

## FCC Test Report (PART 24)

**Report No.:** RF180321E03-1

**FCC ID:** MCLT77W968

**Test Model:** T77W968

**Received Date:** Mar. 21, 2018

**Test Date:** Mar. 31 to Apr. 08, 2018

**Issued Date:** May 17, 2018

**Applicant:** HON HAI PRECISION IND. CO., LTD.

**Address:** 5F-1,5 Hsin-An Road Hsinchu, Science-Based Industrial Park Taiwan,  
R.O.C.

**Issued By:** Bureau Veritas Consumer Products Services (H.K.) Ltd., Taoyuan Branch  
Hsin Chu Laboratory

**Lab Address:** E-2, No.1, Li Hsin 1st Road, Hsinchu Science Park, Hsinchu City 300,  
Taiwan R.O.C.

**Test Location:** E-2, No.1, Li Hsin 1st Road, Hsinchu Science Park, Hsinchu City 300,  
Taiwan R.O.C.

**FCC Registration /  
Designation Number:** 723255 / TW2022



This report is for your exclusive use. Any copying or replication of this report to or for any other person or entity, or use of our name or trademark, is permitted only with our prior written permission. This report sets forth our findings solely with respect to the test samples identified herein. The results set forth in this report are not indicative or representative of the quality or characteristics of the lot from which a test sample was taken or any similar or identical product unless specifically and expressly noted. Our report includes all of the tests requested by you and the results thereof based upon the information that you provided to us. You have 60 days from date of issuance of this report to notify us of any material error or omission caused by our negligence, provided, however, that such notice shall be in writing and shall specifically address the issue you wish to raise. A failure to raise such issue within the prescribed time shall constitute your unqualified acceptance of the completeness of this report, the tests conducted and the correctness of the report contents. Unless specific mention, the uncertainty of measurement has been explicitly taken into account to declare the compliance or non-compliance to the specification. The report must not be used by the client to claim product certification, approval, or endorsement by TAF or any government agencies.

## Table of Contents

<b>Release Control Record</b> .....	<b>4</b>
<b>1 Certificate of Conformity</b> .....	<b>5</b>
<b>2 Summary of Test Results</b> .....	<b>6</b>
2.1 Measurement Uncertainty .....	6
2.2 Test Site and Instruments .....	7
<b>3 General Information</b> .....	<b>9</b>
3.1 General Description of EUT .....	9
3.2 Configuration of System under Test .....	12
3.2.1 Description Of Support Units .....	13
3.3 Test Mode Applicability and Tested Channel Detail .....	14
3.4 EUT Operating Conditions .....	17
3.5 General Description of Applied Standards .....	18
<b>4 Test Types and Results</b> .....	<b>19</b>
4.1 Output Power Measurement .....	19
4.1.1 Limits of Output Power Measurement .....	19
4.1.2 Test Procedures .....	19
4.1.3 Test Setup .....	19
4.1.4 Test Results .....	20
4.2 Modulation characteristics Measurement .....	30
4.2.1 Limits of Modulation characteristics .....	30
4.2.2 Test Procedure .....	30
4.2.3 Test Setup .....	30
4.2.4 Test Results .....	31
4.3 Frequency Stability Measurement .....	33
4.3.1 Limits of Frequency Stability Measurement .....	33
4.3.2 Test Procedure .....	33
4.3.3 Test Setup .....	33
4.3.4 Test Results .....	34
4.4 Occupied Bandwidth Measurement .....	37
4.4.1 Test Procedure .....	37
4.4.2 Test Setup .....	37
4.4.3 Test Result (-26dB Bandwidth) .....	38
4.4.4 Test Result (Occupied Bandwidth) .....	43
4.5 Band Edge Measurement .....	48
4.5.1 Limits of Band Edge Measurement .....	48
4.5.2 Test Setup .....	48
4.5.3 Test Procedures .....	48
4.5.4 Test Results .....	49
4.6 Peak to Average Ratio .....	62
4.6.1 Limits of Peak to Average Ratio Measurement .....	62
4.6.2 Test Setup .....	62
4.6.3 Test Procedures .....	62
4.6.4 Test Results .....	63
4.7 Conducted Spurious Emissions .....	68
4.7.1 Limits of Conducted Spurious Emissions Measurement .....	68
4.7.2 Test Setup .....	68
4.7.3 Test Procedure .....	68
4.7.4 Test Results .....	69
4.8 Radiated Emission Measurement .....	108
4.8.1 Limits of Radiated Emission Measurement .....	108
4.8.2 Test Procedure .....	108
4.8.3 Deviation from Test Standard .....	108
4.8.4 Test Setup .....	109

4.8.5 Test Results .....	110
<b>5 Pictures of Test Arrangements.....</b>	<b>188</b>
<b>Appendix – Information on the Testing Laboratories .....</b>	<b>189</b>

### Release Control Record

Issue No.	Description	Date Issued
RF180321E03-1	Original release.	May 17, 2018

## 1 Certificate of Conformity

**Product:** LTE M.2 Module

**Brand:** FOXCONN

**Test Model:** T77W968

**Sample Status:** ENGINEERING SAMPLE

**Applicant:** HON HAI PRECISION IND. CO., LTD.

**Test Date:** Mar. 31 to Apr. 08, 2018

**Standards:** FCC Part 24

The above equipment has been tested by **Bureau Veritas Consumer Products Services (H.K.) Ltd., Taoyuan Branch**, and found compliance with the requirement of the above standards. The test record, data evaluation & Equipment Under Test (EUT) configurations represented herein are true and accurate accounts of the measurements of the sample's EMC characteristics under the conditions specified in this report.

**Prepared by :** Wendy Wu , **Date:** May 17, 2018  
Wendy Wu / Specialist

**Approved by :** May Chen , **Date:** May 17, 2018  
May Chen / Manager

## 2 Summary of Test Results

Applied Standard: FCC Part 24 & Part 2			
FCC Clause	Test Item	Result	Remarks
2.1046 24.232	Equivalent Isotropically Radiated Power	PASS	Meet the requirement of limit.
2.1046 24.232(d)	Peak To Average Ratio	PASS	Meet the requirement of limit.
2.1047	Modulation characteristics	PASS	Meet the requirement
2.1055 24.235	Frequency Stability	PASS	Meet the requirement of limit.
2.1049 24.238(b)	Occupied Bandwidth	PASS	Meet the requirement of limit.
24.238(b)	Band Edge Measurements	PASS	Meet the requirement of limit.
2.1051 24.238	Conducted Spurious Emissions	PASS	Meet the requirement of limit.
2.1053 24.238	Radiated Spurious Emissions	PASS	Meet the requirement of limit. Minimum passing margin is -20.40dB at 14820MHz.

### 2.1 Measurement Uncertainty

Where relevant, the following measurement uncertainty levels have been estimated for tests performed on the EUT as specified in CISPR 16-4-2:

Measurement	Frequency	Expanded Uncertainty (k=2) (±)
Radiated Emissions up to 1 GHz	30MHz ~ 1GHz	5.53 dB
Radiated Emissions above 1 GHz	1GHz ~ 6GHz	5.08 dB
	6GHz ~ 18GHz	4.98 dB
	18GHz ~ 40GHz	5.19 dB

## 2.2 Test Site and Instruments

### For radiated spurious emissions test:

DESCRIPTION & MANUFACTURER	MODEL NO.	SERIAL NO.	CALIBRATED DATE	CALIBRATED UNTIL
Test Receiver Agilent	N9038A	MY50010156	July 12, 2017	July 11, 2018
Pre-Amplifier EMCI	EMC001340	980142	Feb. 09, 2018	Feb. 08, 2019
Loop Antenna <sup>(*)</sup> Electro-Metrics	EM-6879	264	Dec. 16, 2016	Dec. 15, 2018
RF Cable	NA	LOOPCAB-001 LOOPCAB-002	Jan. 15, 2018	Jan. 14, 2019
Pre-Amplifier Mini-Circuits	ZFL-1000VH2B	AMP-ZFL-05	May 06, 2017	May 05, 2018
Trilog Broadband Antenna SCHWARZBECK	VULB 9168	9168-361	Nov. 29, 2017	Nov. 28, 2018
RF Cable	8D	966-3-1 966-3-2 966-3-3	Mar. 20, 2018	Mar. 19, 2019
Fixed attenuator Mini-Circuits	UNAT-5+	PAD-3m-3-01	Oct. 03, 2017	Oct. 02, 2018
Horn_Antenna SCHWARZBECK	BBHA9120-D	9120D-406	Dec. 12, 2017	Dec. 11, 2018
Pre-Amplifier EMCI	EMC12630SE	980384	Jan. 29, 2018	Jan. 28, 2019
RF Cable	EMC104-SM-SM-1200 EMC104-SM-SM-2000 EMC104-SM-SM-5000	160922 150317 150322	Jan. 29, 2018	Jan. 28, 2019
Spectrum Analyzer Keysight	N9030A	MY54490679	July 25, 2017	July 24, 2018
Pre-Amplifier EMCI	EMC184045SE	980386	Jan. 29, 2018	Jan. 28, 2019
Horn_Antenna SCHWARZBECK	BBHA 9170	BBHA9170608	Dec. 14, 2017	Dec. 13, 2018
RF Cable	EMC102-KM-KM-1200	160924	Jan. 29, 2018	Jan. 28, 2019
Software	ADT_Radiated_V8.7.08	NA	NA	NA
Antenna Tower & Turn Table Max-Full	MF-7802	MF780208406	NA	NA
Boresight Antenna Fixture	FBA-01	FBA-SIP01	NA	NA

#### Note:

1. The calibration interval of the above test instruments is 12 months and the calibrations are traceable to NML/ROC and NIST/USA.
2. \*The calibration interval of the above test instruments is 24 months and the calibrations are traceable to NML/ROC and NIST/USA.
3. The test was performed in 966 Chamber No. 3.
4. The CANADA Site Registration No. is 20331-1
5. Loop antenna was used for all emissions below 30 MHz.
6. Tested Date: Mar. 31 to Apr. 05, 2018

**For other test:**

DESCRIPTION & MANUFACTURER	MODEL NO.	SERIAL NO.	CALIBRATED DATE	CALIBRATED UNTIL
Spectrum Analyzer R&S	FSV40	100964	July 1, 2017	June 30, 2018
Spectrum Analyzer Agilent	E4446A	MY48250254	Nov. 21, 2017	Nov. 20, 2018
Power meter Anritsu	ML2495A	1014008	May 11, 2017	May 10, 2018
Power sensor Anritsu	MA2411B	0917122	May 11, 2017	May 10, 2018
AC Power Source Extech Electronics	6205	1440452	NA	NA
Temperature & Humidity Chamber Giant Force	GTH-150-40-SP-AR	MAA0812-008	Jan. 10, 2018	Jan. 09, 2019
DC Power Supply Topward	6603D	795558	NA	NA
True RMS Clamp Meter FLUKE	325	31130711WS	May 29, 2017	May 28, 2018
ESG Vector signal generator Agilent	E4438C	MY45094468/0 05 506 602 UK6 UNJ	Nov. 26, 2017	Nov. 25, 2018
ESG Vector signal generator Agilent	E4438C	MY47271330 506 602 UNJ	Oct. 11, 2017	Oct. 10, 2018
Mech Switch Absorptive Mini-Circuits	MSP4TA-18+	0140	Feb. 12, 2018	Feb. 11, 2019
FXD ATTEN Mini-Circuits	BW-S3W2+	MN71981	Feb. 12, 2018	Feb. 11, 2019
Software	ADT_RF Test Software V6.6.5.4	NA	NA	NA

- NOTE:**
1. The test was performed in Oven room 2.
  2. The calibration interval of the above test instruments is 12 months and the calibrations are traceable to NML/ROC and NIST/USA.
  3. Tested Date: Apr. 01 to 08, 2018



### 3 General Information

#### 3.1 General Description of EUT

Product	LTE M.2 Module	
Brand	FOXCONN	
Test Model	T77W968	
Status of EUT	ENGINEERING SAMPLE	
Power Supply Rating	DC 3.3V from host equipment	
Modulation Type	WCDMA, HSDPA, HSUPA	BPSK
	LTE Band 2	QPSK, 16QAM, 64QAM
	LTE Band 25	QPSK, 16QAM, 64QAM
Operating Frequency	WCDMA, HSDPA, HSUPA	1852.4MHz ~ 1907.6MHz
	LTE Band 2	1850.7MHz ~ 1909.3MHz
	LTE Band 25	1850.7MHz ~ 1914.3MHz
Max. EIRP Power	WCDMA Band 2	29.16dBm
	LTE Band 2 (Channel Bandwidth 1.4MHz)	28.60dBm
	LTE Band 2 (Channel Bandwidth 3MHz)	28.61dBm
	LTE Band 2 (Channel Bandwidth 5MHz)	28.60dBm
	LTE Band 2 (Channel Bandwidth 10MHz)	28.54dBm
	LTE Band 2 (Channel Bandwidth 15MHz)	28.57dBm
	LTE Band 2 (Channel Bandwidth 20MHz)	28.59dBm
	LTE Band 25 (Channel Bandwidth 1.4MHz)	28.61dBm
	LTE Band 25 (Channel Bandwidth 3MHz)	28.61dBm
	LTE Band 25 (Channel Bandwidth 5MHz)	28.60dBm
	LTE Band 25 (Channel Bandwidth 10MHz)	28.57dBm
	LTE Band 25 (Channel Bandwidth 15MHz)	28.56dBm
	LTE Band 25 (Channel Bandwidth 20MHz)	28.67dBm

Emission Designator	WCDMA Band 2	4M16F9W
	LTE Band 2 (Channel Bandwidth 1.4MHz)	QPSK: 1M09G7D 16QAM: 1M09D7W 64QAW: 1M09D7W
	LTE Band 2 (Channel Bandwidth 3MHz)	QPSK: 2M70G7D 16QAM: 2M70D7W 64QAW: 2M70D7W
	LTE Band 2 (Channel Bandwidth 5MHz)	QPSK: 4M49G7D 16QAM: 4M49D7W 64QAW: 4M49D7W
	LTE Band 2 (Channel Bandwidth 10MHz)	QPSK: 8M96G7D 16QAM: 8M97D7W 64QAW: 8M96D7W
	LTE Band 2 (Channel Bandwidth 15MHz)	QPSK: 13M5G7D 16QAM: 13M4D7W 64QAW: 13M4D7W
	LTE Band 2 (Channel Bandwidth 20MHz)	QPSK: 17M9G7D 16QAM: 17M9D7W 64QAW: 18M0D7W
	LTE Band 25 (Channel Bandwidth 1.4MHz)	QPSK: 1M09G7D 16QAM: 1M09D7W 64QAW: 1M09D7W
	LTE Band 25 (Channel Bandwidth 3MHz)	QPSK: 2M71G7D 16QAM: 2M71D7W 64QAW: 2M72D7W
	LTE Band 25 (Channel Bandwidth 5MHz)	QPSK: 4M50G7D 16QAM: 4M50D7W 64QAW: 4M50D7W
	LTE Band 25 (Channel Bandwidth 10MHz)	QPSK: 8M99G7D 16QAM: 9M01D7W 64QAW: 8M99D7W
	LTE Band 25 (Channel Bandwidth 15MHz)	QPSK: 13M5G7D 16QAM: 13M5D7W 64QAW: 13M5D7W
	LTE Band 25 (Channel Bandwidth 20MHz)	QPSK: 18M0G7D 16QAM: 18M0D7W 64QAW: 18M0D7W
	Antenna Type	Refer to Note
Antenna Connector	Refer to Note	
Accessory Device	NA	
Data Cable Supplied	NA	

Note:

1. The antennas provided to the EUT, please refer to the following table:

Antenna No.	Antenna Net Gain(dBi)	Frequency range (MHz)	Antenna Type	Connector Type	Cable Length
1	Please refer to below table	699~803	PIFA	i-pex(MHF)	100mm
2	Please refer to below table	791~960 1447.9~1606	PIFA	i-pex(MHF)	100mm
3	Please refer to below table	1710~2170 2500~2690	PIFA	i-pex(MHF)	100mm
4	Please refer to below table	3400~3700	PIFA	i-pex(MHF)	100mm
5	Please refer to below table	5110~5925	PIFA	i-pex(MHF)	100mm
6	Please refer to below table	2305~2315	Dipole	i-pex(MHF)	80mm

Antenna gain list		
Band	Freq. Range (MHz)	Gain (dBi)
WCDMA II (B2)	1850~1910	4.92
WCDMA IV (B4)	1710~1755	5.99
WCDMA V (B5)	824~849	2.68
LTE Band (2)	1850~1910	4.92
LTE Band (4)	1710~1755	5.99
LTE Band (5)	824~849	2.68
LTE Band (7)	2500~2570	5.2
LTE Band (12)	698~716	4.17
LTE Band (13)	777~787	3.05
LTE Band (14)	788~798	2.87
LTE Band (17)	704~716	4.17
LTE Band (25)	1850~1915	4.92
LTE Band (26)	814~849	2.92
LTE Band (30)	2305~2315	3.02
LTE Band (38)	2570~2620	4.82
LTE Band (41)	2496~2690	5.38
LTE Band (66)	1710~1780	5.99

2. The above EUT information is declared by manufacturer and for more detailed features description, please refer to the manufacturer's specifications or User's Manual.

### 3.2 Configuration of System under Test

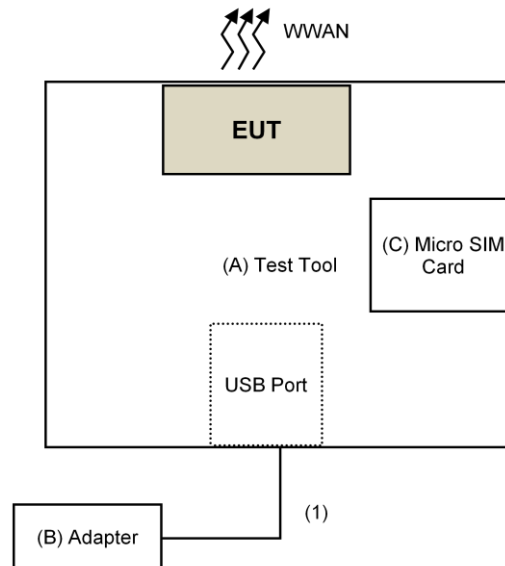

-----  
Remote Site



### 3.2.1 Description Of Support Units

The EUT has been tested as an independent unit together with other necessary accessories or support units. The following support units or accessories were used to form a representative test configuration during the tests.

ID	Product	Brand	Model No.	Serial No.	FCC ID	Remarks
A.	Test Tool	Foxconn	T77W968	NA	NA	Supplied by client
B.	Adapter	ASUS	EXA1205UA	NA	NA	Provided by Lab
C.	SIM Card	NA	NA	NA	NA	Provided by Lab
D.	Simulator	Keysight	E7515A	MY56030229	NA	Provided by Lab

Note:

1. All power cords of the above support units are non-shielded (1.8m).

ID	Descriptions	Qty.	Length (m)	Shielding (Yes/No)	Cores (Qty.)	Remarks
1.	USB Cable	1	1	Yes	0	Provided by Lab

### 3.3 Test Mode Applicability and Tested Channel Detail

Pre-Scan has been conducted to determine the worst-case mode from all possible combinations between available modulations, data rates, XYZ axis and antenna ports

The worst case was found when positioned on X-plane. Following channel(s) was (were) selected for the final test as listed below:

#### WCDMA Band 2

Test Item	Available Channel	Tested Channel	Mode
EIRP	9262 to 9538	9262, 9400, 9538	WCDMA
Frequency Stability	9262 to 9538	9400	WCDMA
Occupied Bandwidth	9262 to 9538	9262, 9400, 9538	WCDMA
Band Edge	9262 to 9538	9262, 9538	WCDMA
Peak to Average Ratio	9262 to 9538	9262, 9400, 9538	WCDMA
Conducted Emission	9262 to 9538	9262, 9400, 9538	WCDMA
Radiated Emission Below 1GHz	9262 to 9538	9262, 9400, 9538	WCDMA
Radiated Emission Above 1GHz	9262 to 9538	9262, 9400, 9538	WCDMA

## LTE Band 2

TEST ITEM	AVAILABLE CHANNEL	TESTED CHANNEL	CHANNEL BANDWIDTH	MODULATION	MODE
EIRP	18607 to 19193	18607, 18900 19193	1.4MHz	QPSK/16QAM/64QAM	1RB / 0 RB offset
	18615 to 19185	18615, 18900, 19185	3MHz	QPSK/16QAM/64QAM	1RB / 0 RB offset
	18625 to 19175	18625, 18900, 19175	5MHz	QPSK/16QAM/64QAM	1RB / 0 RB offset
	18650 to 19150	18650, 18900, 19150	10MHz	QPSK/16QAM/64QAM	1RB / 0 RB offset
	18675 to 19125	18675, 18900, 19125	15MHz	QPSK/16QAM/64QAM	1RB / 0 RB offset
	18700 to 19100	18700, 18900, 19100	20MHz	QPSK/16QAM/64QAM	1RB / 0 RB offset
Frequency Stability	18607 to 19193	18900	1.4MHz	QPSK	-
	18615 to 19185	18900	3MHz	QPSK	-
	18625 to 19175	18900	5MHz	QPSK	-
	18650 to 19150	18900	10MHz	QPSK	-
	18675 to 19125	18900	15MHz	QPSK	-
	18700 to 19100	18900	20MHz	QPSK	-
Occupied Bandwidth	18607 to 19193	18607, 18900 19193	1.4MHz	QPSK/16QAM/64QAM	Full RB
	18615 to 19185	18615, 18900, 19185	3MHz	QPSK/16QAM/64QAM	Full RB
	18625 to 19175	18625, 18900, 19175	5MHz	QPSK/16QAM/64QAM	Full RB
	18650 to 19150	18650, 18900, 19150	10MHz	QPSK/16QAM/64QAM	Full RB
	18675 to 19125	18675, 18900, 19125	15MHz	QPSK/16QAM/64QAM	Full RB
	18700 to 19100	18700, 18900, 19100	20MHz	QPSK/16QAM/64QAM	Full RB
Peak to Average Ratio	18607 to 19193	18607, 18900 19193	1.4MHz	QPSK/16QAM/64QAM	Full RB
	18615 to 19185	18615, 18900, 19185	3MHz	QPSK/16QAM/64QAM	Full RB
	18625 to 19175	18625, 18900, 19175	5MHz	QPSK/16QAM/64QAM	Full RB
	18650 to 19150	18650, 18900, 19150	10MHz	QPSK/16QAM/64QAM	Full RB
	18675 to 19125	18675, 18900, 19125	15MHz	QPSK/16QAM/64QAM	Full RB
	18700 to 19100	18700, 18900, 19100	20MHz	QPSK/16QAM/64QAM	Full RB
Band Edge	18607 to 19193	18607	1.4MHz	QPSK	1 RB / 0 RB Offset
		19193			1 RB / 5 RB Offset
		18607, 19193			6 RB / 0 RB Offset
	18615 to 19185	18615	3MHz	QPSK	1 RB / 0 RB Offset
		19185			1 RB / 14 RB Offset
		18615, 19185			15 RB / 0 RB Offset
	18625 to 19175	18625,	5MHz	QPSK	1 RB / 0 RB Offset
		19175			1 RB / 24 RB Offset
		18625, 19175			25 RB / 0 RB Offset
	18650 to 19150	18650	10MHz	QPSK	1 RB / 0 RB Offset
		19150			1 RB / 49 RB Offset
		18650, 19150			50 RB / 0 RB Offset
	18675 to 19125	18675,	15MHz	QPSK	1 RB / 0 RB Offset
		19125			1 RB / 74 RB Offset
		18675, 19125			75 RB / 0 RB Offset
	18700 to 19100	18700.	20MHz	QPSK	1 RB / 0 RB Offset
		19100			1 RB / 99 RB Offset
		18700. 19100			100 RB / 0 RB Offset
Conducted Emission	18607 to 19193	18607, 18900 19193	1.4MHz	QPSK	1 RB / 0 RB Offset
	18615 to 19185	18615, 18900, 19185	3MHz	QPSK	1 RB / 0 RB Offset
	18625 to 19175	18625, 18900, 19175	5MHz	QPSK	1 RB / 0 RB Offset
	18650 to 19150	18650, 18900, 19150	10MHz	QPSK	1 RB / 0 RB Offset
	18675 to 19125	18675, 18900, 19125	15MHz	QPSK	1 RB / 0 RB Offset
	18700 to 19100	18700, 18900, 19100	20MHz	QPSK	1 RB / 0 RB Offset
Radiated Emission	18607 to 19193	18607, 18900 19193	1.4MHz	QPSK	1 RB / 0 RB Offset
	18615 to 19185	18615, 18900, 19185	3MHz	QPSK	1 RB / 0 RB Offset
	18625 to 19175	18625, 18900, 19175	5MHz	QPSK	1 RB / 0 RB Offset
	18650 to 19150	18650, 18900, 19150	10MHz	QPSK	1 RB / 0 RB Offset
	18675 to 19125	18675, 18900, 19125	15MHz	QPSK	1 RB / 0 RB Offset
	18700 to 19100	18700, 18900, 19100	20MHz	QPSK	1 RB / 0 RB Offset

### LTE Band 25

TEST ITEM	AVAILABLE CHANNEL	TESTED CHANNEL	CHANNEL BANDWIDTH	MODULATION	MODE
EIRP	26047 to 26683	26047, 26365, 26683	1.4MHz	QPSK/16QAM/64QAM	1RB / 0 RB offset
	26055 to 26675	26055, 26365, 26675	3MHz	QPSK/16QAM/64QAM	1RB / 0 RB offset
	26065 to 26665	26065, 26365, 26665	5MHz	QPSK/16QAM/64QAM	1RB / 0 RB offset
	26090 to 26640	26090, 26365, 26640	10MHz	QPSK/16QAM/64QAM	1RB / 0 RB offset
	26115 to 26615	26115, 26365, 26615	15MHz	QPSK/16QAM/64QAM	1RB / 0 RB offset
	26140 to 26590	26140, 26365, 26590	20MHz	QPSK/16QAM/64QAM	1RB / 0 RB offset
Frequency Stability	26047 to 26683	26365	1.4MHz	QPSK	-
	26055 to 26675	26365	3MHz	QPSK	-
	26065 to 26665	26365	5MHz	QPSK	-
	26090 to 26640	26365	10MHz	QPSK	-
	26115 to 26615	26365	15MHz	QPSK	-
	26140 to 26590	26365	20MHz	QPSK	-
Occupied Bandwidth	26047 to 26683	26047, 26365, 26683	1.4MHz	QPSK/16QAM/64QAM	Full RB
	26055 to 26675	26055, 26365, 26675	3MHz	QPSK/16QAM/64QAM	Full RB
	26065 to 26665	26065, 26365, 26665	5MHz	QPSK/16QAM/64QAM	Full RB
	26090 to 26640	26090, 26365, 26640	10MHz	QPSK/16QAM/64QAM	Full RB
	26115 to 26615	26115, 26365, 26615	15MHz	QPSK/16QAM/64QAM	Full RB
	26140 to 26590	26140, 26365, 26590	20MHz	QPSK/16QAM/64QAM	Full RB
Peak to Average Ratio	26047 to 26683	26047, 26365, 26683	1.4MHz	QPSK/16QAM/64QAM	Full RB
	26055 to 26675	26055, 26365, 26675	3MHz	QPSK/16QAM/64QAM	Full RB
	26065 to 26665	26065, 26365, 26665	5MHz	QPSK/16QAM/64QAM	Full RB
	26090 to 26640	26090, 26365, 26640	10MHz	QPSK/16QAM/64QAM	Full RB
	26115 to 26615	26115, 26365, 26615	15MHz	QPSK/16QAM/64QAM	Full RB
	26140 to 26590	26140, 26365, 26590	20MHz	QPSK/16QAM/64QAM	Full RB
Band Edge	26047 to 26683	26047	1.4MHz	QPSK	1 RB / 0 RB Offset
		26683			1 RB / 5 RB Offset
		26047, 26683			6 RB / 0 RB Offset
	26055 to 26675	26055	3MHz	QPSK	1 RB / 0 RB Offset
		26675			1 RB / 14 RB Offset
		26055, 26675			15 RB / 0 RB Offset
	26065 to 26665	26065	5MHz	QPSK	1 RB / 0 RB Offset
		26665			1 RB / 24 RB Offset
		26065, 26665			25 RB / 0 RB Offset
	26090 to 26640	26090	10MHz	QPSK	1 RB / 0 RB Offset
		26640			1 RB / 49 RB Offset
		26090, 26640			50 RB / 0 RB Offset
	26115 to 26615	26115	15MHz	QPSK	1 RB / 0 RB Offset
		26615			1 RB / 74 RB Offset
		26115, 26615			75 RB / 0 RB Offset
26140 to 26590	26140	20MHz	QPSK	1 RB / 0 RB Offset	
	26590			1 RB / 99 RB Offset	
	26140, 26590			100 RB / 0 RB Offset	
Conducted Emission	26047 to 26683	26047, 26365, 26683	1.4MHz	QPSK	1RB / 0 RB offset
	26055 to 26675	26055, 26365, 26675	3MHz	QPSK	1RB / 0 RB offset
	26065 to 26665	26065, 26365, 26665	5MHz	QPSK	1RB / 0 RB offset
	26090 to 26640	26090, 26365, 26640	10MHz	QPSK	1RB / 0 RB offset
	26115 to 26615	26115, 26365, 26615	15MHz	QPSK	1RB / 0 RB offset
	26140 to 26590	26140, 26365, 26590	20MHz	QPSK	1RB / 0 RB offset
Radiated Emission	26047 to 26683	26047, 26365, 26683	1.4MHz	QPSK	1RB / 0 RB offset
	26055 to 26675	26055, 26365, 26675	3MHz	QPSK	1RB / 0 RB offset
	26065 to 26665	26065, 26365, 26665	5MHz	QPSK	1RB / 0 RB offset
	26090 to 26640	26090, 26365, 26640	10MHz	QPSK	1RB / 0 RB offset
	26115 to 26615	26115, 26365, 26615	15MHz	QPSK	1RB / 0 RB offset
	26140 to 26590	26140, 26365, 26590	20MHz	QPSK	1RB / 0 RB offset

**NOTE:**

All supported modulation types were evaluated. The Worst case of QPSK was selected. Therefore, the Band Edge, Frequency Stability, Condcudeted Emission and Radiated Emission were presented under QPSK mode only.



**Test Condition:**

Test Item	Environmental Conditions	Input Power (System)	Tested By
EIRP	25deg. C, 63%RH	120Vac, 60Hz	Jyunchun Lin
Frequency Stability	25deg. C, 63%RH	120Vac, 60Hz	Jyunchun Lin
Occupied Bandwidth	25deg. C, 63%RH	120Vac, 60Hz	Jyunchun Lin
Band Edge	25deg. C, 63%RH	120Vac, 60Hz	Jyunchun Lin
Peak to Average Ratio	25deg. C, 63%RH	120Vac, 60Hz	Jyunchun Lin
Conducuted Emission	25deg. C, 63%RH	120Vac, 60Hz	Jyunchun Lin
Radiated Emission Below 1GHz	25deg. C, 66%RH	120Vac, 60Hz	Frank Chiang
Radiated Emission Above 1GHz	25deg. C, 66%RH	120Vac, 60Hz	Frank Chiang

**3.4 EUT Operating Conditions**

The communication simulator station system controlled a EUT to export maximum output power under transmission mode and specific channel frequency

### 3.5 General Description of Applied Standards

The EUT is a RF Product. According to the specifications of the manufacturer, it must comply with the requirements of the following standards:

**FCC 47 CFR Part 2**

**FCC 47 CFR Part 24**

**KDB 971168 D01 Power Meas License Digital Systems v03r01**

**ANSI/TIA/EIA-603-E 2016**

**ANSI 63.26-2015**

**NOTE:** All test items have been performed and recorded as per the above standards.

## 4 Test Types and Results

### 4.1 Output Power Measurement

#### 4.1.1 Limits of Output Power Measurement

Mobile / Portable station are limited to 2 watts e.i.r.p.

#### 4.1.2 Test Procedures

##### Conducted Power Measurement:

The EUT was set up for the maximum power with WCDMA/LTE link data modulation and link up with simulator. Set the EUT to transmit under low, middle and high channel and difference RB size/ RB offset for difference bandwidth record the power level shown on power meter.

##### EIRP Measurement:

- a.  $EIRP = \text{Conducted Output power level} + \text{Antenna gain.}$

#### 4.1.3 Test Setup

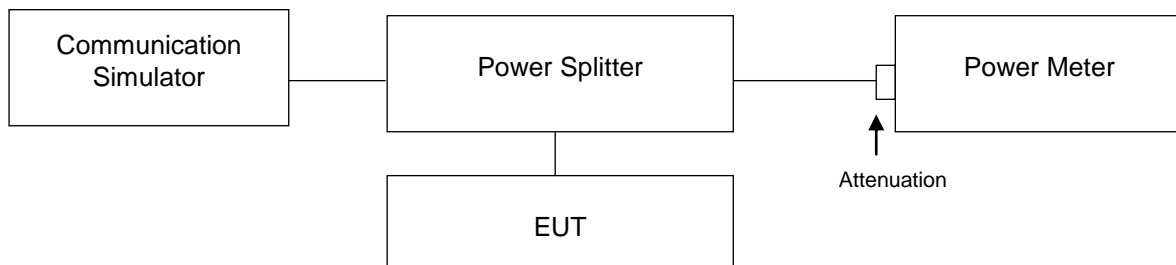

For the actual test configuration, please refer to the attached file (Test Setup Photo).

#### 4.1.4 Test Results

#### CONDUCTED OUTPUT POWER (dBm)

Band	WCDMA B2		
	Channel	9262	9400
Frequency (MHz)	1852.4	1880.0	1907.6
RMC	24.09	24.24	24.08
HSDPA Subtest-1	23.53	23.69	23.50
HSDPA Subtest-2	23.60	23.67	23.60
HSDPA Subtest-3	23.93	23.98	23.82
HSDPA Subtest-4	23.64	23.71	23.56
HSUPA Subtest-1	23.78	23.83	23.70
HSUPA Subtest-2	23.76	23.82	23.87
HSUPA Subtest-3	23.45	23.53	23.51
HSUPA Subtest-4	23.78	23.89	23.80
HSUPA Subtest-5	23.74	23.84	23.74

**LTE Band 2**

Band / BW	RB Size	RB Offset	QPSK			3GPP MPR (dB)	16QAM			3GPP MPR (dB)	64QAM			3GPP MPR (dB)
			Low CH	Mid CH	High CH		Low CH	Mid CH	High CH		Low CH	Mid CH	High CH	
			18607	18900	19193		18607	18900	19193		18607	18900	19193	
			1850.7	1880	1909.3		1850.7	1880	1909.3		1850.7	1880	1909.3	
			MHz	MHz	MHz				MHz	MHz	MHz			
2 / 1.4M	1	0	23.55	23.57	23.68	0	22.37	22.21	22.36	1	21.10	21.41	21.40	2
	1	2	23.53	23.54	23.56	0	22.28	22.24	22.42	1	21.19	21.33	21.50	2
	1	5	23.50	23.51	23.53	0	22.17	22.30	22.32	1	21.27	21.48	21.48	2
	3	0	23.40	23.27	23.50	0	22.20	22.20	22.54	1	21.47	21.52	21.48	2
	3	1	23.44	23.16	23.38	0	22.33	22.27	22.52	1	21.45	21.38	21.32	2
	3	3	23.40	23.02	23.45	0	22.39	22.19	22.49	1	21.41	21.50	21.48	2
	6	0	22.35	22.11	22.50	1	21.37	21.18	21.44	2	20.42	20.45	20.50	3

Band / BW	RB Size	RB Offset	QPSK			3GPP MPR (dB)	16QAM			3GPP MPR (dB)	64QAM			3GPP MPR (dB)
			Low CH	Mid CH	High CH		Low CH	Mid CH	High CH		Low CH	Mid CH	High CH	
			18615	18900	19185		18615	18900	19185		18615	18900	19185	
			1851.5	1880	1908.5		1851.5	1880	1908.5		1851.5	1880	1908.5	
			MHz	MHz	MHz				MHz	MHz	MHz			
2 / 3M	1	0	23.52	23.55	23.69	0	22.66	22.42	22.60	1	21.26	21.30	21.56	2
	1	7	23.53	23.56	23.55	0	22.68	22.38	22.65	1	21.32	21.31	21.55	2
	1	14	23.54	23.51	23.61	0	22.58	22.18	22.58	1	21.23	21.22	21.53	2
	8	0	22.42	22.12	22.70	1	21.35	21.06	21.62	2	20.54	20.51	20.38	3
	8	3	22.42	22.32	22.63	1	21.40	21.08	21.60	2	20.47	20.52	20.44	3
	8	7	22.40	22.26	22.52	1	21.37	21.17	21.51	2	20.51	20.56	20.21	3
	15	0	22.36	22.22	22.55	1	21.39	21.24	21.60	2	20.55	20.46	20.55	3

Band / BW	RB Size	RB Offset	QPSK			3GPP MPR (dB)	16QAM			3GPP MPR (dB)	64QAM			3GPP MPR (dB)
			Low CH	Mid CH	High CH		Low CH	Mid CH	High CH		Low CH	Mid CH	High CH	
			18625	18900	19175		18625	18900	19175		18625	18900	19175	
			1852.5	1880	1907.5		1852.5	1880	1907.5		1852.5	1880	1907.5	
			MHz	MHz	MHz				MHz	MHz	MHz			
2 / 5M	1	0	23.55	23.56	23.68	0	22.30	22.29	22.46	1	21.11	21.36	21.42	2
	1	12	23.56	23.58	23.56	0	22.28	22.19	22.40	1	21.30	21.32	21.56	2
	1	24	23.55	23.53	23.56	0	22.31	22.30	22.43	1	21.26	21.37	21.42	2
	12	0	22.39	22.55	22.63	1	21.29	21.19	21.65	2	20.42	20.60	20.38	3
	12	6	22.38	22.37	22.61	1	21.48	21.25	21.59	2	20.37	20.33	20.40	3
	12	13	22.36	22.32	22.55	1	21.41	21.11	21.63	2	20.38	20.40	20.37	3
	25	0	22.41	22.36	22.55	1	21.49	21.25	21.60	2	20.50	20.35	20.48	3

Band / BW	RB Size	RB Offset	QPSK			3GPP MPR (dB)	16QAM			3GPP MPR (dB)	64QAM			3GPP MPR (dB)
			Low CH	Mid CH	High CH		Low CH	Mid CH	High CH		Low CH	Mid CH	High CH	
			18650	18900	19150		18650	18900	19150		18650	18900	19150	
			1855	1880	1905		1855	1880	1905		1855	1880	1905	
			MHz	MHz	MHz	MHz	MHz	MHz	MHz	MHz	MHz	MHz		
2 / 10M	1	0	23.55	23.52	23.62	0	22.55	22.18	22.58	1	21.23	21.41	21.40	2
	1	24	23.59	23.53	23.62	0	22.50	22.19	22.49	1	21.17	21.31	21.53	2
	1	49	23.54	23.58	23.63	0	22.40	22.13	22.84	1	21.25	21.35	21.47	2
	25	0	22.33	22.47	22.61	1	21.47	21.27	21.58	2	20.55	20.62	20.48	3
	25	12	22.34	22.27	22.50	1	21.44	21.34	21.55	2	20.48	20.58	20.52	3
	25	25	22.29	22.23	22.50	1	21.44	21.30	21.59	2	20.49	20.61	20.52	3
	50	0	22.24	22.24	22.48	1	21.39	21.40	21.56	2	20.51	20.58	20.49	3

Band / BW	RB Size	RB Offset	QPSK			3GPP MPR (dB)	16QAM			3GPP MPR (dB)	64QAM			3GPP MPR (dB)
			Low CH	Mid CH	High CH		Low CH	Mid CH	High CH		Low CH	Mid CH	High CH	
			18675	18900	19125		18675	18900	19125		18675	18900	19125	
			1857.5	1880	1902.5		1857.5	1880	1902.5		1857.5	1880	1902.5	
			MHz	MHz	MHz	MHz	MHz	MHz	MHz	MHz	MHz			
2 / 15M	1	0	23.57	23.58	23.65	0	22.40	22.39	22.49	1	21.28	21.38	21.53	2
	1	37	23.55	23.53	23.52	0	22.21	22.31	22.29	1	21.12	21.22	21.41	2
	1	74	23.52	23.58	23.61	0	22.15	22.44	22.47	1	21.21	21.20	21.48	2
	36	0	22.32	22.28	22.50	1	21.50	21.27	21.52	2	20.35	20.54	20.40	3
	36	19	22.30	22.11	22.51	1	21.37	21.32	21.53	2	20.42	20.45	20.33	3
	36	39	22.27	22.13	22.53	1	21.34	21.14	21.55	2	20.55	20.35	20.45	3
	75	0	22.29	22.15	22.59	1	21.30	21.34	21.51	2	20.51	20.45	20.48	3

Band / BW	RB Size	RB Offset	QPSK			3GPP MPR (dB)	16QAM			3GPP MPR (dB)	64QAM			3GPP MPR (dB)
			Low CH	Mid CH	High CH		Low CH	Mid CH	High CH		Low CH	Mid CH	High CH	
			18700	18900	19100		18700	18900	19100		18700	18900	19100	
			1860	1880	1900		1860	1880	1900		1860	1880	1900	
			MHz	MHz	MHz	MHz	MHz	MHz	MHz	MHz	MHz			
2 / 20M	1	0	23.57	23.58	23.67	0	22.47	22.20	22.48	1	21.23	21.22	21.17	2
	1	50	23.55	23.50	23.52	0	22.46	22.11	22.59	1	21.21	21.23	21.47	2
	1	99	23.59	23.55	23.50	0	22.63	22.28	22.54	1	21.38	21.40	21.54	2
	50	0	22.37	22.32	22.53	1	21.46	21.35	21.54	2	20.45	20.51	20.51	3
	50	25	22.36	22.20	22.56	1	21.34	21.31	21.58	2	20.48	20.46	20.48	3
	50	50	22.20	22.15	22.53	1	21.58	21.31	21.55	2	20.43	20.49	20.45	3
	100	0	22.23	22.17	22.59	1	21.33	21.34	21.64	2	20.38	20.45	20.53	3

**LTE Band 25**

Band / BW	RB Size	RB Offset	QPSK			3GPP MPR (dB)	16QAM			3GPP MPR (dB)	64QAM			3GPP MPR (dB)
			Low CH	Mid CH	High CH		Low CH	Mid CH	High CH		Low CH	Mid CH	High CH	
			26047	26365	26683		26047	26365	26683		26047	26365	26683	
			1850.7	1882.5	1914.3		1850.7	1882.5	1914.3		1850.7	1882.5	1914.3	
			MHz	MHz	MHz				MHz	MHz	MHz			
25 / 1.4M	1	0	23.55	23.69	23.59	0	22.38	22.51	22.38	1	21.40	21.59	21.50	2
	1	2	23.53	23.51	23.54	0	22.45	22.51	22.42	1	21.35	21.50	21.56	2
	1	5	23.52	23.55	23.50	0	22.42	22.55	22.39	1	21.38	21.48	21.52	2
	3	0	23.16	23.30	23.23	0	22.55	22.49	22.40	1	21.32	21.52	21.48	2
	3	1	23.12	23.41	23.25	0	22.39	22.55	22.45	1	21.39	21.55	21.58	2
	3	3	23.29	23.39	23.48	0	22.49	22.48	22.38	1	21.43	21.49	21.60	2
	6	0	22.46	22.52	22.48	1	21.38	21.35	21.16	2	20.38	20.41	20.53	3

Band / BW	RB Size	RB Offset	QPSK			3GPP MPR (dB)	16QAM			3GPP MPR (dB)	64QAM			3GPP MPR (dB)
			Low CH	Mid CH	High CH		Low CH	Mid CH	High CH		Low CH	Mid CH	High CH	
			26055	26365	26675		26055	26365	26675		26055	26365	26675	
			1851.5	1882.5	1913.5		1851.5	1882.5	1913.5		1851.5	1882.5	1913.5	
			MHz	MHz	MHz				MHz	MHz	MHz			
25 / 3M	1	0	23.55	23.57	23.69	0	22.18	22.25	22.46	1	21.33	21.39	21.32	2
	1	7	23.53	23.59	23.56	0	22.27	22.18	22.39	1	21.45	21.30	21.43	2
	1	14	23.53	23.56	23.54	0	22.16	22.16	22.29	1	21.40	21.28	21.53	2
	8	0	22.22	22.30	22.28	1	21.21	21.29	21.37	2	20.49	20.41	20.46	3
	8	3	22.16	22.18	22.16	1	21.13	21.26	21.37	2	20.33	20.39	20.38	3
	8	7	22.16	22.25	22.27	1	21.11	21.23	21.33	2	20.35	20.40	20.44	3
	15	0	22.15	22.15	22.29	1	21.36	21.45	21.37	2	20.41	20.38	20.41	3

Band / BW	RB Size	RB Offset	QPSK			3GPP MPR (dB)	16QAM			3GPP MPR (dB)	64QAM			3GPP MPR (dB)
			Low CH	Mid CH	High CH		Low CH	Mid CH	High CH		Low CH	Mid CH	High CH	
			26065	26365	26665		26065	26365	26665		26065	26365	26665	
			1852.5	1882.5	1912.5		1852.5	1882.5	1912.5		1852.5	1882.5	1912.5	
			MHz	MHz	MHz				MHz	MHz	MHz			
25 / 5M	1	0	23.52	23.57	23.68	0	22.37	22.36	22.12	1	21.32	21.41	21.22	2
	1	12	23.52	23.59	23.56	0	22.29	22.30	22.24	1	21.28	21.28	21.18	2
	1	24	23.54	23.51	23.51	0	22.41	22.31	22.29	1	21.22	21.35	21.26	2
	12	0	22.11	22.40	22.33	1	21.47	21.24	21.37	2	20.38	20.41	20.21	3
	12	6	22.21	22.19	22.43	1	21.39	21.26	21.40	2	20.41	20.38	20.18	3
	12	13	22.18	22.23	22.17	1	21.34	21.23	21.31	2	20.28	20.44	20.30	3
	25	0	22.09	22.18	22.38	1	21.25	21.27	21.39	2	20.32	20.39	20.26	3

Band / BW	RB Size	RB Offset	QPSK			3GPP MPR (dB)	16QAM			3GPP MPR (dB)	64QAM			3GPP MPR (dB)
			Low CH	Mid CH	High CH		Low CH	Mid CH	High CH		Low CH	Mid CH	High CH	
			26090	26365	26640		26090	26365	26640		26090	26365	26640	
			1855	1882.5	1910		1855	1882.5	1910		1855	1882.5	1910	
			MHz	MHz	MHz	MHz	MHz	MHz	MHz	MHz	MHz			
25 / 10M	1	0	23.60	23.65	23.57	0	22.29	22.39	22.48	1	21.35	21.40	21.38	2
	1	24	23.51	23.53	23.51	0	22.30	22.25	22.47	1	21.30	21.35	21.36	2
	1	49	23.55	23.58	23.58	0	22.19	22.14	22.23	1	21.25	21.39	21.42	2
	25	0	22.38	22.56	22.45	1	21.16	21.28	21.49	2	20.33	20.42	20.36	3
	25	12	22.16	22.21	22.31	1	21.19	21.37	21.45	2	20.28	20.39	20.41	3
	25	25	22.13	22.21	22.42	1	21.17	21.40	21.40	2	20.19	20.36	20.38	3
	50	0	22.15	22.25	22.52	1	21.21	21.24	21.46	2	20.25	20.41	20.39	3

Band / BW	RB Size	RB Offset	QPSK			3GPP MPR (dB)	16QAM			3GPP MPR (dB)	64QAM			3GPP MPR (dB)
			Low CH	Mid CH	High CH		Low CH	Mid CH	High CH		Low CH	Mid CH	High CH	
			26115	26365	26615		26115	26365	26615		26115	26365	26615	
			1857.5	1882.5	1907.5		1857.5	1882.5	1907.5		1857.5	1882.5	1907.5	
			MHz	MHz	MHz	MHz	MHz	MHz	MHz	MHz				
25 / 15M	1	0	23.53	23.56	23.64	0	22.29	22.23	22.44	1	21.23	21.35	21.43	2
	1	37	23.58	23.55	23.60	0	22.24	22.35	22.29	1	21.30	21.32	21.38	2
	1	74	23.53	23.51	23.62	0	22.39	22.55	22.49	1	21.28	21.43	21.40	2
	36	0	22.24	22.15	22.48	1	21.24	21.35	21.51	2	20.41	20.38	20.38	3
	36	19	22.14	22.20	22.41	1	21.25	21.33	21.49	2	20.38	20.36	20.42	3
	36	39	22.08	22.28	22.34	1	21.20	21.30	21.35	2	20.35	20.39	20.45	3
	75	0	22.11	22.13	22.47	1	21.33	21.26	21.42	2	20.39	20.41	20.47	3

Band / BW	RB Size	RB Offset	QPSK			3GPP MPR (dB)	16QAM			3GPP MPR (dB)	64QAM			3GPP MPR (dB)
			Low CH	Mid CH	High CH		Low CH	Mid CH	High CH		Low CH	Mid CH	High CH	
			26140	26365	26590		26140	26365	26590		26140	26365	26590	
			1860	1882.5	1905		1860	1882.5	1905		1860	1882.5	1905	
			MHz	MHz	MHz	MHz	MHz	MHz	MHz	MHz				
25 / 20M	1	0	23.59	23.61	23.75	0	22.33	22.38	22.52	1	21.38	21.42	21.33	2
	1	50	23.61	23.66	23.55	0	22.28	22.35	22.69	1	21.35	21.40	21.42	2
	1	99	23.55	23.53	23.66	0	22.31	22.31	22.48	1	21.40	21.45	21.44	2
	50	0	22.25	22.35	22.39	1	21.58	21.38	21.63	2	20.38	20.51	20.52	3
	50	25	22.24	22.25	22.36	1	21.55	21.36	21.51	2	20.42	20.38	20.48	3
	50	50	22.18	22.26	22.40	1	21.33	21.38	21.51	2	20.39	20.43	20.49	3
	100	0	22.28	22.30	22.61	1	21.43	21.36	21.48	2	20.33	20.45	20.45	3



## EIRP POWER

Band	WCDMA B2		
Channel	9262	9400	9538
Frequency (MHz)	1852.4	1880	1907.6
RMC 12.2K	24.09	24.24	24.08
Gain (dBi)	4.92	4.92	4.92
Max EIRP Power (dBm)	29.01	29.16	29.00

**LTE Band 2**

Band / BW	RB Size	RB Offset	QPSK			3GPP MPR (dB)	16QAM			3GPP MPR (dB)	64QAM			3GPP MPR (dB)
			Low CH	Mid CH	High CH		Low CH	Mid CH	High CH		Low CH	Mid CH	High CH	
			18607	18900	19193		18607	18900	19193		18607	18900	19193	
			1850.7	1880	1909.3		1850.7	1880	1909.3		1850.7	1880	1909.3	
			MHz	MHz	MHz	MHz	MHz	MHz	MHz	MHz	MHz			
2 / 1.4M	1	0	23.55	23.57	23.68	0	22.37	22.21	22.36	1	21.10	21.41	21.40	2
Gain (dBi)			4.92	4.92	4.92		4.92	4.92	4.92		4.92	4.92	4.92	
Max EIRP Power (dBm)			28.47	28.49	28.60		27.29	27.13	27.28		26.02	26.33	26.32	

Band / BW	RB Size	RB Offset	QPSK			3GPP MPR (dB)	16QAM			3GPP MPR (dB)	64QAM			3GPP MPR (dB)
			Low CH	Mid CH	High CH		Low CH	Mid CH	High CH		Low CH	Mid CH	High CH	
			18615	18900	19185		18615	18900	19185		18615	18900	19185	
			1851.5	1880	1908.5		1851.5	1880	1908.5		1851.5	1880	1908.5	
			MHz	MHz	MHz	MHz	MHz	MHz	MHz	MHz				
2 / 3M	1	0	23.52	23.55	23.69	0	22.66	22.42	22.60	1	21.26	21.30	21.56	2
Gain (dBi)			4.92	4.92	4.92		4.92	4.92	4.92		4.92	4.92		
Max EIRP Power (dBm)			28.44	28.47	28.61		27.58	27.34	27.52		26.18	26.22	26.48	

Band / BW	RB Size	RB Offset	QPSK			3GPP MPR (dB)	16QAM			3GPP MPR (dB)	64QAM			3GPP MPR (dB)
			Low CH	Mid CH	High CH		Low CH	Mid CH	High CH		Low CH	Mid CH	High CH	
			18625	18900	19175		18625	18900	19175		18625	18900	19175	
			1852.5	1880	1907.5		1852.5	1880	1907.5		1852.5	1880	1907.5	
			MHz	MHz	MHz	MHz	MHz	MHz	MHz	MHz				
2 / 5M	1	0	23.55	23.56	23.68	0	22.30	22.29	22.46	1	21.11	21.36	21.42	2
Gain (dBi)			4.92	4.92	4.92		4.92	4.92	4.92		4.92	4.92		
Max EIRP Power (dBm)			28.47	28.48	28.60		27.22	27.21	27.38		26.03	26.28	26.34	

Band / BW	RB Size	RB Offset	QPSK			3GPP MPR (dB)	16QAM			3GPP MPR (dB)	64QAM			3GPP MPR (dB)
			Low CH	Mid CH	High CH		Low CH	Mid CH	High CH		Low CH	Mid CH	High CH	
			18650	18900	19150		20000	20175	20350		20000	20175	20350	
			1855	1880	1905		1715	1732.5	1750		1715	1732.5	1750	
			MHz	MHz	MHz	MHz	MHz	MHz	MHz	MHz				
2 / 10M	1	0	23.55	23.52	23.62	0	22.55	22.18	22.58	1	21.23	21.41	21.40	2
Gain (dBi)			4.92	4.92	4.92		4.92	4.92	4.92		4.92	4.92		
Max EIRP Power (dBm)			28.47	28.44	28.54		27.47	27.10	27.50		26.15	26.33	26.32	

Band / BW	RB Size	RB Offset	QPSK			3GPP MPR (dB)	16QAM			3GPP MPR (dB)	64QAM			3GPP MPR (dB)
			Low CH	Mid CH	High CH		Low CH	Mid CH	High CH		Low CH	Mid CH	High CH	
			18675	18900	19125		18675	18900	19125		18675	18900	19125	
			1857.5	1880	1902.5		1857.5	1880	1902.5		1857.5	1880	1902.5	
			MHz	MHz	MHz	MHz	MHz	MHz	MHz	MHz	MHz			
2 / 15M	1	0	23.57	23.58	23.65	0	22.40	22.39	22.49	1	21.28	21.38	21.53	2
Gain (dBi)			4.92	4.92	4.92		4.92	4.92	4.92		4.92	4.92	4.92	
Max EIRP Power (dBm)			28.49	28.50	28.57		27.32	27.31	27.41		26.20	26.30	26.45	

Band / BW	RB Size	RB Offset	QPSK			3GPP MPR (dB)	16QAM			3GPP MPR (dB)	64QAM			3GPP MPR (dB)
			Low CH	Mid CH	High CH		Low CH	Mid CH	High CH		Low CH	Mid CH	High CH	
			18700	18900	19100		18700	18900	19100		18700	18900	19100	
			1860	1880	1900		1860	1880	1900		1860	1880	1900	
			MHz	MHz	MHz	MHz	MHz	MHz	MHz	MHz				
2 / 20M	1	0	23.57	23.58	23.67	0	22.47	22.20	22.48	1	21.23	21.22	21.17	2
Gain (dBi)			4.92	4.92	4.92		4.92	4.92	4.92		4.92	4.92		
Max EIRP Power (dBm)			28.49	28.50	28.59		27.39	27.12	27.40		26.15	26.14	26.09	

**LTE Band 25**

Band / BW	RB Size	RB Offset	QPSK			3GPP MPR (dB)	16QAM			3GPP MPR (dB)	64QAM			3GPP MPR (dB)
			Low CH	Mid CH	High CH		Low CH	Mid CH	High CH		Low CH	Mid CH	High CH	
			26047	26365	26683		26047	26365	26683		26047	26365	26683	
			1850.7	1882.5	1914.3		1850.7	1882.5	1914.3		1850.7	1882.5	1914.3	
			MHz	MHz	MHz	MHz	MHz	MHz	MHz	MHz	MHz			
25 / 1.4M	1	0	23.55	23.69	23.59	0	22.38	22.51	22.38	1	21.40	21.59	21.50	2
Gain (dBi)			4.92	4.92	4.92		4.92	4.92	4.92		4.92	4.92	4.92	
Max EIRP Power (dBm)			28.47	28.61	28.51		27.30	27.43	27.30		26.32	26.51	26.42	

Band / BW	RB Size	RB Offset	QPSK			3GPP MPR (dB)	16QAM			3GPP MPR (dB)	64QAM			3GPP MPR (dB)
			Low CH	Mid CH	High CH		Low CH	Mid CH	High CH		Low CH	Mid CH	High CH	
			26055	26365	26675		26055	26365	26675		26055	26365	26675	
			1851.5	1882.5	1913.5		1851.5	1882.5	1913.5		1851.5	1882.5	1913.5	
			MHz	MHz	MHz	MHz	MHz	MHz	MHz	MHz				
25 / 3M	1	0	23.55	23.57	23.69	0	22.18	22.25	22.46	1	21.33	21.39	21.32	2
Gain (dBi)			4.92	4.92	4.92		4.92	4.92	4.92		4.92	4.92		
Max EIRP Power (dBm)			28.47	28.49	28.61		27.10	27.17	27.38		26.25	26.31	26.24	

Band / BW	RB Size	RB Offset	QPSK			3GPP MPR (dB)	16QAM			3GPP MPR (dB)	64QAM			3GPP MPR (dB)
			Low CH	Mid CH	High CH		Low CH	Mid CH	High CH		Low CH	Mid CH	High CH	
			26065	26365	26665		26065	26365	26665		26065	26365	26665	
			1852.5	1882.5	1912.5		1852.5	1882.5	1912.5		1852.5	1882.5	1912.5	
			MHz	MHz	MHz	MHz	MHz	MHz	MHz	MHz				
25 / 5M	1	0	23.52	23.57	23.68	0	22.37	22.36	22.12	1	21.32	21.41	21.22	2
Gain (dBi)			4.92	4.92	4.92		4.92	4.92	4.92		4.92	4.92		
Max EIRP Power (dBm)			28.44	28.49	28.60		27.29	27.28	27.04		26.24	26.33	26.14	

Band / BW	RB Size	RB Offset	QPSK			3GPP MPR (dB)	16QAM			3GPP MPR (dB)	64QAM			3GPP MPR (dB)
			Low CH	Mid CH	High CH		Low CH	Mid CH	High CH		Low CH	Mid CH	High CH	
			26090	26365	26640		26090	26365	26640		26090	26365	26640	
			1855	1882.5	1910		1855	1882.5	1910		1855	1882.5	1910	
			MHz	MHz	MHz	MHz	MHz	MHz	MHz	MHz				
25 / 10M	1	0	23.60	23.65	23.57	0	22.29	22.39	22.48	1	21.35	21.40	21.38	2
Gain (dBi)			4.92	4.92	4.92		4.92	4.92	4.92		4.92	4.92		
Max EIRP Power (dBm)			28.52	28.57	28.49		27.21	27.31	27.40		26.27	26.32	26.30	

Band / BW	RB Size	RB Offset	QPSK			3GPP MPR (dB)	16QAM			3GPP MPR (dB)	64QAM			3GPP MPR (dB)
			Low CH	Mid CH	High CH		Low CH	Mid CH	High CH		Low CH	Mid CH	High CH	
			26115	26365	26615		26115	26365	26615		26115	26365	26615	
			1857.5	1882.5	1907.5		1857.5	1882.5	1907.5		1857.5	1882.5	1907.5	
			MHz	MHz	MHz	MHz	MHz	MHz	MHz	MHz	MHz			
25 / 15M	1	0	23.53	23.56	23.64	0	22.29	22.23	22.44	1	21.23	21.35	21.43	2
Gain (dBi)			4.92	4.92	4.92		4.92	4.92	4.92		4.92	4.92	4.92	
Max EIRP Power (dBm)			28.45	28.48	28.56		27.21	27.15	27.36		26.15	26.27	26.35	

Band / BW	RB Size	RB Offset	QPSK			3GPP MPR (dB)	16QAM			3GPP MPR (dB)	64QAM			3GPP MPR (dB)
			Low CH	Mid CH	High CH		Low CH	Mid CH	High CH		Low CH	Mid CH	High CH	
			26140	26365	26590		26140	26365	26590		26140	26365	26590	
			1860	1882.5	1905		1860	1882.5	1905		1860	1882.5	1905	
			MHz	MHz	MHz	MHz	MHz	MHz	MHz	MHz				
25 / 20M	1	0	23.59	23.61	23.75	0	22.33	22.38	22.52	1	21.38	21.42	21.33	2
Gain (dBi)			4.92	4.92	4.92		4.92	4.92	4.92		4.92	4.92		
Max EIRP Power (dBm)			28.51	28.53	28.67		27.25	27.30	27.44		26.30	26.34	26.25	

## 4.2 Modulation characteristics Measurement

### 4.2.1 Limits of Modulation characteristics

N/A

### 4.2.2 Test Procedure

Connect the EUT to Communication Simulator via the antenna connector, The frequency band is set as EUT supported Modulation and Channels, the EUT output is matched with 50 ohm load, the waveform quality and constellation of the EUT was tested.

### 4.2.3 Test Setup



## 4.2.4 Test Results

### LTE Band 2

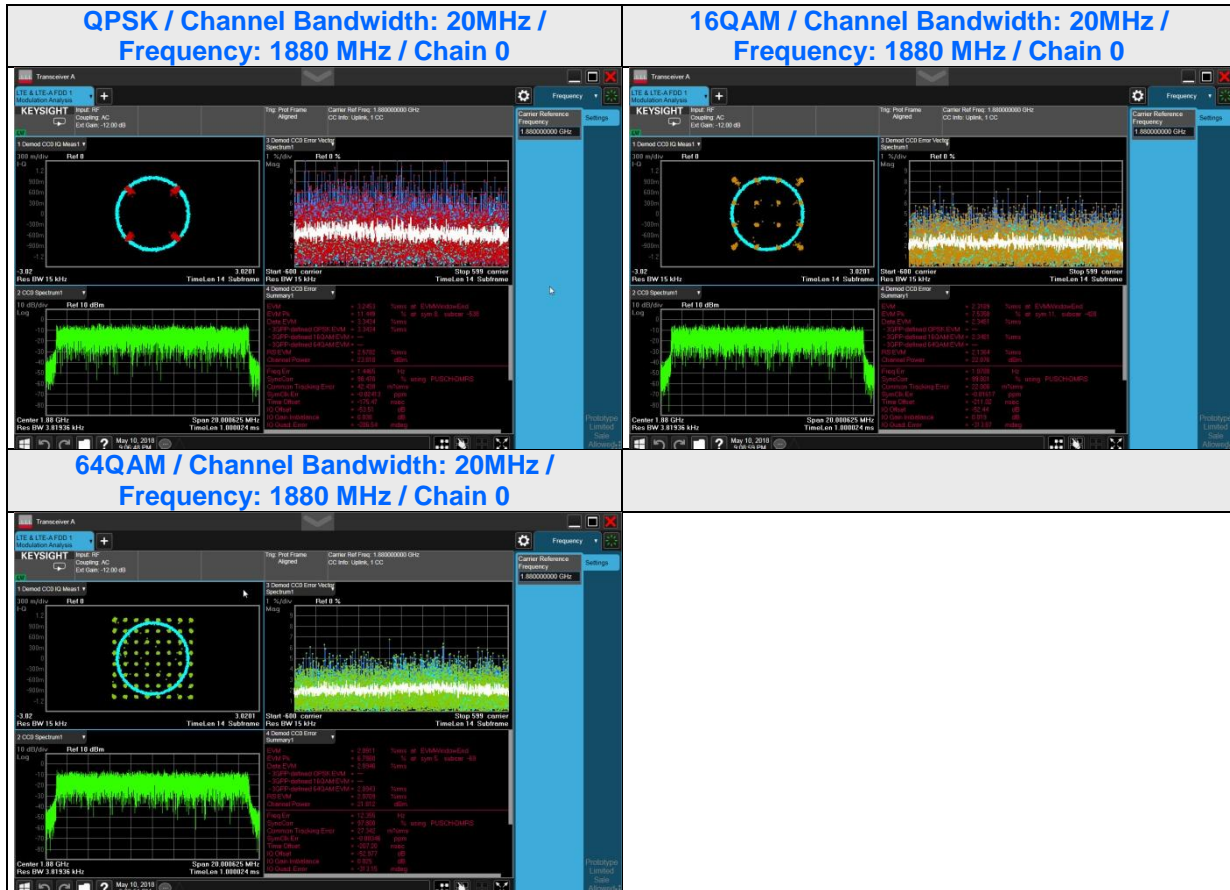

# LTE Band 25

**QPSK / Channel Bandwidth: 20MHz /  
Frequency: 1882.5 MHz / Chain 0**

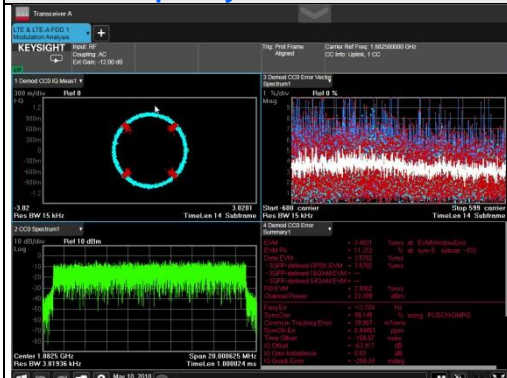

**16QAM / Channel Bandwidth: 20MHz /  
Frequency: 1882.5 MHz / Chain 0**

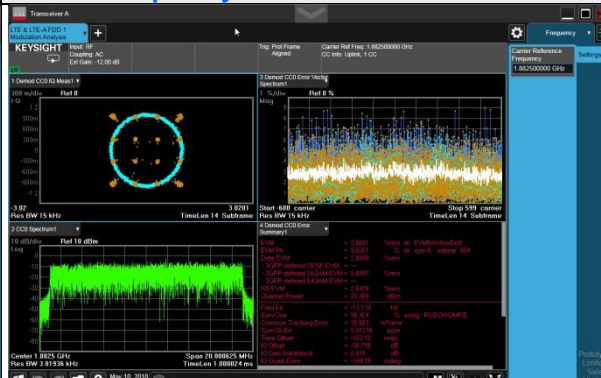

**64QAM / Channel Bandwidth: 20MHz /  
Frequency: 1882.5 MHz / Chain 0**

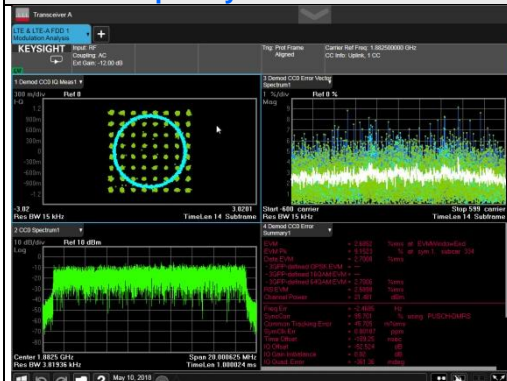



### 4.3 Frequency Stability Measurement

#### 4.3.1 Limits of Frequency Stability Measurement

The frequency stability shall be sufficient to ensure that the fundamental emission stays within the authorized frequency block.

#### 4.3.2 Test Procedure

- Device is placed at the oven room. The oven room could control the temperatures and humidity. Power warm up is at least 15 min and power applied should perform before recording frequency error.
- EUT is connected the external power supply to control the DC input power. The test voltage range is from minimum to maximum working voltage. Each step shall be record the frequency error rate.
- The temperature range step is 10 degrees in this test items. All temperature levels shall be hold the  $\pm 0.5$  °C during the measurement testing. The each temperature step shall be at least 0.5 hours, consider the EUT could be test under the stability condition.

**NOTE:** The frequency error was recorded frequency error from the communication simulator.

#### 4.3.3 Test Setup

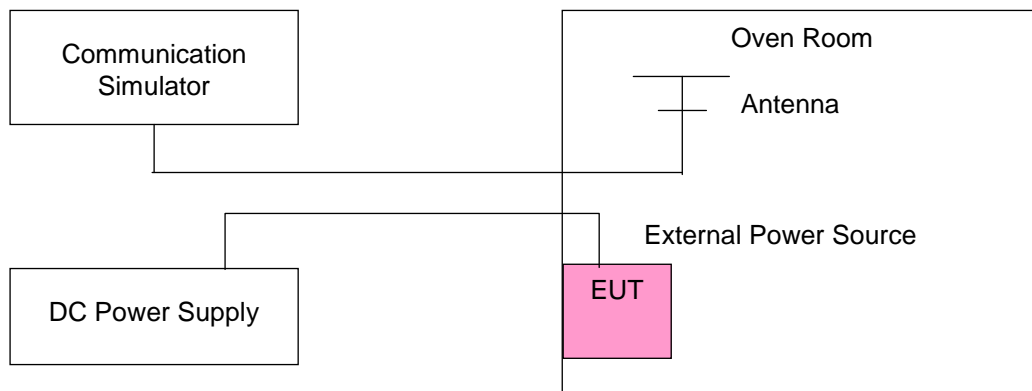

#### 4.3.4 Test Results

#### WCDMA

##### Frequency Error vs. Voltage

Voltage (Volts)	Frequency Error (MHz)		Limit (MHz)	
	WCDMA		Low Edge	High Edge
	Low	High		
2.805	1850.34	1909.72	1850	1910
3.795	1850.27	1909.61	1850	1910

##### Frequency Error vs. Temperature.

TEMP. (°C)	Frequency Error (MHz)		Limit (MHz)	
	WCDMA		Low Edge	High Edge
	Low	High		
50	1850.41	1909.70	1850	1910
40	1850.25	1909.69	1850	1910
30	1850.32	1909.68	1850	1910
20	1850.33	1909.69	1850	1910
10	1850.30	1909.68	1850	1910
0	1850.30	1909.68	1850	1910
-10	1850.32	1909.70	1850	1910
-20	1850.41	1909.69	1850	1910
-30	1850.32	1909.69	1850	1910

## LTE Band 2

### Frequency Error vs. Voltage

Voltage (Volts)	Frequency Error (MHz)												Limit (MHz)	
	1.4MHz		3MHz		5MHz		10MHz		15MHz		20MHz			
	Low	High	Low	High	Low	High	Low	High	Low	High	Low	High	Low Edge	High Edge
2.805	1850.11	1909.86	1850.10	1909.81	1852.43	1907.44	1850.45	1909.50	1850.85	1909.12	1851.06	1908.87	1850	1910
3.795	1850.18	1909.83	1850.12	1909.79	1852.51	1907.41	1850.53	1909.47	1850.84	1909.28	1851.02	1908.95	1850	1910

### Frequency Error vs. Temperature

Temp. (°C)	Frequency Error (MHz)												Limit (MHz)	
	1.4MHz		3MHz		5MHz		10MHz		15MHz		20MHz			
	Low	High	Low	High	Low	High	Low	High	Low	High	Low	High	Low Edge	High Edge
50	1850.25	1909.78	1850.23	1909.77	1852.58	1907.53	1850.57	1909.40	1850.85	1909.28	1850.97	1908.92	1850	1910
40	1850.25	1909.87	1850.23	1909.90	1852.42	1907.44	1850.51	1909.55	1850.74	1909.28	1851.10	1908.93	1850	1910
30	1850.08	1909.74	1850.23	1909.89	1852.52	1907.42	1850.45	1909.55	1850.78	1909.23	1850.96	1909.01	1850	1910
20	1850.16	1909.84	1850.15	1909.85	1852.50	1907.50	1850.52	1909.48	1850.78	1909.22	1851.04	1908.96	1850	1910
10	1850.20	1909.78	1850.07	1909.94	1852.44	1907.52	1850.55	1909.54	1850.70	1909.24	1851.08	1908.86	1850	1910
0	1850.18	1909.91	1850.16	1909.89	1852.47	1907.56	1850.48	1909.48	1850.78	1909.22	1851.03	1909.05	1850	1910
-10	1850.07	1909.83	1850.24	1909.80	1852.56	1907.45	1850.56	1909.43	1850.85	1909.30	1851.00	1909.02	1850	1910
-20	1850.24	1909.83	1850.13	1909.80	1852.43	1907.40	1850.61	1909.51	1850.75	1909.29	1851.12	1908.91	1850	1910
-30	1850.25	1909.79	1850.07	1909.82	1852.49	1907.54	1850.52	1909.52	1850.78	1909.14	1851.11	1909.04	1850	1910

## LTE Band 25

### Frequency Error vs. Voltage

Voltage (Volts)	Frequency Error (MHz)												Limit (MHz)	
	1.4MHz		3MHz		5MHz		10MHz		15MHz		20MHz		Low Edge	High Edge
	Low	High	Low	High	Low	High	Low	High	Low	High	Low	High		
2.805	1850.13	1914.83	1850.24	1914.83	1850.27	1914.73	1850.57	1909.94	1850.62	1914.32	1851.06	1913.87	1850	1915
3.795	1850.17	1914.82	1850.21	1914.80	1850.30	1914.69	1850.56	1910.06	1850.69	1914.28	1851.07	1913.98	1850	1915

### Frequency Error vs. Temperature

Temp. (°C)	Frequency Error (MHz)												Limit (MHz)	
	1.4MHz		3MHz		5MHz		10MHz		15MHz		20MHz		Low Edge	High Edge
	Low	High	Low	High	Low	High	Low	High	Low	High	Low	High		
50	1850.11	1914.85	1850.24	1914.93	1850.17	1914.75	1850.47	1910.00	1850.74	1914.31	1850.99	1913.89	1850	1915
40	1850.17	1914.84	1850.19	1914.77	1850.18	1914.83	1850.41	1910.06	1850.74	1914.20	1850.97	1914.03	1850	1915
30	1850.19	1914.94	1850.15	1914.89	1850.34	1914.69	1850.52	1910.03	1850.63	1914.34	1850.97	1913.91	1850	1915
20	1850.16	1914.85	1850.15	1914.86	1850.25	1914.75	1850.51	1910.00	1850.72	1914.26	1851.02	1913.95	1850	1915
10	1850.22	1914.79	1850.11	1914.89	1850.30	1914.75	1850.55	1909.98	1850.76	1914.25	1850.99	1913.95	1850	1915
0	1850.21	1914.83	1850.16	1914.90	1850.15	1914.65	1850.58	1909.92	1850.79	1914.30	1850.94	1914.01	1850	1915
-10	1850.14	1914.75	1850.24	1914.88	1850.20	1914.82	1850.60	1909.99	1850.73	1914.32	1850.98	1913.90	1850	1915
-20	1850.23	1914.91	1850.08	1914.87	1850.16	1914.75	1850.51	1910.09	1850.76	1914.35	1850.95	1913.86	1850	1915
-30	1850.07	1914.94	1850.20	1914.94	1850.27	1914.67	1850.47	1910.03	1850.65	1914.30	1851.09	1913.91	1850	1915

## 4.4 Occupied Bandwidth Measurement

### 4.4.1 Test Procedure

All measurements were done at low, middle and high operational frequency range. The communication simulator station system controlled a EUT to export maximum output power under transmission mode and specific channel frequency. The bandwidth of the fundamental frequency was measured by spectrum analyzer with  $RBW \geq 1\% \times OBW$  and  $VBW \geq 3 \times VBW$ .

#### Occupied Bandwidth Measurement:

Use OBW measurement function of Spectrum analyzer to measure 99 % occupied bandwidth.

#### 26 dB Bandwidth Measurement:

The emission bandwidth is defined as the width of the signal between two points, one below the carrier center frequency and one above the carrier center frequency, outside of which all emission are attenuated at least 26dB below the transmitter power.

### 4.4.2 Test Setup

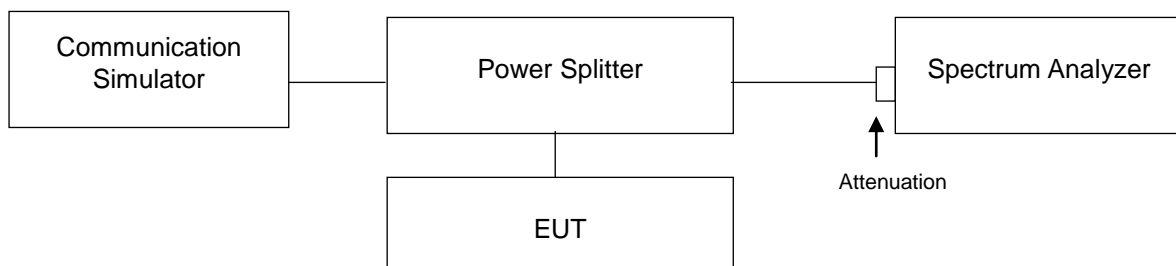

#### 4.4.3 Test Result (-26dB Bandwidth)

Channel	Freq. (MHz)	-26dB Bandwidth (MHz)
		WCDMA B2
9262	1852.4	4.70
9400	1880.0	4.66
9538	1907.6	4.69

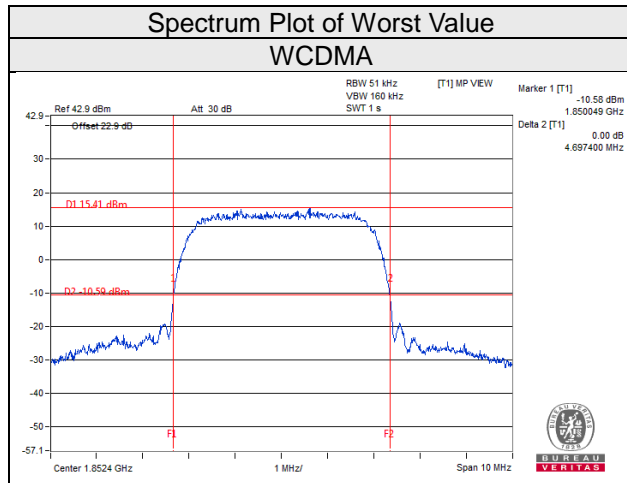

LTE Band 2									
Channel Bandwidth 1.4MHz					Channel Bandwidth 3MHz				
Channel	Frequency (MHz)	-26dB Bandwidth (MHz)			Channel	Frequency (MHz)	-26dB Bandwidth (MHz)		
		QPSK	16QAM	64QAM			QPSK	16QAM	64QAM
18607	1850.7	1.23	1.22	1.22	18615	1851.5	2.94	2.94	2.93
18900	1880	1.22	1.21	1.22	18900	1880	2.92	2.92	2.93
19193	1909.3	1.22	1.21	1.22	19185	1908.5	2.93	2.91	2.92
Channel Bandwidth 5MHz					Channel Bandwidth 10MHz				
Channel	Frequency (MHz)	-26dB Bandwidth (MHz)			Channel	Frequency (MHz)	-26dB Bandwidth (MHz)		
		QPSK	16QAM	64QAM			QPSK	16QAM	64QAM
18625	1852.5	4.82	4.82	4.80	18650	1855	9.53	9.51	9.51
18900	1880	4.79	4.80	4.80	18900	1880	9.54	9.51	9.53
19175	1907.5	4.81	4.80	4.81	19150	1905	9.52	9.51	9.51
Channel Bandwidth 15MHz					Channel Bandwidth 20MHz				
Channel	Frequency (MHz)	-26dB Bandwidth (MHz)			Channel	Frequency (MHz)	-26dB Bandwidth (MHz)		
		QPSK	16QAM	64QAM			QPSK	16QAM	64QAM
18675	1857.5	14.28	14.25	14.26	18700	1860	19.06	19.04	19.06
18900	1880	14.27	14.25	14.25	18900	1880	19.03	19.02	19.06
19125	1902.5	14.23	14.24	14.23	19100	1900	19.07	19.03	19.06

### Spectrum Plot of Worst Value

#### 1.4MHz / QPSK

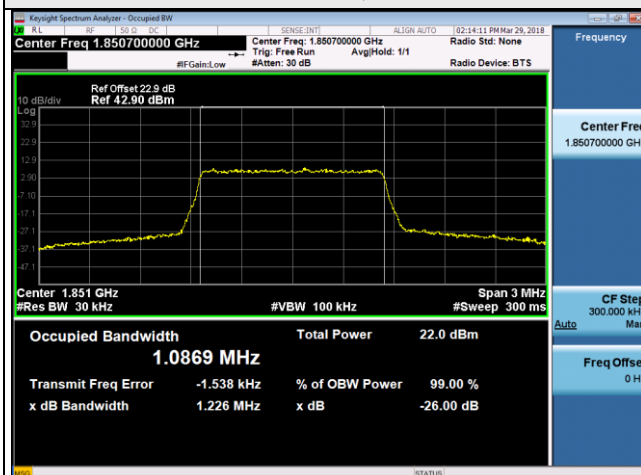

#### 3MHz / QPSK

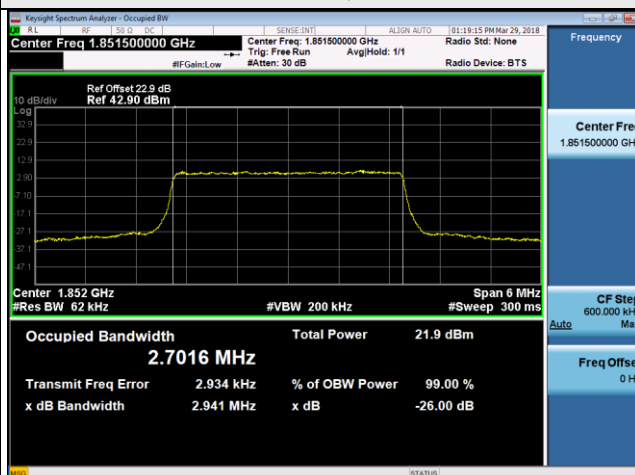

#### 5MHz / QPSK



#### 10MHz / QPSK



#### 15MHz / QPSK

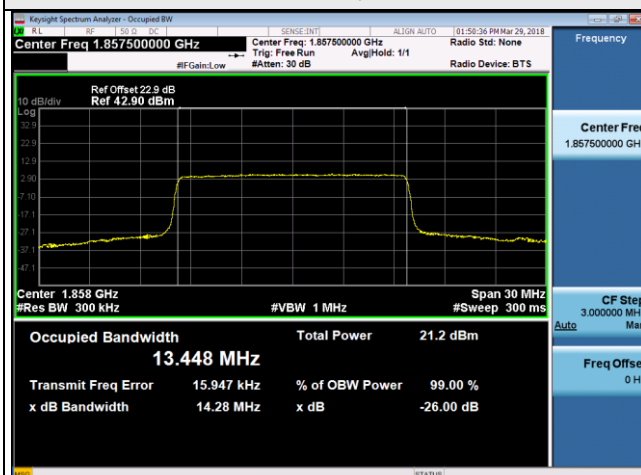

#### 20MHz / QPSK

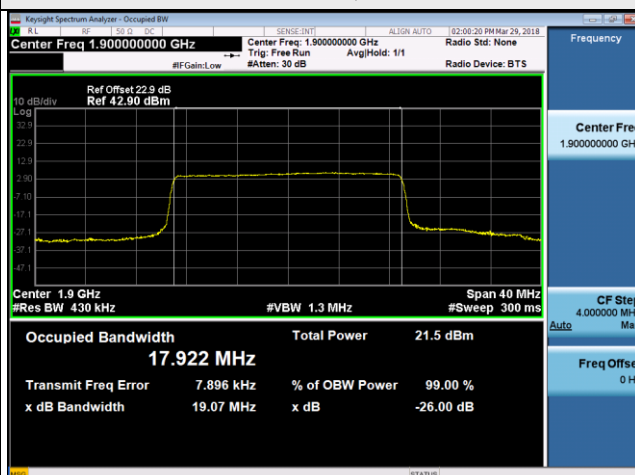



LTE Band 25									
Channel Bandwidth 1.4MHz					Channel Bandwidth 3MHz				
Channel	Frequency (MHz)	-26dB Bandwidth (MHz)			Channel	Frequency (MHz)	-26dB Bandwidth (MHz)		
		QPSK	16QAM	64QAM			QPSK	16QAM	64QAM
26047	1850.7	1.22	1.22	1.22	26055	1851.5	2.94	2.94	2.92
26365	1882.5	1.22	1.22	1.22	26365	1882.5	2.94	2.92	2.93
26683	1914.3	1.25	1.23	1.24	26675	1913.5	2.98	2.93	2.96
Channel Bandwidth 5MHz					Channel Bandwidth 10MHz				
Channel	Frequency (MHz)	-26dB Bandwidth (MHz)			Channel	Frequency (MHz)	-26dB Bandwidth (MHz)		
		QPSK	16QAM	64QAM			QPSK	16QAM	64QAM
26065	1852.5	4.83	4.86	4.87	26090	1855	9.66	9.58	9.52
26365	1882.5	4.84	4.82	4.83	26365	1882.5	9.56	9.95	9.86
26665	1912.5	4.87	4.87	4.85	26640	1910	9.61	9.59	9.55
Channel Bandwidth 15MHz					Channel Bandwidth 20MHz				
Channel	Frequency (MHz)	-26dB Bandwidth (MHz)			Channel	Frequency (MHz)	-26dB Bandwidth (MHz)		
		QPSK	16QAM	64QAM			QPSK	16QAM	64QAM
26615	1857.5	14.54	14.31	14.27	26140	1860	19.18	19.07	19.08
26365	1882.5	14.32	14.27	14.25	26365	1882.5	19.05	19.03	19.06
26615	1907.5	14.34	14.29	14.28	26590	1905	19.03	19.03	19.05

### Spectrum Plot of Worst Value

#### 1.4MHz / QPSK

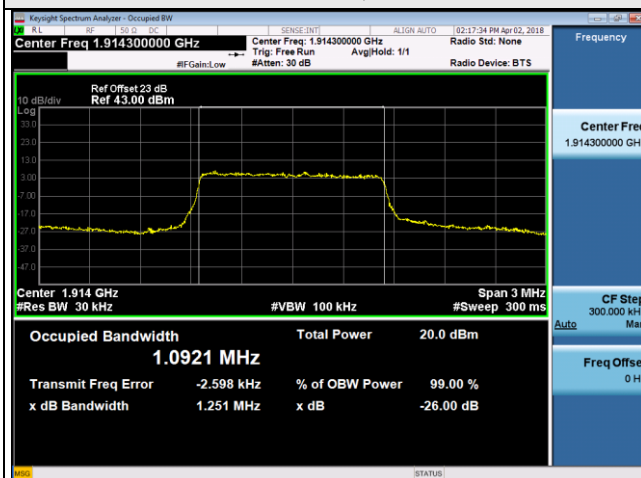

#### 3MHz / QPSK

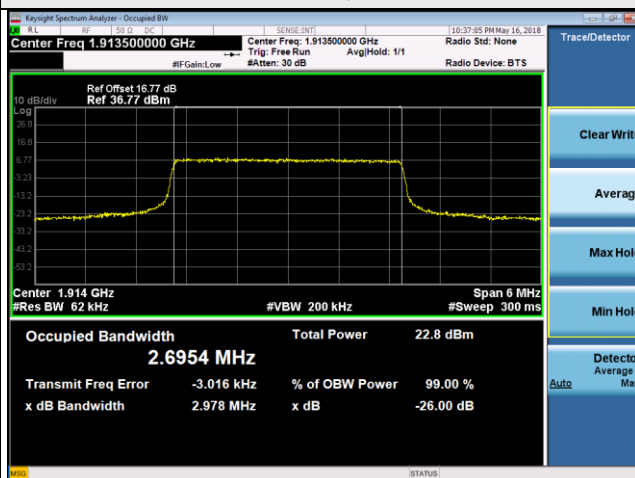

#### 5MHz / QPSK

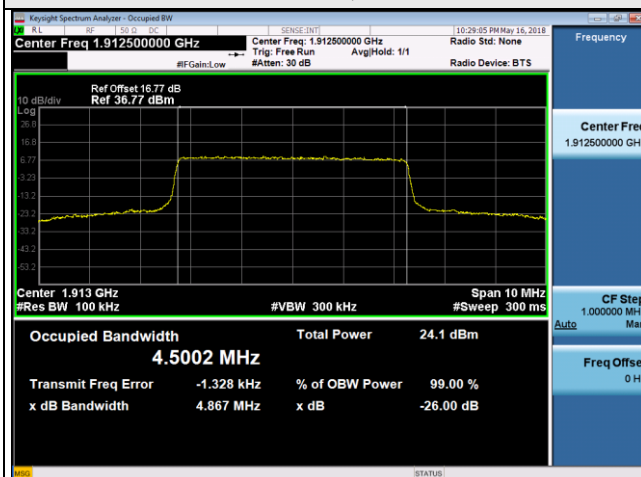

#### 10MHz / 64QAM



#### 15MHz / QPSK

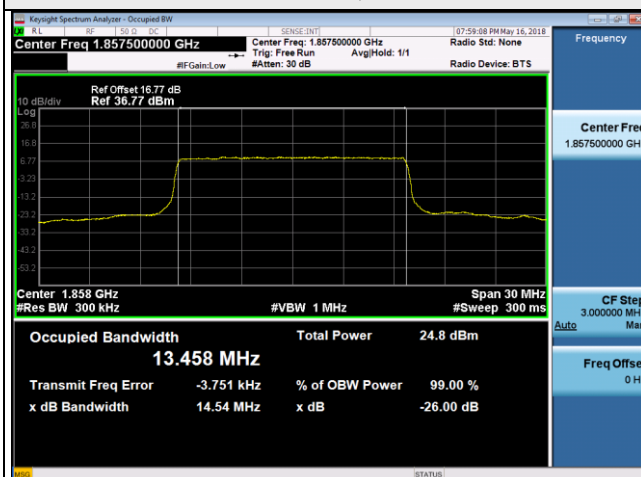

#### 20MHz / QPSK

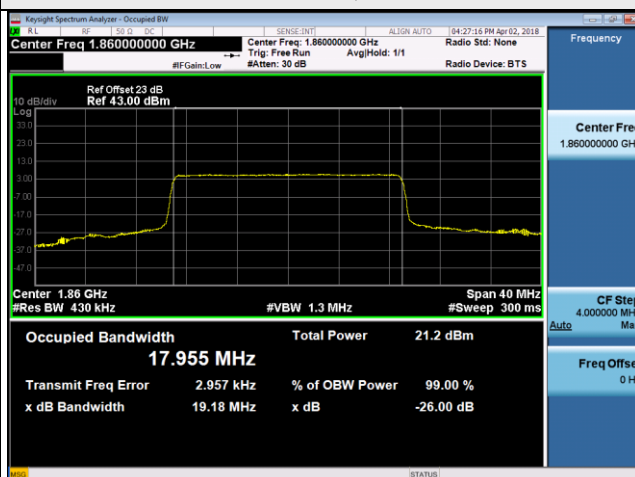

#### 4.4.4 Test Result (Occupied Bandwidth)

Channel	Freq. (MHz)	99% Occupied Bandwidth (MHz)
		WCDMA B2
9262	1852.4	4.15
9400	1880.0	4.13
9538	1907.6	4.16

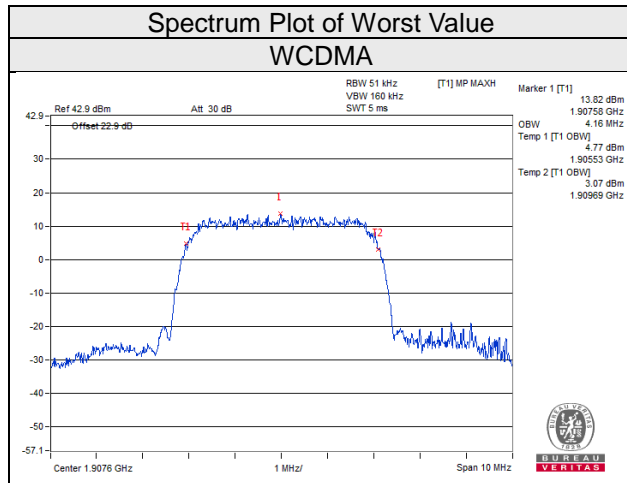

LTE Band 2									
Channel Bandwidth 1.4MHz					Channel Bandwidth 3MHz				
Channel	Frequency (MHz)	99% Occupied Bandwidth (MHz)			Channel	Frequency (MHz)	99% Occupied Bandwidth (MHz)		
		QPSK	16QAM	64QAM			QPSK	16QAM	64QAM
18607	1850.7	1.09	1.09	1.09	18615	1851.5	2.70	2.70	2.70
18900	1880	1.09	1.09	1.09	18900	1880	2.70	2.70	2.70
19193	1909.3	1.09	1.09	1.09	19185	1907.5	2.70	2.70	2.70
Channel Bandwidth 5MHz					Channel Bandwidth 10MHz				
Channel	Frequency (MHz)	99% Occupied Bandwidth (MHz)			Channel	Frequency (MHz)	99% Occupied Bandwidth (MHz)		
		QPSK	16QAM	64QAM			QPSK	16QAM	64QAM
18625	1852.5	4.49	4.49	4.49	18650	1855	8.96	8.97	8.96
18900	1880	4.49	4.49	4.49	18900	1880	8.96	8.97	8.96
19175	1907.5	4.49	4.49	4.49	19150	1905	8.96	8.96	8.95
Channel Bandwidth 15MHz					Channel Bandwidth 20MHz				
Channel	Frequency (MHz)	99% Occupied Bandwidth (MHz)			Channel	Frequency (MHz)	99% Occupied Bandwidth (MHz)		
		QPSK	16QAM	64QAM			QPSK	16QAM	64QAM
18675	1857.5	13.45	13.44	13.44	18700	1860	17.91	17.94	17.94
18900	1880	13.43	13.43	13.42	18900	1880	17.89	17.91	17.91
19125	1902.5	13.43	13.42	13.42	19100	1900	17.92	17.94	17.95

### Spectrum Plot of Worst Value

1.4MHz / QPSK

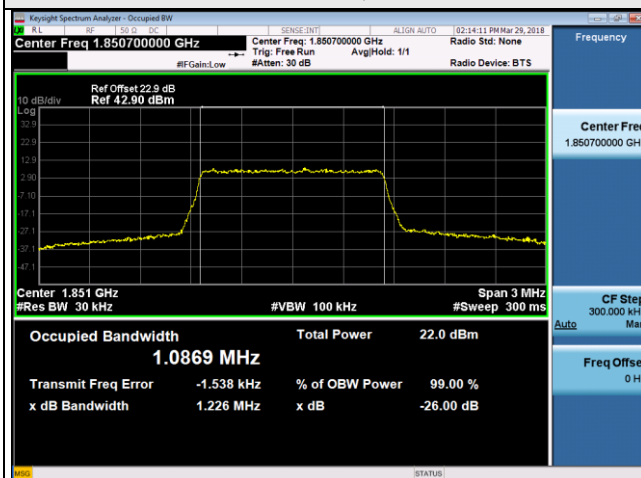

3MHz / QPSK

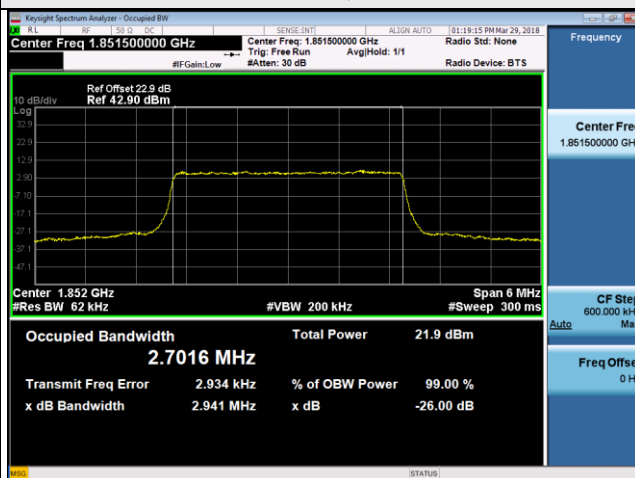

5MHz / QPSK

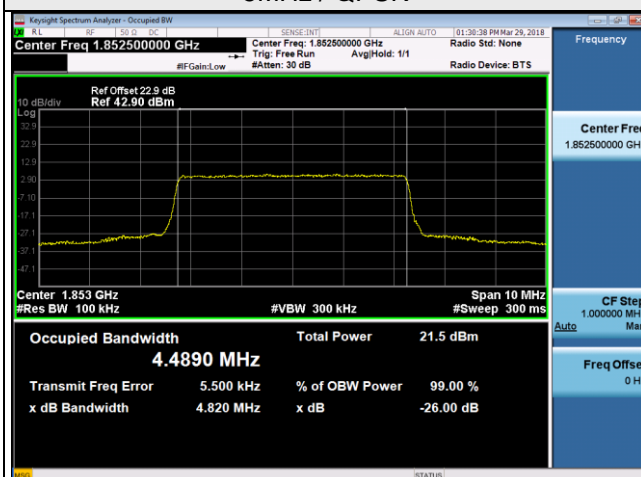

10MHz / 16QAM

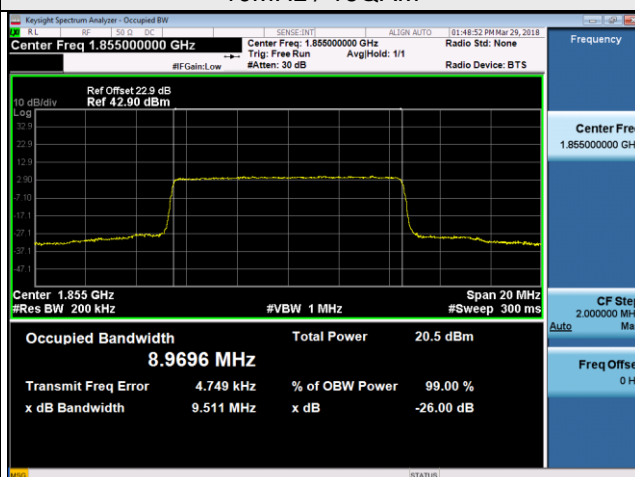

15MHz / QPSK

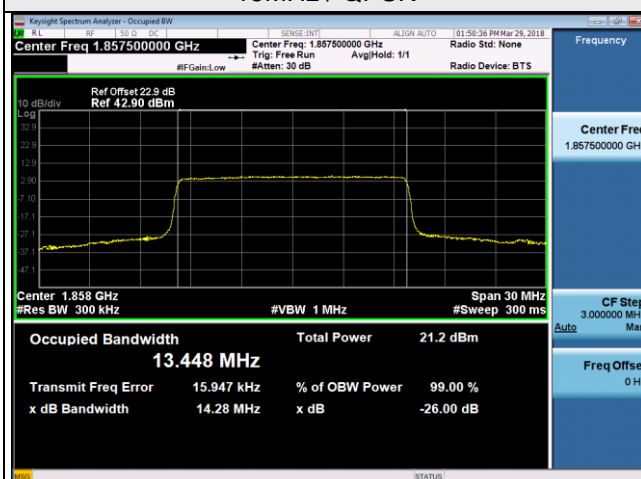

20MHz / 64QAM

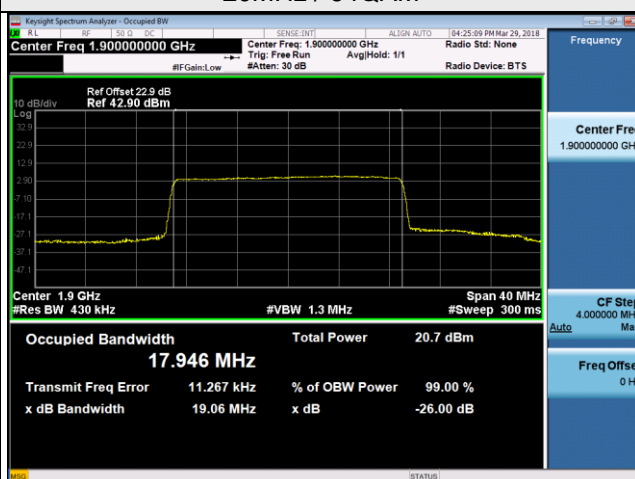

LTE Band 25									
Channel Bandwidth 1.4MHz					Channel Bandwidth 3MHz				
Channel	Frequency (MHz)	99% Occupied Bandwidth (MHz)			Channel	Frequency (MHz)	99% Occupied Bandwidth (MHz)		
		QPSK	16QAM	64QAM			QPSK	16QAM	64QAM
26047	1850.7	1.09	1.09	1.09	26055	1851.5	2.70	2.70	2.71
26365	1882.5	1.09	1.09	1.09	26365	1882.5	2.70	2.70	2.70
26683	1914.3	1.09	1.09	1.09	26675	1913.5	2.70	2.70	2.71
Channel Bandwidth 5MHz					Channel Bandwidth 10MHz				
Channel	Frequency (MHz)	99% Occupied Bandwidth (MHz)			Channel	Frequency (MHz)	99% Occupied Bandwidth (MHz)		
		QPSK	16QAM	64QAM			QPSK	16QAM	64QAM
26065	1852.5	4.49	4.50	4.50	26090	1855	8.99	8.97	8.98
26365	1882.5	4.49	4.49	4.50	26365	1882.5	8.96	9.01	8.99
26665	1912.5	4.50	4.50	4.50	26640	1910	8.95	8.96	8.97
Channel Bandwidth 15MHz					Channel Bandwidth 20MHz				
Channel	Frequency (MHz)	99% Occupied Bandwidth (MHz)			Channel	Frequency (MHz)	99% Occupied Bandwidth (MHz)		
		QPSK	16QAM	64QAM			QPSK	16QAM	64QAM
26615	1857.5	13.46	13.47	13.47	26140	1860	17.96	17.98	17.97
26365	1882.5	13.45	13.45	13.45	26365	1882.5	17.91	17.94	17.94
26615	1907.5	13.43	13.43	13.44	26590	1905	17.90	17.93	17.92

### Spectrum Plot of Worst Value

1.4MHz / QPSK

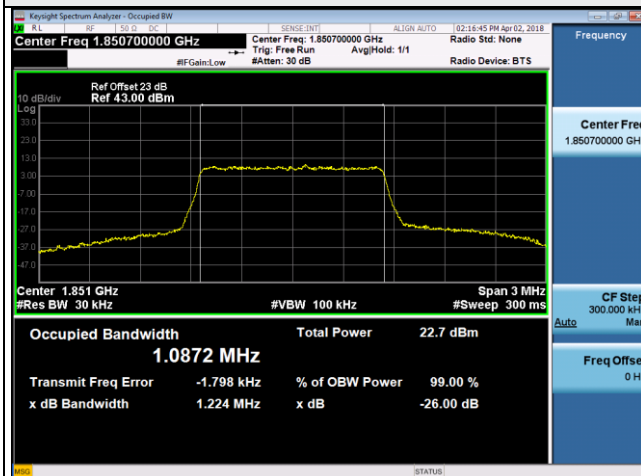

3MHz / 64QAM



5MHz / QPSK

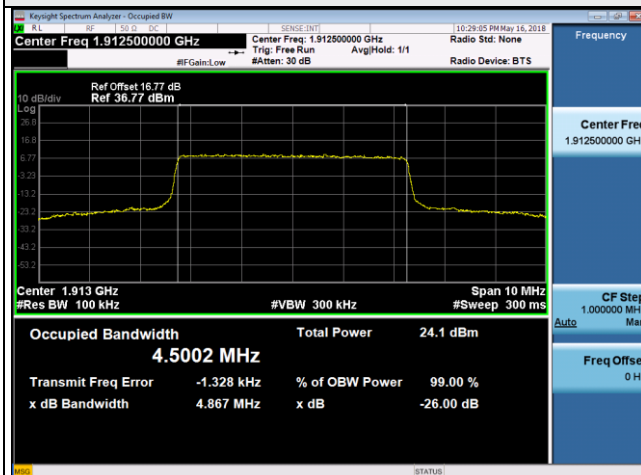

10MHz / 16QAM

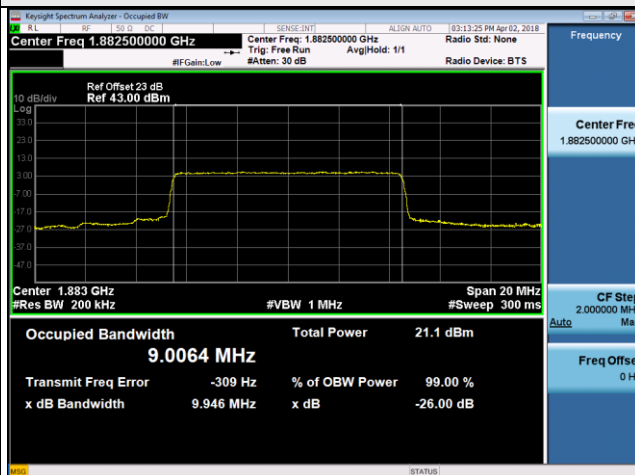

15MHz / 16QAM

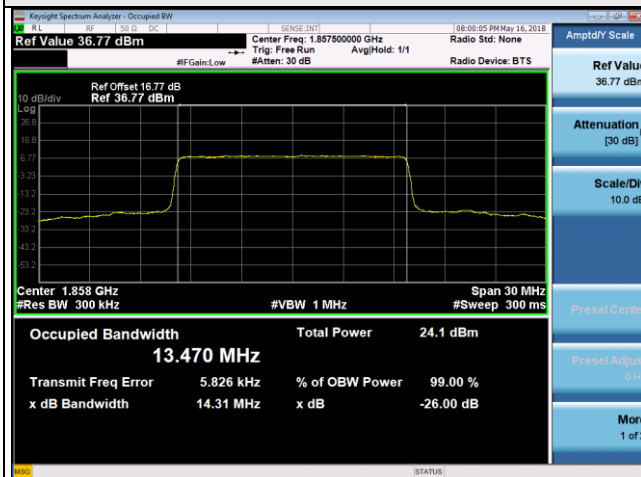

20MHz / 16QAM

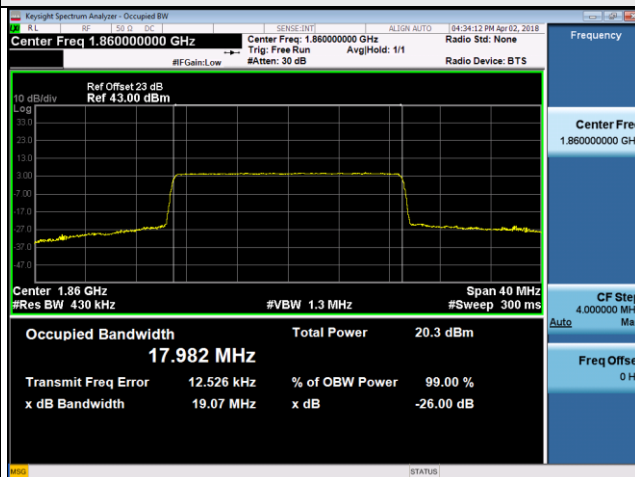

## 4.5 Band Edge Measurement

### 4.5.1 Limits of Band Edge Measurement

Power of any emission outside of the authorized operating frequency ranges must be attenuated below the transmitting power (P) by a factor of at least  $43 + 10 \log(P)$  dB. In the 1 MHz bands immediately outside and adjacent to the frequency block a resolution bandwidth of at least one percent of the emission bandwidth of the fundamental emission of the transmitter may be employed.

### 4.5.2 Test Setup

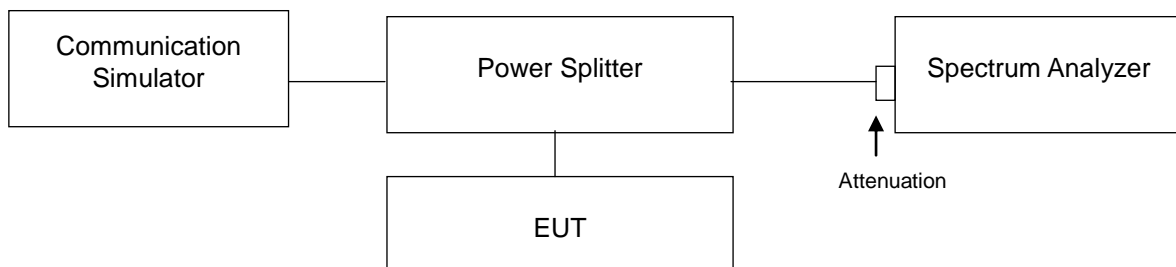

### 4.5.3 Test Procedures

- All measurements were done at low and high operational frequency range.
- The center frequency of spectrum is the band edge frequency and RB of the spectrum is  $>1\%$  emission bandwidth and VB of the spectrum is  $\geq 3 \cdot RB$ .
- Record the max trace plot into the test report.



### 4.5.4 Test Results

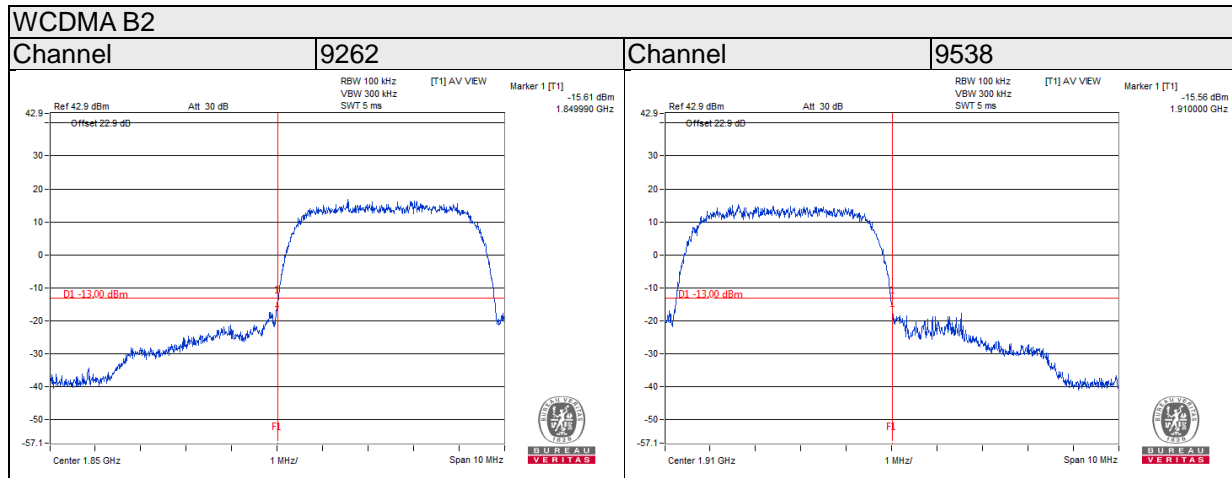

LTE Band 2

Channel Bandwidth 1.4MHz

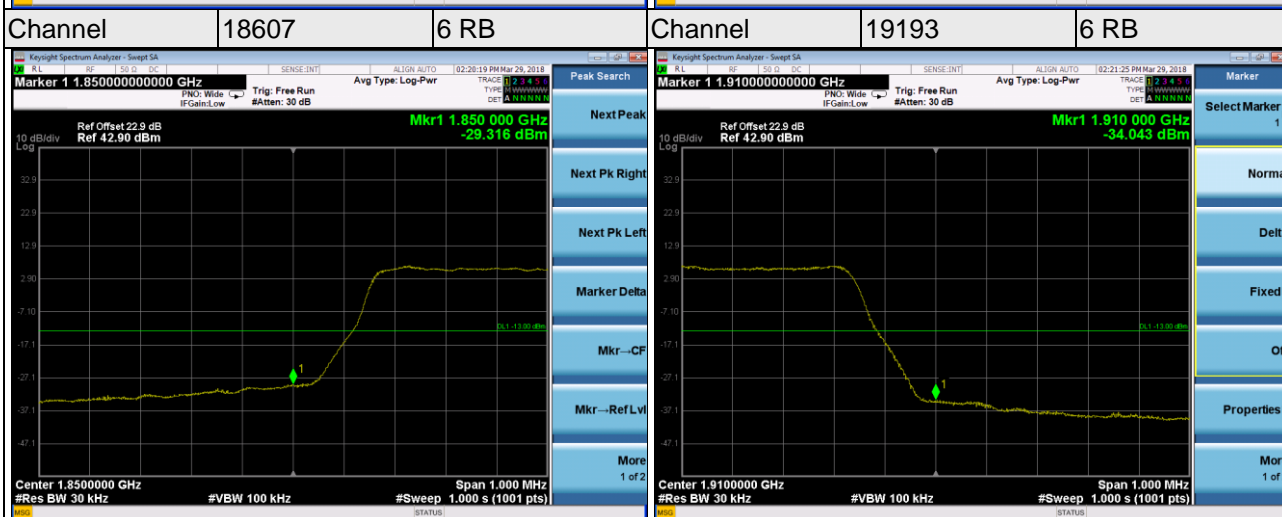
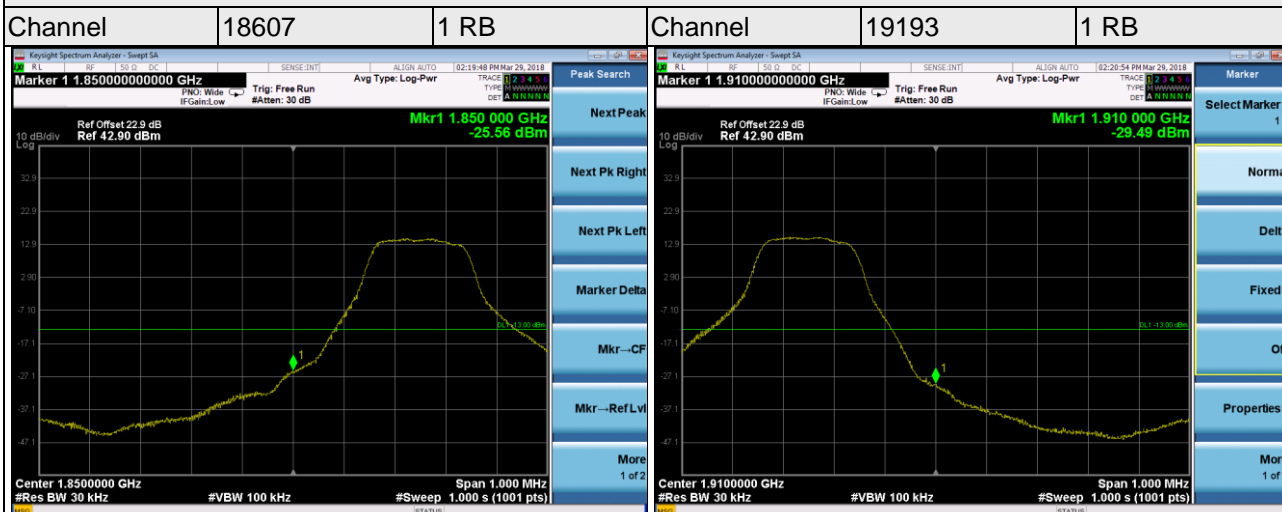

## LTE Band 2

### Channel Bandwidth 3MHz

