

Impedance Measurement Plot for Head TSL

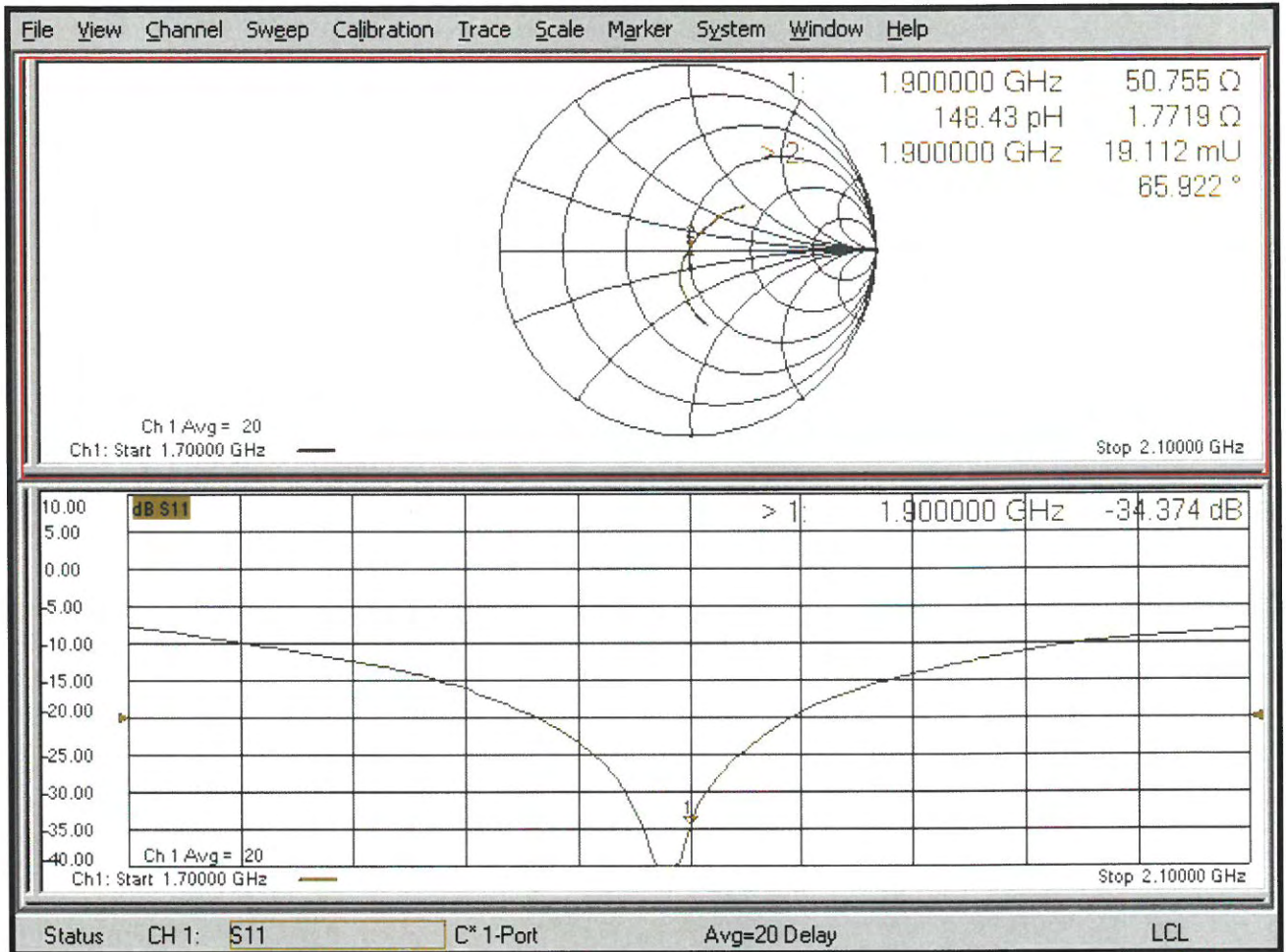

DASY5 Validation Report for Body TSL

Date: 27.06.2019

Test Laboratory: SPEAG, Zurich, Switzerland

DUT: Dipole 1900 MHz; Type: D1900V2; Serial: D1900V2 - SN:5d018

Communication System: UID 0 - CW; Frequency: 1900 MHz

Medium parameters used: $f = 1900$ MHz; $\sigma = 1.5$ S/m; $\epsilon_r = 54.2$; $\rho = 1000$ kg/m³

Phantom section: Flat Section

Measurement Standard: DASY5 (IEEE/IEC/ANSI C63.19-2011)

DASY52 Configuration:

- Probe: EX3DV4 - SN7349; ConvF(8.42, 8.42, 8.42) @ 1900 MHz; Calibrated: 29.05.2019
- Sensor-Surface: 1.4mm (Mechanical Surface Detection)
- Electronics: DAE4 Sn601; Calibrated: 30.04.2019
- Phantom: Flat Phantom 5.0 (back); Type: QD 000 P50 AA; Serial: 1002
- DASY52 52.10.2(1504); SEMCAD X 14.6.12(7470)

Dipole Calibration for Body Tissue/Pin=250 mW, d=10mm/Zoom Scan (7x7x7)/Cube 0:

Measurement grid: dx=5mm, dy=5mm, dz=5mm

Reference Value = 104.5 V/m; Power Drift = -0.06 dB

Peak SAR (extrapolated) = 17.7 W/kg

SAR(1 g) = 9.91 W/kg; SAR(10 g) = 5.25 W/kg

Maximum value of SAR (measured) = 14.9 W/kg

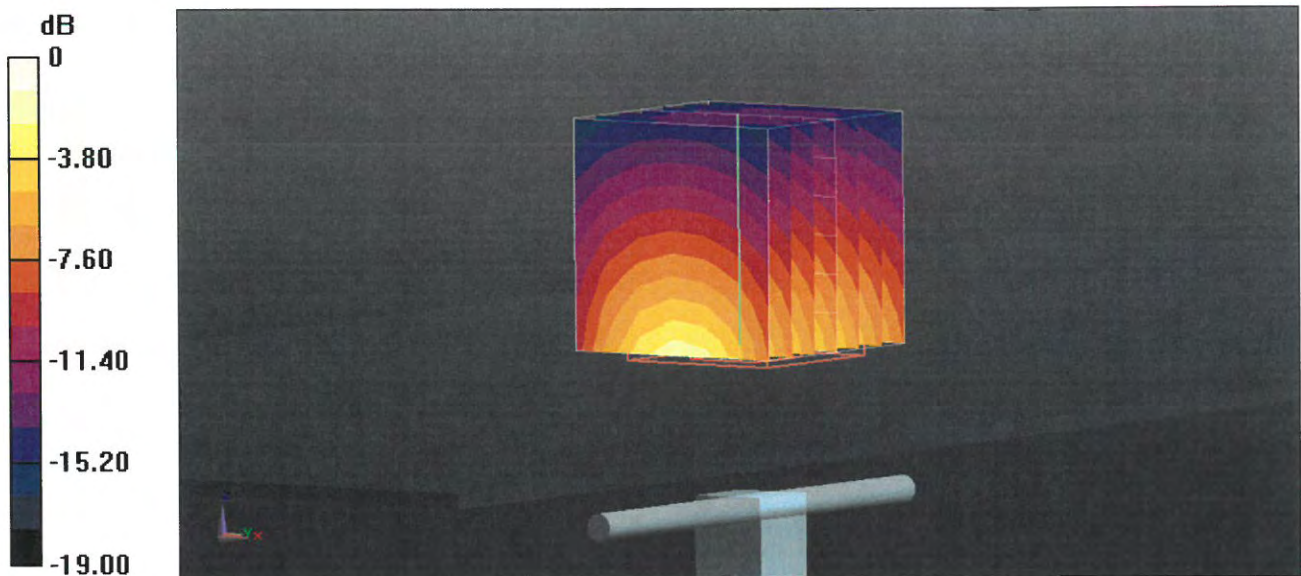

Impedance Measurement Plot for Body TSL

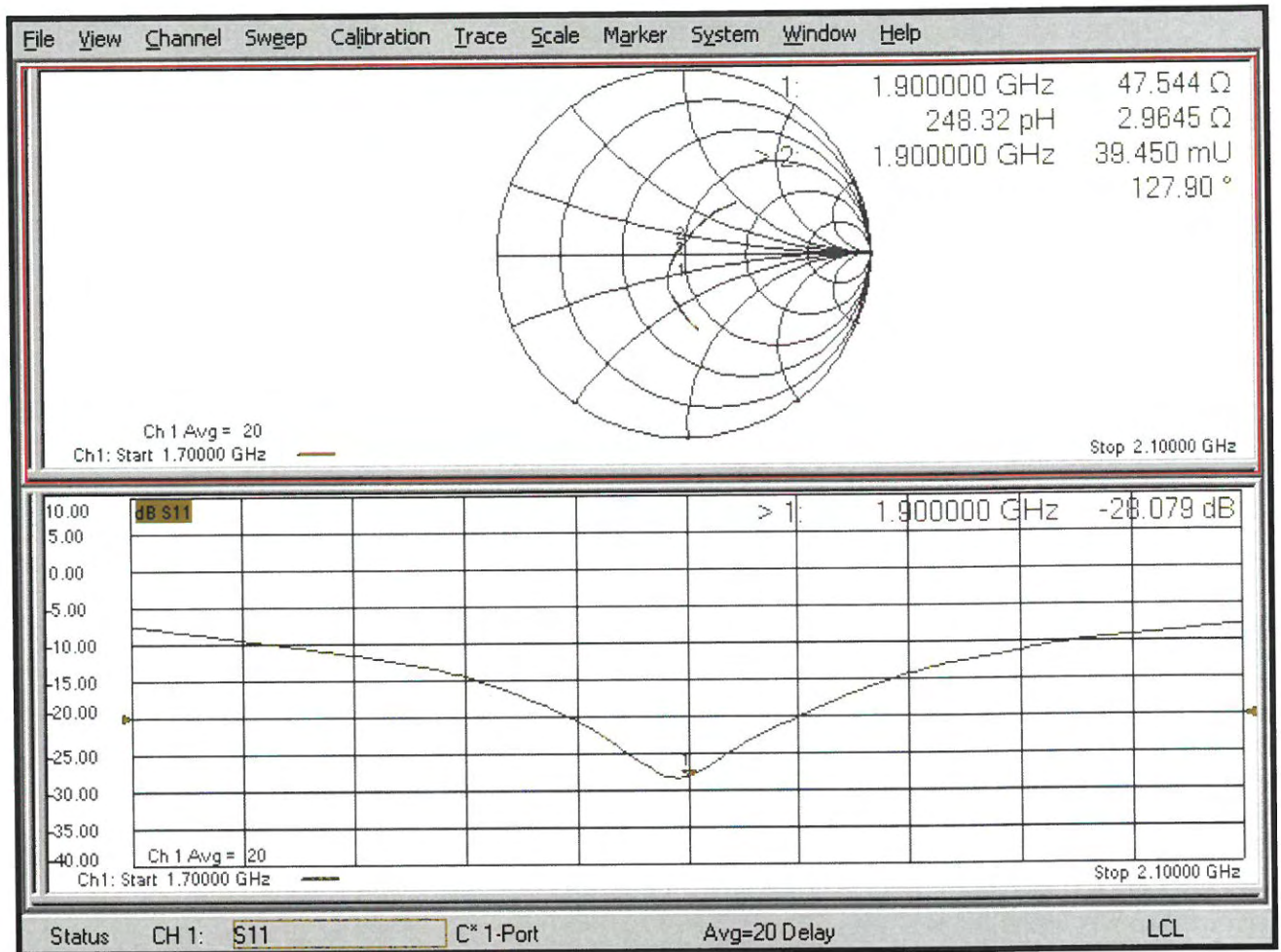



Accredited by the Swiss Accreditation Service (SAS)
The Swiss Accreditation Service is one of the signatories to the EA
Multilateral Agreement for the recognition of calibration certificates

Accreditation No.: **SCS 0108**

Client **Auden**

Certificate No: **D2300V2-1092_Dec19**

CALIBRATION CERTIFICATE

Object **D2300V2 - SN:1092**

Calibration procedure(s) **QA CAL-05.v11
Calibration Procedure for SAR Validation Sources between 0.7-3 GHz**

Calibration date: **December 13, 2019**

This calibration certificate documents the traceability to national standards, which realize the physical units of measurements (SI).
The measurements and the uncertainties with confidence probability are given on the following pages and are part of the certificate.

All calibrations have been conducted in the closed laboratory facility: environment temperature (22 ± 3)°C and humidity < 70%.

Calibration Equipment used (M&TE critical for calibration)

| Primary Standards | ID # | Cal Date (Certificate No.) | Scheduled Calibration |
|-----------------------------|--------------------|---------------------------------|-----------------------|
| Power meter NRP | SN: 104778 | 03-Apr-19 (No. 217-02892/02893) | Apr-20 |
| Power sensor NRP-Z91 | SN: 103244 | 03-Apr-19 (No. 217-02892) | Apr-20 |
| Power sensor NRP-Z91 | SN: 103245 | 03-Apr-19 (No. 217-02893) | Apr-20 |
| Reference 20 dB Attenuator | SN: 5058 (20k) | 04-Apr-19 (No. 217-02894) | Apr-20 |
| Type-N mismatch combination | SN: 5047.2 / 06327 | 04-Apr-19 (No. 217-02895) | Apr-20 |
| Reference Probe EX3DV4 | SN: 7349 | 29-May-19 (No. EX3-7349_May19) | May-20 |
| DAE4 | SN: 601 | 30-Apr-19 (No. DAE4-601_Apr19) | Apr-20 |

| Secondary Standards | ID # | Check Date (in house) | Scheduled Check |
|---------------------------------|----------------|-----------------------------------|------------------------|
| Power meter E4419B | SN: GB39512475 | 30-Oct-14 (in house check Feb-19) | In house check: Oct-20 |
| Power sensor HP 8481A | SN: US37292783 | 07-Oct-15 (in house check Oct-18) | In house check: Oct-20 |
| Power sensor HP 8481A | SN: MY41092317 | 07-Oct-15 (in house check Oct-18) | In house check: Oct-20 |
| RF generator R&S SMT-06 | SN: 100972 | 15-Jun-15 (in house check Oct-18) | In house check: Oct-20 |
| Network Analyzer Agilent E8358A | SN: US41080477 | 31-Mar-14 (in house check Oct-19) | In house check: Oct-20 |

Calibrated by: **Michael Weber** (Name) **Laboratory Technician** (Function)  (Signature)

Approved by: **Katja Pokovic** (Name) **Technical Manager** (Function)  (Signature)

Issued: December 16, 2019

This calibration certificate shall not be reproduced except in full without written approval of the laboratory.



Accredited by the Swiss Accreditation Service (SAS)

The Swiss Accreditation Service is one of the signatories to the EA Multilateral Agreement for the recognition of calibration certificates

Glossary:

| | |
|-------|---------------------------------|
| TSL | tissue simulating liquid |
| ConvF | sensitivity in TSL / NORM x,y,z |
| N/A | not applicable or not measured |

Calibration is Performed According to the Following Standards:

- IEEE Std 1528-2013, "IEEE Recommended Practice for Determining the Peak Spatial-Averaged Specific Absorption Rate (SAR) in the Human Head from Wireless Communications Devices: Measurement Techniques", June 2013
- IEC 62209-1, "Measurement procedure for the assessment of Specific Absorption Rate (SAR) from hand-held and body-mounted devices used next to the ear (frequency range of 300 MHz to 6 GHz)", July 2016
- IEC 62209-2, "Procedure to determine the Specific Absorption Rate (SAR) for wireless communication devices used in close proximity to the human body (frequency range of 30 MHz to 6 GHz)", March 2010
- KDB 865664, "SAR Measurement Requirements for 100 MHz to 6 GHz"

Additional Documentation:

- DASY4/5 System Handbook

Methods Applied and Interpretation of Parameters:

- Measurement Conditions:** Further details are available from the Validation Report at the end of the certificate. All figures stated in the certificate are valid at the frequency indicated.
- Antenna Parameters with TSL:** The dipole is mounted with the spacer to position its feed point exactly below the center marking of the flat phantom section, with the arms oriented parallel to the body axis.
- Feed Point Impedance and Return Loss:** These parameters are measured with the dipole positioned under the liquid filled phantom. The impedance stated is transformed from the measurement at the SMA connector to the feed point. The Return Loss ensures low reflected power. No uncertainty required.
- Electrical Delay:** One-way delay between the SMA connector and the antenna feed point. No uncertainty required.
- SAR measured:** SAR measured at the stated antenna input power.
- SAR normalized:** SAR as measured, normalized to an input power of 1 W at the antenna connector.
- SAR for nominal TSL parameters:** The measured TSL parameters are used to calculate the nominal SAR result.

The reported uncertainty of measurement is stated as the standard uncertainty of measurement multiplied by the coverage factor $k=2$, which for a normal distribution corresponds to a coverage probability of approximately 95%.

Measurement Conditions

DASY system configuration, as far as not given on page 1.

| | | |
|-------------------------------------|------------------------|-------------|
| DASY Version | DASY5 | V52.10.3 |
| Extrapolation | Advanced Extrapolation | |
| Phantom | Modular Flat Phantom | |
| Distance Dipole Center - TSL | 10 mm | with Spacer |
| Zoom Scan Resolution | dx, dy, dz = 5 mm | |
| Frequency | 2300 MHz \pm 1 MHz | |

Head TSL parameters

The following parameters and calculations were applied.

| | Temperature | Permittivity | Conductivity |
|------------------------------------------------|---------------------|---------------------|----------------------|
| Nominal Head TSL parameters | 22.0 °C | 39.5 | 1.67 mho/m |
| Measured Head TSL parameters | (22.0 \pm 0.2) °C | 39.4 \pm 6 % | 1.70 mho/m \pm 6 % |
| Head TSL temperature change during test | < 0.5 °C | ---- | ---- |

SAR result with Head TSL

| SAR averaged over 1 cm³ (1 g) of Head TSL | Condition | |
|-------------------------------------------------------------|--------------------|------------------------------------------------|
| SAR measured | 250 mW input power | 12.1 W/kg |
| SAR for nominal Head TSL parameters | normalized to 1W | 47.9 W/kg \pm 17.0 % (k=2) |

| SAR averaged over 10 cm³ (10 g) of Head TSL | condition | |
|---------------------------------------------------------------|--------------------|------------------------------------------------|
| SAR measured | 250 mW input power | 5.79 W/kg |
| SAR for nominal Head TSL parameters | normalized to 1W | 23.0 W/kg \pm 16.5 % (k=2) |

Appendix (Additional assessments outside the scope of SCS 0108)

Antenna Parameters with Head TSL

| | |
|--------------------------------------|--------------------------------|
| Impedance, transformed to feed point | 50.1 Ω - 4.9 j Ω |
| Return Loss | - 26.3 dB |

General Antenna Parameters and Design

| | |
|----------------------------------|----------|
| Electrical Delay (one direction) | 1.163 ns |
|----------------------------------|----------|

After long term use with 100W radiated power, only a slight warming of the dipole near the feedpoint can be measured.

The dipole is made of standard semirigid coaxial cable. The center conductor of the feeding line is directly connected to the second arm of the dipole. The antenna is therefore short-circuited for DC-signals. On some of the dipoles, small end caps are added to the dipole arms in order to improve matching when loaded according to the position as explained in the "Measurement Conditions" paragraph. The SAR data are not affected by this change. The overall dipole length is still according to the Standard.

No excessive force must be applied to the dipole arms, because they might bend or the soldered connections near the feedpoint may be damaged.

Additional EUT Data

| | |
|-----------------|-------|
| Manufactured by | SPEAG |
|-----------------|-------|

DASY5 Validation Report for Head TSL

Date: 13.12.2019

Test Laboratory: SPEAG, Zurich, Switzerland

DUT: Dipole 2300 MHz; Type: D2300V2; Serial: D2300V2 - SN:1092

Communication System: UID 0 - CW; Frequency: 2300 MHz

Medium parameters used: $f = 2300$ MHz; $\sigma = 1.7$ S/m; $\epsilon_r = 39.4$; $\rho = 1000$ kg/m³

Phantom section: Flat Section

Measurement Standard: DASY5 (IEEE/IEC/ANSI C63.19-2011)

DASY52 Configuration:

- Probe: EX3DV4 - SN7349; ConvF(8.15, 8.15, 8.15) @ 2300 MHz; Calibrated: 29.05.2019
- Sensor-Surface: 1.4mm (Mechanical Surface Detection)
- Electronics: DAE4 Sn601; Calibrated: 30.04.2019
- Phantom: Flat Phantom 5.0 (front); Type: QD 000 P50 AA; Serial: 1001
- DASY52 52.10.3(1513); SEMCAD X 14.6.13(7474)

Dipole Calibration for Head Tissue/Pin=250 mW, d=10mm/Zoom Scan (7x7x7)/Cube 0:

Measurement grid: dx=5mm, dy=5mm, dz=5mm

Reference Value = 114.3 V/m; Power Drift = -0.04 dB

Peak SAR (extrapolated) = 22.9 W/kg

SAR(1 g) = 12.1 W/kg; SAR(10 g) = 5.79 W/kg

Smallest distance from peaks to all points 3 dB below = 9 mm

Ratio of SAR at M2 to SAR at M1 = 53%

Maximum value of SAR (measured) = 19.3 W/kg

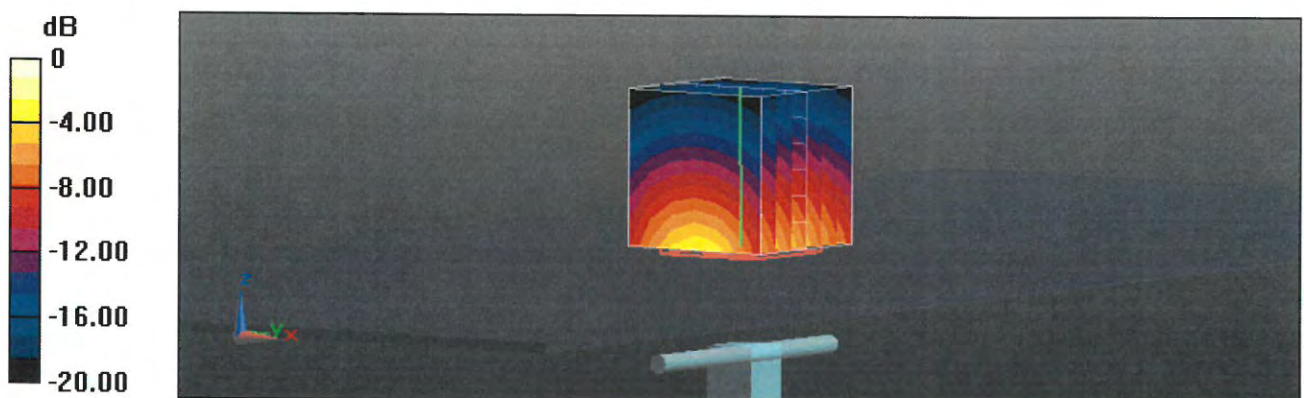

Impedance Measurement Plot for Head TSL

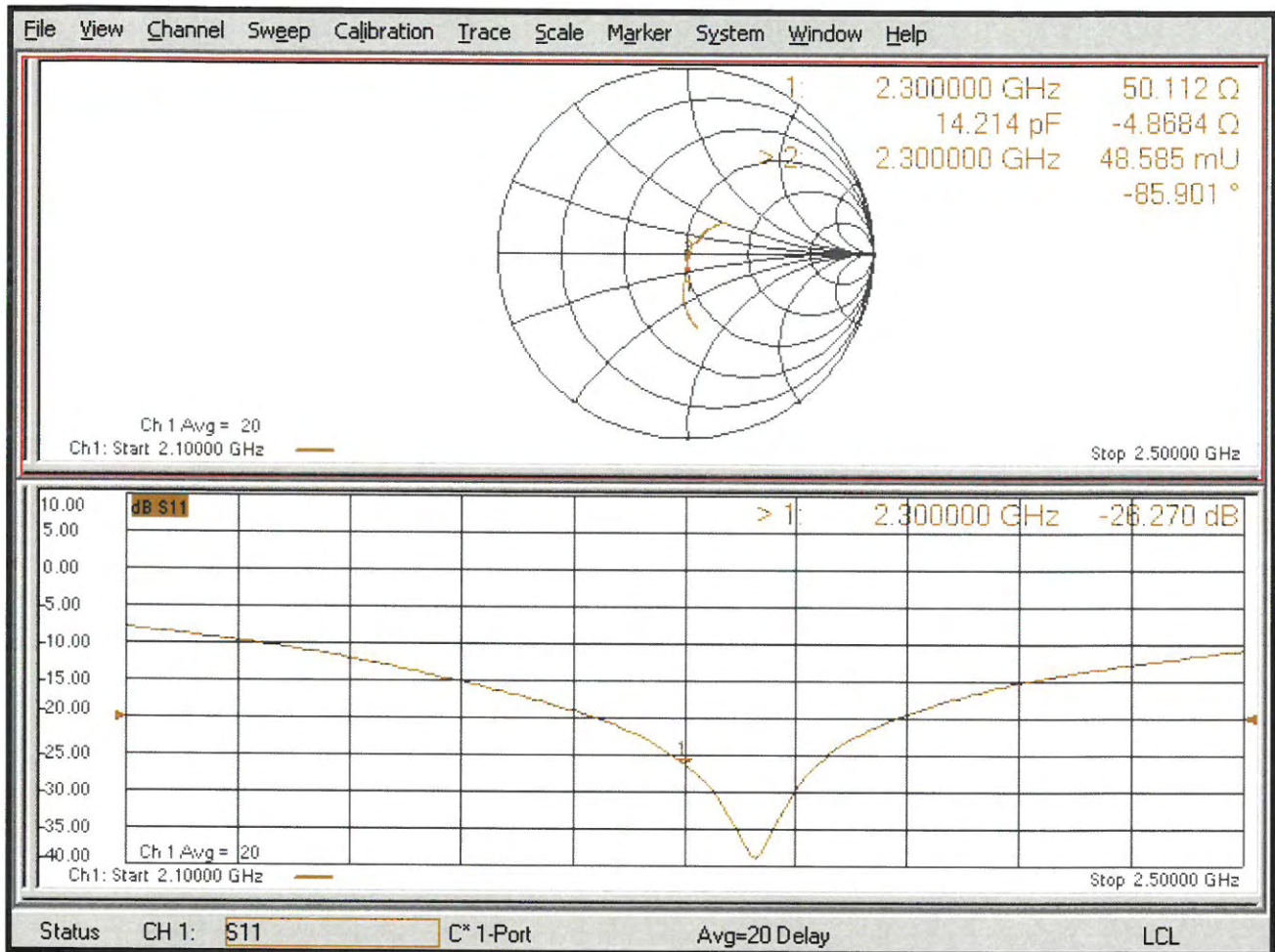



Accredited by the Swiss Accreditation Service (SAS)
The Swiss Accreditation Service is one of the signatories to the EA
Multilateral Agreement for the recognition of calibration certificates

Accreditation No.: **SCS 0108**

Client **B.V. ADT (Auden)**

Certificate No: **D2600V2-1020_Aug19**

CALIBRATION CERTIFICATE

Object **D2600V2 - SN:1020**

Calibration procedure(s) **QA CAL-05.v11
Calibration Procedure for SAR Validation Sources between 0.7-3 GHz**

Calibration date: **August 26, 2019**

This calibration certificate documents the traceability to national standards, which realize the physical units of measurements (SI).
The measurements and the uncertainties with confidence probability are given on the following pages and are part of the certificate.

All calibrations have been conducted in the closed laboratory facility: environment temperature (22 ± 3)°C and humidity < 70%.

Calibration Equipment used (M&TE critical for calibration)

| Primary Standards | ID # | Cal Date (Certificate No.) | Scheduled Calibration |
|-----------------------------|--------------------|---------------------------------|-----------------------|
| Power meter NRP | SN: 104778 | 03-Apr-19 (No. 217-02892/02893) | Apr-20 |
| Power sensor NRP-Z91 | SN: 103244 | 03-Apr-19 (No. 217-02892) | Apr-20 |
| Power sensor NRP-Z91 | SN: 103245 | 03-Apr-19 (No. 217-02893) | Apr-20 |
| Reference 20 dB Attenuator | SN: 5058 (20k) | 04-Apr-19 (No. 217-02894) | Apr-20 |
| Type-N mismatch combination | SN: 5047.2 / 06327 | 04-Apr-19 (No. 217-02895) | Apr-20 |
| Reference Probe EX3DV4 | SN: 7349 | 29-May-19 (No. EX3-7349_May19) | May-20 |
| DAE4 | SN: 601 | 30-Apr-19 (No. DAE4-601_Apr19) | Apr-20 |

| Secondary Standards | ID # | Check Date (in house) | Scheduled Check |
|---------------------------------|----------------|-----------------------------------|------------------------|
| Power meter E4419B | SN: GB39512475 | 30-Oct-14 (in house check Feb-19) | In house check: Oct-20 |
| Power sensor HP 8481A | SN: US37292783 | 07-Oct-15 (in house check Oct-18) | In house check: Oct-20 |
| Power sensor HP 8481A | SN: MY41092317 | 07-Oct-15 (in house check Oct-18) | In house check: Oct-20 |
| RF generator R&S SMT-06 | SN: 100972 | 15-Jun-15 (in house check Oct-18) | In house check: Oct-20 |
| Network Analyzer Agilent E8358A | SN: US41080477 | 31-Mar-14 (in house check Oct-18) | In house check: Oct-19 |

| | | | |
|----------------|------------------------------|------------------------------------------|---------------|
| Calibrated by: | Name Michael Weber | Function Laboratory Technician | Signature |
| Approved by: | Name Katja Pokovic | Technical Manager | |

Issued: August 26, 2019

This calibration certificate shall not be reproduced except in full without written approval of the laboratory.



Accredited by the Swiss Accreditation Service (SAS)

Accreditation No.: **SCS 0108**

The Swiss Accreditation Service is one of the signatories to the EA
Multilateral Agreement for the recognition of calibration certificates

Glossary:

| | |
|-------|---------------------------------|
| TSL | tissue simulating liquid |
| ConvF | sensitivity in TSL / NORM x,y,z |
| N/A | not applicable or not measured |

Calibration is Performed According to the Following Standards:

- IEEE Std 1528-2013, "IEEE Recommended Practice for Determining the Peak Spatial-Averaged Specific Absorption Rate (SAR) in the Human Head from Wireless Communications Devices: Measurement Techniques", June 2013
- IEC 62209-1, "Measurement procedure for the assessment of Specific Absorption Rate (SAR) from hand-held and body-mounted devices used next to the ear (frequency range of 300 MHz to 6 GHz)", July 2016
- IEC 62209-2, "Procedure to determine the Specific Absorption Rate (SAR) for wireless communication devices used in close proximity to the human body (frequency range of 30 MHz to 6 GHz)", March 2010
- KDB 865664, "SAR Measurement Requirements for 100 MHz to 6 GHz"

Additional Documentation:

- DASY4/5 System Handbook

Methods Applied and Interpretation of Parameters:

- Measurement Conditions:** Further details are available from the Validation Report at the end of the certificate. All figures stated in the certificate are valid at the frequency indicated.
- Antenna Parameters with TSL:** The dipole is mounted with the spacer to position its feed point exactly below the center marking of the flat phantom section, with the arms oriented parallel to the body axis.
- Feed Point Impedance and Return Loss:** These parameters are measured with the dipole positioned under the liquid filled phantom. The impedance stated is transformed from the measurement at the SMA connector to the feed point. The Return Loss ensures low reflected power. No uncertainty required.
- Electrical Delay:** One-way delay between the SMA connector and the antenna feed point. No uncertainty required.
- SAR measured:** SAR measured at the stated antenna input power.
- SAR normalized:** SAR as measured, normalized to an input power of 1 W at the antenna connector.
- SAR for nominal TSL parameters:** The measured TSL parameters are used to calculate the nominal SAR result.

The reported uncertainty of measurement is stated as the standard uncertainty of measurement multiplied by the coverage factor $k=2$, which for a normal distribution corresponds to a coverage probability of approximately 95%.

Measurement Conditions

DASY system configuration, as far as not given on page 1.

| | | |
|-------------------------------------|------------------------|-------------|
| DASY Version | DASY5 | V52.10.2 |
| Extrapolation | Advanced Extrapolation | |
| Phantom | Modular Flat Phantom | |
| Distance Dipole Center - TSL | 10 mm | with Spacer |
| Zoom Scan Resolution | dx, dy, dz = 5 mm | |
| Frequency | 2600 MHz ± 1 MHz | |

Head TSL parameters

The following parameters and calculations were applied.

| | Temperature | Permittivity | Conductivity |
|------------------------------------------------|-----------------|--------------|------------------|
| Nominal Head TSL parameters | 22.0 °C | 39.0 | 1.96 mho/m |
| Measured Head TSL parameters | (22.0 ± 0.2) °C | 37.3 ± 6 % | 2.00 mho/m ± 6 % |
| Head TSL temperature change during test | < 0.5 °C | ---- | ---- |

SAR result with Head TSL

| SAR averaged over 1 cm³ (1 g) of Head TSL | Condition | |
|-------------------------------------------------------------|--------------------|---------------------------------|
| SAR measured | 250 mW input power | 14.6 W/kg |
| SAR for nominal Head TSL parameters | normalized to 1W | 57.3 W/kg ± 17.0 % (k=2) |

| SAR averaged over 10 cm³ (10 g) of Head TSL | condition | |
|---------------------------------------------------------------|--------------------|---------------------------------|
| SAR measured | 250 mW input power | 6.48 W/kg |
| SAR for nominal Head TSL parameters | normalized to 1W | 25.6 W/kg ± 16.5 % (k=2) |

Appendix (Additional assessments outside the scope of SCS 0108)

Antenna Parameters with Head TSL

| | |
|--------------------------------------|--------------------------------|
| Impedance, transformed to feed point | 47.6 Ω - 5.8 j Ω |
| Return Loss | - 23.8 dB |

General Antenna Parameters and Design

| | |
|----------------------------------|----------|
| Electrical Delay (one direction) | 1.154 ns |
|----------------------------------|----------|

After long term use with 100W radiated power, only a slight warming of the dipole near the feedpoint can be measured.

The dipole is made of standard semirigid coaxial cable. The center conductor of the feeding line is directly connected to the second arm of the dipole. The antenna is therefore short-circuited for DC-signals. On some of the dipoles, small end caps are added to the dipole arms in order to improve matching when loaded according to the position as explained in the "Measurement Conditions" paragraph. The SAR data are not affected by this change. The overall dipole length is still according to the Standard.

No excessive force must be applied to the dipole arms, because they might bend or the soldered connections near the feedpoint may be damaged.

Additional EUT Data

| | |
|-----------------|-------|
| Manufactured by | SPEAG |
|-----------------|-------|

DASY5 Validation Report for Head TSL

Date: 26.08.2019

Test Laboratory: SPEAG, Zurich, Switzerland

DUT: Dipole 2600 MHz; Type: D2600V2; Serial: D2600V2 - SN:1020

Communication System: UID 0 - CW; Frequency: 2600 MHz

Medium parameters used: $f = 2600$ MHz; $\sigma = 2$ S/m; $\epsilon_r = 37.3$; $\rho = 1000$ kg/m³

Phantom section: Flat Section

Measurement Standard: DASY5 (IEEE/IEC/ANSI C63.19-2011)

DASY52 Configuration:

- Probe: EX3DV4 - SN7349; ConvF(7.69, 7.69, 7.69) @ 2600 MHz; Calibrated: 29.05.2019
- Sensor-Surface: 1.4mm (Mechanical Surface Detection)
- Electronics: DAE4 Sn601; Calibrated: 30.04.2019
- Phantom: Flat Phantom 5.0 (front); Type: QD 000 P50 AA; Serial: 1001
- DASY52 52.10.2(1504); SEMCAD X 14.6.12(7470)

Dipole Calibration for Head Tissue/Pin=250 mW, d=10mm/Zoom Scan (7x7x7)/Cube 0:

Measurement grid: dx=5mm, dy=5mm, dz=5mm

Reference Value = 121.0 V/m; Power Drift = -0.01 dB

Peak SAR (extrapolated) = 29.5 W/kg

SAR(1 g) = 14.6 W/kg; SAR(10 g) = 6.48 W/kg

Maximum value of SAR (measured) = 24.5 W/kg



0 dB = 24.5 W/kg = 13.89 dBW/kg

Impedance Measurement Plot for Head TSL

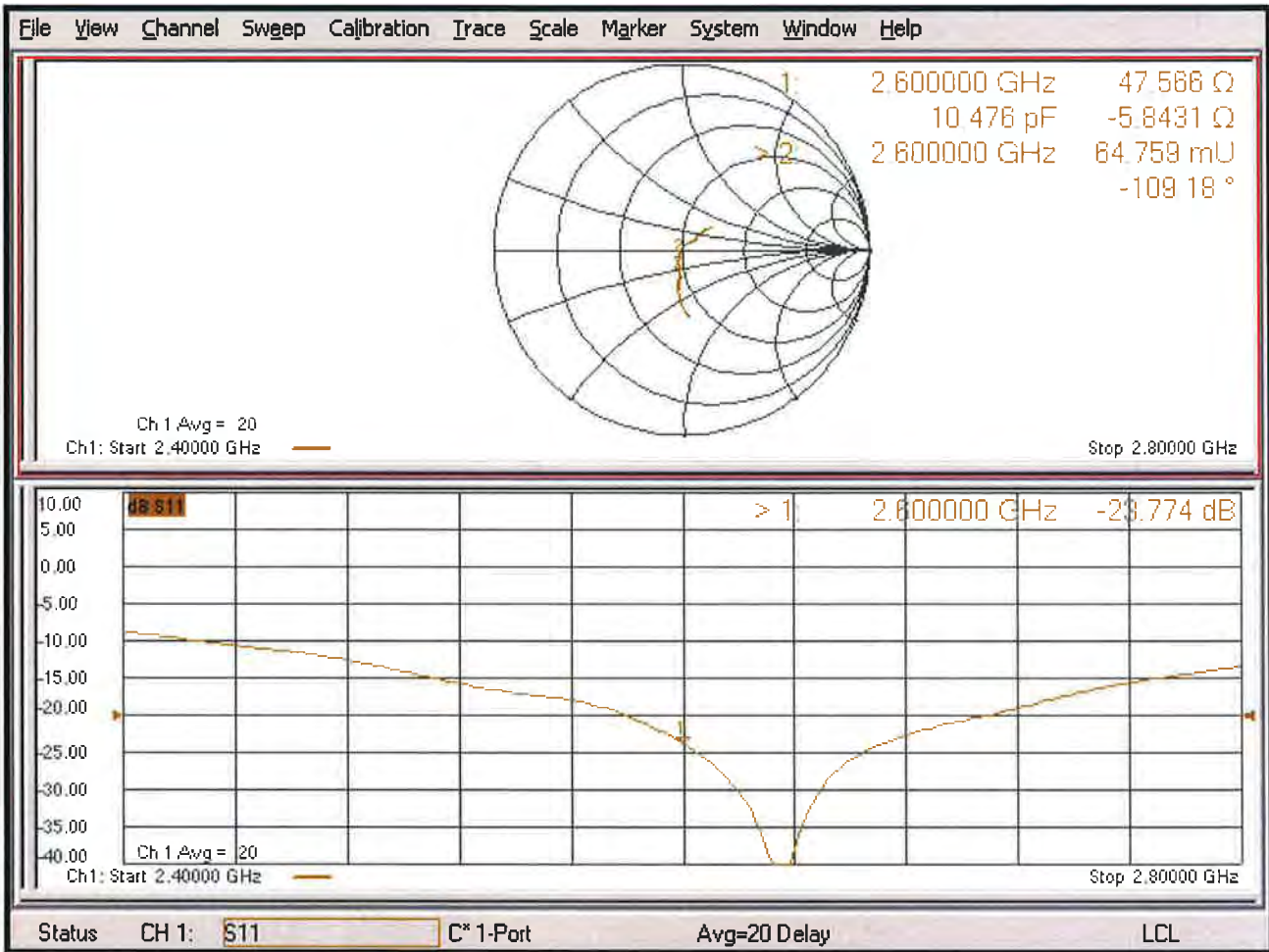



Accredited by the Swiss Accreditation Service (SAS)
The Swiss Accreditation Service is one of the signatories to the EA
Multilateral Agreement for the recognition of calibration certificates

Accreditation No.: **SCS 0108**

Client **BV ADT (Auden)**

Certificate No: **EX3-3650_May19**

CALIBRATION CERTIFICATE

Object **EX3DV4 - SN:3650**

Calibration procedure(s) **QA CAL-01.v9, QA CAL-14.v5, QA CAL-23.v5, QA CAL-25.v7
Calibration procedure for dosimetric E-field probes**

Calibration date: **May 20, 2019**

This calibration certificate documents the traceability to national standards, which realize the physical units of measurements (SI).
The measurements and the uncertainties with confidence probability are given on the following pages and are part of the certificate.

All calibrations have been conducted in the closed laboratory facility: environment temperature (22 ± 3)°C and humidity < 70%.

Calibration Equipment used (M&TE critical for calibration)

| Primary Standards | ID | Cal Date (Certificate No.) | Scheduled Calibration |
|----------------------------|------------------|-----------------------------------|------------------------|
| Power meter NRP | SN: 104778 | 03-Apr-19 (No. 217-02892/02893) | Apr-20 |
| Power sensor NRP-Z91 | SN: 103244 | 03-Apr-19 (No. 217-02892) | Apr-20 |
| Power sensor NRP-Z91 | SN: 103245 | 03-Apr-19 (No. 217-02893) | Apr-20 |
| Reference 20 dB Attenuator | SN: S5277 (20x) | 04-Apr-19 (No. 217-02894) | Apr-20 |
| DAE4 | SN: 660 | 19-Dec-18 (No. DAE4-660_Dec18) | Dec-19 |
| Reference Probe ES3DV2 | SN: 3013 | 31-Dec-18 (No. ES3-3013_Dec18) | Dec-19 |
| | | | |
| Secondary Standards | ID | Check Date (in house) | Scheduled Check |
| Power meter E4419B | SN: GB41293874 | 06-Apr-16 (in house check Jun-18) | In house check: Jun-20 |
| Power sensor E4412A | SN: MY41498087 | 06-Apr-16 (in house check Jun-18) | In house check: Jun-20 |
| Power sensor E4412A | SN: 000110210 | 06-Apr-16 (in house check Jun-18) | In house check: Jun-20 |
| RF generator HP 8648C | SN: US3642U01700 | 04-Aug-99 (in house check Jun-18) | In house check: Jun-20 |
| Network Analyzer E8358A | SN: US41080477 | 31-Mar-14 (in house check Oct-18) | In house check: Oct-19 |

| | Name | Function | Signature |
|-----------------------------------------------------------------------------------------------------------------|-----------------------|------------------------------|----------------------|
| Calibrated by: | Jeton Kastrati | Laboratory Technician | |
| Approved by: | Katja Pokovic | Technical Manager | |
| | | | Issued: May 20, 2019 |
| This calibration certificate shall not be reproduced except in full without written approval of the laboratory. | | | |



Accredited by the Swiss Accreditation Service (SAS)

Accreditation No.: **SCS 0108**

The Swiss Accreditation Service is one of the signatories to the EA
Multilateral Agreement for the recognition of calibration certificates

Glossary:

| | |
|--------------------------|---------------------------------------------------------------------------------------------------------------------------------------------------------|
| TSL | tissue simulating liquid |
| NORM _{x,y,z} | sensitivity in free space |
| ConvF | sensitivity in TSL / NORM _{x,y,z} |
| DCP | diode compression point |
| CF | crest factor (1/duty_cycle) of the RF signal |
| A, B, C, D | modulation dependent linearization parameters |
| Polarization φ | φ rotation around probe axis |
| Polarization ϑ | ϑ rotation around an axis that is in the plane normal to probe axis (at measurement center), i.e., $\vartheta = 0$ is normal to probe axis |
| Connector Angle | information used in DASY system to align probe sensor X to the robot coordinate system |

Calibration is Performed According to the Following Standards:

- IEEE Std 1528-2013, "IEEE Recommended Practice for Determining the Peak Spatial-Averaged Specific Absorption Rate (SAR) in the Human Head from Wireless Communications Devices: Measurement Techniques", June 2013
- IEC 62209-1, "Measurement procedure for the assessment of Specific Absorption Rate (SAR) from hand-held and body-mounted devices used next to the ear (frequency range of 300 MHz to 6 GHz)", July 2016
- IEC 62209-2, "Procedure to determine the Specific Absorption Rate (SAR) for wireless communication devices used in close proximity to the human body (frequency range of 30 MHz to 6 GHz)", March 2010
- KDB 865664, "SAR Measurement Requirements for 100 MHz to 6 GHz"

Methods Applied and Interpretation of Parameters:

- NORM_{x,y,z}**: Assessed for E-field polarization $\vartheta = 0$ ($f \leq 900$ MHz in TEM-cell; $f > 1800$ MHz: R22 waveguide). NORM_{x,y,z} are only intermediate values, i.e., the uncertainties of NORM_{x,y,z} does not affect the E²-field uncertainty inside TSL (see below ConvF).
- NORM(f)_{x,y,z} = NORM_{x,y,z} * frequency_response** (see Frequency Response Chart). This linearization is implemented in DASY4 software versions later than 4.2. The uncertainty of the frequency response is included in the stated uncertainty of ConvF.
- DCP_{x,y,z}**: DCP are numerical linearization parameters assessed based on the data of power sweep with CW signal (no uncertainty required). DCP does not depend on frequency nor media.
- PAR**: PAR is the Peak to Average Ratio that is not calibrated but determined based on the signal characteristics
- A_{x,y,z}; B_{x,y,z}; C_{x,y,z}; D_{x,y,z}; VR_{x,y,z}; A, B, C, D** are numerical linearization parameters assessed based on the data of power sweep for specific modulation signal. The parameters do not depend on frequency nor media. VR is the maximum calibration range expressed in RMS voltage across the diode.
- ConvF and Boundary Effect Parameters**: Assessed in flat phantom using E-field (or Temperature Transfer Standard for $f \leq 800$ MHz) and inside waveguide using analytical field distributions based on power measurements for $f > 800$ MHz. The same setups are used for assessment of the parameters applied for boundary compensation (alpha, depth) of which typical uncertainty values are given. These parameters are used in DASY4 software to improve probe accuracy close to the boundary. The sensitivity in TSL corresponds to NORM_{x,y,z} * ConvF whereby the uncertainty corresponds to that given for ConvF. A frequency dependent ConvF is used in DASY version 4.4 and higher which allows extending the validity from ± 50 MHz to ± 100 MHz.
- Spherical isotropy (3D deviation from isotropy)**: in a field of low gradients realized using a flat phantom exposed by a patch antenna.
- Sensor Offset**: The sensor offset corresponds to the offset of virtual measurement center from the probe tip (on probe axis). No tolerance required.
- Connector Angle**: The angle is assessed using the information gained by determining the NORM_x (no uncertainty required).

DASY/EASY - Parameters of Probe: EX3DV4 - SN:3650

Basic Calibration Parameters

| | Sensor X | Sensor Y | Sensor Z | Unc (k=2) |
|-----------------------------------------------------------|----------|----------|----------|-----------|
| Norm ($\mu\text{V}/(\text{V}/\text{m})^2$) ^A | 0.40 | 0.40 | 0.41 | ± 10.1 % |
| DCP (mV) ^B | 105.4 | 99.2 | 105.9 | |

Calibration Results for Modulation Response

| UID | Communication System Name | | A dB | B dB $\sqrt{\mu\text{V}}$ | C | D dB | VR mV | Max dev. | Max Unc ^E (k=2) |
|---------------|-----------------------------|---|---------|------------------------------|-------|---------|----------|-------------|----------------------------------|
| 0 | CW | X | 0.00 | 0.00 | 1.00 | 0.00 | 169.3 | ± 3.3 % | ± 4.7 % |
| | | Y | 0.00 | 0.00 | 1.00 | | 155.5 | | |
| | | Z | 0.00 | 0.00 | 1.00 | | 169.9 | | |
| 10352- AAA | Pulse Waveform (200Hz, 10%) | X | 5.52 | 73.99 | 14.03 | 10.00 | 60.0 | ± 2.9 % | ± 9.6 % |
| | | Y | 12.59 | 82.85 | 17.90 | | 60.0 | | |
| | | Z | 15.00 | 88.44 | 20.60 | | 60.0 | | |
| 10353- AAA | Pulse Waveform (200Hz, 20%) | X | 15.00 | 85.13 | 16.40 | 6.99 | 80.0 | ± 2.1 % | ± 9.6 % |
| | | Y | 15.00 | 85.80 | 17.44 | | 80.0 | | |
| | | Z | 15.00 | 89.95 | 20.10 | | 80.0 | | |
| 10354- AAA | Pulse Waveform (200Hz, 40%) | X | 15.00 | 90.82 | 17.69 | 3.98 | 95.0 | ± 1.2 % | ± 9.6 % |
| | | Y | 15.00 | 84.35 | 14.90 | | 95.0 | | |
| | | Z | 15.00 | 96.80 | 22.00 | | 95.0 | | |
| 10355- AAA | Pulse Waveform (200Hz, 60%) | X | 15.00 | 125.07 | 31.80 | 2.22 | 120.0 | ± 1.3 % | ± 9.6 % |
| | | Y | 0.40 | 60.68 | 5.28 | | 120.0 | | |
| | | Z | 15.00 | 108.39 | 25.98 | | 120.0 | | |
| 10387- AAA | QPSK Waveform, 1 MHz | X | 0.40 | 60.00 | 5.50 | 0.00 | 150.0 | ± 3.1 % | ± 9.6 % |
| | | Y | 0.62 | 60.97 | 8.03 | | 150.0 | | |
| | | Z | 1.18 | 68.04 | 13.15 | | 150.0 | | |
| 10388- AAA | QPSK Waveform, 10 MHz | X | 2.67 | 73.57 | 18.93 | 0.00 | 150.0 | ± 1.0 % | ± 9.6 % |
| | | Y | 2.27 | 68.77 | 16.00 | | 150.0 | | |
| | | Z | 2.67 | 71.48 | 17.65 | | 150.0 | | |
| 10396- AAA | 64-QAM Waveform, 100 kHz | X | 2.53 | 70.36 | 19.21 | 3.01 | 150.0 | ± 0.9 % | ± 9.6 % |
| | | Y | 3.20 | 71.37 | 19.39 | | 150.0 | | |
| | | Z | 3.76 | 74.72 | 20.75 | | 150.0 | | |
| 10399- AAA | 64-QAM Waveform, 40 MHz | X | 3.60 | 68.84 | 16.97 | 0.00 | 150.0 | ± 2.3 % | ± 9.6 % |
| | | Y | 3.55 | 67.48 | 16.02 | | 150.0 | | |
| | | Z | 3.72 | 68.39 | 16.62 | | 150.0 | | |
| 10414- AAA | WLAN CCDF, 64-QAM, 40MHz | X | 4.71 | 66.59 | 16.23 | 0.00 | 150.0 | ± 4.3 % | ± 9.6 % |
| | | Y | 4.96 | 65.99 | 15.86 | | 150.0 | | |
| | | Z | 5.01 | 66.21 | 15.98 | | 150.0 | | |

Note: For details on UID parameters see Appendix

The reported uncertainty of measurement is stated as the standard uncertainty of measurement multiplied by the coverage factor k=2, which for a normal distribution corresponds to a coverage probability of approximately 95%.

^A The uncertainties of Norm X,Y,Z do not affect the E²-field uncertainty inside TSL (see Page 5).

^B Numerical linearization parameter: uncertainty not required.

^E Uncertainty is determined using the max. deviation from linear response applying rectangular distribution and is expressed for the square of the field value.

DASY/EASY - Parameters of Probe: EX3DV4 - SN:3650

Sensor Model Parameters

| | C1 fF | C2 fF | α V ⁻¹ | T1 ms.V ⁻² | T2 ms.V ⁻¹ | T3 ms | T4 V ⁻² | T5 V ⁻¹ | T6 |
|---|----------|----------|-----------------------------|--------------------------|--------------------------|----------|-----------------------|-----------------------|------|
| X | 28.0 | 203.57 | 34.24 | 7.40 | 0.27 | 5.01 | 0.72 | 0.18 | 1.00 |
| Y | 47.3 | 370.03 | 38.58 | 9.66 | 0.85 | 5.06 | 0.00 | 0.62 | 1.01 |
| Z | 49.8 | 370.45 | 35.51 | 13.89 | 0.57 | 5.06 | 1.46 | 0.32 | 1.01 |

Other Probe Parameters

| | |
|-----------------------------------------------|------------|
| Sensor Arrangement | Triangular |
| Connector Angle (°) | -21.6 |
| Mechanical Surface Detection Mode | enabled |
| Optical Surface Detection Mode | disabled |
| Probe Overall Length | 337 mm |
| Probe Body Diameter | 10 mm |
| Tip Length | 9 mm |
| Tip Diameter | 2.5 mm |
| Probe Tip to Sensor X Calibration Point | 1 mm |
| Probe Tip to Sensor Y Calibration Point | 1 mm |
| Probe Tip to Sensor Z Calibration Point | 1 mm |
| Recommended Measurement Distance from Surface | 1.4 mm |

DASY/EASY - Parameters of Probe: EX3DV4 - SN:3650

Calibration Parameter Determined in Head Tissue Simulating Media

| f (MHz) ^C | Relative Permittivity ^F | Conductivity (S/m) ^F | ConvF X | ConvF Y | ConvF Z | Alpha ^G | Depth (mm) ^G | Unc (k=2) |
|----------------------|------------------------------------|---------------------------------|---------|---------|---------|--------------------|-------------------------|-----------|
| 750 | 41.9 | 0.89 | 10.06 | 10.06 | 10.06 | 0.48 | 0.87 | ± 12.0 % |
| 835 | 41.5 | 0.90 | 9.82 | 9.82 | 9.82 | 0.55 | 0.80 | ± 12.0 % |
| 900 | 41.5 | 0.97 | 9.61 | 9.61 | 9.61 | 0.49 | 0.85 | ± 12.0 % |
| 1450 | 40.5 | 1.20 | 8.91 | 8.91 | 8.91 | 0.41 | 0.80 | ± 12.0 % |
| 1750 | 40.1 | 1.37 | 8.44 | 8.44 | 8.44 | 0.38 | 0.85 | ± 12.0 % |
| 1900 | 40.0 | 1.40 | 8.25 | 8.25 | 8.25 | 0.33 | 0.85 | ± 12.0 % |
| 2000 | 40.0 | 1.40 | 8.17 | 8.17 | 8.17 | 0.38 | 0.84 | ± 12.0 % |
| 2300 | 39.5 | 1.67 | 8.00 | 8.00 | 8.00 | 0.30 | 0.84 | ± 12.0 % |
| 2450 | 39.2 | 1.80 | 7.63 | 7.63 | 7.63 | 0.38 | 0.87 | ± 12.0 % |
| 2600 | 39.0 | 1.96 | 7.50 | 7.50 | 7.50 | 0.44 | 0.86 | ± 12.0 % |
| 3300 | 38.2 | 2.71 | 7.16 | 7.16 | 7.16 | 0.32 | 1.20 | ± 13.1 % |
| 3500 | 37.9 | 2.91 | 6.93 | 6.93 | 6.93 | 0.30 | 1.25 | ± 13.1 % |
| 3700 | 37.7 | 3.12 | 6.71 | 6.71 | 6.71 | 0.35 | 1.25 | ± 13.1 % |
| 3900 | 37.5 | 3.32 | 6.50 | 6.50 | 6.50 | 0.30 | 1.60 | ± 13.1 % |
| 4100 | 37.2 | 3.53 | 6.30 | 6.30 | 6.30 | 0.40 | 1.60 | ± 13.1 % |
| 4200 | 37.1 | 3.63 | 6.16 | 6.16 | 6.16 | 0.40 | 1.60 | ± 13.1 % |
| 4400 | 36.9 | 3.84 | 6.13 | 6.13 | 6.13 | 0.40 | 1.70 | ± 13.1 % |
| 4600 | 36.7 | 4.04 | 6.11 | 6.11 | 6.11 | 0.45 | 1.80 | ± 13.1 % |
| 4800 | 36.4 | 4.25 | 6.08 | 6.08 | 6.08 | 0.45 | 1.80 | ± 13.1 % |
| 4950 | 36.3 | 4.40 | 5.79 | 5.79 | 5.79 | 0.45 | 1.80 | ± 13.1 % |
| 5250 | 35.9 | 4.71 | 5.40 | 5.40 | 5.40 | 0.40 | 1.80 | ± 13.1 % |
| 5600 | 35.5 | 5.07 | 4.90 | 4.90 | 4.90 | 0.40 | 1.80 | ± 13.1 % |
| 5750 | 35.4 | 5.22 | 5.17 | 5.17 | 5.17 | 0.40 | 1.80 | ± 13.1 % |

^C Frequency validity above 300 MHz of ± 100 MHz only applies for DASY v4.4 and higher (see Page 2), else it is restricted to ± 50 MHz. The uncertainty is the RSS of the ConvF uncertainty at calibration frequency and the uncertainty for the indicated frequency band. Frequency validity below 300 MHz is ± 10, 25, 40, 50 and 70 MHz for ConvF assessments at 30, 64, 128, 150 and 220 MHz respectively. Validity of ConvF assessed at 6 MHz is 4-9 MHz, and ConvF assessed at 13 MHz is 9-19 MHz. Above 5 GHz frequency validity can be extended to ± 110 MHz.

^F At frequencies below 3 GHz, the validity of tissue parameters (ϵ and σ) can be relaxed to ± 10% if liquid compensation formula is applied to measured SAR values. At frequencies above 3 GHz, the validity of tissue parameters (ϵ and σ) is restricted to ± 5%. The uncertainty is the RSS of the ConvF uncertainty for indicated target tissue parameters.

^G Alpha/Depth are determined during calibration. SPEAG warrants that the remaining deviation due to the boundary effect after compensation is always less than ± 1% for frequencies below 3 GHz and below ± 2% for frequencies between 3-6 GHz at any distance larger than half the probe tip diameter from the boundary.

Frequency Response of E-Field (TEM-Cell:ifi110 EXX, Waveguide: R22)

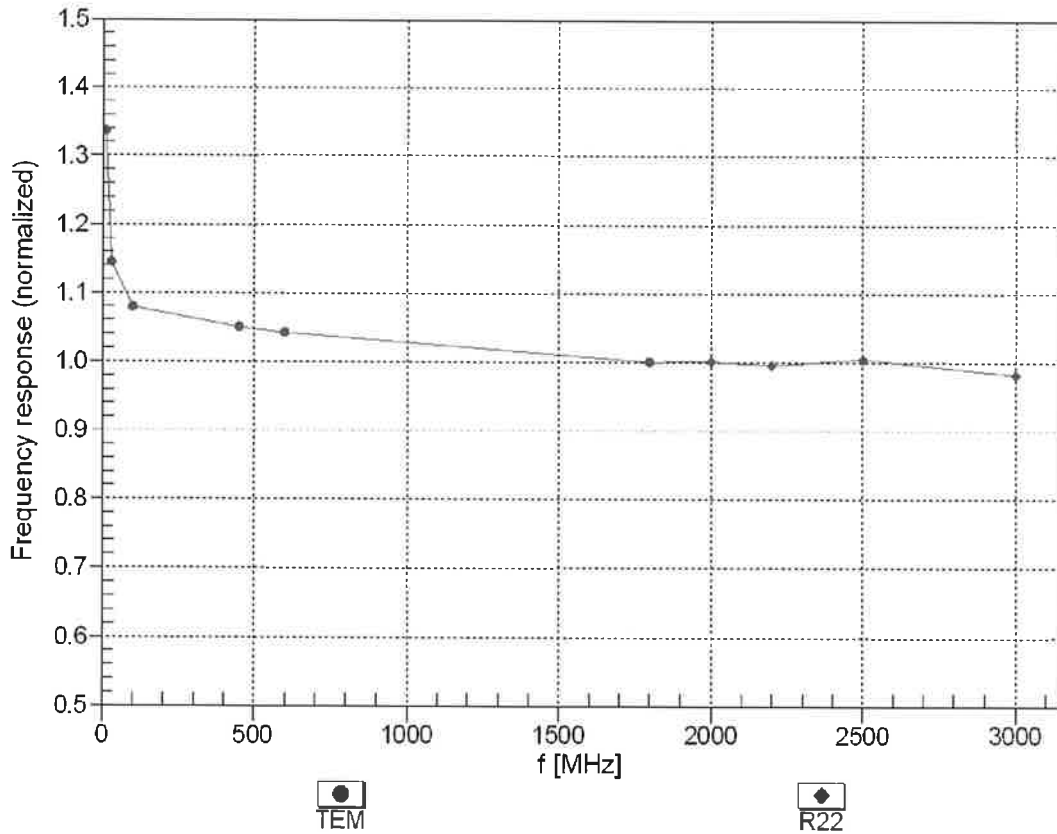

Uncertainty of Frequency Response of E-field: $\pm 6.3\%$ (k=2)

Receiving Pattern (ϕ), $\theta = 0^\circ$

f=600 MHz,TEM

f=1800 MHz,R22

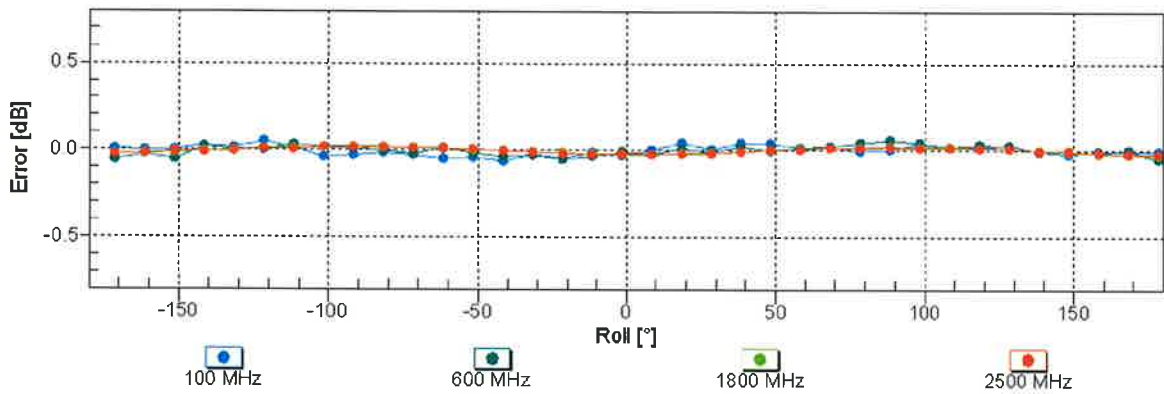
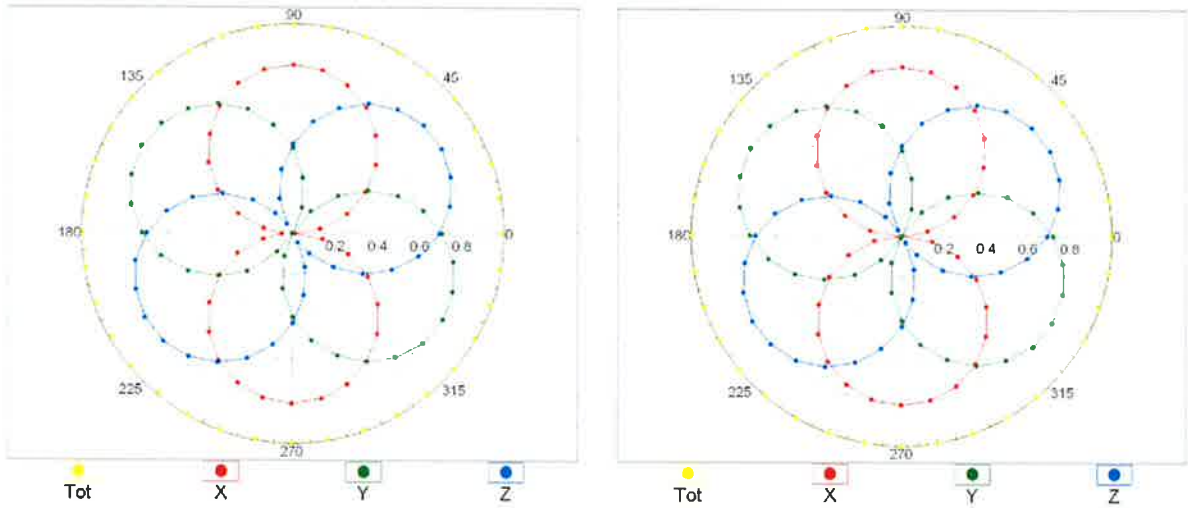

Uncertainty of Axial Isotropy Assessment: $\pm 0.5\%$ (k=2)

Dynamic Range $f(\text{SAR}_{\text{head}})$ (TEM cell , $f_{\text{eval}}= 1900 \text{ MHz}$)

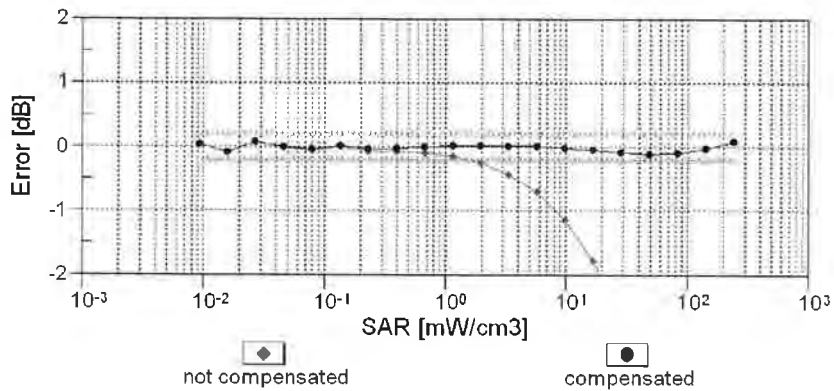
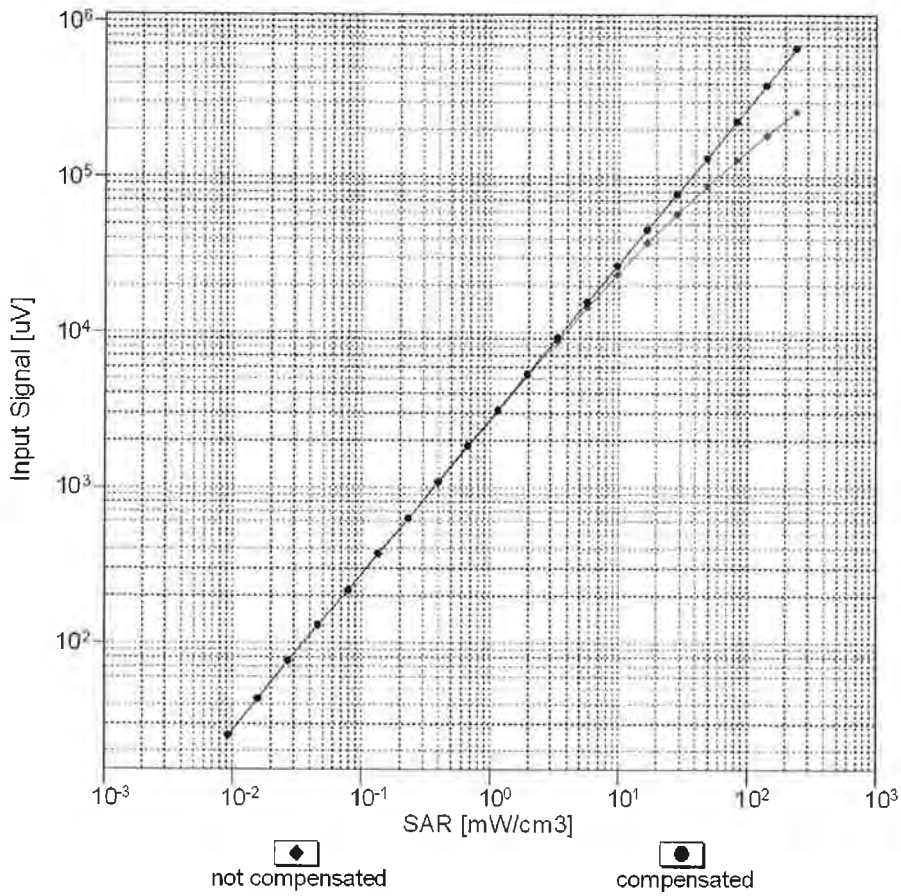

Uncertainty of Linearity Assessment: $\pm 0.6\%$ ($k=2$)

Conversion Factor Assessment

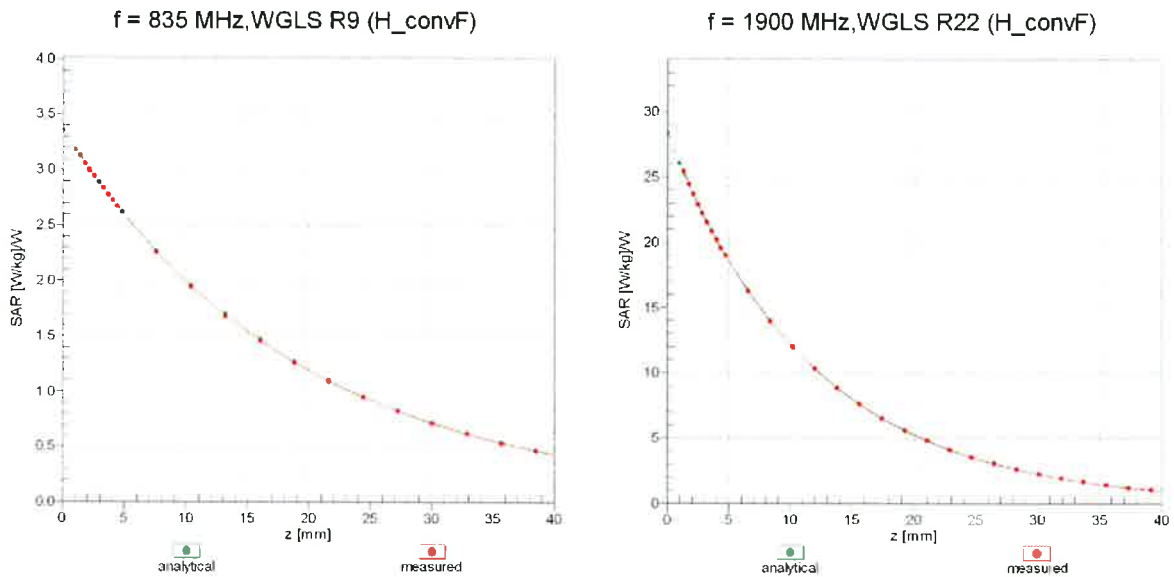

Deviation from Isotropy in Liquid

Error (ϕ, ϑ), f = 900 MHz

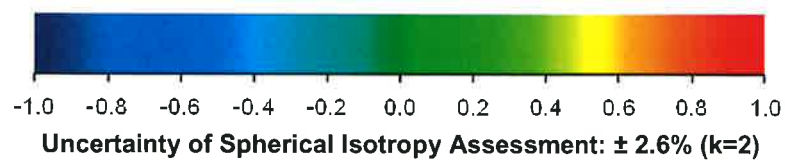
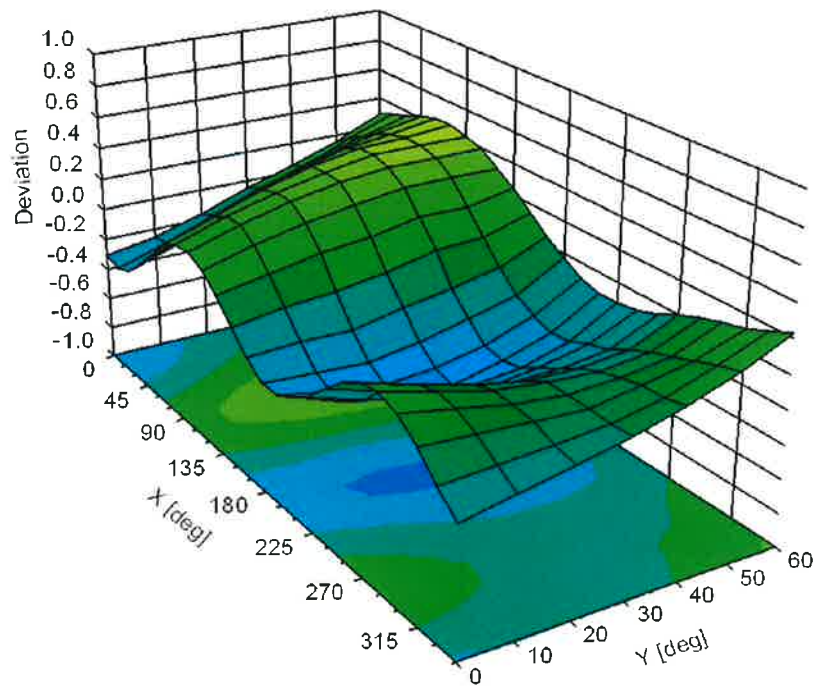

Appendix: Modulation Calibration Parameters

| UID | Rev | Communication System Name | Group | PAR (dB) | Unc ^E (k=2) |
|-------|-----|-----------------------------------------------------|-----------|----------|------------------------|
| 0 | | CW | CW | 0.00 | ± 4.7 % |
| 10010 | CAA | SAR Validation (Square, 100ms, 10ms) | Test | 10.00 | ± 9.6 % |
| 10011 | CAB | UMTS-FDD (WCDMA) | WCDMA | 2.91 | ± 9.6 % |
| 10012 | CAB | IEEE 802.11b WiFi 2.4 GHz (DSSS, 1 Mbps) | WLAN | 1.87 | ± 9.6 % |
| 10013 | CAB | IEEE 802.11g WiFi 2.4 GHz (DSSS-OFDM, 6 Mbps) | WLAN | 9.46 | ± 9.6 % |
| 10021 | DAC | GSM-FDD (TDMA, GMSK) | GSM | 9.39 | ± 9.6 % |
| 10023 | DAC | GPRS-FDD (TDMA, GMSK, TN 0) | GSM | 9.57 | ± 9.6 % |
| 10024 | DAC | GPRS-FDD (TDMA, GMSK, TN 0-1) | GSM | 6.56 | ± 9.6 % |
| 10025 | DAC | EDGE-FDD (TDMA, 8PSK, TN 0) | GSM | 12.62 | ± 9.6 % |
| 10026 | DAC | EDGE-FDD (TDMA, 8PSK, TN 0-1) | GSM | 9.55 | ± 9.6 % |
| 10027 | DAC | GPRS-FDD (TDMA, GMSK, TN 0-1-2) | GSM | 4.80 | ± 9.6 % |
| 10028 | DAC | GPRS-FDD (TDMA, GMSK, TN 0-1-2-3) | GSM | 3.55 | ± 9.6 % |
| 10029 | DAC | EDGE-FDD (TDMA, 8PSK, TN 0-1-2) | GSM | 7.78 | ± 9.6 % |
| 10030 | CAA | IEEE 802.15.1 Bluetooth (GFSK, DH1) | Bluetooth | 5.30 | ± 9.6 % |
| 10031 | CAA | IEEE 802.15.1 Bluetooth (GFSK, DH3) | Bluetooth | 1.87 | ± 9.6 % |
| 10032 | CAA | IEEE 802.15.1 Bluetooth (GFSK, DH5) | Bluetooth | 1.16 | ± 9.6 % |
| 10033 | CAA | IEEE 802.15.1 Bluetooth (PI/4-DQPSK, DH1) | Bluetooth | 7.74 | ± 9.6 % |
| 10034 | CAA | IEEE 802.15.1 Bluetooth (PI/4-DQPSK, DH3) | Bluetooth | 4.53 | ± 9.6 % |
| 10035 | CAA | IEEE 802.15.1 Bluetooth (PI/4-DQPSK, DH5) | Bluetooth | 3.83 | ± 9.6 % |
| 10036 | CAA | IEEE 802.15.1 Bluetooth (8-DPSK, DH1) | Bluetooth | 8.01 | ± 9.6 % |
| 10037 | CAA | IEEE 802.15.1 Bluetooth (8-DPSK, DH3) | Bluetooth | 4.77 | ± 9.6 % |
| 10038 | CAA | IEEE 802.15.1 Bluetooth (8-DPSK, DH5) | Bluetooth | 4.10 | ± 9.6 % |
| 10039 | CAB | CDMA2000 (1xRTT, RC1) | CDMA2000 | 4.57 | ± 9.6 % |
| 10042 | CAB | IS-54 / IS-136 FDD (TDMA/FDM, PI/4-DQPSK, Halfrate) | AMPS | 7.78 | ± 9.6 % |
| 10044 | CAA | IS-91/EIA/TIA-553 FDD (FDMA, FM) | AMPS | 0.00 | ± 9.6 % |
| 10048 | CAA | DECT (TDD, TDMA/FDM, GFSK, Full Slot, 24) | DECT | 13.80 | ± 9.6 % |
| 10049 | CAA | DECT (TDD, TDMA/FDM, GFSK, Double Slot, 12) | DECT | 10.79 | ± 9.6 % |
| 10056 | CAA | UMTS-TDD (TD-SCDMA, 1.28 Mcps) | TD-SCDMA | 11.01 | ± 9.6 % |
| 10058 | DAC | EDGE-FDD (TDMA, 8PSK, TN 0-1-2-3) | GSM | 6.52 | ± 9.6 % |
| 10059 | CAB | IEEE 802.11b WiFi 2.4 GHz (DSSS, 2 Mbps) | WLAN | 2.12 | ± 9.6 % |
| 10060 | CAB | IEEE 802.11b WiFi 2.4 GHz (DSSS, 5.5 Mbps) | WLAN | 2.83 | ± 9.6 % |
| 10061 | CAB | IEEE 802.11b WiFi 2.4 GHz (DSSS, 11 Mbps) | WLAN | 3.60 | ± 9.6 % |
| 10062 | CAC | IEEE 802.11a/h WiFi 5 GHz (OFDM, 6 Mbps) | WLAN | 8.68 | ± 9.6 % |
| 10063 | CAC | IEEE 802.11a/h WiFi 5 GHz (OFDM, 9 Mbps) | WLAN | 8.63 | ± 9.6 % |
| 10064 | CAC | IEEE 802.11a/h WiFi 5 GHz (OFDM, 12 Mbps) | WLAN | 9.09 | ± 9.6 % |
| 10065 | CAC | IEEE 802.11a/h WiFi 5 GHz (OFDM, 18 Mbps) | WLAN | 9.00 | ± 9.6 % |
| 10066 | CAC | IEEE 802.11a/h WiFi 5 GHz (OFDM, 24 Mbps) | WLAN | 9.38 | ± 9.6 % |
| 10067 | CAC | IEEE 802.11a/h WiFi 5 GHz (OFDM, 36 Mbps) | WLAN | 10.12 | ± 9.6 % |
| 10068 | CAC | IEEE 802.11a/h WiFi 5 GHz (OFDM, 48 Mbps) | WLAN | 10.24 | ± 9.6 % |
| 10069 | CAC | IEEE 802.11a/h WiFi 5 GHz (OFDM, 54 Mbps) | WLAN | 10.56 | ± 9.6 % |
| 10071 | CAB | IEEE 802.11g WiFi 2.4 GHz (DSSS/OFDM, 9 Mbps) | WLAN | 9.83 | ± 9.6 % |
| 10072 | CAB | IEEE 802.11g WiFi 2.4 GHz (DSSS/OFDM, 12 Mbps) | WLAN | 9.62 | ± 9.6 % |
| 10073 | CAB | IEEE 802.11g WiFi 2.4 GHz (DSSS/OFDM, 18 Mbps) | WLAN | 9.94 | ± 9.6 % |
| 10074 | CAB | IEEE 802.11g WiFi 2.4 GHz (DSSS/OFDM, 24 Mbps) | WLAN | 10.30 | ± 9.6 % |
| 10075 | CAB | IEEE 802.11g WiFi 2.4 GHz (DSSS/OFDM, 36 Mbps) | WLAN | 10.77 | ± 9.6 % |
| 10076 | CAB | IEEE 802.11g WiFi 2.4 GHz (DSSS/OFDM, 48 Mbps) | WLAN | 10.94 | ± 9.6 % |
| 10077 | CAB | IEEE 802.11g WiFi 2.4 GHz (DSSS/OFDM, 54 Mbps) | WLAN | 11.00 | ± 9.6 % |
| 10081 | CAB | CDMA2000 (1xRTT, RC3) | CDMA2000 | 3.97 | ± 9.6 % |
| 10082 | CAB | IS-54 / IS-136 FDD (TDMA/FDM, PI/4-DQPSK, Fullrate) | AMPS | 4.77 | ± 9.6 % |
| 10090 | DAC | GPRS-FDD (TDMA, GMSK, TN 0-4) | GSM | 6.56 | ± 9.6 % |
| 10097 | CAB | UMTS-FDD (HSDPA) | WCDMA | 3.98 | ± 9.6 % |
| 10098 | CAB | UMTS-FDD (HSUPA, Subtest 2) | WCDMA | 3.98 | ± 9.6 % |
| 10099 | DAC | EDGE-FDD (TDMA, 8PSK, TN 0-4) | GSM | 9.55 | ± 9.6 % |
| 10100 | CAE | LTE-FDD (SC-FDMA, 100% RB, 20 MHz, QPSK) | LTE-FDD | 5.67 | ± 9.6 % |
| 10101 | CAE | LTE-FDD (SC-FDMA, 100% RB, 20 MHz, 16-QAM) | LTE-FDD | 6.42 | ± 9.6 % |
| 10102 | CAE | LTE-FDD (SC-FDMA, 100% RB, 20 MHz, 64-QAM) | LTE-FDD | 6.60 | ± 9.6 % |
| 10103 | CAG | LTE-TDD (SC-FDMA, 100% RB, 20 MHz, QPSK) | LTE-TDD | 9.29 | ± 9.6 % |
| 10104 | CAG | LTE-TDD (SC-FDMA, 100% RB, 20 MHz, 16-QAM) | LTE-TDD | 9.97 | ± 9.6 % |
| 10105 | CAG | LTE-TDD (SC-FDMA, 100% RB, 20 MHz, 64-QAM) | LTE-TDD | 10.01 | ± 9.6 % |
| 10108 | CAG | LTE-FDD (SC-FDMA, 100% RB, 10 MHz, QPSK) | LTE-FDD | 5.80 | ± 9.6 % |

| | | | | | |
|-------|-----|------------------------------------------------|---------|-------|---------|
| 10109 | CAG | LTE-FDD (SC-FDMA, 100% RB, 10 MHz, 16-QAM) | LTE-FDD | 6.43 | ± 9.6 % |
| 10110 | CAG | LTE-FDD (SC-FDMA, 100% RB, 5 MHz, QPSK) | LTE-FDD | 5.75 | ± 9.6 % |
| 10111 | CAG | LTE-FDD (SC-FDMA, 100% RB, 5 MHz, 16-QAM) | LTE-FDD | 6.44 | ± 9.6 % |
| 10112 | CAG | LTE-FDD (SC-FDMA, 100% RB, 10 MHz, 64-QAM) | LTE-FDD | 6.59 | ± 9.6 % |
| 10113 | CAG | LTE-FDD (SC-FDMA, 100% RB, 5 MHz, 64-QAM) | LTE-FDD | 6.62 | ± 9.6 % |
| 10114 | CAC | IEEE 802.11n (HT Greenfield, 13.5 Mbps, BPSK) | WLAN | 8.10 | ± 9.6 % |
| 10115 | CAC | IEEE 802.11n (HT Greenfield, 81 Mbps, 16-QAM) | WLAN | 8.46 | ± 9.6 % |
| 10116 | CAC | IEEE 802.11n (HT Greenfield, 135 Mbps, 64-QAM) | WLAN | 8.15 | ± 9.6 % |
| 10117 | CAC | IEEE 802.11n (HT Mixed, 13.5 Mbps, BPSK) | WLAN | 8.07 | ± 9.6 % |
| 10118 | CAC | IEEE 802.11n (HT Mixed, 81 Mbps, 16-QAM) | WLAN | 8.59 | ± 9.6 % |
| 10119 | CAC | IEEE 802.11n (HT Mixed, 135 Mbps, 64-QAM) | WLAN | 8.13 | ± 9.6 % |
| 10140 | CAE | LTE-FDD (SC-FDMA, 100% RB, 15 MHz, 16-QAM) | LTE-FDD | 6.49 | ± 9.6 % |
| 10141 | CAE | LTE-FDD (SC-FDMA, 100% RB, 15 MHz, 64-QAM) | LTE-FDD | 6.53 | ± 9.6 % |
| 10142 | CAE | LTE-FDD (SC-FDMA, 100% RB, 3 MHz, QPSK) | LTE-FDD | 5.73 | ± 9.6 % |
| 10143 | CAE | LTE-FDD (SC-FDMA, 100% RB, 3 MHz, 16-QAM) | LTE-FDD | 6.35 | ± 9.6 % |
| 10144 | CAE | LTE-FDD (SC-FDMA, 100% RB, 3 MHz, 64-QAM) | LTE-FDD | 6.65 | ± 9.6 % |
| 10145 | CAF | LTE-FDD (SC-FDMA, 100% RB, 1.4 MHz, QPSK) | LTE-FDD | 5.76 | ± 9.6 % |
| 10146 | CAF | LTE-FDD (SC-FDMA, 100% RB, 1.4 MHz, 16-QAM) | LTE-FDD | 6.41 | ± 9.6 % |
| 10147 | CAF | LTE-FDD (SC-FDMA, 100% RB, 1.4 MHz, 64-QAM) | LTE-FDD | 6.72 | ± 9.6 % |
| 10149 | CAE | LTE-FDD (SC-FDMA, 50% RB, 20 MHz, 16-QAM) | LTE-FDD | 6.42 | ± 9.6 % |
| 10150 | CAE | LTE-FDD (SC-FDMA, 50% RB, 20 MHz, 64-QAM) | LTE-FDD | 6.60 | ± 9.6 % |
| 10151 | CAG | LTE-TDD (SC-FDMA, 50% RB, 20 MHz, QPSK) | LTE-TDD | 9.28 | ± 9.6 % |
| 10152 | CAG | LTE-TDD (SC-FDMA, 50% RB, 20 MHz, 16-QAM) | LTE-TDD | 9.92 | ± 9.6 % |
| 10153 | CAG | LTE-TDD (SC-FDMA, 50% RB, 20 MHz, 64-QAM) | LTE-TDD | 10.05 | ± 9.6 % |
| 10154 | CAG | LTE-FDD (SC-FDMA, 50% RB, 10 MHz, QPSK) | LTE-FDD | 5.75 | ± 9.6 % |
| 10155 | CAG | LTE-FDD (SC-FDMA, 50% RB, 10 MHz, 16-QAM) | LTE-FDD | 6.43 | ± 9.6 % |
| 10156 | CAG | LTE-FDD (SC-FDMA, 50% RB, 5 MHz, QPSK) | LTE-FDD | 5.79 | ± 9.6 % |
| 10157 | CAG | LTE-FDD (SC-FDMA, 50% RB, 5 MHz, 16-QAM) | LTE-FDD | 6.49 | ± 9.6 % |
| 10158 | CAG | LTE-FDD (SC-FDMA, 50% RB, 10 MHz, 64-QAM) | LTE-FDD | 6.62 | ± 9.6 % |
| 10159 | CAG | LTE-FDD (SC-FDMA, 50% RB, 5 MHz, 64-QAM) | LTE-FDD | 6.56 | ± 9.6 % |
| 10160 | CAE | LTE-FDD (SC-FDMA, 50% RB, 15 MHz, QPSK) | LTE-FDD | 5.82 | ± 9.6 % |
| 10161 | CAE | LTE-FDD (SC-FDMA, 50% RB, 15 MHz, 16-QAM) | LTE-FDD | 6.43 | ± 9.6 % |
| 10162 | CAE | LTE-FDD (SC-FDMA, 50% RB, 15 MHz, 64-QAM) | LTE-FDD | 6.58 | ± 9.6 % |
| 10166 | CAF | LTE-FDD (SC-FDMA, 50% RB, 1.4 MHz, QPSK) | LTE-FDD | 5.46 | ± 9.6 % |
| 10167 | CAF | LTE-FDD (SC-FDMA, 50% RB, 1.4 MHz, 16-QAM) | LTE-FDD | 6.21 | ± 9.6 % |
| 10168 | CAF | LTE-FDD (SC-FDMA, 50% RB, 1.4 MHz, 64-QAM) | LTE-FDD | 6.79 | ± 9.6 % |
| 10169 | CAE | LTE-FDD (SC-FDMA, 1 RB, 20 MHz, QPSK) | LTE-FDD | 5.73 | ± 9.6 % |
| 10170 | CAE | LTE-FDD (SC-FDMA, 1 RB, 20 MHz, 16-QAM) | LTE-FDD | 6.52 | ± 9.6 % |
| 10171 | AAE | LTE-FDD (SC-FDMA, 1 RB, 20 MHz, 64-QAM) | LTE-FDD | 6.49 | ± 9.6 % |
| 10172 | CAG | LTE-TDD (SC-FDMA, 1 RB, 20 MHz, QPSK) | LTE-TDD | 9.21 | ± 9.6 % |
| 10173 | CAG | LTE-TDD (SC-FDMA, 1 RB, 20 MHz, 16-QAM) | LTE-TDD | 9.48 | ± 9.6 % |
| 10174 | CAG | LTE-TDD (SC-FDMA, 1 RB, 20 MHz, 64-QAM) | LTE-TDD | 10.25 | ± 9.6 % |
| 10175 | CAG | LTE-FDD (SC-FDMA, 1 RB, 10 MHz, QPSK) | LTE-FDD | 5.72 | ± 9.6 % |
| 10176 | CAG | LTE-FDD (SC-FDMA, 1 RB, 10 MHz, 16-QAM) | LTE-FDD | 6.52 | ± 9.6 % |
| 10177 | CAI | LTE-FDD (SC-FDMA, 1 RB, 5 MHz, QPSK) | LTE-FDD | 5.73 | ± 9.6 % |
| 10178 | CAG | LTE-FDD (SC-FDMA, 1 RB, 5 MHz, 16-QAM) | LTE-FDD | 6.52 | ± 9.6 % |
| 10179 | CAG | LTE-FDD (SC-FDMA, 1 RB, 10 MHz, 64-QAM) | LTE-FDD | 6.50 | ± 9.6 % |
| 10180 | CAG | LTE-FDD (SC-FDMA, 1 RB, 5 MHz, 64-QAM) | LTE-FDD | 6.50 | ± 9.6 % |
| 10181 | CAE | LTE-FDD (SC-FDMA, 1 RB, 15 MHz, QPSK) | LTE-FDD | 5.72 | ± 9.6 % |
| 10182 | CAE | LTE-FDD (SC-FDMA, 1 RB, 15 MHz, 16-QAM) | LTE-FDD | 6.52 | ± 9.6 % |
| 10183 | AAD | LTE-FDD (SC-FDMA, 1 RB, 15 MHz, 64-QAM) | LTE-FDD | 6.50 | ± 9.6 % |
| 10184 | CAE | LTE-FDD (SC-FDMA, 1 RB, 3 MHz, QPSK) | LTE-FDD | 5.73 | ± 9.6 % |
| 10185 | CAE | LTE-FDD (SC-FDMA, 1 RB, 3 MHz, 16-QAM) | LTE-FDD | 6.51 | ± 9.6 % |
| 10186 | AAE | LTE-FDD (SC-FDMA, 1 RB, 3 MHz, 64-QAM) | LTE-FDD | 6.50 | ± 9.6 % |
| 10187 | CAF | LTE-FDD (SC-FDMA, 1 RB, 1.4 MHz, QPSK) | LTE-FDD | 5.73 | ± 9.6 % |
| 10188 | CAF | LTE-FDD (SC-FDMA, 1 RB, 1.4 MHz, 16-QAM) | LTE-FDD | 6.52 | ± 9.6 % |
| 10189 | AAF | LTE-FDD (SC-FDMA, 1 RB, 1.4 MHz, 64-QAM) | LTE-FDD | 6.50 | ± 9.6 % |
| 10193 | CAC | IEEE 802.11n (HT Greenfield, 6.5 Mbps, BPSK) | WLAN | 8.09 | ± 9.6 % |
| 10194 | CAC | IEEE 802.11n (HT Greenfield, 39 Mbps, 16-QAM) | WLAN | 8.12 | ± 9.6 % |
| 10195 | CAC | IEEE 802.11n (HT Greenfield, 65 Mbps, 64-QAM) | WLAN | 8.21 | ± 9.6 % |
| 10196 | CAC | IEEE 802.11n (HT Mixed, 6.5 Mbps, BPSK) | WLAN | 8.10 | ± 9.6 % |
| 10197 | CAC | IEEE 802.11n (HT Mixed, 39 Mbps, 16-QAM) | WLAN | 8.13 | ± 9.6 % |
| 10198 | CAC | IEEE 802.11n (HT Mixed, 65 Mbps, 64-QAM) | WLAN | 8.27 | ± 9.6 % |
| 10219 | CAC | IEEE 802.11n (HT Mixed, 7.2 Mbps, BPSK) | WLAN | 8.03 | ± 9.6 % |

| | | | | | |
|-------|-----|---------------------------------------------|----------|-------|---------|
| 10220 | CAC | IEEE 802.11n (HT Mixed, 43.3 Mbps, 16-QAM) | WLAN | 8.13 | ± 9.6 % |
| 10221 | CAC | IEEE 802.11n (HT Mixed, 72.2 Mbps, 64-QAM) | WLAN | 8.27 | ± 9.6 % |
| 10222 | CAC | IEEE 802.11n (HT Mixed, 15 Mbps, BPSK) | WLAN | 8.06 | ± 9.6 % |
| 10223 | CAC | IEEE 802.11n (HT Mixed, 90 Mbps, 16-QAM) | WLAN | 8.48 | ± 9.6 % |
| 10224 | CAC | IEEE 802.11n (HT Mixed, 150 Mbps, 64-QAM) | WLAN | 8.08 | ± 9.6 % |
| 10225 | CAB | UMTS-FDD (HSPA+) | WCDMA | 5.97 | ± 9.6 % |
| 10226 | CAA | LTE-TDD (SC-FDMA, 1 RB, 1.4 MHz, 16-QAM) | LTE-TDD | 9.49 | ± 9.6 % |
| 10227 | CAA | LTE-TDD (SC-FDMA, 1 RB, 1.4 MHz, 64-QAM) | LTE-TDD | 10.26 | ± 9.6 % |
| 10228 | CAA | LTE-TDD (SC-FDMA, 1 RB, 1.4 MHz, QPSK) | LTE-TDD | 9.22 | ± 9.6 % |
| 10229 | CAC | LTE-TDD (SC-FDMA, 1 RB, 3 MHz, 16-QAM) | LTE-TDD | 9.48 | ± 9.6 % |
| 10230 | CAC | LTE-TDD (SC-FDMA, 1 RB, 3 MHz, 64-QAM) | LTE-TDD | 10.25 | ± 9.6 % |
| 10231 | CAC | LTE-TDD (SC-FDMA, 1 RB, 3 MHz, QPSK) | LTE-TDD | 9.19 | ± 9.6 % |
| 10232 | CAF | LTE-TDD (SC-FDMA, 1 RB, 5 MHz, 16-QAM) | LTE-TDD | 9.48 | ± 9.6 % |
| 10233 | CAF | LTE-TDD (SC-FDMA, 1 RB, 5 MHz, 64-QAM) | LTE-TDD | 10.25 | ± 9.6 % |
| 10234 | CAF | LTE-TDD (SC-FDMA, 1 RB, 5 MHz, QPSK) | LTE-TDD | 9.21 | ± 9.6 % |
| 10235 | CAF | LTE-TDD (SC-FDMA, 1 RB, 10 MHz, 16-QAM) | LTE-TDD | 9.48 | ± 9.6 % |
| 10236 | CAF | LTE-TDD (SC-FDMA, 1 RB, 10 MHz, 64-QAM) | LTE-TDD | 10.25 | ± 9.6 % |
| 10237 | CAF | LTE-TDD (SC-FDMA, 1 RB, 10 MHz, QPSK) | LTE-TDD | 9.21 | ± 9.6 % |
| 10238 | CAF | LTE-TDD (SC-FDMA, 1 RB, 15 MHz, 16-QAM) | LTE-TDD | 9.48 | ± 9.6 % |
| 10239 | CAF | LTE-TDD (SC-FDMA, 1 RB, 15 MHz, 64-QAM) | LTE-TDD | 10.25 | ± 9.6 % |
| 10240 | CAF | LTE-TDD (SC-FDMA, 1 RB, 15 MHz, QPSK) | LTE-TDD | 9.21 | ± 9.6 % |
| 10241 | CAA | LTE-TDD (SC-FDMA, 50% RB, 1.4 MHz, 16-QAM) | LTE-TDD | 9.82 | ± 9.6 % |
| 10242 | CAA | LTE-TDD (SC-FDMA, 50% RB, 1.4 MHz, 64-QAM) | LTE-TDD | 9.86 | ± 9.6 % |
| 10243 | CAA | LTE-TDD (SC-FDMA, 50% RB, 1.4 MHz, QPSK) | LTE-TDD | 9.46 | ± 9.6 % |
| 10244 | CAC | LTE-TDD (SC-FDMA, 50% RB, 3 MHz, 16-QAM) | LTE-TDD | 10.06 | ± 9.6 % |
| 10245 | CAC | LTE-TDD (SC-FDMA, 50% RB, 3 MHz, 64-QAM) | LTE-TDD | 10.06 | ± 9.6 % |
| 10246 | CAC | LTE-TDD (SC-FDMA, 50% RB, 3 MHz, QPSK) | LTE-TDD | 9.30 | ± 9.6 % |
| 10247 | CAF | LTE-TDD (SC-FDMA, 50% RB, 5 MHz, 16-QAM) | LTE-TDD | 9.91 | ± 9.6 % |
| 10248 | CAF | LTE-TDD (SC-FDMA, 50% RB, 5 MHz, 64-QAM) | LTE-TDD | 10.09 | ± 9.6 % |
| 10249 | CAF | LTE-TDD (SC-FDMA, 50% RB, 5 MHz, QPSK) | LTE-TDD | 9.29 | ± 9.6 % |
| 10250 | CAF | LTE-TDD (SC-FDMA, 50% RB, 10 MHz, 16-QAM) | LTE-TDD | 9.81 | ± 9.6 % |
| 10251 | CAF | LTE-TDD (SC-FDMA, 50% RB, 10 MHz, 64-QAM) | LTE-TDD | 10.17 | ± 9.6 % |
| 10252 | CAF | LTE-TDD (SC-FDMA, 50% RB, 10 MHz, QPSK) | LTE-TDD | 9.24 | ± 9.6 % |
| 10253 | CAF | LTE-TDD (SC-FDMA, 50% RB, 15 MHz, 16-QAM) | LTE-TDD | 9.90 | ± 9.6 % |
| 10254 | CAF | LTE-TDD (SC-FDMA, 50% RB, 15 MHz, 64-QAM) | LTE-TDD | 10.14 | ± 9.6 % |
| 10255 | CAF | LTE-TDD (SC-FDMA, 50% RB, 15 MHz, QPSK) | LTE-TDD | 9.20 | ± 9.6 % |
| 10256 | CAA | LTE-TDD (SC-FDMA, 100% RB, 1.4 MHz, 16-QAM) | LTE-TDD | 9.96 | ± 9.6 % |
| 10257 | CAA | LTE-TDD (SC-FDMA, 100% RB, 1.4 MHz, 64-QAM) | LTE-TDD | 10.08 | ± 9.6 % |
| 10258 | CAA | LTE-TDD (SC-FDMA, 100% RB, 1.4 MHz, QPSK) | LTE-TDD | 9.34 | ± 9.6 % |
| 10259 | CAC | LTE-TDD (SC-FDMA, 100% RB, 3 MHz, 16-QAM) | LTE-TDD | 9.98 | ± 9.6 % |
| 10260 | CAC | LTE-TDD (SC-FDMA, 100% RB, 3 MHz, 64-QAM) | LTE-TDD | 9.97 | ± 9.6 % |
| 10261 | CAC | LTE-TDD (SC-FDMA, 100% RB, 3 MHz, QPSK) | LTE-TDD | 9.24 | ± 9.6 % |
| 10262 | CAF | LTE-TDD (SC-FDMA, 100% RB, 5 MHz, 16-QAM) | LTE-TDD | 9.83 | ± 9.6 % |
| 10263 | CAF | LTE-TDD (SC-FDMA, 100% RB, 5 MHz, 64-QAM) | LTE-TDD | 10.16 | ± 9.6 % |
| 10264 | CAF | LTE-TDD (SC-FDMA, 100% RB, 5 MHz, QPSK) | LTE-TDD | 9.23 | ± 9.6 % |
| 10265 | CAF | LTE-TDD (SC-FDMA, 100% RB, 10 MHz, 16-QAM) | LTE-TDD | 9.92 | ± 9.6 % |
| 10266 | CAF | LTE-TDD (SC-FDMA, 100% RB, 10 MHz, 64-QAM) | LTE-TDD | 10.07 | ± 9.6 % |
| 10267 | CAF | LTE-TDD (SC-FDMA, 100% RB, 10 MHz, QPSK) | LTE-TDD | 9.30 | ± 9.6 % |
| 10268 | CAF | LTE-TDD (SC-FDMA, 100% RB, 15 MHz, 16-QAM) | LTE-TDD | 10.06 | ± 9.6 % |
| 10269 | CAF | LTE-TDD (SC-FDMA, 100% RB, 15 MHz, 64-QAM) | LTE-TDD | 10.13 | ± 9.6 % |
| 10270 | CAF | LTE-TDD (SC-FDMA, 100% RB, 15 MHz, QPSK) | LTE-TDD | 9.58 | ± 9.6 % |
| 10274 | CAB | UMTS-FDD (HSUPA, Subtest 5, 3GPP Rel8.10) | WCDMA | 4.87 | ± 9.6 % |
| 10275 | CAB | UMTS-FDD (HSUPA, Subtest 5, 3GPP Rel8.4) | WCDMA | 3.96 | ± 9.6 % |
| 10277 | CAA | PHS (QPSK) | PHS | 11.81 | ± 9.6 % |
| 10278 | CAA | PHS (QPSK, BW 884MHz, Rolloff 0.5) | PHS | 11.81 | ± 9.6 % |
| 10279 | CAA | PHS (QPSK, BW 884MHz, Rolloff 0.38) | PHS | 12.18 | ± 9.6 % |
| 10290 | AAB | CDMA2000, RC1, SO55, Full Rate | CDMA2000 | 3.91 | ± 9.6 % |
| 10291 | AAB | CDMA2000, RC3, SO55, Full Rate | CDMA2000 | 3.46 | ± 9.6 % |
| 10292 | AAB | CDMA2000, RC3, SO32, Full Rate | CDMA2000 | 3.39 | ± 9.6 % |
| 10293 | AAB | CDMA2000, RC3, SO3, Full Rate | CDMA2000 | 3.50 | ± 9.6 % |
| 10295 | AAB | CDMA2000, RC1, SO3, 1/8th Rate 25 fr. | CDMA2000 | 12.49 | ± 9.6 % |
| 10297 | AAD | LTE-FDD (SC-FDMA, 50% RB, 20 MHz, QPSK) | LTE-FDD | 5.81 | ± 9.6 % |
| 10298 | AAD | LTE-FDD (SC-FDMA, 50% RB, 3 MHz, QPSK) | LTE-FDD | 5.72 | ± 9.6 % |
| 10299 | AAD | LTE-FDD (SC-FDMA, 50% RB, 3 MHz, 16-QAM) | LTE-FDD | 6.39 | ± 9.6 % |

| | | | | | |
|-------|-----|---------------------------------------------------------------------------------|----------|-------|---------|
| 10300 | AAD | LTE-FDD (SC-FDMA, 50% RB, 3 MHz, 64-QAM) | LTE-FDD | 6.60 | ± 9.6 % |
| 10301 | AAA | IEEE 802.16e WiMAX (29:18, 5ms, 10MHz, QPSK, PUSC) | WiMAX | 12.03 | ± 9.6 % |
| 10302 | AAA | IEEE 802.16e WiMAX (29:18, 5ms, 10MHz, QPSK, PUSC, 3 CTRL symbols) | WiMAX | 12.57 | ± 9.6 % |
| 10303 | AAA | IEEE 802.16e WiMAX (31:15, 5ms, 10MHz, 64QAM, PUSC) | WiMAX | 12.52 | ± 9.6 % |
| 10304 | AAA | IEEE 802.16e WiMAX (29:18, 5ms, 10MHz, 64QAM, PUSC) | WiMAX | 11.86 | ± 9.6 % |
| 10305 | AAA | IEEE 802.16e WiMAX (31:15, 10ms, 10MHz, 64QAM, PUSC, 15 symbols) | WiMAX | 15.24 | ± 9.6 % |
| 10306 | AAA | IEEE 802.16e WiMAX (29:18, 10ms, 10MHz, 64QAM, PUSC, 18 symbols) | WiMAX | 14.67 | ± 9.6 % |
| 10307 | AAA | IEEE 802.16e WiMAX (29:18, 10ms, 10MHz, QPSK, PUSC, 18 symbols) | WiMAX | 14.49 | ± 9.6 % |
| 10308 | AAA | IEEE 802.16e WiMAX (29:18, 10ms, 10MHz, 16QAM, PUSC) | WiMAX | 14.46 | ± 9.6 % |
| 10309 | AAA | IEEE 802.16e WiMAX (29:18, 10ms, 10MHz, 16QAM, AMC 2x3, 18 symbols) | WiMAX | 14.58 | ± 9.6 % |
| 10310 | AAA | IEEE 802.16e WiMAX (29:18, 10ms, 10MHz, QPSK, AMC 2x3, 18 symbols) | WiMAX | 14.57 | ± 9.6 % |
| 10311 | AAD | LTE-FDD (SC-FDMA, 100% RB, 15 MHz, QPSK) | LTE-FDD | 6.06 | ± 9.6 % |
| 10313 | AAA | iDEN 1:3 | iDEN | 10.51 | ± 9.6 % |
| 10314 | AAA | iDEN 1:6 | iDEN | 13.48 | ± 9.6 % |
| 10315 | AAB | IEEE 802.11b WiFi 2.4 GHz (DSSS, 1 Mbps, 96pc duty cycle) | WLAN | 1.71 | ± 9.6 % |
| 10316 | AAB | IEEE 802.11g WiFi 2.4 GHz (ERP-OFDM, 6 Mbps, 96pc duty cycle) | WLAN | 8.36 | ± 9.6 % |
| 10317 | AAC | IEEE 802.11a WiFi 5 GHz (OFDM, 6 Mbps, 96pc duty cycle) | WLAN | 8.36 | ± 9.6 % |
| 10352 | AAA | Pulse Waveform (200Hz, 10%) | Generic | 10.00 | ± 9.6 % |
| 10353 | AAA | Pulse Waveform (200Hz, 20%) | Generic | 6.99 | ± 9.6 % |
| 10354 | AAA | Pulse Waveform (200Hz, 40%) | Generic | 3.98 | ± 9.6 % |
| 10355 | AAA | Pulse Waveform (200Hz, 60%) | Generic | 2.22 | ± 9.6 % |
| 10356 | AAA | Pulse Waveform (200Hz, 80%) | Generic | 0.97 | ± 9.6 % |
| 10387 | AAA | QPSK Waveform, 1 MHz | Generic | 5.10 | ± 9.6 % |
| 10388 | AAA | QPSK Waveform, 10 MHz | Generic | 5.22 | ± 9.6 % |
| 10396 | AAA | 64-QAM Waveform, 100 kHz | Generic | 6.27 | ± 9.6 % |
| 10399 | AAA | 64-QAM Waveform, 40 MHz | Generic | 6.27 | ± 9.6 % |
| 10400 | AAD | IEEE 802.11ac WiFi (20MHz, 64-QAM, 99pc duty cycle) | WLAN | 8.37 | ± 9.6 % |
| 10401 | AAD | IEEE 802.11ac WiFi (40MHz, 64-QAM, 99pc duty cycle) | WLAN | 8.60 | ± 9.6 % |
| 10402 | AAD | IEEE 802.11ac WiFi (80MHz, 64-QAM, 99pc duty cycle) | WLAN | 8.53 | ± 9.6 % |
| 10403 | AAB | CDMA2000 (1xEV-DO, Rev. 0) | CDMA2000 | 3.76 | ± 9.6 % |
| 10404 | AAB | CDMA2000 (1xEV-DO, Rev. A) | CDMA2000 | 3.77 | ± 9.6 % |
| 10406 | AAB | CDMA2000, RC3, SO32, SCH0, Full Rate | CDMA2000 | 5.22 | ± 9.6 % |
| 10410 | AAF | LTE-TDD (SC-FDMA, 1 RB, 10 MHz, QPSK, UL Subframe=2,3,4,7,8,9, Subframe Conf=4) | LTE-TDD | 7.82 | ± 9.6 % |
| 10414 | AAA | WLAN CCDF, 64-QAM, 40MHz | Generic | 8.54 | ± 9.6 % |
| 10415 | AAA | IEEE 802.11b WiFi 2.4 GHz (DSSS, 1 Mbps, 99pc duty cycle) | WLAN | 1.54 | ± 9.6 % |
| 10416 | AAA | IEEE 802.11g WiFi 2.4 GHz (ERP-OFDM, 6 Mbps, 99pc duty cycle) | WLAN | 8.23 | ± 9.6 % |
| 10417 | AAB | IEEE 802.11a/h WiFi 5 GHz (OFDM, 6 Mbps, 99pc duty cycle) | WLAN | 8.23 | ± 9.6 % |
| 10418 | AAA | IEEE 802.11g WiFi 2.4 GHz (DSSS-OFDM, 6 Mbps, 99pc duty cycle, Long preamble) | WLAN | 8.14 | ± 9.6 % |
| 10419 | AAA | IEEE 802.11g WiFi 2.4 GHz (DSSS-OFDM, 6 Mbps, 99pc duty cycle, Short preamble) | WLAN | 8.19 | ± 9.6 % |
| 10422 | AAB | IEEE 802.11n (HT Greenfield, 7.2 Mbps, BPSK) | WLAN | 8.32 | ± 9.6 % |
| 10423 | AAB | IEEE 802.11n (HT Greenfield, 43.3 Mbps, 16-QAM) | WLAN | 8.47 | ± 9.6 % |
| 10424 | AAB | IEEE 802.11n (HT Greenfield, 72.2 Mbps, 64-QAM) | WLAN | 8.40 | ± 9.6 % |
| 10425 | AAB | IEEE 802.11n (HT Greenfield, 15 Mbps, BPSK) | WLAN | 8.41 | ± 9.6 % |
| 10426 | AAB | IEEE 802.11n (HT Greenfield, 90 Mbps, 16-QAM) | WLAN | 8.45 | ± 9.6 % |
| 10427 | AAB | IEEE 802.11n (HT Greenfield, 150 Mbps, 64-QAM) | WLAN | 8.41 | ± 9.6 % |
| 10430 | AAD | LTE-FDD (OFDMA, 5 MHz, E-TM 3.1) | LTE-FDD | 8.28 | ± 9.6 % |
| 10431 | AAD | LTE-FDD (OFDMA, 10 MHz, E-TM 3.1) | LTE-FDD | 8.38 | ± 9.6 % |
| 10432 | AAC | LTE-FDD (OFDMA, 15 MHz, E-TM 3.1) | LTE-FDD | 8.34 | ± 9.6 % |
| 10433 | AAC | LTE-FDD (OFDMA, 20 MHz, E-TM 3.1) | LTE-FDD | 8.34 | ± 9.6 % |
| 10434 | AAA | W-CDMA (BS Test Model 1, 64 DPCH) | WCDMA | 8.60 | ± 9.6 % |
| 10435 | AAF | LTE-TDD (SC-FDMA, 1 RB, 20 MHz, QPSK, UL Subframe=2,3,4,7,8,9) | LTE-TDD | 7.82 | ± 9.6 % |
| 10447 | AAD | LTE-FDD (OFDMA, 5 MHz, E-TM 3.1, Clipping 44%) | LTE-FDD | 7.56 | ± 9.6 % |
| 10448 | AAD | LTE-FDD (OFDMA, 10 MHz, E-TM 3.1, Clipping 44%) | LTE-FDD | 7.53 | ± 9.6 % |
| 10449 | AAC | LTE-FDD (OFDMA, 15 MHz, E-TM 3.1, Clipping 44%) | LTE-FDD | 7.51 | ± 9.6 % |
| 10450 | AAC | LTE-FDD (OFDMA, 20 MHz, E-TM 3.1, Clipping 44%) | LTE-FDD | 7.48 | ± 9.6 % |

| | | | | | |
|-------|-----|------------------------------------------------------------------------|----------|------|---------|
| 10451 | AAA | W-CDMA (BS Test Model 1, 64 DPCH, Clipping 44%) | WCDMA | 7.59 | ± 9.6 % |
| 10456 | AAB | IEEE 802.11ac WiFi (160MHz, 64-QAM, 99pc duty cycle) | WLAN | 8.63 | ± 9.6 % |
| 10457 | AAA | UMTS-FDD (DC-HSDPA) | WCDMA | 6.62 | ± 9.6 % |
| 10458 | AAA | CDMA2000 (1xEV-DO, Rev. B, 2 carriers) | CDMA2000 | 6.55 | ± 9.6 % |
| 10459 | AAA | CDMA2000 (1xEV-DO, Rev. B, 3 carriers) | CDMA2000 | 8.25 | ± 9.6 % |
| 10460 | AAA | UMTS-FDD (WCDMA, AMR) | WCDMA | 2.39 | ± 9.6 % |
| 10461 | AAA | LTE-TDD (SC-FDMA, 1 RB, 1.4 MHz, QPSK, UL Subframe=2,3,4,7,8,9) | LTE-TDD | 7.82 | ± 9.6 % |
| 10462 | AAA | LTE-TDD (SC-FDMA, 1 RB, 1.4 MHz, 16-QAM, UL Subframe=2,3,4,7,8,9) | LTE-TDD | 8.30 | ± 9.6 % |
| 10463 | AAA | LTE-TDD (SC-FDMA, 1 RB, 1.4 MHz, 64-QAM, UL Subframe=2,3,4,7,8,9) | LTE-TDD | 8.56 | ± 9.6 % |
| 10464 | AAB | LTE-TDD (SC-FDMA, 1 RB, 3 MHz, QPSK, UL Subframe=2,3,4,7,8,9) | LTE-TDD | 7.82 | ± 9.6 % |
| 10465 | AAB | LTE-TDD (SC-FDMA, 1 RB, 3 MHz, 16-QAM, UL Subframe=2,3,4,7,8,9) | LTE-TDD | 8.32 | ± 9.6 % |
| 10466 | AAB | LTE-TDD (SC-FDMA, 1 RB, 3 MHz, 64-QAM, UL Subframe=2,3,4,7,8,9) | LTE-TDD | 8.57 | ± 9.6 % |
| 10467 | AAE | LTE-TDD (SC-FDMA, 1 RB, 5 MHz, QPSK, UL Subframe=2,3,4,7,8,9) | LTE-TDD | 7.82 | ± 9.6 % |
| 10468 | AAE | LTE-TDD (SC-FDMA, 1 RB, 5 MHz, 16-QAM, UL Subframe=2,3,4,7,8,9) | LTE-TDD | 8.32 | ± 9.6 % |
| 10469 | AAE | LTE-TDD (SC-FDMA, 1 RB, 5 MHz, 64-QAM, UL Subframe=2,3,4,7,8,9) | LTE-TDD | 8.56 | ± 9.6 % |
| 10470 | AAE | LTE-TDD (SC-FDMA, 1 RB, 10 MHz, QPSK, UL Subframe=2,3,4,7,8,9) | LTE-TDD | 7.82 | ± 9.6 % |
| 10471 | AAE | LTE-TDD (SC-FDMA, 1 RB, 10 MHz, 16-QAM, UL Subframe=2,3,4,7,8,9) | LTE-TDD | 8.32 | ± 9.6 % |
| 10472 | AAE | LTE-TDD (SC-FDMA, 1 RB, 10 MHz, 64-QAM, UL Subframe=2,3,4,7,8,9) | LTE-TDD | 8.57 | ± 9.6 % |
| 10473 | AAE | LTE-TDD (SC-FDMA, 1 RB, 15 MHz, QPSK, UL Subframe=2,3,4,7,8,9) | LTE-TDD | 7.82 | ± 9.6 % |
| 10474 | AAE | LTE-TDD (SC-FDMA, 1 RB, 15 MHz, 16-QAM, UL Subframe=2,3,4,7,8,9) | LTE-TDD | 8.32 | ± 9.6 % |
| 10475 | AAE | LTE-TDD (SC-FDMA, 1 RB, 15 MHz, 64-QAM, UL Subframe=2,3,4,7,8,9) | LTE-TDD | 8.57 | ± 9.6 % |
| 10477 | AAF | LTE-TDD (SC-FDMA, 1 RB, 20 MHz, 16-QAM, UL Subframe=2,3,4,7,8,9) | LTE-TDD | 8.32 | ± 9.6 % |
| 10478 | AAF | LTE-TDD (SC-FDMA, 1 RB, 20 MHz, 64-QAM, UL Subframe=2,3,4,7,8,9) | LTE-TDD | 8.57 | ± 9.6 % |
| 10479 | AAA | LTE-TDD (SC-FDMA, 50% RB, 1.4 MHz, QPSK, UL Subframe=2,3,4,7,8,9) | LTE-TDD | 7.74 | ± 9.6 % |
| 10480 | AAA | LTE-TDD (SC-FDMA, 50% RB, 1.4 MHz, 16-QAM, UL Subframe=2,3,4,7,8,9) | LTE-TDD | 8.18 | ± 9.6 % |
| 10481 | AAA | LTE-TDD (SC-FDMA, 50% RB, 1.4 MHz, 64-QAM, UL Subframe=2,3,4,7,8,9) | LTE-TDD | 8.45 | ± 9.6 % |
| 10482 | AAB | LTE-TDD (SC-FDMA, 50% RB, 3 MHz, QPSK, UL Subframe=2,3,4,7,8,9) | LTE-TDD | 7.71 | ± 9.6 % |
| 10483 | AAB | LTE-TDD (SC-FDMA, 50% RB, 3 MHz, 16-QAM, UL Subframe=2,3,4,7,8,9) | LTE-TDD | 8.39 | ± 9.6 % |
| 10484 | AAB | LTE-TDD (SC-FDMA, 50% RB, 3 MHz, 64-QAM, UL Subframe=2,3,4,7,8,9) | LTE-TDD | 8.47 | ± 9.6 % |
| 10485 | AAE | LTE-TDD (SC-FDMA, 50% RB, 5 MHz, QPSK, UL Subframe=2,3,4,7,8,9) | LTE-TDD | 7.59 | ± 9.6 % |
| 10486 | AAE | LTE-TDD (SC-FDMA, 50% RB, 5 MHz, 16-QAM, UL Subframe=2,3,4,7,8,9) | LTE-TDD | 8.38 | ± 9.6 % |
| 10487 | AAE | LTE-TDD (SC-FDMA, 50% RB, 5 MHz, 64-QAM, UL Subframe=2,3,4,7,8,9) | LTE-TDD | 8.60 | ± 9.6 % |
| 10488 | AAE | LTE-TDD (SC-FDMA, 50% RB, 10 MHz, QPSK, UL Subframe=2,3,4,7,8,9) | LTE-TDD | 7.70 | ± 9.6 % |
| 10489 | AAE | LTE-TDD (SC-FDMA, 50% RB, 10 MHz, 16-QAM, UL Subframe=2,3,4,7,8,9) | LTE-TDD | 8.31 | ± 9.6 % |
| 10490 | AAE | LTE-TDD (SC-FDMA, 50% RB, 10 MHz, 64-QAM, UL Subframe=2,3,4,7,8,9) | LTE-TDD | 8.54 | ± 9.6 % |
| 10491 | AAE | LTE-TDD (SC-FDMA, 50% RB, 15 MHz, QPSK, UL Subframe=2,3,4,7,8,9) | LTE-TDD | 7.74 | ± 9.6 % |

| | | | | | |
|-------|-----|----------------------------------------------------------------------|---------|------|---------|
| 10492 | AAE | LTE-TDD (SC-FDMA, 50% RB, 15 MHz, 16-QAM, UL Subframe=2,3,4,7,8,9) | LTE-TDD | 8.41 | ± 9.6 % |
| 10493 | AAE | LTE-TDD (SC-FDMA, 50% RB, 15 MHz, 64-QAM, UL Subframe=2,3,4,7,8,9) | LTE-TDD | 8.55 | ± 9.6 % |
| 10494 | AAF | LTE-TDD (SC-FDMA, 50% RB, 20 MHz, QPSK, UL Subframe=2,3,4,7,8,9) | LTE-TDD | 7.74 | ± 9.6 % |
| 10495 | AAF | LTE-TDD (SC-FDMA, 50% RB, 20 MHz, 16-QAM, UL Subframe=2,3,4,7,8,9) | LTE-TDD | 8.37 | ± 9.6 % |
| 10496 | AAF | LTE-TDD (SC-FDMA, 50% RB, 20 MHz, 64-QAM, UL Subframe=2,3,4,7,8,9) | LTE-TDD | 8.54 | ± 9.6 % |
| 10497 | AAA | LTE-TDD (SC-FDMA, 100% RB, 1.4 MHz, QPSK, UL Subframe=2,3,4,7,8,9) | LTE-TDD | 7.67 | ± 9.6 % |
| 10498 | AAA | LTE-TDD (SC-FDMA, 100% RB, 1.4 MHz, 16-QAM, UL Subframe=2,3,4,7,8,9) | LTE-TDD | 8.40 | ± 9.6 % |
| 10499 | AAA | LTE-TDD (SC-FDMA, 100% RB, 1.4 MHz, 64-QAM, UL Subframe=2,3,4,7,8,9) | LTE-TDD | 8.68 | ± 9.6 % |
| 10500 | AAB | LTE-TDD (SC-FDMA, 100% RB, 3 MHz, QPSK, UL Subframe=2,3,4,7,8,9) | LTE-TDD | 7.67 | ± 9.6 % |
| 10501 | AAB | LTE-TDD (SC-FDMA, 100% RB, 3 MHz, 16-QAM, UL Subframe=2,3,4,7,8,9) | LTE-TDD | 8.44 | ± 9.6 % |
| 10502 | AAB | LTE-TDD (SC-FDMA, 100% RB, 3 MHz, 64-QAM, UL Subframe=2,3,4,7,8,9) | LTE-TDD | 8.52 | ± 9.6 % |
| 10503 | AAE | LTE-TDD (SC-FDMA, 100% RB, 5 MHz, QPSK, UL Subframe=2,3,4,7,8,9) | LTE-TDD | 7.72 | ± 9.6 % |
| 10504 | AAE | LTE-TDD (SC-FDMA, 100% RB, 5 MHz, 16-QAM, UL Subframe=2,3,4,7,8,9) | LTE-TDD | 8.31 | ± 9.6 % |
| 10505 | AAE | LTE-TDD (SC-FDMA, 100% RB, 5 MHz, 64-QAM, UL Subframe=2,3,4,7,8,9) | LTE-TDD | 8.54 | ± 9.6 % |
| 10506 | AAE | LTE-TDD (SC-FDMA, 100% RB, 10 MHz, QPSK, UL Subframe=2,3,4,7,8,9) | LTE-TDD | 7.74 | ± 9.6 % |
| 10507 | AAE | LTE-TDD (SC-FDMA, 100% RB, 10 MHz, 16-QAM, UL Subframe=2,3,4,7,8,9) | LTE-TDD | 8.36 | ± 9.6 % |
| 10508 | AAE | LTE-TDD (SC-FDMA, 100% RB, 10 MHz, 64-QAM, UL Subframe=2,3,4,7,8,9) | LTE-TDD | 8.55 | ± 9.6 % |
| 10509 | AAE | LTE-TDD (SC-FDMA, 100% RB, 15 MHz, QPSK, UL Subframe=2,3,4,7,8,9) | LTE-TDD | 7.99 | ± 9.6 % |
| 10510 | AAE | LTE-TDD (SC-FDMA, 100% RB, 15 MHz, 16-QAM, UL Subframe=2,3,4,7,8,9) | LTE-TDD | 8.49 | ± 9.6 % |
| 10511 | AAE | LTE-TDD (SC-FDMA, 100% RB, 15 MHz, 64-QAM, UL Subframe=2,3,4,7,8,9) | LTE-TDD | 8.51 | ± 9.6 % |
| 10512 | AAF | LTE-TDD (SC-FDMA, 100% RB, 20 MHz, QPSK, UL Subframe=2,3,4,7,8,9) | LTE-TDD | 7.74 | ± 9.6 % |
| 10513 | AAF | LTE-TDD (SC-FDMA, 100% RB, 20 MHz, 16-QAM, UL Subframe=2,3,4,7,8,9) | LTE-TDD | 8.42 | ± 9.6 % |
| 10514 | AAF | LTE-TDD (SC-FDMA, 100% RB, 20 MHz, 64-QAM, UL Subframe=2,3,4,7,8,9) | LTE-TDD | 8.45 | ± 9.6 % |
| 10515 | AAA | IEEE 802.11b WiFi 2.4 GHz (DSSS, 2 Mbps, 99pc duty cycle) | WLAN | 1.58 | ± 9.6 % |
| 10516 | AAA | IEEE 802.11b WiFi 2.4 GHz (DSSS, 5.5 Mbps, 99pc duty cycle) | WLAN | 1.57 | ± 9.6 % |
| 10517 | AAA | IEEE 802.11b WiFi 2.4 GHz (DSSS, 11 Mbps, 99pc duty cycle) | WLAN | 1.58 | ± 9.6 % |
| 10518 | AAB | IEEE 802.11a/h WiFi 5 GHz (OFDM, 9 Mbps, 99pc duty cycle) | WLAN | 8.23 | ± 9.6 % |
| 10519 | AAB | IEEE 802.11a/h WiFi 5 GHz (OFDM, 12 Mbps, 99pc duty cycle) | WLAN | 8.39 | ± 9.6 % |
| 10520 | AAB | IEEE 802.11a/h WiFi 5 GHz (OFDM, 18 Mbps, 99pc duty cycle) | WLAN | 8.12 | ± 9.6 % |
| 10521 | AAB | IEEE 802.11a/h WiFi 5 GHz (OFDM, 24 Mbps, 99pc duty cycle) | WLAN | 7.97 | ± 9.6 % |
| 10522 | AAB | IEEE 802.11a/h WiFi 5 GHz (OFDM, 36 Mbps, 99pc duty cycle) | WLAN | 8.45 | ± 9.6 % |
| 10523 | AAB | IEEE 802.11a/h WiFi 5 GHz (OFDM, 48 Mbps, 99pc duty cycle) | WLAN | 8.08 | ± 9.6 % |
| 10524 | AAB | IEEE 802.11a/h WiFi 5 GHz (OFDM, 54 Mbps, 99pc duty cycle) | WLAN | 8.27 | ± 9.6 % |
| 10525 | AAB | IEEE 802.11ac WiFi (20MHz, MCS0, 99pc duty cycle) | WLAN | 8.36 | ± 9.6 % |
| 10526 | AAB | IEEE 802.11ac WiFi (20MHz, MCS1, 99pc duty cycle) | WLAN | 8.42 | ± 9.6 % |
| 10527 | AAB | IEEE 802.11ac WiFi (20MHz, MCS2, 99pc duty cycle) | WLAN | 8.21 | ± 9.6 % |
| 10528 | AAB | IEEE 802.11ac WiFi (20MHz, MCS3, 99pc duty cycle) | WLAN | 8.36 | ± 9.6 % |
| 10529 | AAB | IEEE 802.11ac WiFi (20MHz, MCS4, 99pc duty cycle) | WLAN | 8.36 | ± 9.6 % |
| 10531 | AAB | IEEE 802.11ac WiFi (20MHz, MCS6, 99pc duty cycle) | WLAN | 8.43 | ± 9.6 % |
| 10532 | AAB | IEEE 802.11ac WiFi (20MHz, MCS7, 99pc duty cycle) | WLAN | 8.29 | ± 9.6 % |
| 10533 | AAB | IEEE 802.11ac WiFi (20MHz, MCS8, 99pc duty cycle) | WLAN | 8.38 | ± 9.6 % |
| 10534 | AAB | IEEE 802.11ac WiFi (40MHz, MCS0, 99pc duty cycle) | WLAN | 8.45 | ± 9.6 % |

| | | | | | |
|-------|-----|-----------------------------------------------------------------|------|------|---------|
| 10535 | AAB | IEEE 802.11ac WiFi (40MHz, MCS1, 99pc duty cycle) | WLAN | 8.45 | ± 9.6 % |
| 10536 | AAB | IEEE 802.11ac WiFi (40MHz, MCS2, 99pc duty cycle) | WLAN | 8.32 | ± 9.6 % |
| 10537 | AAB | IEEE 802.11ac WiFi (40MHz, MCS3, 99pc duty cycle) | WLAN | 8.44 | ± 9.6 % |
| 10538 | AAB | IEEE 802.11ac WiFi (40MHz, MCS4, 99pc duty cycle) | WLAN | 8.54 | ± 9.6 % |
| 10540 | AAB | IEEE 802.11ac WiFi (40MHz, MCS6, 99pc duty cycle) | WLAN | 8.39 | ± 9.6 % |
| 10541 | AAB | IEEE 802.11ac WiFi (40MHz, MCS7, 99pc duty cycle) | WLAN | 8.46 | ± 9.6 % |
| 10542 | AAB | IEEE 802.11ac WiFi (40MHz, MCS8, 99pc duty cycle) | WLAN | 8.65 | ± 9.6 % |
| 10543 | AAB | IEEE 802.11ac WiFi (40MHz, MCS9, 99pc duty cycle) | WLAN | 8.65 | ± 9.6 % |
| 10544 | AAB | IEEE 802.11ac WiFi (80MHz, MCS0, 99pc duty cycle) | WLAN | 8.47 | ± 9.6 % |
| 10545 | AAB | IEEE 802.11ac WiFi (80MHz, MCS1, 99pc duty cycle) | WLAN | 8.55 | ± 9.6 % |
| 10546 | AAB | IEEE 802.11ac WiFi (80MHz, MCS2, 99pc duty cycle) | WLAN | 8.35 | ± 9.6 % |
| 10547 | AAB | IEEE 802.11ac WiFi (80MHz, MCS3, 99pc duty cycle) | WLAN | 8.49 | ± 9.6 % |
| 10548 | AAB | IEEE 802.11ac WiFi (80MHz, MCS4, 99pc duty cycle) | WLAN | 8.37 | ± 9.6 % |
| 10550 | AAB | IEEE 802.11ac WiFi (80MHz, MCS6, 99pc duty cycle) | WLAN | 8.38 | ± 9.6 % |
| 10551 | AAB | IEEE 802.11ac WiFi (80MHz, MCS7, 99pc duty cycle) | WLAN | 8.50 | ± 9.6 % |
| 10552 | AAB | IEEE 802.11ac WiFi (80MHz, MCS8, 99pc duty cycle) | WLAN | 8.42 | ± 9.6 % |
| 10553 | AAB | IEEE 802.11ac WiFi (80MHz, MCS9, 99pc duty cycle) | WLAN | 8.45 | ± 9.6 % |
| 10554 | AAC | IEEE 802.11ac WiFi (160MHz, MCS0, 99pc duty cycle) | WLAN | 8.48 | ± 9.6 % |
| 10555 | AAC | IEEE 802.11ac WiFi (160MHz, MCS1, 99pc duty cycle) | WLAN | 8.47 | ± 9.6 % |
| 10556 | AAC | IEEE 802.11ac WiFi (160MHz, MCS2, 99pc duty cycle) | WLAN | 8.50 | ± 9.6 % |
| 10557 | AAC | IEEE 802.11ac WiFi (160MHz, MCS3, 99pc duty cycle) | WLAN | 8.52 | ± 9.6 % |
| 10558 | AAC | IEEE 802.11ac WiFi (160MHz, MCS4, 99pc duty cycle) | WLAN | 8.61 | ± 9.6 % |
| 10560 | AAC | IEEE 802.11ac WiFi (160MHz, MCS6, 99pc duty cycle) | WLAN | 8.73 | ± 9.6 % |
| 10561 | AAC | IEEE 802.11ac WiFi (160MHz, MCS7, 99pc duty cycle) | WLAN | 8.56 | ± 9.6 % |
| 10562 | AAC | IEEE 802.11ac WiFi (160MHz, MCS8, 99pc duty cycle) | WLAN | 8.69 | ± 9.6 % |
| 10563 | AAC | IEEE 802.11ac WiFi (160MHz, MCS9, 99pc duty cycle) | WLAN | 8.77 | ± 9.6 % |
| 10564 | AAA | IEEE 802.11g WiFi 2.4 GHz (DSSS-OFDM, 9 Mbps, 99pc duty cycle) | WLAN | 8.25 | ± 9.6 % |
| 10565 | AAA | IEEE 802.11g WiFi 2.4 GHz (DSSS-OFDM, 12 Mbps, 99pc duty cycle) | WLAN | 8.45 | ± 9.6 % |
| 10566 | AAA | IEEE 802.11g WiFi 2.4 GHz (DSSS-OFDM, 18 Mbps, 99pc duty cycle) | WLAN | 8.13 | ± 9.6 % |
| 10567 | AAA | IEEE 802.11g WiFi 2.4 GHz (DSSS-OFDM, 24 Mbps, 99pc duty cycle) | WLAN | 8.00 | ± 9.6 % |
| 10568 | AAA | IEEE 802.11g WiFi 2.4 GHz (DSSS-OFDM, 36 Mbps, 99pc duty cycle) | WLAN | 8.37 | ± 9.6 % |
| 10569 | AAA | IEEE 802.11g WiFi 2.4 GHz (DSSS-OFDM, 48 Mbps, 99pc duty cycle) | WLAN | 8.10 | ± 9.6 % |
| 10570 | AAA | IEEE 802.11g WiFi 2.4 GHz (DSSS-OFDM, 54 Mbps, 99pc duty cycle) | WLAN | 8.30 | ± 9.6 % |
| 10571 | AAA | IEEE 802.11b WiFi 2.4 GHz (DSSS, 1 Mbps, 90pc duty cycle) | WLAN | 1.99 | ± 9.6 % |
| 10572 | AAA | IEEE 802.11b WiFi 2.4 GHz (DSSS, 2 Mbps, 90pc duty cycle) | WLAN | 1.99 | ± 9.6 % |
| 10573 | AAA | IEEE 802.11b WiFi 2.4 GHz (DSSS, 5.5 Mbps, 90pc duty cycle) | WLAN | 1.98 | ± 9.6 % |
| 10574 | AAA | IEEE 802.11b WiFi 2.4 GHz (DSSS, 11 Mbps, 90pc duty cycle) | WLAN | 1.98 | ± 9.6 % |
| 10575 | AAA | IEEE 802.11g WiFi 2.4 GHz (DSSS-OFDM, 6 Mbps, 90pc duty cycle) | WLAN | 8.59 | ± 9.6 % |
| 10576 | AAA | IEEE 802.11g WiFi 2.4 GHz (DSSS-OFDM, 9 Mbps, 90pc duty cycle) | WLAN | 8.60 | ± 9.6 % |
| 10577 | AAA | IEEE 802.11g WiFi 2.4 GHz (DSSS-OFDM, 12 Mbps, 90pc duty cycle) | WLAN | 8.70 | ± 9.6 % |
| 10578 | AAA | IEEE 802.11g WiFi 2.4 GHz (DSSS-OFDM, 18 Mbps, 90pc duty cycle) | WLAN | 8.49 | ± 9.6 % |
| 10579 | AAA | IEEE 802.11g WiFi 2.4 GHz (DSSS-OFDM, 24 Mbps, 90pc duty cycle) | WLAN | 8.36 | ± 9.6 % |
| 10580 | AAA | IEEE 802.11g WiFi 2.4 GHz (DSSS-OFDM, 36 Mbps, 90pc duty cycle) | WLAN | 8.76 | ± 9.6 % |
| 10581 | AAA | IEEE 802.11g WiFi 2.4 GHz (DSSS-OFDM, 48 Mbps, 90pc duty cycle) | WLAN | 8.35 | ± 9.6 % |
| 10582 | AAA | IEEE 802.11g WiFi 2.4 GHz (DSSS-OFDM, 54 Mbps, 90pc duty cycle) | WLAN | 8.67 | ± 9.6 % |
| 10583 | AAB | IEEE 802.11a/h WiFi 5 GHz (OFDM, 6 Mbps, 90pc duty cycle) | WLAN | 8.59 | ± 9.6 % |
| 10584 | AAB | IEEE 802.11a/h WiFi 5 GHz (OFDM, 9 Mbps, 90pc duty cycle) | WLAN | 8.60 | ± 9.6 % |
| 10585 | AAB | IEEE 802.11a/h WiFi 5 GHz (OFDM, 12 Mbps, 90pc duty cycle) | WLAN | 8.70 | ± 9.6 % |
| 10586 | AAB | IEEE 802.11a/h WiFi 5 GHz (OFDM, 18 Mbps, 90pc duty cycle) | WLAN | 8.49 | ± 9.6 % |
| 10587 | AAB | IEEE 802.11a/h WiFi 5 GHz (OFDM, 24 Mbps, 90pc duty cycle) | WLAN | 8.36 | ± 9.6 % |

| | | | | | |
|-------|-----|------------------------------------------------------------|----------|-------|---------|
| 10588 | AAB | IEEE 802.11a/h WiFi 5 GHz (OFDM, 36 Mbps, 90pc duty cycle) | WLAN | 8.76 | ± 9.6 % |
| 10589 | AAB | IEEE 802.11a/h WiFi 5 GHz (OFDM, 48 Mbps, 90pc duty cycle) | WLAN | 8.35 | ± 9.6 % |
| 10590 | AAB | IEEE 802.11a/h WiFi 5 GHz (OFDM, 54 Mbps, 90pc duty cycle) | WLAN | 8.67 | ± 9.6 % |
| 10591 | AAB | IEEE 802.11n (HT Mixed, 20MHz, MCS0, 90pc duty cycle) | WLAN | 8.63 | ± 9.6 % |
| 10592 | AAB | IEEE 802.11n (HT Mixed, 20MHz, MCS1, 90pc duty cycle) | WLAN | 8.79 | ± 9.6 % |
| 10593 | AAB | IEEE 802.11n (HT Mixed, 20MHz, MCS2, 90pc duty cycle) | WLAN | 8.64 | ± 9.6 % |
| 10594 | AAB | IEEE 802.11n (HT Mixed, 20MHz, MCS3, 90pc duty cycle) | WLAN | 8.74 | ± 9.6 % |
| 10595 | AAB | IEEE 802.11n (HT Mixed, 20MHz, MCS4, 90pc duty cycle) | WLAN | 8.74 | ± 9.6 % |
| 10596 | AAB | IEEE 802.11n (HT Mixed, 20MHz, MCS5, 90pc duty cycle) | WLAN | 8.71 | ± 9.6 % |
| 10597 | AAB | IEEE 802.11n (HT Mixed, 20MHz, MCS6, 90pc duty cycle) | WLAN | 8.72 | ± 9.6 % |
| 10598 | AAB | IEEE 802.11n (HT Mixed, 20MHz, MCS7, 90pc duty cycle) | WLAN | 8.50 | ± 9.6 % |
| 10599 | AAB | IEEE 802.11n (HT Mixed, 40MHz, MCS0, 90pc duty cycle) | WLAN | 8.79 | ± 9.6 % |
| 10600 | AAB | IEEE 802.11n (HT Mixed, 40MHz, MCS1, 90pc duty cycle) | WLAN | 8.88 | ± 9.6 % |
| 10601 | AAB | IEEE 802.11n (HT Mixed, 40MHz, MCS2, 90pc duty cycle) | WLAN | 8.82 | ± 9.6 % |
| 10602 | AAB | IEEE 802.11n (HT Mixed, 40MHz, MCS3, 90pc duty cycle) | WLAN | 8.94 | ± 9.6 % |
| 10603 | AAB | IEEE 802.11n (HT Mixed, 40MHz, MCS4, 90pc duty cycle) | WLAN | 9.03 | ± 9.6 % |
| 10604 | AAB | IEEE 802.11n (HT Mixed, 40MHz, MCS5, 90pc duty cycle) | WLAN | 8.76 | ± 9.6 % |
| 10605 | AAB | IEEE 802.11n (HT Mixed, 40MHz, MCS6, 90pc duty cycle) | WLAN | 8.97 | ± 9.6 % |
| 10606 | AAB | IEEE 802.11n (HT Mixed, 40MHz, MCS7, 90pc duty cycle) | WLAN | 8.82 | ± 9.6 % |
| 10607 | AAB | IEEE 802.11ac WiFi (20MHz, MCS0, 90pc duty cycle) | WLAN | 8.64 | ± 9.6 % |
| 10608 | AAB | IEEE 802.11ac WiFi (20MHz, MCS1, 90pc duty cycle) | WLAN | 8.77 | ± 9.6 % |
| 10609 | AAB | IEEE 802.11ac WiFi (20MHz, MCS2, 90pc duty cycle) | WLAN | 8.57 | ± 9.6 % |
| 10610 | AAB | IEEE 802.11ac WiFi (20MHz, MCS3, 90pc duty cycle) | WLAN | 8.78 | ± 9.6 % |
| 10611 | AAB | IEEE 802.11ac WiFi (20MHz, MCS4, 90pc duty cycle) | WLAN | 8.70 | ± 9.6 % |
| 10612 | AAB | IEEE 802.11ac WiFi (20MHz, MCS5, 90pc duty cycle) | WLAN | 8.77 | ± 9.6 % |
| 10613 | AAB | IEEE 802.11ac WiFi (20MHz, MCS6, 90pc duty cycle) | WLAN | 8.94 | ± 9.6 % |
| 10614 | AAB | IEEE 802.11ac WiFi (20MHz, MCS7, 90pc duty cycle) | WLAN | 8.59 | ± 9.6 % |
| 10615 | AAB | IEEE 802.11ac WiFi (20MHz, MCS8, 90pc duty cycle) | WLAN | 8.82 | ± 9.6 % |
| 10616 | AAB | IEEE 802.11ac WiFi (40MHz, MCS0, 90pc duty cycle) | WLAN | 8.82 | ± 9.6 % |
| 10617 | AAB | IEEE 802.11ac WiFi (40MHz, MCS1, 90pc duty cycle) | WLAN | 8.81 | ± 9.6 % |
| 10618 | AAB | IEEE 802.11ac WiFi (40MHz, MCS2, 90pc duty cycle) | WLAN | 8.58 | ± 9.6 % |
| 10619 | AAB | IEEE 802.11ac WiFi (40MHz, MCS3, 90pc duty cycle) | WLAN | 8.86 | ± 9.6 % |
| 10620 | AAB | IEEE 802.11ac WiFi (40MHz, MCS4, 90pc duty cycle) | WLAN | 8.87 | ± 9.6 % |
| 10621 | AAB | IEEE 802.11ac WiFi (40MHz, MCS5, 90pc duty cycle) | WLAN | 8.77 | ± 9.6 % |
| 10622 | AAB | IEEE 802.11ac WiFi (40MHz, MCS6, 90pc duty cycle) | WLAN | 8.68 | ± 9.6 % |
| 10623 | AAB | IEEE 802.11ac WiFi (40MHz, MCS7, 90pc duty cycle) | WLAN | 8.82 | ± 9.6 % |
| 10624 | AAB | IEEE 802.11ac WiFi (40MHz, MCS8, 90pc duty cycle) | WLAN | 8.96 | ± 9.6 % |
| 10625 | AAB | IEEE 802.11ac WiFi (40MHz, MCS9, 90pc duty cycle) | WLAN | 8.96 | ± 9.6 % |
| 10626 | AAB | IEEE 802.11ac WiFi (80MHz, MCS0, 90pc duty cycle) | WLAN | 8.83 | ± 9.6 % |
| 10627 | AAB | IEEE 802.11ac WiFi (80MHz, MCS1, 90pc duty cycle) | WLAN | 8.88 | ± 9.6 % |
| 10628 | AAB | IEEE 802.11ac WiFi (80MHz, MCS2, 90pc duty cycle) | WLAN | 8.71 | ± 9.6 % |
| 10629 | AAB | IEEE 802.11ac WiFi (80MHz, MCS3, 90pc duty cycle) | WLAN | 8.85 | ± 9.6 % |
| 10630 | AAB | IEEE 802.11ac WiFi (80MHz, MCS4, 90pc duty cycle) | WLAN | 8.72 | ± 9.6 % |
| 10631 | AAB | IEEE 802.11ac WiFi (80MHz, MCS5, 90pc duty cycle) | WLAN | 8.81 | ± 9.6 % |
| 10632 | AAB | IEEE 802.11ac WiFi (80MHz, MCS6, 90pc duty cycle) | WLAN | 8.74 | ± 9.6 % |
| 10633 | AAB | IEEE 802.11ac WiFi (80MHz, MCS7, 90pc duty cycle) | WLAN | 8.83 | ± 9.6 % |
| 10634 | AAB | IEEE 802.11ac WiFi (80MHz, MCS8, 90pc duty cycle) | WLAN | 8.80 | ± 9.6 % |
| 10635 | AAB | IEEE 802.11ac WiFi (80MHz, MCS9, 90pc duty cycle) | WLAN | 8.81 | ± 9.6 % |
| 10636 | AAC | IEEE 802.11ac WiFi (160MHz, MCS0, 90pc duty cycle) | WLAN | 8.83 | ± 9.6 % |
| 10637 | AAC | IEEE 802.11ac WiFi (160MHz, MCS1, 90pc duty cycle) | WLAN | 8.79 | ± 9.6 % |
| 10638 | AAC | IEEE 802.11ac WiFi (160MHz, MCS2, 90pc duty cycle) | WLAN | 8.86 | ± 9.6 % |
| 10639 | AAC | IEEE 802.11ac WiFi (160MHz, MCS3, 90pc duty cycle) | WLAN | 8.85 | ± 9.6 % |
| 10640 | AAC | IEEE 802.11ac WiFi (160MHz, MCS4, 90pc duty cycle) | WLAN | 8.98 | ± 9.6 % |
| 10641 | AAC | IEEE 802.11ac WiFi (160MHz, MCS5, 90pc duty cycle) | WLAN | 9.06 | ± 9.6 % |
| 10642 | AAC | IEEE 802.11ac WiFi (160MHz, MCS6, 90pc duty cycle) | WLAN | 9.06 | ± 9.6 % |
| 10643 | AAC | IEEE 802.11ac WiFi (160MHz, MCS7, 90pc duty cycle) | WLAN | 8.89 | ± 9.6 % |
| 10644 | AAC | IEEE 802.11ac WiFi (160MHz, MCS8, 90pc duty cycle) | WLAN | 9.05 | ± 9.6 % |
| 10645 | AAC | IEEE 802.11ac WiFi (160MHz, MCS9, 90pc duty cycle) | WLAN | 9.11 | ± 9.6 % |
| 10646 | AAF | LTE-TDD (SC-FDMA, 1 RB, 5 MHz, QPSK, UL Subframe=2,7) | LTE-TDD | 11.96 | ± 9.6 % |
| 10647 | AAF | LTE-TDD (SC-FDMA, 1 RB, 20 MHz, QPSK, UL Subframe=2,7) | LTE-TDD | 11.96 | ± 9.6 % |
| 10648 | AAA | CDMA2000 (1x Advanced) | CDMA2000 | 3.45 | ± 9.6 % |
| 10652 | AAD | LTE-TDD (OFDMA, 5 MHz, E-TM 3.1, Clipping 44%) | LTE-TDD | 6.91 | ± 9.6 % |
| 10653 | AAD | LTE-TDD (OFDMA, 10 MHz, E-TM 3.1, Clipping 44%) | LTE-TDD | 7.42 | ± 9.6 % |
| 10654 | AAD | LTE-TDD (OFDMA, 15 MHz, E-TM 3.1, Clipping 44%) | LTE-TDD | 6.96 | ± 9.6 % |

| | | | | | |
|-------|-----|-------------------------------------------------|-----------|-------|---------|
| 10655 | AAE | LTE-TDD (OFDMA, 20 MHz, E-TM 3.1, Clipping 44%) | LTE-TDD | 7.21 | ± 9.6 % |
| 10658 | AAA | Pulse Waveform (200Hz, 10%) | Test | 10.00 | ± 9.6 % |
| 10659 | AAA | Pulse Waveform (200Hz, 20%) | Test | 6.99 | ± 9.6 % |
| 10660 | AAA | Pulse Waveform (200Hz, 40%) | Test | 3.98 | ± 9.6 % |
| 10661 | AAA | Pulse Waveform (200Hz, 60%) | Test | 2.22 | ± 9.6 % |
| 10662 | AAA | Pulse Waveform (200Hz, 80%) | Test | 0.97 | ± 9.6 % |
| 10670 | AAA | Bluetooth Low Energy | Bluetooth | 2.19 | ± 9.6 % |
| 10671 | AAA | IEEE 802.11ax (20MHz, MCS0, 90pc duty cycle) | WLAN | 9.09 | ± 9.6 % |
| 10672 | AAA | IEEE 802.11ax (20MHz, MCS1, 90pc duty cycle) | WLAN | 8.57 | ± 9.6 % |
| 10673 | AAA | IEEE 802.11ax (20MHz, MCS2, 90pc duty cycle) | WLAN | 8.78 | ± 9.6 % |
| 10674 | AAA | IEEE 802.11ax (20MHz, MCS3, 90pc duty cycle) | WLAN | 8.74 | ± 9.6 % |
| 10675 | AAA | IEEE 802.11ax (20MHz, MCS4, 90pc duty cycle) | WLAN | 8.90 | ± 9.6 % |
| 10676 | AAA | IEEE 802.11ax (20MHz, MCS5, 90pc duty cycle) | WLAN | 8.77 | ± 9.6 % |
| 10677 | AAA | IEEE 802.11ax (20MHz, MCS6, 90pc duty cycle) | WLAN | 8.73 | ± 9.6 % |
| 10678 | AAA | IEEE 802.11ax (20MHz, MCS7, 90pc duty cycle) | WLAN | 8.78 | ± 9.6 % |
| 10679 | AAA | IEEE 802.11ax (20MHz, MCS8, 90pc duty cycle) | WLAN | 8.89 | ± 9.6 % |
| 10680 | AAA | IEEE 802.11ax (20MHz, MCS9, 90pc duty cycle) | WLAN | 8.80 | ± 9.6 % |
| 10681 | AAA | IEEE 802.11ax (20MHz, MCS10, 90pc duty cycle) | WLAN | 8.62 | ± 9.6 % |
| 10682 | AAA | IEEE 802.11ax (20MHz, MCS11, 90pc duty cycle) | WLAN | 8.83 | ± 9.6 % |
| 10683 | AAA | IEEE 802.11ax (20MHz, MCS0, 99pc duty cycle) | WLAN | 8.42 | ± 9.6 % |
| 10684 | AAA | IEEE 802.11ax (20MHz, MCS1, 99pc duty cycle) | WLAN | 8.26 | ± 9.6 % |
| 10685 | AAA | IEEE 802.11ax (20MHz, MCS2, 99pc duty cycle) | WLAN | 8.33 | ± 9.6 % |
| 10686 | AAA | IEEE 802.11ax (20MHz, MCS3, 99pc duty cycle) | WLAN | 8.28 | ± 9.6 % |
| 10687 | AAA | IEEE 802.11ax (20MHz, MCS4, 99pc duty cycle) | WLAN | 8.45 | ± 9.6 % |
| 10688 | AAA | IEEE 802.11ax (20MHz, MCS5, 99pc duty cycle) | WLAN | 8.29 | ± 9.6 % |
| 10689 | AAA | IEEE 802.11ax (20MHz, MCS6, 99pc duty cycle) | WLAN | 8.55 | ± 9.6 % |
| 10690 | AAA | IEEE 802.11ax (20MHz, MCS7, 99pc duty cycle) | WLAN | 8.29 | ± 9.6 % |
| 10691 | AAA | IEEE 802.11ax (20MHz, MCS8, 99pc duty cycle) | WLAN | 8.25 | ± 9.6 % |
| 10692 | AAA | IEEE 802.11ax (20MHz, MCS9, 99pc duty cycle) | WLAN | 8.29 | ± 9.6 % |
| 10693 | AAA | IEEE 802.11ax (20MHz, MCS10, 99pc duty cycle) | WLAN | 8.25 | ± 9.6 % |
| 10694 | AAA | IEEE 802.11ax (20MHz, MCS11, 99pc duty cycle) | WLAN | 8.57 | ± 9.6 % |
| 10695 | AAA | IEEE 802.11ax (40MHz, MCS0, 90pc duty cycle) | WLAN | 8.78 | ± 9.6 % |
| 10696 | AAA | IEEE 802.11ax (40MHz, MCS1, 90pc duty cycle) | WLAN | 8.91 | ± 9.6 % |
| 10697 | AAA | IEEE 802.11ax (40MHz, MCS2, 90pc duty cycle) | WLAN | 8.61 | ± 9.6 % |
| 10698 | AAA | IEEE 802.11ax (40MHz, MCS3, 90pc duty cycle) | WLAN | 8.89 | ± 9.6 % |
| 10699 | AAA | IEEE 802.11ax (40MHz, MCS4, 90pc duty cycle) | WLAN | 8.82 | ± 9.6 % |
| 10700 | AAA | IEEE 802.11ax (40MHz, MCS5, 90pc duty cycle) | WLAN | 8.73 | ± 9.6 % |
| 10701 | AAA | IEEE 802.11ax (40MHz, MCS6, 90pc duty cycle) | WLAN | 8.86 | ± 9.6 % |
| 10702 | AAA | IEEE 802.11ax (40MHz, MCS7, 90pc duty cycle) | WLAN | 8.70 | ± 9.6 % |
| 10703 | AAA | IEEE 802.11ax (40MHz, MCS8, 90pc duty cycle) | WLAN | 8.82 | ± 9.6 % |
| 10704 | AAA | IEEE 802.11ax (40MHz, MCS9, 90pc duty cycle) | WLAN | 8.56 | ± 9.6 % |
| 10705 | AAA | IEEE 802.11ax (40MHz, MCS10, 90pc duty cycle) | WLAN | 8.69 | ± 9.6 % |
| 10706 | AAA | IEEE 802.11ax (40MHz, MCS11, 90pc duty cycle) | WLAN | 8.66 | ± 9.6 % |
| 10707 | AAA | IEEE 802.11ax (40MHz, MCS0, 99pc duty cycle) | WLAN | 8.32 | ± 9.6 % |
| 10708 | AAA | IEEE 802.11ax (40MHz, MCS1, 99pc duty cycle) | WLAN | 8.55 | ± 9.6 % |
| 10709 | AAA | IEEE 802.11ax (40MHz, MCS2, 99pc duty cycle) | WLAN | 8.33 | ± 9.6 % |
| 10710 | AAA | IEEE 802.11ax (40MHz, MCS3, 99pc duty cycle) | WLAN | 8.29 | ± 9.6 % |
| 10711 | AAA | IEEE 802.11ax (40MHz, MCS4, 99pc duty cycle) | WLAN | 8.39 | ± 9.6 % |
| 10712 | AAA | IEEE 802.11ax (40MHz, MCS5, 99pc duty cycle) | WLAN | 8.67 | ± 9.6 % |
| 10713 | AAA | IEEE 802.11ax (40MHz, MCS6, 99pc duty cycle) | WLAN | 8.33 | ± 9.6 % |
| 10714 | AAA | IEEE 802.11ax (40MHz, MCS7, 99pc duty cycle) | WLAN | 8.26 | ± 9.6 % |
| 10715 | AAA | IEEE 802.11ax (40MHz, MCS8, 99pc duty cycle) | WLAN | 8.45 | ± 9.6 % |
| 10716 | AAA | IEEE 802.11ax (40MHz, MCS9, 99pc duty cycle) | WLAN | 8.30 | ± 9.6 % |
| 10717 | AAA | IEEE 802.11ax (40MHz, MCS10, 99pc duty cycle) | WLAN | 8.48 | ± 9.6 % |
| 10718 | AAA | IEEE 802.11ax (40MHz, MCS11, 99pc duty cycle) | WLAN | 8.24 | ± 9.6 % |
| 10719 | AAA | IEEE 802.11ax (80MHz, MCS0, 90pc duty cycle) | WLAN | 8.81 | ± 9.6 % |
| 10720 | AAA | IEEE 802.11ax (80MHz, MCS1, 90pc duty cycle) | WLAN | 8.87 | ± 9.6 % |
| 10721 | AAA | IEEE 802.11ax (80MHz, MCS2, 90pc duty cycle) | WLAN | 8.76 | ± 9.6 % |
| 10722 | AAA | IEEE 802.11ax (80MHz, MCS3, 90pc duty cycle) | WLAN | 8.55 | ± 9.6 % |
| 10723 | AAA | IEEE 802.11ax (80MHz, MCS4, 90pc duty cycle) | WLAN | 8.70 | ± 9.6 % |
| 10724 | AAA | IEEE 802.11ax (80MHz, MCS5, 90pc duty cycle) | WLAN | 8.90 | ± 9.6 % |
| 10725 | AAA | IEEE 802.11ax (80MHz, MCS6, 90pc duty cycle) | WLAN | 8.74 | ± 9.6 % |
| 10726 | AAA | IEEE 802.11ax (80MHz, MCS7, 90pc duty cycle) | WLAN | 8.72 | ± 9.6 % |
| 10727 | AAA | IEEE 802.11ax (80MHz, MCS8, 90pc duty cycle) | WLAN | 8.66 | ± 9.6 % |

| | | | | | |
|-------|-----|------------------------------------------------|------|------|---------|
| 10728 | AAA | IEEE 802.11ax (80MHz, MCS9, 90pc duty cycle) | WLAN | 8.65 | ± 9.6 % |
| 10729 | AAA | IEEE 802.11ax (80MHz, MCS10, 90pc duty cycle) | WLAN | 8.64 | ± 9.6 % |
| 10730 | AAA | IEEE 802.11ax (80MHz, MCS11, 90pc duty cycle) | WLAN | 8.67 | ± 9.6 % |
| 10731 | AAA | IEEE 802.11ax (80MHz, MCS0, 99pc duty cycle) | WLAN | 8.42 | ± 9.6 % |
| 10732 | AAA | IEEE 802.11ax (80MHz, MCS1, 99pc duty cycle) | WLAN | 8.46 | ± 9.6 % |
| 10733 | AAA | IEEE 802.11ax (80MHz, MCS2, 99pc duty cycle) | WLAN | 8.40 | ± 9.6 % |
| 10734 | AAA | IEEE 802.11ax (80MHz, MCS3, 99pc duty cycle) | WLAN | 8.25 | ± 9.6 % |
| 10735 | AAA | IEEE 802.11ax (80MHz, MCS4, 99pc duty cycle) | WLAN | 8.33 | ± 9.6 % |
| 10736 | AAA | IEEE 802.11ax (80MHz, MCS5, 99pc duty cycle) | WLAN | 8.27 | ± 9.6 % |
| 10737 | AAA | IEEE 802.11ax (80MHz, MCS6, 99pc duty cycle) | WLAN | 8.36 | ± 9.6 % |
| 10738 | AAA | IEEE 802.11ax (80MHz, MCS7, 99pc duty cycle) | WLAN | 8.42 | ± 9.6 % |
| 10739 | AAA | IEEE 802.11ax (80MHz, MCS8, 99pc duty cycle) | WLAN | 8.29 | ± 9.6 % |
| 10740 | AAA | IEEE 802.11ax (80MHz, MCS9, 99pc duty cycle) | WLAN | 8.48 | ± 9.6 % |
| 10741 | AAA | IEEE 802.11ax (80MHz, MCS10, 99pc duty cycle) | WLAN | 8.40 | ± 9.6 % |
| 10742 | AAA | IEEE 802.11ax (80MHz, MCS11, 99pc duty cycle) | WLAN | 8.43 | ± 9.6 % |
| 10743 | AAA | IEEE 802.11ax (160MHz, MCS0, 90pc duty cycle) | WLAN | 8.94 | ± 9.6 % |
| 10744 | AAA | IEEE 802.11ax (160MHz, MCS1, 90pc duty cycle) | WLAN | 9.16 | ± 9.6 % |
| 10745 | AAA | IEEE 802.11ax (160MHz, MCS2, 90pc duty cycle) | WLAN | 8.93 | ± 9.6 % |
| 10746 | AAA | IEEE 802.11ax (160MHz, MCS3, 90pc duty cycle) | WLAN | 9.11 | ± 9.6 % |
| 10747 | AAA | IEEE 802.11ax (160MHz, MCS4, 90pc duty cycle) | WLAN | 9.04 | ± 9.6 % |
| 10748 | AAA | IEEE 802.11ax (160MHz, MCS5, 90pc duty cycle) | WLAN | 8.93 | ± 9.6 % |
| 10749 | AAA | IEEE 802.11ax (160MHz, MCS6, 90pc duty cycle) | WLAN | 8.90 | ± 9.6 % |
| 10750 | AAA | IEEE 802.11ax (160MHz, MCS7, 90pc duty cycle) | WLAN | 8.79 | ± 9.6 % |
| 10751 | AAA | IEEE 802.11ax (160MHz, MCS8, 90pc duty cycle) | WLAN | 8.82 | ± 9.6 % |
| 10752 | AAA | IEEE 802.11ax (160MHz, MCS9, 90pc duty cycle) | WLAN | 8.81 | ± 9.6 % |
| 10753 | AAA | IEEE 802.11ax (160MHz, MCS10, 90pc duty cycle) | WLAN | 9.00 | ± 9.6 % |
| 10754 | AAA | IEEE 802.11ax (160MHz, MCS11, 90pc duty cycle) | WLAN | 8.94 | ± 9.6 % |
| 10755 | AAA | IEEE 802.11ax (160MHz, MCS0, 99pc duty cycle) | WLAN | 8.64 | ± 9.6 % |
| 10756 | AAA | IEEE 802.11ax (160MHz, MCS1, 99pc duty cycle) | WLAN | 8.77 | ± 9.6 % |
| 10757 | AAA | IEEE 802.11ax (160MHz, MCS2, 99pc duty cycle) | WLAN | 8.77 | ± 9.6 % |
| 10758 | AAA | IEEE 802.11ax (160MHz, MCS3, 99pc duty cycle) | WLAN | 8.69 | ± 9.6 % |
| 10759 | AAA | IEEE 802.11ax (160MHz, MCS4, 99pc duty cycle) | WLAN | 8.58 | ± 9.6 % |
| 10760 | AAA | IEEE 802.11ax (160MHz, MCS5, 99pc duty cycle) | WLAN | 8.49 | ± 9.6 % |
| 10761 | AAA | IEEE 802.11ax (160MHz, MCS6, 99pc duty cycle) | WLAN | 8.58 | ± 9.6 % |
| 10762 | AAA | IEEE 802.11ax (160MHz, MCS7, 99pc duty cycle) | WLAN | 8.49 | ± 9.6 % |
| 10763 | AAA | IEEE 802.11ax (160MHz, MCS8, 99pc duty cycle) | WLAN | 8.53 | ± 9.6 % |
| 10764 | AAA | IEEE 802.11ax (160MHz, MCS9, 99pc duty cycle) | WLAN | 8.54 | ± 9.6 % |
| 10765 | AAA | IEEE 802.11ax (160MHz, MCS10, 99pc duty cycle) | WLAN | 8.54 | ± 9.6 % |
| 10766 | AAA | IEEE 802.11ax (160MHz, MCS11, 99pc duty cycle) | WLAN | 8.51 | ± 9.6 % |

^E Uncertainty is determined using the max. deviation from linear response applying rectangular distribution and is expressed for the square of the field value.



Accredited by the Swiss Accreditation Service (SAS)
The Swiss Accreditation Service is one of the signatories to the EA
Multilateral Agreement for the recognition of calibration certificates

Accreditation No.: **SCS 0108**

Client **BV ADT (Auden)**

Certificate No: **EX3-7472_Aug19**

CALIBRATION CERTIFICATE

Object **EX3DV4 - SN:7472**

Calibration procedure(s) **QA CAL-01.v9, QA CAL-14.v5, QA CAL-23.v5, QA CAL-25.v7
Calibration procedure for dosimetric E-field probes**

Calibration date: **August 30, 2019**

This calibration certificate documents the traceability to national standards, which realize the physical units of measurements (SI).
The measurements and the uncertainties with confidence probability are given on the following pages and are part of the certificate.

All calibrations have been conducted in the closed laboratory facility: environment temperature (22 ± 3)°C and humidity < 70%.

Calibration Equipment used (M&TE critical for calibration)

| Primary Standards | ID | Cal Date (Certificate No.) | Scheduled Calibration |
|----------------------------|------------------|-----------------------------------|------------------------|
| Power meter NRP | SN: 104778 | 03-Apr-19 (No. 217-02892/02893) | Apr-20 |
| Power sensor NRP-Z91 | SN: 103244 | 03-Apr-19 (No. 217-02892) | Apr-20 |
| Power sensor NRP-Z91 | SN: 103245 | 03-Apr-19 (No. 217-02893) | Apr-20 |
| Reference 20 dB Attenuator | SN: S5277 (20x) | 04-Apr-19 (No. 217-02894) | Apr-20 |
| DAE4 | SN: 660 | 19-Dec-18 (No. DAE4-660_Dec18) | Dec-19 |
| Reference Probe ES3DV2 | SN: 3013 | 31-Dec-18 (No. ES3-3013_Dec18) | Dec-19 |
| | | | |
| Secondary Standards | ID | Check Date (in house) | Scheduled Check |
| Power meter E4419B | SN: GB41293874 | 06-Apr-16 (in house check Jun-18) | In house check: Jun-20 |
| Power sensor E4412A | SN: MY41498087 | 06-Apr-16 (in house check Jun-18) | In house check: Jun-20 |
| Power sensor E4412A | SN: 000110210 | 06-Apr-16 (in house check Jun-18) | In house check: Jun-20 |
| RF generator HP 8648C | SN: US3642U01700 | 04-Aug-99 (in house check Jun-18) | In house check: Jun-20 |
| Network Analyzer E8358A | SN: US41080477 | 31-Mar-14 (in house check Oct-18) | In house check: Oct-19 |

| | Name | Function | Signature |
|-----------------------------------------------------------------------------------------------------------------|----------------------|------------------------------|-------------------------|
| Calibrated by: | Leif Klysner | Laboratory Technician | |
| Approved by: | Katja Pokovic | Technical Manager | |
| | | | Issued: August 31, 2019 |
| This calibration certificate shall not be reproduced except in full without written approval of the laboratory. | | | |



Accredited by the Swiss Accreditation Service (SAS)

Accreditation No.: **SCS 0108**

The Swiss Accreditation Service is one of the signatories to the EA Multilateral Agreement for the recognition of calibration certificates

Glossary:

| | |
|-----------------------|----------------------------------------------------------------------------------------------------------------------------------|
| TSL | tissue simulating liquid |
| NORM _{x,y,z} | sensitivity in free space |
| ConvF | sensitivity in TSL / NORM _{x,y,z} |
| DCP | diode compression point |
| CF | crest factor (1/duty_cycle) of the RF signal |
| A, B, C, D | modulation dependent linearization parameters |
| Polarization φ | φ rotation around probe axis |
| Polarization ϑ | ϑ rotation around an axis that is in the plane normal to probe axis (at measurement center), i.e., ϑ = 0 is normal to probe axis |
| Connector Angle | information used in DASY system to align probe sensor X to the robot coordinate system |

Calibration is Performed According to the Following Standards:

- a) IEEE Std 1528-2013, "IEEE Recommended Practice for Determining the Peak Spatial-Averaged Specific Absorption Rate (SAR) in the Human Head from Wireless Communications Devices: Measurement Techniques", June 2013
- b) IEC 62209-1, "Measurement procedure for the assessment of Specific Absorption Rate (SAR) from hand-held and body-mounted devices used next to the ear (frequency range of 300 MHz to 6 GHz)", July 2016
- c) IEC 62209-2, "Procedure to determine the Specific Absorption Rate (SAR) for wireless communication devices used in close proximity to the human body (frequency range of 30 MHz to 6 GHz)", March 2010
- d) KDB 865664, "SAR Measurement Requirements for 100 MHz to 6 GHz"

Methods Applied and Interpretation of Parameters:

- *NORM_{x,y,z}*: Assessed for E-field polarization ϑ = 0 (f ≤ 900 MHz in TEM-cell; f > 1800 MHz: R22 waveguide). *NORM_{x,y,z}* are only intermediate values, i.e., the uncertainties of *NORM_{x,y,z}* does not affect the E²-field uncertainty inside TSL (see below *ConvF*).
- *NORM(f)_{x,y,z} = NORM_{x,y,z} * frequency_response* (see Frequency Response Chart). This linearization is implemented in DASY4 software versions later than 4.2. The uncertainty of the frequency response is included in the stated uncertainty of *ConvF*.
- *DCP_{x,y,z}*: DCP are numerical linearization parameters assessed based on the data of power sweep with CW signal (no uncertainty required). DCP does not depend on frequency nor media.
- *PAR*: PAR is the Peak to Average Ratio that is not calibrated but determined based on the signal characteristics
- *A_{x,y,z}; B_{x,y,z}; C_{x,y,z}; D_{x,y,z}; VR_{x,y,z}; A, B, C, D* are numerical linearization parameters assessed based on the data of power sweep for specific modulation signal. The parameters do not depend on frequency nor media. *VR* is the maximum calibration range expressed in RMS voltage across the diode.
- *ConvF and Boundary Effect Parameters*: Assessed in flat phantom using E-field (or Temperature Transfer Standard for f ≤ 800 MHz) and inside waveguide using analytical field distributions based on power measurements for f > 800 MHz. The same setups are used for assessment of the parameters applied for boundary compensation (alpha, depth) of which typical uncertainty values are given. These parameters are used in DASY4 software to improve probe accuracy close to the boundary. The sensitivity in TSL corresponds to *NORM_{x,y,z} * ConvF* whereby the uncertainty corresponds to that given for *ConvF*. A frequency dependent *ConvF* is used in DASY version 4.4 and higher which allows extending the validity from ± 50 MHz to ± 100 MHz.
- *Spherical isotropy (3D deviation from isotropy)*: in a field of low gradients realized using a flat phantom exposed by a patch antenna.
- *Sensor Offset*: The sensor offset corresponds to the offset of virtual measurement center from the probe tip (on probe axis). No tolerance required.
- *Connector Angle*: The angle is assessed using the information gained by determining the *NORM_x* (no uncertainty required).

DASY/EASY - Parameters of Probe: EX3DV4 - SN:7472

Basic Calibration Parameters

| | Sensor X | Sensor Y | Sensor Z | Unc (k=2) |
|-----------------------------------------------------------|----------|----------|----------|-----------|
| Norm ($\mu\text{V}/(\text{V}/\text{m})^2$) ^A | 0.59 | 0.49 | 0.42 | ± 10.1 % |
| DCP (mV) ^B | 97.0 | 97.2 | 97.3 | |

Calibration Results for Modulation Response

| UID | Communication System Name | | A dB | B dB $\sqrt{\mu\text{V}}$ | C | D dB | VR mV | Max dev. | Max Unc ^E (k=2) |
|-----------|-----------------------------|---|---------|------------------------------|-------|---------|----------|-------------|----------------------------------|
| 0 | CW | X | 0.00 | 0.00 | 1.00 | 0.00 | 135.0 | ± 3.0 % | ± 4.7 % |
| | | Y | 0.00 | 0.00 | 1.00 | | 136.2 | | |
| | | Z | 0.00 | 0.00 | 1.00 | | 145.7 | | |
| 10352-AAA | Pulse Waveform (200Hz, 10%) | X | 15.00 | 89.64 | 20.81 | 10.00 | 60.0 | ± 3.6 % | ± 9.6 % |
| | | Y | 6.74 | 75.93 | 14.48 | | 60.0 | | |
| | | Z | 6.82 | 76.61 | 14.71 | | 60.0 | | |
| 10353-AAA | Pulse Waveform (200Hz, 20%) | X | 15.00 | 92.44 | 21.21 | 6.99 | 80.0 | ± 2.0 % | ± 9.6 % |
| | | Y | 15.00 | 84.22 | 15.57 | | 80.0 | | |
| | | Z | 15.00 | 85.59 | 16.35 | | 80.0 | | |
| 10354-AAA | Pulse Waveform (200Hz, 40%) | X | 15.00 | 99.81 | 23.54 | 3.98 | 95.0 | ± 1.2 % | ± 9.6 % |
| | | Y | 15.00 | 82.03 | 12.78 | | 95.0 | | |
| | | Z | 15.00 | 89.26 | 16.67 | | 95.0 | | |
| 10355-AAA | Pulse Waveform (200Hz, 60%) | X | 15.00 | 115.84 | 29.73 | 2.22 | 120.0 | ± 1.2 % | ± 9.6 % |
| | | Y | 0.25 | 60.00 | 3.83 | | 120.0 | | |
| | | Z | 15.00 | 93.72 | 17.46 | | 120.0 | | |
| 10387-AAA | QPSK Waveform, 1 MHz | X | 1.84 | 73.92 | 15.98 | 0.00 | 150.0 | ± 3.3 % | ± 9.6 % |
| | | Y | 0.48 | 60.00 | 6.07 | | 150.0 | | |
| | | Z | 0.51 | 60.00 | 7.01 | | 150.0 | | |
| 10388-AAA | QPSK Waveform, 10 MHz | X | 3.02 | 73.56 | 18.83 | 0.00 | 150.0 | ± 1.1 % | ± 9.6 % |
| | | Y | 2.07 | 68.01 | 15.84 | | 150.0 | | |
| | | Z | 2.10 | 67.77 | 15.67 | | 150.0 | | |
| 10396-AAA | 64-QAM Waveform, 100 kHz | X | 3.27 | 72.09 | 19.97 | 3.01 | 150.0 | ± 1.2 % | ± 9.6 % |
| | | Y | 2.63 | 69.68 | 18.97 | | 150.0 | | |
| | | Z | 2.90 | 71.67 | 19.32 | | 150.0 | | |
| 10399-AAA | 64-QAM Waveform, 40 MHz | X | 3.79 | 68.69 | 16.96 | 0.00 | 150.0 | ± 2.2 % | ± 9.6 % |
| | | Y | 3.51 | 67.51 | 16.12 | | 150.0 | | |
| | | Z | 3.43 | 67.04 | 15.75 | | 150.0 | | |
| 10414-AAA | WLAN CCDF, 64-QAM, 40MHz | X | 5.01 | 66.13 | 16.10 | 0.00 | 150.0 | ± 4.1 % | ± 9.6 % |
| | | Y | 4.82 | 65.99 | 15.91 | | 150.0 | | |
| | | Z | 4.73 | 65.68 | 15.57 | | 150.0 | | |

Note: For details on UID parameters see Appendix

The reported uncertainty of measurement is stated as the standard uncertainty of measurement multiplied by the coverage factor k=2, which for a normal distribution corresponds to a coverage probability of approximately 95%.

^A The uncertainties of Norm X,Y,Z do not affect the E²-field uncertainty inside TSL (see Page 5).

^B Numerical linearization parameter: uncertainty not required.

^E Uncertainty is determined using the max. deviation from linear response applying rectangular distribution and is expressed for the square of the field value.

DASY/EASY - Parameters of Probe: EX3DV4 - SN:7472

Sensor Model Parameters

| | C1 fF | C2 fF | α V ⁻¹ | T1 ms.V ⁻² | T2 ms.V ⁻¹ | T3 ms | T4 V ⁻² | T5 V ⁻¹ | T6 |
|---|----------|----------|-----------------------------|--------------------------|--------------------------|----------|-----------------------|-----------------------|------|
| X | 51.2 | 388.70 | 36.93 | 15.69 | 0.21 | 5.10 | 0.03 | 0.55 | 1.01 |
| Y | 36.9 | 289.61 | 38.78 | 5.03 | 0.18 | 5.07 | 0.00 | 0.40 | 1.01 |
| Z | 36.4 | 270.90 | 35.38 | 6.49 | 0.01 | 5.04 | 2.00 | 0.03 | 1.01 |

Other Probe Parameters

| | |
|-----------------------------------------------|------------|
| Sensor Arrangement | Triangular |
| Connector Angle (°) | 84 |
| Mechanical Surface Detection Mode | enabled |
| Optical Surface Detection Mode | disabled |
| Probe Overall Length | 337 mm |
| Probe Body Diameter | 10 mm |
| Tip Length | 9 mm |
| Tip Diameter | 2.5 mm |
| Probe Tip to Sensor X Calibration Point | 1 mm |
| Probe Tip to Sensor Y Calibration Point | 1 mm |
| Probe Tip to Sensor Z Calibration Point | 1 mm |
| Recommended Measurement Distance from Surface | 1.4 mm |

DASY/EASY - Parameters of Probe: EX3DV4 - SN:7472

Calibration Parameter Determined in Head Tissue Simulating Media

| f (MHz) ^C | Relative Permittivity ^F | Conductivity (S/m) ^F | ConvF X | ConvF Y | ConvF Z | Alpha ^G | Depth ^G (mm) | Unc (k=2) |
|----------------------|------------------------------------|---------------------------------|---------|---------|---------|--------------------|-------------------------|-----------|
| 750 | 41.9 | 0.89 | 10.49 | 10.49 | 10.49 | 0.48 | 0.86 | ± 12.0 % |
| 835 | 41.5 | 0.90 | 10.18 | 10.18 | 10.18 | 0.52 | 0.80 | ± 12.0 % |
| 900 | 41.5 | 0.97 | 9.90 | 9.90 | 9.90 | 0.49 | 0.80 | ± 12.0 % |
| 1450 | 40.5 | 1.20 | 8.96 | 8.96 | 8.96 | 0.35 | 0.80 | ± 12.0 % |
| 1640 | 40.2 | 1.31 | 8.71 | 8.71 | 8.71 | 0.28 | 0.85 | ± 12.0 % |
| 1750 | 40.1 | 1.37 | 8.68 | 8.68 | 8.68 | 0.30 | 0.85 | ± 12.0 % |
| 1900 | 40.0 | 1.40 | 8.34 | 8.34 | 8.34 | 0.30 | 0.85 | ± 12.0 % |
| 2000 | 40.0 | 1.40 | 8.37 | 8.37 | 8.37 | 0.32 | 0.84 | ± 12.0 % |
| 2300 | 39.5 | 1.67 | 8.11 | 8.11 | 8.11 | 0.25 | 0.95 | ± 12.0 % |
| 2450 | 39.2 | 1.80 | 7.70 | 7.70 | 7.70 | 0.33 | 0.95 | ± 12.0 % |
| 2600 | 39.0 | 1.96 | 7.64 | 7.64 | 7.64 | 0.33 | 0.95 | ± 12.0 % |
| 3300 | 38.2 | 2.71 | 7.25 | 7.25 | 7.25 | 0.35 | 1.30 | ± 13.1 % |
| 3500 | 37.9 | 2.91 | 7.21 | 7.21 | 7.21 | 0.35 | 1.30 | ± 13.1 % |
| 3700 | 37.7 | 3.12 | 7.11 | 7.11 | 7.11 | 0.35 | 1.35 | ± 13.1 % |
| 3900 | 37.5 | 3.32 | 6.81 | 6.81 | 6.81 | 0.40 | 1.60 | ± 13.1 % |
| 4100 | 37.2 | 3.53 | 6.57 | 6.57 | 6.57 | 0.40 | 1.60 | ± 13.1 % |
| 4200 | 37.1 | 3.63 | 6.53 | 6.53 | 6.53 | 0.40 | 1.60 | ± 13.1 % |
| 4400 | 36.9 | 3.84 | 6.31 | 6.31 | 6.31 | 0.40 | 1.70 | ± 13.1 % |
| 4600 | 36.7 | 4.04 | 6.27 | 6.27 | 6.27 | 0.40 | 1.80 | ± 13.1 % |
| 4800 | 36.4 | 4.25 | 6.16 | 6.16 | 6.16 | 0.40 | 1.80 | ± 13.1 % |
| 4950 | 36.3 | 4.40 | 5.90 | 5.90 | 5.90 | 0.40 | 1.80 | ± 13.1 % |
| 5250 | 35.9 | 4.71 | 5.67 | 5.67 | 5.67 | 0.40 | 1.80 | ± 13.1 % |
| 5600 | 35.5 | 5.07 | 5.10 | 5.10 | 5.10 | 0.40 | 1.80 | ± 13.1 % |
| 5750 | 35.4 | 5.22 | 5.23 | 5.23 | 5.23 | 0.40 | 1.80 | ± 13.1 % |

^C Frequency validity above 300 MHz of ± 100 MHz only applies for DASY v4.4 and higher (see Page 2), else it is restricted to ± 50 MHz. The uncertainty is the RSS of the ConvF uncertainty at calibration frequency and the uncertainty for the indicated frequency band. Frequency validity below 300 MHz is ± 10, 25, 40, 50 and 70 MHz for ConvF assessments at 30, 64, 128, 150 and 220 MHz respectively. Validity of ConvF assessed at 6 MHz is 4-9 MHz, and ConvF assessed at 13 MHz is 9-19 MHz. Above 5 GHz frequency validity can be extended to ± 110 MHz.

^F At frequencies below 3 GHz, the validity of tissue parameters (ϵ and σ) can be relaxed to ± 10% if liquid compensation formula is applied to measured SAR values. At frequencies above 3 GHz, the validity of tissue parameters (ϵ and σ) is restricted to ± 5%. The uncertainty is the RSS of the ConvF uncertainty for indicated target tissue parameters.

^G Alpha/Depth are determined during calibration. SPEAG warrants that the remaining deviation due to the boundary effect after compensation is always less than ± 1% for frequencies below 3 GHz and below ± 2% for frequencies between 3-6 GHz at any distance larger than half the probe tip diameter from the boundary.

Frequency Response of E-Field (TEM-Cell:ifi110 EXX, Waveguide: R22)

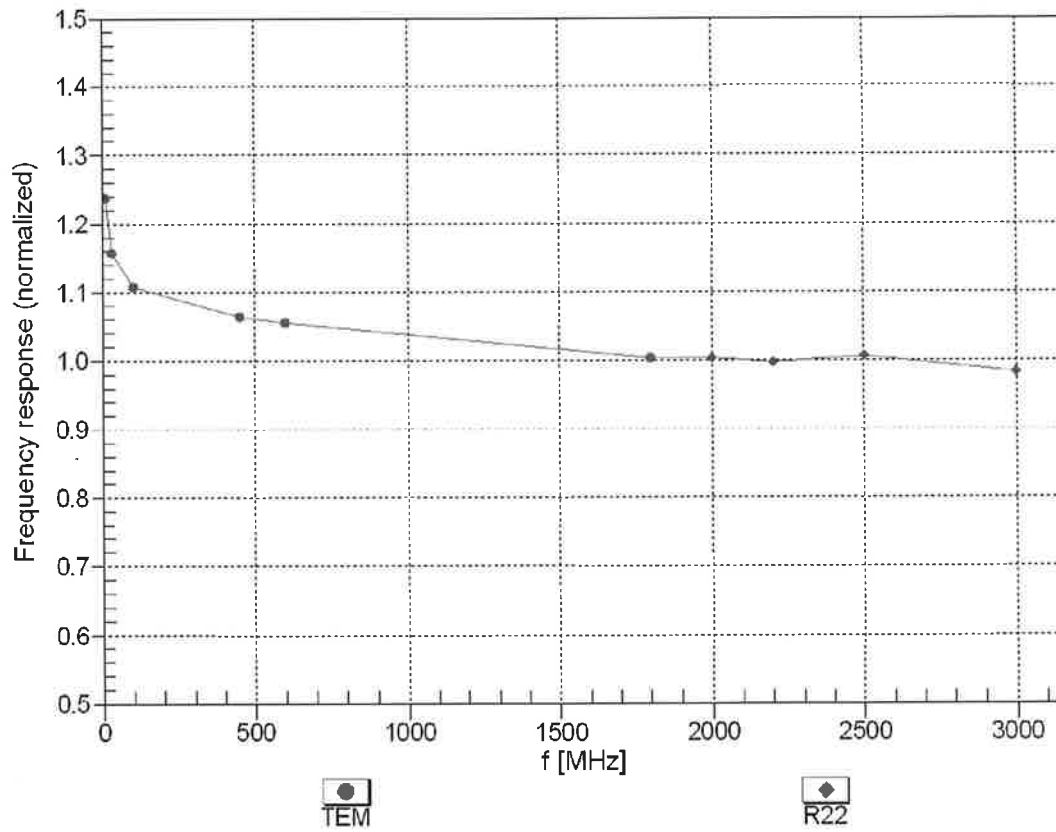

Uncertainty of Frequency Response of E-field: $\pm 6.3\%$ (k=2)

Receiving Pattern (ϕ), $\theta = 0^\circ$

f=600 MHz,TEM

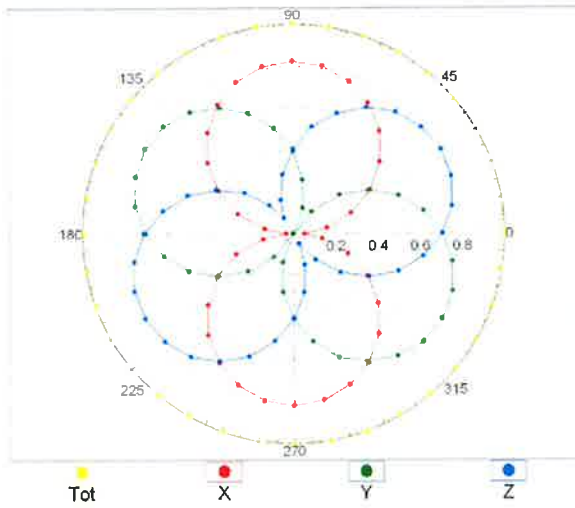

f=1800 MHz,R22

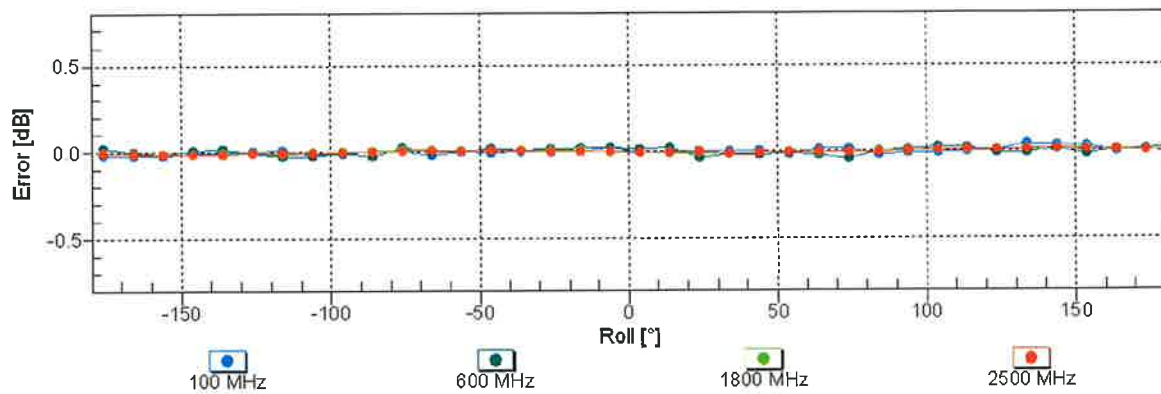
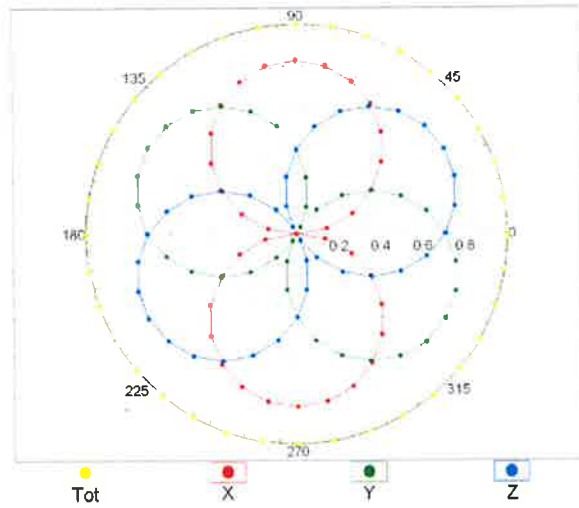

Uncertainty of Axial Isotropy Assessment: $\pm 0.5\%$ (k=2)

Dynamic Range $f(\text{SAR}_{\text{head}})$ (TEM cell , $f_{\text{eval}}= 1900 \text{ MHz}$)

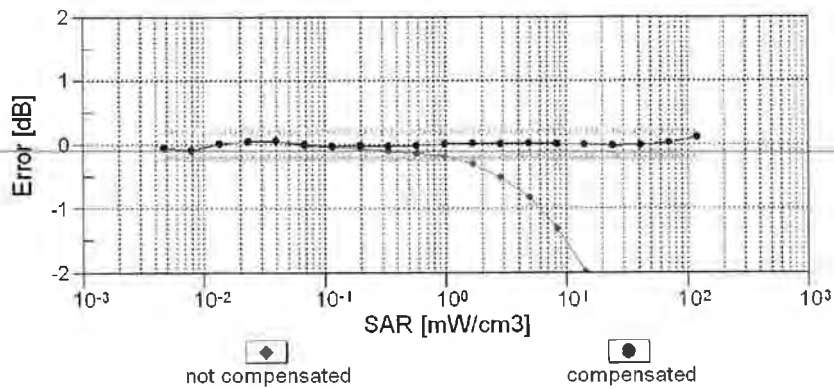
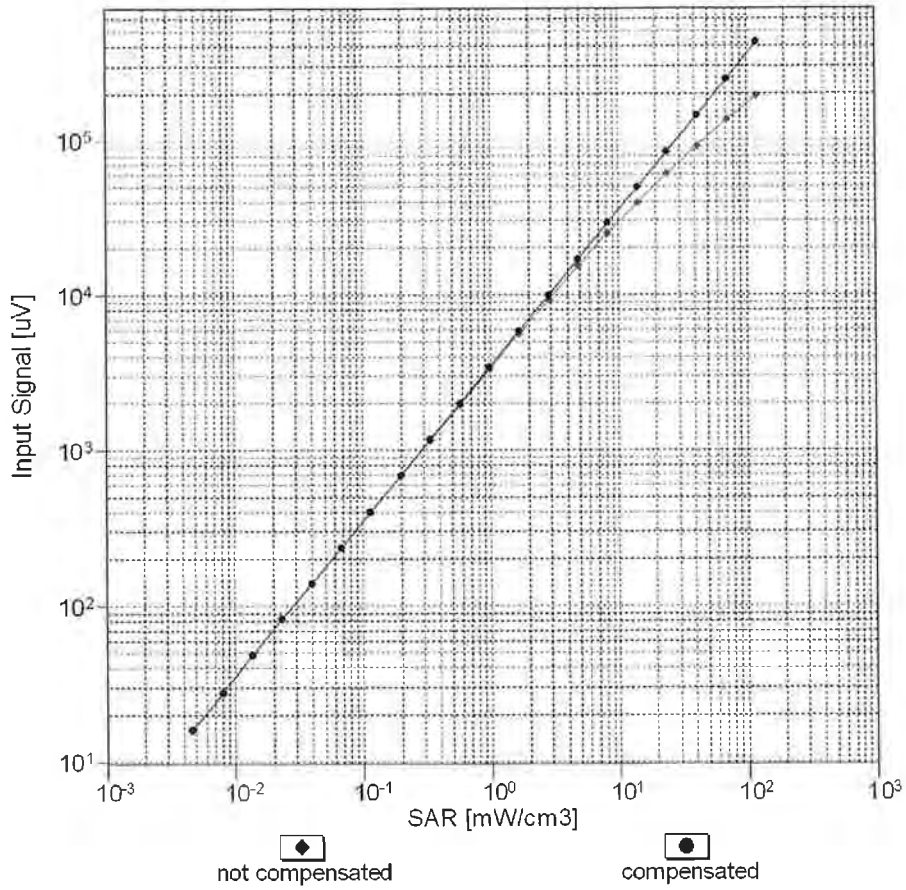

Uncertainty of Linearity Assessment: $\pm 0.6\%$ (k=2)

Conversion Factor Assessment

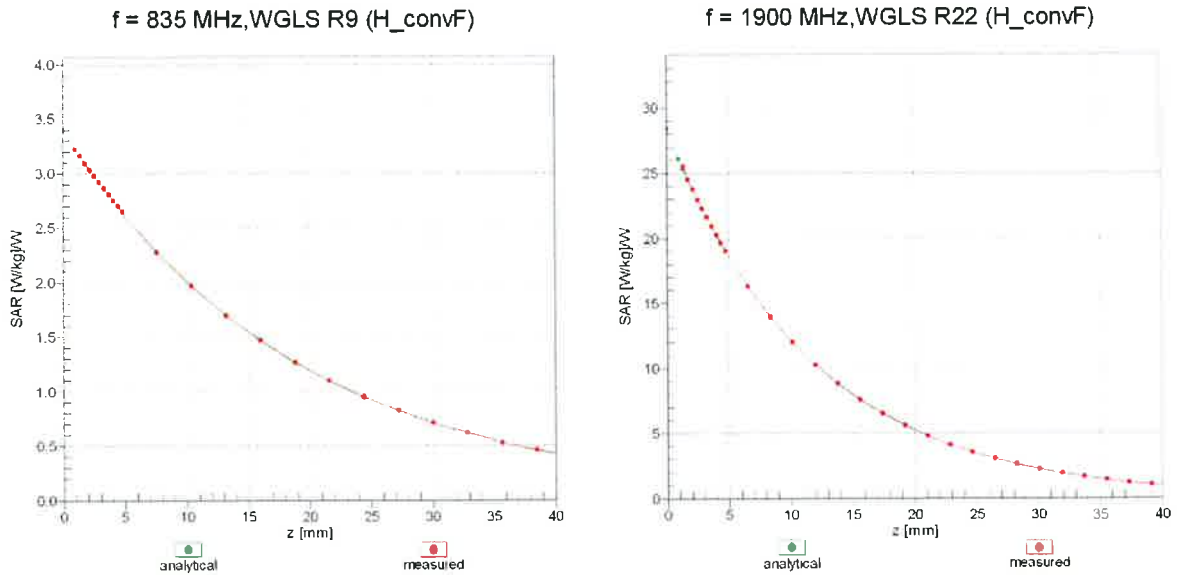

Deviation from Isotropy in Liquid Error (ϕ, ϑ), f = 900 MHz

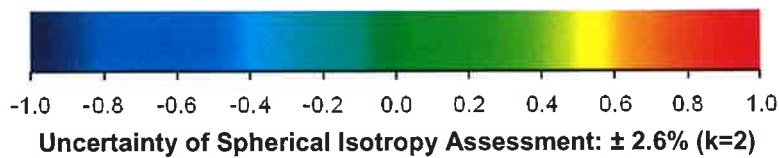
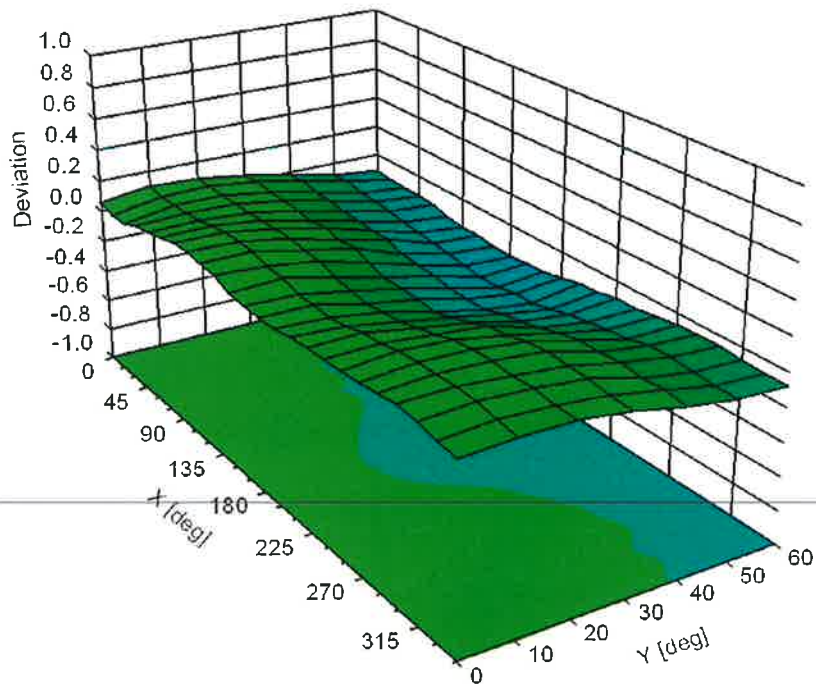

Appendix: Modulation Calibration Parameters

| UID | Rev | Communication System Name | Group | PAR (dB) | Unc ^E (k=2) |
|-------|-----|-----------------------------------------------------|-----------|----------|------------------------|
| 0 | | CW | CW | 0.00 | ± 4.7 % |
| 10010 | CAA | SAR Validation (Square, 100ms, 10ms) | Test | 10.00 | ± 9.6 % |
| 10011 | CAB | UMTS-FDD (WCDMA) | WCDMA | 2.91 | ± 9.6 % |
| 10012 | CAB | IEEE 802.11b WiFi 2.4 GHz (DSSS, 1 Mbps) | WLAN | 1.87 | ± 9.6 % |
| 10013 | CAB | IEEE 802.11g WiFi 2.4 GHz (DSSS-OFDM, 6 Mbps) | WLAN | 9.46 | ± 9.6 % |
| 10021 | DAC | GSM-FDD (TDMA, GMSK) | GSM | 9.39 | ± 9.6 % |
| 10023 | DAC | GPRS-FDD (TDMA, GMSK, TN 0) | GSM | 9.57 | ± 9.6 % |
| 10024 | DAC | GPRS-FDD (TDMA, GMSK, TN 0-1) | GSM | 6.56 | ± 9.6 % |
| 10025 | DAC | EDGE-FDD (TDMA, 8PSK, TN 0) | GSM | 12.62 | ± 9.6 % |
| 10026 | DAC | EDGE-FDD (TDMA, 8PSK, TN 0-1) | GSM | 9.55 | ± 9.6 % |
| 10027 | DAC | GPRS-FDD (TDMA, GMSK, TN 0-1-2) | GSM | 4.80 | ± 9.6 % |
| 10028 | DAC | GPRS-FDD (TDMA, GMSK, TN 0-1-2-3) | GSM | 3.55 | ± 9.6 % |
| 10029 | DAC | EDGE-FDD (TDMA, 8PSK, TN 0-1-2) | GSM | 7.78 | ± 9.6 % |
| 10030 | CAA | IEEE 802.15.1 Bluetooth (GFSK, DH1) | Bluetooth | 5.30 | ± 9.6 % |
| 10031 | CAA | IEEE 802.15.1 Bluetooth (GFSK, DH3) | Bluetooth | 1.87 | ± 9.6 % |
| 10032 | CAA | IEEE 802.15.1 Bluetooth (GFSK, DH5) | Bluetooth | 1.16 | ± 9.6 % |
| 10033 | CAA | IEEE 802.15.1 Bluetooth (PI/4-DQPSK, DH1) | Bluetooth | 7.74 | ± 9.6 % |
| 10034 | CAA | IEEE 802.15.1 Bluetooth (PI/4-DQPSK, DH3) | Bluetooth | 4.53 | ± 9.6 % |
| 10035 | CAA | IEEE 802.15.1 Bluetooth (PI/4-DQPSK, DH5) | Bluetooth | 3.83 | ± 9.6 % |
| 10036 | CAA | IEEE 802.15.1 Bluetooth (8-DPSK, DH1) | Bluetooth | 8.01 | ± 9.6 % |
| 10037 | CAA | IEEE 802.15.1 Bluetooth (8-DPSK, DH3) | Bluetooth | 4.77 | ± 9.6 % |
| 10038 | CAA | IEEE 802.15.1 Bluetooth (8-DPSK, DH5) | Bluetooth | 4.10 | ± 9.6 % |
| 10039 | CAB | CDMA2000 (1xRTT, RC1) | CDMA2000 | 4.57 | ± 9.6 % |
| 10042 | CAB | IS-54 / IS-136 FDD (TDMA/FDM, PI/4-DQPSK, Halfrate) | AMPS | 7.78 | ± 9.6 % |
| 10044 | CAA | IS-91/EIA/TIA-553 FDD (FDMA, FM) | AMPS | 0.00 | ± 9.6 % |
| 10048 | CAA | DECT (TDD, TDMA/FDM, GFSK, Full Slot, 24) | DECT | 13.80 | ± 9.6 % |
| 10049 | CAA | DECT (TDD, TDMA/FDM, GFSK, Double Slot, 12) | DECT | 10.79 | ± 9.6 % |
| 10056 | CAA | UMTS-TDD (TD-SCDMA, 1.28 Mcps) | TD-SCDMA | 11.01 | ± 9.6 % |
| 10058 | DAC | EDGE-FDD (TDMA, 8PSK, TN 0-1-2-3) | GSM | 6.52 | ± 9.6 % |
| 10059 | CAB | IEEE 802.11b WiFi 2.4 GHz (DSSS, 2 Mbps) | WLAN | 2.12 | ± 9.6 % |
| 10060 | CAB | IEEE 802.11b WiFi 2.4 GHz (DSSS, 5.5 Mbps) | WLAN | 2.83 | ± 9.6 % |
| 10061 | CAB | IEEE 802.11b WiFi 2.4 GHz (DSSS, 11 Mbps) | WLAN | 3.60 | ± 9.6 % |
| 10062 | CAC | IEEE 802.11a/h WiFi 5 GHz (OFDM, 6 Mbps) | WLAN | 8.68 | ± 9.6 % |
| 10063 | CAC | IEEE 802.11a/h WiFi 5 GHz (OFDM, 9 Mbps) | WLAN | 8.63 | ± 9.6 % |
| 10064 | CAC | IEEE 802.11a/h WiFi 5 GHz (OFDM, 12 Mbps) | WLAN | 9.09 | ± 9.6 % |
| 10065 | CAC | IEEE 802.11a/h WiFi 5 GHz (OFDM, 18 Mbps) | WLAN | 9.00 | ± 9.6 % |
| 10066 | CAC | IEEE 802.11a/h WiFi 5 GHz (OFDM, 24 Mbps) | WLAN | 9.38 | ± 9.6 % |
| 10067 | CAC | IEEE 802.11a/h WiFi 5 GHz (OFDM, 36 Mbps) | WLAN | 10.12 | ± 9.6 % |
| 10068 | CAC | IEEE 802.11a/h WiFi 5 GHz (OFDM, 48 Mbps) | WLAN | 10.24 | ± 9.6 % |
| 10069 | CAC | IEEE 802.11a/h WiFi 5 GHz (OFDM, 54 Mbps) | WLAN | 10.56 | ± 9.6 % |
| 10071 | CAB | IEEE 802.11g WiFi 2.4 GHz (DSSS/OFDM, 9 Mbps) | WLAN | 9.83 | ± 9.6 % |
| 10072 | CAB | IEEE 802.11g WiFi 2.4 GHz (DSSS/OFDM, 12 Mbps) | WLAN | 9.62 | ± 9.6 % |
| 10073 | CAB | IEEE 802.11g WiFi 2.4 GHz (DSSS/OFDM, 18 Mbps) | WLAN | 9.94 | ± 9.6 % |
| 10074 | CAB | IEEE 802.11g WiFi 2.4 GHz (DSSS/OFDM, 24 Mbps) | WLAN | 10.30 | ± 9.6 % |
| 10075 | CAB | IEEE 802.11g WiFi 2.4 GHz (DSSS/OFDM, 36 Mbps) | WLAN | 10.77 | ± 9.6 % |
| 10076 | CAB | IEEE 802.11g WiFi 2.4 GHz (DSSS/OFDM, 48 Mbps) | WLAN | 10.94 | ± 9.6 % |
| 10077 | CAB | IEEE 802.11g WiFi 2.4 GHz (DSSS/OFDM, 54 Mbps) | WLAN | 11.00 | ± 9.6 % |
| 10081 | CAB | CDMA2000 (1xRTT, RC3) | CDMA2000 | 3.97 | ± 9.6 % |
| 10082 | CAB | IS-54 / IS-136 FDD (TDMA/FDM, PI/4-DQPSK, Fullrate) | AMPS | 4.77 | ± 9.6 % |
| 10090 | DAC | GPRS-FDD (TDMA, GMSK, TN 0-4) | GSM | 6.56 | ± 9.6 % |
| 10097 | CAB | UMTS-FDD (HSDPA) | WCDMA | 3.98 | ± 9.6 % |
| 10098 | CAB | UMTS-FDD (HSUPA, Subtest 2) | WCDMA | 3.98 | ± 9.6 % |
| 10099 | DAC | EDGE-FDD (TDMA, 8PSK, TN 0-4) | GSM | 9.55 | ± 9.6 % |
| 10100 | CAE | LTE-FDD (SC-FDMA, 100% RB, 20 MHz, QPSK) | LTE-FDD | 5.67 | ± 9.6 % |
| 10101 | CAE | LTE-FDD (SC-FDMA, 100% RB, 20 MHz, 16-QAM) | LTE-FDD | 6.42 | ± 9.6 % |
| 10102 | CAE | LTE-FDD (SC-FDMA, 100% RB, 20 MHz, 64-QAM) | LTE-FDD | 6.60 | ± 9.6 % |
| 10103 | CAG | LTE-TDD (SC-FDMA, 100% RB, 20 MHz, QPSK) | LTE-TDD | 9.29 | ± 9.6 % |
| 10104 | CAG | LTE-TDD (SC-FDMA, 100% RB, 20 MHz, 16-QAM) | LTE-TDD | 9.97 | ± 9.6 % |
| 10105 | CAG | LTE-TDD (SC-FDMA, 100% RB, 20 MHz, 64-QAM) | LTE-TDD | 10.01 | ± 9.6 % |
| 10108 | CAG | LTE-FDD (SC-FDMA, 100% RB, 10 MHz, QPSK) | LTE-FDD | 5.80 | ± 9.6 % |

| | | | | | |
|-------|-----|------------------------------------------------|---------|-------|---------|
| 10109 | CAG | LTE-FDD (SC-FDMA, 100% RB, 10 MHz, 16-QAM) | LTE-FDD | 6.43 | ± 9.6 % |
| 10110 | CAG | LTE-FDD (SC-FDMA, 100% RB, 5 MHz, QPSK) | LTE-FDD | 5.75 | ± 9.6 % |
| 10111 | CAG | LTE-FDD (SC-FDMA, 100% RB, 5 MHz, 16-QAM) | LTE-FDD | 6.44 | ± 9.6 % |
| 10112 | CAG | LTE-FDD (SC-FDMA, 100% RB, 10 MHz, 64-QAM) | LTE-FDD | 6.59 | ± 9.6 % |
| 10113 | CAG | LTE-FDD (SC-FDMA, 100% RB, 5 MHz, 64-QAM) | LTE-FDD | 6.62 | ± 9.6 % |
| 10114 | CAC | IEEE 802.11n (HT Greenfield, 13.5 Mbps, BPSK) | WLAN | 8.10 | ± 9.6 % |
| 10115 | CAC | IEEE 802.11n (HT Greenfield, 81 Mbps, 16-QAM) | WLAN | 8.46 | ± 9.6 % |
| 10116 | CAC | IEEE 802.11n (HT Greenfield, 135 Mbps, 64-QAM) | WLAN | 8.15 | ± 9.6 % |
| 10117 | CAC | IEEE 802.11n (HT Mixed, 13.5 Mbps, BPSK) | WLAN | 8.07 | ± 9.6 % |
| 10118 | CAC | IEEE 802.11n (HT Mixed, 81 Mbps, 16-QAM) | WLAN | 8.59 | ± 9.6 % |
| 10119 | CAC | IEEE 802.11n (HT Mixed, 135 Mbps, 64-QAM) | WLAN | 8.13 | ± 9.6 % |
| 10140 | CAE | LTE-FDD (SC-FDMA, 100% RB, 15 MHz, 16-QAM) | LTE-FDD | 6.49 | ± 9.6 % |
| 10141 | CAE | LTE-FDD (SC-FDMA, 100% RB, 15 MHz, 64-QAM) | LTE-FDD | 6.53 | ± 9.6 % |
| 10142 | CAE | LTE-FDD (SC-FDMA, 100% RB, 3 MHz, QPSK) | LTE-FDD | 5.73 | ± 9.6 % |
| 10143 | CAE | LTE-FDD (SC-FDMA, 100% RB, 3 MHz, 16-QAM) | LTE-FDD | 6.35 | ± 9.6 % |
| 10144 | CAE | LTE-FDD (SC-FDMA, 100% RB, 3 MHz, 64-QAM) | LTE-FDD | 6.65 | ± 9.6 % |
| 10145 | CAF | LTE-FDD (SC-FDMA, 100% RB, 1.4 MHz, QPSK) | LTE-FDD | 5.76 | ± 9.6 % |
| 10146 | CAF | LTE-FDD (SC-FDMA, 100% RB, 1.4 MHz, 16-QAM) | LTE-FDD | 6.41 | ± 9.6 % |
| 10147 | CAF | LTE-FDD (SC-FDMA, 100% RB, 1.4 MHz, 64-QAM) | LTE-FDD | 6.72 | ± 9.6 % |
| 10149 | CAE | LTE-FDD (SC-FDMA, 50% RB, 20 MHz, 16-QAM) | LTE-FDD | 6.42 | ± 9.6 % |
| 10150 | CAE | LTE-FDD (SC-FDMA, 50% RB, 20 MHz, 64-QAM) | LTE-FDD | 6.60 | ± 9.6 % |
| 10151 | CAG | LTE-TDD (SC-FDMA, 50% RB, 20 MHz, QPSK) | LTE-TDD | 9.28 | ± 9.6 % |
| 10152 | CAG | LTE-TDD (SC-FDMA, 50% RB, 20 MHz, 16-QAM) | LTE-TDD | 9.92 | ± 9.6 % |
| 10153 | CAG | LTE-TDD (SC-FDMA, 50% RB, 20 MHz, 64-QAM) | LTE-TDD | 10.05 | ± 9.6 % |
| 10154 | CAG | LTE-FDD (SC-FDMA, 50% RB, 10 MHz, QPSK) | LTE-FDD | 5.75 | ± 9.6 % |
| 10155 | CAG | LTE-FDD (SC-FDMA, 50% RB, 10 MHz, 16-QAM) | LTE-FDD | 6.43 | ± 9.6 % |
| 10156 | CAG | LTE-FDD (SC-FDMA, 50% RB, 5 MHz, QPSK) | LTE-FDD | 5.79 | ± 9.6 % |
| 10157 | CAG | LTE-FDD (SC-FDMA, 50% RB, 5 MHz, 16-QAM) | LTE-FDD | 6.49 | ± 9.6 % |
| 10158 | CAG | LTE-FDD (SC-FDMA, 50% RB, 10 MHz, 64-QAM) | LTE-FDD | 6.62 | ± 9.6 % |
| 10159 | CAG | LTE-FDD (SC-FDMA, 50% RB, 5 MHz, 64-QAM) | LTE-FDD | 6.56 | ± 9.6 % |
| 10160 | CAE | LTE-FDD (SC-FDMA, 50% RB, 15 MHz, QPSK) | LTE-FDD | 5.82 | ± 9.6 % |
| 10161 | CAE | LTE-FDD (SC-FDMA, 50% RB, 15 MHz, 16-QAM) | LTE-FDD | 6.43 | ± 9.6 % |
| 10162 | CAE | LTE-FDD (SC-FDMA, 50% RB, 15 MHz, 64-QAM) | LTE-FDD | 6.58 | ± 9.6 % |
| 10166 | CAF | LTE-FDD (SC-FDMA, 50% RB, 1.4 MHz, QPSK) | LTE-FDD | 5.46 | ± 9.6 % |
| 10167 | CAF | LTE-FDD (SC-FDMA, 50% RB, 1.4 MHz, 16-QAM) | LTE-FDD | 6.21 | ± 9.6 % |
| 10168 | CAF | LTE-FDD (SC-FDMA, 50% RB, 1.4 MHz, 64-QAM) | LTE-FDD | 6.79 | ± 9.6 % |
| 10169 | CAE | LTE-FDD (SC-FDMA, 1 RB, 20 MHz, QPSK) | LTE-FDD | 5.73 | ± 9.6 % |
| 10170 | CAE | LTE-FDD (SC-FDMA, 1 RB, 20 MHz, 16-QAM) | LTE-FDD | 6.52 | ± 9.6 % |
| 10171 | AAE | LTE-FDD (SC-FDMA, 1 RB, 20 MHz, 64-QAM) | LTE-FDD | 6.49 | ± 9.6 % |
| 10172 | CAG | LTE-TDD (SC-FDMA, 1 RB, 20 MHz, QPSK) | LTE-TDD | 9.21 | ± 9.6 % |
| 10173 | CAG | LTE-TDD (SC-FDMA, 1 RB, 20 MHz, 16-QAM) | LTE-TDD | 9.48 | ± 9.6 % |
| 10174 | CAG | LTE-TDD (SC-FDMA, 1 RB, 20 MHz, 64-QAM) | LTE-TDD | 10.25 | ± 9.6 % |
| 10175 | CAG | LTE-FDD (SC-FDMA, 1 RB, 10 MHz, QPSK) | LTE-FDD | 5.72 | ± 9.6 % |
| 10176 | CAG | LTE-FDD (SC-FDMA, 1 RB, 10 MHz, 16-QAM) | LTE-FDD | 6.52 | ± 9.6 % |
| 10177 | CAI | LTE-FDD (SC-FDMA, 1 RB, 5 MHz, QPSK) | LTE-FDD | 5.73 | ± 9.6 % |
| 10178 | CAG | LTE-FDD (SC-FDMA, 1 RB, 5 MHz, 16-QAM) | LTE-FDD | 6.52 | ± 9.6 % |
| 10179 | CAG | LTE-FDD (SC-FDMA, 1 RB, 10 MHz, 64-QAM) | LTE-FDD | 6.50 | ± 9.6 % |
| 10180 | CAG | LTE-FDD (SC-FDMA, 1 RB, 5 MHz, 64-QAM) | LTE-FDD | 6.50 | ± 9.6 % |
| 10181 | CAE | LTE-FDD (SC-FDMA, 1 RB, 15 MHz, QPSK) | LTE-FDD | 5.72 | ± 9.6 % |
| 10182 | CAE | LTE-FDD (SC-FDMA, 1 RB, 15 MHz, 16-QAM) | LTE-FDD | 6.52 | ± 9.6 % |
| 10183 | AAD | LTE-FDD (SC-FDMA, 1 RB, 15 MHz, 64-QAM) | LTE-FDD | 6.50 | ± 9.6 % |
| 10184 | CAE | LTE-FDD (SC-FDMA, 1 RB, 3 MHz, QPSK) | LTE-FDD | 5.73 | ± 9.6 % |
| 10185 | CAE | LTE-FDD (SC-FDMA, 1 RB, 3 MHz, 16-QAM) | LTE-FDD | 6.51 | ± 9.6 % |
| 10186 | AAE | LTE-FDD (SC-FDMA, 1 RB, 3 MHz, 64-QAM) | LTE-FDD | 6.50 | ± 9.6 % |
| 10187 | CAF | LTE-FDD (SC-FDMA, 1 RB, 1.4 MHz, QPSK) | LTE-FDD | 5.73 | ± 9.6 % |
| 10188 | CAF | LTE-FDD (SC-FDMA, 1 RB, 1.4 MHz, 16-QAM) | LTE-FDD | 6.52 | ± 9.6 % |
| 10189 | AAF | LTE-FDD (SC-FDMA, 1 RB, 1.4 MHz, 64-QAM) | LTE-FDD | 6.50 | ± 9.6 % |
| 10193 | CAC | IEEE 802.11n (HT Greenfield, 6.5 Mbps, BPSK) | WLAN | 8.09 | ± 9.6 % |
| 10194 | CAC | IEEE 802.11n (HT Greenfield, 39 Mbps, 16-QAM) | WLAN | 8.12 | ± 9.6 % |
| 10195 | CAC | IEEE 802.11n (HT Greenfield, 65 Mbps, 64-QAM) | WLAN | 8.21 | ± 9.6 % |
| 10196 | CAC | IEEE 802.11n (HT Mixed, 6.5 Mbps, BPSK) | WLAN | 8.10 | ± 9.6 % |
| 10197 | CAC | IEEE 802.11n (HT Mixed, 39 Mbps, 16-QAM) | WLAN | 8.13 | ± 9.6 % |
| 10198 | CAC | IEEE 802.11n (HT Mixed, 65 Mbps, 64-QAM) | WLAN | 8.27 | ± 9.6 % |
| 10219 | CAC | IEEE 802.11n (HT Mixed, 7.2 Mbps, BPSK) | WLAN | 8.03 | ± 9.6 % |

| | | | | | |
|-------|-----|---------------------------------------------|----------|-------|---------|
| 10220 | CAC | IEEE 802.11n (HT Mixed, 43.3 Mbps, 16-QAM) | WLAN | 8.13 | ± 9.6 % |
| 10221 | CAC | IEEE 802.11n (HT Mixed, 72.2 Mbps, 64-QAM) | WLAN | 8.27 | ± 9.6 % |
| 10222 | CAC | IEEE 802.11n (HT Mixed, 15 Mbps, BPSK) | WLAN | 8.06 | ± 9.6 % |
| 10223 | CAC | IEEE 802.11n (HT Mixed, 90 Mbps, 16-QAM) | WLAN | 8.48 | ± 9.6 % |
| 10224 | CAC | IEEE 802.11n (HT Mixed, 150 Mbps, 64-QAM) | WLAN | 8.08 | ± 9.6 % |
| 10225 | CAB | UMTS-FDD (HSPA+) | WCDMA | 5.97 | ± 9.6 % |
| 10226 | CAB | LTE-TDD (SC-FDMA, 1 RB, 1.4 MHz, 16-QAM) | LTE-TDD | 9.49 | ± 9.6 % |
| 10227 | CAB | LTE-TDD (SC-FDMA, 1 RB, 1.4 MHz, 64-QAM) | LTE-TDD | 10.26 | ± 9.6 % |
| 10228 | CAB | LTE-TDD (SC-FDMA, 1 RB, 1.4 MHz, QPSK) | LTE-TDD | 9.22 | ± 9.6 % |
| 10229 | CAD | LTE-TDD (SC-FDMA, 1 RB, 3 MHz, 16-QAM) | LTE-TDD | 9.48 | ± 9.6 % |
| 10230 | CAD | LTE-TDD (SC-FDMA, 1 RB, 3 MHz, 64-QAM) | LTE-TDD | 10.25 | ± 9.6 % |
| 10231 | CAD | LTE-TDD (SC-FDMA, 1 RB, 3 MHz, QPSK) | LTE-TDD | 9.19 | ± 9.6 % |
| 10232 | CAG | LTE-TDD (SC-FDMA, 1 RB, 5 MHz, 16-QAM) | LTE-TDD | 9.48 | ± 9.6 % |
| 10233 | CAG | LTE-TDD (SC-FDMA, 1 RB, 5 MHz, 64-QAM) | LTE-TDD | 10.25 | ± 9.6 % |
| 10234 | CAG | LTE-TDD (SC-FDMA, 1 RB, 5 MHz, QPSK) | LTE-TDD | 9.21 | ± 9.6 % |
| 10235 | CAG | LTE-TDD (SC-FDMA, 1 RB, 10 MHz, 16-QAM) | LTE-TDD | 9.48 | ± 9.6 % |
| 10236 | CAG | LTE-TDD (SC-FDMA, 1 RB, 10 MHz, 64-QAM) | LTE-TDD | 10.25 | ± 9.6 % |
| 10237 | CAG | LTE-TDD (SC-FDMA, 1 RB, 10 MHz, QPSK) | LTE-TDD | 9.21 | ± 9.6 % |
| 10238 | CAF | LTE-TDD (SC-FDMA, 1 RB, 15 MHz, 16-QAM) | LTE-TDD | 9.48 | ± 9.6 % |
| 10239 | CAF | LTE-TDD (SC-FDMA, 1 RB, 15 MHz, 64-QAM) | LTE-TDD | 10.25 | ± 9.6 % |
| 10240 | CAF | LTE-TDD (SC-FDMA, 1 RB, 15 MHz, QPSK) | LTE-TDD | 9.21 | ± 9.6 % |
| 10241 | CAB | LTE-TDD (SC-FDMA, 50% RB, 1.4 MHz, 16-QAM) | LTE-TDD | 9.82 | ± 9.6 % |
| 10242 | CAB | LTE-TDD (SC-FDMA, 50% RB, 1.4 MHz, 64-QAM) | LTE-TDD | 9.86 | ± 9.6 % |
| 10243 | CAB | LTE-TDD (SC-FDMA, 50% RB, 1.4 MHz, QPSK) | LTE-TDD | 9.46 | ± 9.6 % |
| 10244 | CAD | LTE-TDD (SC-FDMA, 50% RB, 3 MHz, 16-QAM) | LTE-TDD | 10.06 | ± 9.6 % |
| 10245 | CAD | LTE-TDD (SC-FDMA, 50% RB, 3 MHz, 64-QAM) | LTE-TDD | 10.06 | ± 9.6 % |
| 10246 | CAD | LTE-TDD (SC-FDMA, 50% RB, 3 MHz, QPSK) | LTE-TDD | 9.30 | ± 9.6 % |
| 10247 | CAG | LTE-TDD (SC-FDMA, 50% RB, 5 MHz, 16-QAM) | LTE-TDD | 9.91 | ± 9.6 % |
| 10248 | CAG | LTE-TDD (SC-FDMA, 50% RB, 5 MHz, 64-QAM) | LTE-TDD | 10.09 | ± 9.6 % |
| 10249 | CAG | LTE-TDD (SC-FDMA, 50% RB, 5 MHz, QPSK) | LTE-TDD | 9.29 | ± 9.6 % |
| 10250 | CAG | LTE-TDD (SC-FDMA, 50% RB, 10 MHz, 16-QAM) | LTE-TDD | 9.81 | ± 9.6 % |
| 10251 | CAG | LTE-TDD (SC-FDMA, 50% RB, 10 MHz, 64-QAM) | LTE-TDD | 10.17 | ± 9.6 % |
| 10252 | CAG | LTE-TDD (SC-FDMA, 50% RB, 10 MHz, QPSK) | LTE-TDD | 9.24 | ± 9.6 % |
| 10253 | CAF | LTE-TDD (SC-FDMA, 50% RB, 15 MHz, 16-QAM) | LTE-TDD | 9.90 | ± 9.6 % |
| 10254 | CAF | LTE-TDD (SC-FDMA, 50% RB, 15 MHz, 64-QAM) | LTE-TDD | 10.14 | ± 9.6 % |
| 10255 | CAF | LTE-TDD (SC-FDMA, 50% RB, 15 MHz, QPSK) | LTE-TDD | 9.20 | ± 9.6 % |
| 10256 | CAB | LTE-TDD (SC-FDMA, 100% RB, 1.4 MHz, 16-QAM) | LTE-TDD | 9.96 | ± 9.6 % |
| 10257 | CAB | LTE-TDD (SC-FDMA, 100% RB, 1.4 MHz, 64-QAM) | LTE-TDD | 10.08 | ± 9.6 % |
| 10258 | CAB | LTE-TDD (SC-FDMA, 100% RB, 1.4 MHz, QPSK) | LTE-TDD | 9.34 | ± 9.6 % |
| 10259 | CAD | LTE-TDD (SC-FDMA, 100% RB, 3 MHz, 16-QAM) | LTE-TDD | 9.98 | ± 9.6 % |
| 10260 | CAD | LTE-TDD (SC-FDMA, 100% RB, 3 MHz, 64-QAM) | LTE-TDD | 9.97 | ± 9.6 % |
| 10261 | CAD | LTE-TDD (SC-FDMA, 100% RB, 3 MHz, QPSK) | LTE-TDD | 9.24 | ± 9.6 % |
| 10262 | CAG | LTE-TDD (SC-FDMA, 100% RB, 5 MHz, 16-QAM) | LTE-TDD | 9.83 | ± 9.6 % |
| 10263 | CAG | LTE-TDD (SC-FDMA, 100% RB, 5 MHz, 64-QAM) | LTE-TDD | 10.16 | ± 9.6 % |
| 10264 | CAG | LTE-TDD (SC-FDMA, 100% RB, 5 MHz, QPSK) | LTE-TDD | 9.23 | ± 9.6 % |
| 10265 | CAG | LTE-TDD (SC-FDMA, 100% RB, 10 MHz, 16-QAM) | LTE-TDD | 9.92 | ± 9.6 % |
| 10266 | CAG | LTE-TDD (SC-FDMA, 100% RB, 10 MHz, 64-QAM) | LTE-TDD | 10.07 | ± 9.6 % |
| 10267 | CAG | LTE-TDD (SC-FDMA, 100% RB, 10 MHz, QPSK) | LTE-TDD | 9.30 | ± 9.6 % |
| 10268 | CAF | LTE-TDD (SC-FDMA, 100% RB, 15 MHz, 16-QAM) | LTE-TDD | 10.06 | ± 9.6 % |
| 10269 | CAF | LTE-TDD (SC-FDMA, 100% RB, 15 MHz, 64-QAM) | LTE-TDD | 10.13 | ± 9.6 % |
| 10270 | CAF | LTE-TDD (SC-FDMA, 100% RB, 15 MHz, QPSK) | LTE-TDD | 9.58 | ± 9.6 % |
| 10274 | CAB | UMTS-FDD (HSUPA, Subtest 5, 3GPP Rel8.10) | WCDMA | 4.87 | ± 9.6 % |
| 10275 | CAB | UMTS-FDD (HSUPA, Subtest 5, 3GPP Rel8.4) | WCDMA | 3.96 | ± 9.6 % |
| 10277 | CAA | PHS (QPSK) | PHS | 11.81 | ± 9.6 % |
| 10278 | CAA | PHS (QPSK, BW 884MHz, Rolloff 0.5) | PHS | 11.81 | ± 9.6 % |
| 10279 | CAA | PHS (QPSK, BW 884MHz, Rolloff 0.38) | PHS | 12.18 | ± 9.6 % |
| 10290 | AAB | CDMA2000, RC1, SO55, Full Rate | CDMA2000 | 3.91 | ± 9.6 % |
| 10291 | AAB | CDMA2000, RC3, SO55, Full Rate | CDMA2000 | 3.46 | ± 9.6 % |
| 10292 | AAB | CDMA2000, RC3, SO32, Full Rate | CDMA2000 | 3.39 | ± 9.6 % |
| 10293 | AAB | CDMA2000, RC3, SO3, Full Rate | CDMA2000 | 3.50 | ± 9.6 % |
| 10295 | AAB | CDMA2000, RC1, SO3, 1/8th Rate 25 fr. | CDMA2000 | 12.49 | ± 9.6 % |
| 10297 | AAD | LTE-FDD (SC-FDMA, 50% RB, 20 MHz, QPSK) | LTE-FDD | 5.81 | ± 9.6 % |
| 10298 | AAD | LTE-FDD (SC-FDMA, 50% RB, 3 MHz, QPSK) | LTE-FDD | 5.72 | ± 9.6 % |
| 10299 | AAD | LTE-FDD (SC-FDMA, 50% RB, 3 MHz, 16-QAM) | LTE-FDD | 6.39 | ± 9.6 % |

| | | | | | |
|-------|-----|---------------------------------------------------------------------------------|----------|-------|---------|
| 10300 | AAD | LTE-FDD (SC-FDMA, 50% RB, 3 MHz, 64-QAM) | LTE-FDD | 6.60 | ± 9.6 % |
| 10301 | AAA | IEEE 802.16e WiMAX (29:18, 5ms, 10MHz, QPSK, PUSC) | WiMAX | 12.03 | ± 9.6 % |
| 10302 | AAA | IEEE 802.16e WiMAX (29:18, 5ms, 10MHz, QPSK, PUSC, 3 CTRL symbols) | WiMAX | 12.57 | ± 9.6 % |
| 10303 | AAA | IEEE 802.16e WiMAX (31:15, 5ms, 10MHz, 64QAM, PUSC) | WiMAX | 12.52 | ± 9.6 % |
| 10304 | AAA | IEEE 802.16e WiMAX (29:18, 5ms, 10MHz, 64QAM, PUSC) | WiMAX | 11.86 | ± 9.6 % |
| 10305 | AAA | IEEE 802.16e WiMAX (31:15, 10ms, 10MHz, 64QAM, PUSC, 15 symbols) | WiMAX | 15.24 | ± 9.6 % |
| 10306 | AAA | IEEE 802.16e WiMAX (29:18, 10ms, 10MHz, 64QAM, PUSC, 18 symbols) | WiMAX | 14.67 | ± 9.6 % |
| 10307 | AAA | IEEE 802.16e WiMAX (29:18, 10ms, 10MHz, QPSK, PUSC, 18 symbols) | WiMAX | 14.49 | ± 9.6 % |
| 10308 | AAA | IEEE 802.16e WiMAX (29:18, 10ms, 10MHz, 16QAM, PUSC) | WiMAX | 14.46 | ± 9.6 % |
| 10309 | AAA | IEEE 802.16e WiMAX (29:18, 10ms, 10MHz, 16QAM, AMC 2x3, 18 symbols) | WiMAX | 14.58 | ± 9.6 % |
| 10310 | AAA | IEEE 802.16e WiMAX (29:18, 10ms, 10MHz, QPSK, AMC 2x3, 18 symbols) | WiMAX | 14.57 | ± 9.6 % |
| 10311 | AAD | LTE-FDD (SC-FDMA, 100% RB, 15 MHz, QPSK) | LTE-FDD | 6.06 | ± 9.6 % |
| 10313 | AAA | iDEN 1:3 | iDEN | 10.51 | ± 9.6 % |
| 10314 | AAA | iDEN 1:6 | iDEN | 13.48 | ± 9.6 % |
| 10315 | AAB | IEEE 802.11b WiFi 2.4 GHz (DSSS, 1 Mbps, 96pc duty cycle) | WLAN | 1.71 | ± 9.6 % |
| 10316 | AAB | IEEE 802.11g WiFi 2.4 GHz (ERP-OFDM, 6 Mbps, 96pc duty cycle) | WLAN | 8.36 | ± 9.6 % |
| 10317 | AAC | IEEE 802.11a WiFi 5 GHz (OFDM, 6 Mbps, 96pc duty cycle) | WLAN | 8.36 | ± 9.6 % |
| 10352 | AAA | Pulse Waveform (200Hz, 10%) | Generic | 10.00 | ± 9.6 % |
| 10353 | AAA | Pulse Waveform (200Hz, 20%) | Generic | 6.99 | ± 9.6 % |
| 10354 | AAA | Pulse Waveform (200Hz, 40%) | Generic | 3.98 | ± 9.6 % |
| 10355 | AAA | Pulse Waveform (200Hz, 60%) | Generic | 2.22 | ± 9.6 % |
| 10356 | AAA | Pulse Waveform (200Hz, 80%) | Generic | 0.97 | ± 9.6 % |
| 10387 | AAA | QPSK Waveform, 1 MHz | Generic | 5.10 | ± 9.6 % |
| 10388 | AAA | QPSK Waveform, 10 MHz | Generic | 5.22 | ± 9.6 % |
| 10396 | AAA | 64-QAM Waveform, 100 kHz | Generic | 6.27 | ± 9.6 % |
| 10399 | AAA | 64-QAM Waveform, 40 MHz | Generic | 6.27 | ± 9.6 % |
| 10400 | AAD | IEEE 802.11ac WiFi (20MHz, 64-QAM, 99pc duty cycle) | WLAN | 8.37 | ± 9.6 % |
| 10401 | AAD | IEEE 802.11ac WiFi (40MHz, 64-QAM, 99pc duty cycle) | WLAN | 8.60 | ± 9.6 % |
| 10402 | AAD | IEEE 802.11ac WiFi (80MHz, 64-QAM, 99pc duty cycle) | WLAN | 8.53 | ± 9.6 % |
| 10403 | AAB | CDMA2000 (1xEV-DO, Rev. 0) | CDMA2000 | 3.76 | ± 9.6 % |
| 10404 | AAB | CDMA2000 (1xEV-DO, Rev. A) | CDMA2000 | 3.77 | ± 9.6 % |
| 10406 | AAB | CDMA2000, RC3, SO32, SCH0, Full Rate | CDMA2000 | 5.22 | ± 9.6 % |
| 10410 | AAG | LTE-TDD (SC-FDMA, 1 RB, 10 MHz, QPSK, UL Subframe=2,3,4,7,8,9, Subframe Conf=4) | LTE-TDD | 7.82 | ± 9.6 % |
| 10414 | AAA | WLAN CCDF, 64-QAM, 40MHz | Generic | 8.54 | ± 9.6 % |
| 10415 | AAA | IEEE 802.11b WiFi 2.4 GHz (DSSS, 1 Mbps, 99pc duty cycle) | WLAN | 1.54 | ± 9.6 % |
| 10416 | AAA | IEEE 802.11g WiFi 2.4 GHz (ERP-OFDM, 6 Mbps, 99pc duty cycle) | WLAN | 8.23 | ± 9.6 % |
| 10417 | AAB | IEEE 802.11a/h WiFi 5 GHz (OFDM, 6 Mbps, 99pc duty cycle) | WLAN | 8.23 | ± 9.6 % |
| 10418 | AAA | IEEE 802.11g WiFi 2.4 GHz (DSSS-OFDM, 6 Mbps, 99pc duty cycle, Long preamble) | WLAN | 8.14 | ± 9.6 % |
| 10419 | AAA | IEEE 802.11g WiFi 2.4 GHz (DSSS-OFDM, 6 Mbps, 99pc duty cycle, Short preamble) | WLAN | 8.19 | ± 9.6 % |
| 10422 | AAB | IEEE 802.11n (HT Greenfield, 7.2 Mbps, BPSK) | WLAN | 8.32 | ± 9.6 % |
| 10423 | AAB | IEEE 802.11n (HT Greenfield, 43.3 Mbps, 16-QAM) | WLAN | 8.47 | ± 9.6 % |
| 10424 | AAB | IEEE 802.11n (HT Greenfield, 72.2 Mbps, 64-QAM) | WLAN | 8.40 | ± 9.6 % |
| 10425 | AAB | IEEE 802.11n (HT Greenfield, 15 Mbps, BPSK) | WLAN | 8.41 | ± 9.6 % |
| 10426 | AAB | IEEE 802.11n (HT Greenfield, 90 Mbps, 16-QAM) | WLAN | 8.45 | ± 9.6 % |
| 10427 | AAB | IEEE 802.11n (HT Greenfield, 150 Mbps, 64-QAM) | WLAN | 8.41 | ± 9.6 % |
| 10430 | AAD | LTE-FDD (OFDMA, 5 MHz, E-TM 3.1) | LTE-FDD | 8.28 | ± 9.6 % |
| 10431 | AAD | LTE-FDD (OFDMA, 10 MHz, E-TM 3.1) | LTE-FDD | 8.38 | ± 9.6 % |
| 10432 | AAC | LTE-FDD (OFDMA, 15 MHz, E-TM 3.1) | LTE-FDD | 8.34 | ± 9.6 % |
| 10433 | AAC | LTE-FDD (OFDMA, 20 MHz, E-TM 3.1) | LTE-FDD | 8.34 | ± 9.6 % |
| 10434 | AAA | W-CDMA (BS Test Model 1, 64 DPCH) | WCDMA | 8.60 | ± 9.6 % |
| 10435 | AAF | LTE-TDD (SC-FDMA, 1 RB, 20 MHz, QPSK, UL Subframe=2,3,4,7,8,9) | LTE-TDD | 7.82 | ± 9.6 % |
| 10447 | AAD | LTE-FDD (OFDMA, 5 MHz, E-TM 3.1, Clipping 44%) | LTE-FDD | 7.56 | ± 9.6 % |
| 10448 | AAD | LTE-FDD (OFDMA, 10 MHz, E-TM 3.1, Clipping 44%) | LTE-FDD | 7.53 | ± 9.6 % |
| 10449 | AAC | LTE-FDD (OFDMA, 15 MHz, E-TM 3.1, Clipping 44%) | LTE-FDD | 7.51 | ± 9.6 % |
| 10450 | AAC | LTE-FDD (OFDMA, 20 MHz, E-TM 3.1, Clipping 44%) | LTE-FDD | 7.48 | ± 9.6 % |

| | | | | | |
|-------|-----|------------------------------------------------------------------------|----------|------|---------|
| 10451 | AAA | W-CDMA (BS Test Model 1, 64 DPCH, Clipping 44%) | WCDMA | 7.59 | ± 9.6 % |
| 10456 | AAB | IEEE 802.11ac WiFi (160MHz, 64-QAM, 99pc duty cycle) | WLAN | 8.63 | ± 9.6 % |
| 10457 | AAA | UMTS-FDD (DC-HSDPA) | WCDMA | 6.62 | ± 9.6 % |
| 10458 | AAA | CDMA2000 (1xEV-DO, Rev. B, 2 carriers) | CDMA2000 | 6.55 | ± 9.6 % |
| 10459 | AAA | CDMA2000 (1xEV-DO, Rev. B, 3 carriers) | CDMA2000 | 8.25 | ± 9.6 % |
| 10460 | AAA | UMTS-FDD (WCDMA, AMR) | WCDMA | 2.39 | ± 9.6 % |
| 10461 | AAB | LTE-TDD (SC-FDMA, 1 RB, 1.4 MHz, QPSK, UL Subframe=2,3,4,7,8,9) | LTE-TDD | 7.82 | ± 9.6 % |
| 10462 | AAB | LTE-TDD (SC-FDMA, 1 RB, 1.4 MHz, 16-QAM, UL Subframe=2,3,4,7,8,9) | LTE-TDD | 8.30 | ± 9.6 % |
| 10463 | AAB | LTE-TDD (SC-FDMA, 1 RB, 1.4 MHz, 64-QAM, UL Subframe=2,3,4,7,8,9) | LTE-TDD | 8.56 | ± 9.6 % |
| 10464 | AAC | LTE-TDD (SC-FDMA, 1 RB, 3 MHz, QPSK, UL Subframe=2,3,4,7,8,9) | LTE-TDD | 7.82 | ± 9.6 % |
| 10465 | AAC | LTE-TDD (SC-FDMA, 1 RB, 3 MHz, 16-QAM, UL Subframe=2,3,4,7,8,9) | LTE-TDD | 8.32 | ± 9.6 % |
| 10466 | AAC | LTE-TDD (SC-FDMA, 1 RB, 3 MHz, 64-QAM, UL Subframe=2,3,4,7,8,9) | LTE-TDD | 8.57 | ± 9.6 % |
| 10467 | AAF | LTE-TDD (SC-FDMA, 1 RB, 5 MHz, QPSK, UL Subframe=2,3,4,7,8,9) | LTE-TDD | 7.82 | ± 9.6 % |
| 10468 | AAF | LTE-TDD (SC-FDMA, 1 RB, 5 MHz, 16-QAM, UL Subframe=2,3,4,7,8,9) | LTE-TDD | 8.32 | ± 9.6 % |
| 10469 | AAF | LTE-TDD (SC-FDMA, 1 RB, 5 MHz, 64-QAM, UL Subframe=2,3,4,7,8,9) | LTE-TDD | 8.56 | ± 9.6 % |
| 10470 | AAF | LTE-TDD (SC-FDMA, 1 RB, 10 MHz, QPSK, UL Subframe=2,3,4,7,8,9) | LTE-TDD | 7.82 | ± 9.6 % |
| 10471 | AAF | LTE-TDD (SC-FDMA, 1 RB, 10 MHz, 16-QAM, UL Subframe=2,3,4,7,8,9) | LTE-TDD | 8.32 | ± 9.6 % |
| 10472 | AAF | LTE-TDD (SC-FDMA, 1 RB, 10 MHz, 64-QAM, UL Subframe=2,3,4,7,8,9) | LTE-TDD | 8.57 | ± 9.6 % |
| 10473 | AAE | LTE-TDD (SC-FDMA, 1 RB, 15 MHz, QPSK, UL Subframe=2,3,4,7,8,9) | LTE-TDD | 7.82 | ± 9.6 % |
| 10474 | AAE | LTE-TDD (SC-FDMA, 1 RB, 15 MHz, 16-QAM, UL Subframe=2,3,4,7,8,9) | LTE-TDD | 8.32 | ± 9.6 % |
| 10475 | AAE | LTE-TDD (SC-FDMA, 1 RB, 15 MHz, 64-QAM, UL Subframe=2,3,4,7,8,9) | LTE-TDD | 8.57 | ± 9.6 % |
| 10477 | AAF | LTE-TDD (SC-FDMA, 1 RB, 20 MHz, 16-QAM, UL Subframe=2,3,4,7,8,9) | LTE-TDD | 8.32 | ± 9.6 % |
| 10478 | AAF | LTE-TDD (SC-FDMA, 1 RB, 20 MHz, 64-QAM, UL Subframe=2,3,4,7,8,9) | LTE-TDD | 8.57 | ± 9.6 % |
| 10479 | AAB | LTE-TDD (SC-FDMA, 50% RB, 1.4 MHz, QPSK, UL Subframe=2,3,4,7,8,9) | LTE-TDD | 7.74 | ± 9.6 % |
| 10480 | AAB | LTE-TDD (SC-FDMA, 50% RB, 1.4 MHz, 16-QAM, UL Subframe=2,3,4,7,8,9) | LTE-TDD | 8.18 | ± 9.6 % |
| 10481 | AAB | LTE-TDD (SC-FDMA, 50% RB, 1.4 MHz, 64-QAM, UL Subframe=2,3,4,7,8,9) | LTE-TDD | 8.45 | ± 9.6 % |
| 10482 | AAC | LTE-TDD (SC-FDMA, 50% RB, 3 MHz, QPSK, UL Subframe=2,3,4,7,8,9) | LTE-TDD | 7.71 | ± 9.6 % |
| 10483 | AAC | LTE-TDD (SC-FDMA, 50% RB, 3 MHz, 16-QAM, UL Subframe=2,3,4,7,8,9) | LTE-TDD | 8.39 | ± 9.6 % |
| 10484 | AAC | LTE-TDD (SC-FDMA, 50% RB, 3 MHz, 64-QAM, UL Subframe=2,3,4,7,8,9) | LTE-TDD | 8.47 | ± 9.6 % |
| 10485 | AAF | LTE-TDD (SC-FDMA, 50% RB, 5 MHz, QPSK, UL Subframe=2,3,4,7,8,9) | LTE-TDD | 7.59 | ± 9.6 % |
| 10486 | AAF | LTE-TDD (SC-FDMA, 50% RB, 5 MHz, 16-QAM, UL Subframe=2,3,4,7,8,9) | LTE-TDD | 8.38 | ± 9.6 % |
| 10487 | AAF | LTE-TDD (SC-FDMA, 50% RB, 5 MHz, 64-QAM, UL Subframe=2,3,4,7,8,9) | LTE-TDD | 8.60 | ± 9.6 % |
| 10488 | AAF | LTE-TDD (SC-FDMA, 50% RB, 10 MHz, QPSK, UL Subframe=2,3,4,7,8,9) | LTE-TDD | 7.70 | ± 9.6 % |
| 10489 | AAF | LTE-TDD (SC-FDMA, 50% RB, 10 MHz, 16-QAM, UL Subframe=2,3,4,7,8,9) | LTE-TDD | 8.31 | ± 9.6 % |
| 10490 | AAF | LTE-TDD (SC-FDMA, 50% RB, 10 MHz, 64-QAM, UL Subframe=2,3,4,7,8,9) | LTE-TDD | 8.54 | ± 9.6 % |
| 10491 | AAE | LTE-TDD (SC-FDMA, 50% RB, 15 MHz, QPSK, UL Subframe=2,3,4,7,8,9) | LTE-TDD | 7.74 | ± 9.6 % |

| | | | | | |
|-------|-----|----------------------------------------------------------------------|---------|------|---------|
| 10492 | AAE | LTE-TDD (SC-FDMA, 50% RB, 15 MHz, 16-QAM, UL Subframe=2,3,4,7,8,9) | LTE-TDD | 8.41 | ± 9.6 % |
| 10493 | AAE | LTE-TDD (SC-FDMA, 50% RB, 15 MHz, 64-QAM, UL Subframe=2,3,4,7,8,9) | LTE-TDD | 8.55 | ± 9.6 % |
| 10494 | AAF | LTE-TDD (SC-FDMA, 50% RB, 20 MHz, QPSK, UL Subframe=2,3,4,7,8,9) | LTE-TDD | 7.74 | ± 9.6 % |
| 10495 | AAF | LTE-TDD (SC-FDMA, 50% RB, 20 MHz, 16-QAM, UL Subframe=2,3,4,7,8,9) | LTE-TDD | 8.37 | ± 9.6 % |
| 10496 | AAF | LTE-TDD (SC-FDMA, 50% RB, 20 MHz, 64-QAM, UL Subframe=2,3,4,7,8,9) | LTE-TDD | 8.54 | ± 9.6 % |
| 10497 | AAB | LTE-TDD (SC-FDMA, 100% RB, 1.4 MHz, QPSK, UL Subframe=2,3,4,7,8,9) | LTE-TDD | 7.67 | ± 9.6 % |
| 10498 | AAB | LTE-TDD (SC-FDMA, 100% RB, 1.4 MHz, 16-QAM, UL Subframe=2,3,4,7,8,9) | LTE-TDD | 8.40 | ± 9.6 % |
| 10499 | AAB | LTE-TDD (SC-FDMA, 100% RB, 1.4 MHz, 64-QAM, UL Subframe=2,3,4,7,8,9) | LTE-TDD | 8.68 | ± 9.6 % |
| 10500 | AAC | LTE-TDD (SC-FDMA, 100% RB, 3 MHz, QPSK, UL Subframe=2,3,4,7,8,9) | LTE-TDD | 7.67 | ± 9.6 % |
| 10501 | AAC | LTE-TDD (SC-FDMA, 100% RB, 3 MHz, 16-QAM, UL Subframe=2,3,4,7,8,9) | LTE-TDD | 8.44 | ± 9.6 % |
| 10502 | AAC | LTE-TDD (SC-FDMA, 100% RB, 3 MHz, 64-QAM, UL Subframe=2,3,4,7,8,9) | LTE-TDD | 8.52 | ± 9.6 % |
| 10503 | AAF | LTE-TDD (SC-FDMA, 100% RB, 5 MHz, QPSK, UL Subframe=2,3,4,7,8,9) | LTE-TDD | 7.72 | ± 9.6 % |
| 10504 | AAF | LTE-TDD (SC-FDMA, 100% RB, 5 MHz, 16-QAM, UL Subframe=2,3,4,7,8,9) | LTE-TDD | 8.31 | ± 9.6 % |
| 10505 | AAF | LTE-TDD (SC-FDMA, 100% RB, 5 MHz, 64-QAM, UL Subframe=2,3,4,7,8,9) | LTE-TDD | 8.54 | ± 9.6 % |
| 10506 | AAF | LTE-TDD (SC-FDMA, 100% RB, 10 MHz, QPSK, UL Subframe=2,3,4,7,8,9) | LTE-TDD | 7.74 | ± 9.6 % |
| 10507 | AAF | LTE-TDD (SC-FDMA, 100% RB, 10 MHz, 16-QAM, UL Subframe=2,3,4,7,8,9) | LTE-TDD | 8.36 | ± 9.6 % |
| 10508 | AAF | LTE-TDD (SC-FDMA, 100% RB, 10 MHz, 64-QAM, UL Subframe=2,3,4,7,8,9) | LTE-TDD | 8.55 | ± 9.6 % |
| 10509 | AAE | LTE-TDD (SC-FDMA, 100% RB, 15 MHz, QPSK, UL Subframe=2,3,4,7,8,9) | LTE-TDD | 7.99 | ± 9.6 % |
| 10510 | AAE | LTE-TDD (SC-FDMA, 100% RB, 15 MHz, 16-QAM, UL Subframe=2,3,4,7,8,9) | LTE-TDD | 8.49 | ± 9.6 % |
| 10511 | AAE | LTE-TDD (SC-FDMA, 100% RB, 15 MHz, 64-QAM, UL Subframe=2,3,4,7,8,9) | LTE-TDD | 8.51 | ± 9.6 % |
| 10512 | AAF | LTE-TDD (SC-FDMA, 100% RB, 20 MHz, QPSK, UL Subframe=2,3,4,7,8,9) | LTE-TDD | 7.74 | ± 9.6 % |
| 10513 | AAF | LTE-TDD (SC-FDMA, 100% RB, 20 MHz, 16-QAM, UL Subframe=2,3,4,7,8,9) | LTE-TDD | 8.42 | ± 9.6 % |
| 10514 | AAF | LTE-TDD (SC-FDMA, 100% RB, 20 MHz, 64-QAM, UL Subframe=2,3,4,7,8,9) | LTE-TDD | 8.45 | ± 9.6 % |
| 10515 | AAA | IEEE 802.11b WiFi 2.4 GHz (DSSS, 2 Mbps, 99pc duty cycle) | WLAN | 1.58 | ± 9.6 % |
| 10516 | AAA | IEEE 802.11b WiFi 2.4 GHz (DSSS, 5.5 Mbps, 99pc duty cycle) | WLAN | 1.57 | ± 9.6 % |
| 10517 | AAA | IEEE 802.11b WiFi 2.4 GHz (DSSS, 11 Mbps, 99pc duty cycle) | WLAN | 1.58 | ± 9.6 % |
| 10518 | AAB | IEEE 802.11a/h WiFi 5 GHz (OFDM, 9 Mbps, 99pc duty cycle) | WLAN | 8.23 | ± 9.6 % |
| 10519 | AAB | IEEE 802.11a/h WiFi 5 GHz (OFDM, 12 Mbps, 99pc duty cycle) | WLAN | 8.39 | ± 9.6 % |
| 10520 | AAB | IEEE 802.11a/h WiFi 5 GHz (OFDM, 18 Mbps, 99pc duty cycle) | WLAN | 8.12 | ± 9.6 % |
| 10521 | AAB | IEEE 802.11a/h WiFi 5 GHz (OFDM, 24 Mbps, 99pc duty cycle) | WLAN | 7.97 | ± 9.6 % |
| 10522 | AAB | IEEE 802.11a/h WiFi 5 GHz (OFDM, 36 Mbps, 99pc duty cycle) | WLAN | 8.45 | ± 9.6 % |
| 10523 | AAB | IEEE 802.11a/h WiFi 5 GHz (OFDM, 48 Mbps, 99pc duty cycle) | WLAN | 8.08 | ± 9.6 % |
| 10524 | AAB | IEEE 802.11a/h WiFi 5 GHz (OFDM, 54 Mbps, 99pc duty cycle) | WLAN | 8.27 | ± 9.6 % |
| 10525 | AAB | IEEE 802.11ac WiFi (20MHz, MCS0, 99pc duty cycle) | WLAN | 8.36 | ± 9.6 % |
| 10526 | AAB | IEEE 802.11ac WiFi (20MHz, MCS1, 99pc duty cycle) | WLAN | 8.42 | ± 9.6 % |
| 10527 | AAB | IEEE 802.11ac WiFi (20MHz, MCS2, 99pc duty cycle) | WLAN | 8.21 | ± 9.6 % |
| 10528 | AAB | IEEE 802.11ac WiFi (20MHz, MCS3, 99pc duty cycle) | WLAN | 8.36 | ± 9.6 % |
| 10529 | AAB | IEEE 802.11ac WiFi (20MHz, MCS4, 99pc duty cycle) | WLAN | 8.36 | ± 9.6 % |
| 10531 | AAB | IEEE 802.11ac WiFi (20MHz, MCS6, 99pc duty cycle) | WLAN | 8.43 | ± 9.6 % |
| 10532 | AAB | IEEE 802.11ac WiFi (20MHz, MCS7, 99pc duty cycle) | WLAN | 8.29 | ± 9.6 % |
| 10533 | AAB | IEEE 802.11ac WiFi (20MHz, MCS8, 99pc duty cycle) | WLAN | 8.38 | ± 9.6 % |
| 10534 | AAB | IEEE 802.11ac WiFi (40MHz, MCS0, 99pc duty cycle) | WLAN | 8.45 | ± 9.6 % |

| | | | | | |
|-------|-----|-----------------------------------------------------------------|------|------|---------|
| 10535 | AAB | IEEE 802.11ac WiFi (40MHz, MCS1, 99pc duty cycle) | WLAN | 8.45 | ± 9.6 % |
| 10536 | AAB | IEEE 802.11ac WiFi (40MHz, MCS2, 99pc duty cycle) | WLAN | 8.32 | ± 9.6 % |
| 10537 | AAB | IEEE 802.11ac WiFi (40MHz, MCS3, 99pc duty cycle) | WLAN | 8.44 | ± 9.6 % |
| 10538 | AAB | IEEE 802.11ac WiFi (40MHz, MCS4, 99pc duty cycle) | WLAN | 8.54 | ± 9.6 % |
| 10540 | AAB | IEEE 802.11ac WiFi (40MHz, MCS6, 99pc duty cycle) | WLAN | 8.39 | ± 9.6 % |
| 10541 | AAB | IEEE 802.11ac WiFi (40MHz, MCS7, 99pc duty cycle) | WLAN | 8.46 | ± 9.6 % |
| 10542 | AAB | IEEE 802.11ac WiFi (40MHz, MCS8, 99pc duty cycle) | WLAN | 8.65 | ± 9.6 % |
| 10543 | AAB | IEEE 802.11ac WiFi (40MHz, MCS9, 99pc duty cycle) | WLAN | 8.65 | ± 9.6 % |
| 10544 | AAB | IEEE 802.11ac WiFi (80MHz, MCS0, 99pc duty cycle) | WLAN | 8.47 | ± 9.6 % |
| 10545 | AAB | IEEE 802.11ac WiFi (80MHz, MCS1, 99pc duty cycle) | WLAN | 8.55 | ± 9.6 % |
| 10546 | AAB | IEEE 802.11ac WiFi (80MHz, MCS2, 99pc duty cycle) | WLAN | 8.35 | ± 9.6 % |
| 10547 | AAB | IEEE 802.11ac WiFi (80MHz, MCS3, 99pc duty cycle) | WLAN | 8.49 | ± 9.6 % |
| 10548 | AAB | IEEE 802.11ac WiFi (80MHz, MCS4, 99pc duty cycle) | WLAN | 8.37 | ± 9.6 % |
| 10550 | AAB | IEEE 802.11ac WiFi (80MHz, MCS6, 99pc duty cycle) | WLAN | 8.38 | ± 9.6 % |
| 10551 | AAB | IEEE 802.11ac WiFi (80MHz, MCS7, 99pc duty cycle) | WLAN | 8.50 | ± 9.6 % |
| 10552 | AAB | IEEE 802.11ac WiFi (80MHz, MCS8, 99pc duty cycle) | WLAN | 8.42 | ± 9.6 % |
| 10553 | AAB | IEEE 802.11ac WiFi (80MHz, MCS9, 99pc duty cycle) | WLAN | 8.45 | ± 9.6 % |
| 10554 | AAC | IEEE 802.11ac WiFi (160MHz, MCS0, 99pc duty cycle) | WLAN | 8.48 | ± 9.6 % |
| 10555 | AAC | IEEE 802.11ac WiFi (160MHz, MCS1, 99pc duty cycle) | WLAN | 8.47 | ± 9.6 % |
| 10556 | AAC | IEEE 802.11ac WiFi (160MHz, MCS2, 99pc duty cycle) | WLAN | 8.50 | ± 9.6 % |
| 10557 | AAC | IEEE 802.11ac WiFi (160MHz, MCS3, 99pc duty cycle) | WLAN | 8.52 | ± 9.6 % |
| 10558 | AAC | IEEE 802.11ac WiFi (160MHz, MCS4, 99pc duty cycle) | WLAN | 8.61 | ± 9.6 % |
| 10560 | AAC | IEEE 802.11ac WiFi (160MHz, MCS6, 99pc duty cycle) | WLAN | 8.73 | ± 9.6 % |
| 10561 | AAC | IEEE 802.11ac WiFi (160MHz, MCS7, 99pc duty cycle) | WLAN | 8.56 | ± 9.6 % |
| 10562 | AAC | IEEE 802.11ac WiFi (160MHz, MCS8, 99pc duty cycle) | WLAN | 8.69 | ± 9.6 % |
| 10563 | AAC | IEEE 802.11ac WiFi (160MHz, MCS9, 99pc duty cycle) | WLAN | 8.77 | ± 9.6 % |
| 10564 | AAA | IEEE 802.11g WiFi 2.4 GHz (DSSS-OFDM, 9 Mbps, 99pc duty cycle) | WLAN | 8.25 | ± 9.6 % |
| 10565 | AAA | IEEE 802.11g WiFi 2.4 GHz (DSSS-OFDM, 12 Mbps, 99pc duty cycle) | WLAN | 8.45 | ± 9.6 % |
| 10566 | AAA | IEEE 802.11g WiFi 2.4 GHz (DSSS-OFDM, 18 Mbps, 99pc duty cycle) | WLAN | 8.13 | ± 9.6 % |
| 10567 | AAA | IEEE 802.11g WiFi 2.4 GHz (DSSS-OFDM, 24 Mbps, 99pc duty cycle) | WLAN | 8.00 | ± 9.6 % |
| 10568 | AAA | IEEE 802.11g WiFi 2.4 GHz (DSSS-OFDM, 36 Mbps, 99pc duty cycle) | WLAN | 8.37 | ± 9.6 % |
| 10569 | AAA | IEEE 802.11g WiFi 2.4 GHz (DSSS-OFDM, 48 Mbps, 99pc duty cycle) | WLAN | 8.10 | ± 9.6 % |
| 10570 | AAA | IEEE 802.11g WiFi 2.4 GHz (DSSS-OFDM, 54 Mbps, 99pc duty cycle) | WLAN | 8.30 | ± 9.6 % |
| 10571 | AAA | IEEE 802.11b WiFi 2.4 GHz (DSSS, 1 Mbps, 90pc duty cycle) | WLAN | 1.99 | ± 9.6 % |
| 10572 | AAA | IEEE 802.11b WiFi 2.4 GHz (DSSS, 2 Mbps, 90pc duty cycle) | WLAN | 1.99 | ± 9.6 % |
| 10573 | AAA | IEEE 802.11b WiFi 2.4 GHz (DSSS, 5.5 Mbps, 90pc duty cycle) | WLAN | 1.98 | ± 9.6 % |
| 10574 | AAA | IEEE 802.11b WiFi 2.4 GHz (DSSS, 11 Mbps, 90pc duty cycle) | WLAN | 1.98 | ± 9.6 % |
| 10575 | AAA | IEEE 802.11g WiFi 2.4 GHz (DSSS-OFDM, 6 Mbps, 90pc duty cycle) | WLAN | 8.59 | ± 9.6 % |
| 10576 | AAA | IEEE 802.11g WiFi 2.4 GHz (DSSS-OFDM, 9 Mbps, 90pc duty cycle) | WLAN | 8.60 | ± 9.6 % |
| 10577 | AAA | IEEE 802.11g WiFi 2.4 GHz (DSSS-OFDM, 12 Mbps, 90pc duty cycle) | WLAN | 8.70 | ± 9.6 % |
| 10578 | AAA | IEEE 802.11g WiFi 2.4 GHz (DSSS-OFDM, 18 Mbps, 90pc duty cycle) | WLAN | 8.49 | ± 9.6 % |
| 10579 | AAA | IEEE 802.11g WiFi 2.4 GHz (DSSS-OFDM, 24 Mbps, 90pc duty cycle) | WLAN | 8.36 | ± 9.6 % |
| 10580 | AAA | IEEE 802.11g WiFi 2.4 GHz (DSSS-OFDM, 36 Mbps, 90pc duty cycle) | WLAN | 8.76 | ± 9.6 % |
| 10581 | AAA | IEEE 802.11g WiFi 2.4 GHz (DSSS-OFDM, 48 Mbps, 90pc duty cycle) | WLAN | 8.35 | ± 9.6 % |
| 10582 | AAA | IEEE 802.11g WiFi 2.4 GHz (DSSS-OFDM, 54 Mbps, 90pc duty cycle) | WLAN | 8.67 | ± 9.6 % |
| 10583 | AAB | IEEE 802.11a/h WiFi 5 GHz (OFDM, 6 Mbps, 90pc duty cycle) | WLAN | 8.59 | ± 9.6 % |
| 10584 | AAB | IEEE 802.11a/h WiFi 5 GHz (OFDM, 9 Mbps, 90pc duty cycle) | WLAN | 8.60 | ± 9.6 % |
| 10585 | AAB | IEEE 802.11a/h WiFi 5 GHz (OFDM, 12 Mbps, 90pc duty cycle) | WLAN | 8.70 | ± 9.6 % |
| 10586 | AAB | IEEE 802.11a/h WiFi 5 GHz (OFDM, 18 Mbps, 90pc duty cycle) | WLAN | 8.49 | ± 9.6 % |
| 10587 | AAB | IEEE 802.11a/h WiFi 5 GHz (OFDM, 24 Mbps, 90pc duty cycle) | WLAN | 8.36 | ± 9.6 % |