

# SAR Test Report

**Report No.** : SFBEDW-WTW-P20100106  
**Applicant** : HON HAI Precision Ind. Co., Ltd.  
**Address** : 5F-1, 5 Hsin-An Road Hsinchu, Science-Based Industrial Park, Hsinchu,  
 Taiwan, R.O.C  
**Product** : LTE M.2 Module  
**FCC ID** : MCLT77W968-D13  
**Brand** : FOXCONN  
**Model No.** : T77W968  
**Standards** : FCC 47 CFR Part 2 (2.1093), IEEE C95.1:1992, IEEE Std 1528:2013  
 KDB 865664 D01 v01r04, KDB 865664 D02 v01r02  
 KDB 248227 D01 v02r02, KDB 447498 D01 v06  
 KDB 616217 D04 v01r02, KDB 941225 D01 v03r01  
 KDB 941225 D05 v02r05, KDB 941225 D05A v01r02  
**Sample Received Date** : Oct. 07, 2020  
**Date of Testing** : Nov. 16, 2020 ~ Nov. 30, 2020  
**Lab Address** : No. 47-2, 14th Ling, Chia Pau Vil., Lin Kou Dist., New Taipei City, Taiwan  
**Test Location** : No. 19, Hwa Ya 2nd Rd., Wen Hwa Vil., Kwei Shan Dist., Taoyuan City, Taiwan

**CERTIFICATION:** The above equipment have been tested by **Bureau Veritas Consumer Products Services (H.K.) Ltd., Taoyuan Branch–Lin Kou Laboratories**, and found compliance with the requirement of the above standards. The test record, data evaluation & Equipment Under Test (EUT) configurations represented herein are true and accurate accounts of the measurements of the sample's SAR characteristics under the conditions specified in this report. It should not be reproduced except in full, without the written approval of our laboratory. The client should not use it to claim product certification, approval, or endorsement by TAF or any government agencies.

Prepared By :



Shelly Hsueh / Specialist

Approved By :



Gordon Lin / Manager



FCC Accredited No.: TW0003

This report is for your exclusive use. Any copying or replication of this report to or for any other person or entity, or use of our name or trademark, is permitted only with our prior written permission. This report sets forth our findings solely with respect to the test samples identified herein. The results set forth in this report are not indicative or representative of the quality or characteristics of the lot from which a test sample was taken or any similar or identical product unless specifically and expressly noted. Our report includes all of the tests requested by you and the results thereof based upon the information that you provided to us. You have 60 days from date of issuance of this report to notify us of any material error or omission caused by our negligence, provided, however, that such notice shall be in writing and shall specifically address the issue you wish to raise. A failure to raise such issue within the prescribed time shall constitute your unqualified acceptance of the completeness of this report, the tests conducted and the correctness of the report contents. Unless specific mention, the uncertainty of measurement has been explicitly taken into account to declare the compliance or non-compliance to the specification.

## Table of Contents

<b>Release Control Record .....</b>	<b>3</b>
<b>1. Summary of Maximum SAR Value .....</b>	<b>4</b>
<b>2. Description of Equipment Under Test .....</b>	<b>5</b>
<b>3. SAR Measurement System .....</b>	<b>7</b>
3.1 Definition of Specific Absorption Rate (SAR) .....	7
3.2 SPEAG DASY6 System .....	7
3.2.1 Robot .....	8
3.2.2 Probes .....	9
3.2.3 Data Acquisition Electronics (DAE) .....	9
3.2.4 Phantoms .....	9
3.2.5 Device Holder .....	10
3.2.6 System Validation Dipoles .....	11
3.2.7 Power Source .....	11
3.2.8 Tissue Simulating Liquids .....	12
3.3 SAR System Verification .....	14
3.4 SAR Measurement Procedure .....	15
3.4.1 Area Scan and Zoom Scan Procedure .....	15
3.4.2 Volume Scan Procedure .....	16
3.4.3 Power Drift Monitoring .....	17
3.4.4 Spatial Peak SAR Evaluation .....	17
3.4.5 SAR Averaged Methods .....	17
<b>4. SAR Measurement Evaluation .....</b>	<b>18</b>
4.1 EUT Configuration and Setting .....	18
4.2 EUT Testing Position .....	29
4.2.1 Body Exposure Conditions .....	29
4.3 Tissue Verification .....	30
4.4 System Validation .....	31
4.5 System Verification .....	32
4.6 Maximum Output Power .....	33
4.6.1 Maximum Target Conducted Power .....	33
4.6.2 Measured Conducted Power Result .....	33
4.7 SAR Testing Results .....	33
4.7.1 SAR Test Reduction Considerations .....	33
4.7.2 SAR Results for Body Exposure Condition .....	35
4.7.3 SAR Measurement Variability .....	53
4.7.4 Simultaneous Multi-band Transmission Evaluation .....	55
<b>5. Calibration of Test Equipment .....</b>	<b>57</b>
<b>6. Measurement Uncertainty .....</b>	<b>58</b>
<b>7. Information of the Testing Laboratories .....</b>	<b>59</b>
<b>Appendix A. SAR Plots of System Verification</b>	
<b>Appendix B. SAR Plots of SAR Measurement</b>	
<b>Appendix C. Calibration Certificate for Probe and Dipole</b>	
<b>Appendix D. Photographs of EUT and Setup</b>	
<b>Appendix E. Maximum Target Conducted Power</b>	
<b>Appendix F. Measured Conducted Power Result</b>	
<b>Appendix G. Analysis of Simultaneous Transmission SAR</b>	
<b>Appendix H. SAR to Peak Location Separation Ratio Analysis</b>	



**1. Summary of Maximum SAR Value**

Equipment Class	Mode	Highest SAR-1g Body (W/kg)	
		Tablet Mode	Laptop PC Mode
PCB	WCDMA II	0.70	0.90
	WCDMA IV	0.75	0.99
	WCDMA V	0.79	1.05
	LTE 2	0.77	0.85
	LTE 4	0.78	0.98
	LTE 5	0.79	1.05
	LTE 7	1.03	0.95
	LTE 12	0.78	1.05
	LTE 13	0.85	0.89
	LTE 14	0.95	0.97
	LTE 17	0.93	0.79
	LTE 25	1.06	0.79
	LTE 26	0.95	0.88
	LTE 30	1.04	0.94
	LTE 38	1.04	0.96
	LTE 41	1.13	0.78
LTE 66	0.86	0.80	
DTS	2.4G WLAN	0.52	1.05
NII	5.2G WLAN	1.10	N/A
	5.3G WLAN	N/A	1.10
	5.6G WLAN	0.77	0.72
	5.8G WLAN	0.62	0.91
DSS	Bluetooth	0.10	0.23

Highest Simultaneous Transmission SAR	Highest SAR-1g Body (W/kg)	
	Tablet Mode	Laptop PC Mode
	1.59	1.59

**Note:**

- The SAR criteria (**Head & Body: SAR-1g1.6 W/kg, and Extremity: SAR-10g 4.0 W/kg**)for general population/uncontrolled exposure is specified in FCC 47 CFR part 2 (2.1093) and ANSI/IEEE C95.1-1992.

**2. Description of Equipment Under Test**

<b>EUT Type</b>	LTE M.2 Module
<b>FCC ID</b>	MCLT77W968-D13 (WWAN Module) PD9AX201D2 (WLAN Module)
<b>Brand Name</b>	FOXCONN
<b>Model Name</b>	T77W968
<b>EUT Configurations</b>	Sample 1 : EUT with WWAN Ant. ET + WLAN Ant. HB Sample 2 : EUT with WWAN Ant. ET + WLAN Ant. ET Sample 3 : EUT with WWAN Ant. WNC + WLAN Ant. HB Sample 4 : EUT with WWAN Ant. WNC + WLAN Ant .ET
<b>Tx Frequency Bands (Unit: MHz)</b>	WCDMA Band II : 1852.4 ~ 1907.6 WCDMA Band IV : 1712.4 ~ 1752.6 WCDMA Band V : 826.4 ~ 846.6 LTE Band 2 : 1850.7 ~ 1909.3 (BW: 1.4M, 3M, 5M, 10M, 15M, 20M) LTE Band 4 : 1710.7 ~ 1754.3 (BW: 1.4M, 3M, 5M, 10M, 15M, 20M) LTE Band 5 : 824.7 ~ 848.3 (BW: 1.4M, 3M, 5M, 10M) LTE Band 7 : 2502.5 ~ 2567.5 (BW: 5M, 10M, 15M, 20M) LTE Band 12 : 699.7 ~ 715.3 (BW: 1.4M, 3M, 5M, 10M) LTE Band 13 : 779.5 ~ 784.5 (BW: 5M, 10M) LTE Band 14 : 790.5 ~ 795.5 (BW: 5M, 10M) LTE Band 17 : 706.5 ~ 713.5 (BW: 5M, 10M) LTE Band 25 : 1850.7 ~ 1914.3 (BW: 1.4M, 3M, 5M, 10M, 15M, 20M) LTE Band 26 : 814.7 ~ 848.3 (BW: 1.4M, 3M, 5M, 10M, 15M) LTE Band 29 : 717 ~ 728(Rx only) LTE Band 30 : 2307.5 ~ 2312.5 (BW: 5M, 10M) LTE Band 38 : 2572.5 ~ 2617.5 (BW: 5M, 10M, 15M, 20M) LTE Band 41 : 2498.5 ~ 2687.5 (BW: 5M, 10M, 15M, 20M) LTE Band 66 : 1710.7 ~ 1779.3 (BW: 1.4M, 3M, 5M, 10M, 15M, 20M) WLAN : 2412 ~ 2472, 5180 ~ 5320, 5500 ~ 5720, 5745 ~ 5825 Bluetooth : 2402 ~ 2480
<b>Uplink Modulations</b>	WCDMA : QPSK LTE : QPSK, 16QAM, 64QAM 802.11b : DSSS 802.11a/g/n/ac : OFDM 802.11ax : OFDMA Bluetooth : GFSK, $\pi/4$ -DQPSK, 8-DPSK
<b>Maximum Tune-up Conducted Power (Unit: dBm)</b>	Please refer to section 4.6.1 of this report
<b>Antenna Type</b>	Refer to note as below
<b>EUT Stage</b>	Mass Product

**Note:**

1. The EUT is authorized for use in specific End-product. Please refer to below for more details.

Product	Brand	Model
Portable Computer	DELL	P95F

- The WWAN module (Brand: FOXCONN, Model: T77W968) was installed in the EUT.
- The WLAN/BT module (Brand: Intel, Model: AX201D2W) was installed in the EUT.
- All of the power reduction (power reduction) do not follow 3GPP MPR.

# SAR Test Report

5. The antenna information is listed as below.

**Manufacturer: Ethertronics**

Antenna Type	Parts Number	WWAN Antenna Gain (dBi)													
		WCDMA II / LTE 2	WCDMA IV / LTE 4	WCDMA V / LTE 5	LTE 7	LTE 12	LTE 13	LTE 14	LTE 17	LTE25	LTE 26	LTE 30	LTE 38	LTE41	LTE66
		<b>Tablet Mode</b>													
PIFA	Main Ant(Tx/Rx): 5003671(DC33002CL0L)	-1.79	-3.01	-6.86	-2.26	-6.13	-6.31	-6.43	-6.13	-1.79	-6.86	-0.18	-0.08	1.41	-2.54
	Aux Ant(Rx): 5003690(DC33002CL1L)	<b>Laptop PC Mode</b>													
	5003700(DC33002CL2L)	2.92	2.94	-1.17	2.46	-1.68	-0.44	-0.47	-1.79	2.92	-1.17	2.67	2.62	5.35	2.94

**Manufacturer: WNC**

Antenna Type	Parts Number	WWAN Antenna Gain (dBi)													
		WCDMA II / LTE 2	WCDMA IV / LTE 4	WCDMA V / LTE 5	LTE 7	LTE 12	LTE 13	LTE 14	LTE 17	LTE25	LTE 26	LTE 30	LTE 38	LTE41	LTE66
		<b>Tablet Mode</b>													
PIFA	Main Ant(Tx/Rx): 57ELAS15.061(DC33002FS0L)	-1.89	-3.02	-6.86	-2.33	-6.23	-6.34	-6.49	-6.23	-1.89	-6.86	-0.21	-5.85	1.27	-2.54
	Aux Ant(Rx): 57ELAS15.062(DC33002FS1L)	<b>Laptop PC Mode</b>													
	57ELAS15.066(DC33002FS2L)	2.9	2.92	-1.28	2.32	-1.75	-0.58	-0.61	-1.91	2.9	-1.28	2.62	-0.31	5.26	2.92

Antenna Type	Manufacturer	Parts Number	WLAN Antenna Gain			
			BT/WLAN 2.4 GHz	WLAN 5.15~5.35 GHz	WLAN 5.47~5.725 GHz	WLAN 5.725~5.85 GHz
PIFA	Ethertronics	Main Ant.: 5003710 (DC33002CL3L) Aux Ant.: 5003710 (DC33002CL3L)	Main: -1.51 Aux.: -2.34	Main: -0.68 Aux.: -1.16	Main: -0.73 Aux.: -1.35	Main: -0.58 Aux.: -1.35
	Hong-BO Co., Ltd.	Main Ant.: 260-24302 (DC33002CQ1L) Aux Ant.: 260-24302 (DC33002CQ1L)	Main: -1.28 Aux.: -2.76	Main: -2.02 Aux.: -1.06	Main: -1.23 Aux.: -1.24	Main: -0.14 Aux.: -1.06

6. The above EUT information is declared by manufacturer and for more detailed features description please refers to the manufacturer's specifications or User's Manual.

**List of Accessory:**

Battery 1 (6 Cell)	Brand Name	Dell
	Model Name	TVKGH
	Power Rating	7334mAh, 88Wh, 11.4V
	Type	Li-ion
Battery 2 (4 Cell)	Brand Name	Dell
	Model Name	V5K68
	Power Rating	6053mAh, 48.5Wh, 7.6V
	Type	Li-ion

### **3. SAR Measurement System**

#### **3.1 Definition of Specific Absorption Rate (SAR)**

SAR is related to the rate at which energy is absorbed per unit mass in an object exposed to a radio field. The SAR distribution in a biological body is complicated and is usually carried out by experimental techniques or numerical modeling. The standard recommends limits for two tiers of groups, occupational/controlled and general population/uncontrolled, based on a person's awareness and ability to exercise control over his or her exposure. In general, occupational/controlled exposure limits are higher than the limits for general population/uncontrolled.

The SAR definition is the time derivative (rate) of the incremental energy (dW) absorbed by (dissipated in) an incremental mass (dm) contained in a volume element (dv) of a given density ( $\rho$ ). The equation description is as below:

$$\text{SAR} = \frac{d}{dt} \left( \frac{dW}{dm} \right) = \frac{d}{dt} \left( \frac{dW}{\rho dv} \right)$$

SAR is expressed in units of Watts per kilogram (W/kg)

SAR measurement can be related to the electrical field in the tissue by

$$\text{SAR} = \frac{\sigma |E|^2}{\rho}$$

Where:  $\sigma$  is the conductivity of the tissue,  $\rho$  is the mass density of the tissue and E is the RMS electrical field strength.

#### **3.2 SPEAG DASY6 System**

DASY6 system consists of high precision robot, probe alignment sensor, phantom, robot controller, controlled measurement server and near-field probe. The robot includes six axes that can move to the precision position of the DASY6 software defined. The DASY6 software can define the area that is detected by the probe. The robot is connected to controlled box. Controlled measurement server is connected to the controlled robot box. The DAE includes amplifier, signal multiplexing, AD converter, offset measurement and surface detection. It is connected to the Electro-optical coupler (ECO). The ECO performs the conversion from the optical into digital electric signal of the DAE and transfers data to the PC.

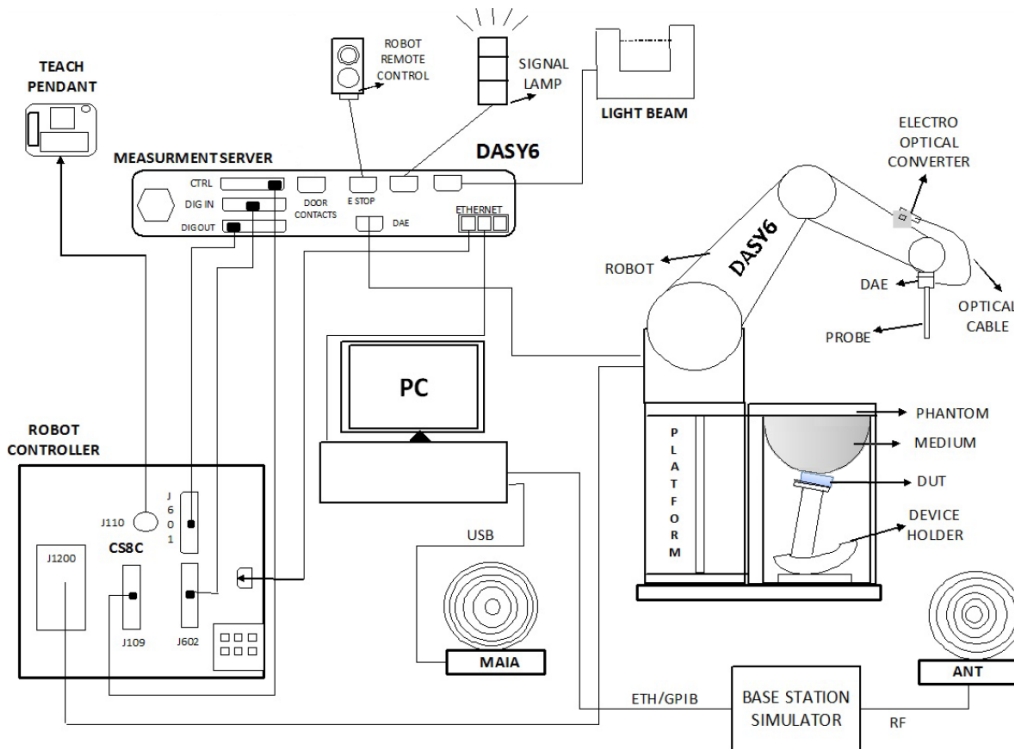
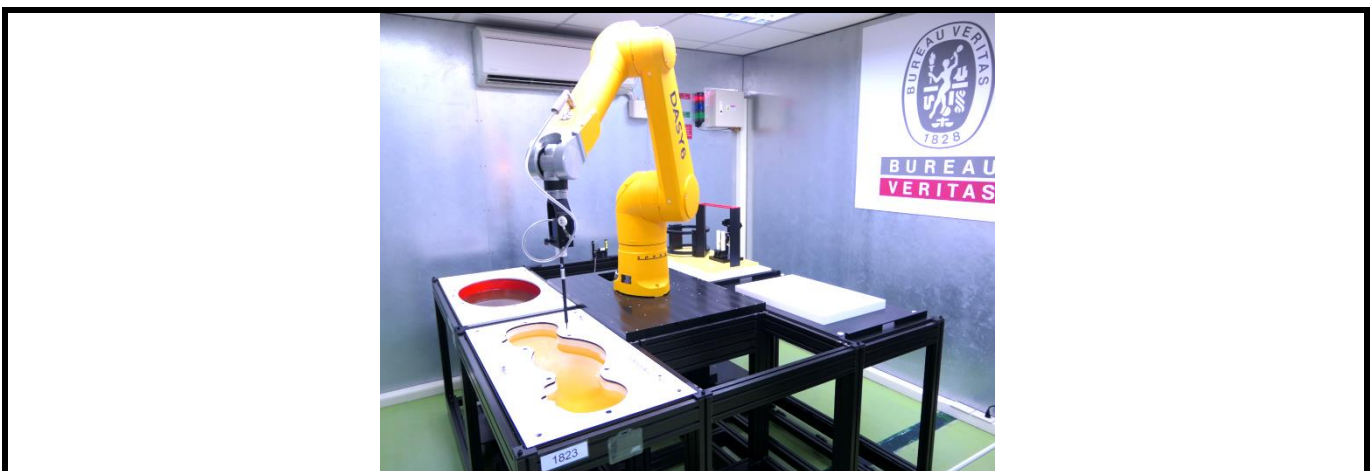

**Fig-3.1 SPEAG DASY6 System Setup**

**3.2.1 Robot**

The DASY6 systems use the high precision robots from Stäubli SA (France). For the 6-axis controller system, the robot controller version of CS8c from Stäubli is used. The Stäubli robot series have many features that are important for our application:

- High precision (repeatability  $\pm 0.035$  mm)
- High reliability (industrial design)
- Jerk-free straight movements
- Low ELF interference (the closed metallic construction shields against motor control fields)



**Fig-3.2 SPEAG DASY6 System**



# SAR Test Report

### 3.2.2 Probes

The SAR measurement is conducted with the dosimetric probe. The probe is specially designed and calibrated for use in liquid with high permittivity. The dosimetric probe has special calibration in liquid at different frequency.

<b>Model</b>	EX3DV4	
<b>Construction</b>	Symmetrical design with triangular core. Built-in shielding against static charges. PEEK enclosure material (resistant to organic solvents, e.g., DGBE).	
<b>Frequency</b>	4 MHz to 10 GHz Linearity: $\pm 0.2$ dB	
<b>Directivity</b>	$\pm 0.1$ dB in TSL (rotation around probe axis) $\pm 0.3$ dB in TSL (rotation normal to probe axis)	
<b>Dynamic Range</b>	10 $\mu$ W/g to 100 mW/g Linearity: $\pm 0.2$ dB (noise: typically $< 1$ $\mu$ W/g)	
<b>Dimensions</b>	Overall length: 337 mm (Tip: 20 mm) Tip diameter: 2.5 mm (Body: 12 mm) Typical distance from probe tip to dipole centers: 1 mm	

### 3.2.3 Data Acquisition Electronics (DAE)

<b>Model</b>	DAE3, DAE4	
<b>Construction</b>	Signal amplifier, multiplexer, A/D converter and control logic. Serial optical link for communication with DASY embedded system (fully remote controlled). Two step probe touch detector for mechanical surface detection and emergency robot stop.	
<b>Measurement Range</b>	-100 to +300 mV (16 bit resolution and two range settings: 4mV, 400mV)	
<b>Input Offset Voltage</b>	$< 5\mu$ V (with auto zero)	
<b>Input Bias Current</b>	$< 50$ fA	
<b>Dimensions</b>	60 x 60 x 68 mm	

### 3.2.4 Phantoms

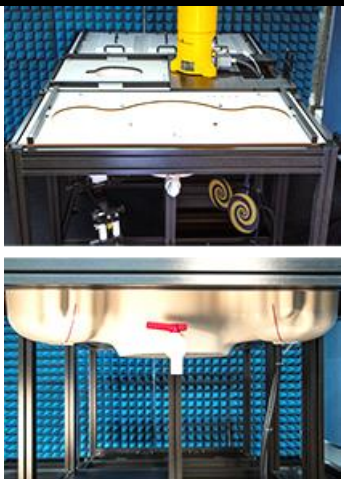
<b>Model</b>	SAM-Twin Phantom	
<b>Construction</b>	The shell corresponds to the specifications of the Specific Anthropomorphic Mannequin (SAM) phantom defined in IEEE Std 1528 and IEC 62209-1. It enables the dosimetric evaluation of left and right hand phone usage as well as body-mounted usage at the flat phantom region. A cover prevents evaporation of the liquid. Reference markings on the phantom allow the complete setup of all predefined phantom positions and measurement grids by teaching three points with the robot.	
<b>Material</b>	Vinylester, fiberglass reinforced (VE-GF)	
<b>Shell Thickness</b>	$2 \pm 0.2$ mm ( $6 \pm 0.2$ mm at ear point)	
<b>Dimensions</b>	Length: 1000 mm Width: 500 mm Height: adjustable feet	
<b>Filling Volume</b>	approx. 25 liters	

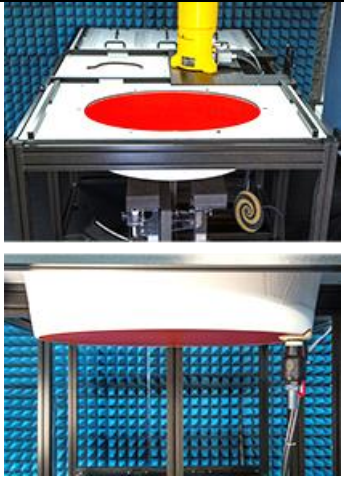
<b>Model</b>	ELI	
<b>Construction</b>	The ELI phantom is used for compliance testing of handheld and body-mounted wireless devices. ELI is fully compatible with the IEC 62209-2 standard and all known tissue simulating liquids. ELI has been optimized regarding its performance and can be integrated into our standard phantom tables. A cover prevents evaporation of the liquid. Reference markings on the phantom allow installation of the complete setup, including all predefined phantom positions and measurement grids, by teaching three points. The phantom is compatible with all SPEAG dosimetric probes and dipoles.	
<b>Material</b>	Vinylester, fiberglass reinforced (VE-GF)	
<b>Shell Thickness</b>	2.0 ± 0.2 mm (bottom plate)	
<b>Dimensions</b>	Major axis: 600 mm Minor axis: 400 mm	
<b>Filling Volume</b>	approx. 30 liters	

### 3.2.5 Device Holder

<b>Model</b>	MD4HHTV5 - Mounting Device for Hand-Held Transmitters	
<b>Construction</b>	In combination with the Twin SAM or ELI phantoms, the Mounting Device for Hand-Held Transmitters enables rotation of the mounted transmitter device to specified spherical coordinates. At the heads, the rotation axis is at the ear opening. Transmitter devices can be easily and accurately positioned according to IEC 62209-1, IEEE 1528, FCC, or other specifications. The device holder can be locked for positioning at different phantom sections (left head, right head, flat).	
<b>Material</b>	Polyoxymethylene (POM)	

<b>Model</b>	MDA4WTV5 - Mounting Device Adaptor for Ultra Wide Transmitters	
<b>Construction</b>	An upgrade kit to Mounting Device to enable easy mounting of wider devices like big smart-phones, e-books, small tablets, etc. It holds devices with width up to 140 mm.	
<b>Material</b>	Polyoxymethylene (POM)	

<b>Model</b>	MDA4SPV6 - Mounting Device Adaptor for Smart Phones	
<b>Construction</b>	The solid low-density MDA4SPV6 adaptor assuring no impact on the DUT radiation performance and is conform with any DUT design and shape.	
<b>Material</b>	ROHACELL	

## SAR Test Report

<b>Model</b>	MD4LAPV5 - Mounting Device for Laptops and other Body-Worn Transmitters	
<b>Construction</b>	In combination with the Twin SAM or ELI phantoms, the Mounting Device (Body-Worn) enables testing of transmitter devices according to IEC 62209-2 specifications. The device holder can be locked for positioning at a flat phantom section.	
<b>Material</b>	Polyoxymethylene (POM), PET-G, Foam	

### 3.2.6 System Validation Dipoles

<b>Model</b>	D-Serial	
<b>Construction</b>	Symmetrical dipole with 1/4 balun. Enables measurement of feed point impedance with NWA. Matched for use near flat phantoms filled with tissue simulating solutions.	
<b>Frequency</b>	750 MHz to 5800 MHz	
<b>Return Loss</b>	> 20 dB	
<b>Power Capability</b>	> 100 W (f < 1GHz), > 40 W (f > 1GHz)	

### 3.2.7 Power Source

<b>Model</b>	Powersource1	
<b>Signal Type</b>	Continuous Wave	
<b>Operating Frequencies</b>	600 MHz to 5850 MHz	
<b>Output Power</b>	-5.0 dBm to +17.0 dBm	
<b>Power Supply</b>	5V DC, via USB jack	
<b>Power Consumption</b>	<3 W	
<b>Applications</b>	System performance check and validation with a CW signal.	

**3.2.8 Tissue Simulating Liquids**

For SAR measurement of the field distribution inside the phantom, the phantom must be filled with homogeneous tissue simulating liquid to a depth of at least 15 cm. For head SAR testing, the liquid height from the ear reference point (ERP) of the phantom to the liquid top surface is larger than 15 cm. For body SAR testing, the liquid height from the center of the flat phantom to the liquid top surface is larger than 15 cm. The nominal dielectric values of the tissue simulating liquids in the phantom and the tolerance of 10 % are listed in Table-3.1.

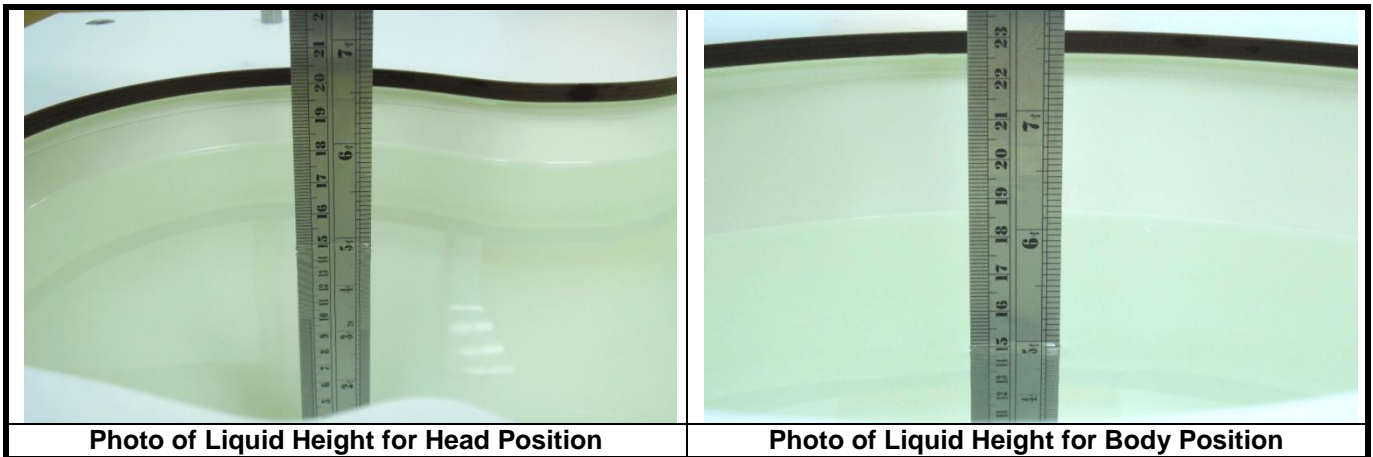

**Table-3.1 Targets of Tissue Simulating Liquid**

Frequency (MHz)	Target Permittivity	Range of ±10 %	Target Conductivity	Range of ±10 %
450	43.5	39.2 ~ 47.9	0.87	0.78 ~ 0.96
750	41.9	37.7 ~ 46.1	0.89	0.80 ~ 0.98
835	41.5	37.4 ~ 45.7	0.90	0.81 ~ 0.99
900	41.5	37.4 ~ 45.7	0.97	0.87 ~ 1.07
1450	40.5	36.5 ~ 44.6	1.20	1.08 ~ 1.32
1500	40.4	36.4 ~ 44.4	1.23	1.11 ~ 1.35
1640	40.2	36.2 ~ 44.2	1.31	1.18 ~ 1.44
1750	40.1	36.1 ~ 44.1	1.37	1.23 ~ 1.51
1800	40.0	36.0 ~ 44.0	1.40	1.26 ~ 1.54
1900	40.0	36.0 ~ 44.0	1.40	1.26 ~ 1.54
2000	40.0	36.0 ~ 44.0	1.40	1.26 ~ 1.54
2100	39.8	35.8 ~ 43.8	1.49	1.34 ~ 1.64
2300	39.5	35.6 ~ 43.5	1.67	1.50 ~ 1.84
2450	39.2	35.3 ~ 43.1	1.80	1.62 ~ 1.98
2600	39.0	35.1 ~ 42.9	1.96	1.76 ~ 2.16
3000	38.5	34.7 ~ 42.4	2.40	2.16 ~ 2.64
3500	37.9	34.1 ~ 41.7	2.91	2.62 ~ 3.20
4000	37.4	33.7 ~ 41.1	3.43	3.09 ~ 3.77
4500	36.8	33.1 ~ 40.5	3.94	3.55 ~ 4.33
5000	36.2	32.6 ~ 39.8	4.45	4.01 ~ 4.90
5200	36.0	32.4 ~ 39.6	4.66	4.19 ~ 5.13
5400	35.8	32.2 ~ 39.4	4.86	4.37 ~ 5.35
5600	35.5	32.0 ~ 39.1	5.07	4.56 ~ 5.58
5800	35.3	31.8 ~ 38.8	5.27	4.74 ~ 5.80
6000	35.1	31.6 ~ 38.6	5.48	4.93 ~ 6.03

## SAR Test Report

The dielectric properties of the tissue simulating liquids are defined in IEC 62209-1 and IEC 62209-2. The dielectric properties of the tissue simulating liquids were verified prior to the SAR evaluation using a dielectric assessment kit and a network analyzer.

Since the range of  $\pm 10\%$  of the required target values is used to measure relative permittivity and conductivity, the SAR correction procedure is applied to correct measured SAR for the deviations in permittivity and conductivity. Only positive correction has been used to scale up the measured SAR, and SAR result would not be corrected if the correction  $\Delta$  SAR has a negative sign.

The following table gives the recipes for tissue simulating liquids.

**Table-3.2 Recipes of Tissue Simulating Liquid**

Tissue Type	Bactericide	DGBE	HEC	NaCl	Sucrose	Triton X-100	Water	Diethylene Glycol Mono-hexylether
H750	0.2	-	0.2	1.5	56.0	-	42.1	-
H835	0.2	-	0.2	1.5	57.0	-	41.1	-
H900	0.2	-	0.2	1.4	58.0	-	40.2	-
H1450	-	43.3	-	0.6	-	-	56.1	-
H1640	-	45.8	-	0.5	-	-	53.7	-
H1750	-	47.0	-	0.4	-	-	52.6	-
H1800	-	44.5	-	0.3	-	-	55.2	-
H1900	-	44.5	-	0.2	-	-	55.3	-
H2000	-	44.5	-	0.1	-	-	55.4	-
H2300	-	44.9	-	0.1	-	-	55.0	-
H2450	-	45.0	-	0.1	-	-	54.9	-
H2600	-	45.1	-	0.1	-	-	54.8	-
H3500	-	8.0	-	0.2	-	20.0	71.8	-
H5G	-	-	-	-	-	17.2	65.5	17.3

**3.3 SAR System Verification**

The system check verifies that the system operates within its specifications. It is performed daily or before every SAR measurement. The system check uses normal SAR measurements in the flat section of the phantom with a matched dipole at a specified distance. The system verification setup is shown as below.

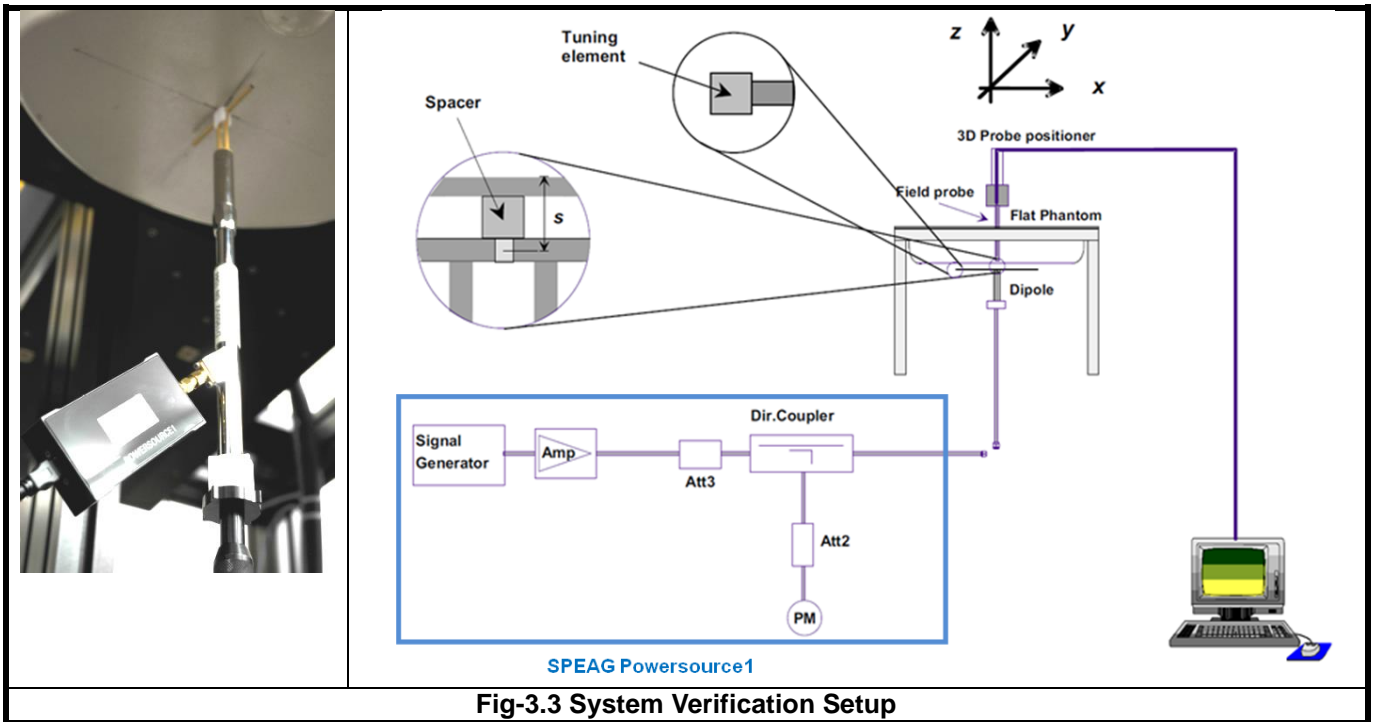

**Fig-3.3 System Verification Setup**

The SPEAG Powersource1 is a portable and very stable RF source providing a continuous wave (CW) signal. It is designed for conducting SAR system checks and SAR system validation of DASy and is compatible with IEC 62209-1, IEC 62209-2 and IEEE Std 1528 standards. The Powersource1 has been calibrated by SPEAG's ISO/IEC 17025-accredited calibration center. When using Powersource1, the setup can be simplified, as shown in Fig-3.3. The signal purity is warranted by design. Since the Powersource1 is calibrated, no additional equipment is needed and the Powersource1 can directly be connected to the SMA connector of the dipole without a cable as all separate components (signal generator, amplifier, coupler and power meter) are built into the unit.

The validation dipole is placed beneath the flat phantom with the specific spacer in place. The distance spacer is touch the phantom surface with a light pressure at the reference marking and be oriented parallel to the long side of the phantom. The Powersource1 is adjusted for the desired forward power of 17 dBm at the dipole connector and the RF output power would be turned on. After system check testing, the SAR result will be normalized to 1W forward input power and compared with the reference SAR value derived from validation dipole certificate report. The deviation of system check should be within 10 %.

**3.4 SAR Measurement Procedure**

According to the SAR test standard, the recommended procedure for assessing the peak spatial-average SAR value consists of the following steps:

- (a) Power reference measurement
- (b) Area scan
- (c) Zoom scan
- (d) Power drift measurement

The SAR measurement procedures for each of test conditions are as follows:

- (a) Make EUT to transmit maximum output power
- (b) Measure conducted output power through RF cable
- (c) Place the EUT in the specific position of phantom
- (d) Perform SAR testing steps on the DASY system
- (e) Record the SAR value

**3.4.1 Area Scan and Zoom Scan Procedure**

First area scan is used to locate the approximate location(s) of the local peak SAR value(s). The measurement grid within an area scan is defined by the grid extent, grid step size and grid offset. Next, in order to determine the EM field distribution in a three-dimensional spatial extension, zoom scan is required. The zoom scan is performed around the highest E-field value to determine the averaged SAR-distribution.

Measure the local SAR at a test point at 1.4 mm of the inner surface of the phantom recommended by SEPAG. The area scan (two-dimensional SAR distribution) is performed cover at least an area larger than the projection of the EUT or antenna. The measurement resolution and spatial resolution for interpolation shall be chosen to allow identification of the local peak locations to within one-half of the linear dimension of the corresponding side of the zoom scan volume. Following table provides the measurement parameters required for the area scan.

Parameter	$f \leq 3 \text{ GHz}$	$3 \text{ GHz} < f \leq 6 \text{ GHz}$
Maximum distance from closest measurement point to phantom surface	$5 \pm 1$	$\delta \ln(2)/2 \pm 0.5$
Maximum probe angle from probe axis to phantom surface normal at the measurement location	$30^\circ \pm 1^\circ$	$20^\circ \pm 1^\circ$
Maximum area scan spatial resolution: $\Delta x_{Area}, \Delta y_{Area}$	$\leq 2 \text{ GHz: } \leq 15 \text{ mm}$ $2 - 3 \text{ GHz: } \leq 12 \text{ mm}$	$3 - 4 \text{ GHz: } \leq 12 \text{ mm}$ $4 - 6 \text{ GHz: } \leq 10 \text{ mm}$

From the scanned SAR distribution, identify the position of the maximum SAR value, in addition identify the positions of any local maxima with SAR values within 2 dB of the maximum value that will not be within the zoom scan of other peaks. Additional peaks shall be measured only when the primary peak is within 2 dB of the SAR compliance limit (e.g. 1 W/kg for 1.6 W/kg, 1 g limit; or 1.26 W/kg for 2 W/kg, 10 g limit).

The zoom scan (three-dimensional SAR distribution) is performed at the local maxima locations identified in previous area scan procedure. The zoom scan volume must be larger than the required minimum dimensions. When graded grids are used, which only applies in the direction normal to the phantom surface, the initial grid separation closest to the phantom surface and subsequent graded grid increment ratios must satisfy the required protocols. The 1-g SAR averaging volume must be fully contained within the zoom scan measurement volume boundaries; otherwise, the measurement must be repeated by shifting or expanding the zoom scan volume. The similar requirements also apply to 10-g SAR measurements. Following table provides the measurement parameters required for the zoom scan.

Parameter		$f \leq 3$ GHz	$3 \text{ GHz} < f \leq 6$ GHz
Maximum zoom scan spatial resolution: $\Delta x_{\text{zoom}}, \Delta y_{\text{zoom}}$		$\leq 2$ GHz: $\leq 8$ mm 2 – 3 GHz: $\leq 5$ mm	3 – 4 GHz: $\leq 5$ mm 4 – 6 GHz: $\leq 4$ mm
Maximum zoom scan spatial resolution, normal to phantom surface	<i>uniform grid:</i> $\Delta z_{\text{zoom}}(n)$	$\leq 5$ mm	3 – 4 GHz: $\leq 4$ mm 4 – 5 GHz: $\leq 3$ mm 5 – 6 GHz: $\leq 2$ mm
	<i>graded grids:</i> $\Delta z_{\text{zoom}}(1)$	$\leq 4$ mm	3 – 4 GHz: $\leq 3.0$ mm 4 – 5 GHz: $\leq 2.5$ mm 5 – 6 GHz: $\leq 2.0$ mm
	$\Delta z_{\text{zoom}}(n>1)$	$\leq 1.5 \cdot \Delta z_{\text{zoom}}(n-1)$ mm	
Minimum zoom scan volume (x, y, z)		$\geq 30$ mm	3 – 4 GHz: $\geq 28$ mm 4 – 5 GHz: $\geq 25$ mm 5 – 6 GHz: $\geq 22$ mm

Per IEC 62209-2 AMD1, the successively higher resolution zoom scan is required if the zoom scan measured as defined above complies with both of the following criteria, or if the peak spatial-average SAR is below 0.1 W/kg, no additional measurements are needed:

- (1) The smallest horizontal distance from the local SAR peaks to all points 3 dB below the SAR peak shall be larger than the horizontal grid steps in both x and y directions ( $\Delta x, \Delta y$ ). This shall be checked for the measured zoom scan plane conformal to the phantom at the distance  $z_{M1}$ .
- (2) The ratio of the SAR at the second measured point (M2) to the SAR at the closest measured point (M1) at the x-y location of the measured maximum SAR value shall be at least 30 %.

If one or both of the above criteria are not met, the zoom scan measurement shall be repeated using a finer resolution. New horizontal and vertical grid steps shall be determined from the measured SAR distribution so that the above criteria are met. Compliance with the above two criteria shall be demonstrated for the new measured zoom scan.

### 3.4.2 Volume Scan Procedure

The volume scan is used for assess overlapping SAR distributions for antennas transmitting in different frequency bands. It is equivalent to an oversized zoom scan used in standalone measurements. The measurement volume will be used to enclose all the simultaneous transmitting antennas. For antennas transmitting simultaneously in different frequency bands, the volume scan is measured separately in each frequency band. In order to sum correctly to compute the 1g aggregate SAR, the EUT remain in the same test position for all measurements and all volume scan use the same spatial resolution and grid spacing. When all volume scan were completed, the software, SEMCAD postprocessor can combine and subsequently superpose these measurement data to calculating the multiband SAR.



### 3.4.3 Power Drift Monitoring

All SAR testing is under the EUT install full charged battery and transmit maximum output power. In DASY measurement software, the power reference measurement and power drift measurement procedures are used for monitoring the power drift of EUT during SAR test. Both these procedures measure the field at a specified reference position before and after the SAR testing. The software will calculate the field difference in dB. If the power drift more than 5%, the SAR will be retested.

### 3.4.4 Spatial Peak SAR Evaluation

The procedure for spatial peak SAR evaluation has been implemented according to the test standard. It can be conducted for 1g and 10g, as well as for user-specific masses. The DASY software includes all numerical procedures necessary to evaluate the spatial peak SAR value.

The base for the evaluation is a "cube" measurement. The measured volume must include the 1g and 10g cubes with the highest averaged SAR values. For that purpose, the center of the measured volume is aligned to the interpolated peak SAR value of a previously performed area scan.

The entire evaluation of the spatial peak values is performed within the post-processing engine (SEMCAD). The system always gives the maximum values for the 1g and 10g cubes. The algorithm to find the cube with highest averaged SAR is divided into the following stages:

- (a) Extraction of the measured data (grid and values) from the Zoom Scan
- (b) Calculation of the SAR value at every measurement point based on all stored data (A/D values and measurement parameters)
- (c) Generation of a high-resolution mesh within the measured volume
- (d) Interpolation of all measured values from the measurement grid to the high-resolution grid
- (e) Extrapolation of the entire 3-D field distribution to the phantom surface over the distance from sensor to surface
- (f) Calculation of the averaged SAR within masses of 1g and 10g

### 3.4.5 SAR Averaged Methods

In DASY, the interpolation and extrapolation are both based on the modified Quadratic Shepard's method. The interpolation scheme combines a least-square fitted function method and a weighted average method which are the two basic types of computational interpolation and approximation.

Extrapolation routines are used to obtain SAR values between the lowest measurement points and the inner phantom surface. The extrapolation distance is determined by the surface detection distance and the probe sensor offset. The uncertainty increases with the extrapolation distance. To keep the uncertainty within 1% for the 1 g and 10 g cubes, the extrapolation distance should not be larger than 5 mm.

## 4. SAR Measurement Evaluation

### 4.1 EUT Configuration and Setting

#### <Considerations Related to Proximity Sensor>

The device supports WWAN, WLAN, and Bluetooth capabilities. It is designed with a proximity sensor which can trigger/not trigger power reduction for GSM, WCDMA and LTE on Rear Face and Top Side of EUT for SAR compliance. Others RF capability (WLAN and Bluetooth) have no power reduction. The power levels for all wireless technologies and the power reduction please refer to section 4.6 of this report.

#### Proximity Sensor Triggering Distances (KDB 616217 D04 §6.2)

The proximity sensor triggering distance was determined per KDB 616217 for rear face and applicable edge. Summary for power verification per distance was tabulated in the below table.

#### Tablet Mode

Output Power Verification in dBm for EUT Rear Face											
Distance (mm)	25	26	27	28	29	30	31	32	33	34	35
WCDMA II	15.30	15.10	15.40	15.00	15.00	15.10	23.59	23.89	23.39	23.69	23.89
WCDMA IV	15.69	15.49	15.89	15.59	15.59	15.79	24.14	23.94	23.94	23.74	24.14
WCDMA V	19.30	19.50	19.40	19.40	19.50	19.10	24.11	23.71	24.11	24.11	23.81
LTE 2	14.58	14.58	14.88	14.58	14.48	14.88	23.94	23.74	23.64	23.84	23.84
LTE 4	16.47	15.97	16.17	16.37	15.97	16.37	23.70	23.70	23.70	23.70	23.50
LTE 5	18.68	18.68	18.98	18.88	18.98	18.88	23.93	23.73	23.73	24.03	23.53
LTE 7	14.47	14.37	14.27	14.47	14.17	14.27	23.66	23.96	23.46	23.86	23.66
LTE 12	17.97	18.17	18.17	18.07	18.47	17.97	23.90	23.80	23.80	23.90	24.10
LTE 13	18.07	18.27	18.27	18.07	17.97	18.37	24.08	24.28	24.18	23.98	24.08
LTE 14	18.57	18.67	18.87	18.77	18.57	18.47	23.61	23.81	23.91	23.61	23.71
LTE 17	18.78	18.58	18.78	18.58	18.98	18.48	24.16	24.16	23.76	24.16	24.16
LTE 25	15.38	15.08	14.98	14.98	15.08	14.88	23.65	23.35	23.65	23.75	23.45
LTE 26	18.77	18.77	18.97	18.87	18.67	18.87	23.59	23.59	24.09	24.09	23.89
LTE 30	13.79	13.79	13.69	13.39	13.69	13.49	22.21	22.31	21.91	22.01	22.21
LTE 38	17.48	17.98	17.68	17.68	17.58	17.58	23.50	23.80	23.80	23.30	23.70
LTE 41	16.63	16.43	16.63	16.93	16.63	16.73	23.84	23.94	23.74	23.94	23.74
LTE 66	15.42	15.62	15.42	15.92	15.82	15.82	23.78	23.98	23.88	23.58	23.88

Output Power Verification in dBm for EUT Bottom Side											
Distance (mm)	25	26	27	28	29	30	31	32	33	34	35
WCDMA II	15.20	15.30	15.30	15.10	15.00	15.50	23.79	23.79	23.79	23.79	23.49
WCDMA IV	15.79	15.89	15.99	15.99	15.89	15.69	24.04	23.94	23.74	24.04	23.74
WCDMA V	19.20	19.20	19.00	19.10	19.10	19.50	24.21	24.01	23.81	24.21	24.01
LTE 2	14.78	14.78	14.58	14.48	14.68	14.58	23.54	23.54	23.64	23.44	23.44
LTE 4	16.37	16.27	15.97	16.07	16.17	16.37	23.90	23.80	23.40	23.80	23.40
LTE 5	18.68	18.68	18.58	18.58	18.78	18.68	23.93	23.53	23.83	23.83	24.03
LTE 7	13.97	14.27	14.27	14.37	14.07	14.47	23.96	23.86	23.66	23.86	23.96
LTE 12	18.27	18.27	18.07	17.97	18.17	17.97	23.70	23.80	23.70	24.10	24.00
LTE 13	18.47	18.47	18.17	18.37	18.37	18.47	23.78	24.08	23.88	23.88	24.08
LTE 14	18.67	18.87	18.57	18.97	18.47	18.47	23.61	23.61	23.91	23.81	23.71
LTE 17	18.58	18.98	18.58	18.98	18.78	18.68	24.26	23.76	24.26	23.86	23.96
LTE 25	14.98	14.98	15.18	15.18	15.38	15.28	23.65	23.85	23.45	23.35	23.65
LTE 26	18.67	18.97	18.77	18.77	18.47	18.67	23.59	24.09	23.79	24.09	23.59
LTE 30	17.39	17.19	16.89	16.89	16.89	17.29	21.91	22.31	22.41	22.11	22.41
LTE 38	19.37	19.87	19.47	19.47	19.57	19.77	23.70	23.50	23.40	23.60	23.60
LTE 41	19.14	19.04	19.34	19.14	19.44	19.04	23.64	23.94	23.84	23.64	23.74
LTE 66	18.98	18.48	18.78	18.98	18.98	18.78	24.08	23.58	23.88	24.08	23.78

**Laptop Mode**

<b>Output Power Verification in dBm for EUT Rear Face S</b>											
Distance (mm)	14	15	16	17	18	19	20	21	22	23	24
WCDMA II	18.23	18.03	18.23	18.43	18.43	18.03	23.69	23.49	23.79	23.69	23.39
WCDMA IV	19.84	19.54	19.94	19.84	19.84	19.54	24.04	24.14	24.24	23.94	24.04
WCDMA V	22.14	22.24	21.94	22.44	22.04	21.94	23.91	24.21	23.81	23.91	24.01
LTE 2	17.82	17.82	17.42	17.82	17.42	17.72	23.94	23.54	23.44	23.84	23.94
LTE 4	19.55	19.95	19.75	19.95	19.95	19.95	23.80	23.70	23.40	23.50	23.60
LTE 5	21.96	21.76	21.66	21.46	21.46	21.66	23.53	23.73	23.73	23.83	23.63
LTE 7	16.62	16.52	16.82	16.42	16.92	16.82	23.76	23.86	23.76	23.76	23.66
LTE 12	20.45	20.85	20.45	20.45	20.75	20.65	24.00	23.80	23.90	23.80	23.90
LTE 13	21.75	21.45	21.55	21.95	21.65	21.65	24.08	24.18	23.98	24.28	24.28
LTE 14	21.83	21.53	21.83	21.93	21.53	21.63	23.81	23.51	24.01	23.51	23.61
LTE 17	20.42	20.32	19.92	19.92	20.12	20.32	24.26	23.96	23.76	24.26	23.76
LTE 25	17.37	17.47	17.07	17.37	17.37	16.97	23.85	23.55	23.55	23.45	23.65
LTE 26	20.96	20.96	21.36	21.36	20.96	21.36	23.99	23.69	23.89	23.99	23.79
LTE 30	16.89	17.09	17.39	17.29	17.09	17.19	22.41	22.21	22.01	22.11	22.31
LTE 38	19.87	19.67	19.67	19.87	19.77	19.57	23.60	23.70	23.80	23.70	23.50
LTE 41	19.24	18.94	19.14	19.34	19.04	18.94	23.84	23.44	23.74	23.44	23.64
LTE 66	18.98	18.78	18.58	18.48	18.48	18.68	24.08	23.68	23.98	23.88	23.78

**Proximity Sensor Coverage (KDB 616217 D04 §6.3)**

Since the proximity sensor is collocated with antenna in one component, the procedure for proximity sensor coverage is not required.

**Proximity Sensor Tilt Angle Influences(KDB 616217 D04 §6.4)**

The proximity sensor tilt angle influence was determined per KDB 616217 for applicable edge. Summary for proximity sensor tilt angle influence is shown in below.

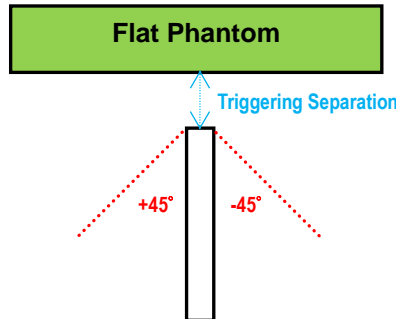

Orientation	Separation Distance (mm)	Tilt Angle											
		-45°	-40°	-30°	-20°	-10°	0°	10°	20°	30°	40°	45°	
Bottom Edge	23	○	○	○	○	○	○	○	○	○	○	○	○

**Summary for Proximity Sensor Triggering Test**

**<Tablet>**

According to the procedures noticed in KDB 616217 D04, the proximity sensor triggering distance is 30 mm for EUT Rear Face, and 30 mm for Bottom Side. The separation distance of 30 mm determined by the smallest triggering distance on Bottom Side is used to access the tilt angle influence and the sensor does not release during ±45 degree. Therefore, the smallest separation distance for tilt angle influence is 23 mm for the Bottom Side. The conservation triggering distances based on the separation distance for the sensor trigger / not triggered as EUT with power reduction at 0 mm, and EUT without power reduction at 29 mm for EUT Rear Face, and 22 mm for Bottom Side and Client decided use 20mm for Rear Face and 15mm for Bottom Side under testing.

**<Laptop>**

According to the procedures noticed in KDB 616217 D04, the proximity sensor triggering distance is 19 mm for EUT Bottom. The conservation triggering distances based on the separation distance for the sensor trigger / not triggered as EUT with power reduction at 0 mm and there is no full power of user mode when EUT of bottom touch user body.

The power reduction is depends on the proximity sensor input. For a steady SAR test, the power reduction was enabled or disabled manually by engineering software during SAR testing.

## <Connections between EUT and System Simulator>

For WWAN SAR testing, the EUT was linked and controlled by base station emulator. Communication between the EUT and the emulator was established by air link. The distance between the EUT and the communicating antenna of the emulator is larger than 50 cm and the output power radiated from the emulator antenna is at least 30 dB smaller than the output power of EUT. The EUT was set from the emulator to radiate maximum output power during SAR testing.

## <Considerations Related to WCDMA for Setup and Testing>

### Release 5 HSDPA Data Devices

The 3G SAR test reduction procedure is applied to body SAR with 12.2 kbps RMC as the primary mode. Otherwise, body SAR for HSDPA is measured using an FRC with H-Set 1 in Sub-test 1 and a 12.2 kbps RMC configured in Test Loop Mode 1, for the highest reported SAR configuration in 12.2 kbps RMC without HSDPA. HSDPA is configured according to the applicable UE category of a test device. The number of HS-DSCH/HS-PDSCHs, HARQ processes, minimum inter-TTI interval, transport block sizes and RV coding sequence are defined by the H-set. To maintain a consistent test configuration and stable transmission conditions, QPSK is used in the H-set for SAR testing. HS-DPCCH should be configured with a CQI feedback cycle of 4 ms and a CQI repetition factor of 2 to maintain a constant rate of active CQI slots. DPCCH and DPDCH gain factors ( $\beta_c$ ,  $\beta_d$ ), and HS-DPCCH power offset parameters ( $\Delta_{ACK}$ ,  $\Delta_{NACK}$ ,  $\Delta_{CQI}$ ) are set according to values indicated in below. The CQI value is determined by the UE category, transport block size, number of HS-PDSCHs and modulation used in the H-set.

Sub-test	$\beta_c$	$\beta_d$	$\beta_d$ (SF)	$\beta_c/\beta_d$	$\beta_{HS}^{(1)(2)}$	CM <sup>(3)</sup> (dB)	MPR <sup>(3)</sup> (dB)
1	2/15	15/15	64	2/15	4/15	0.0	0.0
2	12/15 <sup>(4)</sup>	15/15 <sup>(4)</sup>	64	12/15 <sup>(4)</sup>	24/15	1.0	0.0
3	15/15	8/15	64	15/8	30/15	1.5	0.5
4	15/15	4/15	64	15/4	30/15	1.5	0.5

Note 1:  $\Delta_{ACK}$ ,  $\Delta_{NACK}$  and  $\Delta_{CQI} = 30/15$  with  $\beta_{HS} = 30/15 * \beta_c$ .  
 Note 2: For the HS-DPCCH power mask requirement test in clause 5.2C, 5.7A, and the Error Vector Magnitude (EVM) with HS-DPCCH test in clause 5.13.1A, and HSDPA EVM with phase discontinuity in clause 5.13.1AA,  $\Delta_{ACK}$  and  $\Delta_{NACK} = 30/15$  with  $\beta_{HS} = 30/15 * \beta_c$ , and  $\Delta_{CQI} = 24/15$  with  $\beta_{HS} = 24/15 * \beta_c$ .  
 Note 3: CM = 1 for  $\beta_c/\beta_d = 12/15$ ,  $\beta_{HS}/\beta_c = 24/15$ . For all other combinations of DPDCH, DPCCH and HS-DPCCH the MPR is based on the relative CM difference. This is applicable for only UEs that support HSDPA in release 6 and later releases.  
 Note 4: For subtest 2 the  $\beta_c/\beta_d$  ratio of 12/15 for the TFC during the measurement period (TF1, TF0) is achieved by setting the signalled gain factors for the reference TFC (TF1, TF1) to  $\beta_c = 11/15$  and  $\beta_d = 15/15$ .

### Release 6 HSPA Data Devices

The 3G SAR test reduction procedure is applied to body SAR with 12.2 kbps RMC as the primary mode. Otherwise, body SAR for HSPA is measured with E-DCH Sub-test 5, using H-Set 1 and QPSK for FRC and a 12.2 kbps RMC configured in Test Loop Mode 1 and power control algorithm 2, according to the highest reported body SAR configuration in 12.2 kbps RMC without HSPA. When VOIP applies to head exposure, the 3G SAR test reduction procedure is applied with 12.2 kbps RMC as the primary mode. Otherwise, the same HSPA configuration used for body SAR measurements are applied to head exposure testing. Due to inner loop power control requirements in HSPA, a communication test set is required for output power and SAR tests. The 12.2 kbps RMC, FRC H-set 1 and E-DCH configurations for HSPA are configured according to the  $\beta$  values indicated in below.

# SAR Test Report

Sub-test	$\beta_c$	$\beta_d$	$\beta_d$ (SF)	$\beta_c/\beta_d$	$\beta_{HS}^{(1)}$	$\beta_{ec}$	$\beta_{ed}^{(4)/(5)}$	$\beta_{ed}$ (SF)	$\beta_{ed}$ (Codes)	CM <sup>(2)</sup> (dB)	MPR <sup>(2)/(6)</sup> (dB)	AG <sup>(5)</sup> Index	E-TFCI
1	11/15 <sup>(3)</sup>	15/15 <sup>(3)</sup>	64	11/15 <sup>(3)</sup>	22/15	209/225	1309/225	4	1	1.0	0.0	20	75
2	6/15	15/15	64	6/15	12/15	12/15	94/75	4	1	3.0	2.0	12	67
3	15/15	9/15	64	15/9	30/15	30/15	$\beta_{ed1}$ : 47/15 $\beta_{ed2}$ : 47/15	4	2	2.0	1.0	15	92
4	2/15	15/15	64	2/15	4/15	2/15	56/75	4	1	3.0	2.0	17	71
5	15/15	0	-	-	5/15	5/15	47/15	4	1	1.0	0.0	12	67

Note 1: For sub-test 1 to 4,  $\Delta_{ACK}$ ,  $\Delta_{NACK}$  and  $\Delta_{CQI} = 30/15$  with  $\beta_{HS} = 30/15 * \beta_c$ . For sub-test 5,  $\Delta_{ACK}$ ,  $\Delta_{NACK}$  and  $\Delta_{CQI} = 5/15$  with  $\beta_{HS} = 5/15 * \beta_c$ .  
 Note 2: CM = 1 for  $\beta_c/\beta_d = 12/15$ ,  $\beta_{HS}/\beta_c = 24/15$ . For all other combinations of DPDCH, DPCCH, HS-DPCCH, E-DPDCH and E-DPCCH the MPR is based on the relative CM difference.  
 Note 3: For subtest 1 the  $\beta_c/\beta_d$  ratio of 11/15 for the TFC during the measurement period (TF1, TF0) is achieved by setting the signalled gain factors for the reference TFC (TF1, TF1) to  $\beta_c = 10/15$  and  $\beta_d = 15/15$ .  
 Note 4: In case of testing by UE using E-DPDCH Physical Layer category 1, Sub-test 3 is omitted according to TS25.306 Table 5.1g.  
 Note 5:  $\beta_{ed}$  can not be set directly; it is set by Absolute Grant Value.  
 Note 6: For subtests 2, 3 and 4, UE may perform E-DPDCH power scaling at max power which could result in slightly smaller MPR values.

## DC-HSDPA SAR Guidance

The 3G SAR test reduction procedure is applied to DC-HSDPA with 12.2 kbps RMC as the primary mode. Otherwise, when SAR is required for Rel. 5 HSDPA, SAR is required for Rel. 8 DC-HSDPA. Power is measured for DC-HSDPA according to the H-Set 12, FRC configuration in Table C.8.1.12 of 3GPP TS 34.121-1 to determine SAR test reduction. A primary and a secondary serving HS-DSCH Cell are required to perform the power measurement and for the results to be acceptable.

## <Considerations Related to LTE for Setup and Testing>

This device contains LTE transmitter which follows 3GPP standards, is category 3, supports both QPSK and QAM modulations, and supported LTE band and channel bandwidth is listed in below. The output power was tested per 3GPP TS 36.521-1 maximum transmit procedures for both QPSK and QAM modulation. The results please refer to section 4.6 of this report.

EUT Supported LTE Band and Channel Bandwidth						
LTE Band	BW 1.4 MHz	BW 3 MHz	BW 5 MHz	BW 10 MHz	BW 15 MHz	BW 20 MHz
2	V	V	V	V	V	V
4	V	V	V	V	V	V
5	V	V	V	V		
7			V	V	V	V
12	V	V	V	V		
13			V	V		
14			V	V		
17			V	V		
25	V	V	V	V	V	V
26	V	V	V	V	V	
30			V	V		
38			V	V	V	V
41			V	V	V	V
66	V	V	V	V	V	V

# SAR Test Report

The LTE maximum power reduction (MPR) in accordance with 3GPP TS 36.101 is active all times during LTE operation. The allowed MPR for the maximum output power is specified in below.

Modulation	Channel Bandwidth / RB Configurations						LTE MPR Setting (dB)
	BW 1.4 MHz	BW 3 MHz	BW 5 MHz	BW 10 MHz	BW 15 MHz	BW 20 MHz	
QPSK	> 5	> 4	> 8	> 12	> 16	> 18	1
16QAM	<= 5	<= 4	<= 8	<= 12	<= 16	<= 18	1
16QAM	> 5	> 4	> 8	> 12	> 16	> 18	2
64QAM	<= 5	<= 4	<= 8	<= 12	<= 16	<= 18	2
64QAM	> 5	> 4	> 8	> 12	> 16	> 18	3

**Note:** MPR is according to the standard and implemented in the circuit (mandatory).

In addition, the device is compliant with additional maximum power reduction (A-MPR) requirements defined in 3GPP TS 36.101 section 6.2.4 that was disabled for all FCC compliance testing.

During LTE SAR testing, the related parameters of operating band, channel bandwidth, uplink channel number, modulation type, and RB was set in base station simulator. When the EUT has registered and communicated to base station simulator, the simulator set to make EUT transmitting the maximum radiated power.

## TDD-LTE Setup Configurations

According to KDB 941225 D05, SAR testing for TDD-LTE device must be tested using a fixed periodic duty factor according to the highest transmission duty factor implemented for the device and supported by the defined 3GPP TDD-LTE configurations. The TDD-LTE of this device supports frame structure type 2 defined in 3GPP TS 36.211 section 4.2, and the frame structure configuration can be referred to below.

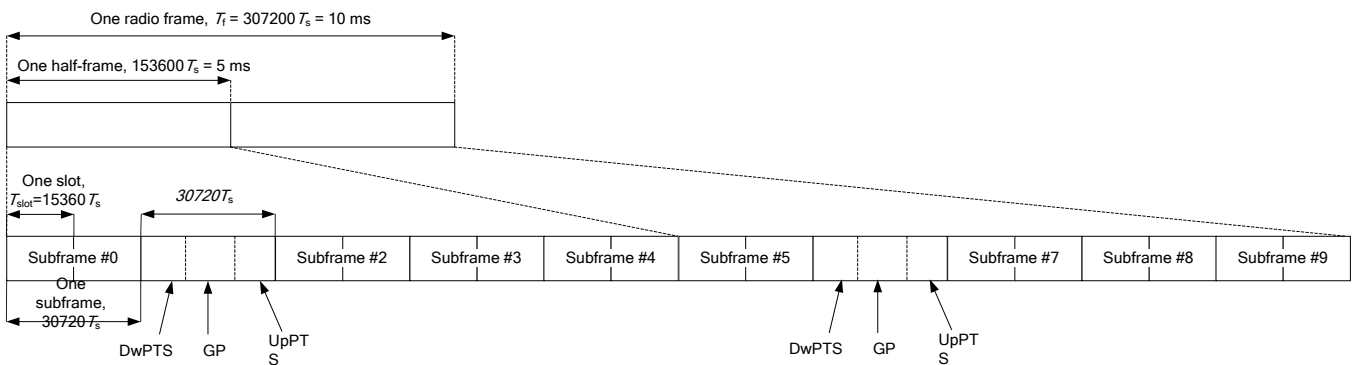

3GPP TS 36.211 Figure 4.2-1: Frame Structure Type 2

Special Subframe Configuration	Normal Cyclic Prefix in Downlink			Extended Cyclic Prefix in Downlink		
	DwPTS	UpPTS		DwPTS	UpPTS	
		Normal Cyclic Prefix in Uplink	Extended Cyclic Prefix in Uplink		Normal Cyclic Prefix in Uplink	Extended Cyclic Prefix in Uplink
0	$6592 \cdot T_s$	$2192 \cdot T_s$	$2560 \cdot T_s$	$7680 \cdot T_s$	$2192 \cdot T_s$	$2560 \cdot T_s$
1	$19760 \cdot T_s$			$20480 \cdot T_s$		
2	$21952 \cdot T_s$			$23040 \cdot T_s$		
3	$24144 \cdot T_s$			$25600 \cdot T_s$		
4	$26336 \cdot T_s$	$4384 \cdot T_s$	$5120 \cdot T_s$	$7680 \cdot T_s$	$4384 \cdot T_s$	$5120 \cdot T_s$
5	$6592 \cdot T_s$			$20480 \cdot T_s$		
6	$19760 \cdot T_s$			$23040 \cdot T_s$		

# SAR Test Report

7	21952 • Ts			12800 • Ts		
8	24144 • Ts			-	-	-
9	13168 • Ts			-	-	-

3GPP TS 36.211 Table 4.2-1: Configuration of Special Subframe

Uplink-Downlink Configuration	Downlink-to-Uplink Switch-Point Periodicity	Subframe Number									
		0	1	2	3	4	5	6	7	8	9
0	5 ms	D	S	U	U	U	D	S	U	U	U
1	5 ms	D	S	U	U	D	D	S	U	U	D
2	5 ms	D	S	U	D	D	D	S	U	D	D
3	10 ms	D	S	U	U	U	D	D	D	D	D
4	10 ms	D	S	U	U	D	D	D	D	D	D
5	10 ms	D	S	U	D	D	D	D	D	D	D
6	5 ms	D	S	U	U	U	D	S	U	U	D

3GPP TS 36.211 Table 4.2-2: Uplink-Downlink Configurations

The variety of different TD-LTE uplink-downlink configurations allows a network operator to allocate the network's capacity between uplink and downlink traffic to meet the needs of the network. The uplink duty cycle of these seven configurations can readily be computed and shown in below.

UL-DL Configuration	0	1	2	3	4	5	6
Highest Duty-Cycle	63.33%	43.33%	23.33%	31.67%	21.67%	11.67%	53.33%

Considering the highest transmission duty cycle, TDD-LTE was tested using Uplink-Downlink Configuration 0 with 6 uplink subframe and 2 special subframe. The special subframe was set to special subframe configuration 7 using extended cyclic prefix uplink. Therefore, SAR testing for TDD-LTE was performed at the maximum output power with highest transmission duty cycle of 63.33%.

## LTE Downlink Carrier Aggregation(CA)Setup Configurations

LTE Carrier Aggregation (CA) was defined in 3GPP release 10 and higher. The LTE device in CA mode has one Primary Component Carrier (PCC) and one or more Secondary Component Carriers (SCC). PCC acts as the anchor carrier and can optionally cross-schedule data transmission on SCC. The RRC connection is only handled by one cell, the PCC for downlink and uplink communications. After making a data connection to the PCC, the LTE device adds the SCC on the downlink only. All uplink communications and acknowledgements remain identical to release 8 specifications on the PCC. The combinations of downlink carrier aggregation supported by this device are listed in below.





# SAR Test Report

	Intra Band		Inter Band								
	Contiguous	2CC Non-Contiguous	2 Bands / 2CC	2 Bands / 3CC	2 Bands / 4CC	3 Bands / 3CC	3 Bands / 4CC	3 Bands / 5CC	4 Bands / 4CC	4 Bands / 5CC	
LTE Downlink CA-Configure	CA_5B	CA_2A-2A	CA_2A-5A	CA_2A-2A-5A		CA_2A-5A-30A	CA_2A-2A-5A-30A				
			CA_2A-30A	CA_2A-2A-5B		CA_2A-5A-66A	CA_2A-2A-5A-66A				
			CA_2A-66A	CA_2A-2A-30A			CA_2A-2A-30A-66A				
				CA_2A-66A	CA_2A-2A-66A	CA_2A-2A-66A-66A		CA_2A-5A-66A-66A	CA_2A-5B-66A-66A		
				CA_2A-66B	CA_2A-2A-66B		CA_2A-5A-66B	CA_2A-2A-5A-66B			
				CA_2A-66C	CA_2A-2A-66C		CA_2A-5A-66C	CA_2A-2A-5A-66C			
				CA_2A-5B			CA_2A-5B-30A				
				CA_2A-66A-66A			CA_2A-5B-66A	CA_2A-5B-66C		CA_2A-5A-30A-66A	CA_2A-5B-30A-66A
	CA_66B	CA_66A-66A		CA_30A-66A-66A		CA_2A-30A-66A	CA_2A-30A-66A-66A				
	CA_66C	CA_66A-66B		CA_5A-66A-66A	CA_5B-66A-66A		CA_5A-30A-66A	CA_5A-30A-66A-66A			
	CA_66D	CA_66A-66C		CA_5A-66B	CA_5B-66C	CA_5A-30A-66A					
			CA_5A-30A	CA_5A-66C				CA_5B-30A-66A	CA_5B-30A-66A-66A		
			CA_5A-66A	CA_5B-30A							
			CA_30A-66A	CA_5B-66A							
			CA_2A-12A	CA_12A-66A-66A		CA_2A-12A-30A	CA_2A-2A-12A-30A				
			CA_12A-30A			CA_2A-12A-66A	CA_2A-2A-12A-66A				
			CA_12A-66A			CA_12A-30A-66A	CA_2A-12A-66A-66A			CA_2A-12A-30A-66A	
							CA_12A-30A-66A-66A				
			CA_2A-13A	CA_2A-2A-13A	CA_2A-46D				CA_2A-13A-46D		
			CA_13A-46A						CA_2A-46D-66A		
			CA_46A-66A						CA_13A-46D-66A		
			CA_13A-66A	CA_13A-66A-66A							
				CA_13A-66B							
				CA_13A-66C							
						CA_2A-13A-66A	CA_2A-2A-13A-66A				
							CA_2A-13A-66A-66A				
							CA_2A-13A-66B				
							CA_2A-13A-66C				
		CA_4A-4A	CA_2A-4A	CA_2A-2A-4A							
				CA_2A-4A-4A		CA_2A-4A-5A					
						CA_2A-4A-5A					
							CA_2A-4A-13A				
		CA_2A-14A					CA_2A-14A-30A				
		CA_14A-30A									
		CA_14A-66A	CA_14A-66A-66A								
		CA_2A-29A									
		CA_2A-46A									
		CA_4A-5A									
		CA_4A-13A									
		CA_4A-46A									
	CA_25A-25A	CA_25A-26A									
		CA_29A-30A									
		CA_29A-66A									
	CA_41C										

This device does not support full CA (Carrier Aggregation) features on 3GPP release 12. Its capability for LTE CA is for LTE band 41 only and supported configuration is shown in above. For network enhancement features, it does not support Wi-Fi Offloading, Enhanced SC-FDMA, Uplink MIMO, CoMP, HetNet, Relay, SON, Cross-Carrier Scheduling, eICIC, Enhanced Downlink MIMO, MBMS, M2M/D2D. All other uplink communications are identical to the LTE Release 8 specifications.

### <Considerations Related to WLAN for Setup and Testing>

In general, various vendor specific external test software and chipset based internal test modes are typically used for SAR measurement. These chipset based test mode utilities are generally hardware and manufacturer dependent, and often include substantial flexibility to reconfigure or reprogram a device. A Wi-Fi device must be configured to transmit continuously at the required data rate, channel bandwidth and signal modulation, using the highest transmission duty factor supported by the test mode tools for SAR measurement. The test frequencies established using test mode must correspond to the actual channel frequencies. When 802.11 frame gaps are accounted for in the transmission, a maximum transmission duty factor of 92 - 96% is typically achievable in most test mode configurations. A minimum transmission duty factor of 85% is required to avoid certain hardware and device implementation issues related to wide range SAR scaling. In addition, a periodic transmission duty factor is required for current generation SAR systems to measure SAR correctly. The reported SAR must be scaled to 100% transmission duty factor to determine compliance at the maximum tune-up tolerance limit.

According to KDB 248227 D01, this device has installed WLAN engineering testing software which can provide continuous transmitting RF signal. During WLAN SAR testing, this device was operated to transmit continuously at the maximum transmission duty with specified transmission mode, operating frequency, lowest data rate, and maximum output power.

### Initial Test Configuration

An initial test configuration is determined for OFDM transmission modes in 2.4 GHz and 5 GHz bands according to the channel bandwidth, modulation and data rate combination(s) with the highest maximum output power specified for production units in each standalone and aggregated frequency band. When the same maximum power is specified for multiple transmission modes in a frequency band, the largest channel bandwidth, lowest order modulation, lowest data rate and lowest order 802.11a/g/n/ac mode is used for SAR measurement, on the highest measured output power channel in the initial test configuration, for each frequency band.

### Subsequent Test Configuration

SAR measurement requirements for the remaining 802.11 transmission mode configurations that have not been tested in the initial test configuration are determined separately for each standalone and aggregated frequency band, in each exposure condition, according to the maximum output power specified for production units. Additional power measurements may be required to determine if SAR measurements are required for subsequent highest output power channels in a subsequent test configuration. When the highest reported SAR for the initial test configuration according to the initial test position or fixed exposure position requirements, is adjusted by the ratio of the subsequent test configuration to initial test configuration specified maximum output power and the adjusted SAR is  $\leq 1.2$  W/kg, SAR is not required for that subsequent test configuration.

### SAR Test Configuration and Channel Selection

When multiple channel bandwidth configurations in a frequency band have the same specified maximum output power, the initial test configuration is using largest channel bandwidth, lowest order modulation, lowest data rate, and lowest order 802.11 mode (i.e., 802.11a is chosen over 802.11n then 802.11ac or 802.11g is chosen over 802.11n). After an initial test configuration is determined, if multiple test channels have the same measured maximum output power, the channel chosen for SAR measurement is determined according to the following.

- 1) The channel closest to mid-band frequency is selected for SAR measurement.
- 2) For channels with equal separation from mid-band frequency; for example, high and low channels or two mid-band channels, the higher frequency (number) channel is selected for SAR measurement.

### Test Reduction for U-NII-1 (5.2 GHz) and U-NII-2A (5.3 GHz) Bands

For devices that operate in both U-NII bands using the same transmitter and antenna(s), SAR test reduction is determined according to the following.

- 1) When the same maximum output power is specified for both bands, begin SAR measurement in U-NII-2A band by applying the OFDM SAR requirements. If the highest reported SAR for a test configuration is  $\leq 1.2$  W/kg, SAR is not required for U-NII-1 band for that configuration (802.11 mode and exposure condition).
- 2) When different maximum output power is specified for the bands, begin SAR measurement in the band with higher specified maximum output power. The highest reported SAR for the tested configuration is adjusted by the ratio of lower to higher specified maximum output power for the two bands. When the adjusted SAR is  $\leq 1.2$  W/kg, SAR is not required for the band with lower maximum output power in that test configuration.

## <Considerations Related to Bluetooth for Setup and Testing>

This device has installed Bluetooth engineering testing software which can provide continuous transmitting RF signal. During Bluetooth SAR testing, this device was operated to transmit continuously at the maximum transmission duty with specified transmission mode, operating frequency, lowest data rate, and maximum output power.

The Bluetooth call box has been used during SAR measurement and the EUT was set to DH5 mode at the maximum output power. Its duty factor was calculated as below and the measured SAR for Bluetooth would be scaled to the 100% transmission duty factor to determine compliance.



**Time-domain plot for Bluetooth transmission signal**

The duty factor of Bluetooth signal has been calculated as following.

$$\text{Duty Factor} = \text{Pulse Width} / \text{Total Period} = ( 12.9 - 10.02 ) / ( 13.77 - 10.02 ) = 76.80 \%$$

## 4.2 EUT Testing Position

### 4.2.1 Body Exposure Conditions

For full-size tablet, according to KDB 616217 D04, SAR evaluation is required for back surface and edges of the devices. The back surface and edges of the tablet are tested with the tablet touching the phantom. Exposures from antennas through the front surface of the display section of a tablet are generally limited to the user's hands. Exposures to hands for typical consumer transmitters used in tablets are not expected to exceed the extremity SAR limit; therefore, SAR evaluation for the front surface of tablet display screens are generally not necessary. When voice mode is supported on a tablet and it is limited to speaker mode or headset operations only, additional SAR testing for this type of voice use is not required.

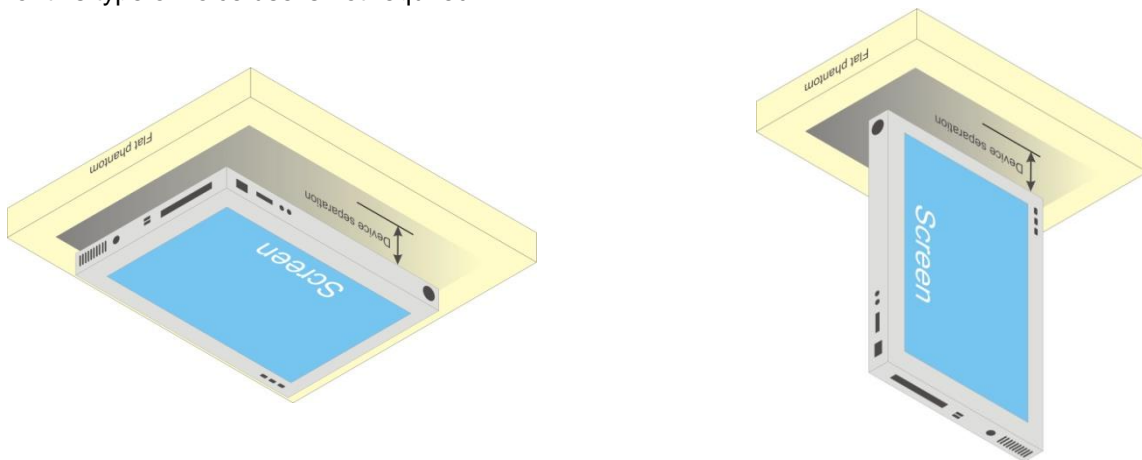

Fig-4.1 Illustration for Tablet Setup

For laptop PC, according to KDB 616217 D04, SAR evaluation is required for the bottom surface of the keyboard. This EUT was tested in the base of EUT directly against the flat phantom. The required minimum test separation distance for incorporating transmitters and antennas into laptop computer display is determined with the display screen opened at an angle of 90° to the keyboard compartment.

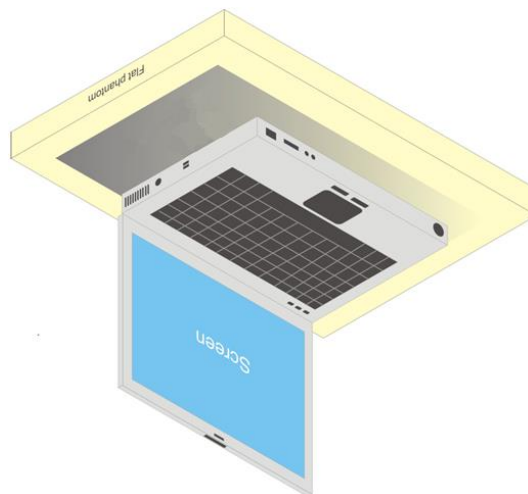

Fig-4.2 Illustration for Laptop Setup

**4.3 Tissue Verification**

The measuring results for tissue simulating liquid are shown as below.

Frequency (MHz)	Liquid Temp. (°C)	Measured Conductivity ( $\sigma$ )	Measured Permittivity ( $\epsilon_r$ )	Target Conductivity ( $\sigma$ )	Target Permittivity ( $\epsilon_r$ )	Conductivity Deviation (%)	Permittivity Deviation (%)	Test Date
750	23	0.897	42.163	0.89	41.9	0.79	0.63	Nov. 21, 2020
750	23	0.9	42.167	0.89	41.9	1.12	0.64	Nov. 27, 2020
750	23.2	0.886	43.472	0.89	41.9	-0.45	3.75	Nov. 28, 2020
835	23.6	0.921	41.933	0.9	41.5	2.33	1.04	Nov. 22, 2020
835	23.2	0.918	41.689	0.9	41.5	2.00	0.46	Nov. 25, 2020
835	23.2	0.909	42.379	0.9	41.5	1.00	2.12	Nov. 26, 2020
835	23.4	0.919	42.035	0.9	41.5	2.11	1.29	Nov. 29, 2020
1750	23.2	1.319	40.264	1.37	40.1	-3.72	0.41	Nov. 23, 2020
1750	23.5	1.314	39.013	1.37	40.1	-4.09	-2.71	Nov. 24, 2020
1750	23.2	1.325	38.941	1.37	40.1	-3.28	-2.89	Nov. 25, 2020
1750	23.2	1.325	39.349	1.37	40.1	-3.28	-1.87	Nov. 26, 2020
1750	23.4	1.329	41.231	1.37	40.1	-2.99	2.82	Nov. 29, 2020
1900	23.2	1.456	39.753	1.4	40	4.00	-0.62	Nov. 23, 2020
1900	23.2	1.455	38.385	1.4	40	3.93	-4.04	Nov. 25, 2020
1900	23.4	1.456	40.887	1.4	40	4.00	2.22	Nov. 29, 2020
2300	23.4	1.721	39.432	1.67	39.5	3.05	-0.17	Nov. 17, 2020
2300	23.4	1.714	39.234	1.67	39.5	2.63	-0.67	Nov. 19, 2020
2300	23.1	1.73	38.874	1.67	39.5	3.59	-1.58	Nov. 20, 2020
2450	23.4	1.869	37.935	1.8	39.2	3.83	-3.23	Nov. 16, 2020
2450	23.4	1.874	37.983	1.8	39.2	4.11	-3.10	Nov. 18, 2020
2450	23.1	1.885	38.34	1.8	39.2	4.72	-2.19	Nov. 20, 2020
2600	23.4	2.035	38.413	1.96	39	3.83	-1.51	Nov. 17, 2020
2600	23.4	2.031	38.237	1.96	39	3.62	-1.96	Nov. 19, 2020
2600	23.6	2.051	37.81	1.96	39	4.64	-3.05	Nov. 22, 2020
2600	23	2.043	37.822	1.96	39	4.23	-3.02	Nov. 27, 2020
5250	23.4	4.713	36.082	4.71	35.9	0.06	0.51	Nov. 18, 2020
5250	23.4	4.573	36.637	4.71	35.9	-2.91	2.05	Nov. 19, 2020
5600	23.4	5.178	34.66	5.07	35.5	2.13	-2.37	Nov. 16, 2020
5600	23.4	5.054	35.608	5.07	35.5	-0.32	0.30	Nov. 18, 2020
5600	23.1	4.87	33.973	5.07	35.5	-3.94	-4.30	Nov. 20, 2020
5750	23.4	5.194	35.42	5.22	35.4	-0.50	0.06	Nov. 18, 2020
5750	23.4	5.061	35.952	5.22	35.4	-3.05	1.56	Nov. 19, 2020

**Note:**

The dielectric properties of the tissue simulating liquid have been measured within 24 hours before the SAR testing and within  $\pm 10\%$  of the target values. Liquid temperature during the SAR testing has kept within  $\pm 2^\circ\text{C}$ .

# SAR Test Report

## 4.4 System Validation

The SAR measurement system was validated according to procedures in KDB 865664 D01. The validation status in tabulated summary is as below.

Test Date	Probe S/N	Calibration Point	Measured Conductivity ( $\sigma$ )	Measured Permittivity ( $\epsilon_r$ )	Validation for CW			Validation for Modulation		
					Sensitivity Range	Probe Linearity	Probe Isotropy	Modulation Type	Duty Factor	PAR
Nov. 21, 2020	3971	750	0.897	42.163	Pass	Pass	Pass	N/A	N/A	N/A
Nov. 27, 2020	3971	750	0.9	42.167	Pass	Pass	Pass	N/A	N/A	N/A
Nov. 28, 2020	3971	750	0.886	43.472	Pass	Pass	Pass	N/A	N/A	N/A
Nov. 22, 2020	3971	835	0.921	41.933	Pass	Pass	Pass	N/A	N/A	N/A
Nov. 25, 2020	3971	835	0.918	41.689	Pass	Pass	Pass	N/A	N/A	N/A
Nov. 26, 2020	3971	835	0.909	42.379	Pass	Pass	Pass	N/A	N/A	N/A
Nov. 29, 2020	7555	835	0.919	42.035	Pass	Pass	Pass	N/A	N/A	N/A
Nov. 23, 2020	3971	1750	1.319	40.264	Pass	Pass	Pass	N/A	N/A	N/A
Nov. 24, 2020	3971	1750	1.314	39.013	Pass	Pass	Pass	N/A	N/A	N/A
Nov. 25, 2020	3971	1750	1.325	38.941	Pass	Pass	Pass	N/A	N/A	N/A
Nov. 26, 2020	3971	1750	1.325	39.349	Pass	Pass	Pass	N/A	N/A	N/A
Nov. 29, 2020	7555	1750	1.329	41.231	Pass	Pass	Pass	N/A	N/A	N/A
Nov. 23, 2020	3971	1900	1.456	39.753	Pass	Pass	Pass	N/A	N/A	N/A
Nov. 25, 2020	3971	1900	1.455	38.385	Pass	Pass	Pass	N/A	N/A	N/A
Nov. 29, 2020	7555	1900	1.456	40.887	Pass	Pass	Pass	N/A	N/A	N/A
Nov. 17, 2020	3650	2300	1.721	39.432	Pass	Pass	Pass	N/A	N/A	N/A
Nov. 19, 2020	3971	2300	1.714	39.234	Pass	Pass	Pass	N/A	N/A	N/A
Nov. 20, 2020	3971	2300	1.73	38.874	Pass	Pass	Pass	N/A	N/A	N/A
Nov. 16, 2020	3650	2450	1.869	37.935	Pass	Pass	Pass	OFDM	N/A	Pass
Nov. 18, 2020	3650	2450	1.874	37.983	Pass	Pass	Pass	OFDM	N/A	Pass
Nov. 20, 2020	3971	2450	1.885	38.34	Pass	Pass	Pass	OFDM	N/A	Pass
Nov. 17, 2020	3650	2600	2.035	38.413	Pass	Pass	Pass	N/A	N/A	N/A
Nov. 19, 2020	3971	2600	2.031	38.237	Pass	Pass	Pass	N/A	N/A	N/A
Nov. 22, 2020	3971	2600	2.051	37.81	Pass	Pass	Pass	N/A	N/A	N/A
Nov. 27, 2020	3971	2600	2.043	37.822	Pass	Pass	Pass	N/A	N/A	N/A
Nov. 18, 2020	3650	5250	4.713	36.082	Pass	Pass	Pass	OFDM	N/A	Pass
Nov. 19, 2020	3971	5250	4.573	36.637	Pass	Pass	Pass	OFDM	N/A	Pass
Nov. 16, 2020	3650	5600	5.178	34.66	Pass	Pass	Pass	OFDM	N/A	Pass
Nov. 18, 2020	3650	5600	5.054	35.608	Pass	Pass	Pass	OFDM	N/A	Pass
Nov. 20, 2020	3971	5600	4.87	33.973	Pass	Pass	Pass	OFDM	N/A	Pass
Nov. 18, 2020	3650	5750	5.194	35.42	Pass	Pass	Pass	OFDM	N/A	Pass
Nov. 19, 2020	3971	5750	5.061	35.952	Pass	Pass	Pass	OFDM	N/A	Pass

**4.5 System Verification**

The measuring result for system verification is tabulated as below.

Test Date	Frequency (MHz)	1W Target SAR-1g (W/kg)	Measured SAR-1g (W/kg)	Normalized to 1W SAR-1g (W/kg)	Deviation (%)	Dipole S/N	Probe S/N	DAE S/N
Nov. 21, 2020	750	8.48	0.421	8.42	-0.71	1013	3971	917
Nov. 27, 2020	750	8.48	0.384	7.68	-9.43	1013	3971	917
Nov. 28, 2020	750	8.48	0.386	7.72	-8.96	1013	3971	917
Nov. 22, 2020	835	9.52	0.471	9.42	-1.05	4d121	3971	917
Nov. 25, 2020	835	9.52	0.47	9.40	-1.26	4d121	3971	917
Nov. 26, 2020	835	9.52	0.479	9.58	0.63	4d121	3971	917
Nov. 29, 2020	835	9.52	0.48	9.60	0.84	4d121	7555	1589
Nov. 23, 2020	1750	36.00	1.94	38.80	7.78	1055	3971	917
Nov. 24, 2020	1750	36.00	1.8	36.00	0.00	1055	3971	917
Nov. 25, 2020	1750	36.00	1.83	36.60	1.67	1055	3971	917
Nov. 26, 2020	1750	36.00	1.71	34.20	-5.00	1055	3971	917
Nov. 29, 2020	1750	36.00	1.83	36.60	1.67	1055	7555	1589
Nov. 23, 2020	1900	40.30	1.84	36.80	-8.68	5d036	3971	917
Nov. 25, 2020	1900	40.30	1.98	39.60	-1.74	5d036	3971	917
Nov. 29, 2020	1900	40.30	1.86	37.20	-7.69	5d036	7555	1589
Nov. 17, 2020	2300	48.80	2.37	47.40	-2.87	1004	3650	861
Nov. 19, 2020	2300	48.80	2.29	45.80	-6.15	1004	3971	917
Nov. 20, 2020	2300	48.80	2.4	48.00	-1.64	1004	3971	917
Nov. 16, 2020	2450	51.60	2.49	49.80	-3.49	737	3650	861
Nov. 18, 2020	2450	51.60	2.47	49.40	-4.26	737	3650	861
Nov. 20, 2020	2450	51.60	2.55	51.00	-1.16	737	3971	917
Nov. 17, 2020	2600	55.50	2.64	52.80	-4.86	1020	3650	861
Nov. 19, 2020	2600	55.50	2.7	54.00	-2.70	1020	3971	917
Nov. 22, 2020	2600	55.50	2.74	54.80	-1.26	1020	3971	917
Nov. 27, 2020	2600	55.50	2.71	54.20	-2.34	1020	3971	917
Nov. 18, 2020	5250	79.70	4.2	84.00	5.40	1019	3650	861
Nov. 19, 2020	5250	79.70	3.88	77.60	-2.63	1019	3971	917
Nov. 16, 2020	5600	83.80	4.55	91.00	8.59	1019	3650	861
Nov. 18, 2020	5600	83.80	4.56	91.20	8.83	1019	3650	861
Nov. 20, 2020	5600	83.80	4.21	84.20	0.48	1019	3971	917
Nov. 18, 2020	5750	80.40	3.91	78.20	-2.74	1019	3650	861
Nov. 19, 2020	5750	80.40	3.72	74.40	-7.46	1019	3971	917

**Note:**

Comparing to the reference SAR value provided by SPEAG in dipole calibration certificate, the deviation of system check results is within its specification of 10 %. The result indicates the system check can meet the variation criterion and the plots please refer to Appendix A of this report.



## **4.6 Maximum Output Power**

### **4.6.1 Maximum Target Conducted Power**

Refer to Appendix E.

### **4.6.2 Measured Conducted Power Result**

Refer to Appendix F.

## **4.7 SAR Testing Results**

### **4.7.1 SAR Test Reduction Considerations**

#### **<KDB 447498 D01, General RF Exposure Guidance>**

Testing of other required channels within the operating mode of a frequency band is not required when the reported SAR for the mid-band or highest output power channel is:

- (1)  $\leq 0.8$  W/kg or 2.0 W/kg, for 1-g or 10-g respectively, when the transmission band is  $\leq 100$  MHz
- (2)  $\leq 0.6$  W/kg or 1.5 W/kg, for 1-g or 10-g respectively, when the transmission band is between 100 MHz and 200 MHz
- (3)  $\leq 0.4$  W/kg or 1.0 W/kg, for 1-g or 10-g respectively, when the transmission band is  $\geq 200$  MHz

When SAR is not measured at the maximum power level allowed for production units, the measured SAR will be scaled to the maximum tune-up tolerance limit to determine compliance. The scaling factor for the tune-up power is defined as maximum tune-up limit (mW) / measured conducted power (mW). The reported SAR would be calculated by measured SAR x tune-up power scaling factor.

The SAR has been measured with highest transmission duty factor supported by the test mode tools for WLAN and/or Bluetooth. When the transmission duty factor could not achieve 100%, the reported SAR will be scaled to 100% transmission duty factor to determine compliance at the maximum tune-up power. The scaling factor for the duty factor is defined as 100% / transmission duty cycle (%). The reported SAR would be calculated by measured SAR x tune-up power scaling factor x duty cycle scaling factor.

#### **<KDB 941225 D01, 3G SAR Measurement Procedures>**

The mode tested for SAR is referred to as the primary mode. The equivalent modes considered for SAR test reduction are denoted as secondary modes. Both primary and secondary modes must be in the same frequency band. When the maximum output power and tune-up tolerance specified for production units in a secondary mode is  $\leq 1/4$  dB higher than the primary mode or when the highest reported SAR of the primary mode is scaled by the ratio of specified maximum output power and tune-up tolerance of secondary to primary mode and the adjusted SAR is  $\leq 1.2$  W/kg, SAR measurement is not required for the secondary mode.

### <KDB 941225 D05, SAR Evaluation Considerations for LTE Devices>

#### (1) QPSK with 1 RB and 50% RB allocation

Start with the largest channel bandwidth and measure SAR, using the RB offset and required test channel combination with the highest maximum output power among RB offsets at the upper edge, middle and lower edge of each required test channel. When the reported SAR is  $\leq 0.8$  W/kg, testing of the remaining RB offset configurations and required test channels is not required; otherwise, SAR is required for the remaining required test channels and only for the RB offset configuration with the highest output power for that channel. When the reported SAR of a required test channel is  $> 1.45$  W/kg, SAR is required for all three RB offset configurations for that required test channel.

#### (2) QPSK with 100% RB allocation

SAR is not required when the highest maximum output power for 100% RB allocation is less than the highest maximum output power in 50% and 1 RB allocations and the highest reported SAR for 1 RB and 50% RB allocation are  $\leq 0.8$  W/kg. Otherwise, SAR is measured for the highest output power channel; and if the reported SAR is  $> 1.45$  W/kg, the remaining required test channels must also be tested.

#### (3) Higher order modulations

SAR is required only when the highest maximum output power for the configuration in the higher order modulation is  $> 1/2$  dB higher than the same configuration in QPSK or when the reported SAR for the QPSK configuration is  $> 1.45$  W/kg.

#### (4) Other channel bandwidth

SAR is required when the highest maximum output power of the smaller channel bandwidth is  $> 1/2$  dB higher than the equivalent channel configurations in the largest channel bandwidth configuration or the reported SAR of a configuration for the largest channel bandwidth is  $> 1.45$  W/kg.

### <Power Confirmation for SAR Test Exclusion for LTE Downlink CA>

According to KDB 941225 D05A, the uplink maximum output power below was measured with downlink CA active on the channel with highest measured maximum output power when downlink CA is inactive. The downlink SCC channel was paired with the uplink channel as normal operation. For intra-band contiguous CA, the downlink channel spacing between the component carriers was set to multiple of 300 kHz less than the nominal channel spacing per section 5.4.1A of 3GPP TS36.521. For intra-band non-contiguous CA, the downlink channel spacing between the component carriers was set to maximum separation from PCC and remain fully within the downlink transmission band. For Inter-band CA, the SCC downlink channel was set to near the middle of its transmission band.

### Power Measurements for Inter-Band Downlink CA

Refer to Appendix F.

### Summary for SAR Test Exclusion for LTE Downlink CA

Per power confirmation results in above, the uplink maximum output power with downlink CA active remains within the specified tune-up tolerance and not more than 0.25 dB higher than the maximum output power with downlink CA inactive. According to KDB 941225 D05A, the SAR test exclusion applies to LTE downlink CA operation.

# SAR Test Report

## 4.7.2 SAR Results for Body Exposure Condition

### Tablet Mode

Plot No.	Band	Mode	Test Position	Gap (mm)	Ch.	Sample	Battery	Reduction Power	Maximum Tune-up (dBm)	Conducted Power (dBm)	Scaling Factor	Power Drift	SAR 1g	Scaled 1g SAR
	WCDMA II	RMC12.2K	Rear Face	20	9262	1	4cell	w/o	24.50	23.89	1.15	-0.18	0.159	0.18
	WCDMA II	RMC12.2K	Left Side	0	9262	1	4cell	w/o	24.50	23.89	1.15	0.16	0.191	0.22
	WCDMA II	RMC12.2K	Right Side	0	9262	1	4cell	w/o	24.50	23.89	1.15	-0.03	0.329	0.38
	WCDMA II	RMC12.2K	Top Side	0	9262	1	4cell	w/o	24.50	23.89	1.15	-0.05	0.114	0.13
	WCDMA II	RMC12.2K	Bottom Side	15	9262	1	4cell	w/o	24.50	23.89	1.15	-0.14	0.137	0.16
	WCDMA II	RMC12.2K	Rear Face	0	9400	1	4cell	w/	15.50	15.50	1.00	0.08	0.679	0.68
	WCDMA II	RMC12.2K	Bottom Side	0	9400	1	4cell	w/	15.50	15.50	1.00	-0.18	0.327	0.33
	WCDMA II	RMC12.2K	Rear Face	0	9262	1	4cell	w/	15.50	15.46	1.01	-0.1	0.662	0.67
01	WCDMA II	RMC12.2K	Rear Face	0	9538	1	4cell	w/	15.50	15.41	1.02	0.08	0.684	0.70
	WCDMA II	RMC12.2K	Rear Face	0	9538	2	4cell	w/	15.50	15.41	1.02	-0.14	0.641	0.65
	WCDMA II	RMC12.2K	Rear Face	0	9538	3	4cell	w/	15.50	15.41	1.02	-0.01	0.611	0.62
	WCDMA II	RMC12.2K	Rear Face	0	9538	4	4cell	w/	15.50	15.41	1.02	0.08	0.578	0.59
	WCDMA II	RMC12.2K	Rear Face	0	9538	1	6cell	w/	15.50	15.41	1.02	-0.02	0.628	0.64
	WCDMA IV	RMC12.2K	Rear Face	20	1413	1	4cell	w/o	24.50	24.24	1.06	0.07	0.141	0.15
	WCDMA IV	RMC12.2K	Left Side	0	1413	1	4cell	w/o	24.50	24.24	1.06	0.02	0.414	0.44
	WCDMA IV	RMC12.2K	Right Side	0	1413	1	4cell	w/o	24.50	24.24	1.06	0.14	0.164	0.17
	WCDMA IV	RMC12.2K	Top Side	0	1413	1	4cell	w/o	24.50	24.24	1.06	-0.19	0.138	0.15
	WCDMA IV	RMC12.2K	Bottom Side	15	1413	1	4cell	w/o	24.50	24.24	1.06	0.1	0.146	0.15
	WCDMA IV	RMC12.2K	Rear Face	0	1312	1	4cell	w/	16.00	15.99	1.00	0.15	0.692	0.69
	WCDMA IV	RMC12.2K	Bottom Side	0	1312	1	4cell	w/	16.00	15.99	1.00	-0.11	0.306	0.31
	WCDMA IV	RMC12.2K	Rear Face	0	1413	1	4cell	w/	16.00	15.94	1.01	0.09	0.659	0.67
02	WCDMA IV	RMC12.2K	Rear Face	0	1513	1	4cell	w/	16.00	15.88	1.03	0.09	0.725	0.75
	WCDMA IV	RMC12.2K	Rear Face	0	1513	2	4cell	w/	16.00	15.88	1.03	0.09	0.635	0.65
	WCDMA IV	RMC12.2K	Rear Face	0	1513	3	4cell	w/	16.00	15.88	1.03	-0.12	0.709	0.73
	WCDMA IV	RMC12.2K	Rear Face	0	1513	4	4cell	w/	16.00	15.88	1.03	-0.16	0.664	0.68
	WCDMA IV	RMC12.2K	Rear Face	0	1513	1	6cell	w/	16.00	15.88	1.03	-0.04	0.683	0.70
	WCDMA V	RMC12.2K	Rear Face	20	4182	1	4cell	w/o	24.50	24.21	1.07	0.11	0.125	0.13
	WCDMA V	RMC12.2K	Left Side	0	4182	1	4cell	w/o	24.50	24.21	1.07	0	<0.001	0.00
	WCDMA V	RMC12.2K	Right Side	0	4182	1	4cell	w/o	24.50	24.21	1.07	0	<0.001	0.00
	WCDMA V	RMC12.2K	Top Side	0	4182	1	4cell	w/o	24.50	24.21	1.07	0	<0.001	0.00
	WCDMA V	RMC12.2K	Bottom Side	15	4182	1	4cell	w/o	24.50	24.21	1.07	0.02	0.156	0.17
	WCDMA V	RMC12.2K	Rear Face	0	4182	1	4cell	w/	19.50	19.50	1.00	0.06	0.764	0.76
	WCDMA V	RMC12.2K	Bottom Side	0	4182	1	4cell	w/	19.50	19.50	1.00	-0.16	0.375	0.38
03	WCDMA V	RMC12.2K	Rear Face	0	4132	1	4cell	w/	19.50	19.41	1.02	-0.06	0.774	0.79
	WCDMA V	RMC12.2K	Rear Face	0	4233	1	4cell	w/	19.50	19.37	1.03	-0.09	0.728	0.75
	WCDMA V	RMC12.2K	Rear Face	0	4132	2	4cell	w/	19.50	19.41	1.02	-0.04	0.721	0.74
	WCDMA V	RMC12.2K	Rear Face	0	4132	3	4cell	w/	19.50	19.41	1.02	-0.01	0.745	0.76
	WCDMA V	RMC12.2K	Rear Face	0	4132	4	4cell	w/	19.50	19.41	1.02	0.03	0.753	0.77
	WCDMA V	RMC12.2K	Rear Face	0	4132	1	6cell	w/	19.50	19.41	1.02	-0.05	0.699	0.71

Note: The "< 0.001" means there is no SAR value or the SAR is too low to be measured.



# SAR Test Report

Plot No.	Band	Mode	Test Position	Gap (mm)	Ch.	RB	offset	Sample	Battery	Reduction Power	Maximum Tune-up (dBm)	Conducted Power (dBm)	Scaling Factor	Power Drift	SAR 1g	Scaled 1g SAR
	LTE 2	QPSK20M	Rear Face	20	19100	1	0	1	4cell	w/o	24.50	23.94	1.14	0.12	0.213	0.24
	LTE 2	QPSK20M	Left Side	0	19100	1	0	1	4cell	w/o	24.50	23.94	1.14	0.04	0.381	0.43
	LTE 2	QPSK20M	Right Side	0	19100	1	0	1	4cell	w/o	24.50	23.94	1.14	0.13	0.653	0.74
	LTE 2	QPSK20M	Top Side	0	19100	1	0	1	4cell	w/o	24.50	23.94	1.14	-0.16	0.216	0.25
	LTE 2	QPSK20M	Bottom Side	15	19100	1	0	1	4cell	w/o	24.50	23.94	1.14	-0.16	0.156	0.18
	LTE 2	QPSK20M	Rear Face	20	19100	50	0	1	4cell	w/o	23.50	22.93	1.14	-0.04	0.165	0.19
	LTE 2	QPSK20M	Left Side	0	19100	50	0	1	4cell	w/o	23.50	22.93	1.14	-0.06	0.281	0.32
	LTE 2	QPSK20M	Right Side	0	19100	50	0	1	4cell	w/o	23.50	22.93	1.14	-0.02	0.537	0.61
	LTE 2	QPSK20M	Top Side	0	19100	50	0	1	4cell	w/o	23.50	22.93	1.14	-0.07	0.107	0.12
	LTE 2	QPSK20M	Bottom Side	15	19100	50	0	1	4cell	w/o	23.50	22.93	1.14	-0.11	0.121	0.14
04	LTE 2	QPSK20M	Rear Face	0	19100	1	0	1	4cell	w/	15.00	14.98	1.00	0.06	0.772	0.77
	LTE 2	QPSK20M	Bottom Side	0	19100	1	0	1	4cell	w/	15.00	14.98	1.00	-0.1	0.277	0.28
	LTE 2	QPSK20M	Rear Face	0	19100	50	0	1	4cell	w/	15.00	14.94	1.01	-0.19	0.731	0.74
	LTE 2	QPSK20M	Bottom Side	0	19100	50	0	1	4cell	w/	15.00	14.94	1.01	0.18	0.218	0.22
	LTE 2	QPSK20M	Rear Face	0	18700	1	0	1	4cell	w/	15.00	14.86	1.03	0.12	0.669	0.69
	LTE 2	QPSK20M	Rear Face	0	18900	1	0	1	4cell	w/	15.00	14.85	1.04	0.05	0.726	0.76
	LTE 2	QPSK20M	Rear Face	0	19100	1	0	2	4cell	w/	15.00	14.98	1.00	-0.18	0.702	0.70
	LTE 2	QPSK20M	Rear Face	0	19100	1	0	3	4cell	w/	15.00	14.98	1.00	0.08	0.679	0.68
	LTE 2	QPSK20M	Rear Face	0	19100	1	0	4	4cell	w/	15.00	14.98	1.00	-0.16	0.747	0.75
	LTE 2	QPSK20M	Rear Face	0	19100	1	0	1	6cell	w/	15.00	14.98	1.00	0.12	0.719	0.72
	LTE 4	QPSK20M	Rear Face	20	20050	1	0	1	4cell	w/o	24.50	23.90	1.15	0.05	0.184	0.21
	LTE 4	QPSK20M	Left Side	0	20050	1	0	1	4cell	w/o	24.50	23.90	1.15	0.13	0.673	0.77
	LTE 4	QPSK20M	Right Side	0	20050	1	0	1	4cell	w/o	24.50	23.90	1.15	0	0.471	0.54
	LTE 4	QPSK20M	Top Side	0	20050	1	0	1	4cell	w/o	24.50	23.90	1.15	-0.16	0.106	0.12
	LTE 4	QPSK20M	Bottom Side	15	20050	1	0	1	4cell	w/o	24.50	23.90	1.15	-0.06	0.143	0.16
	LTE 4	QPSK20M	Rear Face	20	20050	50	0	1	4cell	w/o	23.50	22.94	1.14	-0.01	0.151	0.17
	LTE 4	QPSK20M	Left Side	0	20050	50	0	1	4cell	w/o	23.50	22.94	1.14	-0.15	0.556	0.63
	LTE 4	QPSK20M	Right Side	0	20050	50	0	1	4cell	w/o	23.50	22.94	1.14	-0.15	0.342	0.39
	LTE 4	QPSK20M	Top Side	0	20050	50	0	1	4cell	w/o	23.50	22.94	1.14	0.17	0.087	0.10
	LTE 4	QPSK20M	Bottom Side	15	20050	50	0	1	4cell	w/o	23.50	22.94	1.14	-0.08	0.114	0.13
05	LTE 4	QPSK20M	Rear Face	0	20300	1	0	1	4cell	w/	16.50	16.47	1.01	0.02	0.776	0.78
	LTE 4	QPSK20M	Bottom Side	0	20300	1	0	1	4cell	w/	16.50	16.47	1.01	0.07	0.389	0.39
	LTE 4	QPSK20M	Rear Face	0	20300	50	0	1	4cell	w/	16.50	16.36	1.03	0.13	0.739	0.76
	LTE 4	QPSK20M	Bottom Side	0	20300	50	0	1	4cell	w/	16.50	16.36	1.03	0.03	0.351	0.36
	LTE 4	QPSK20M	Rear Face	0	20050	1	0	1	4cell	w/	16.50	16.39	1.03	-0.06	0.752	0.77
	LTE 4	QPSK20M	Rear Face	0	20175	1	0	1	4cell	w/	16.50	16.35	1.04	-0.16	0.719	0.75
	LTE 4	QPSK20M	Rear Face	0	20300	1	0	2	4cell	w/	16.50	16.47	1.01	-0.03	0.685	0.69
	LTE 4	QPSK20M	Rear Face	0	20300	1	0	3	4cell	w/	16.50	16.47	1.01	-0.11	0.733	0.74
	LTE 4	QPSK20M	Rear Face	0	20300	1	0	4	4cell	w/	16.50	16.47	1.01	0.19	0.757	0.76
	LTE 4	QPSK20M	Rear Face	0	20300	1	0	1	6cell	w/	16.50	16.47	1.01	-0.06	0.709	0.72



# SAR Test Report

Plot No.	Band	Mode	Test Position	Gap (mm)	Ch.	RB	offset	Sample	Battery	Reduction Power	Maximum Tune-up (dBm)	Conducted Power (dBm)	Scaling Factor	Power Drift	SAR 1g	Scaled 1g SAR
	LTE 5	QPSK10M	Rear Face	20	20525	1	0	1	4cell	w/o	24.50	24.03	1.11	0	0.174	0.19
	LTE 5	QPSK10M	Left Side	0	20525	1	0	1	4cell	w/o	24.50	24.03	1.11	-0.11	0.032	0.04
	LTE 5	QPSK10M	Right Side	0	20525	1	0	1	4cell	w/o	24.50	24.03	1.11	0.05	<0.001	0.00
	LTE 5	QPSK10M	Top Side	0	20525	1	0	1	4cell	w/o	24.50	24.03	1.11	0.02	<0.001	0.00
	LTE 5	QPSK10M	Bottom Side	15	20525	1	0	1	4cell	w/o	24.50	24.03	1.11	0.17	0.153	0.17
	LTE 5	QPSK10M	Rear Face	20	20525	25	0	1	4cell	w/o	23.50	23.00	1.12	-0.03	0.134	0.15
	LTE 5	QPSK10M	Left Side	0	20525	25	0	1	4cell	w/o	23.50	23.00	1.12	-0.05	<0.001	0.00
	LTE 5	QPSK10M	Right Side	0	20525	25	0	1	4cell	w/o	23.50	23.00	1.12	0.16	<0.001	0.00
	LTE 5	QPSK10M	Top Side	0	20525	25	0	1	4cell	w/o	23.50	23.00	1.12	0.08	<0.001	0.00
	LTE 5	QPSK10M	Bottom Side	15	20525	25	0	1	4cell	w/o	23.50	23.00	1.12	-0.13	0.108	0.12
	LTE 5	QPSK10M	Rear Face	0	20600	1	0	1	4cell	w/	19.00	18.98	1.00	0.1	0.686	0.69
	LTE 5	QPSK10M	Bottom Side	0	20600	1	0	1	4cell	w/	19.00	18.98	1.00	-0.04	0.431	0.43
	LTE 5	QPSK10M	Rear Face	0	20600	25	0	1	4cell	w/	19.00	18.92	1.02	-0.07	0.665	0.68
	LTE 5	QPSK10M	Bottom Side	0	20600	25	0	1	4cell	w/	19.00	18.92	1.02	0.09	0.356	0.36
06	LTE 5	QPSK10M	Rear Face	0	20450	1	0	1	4cell	w/	19.00	18.87	1.03	-0.02	0.766	0.79
	LTE 5	QPSK10M	Rear Face	0	20525	1	0	1	4cell	w/	19.00	18.89	1.03	0.15	0.747	0.77
	LTE 5	QPSK10M	Rear Face	0	20450	1	0	2	4cell	w/	19.00	18.87	1.03	-0.18	0.707	0.73
	LTE 5	QPSK10M	Rear Face	0	20450	1	0	3	4cell	w/	19.00	18.87	1.03	-0.18	0.733	0.75
	LTE 5	QPSK10M	Rear Face	0	20450	1	0	4	4cell	w/	19.00	18.87	1.03	-0.12	0.663	0.68
	LTE 5	QPSK10M	Rear Face	0	20450	1	0	1	6cell	w/	19.00	18.87	1.03	0.09	0.673	0.69
	LTE 7	QPSK20M	Rear Face	20	21100	1	0	1	4cell	w/o	24.50	23.96	1.13	0.09	0.491	0.55
	LTE 7	QPSK20M	Left Side	0	21100	1	0	1	4cell	w/o	24.50	23.96	1.13	0.05	0.622	0.70
	LTE 7	QPSK20M	Right Side	0	21100	1	0	1	4cell	w/o	24.50	23.96	1.13	-0.1	0.116	0.13
	LTE 7	QPSK20M	Top Side	0	21100	1	0	1	4cell	w/o	24.50	23.96	1.13	0.07	0.102	0.12
	LTE 7	QPSK20M	Bottom Side	15	21100	1	0	1	4cell	w/o	24.50	23.96	1.13	-0.06	0.405	0.46
	LTE 7	QPSK20M	Rear Face	20	21100	50	0	1	4cell	w/o	23.50	22.85	1.16	-0.07	0.322	0.37
	LTE 7	QPSK20M	Left Side	0	21100	50	0	1	4cell	w/o	23.50	22.85	1.16	0.05	0.421	0.49
	LTE 7	QPSK20M	Right Side	0	21100	50	0	1	4cell	w/o	23.50	22.85	1.16	0.07	0.081	0.09
	LTE 7	QPSK20M	Top Side	0	21100	50	0	1	4cell	w/o	23.50	22.85	1.16	-0.12	0.058	0.07
	LTE 7	QPSK20M	Bottom Side	15	21100	50	0	1	4cell	w/o	23.50	22.85	1.16	-0.17	0.261	0.30
07	LTE 7	QPSK20M	Rear Face	0	20850	1	0	1	4cell	w/	14.50	14.47	1.01	0.07	1.02	1.03
	LTE 7	QPSK20M	Bottom Side	0	20850	1	0	1	4cell	w/	14.50	14.47	1.01	-0.13	0.494	0.50
	LTE 7	QPSK20M	Rear Face	0	20850	50	0	1	4cell	w/	14.50	14.39	1.03	-0.07	0.939	0.97
	LTE 7	QPSK20M	Bottom Side	0	20850	50	0	1	4cell	w/	14.50	14.39	1.03	-0.16	0.418	0.43
	LTE 7	QPSK20M	Rear Face	0	20850	100	0	1	4cell	w/	14.50	14.32	1.04	-0.16	0.956	0.99
	LTE 7	QPSK20M	Rear Face	0	21100	1	0	1	4cell	w/	14.50	14.35	1.04	-0.1	0.908	0.94
	LTE 7	QPSK20M	Rear Face	0	21350	1	0	1	4cell	w/	14.50	14.35	1.04	0.06	0.897	0.93
	LTE 7	QPSK20M	Rear Face	0	21100	50	0	1	4cell	w/	14.50	14.32	1.04	-0.07	0.911	0.95
	LTE 7	QPSK20M	Rear Face	0	21350	50	0	1	4cell	w/	14.50	14.24	1.06	-0.07	0.92	0.98
	LTE 7	QPSK20M	Rear Face	0	20850	1	0	2	4cell	w/	14.50	14.47	1.01	-0.04	0.907	0.92
	LTE 7	QPSK20M	Rear Face	0	20850	1	0	3	4cell	w/	14.50	14.47	1.01	-0.19	0.892	0.90
	LTE 7	QPSK20M	Rear Face	0	20850	1	0	4	4cell	w/	14.50	14.47	1.01	0.08	0.871	0.88
	LTE 7	QPSK20M	Rear Face	0	21100	1	0	2	4cell	w/	14.50	14.35	1.04	0.09	0.923	0.96
	LTE 7	QPSK20M	Rear Face	0	21350	1	0	2	4cell	w/	14.50	14.35	1.04	0.11	0.901	0.94
	LTE 7	QPSK20M	Rear Face	0	21100	1	0	3	4cell	w/	14.50	14.35	1.04	-0.19	0.888	0.92
	LTE 7	QPSK20M	Rear Face	0	21350	1	0	3	4cell	w/	14.50	14.35	1.04	0.18	0.841	0.87
	LTE 7	QPSK20M	Rear Face	0	21100	1	0	4	4cell	w/	14.50	14.35	1.04	0.08	0.909	0.95
	LTE 7	QPSK20M	Rear Face	0	21350	1	0	4	4cell	w/	14.50	14.35	1.04	0.12	0.852	0.89
	LTE 7	QPSK20M	Rear Face	0	20850	1	0	1	6cell	w/	14.50	14.47	1.01	0.18	0.901	0.91
	LTE 7	QPSK20M	Rear Face	0	21100	1	0	1	6cell	w/	14.50	14.35	1.04	0.18	0.926	0.96
	LTE 7	QPSK20M	Rear Face	0	21350	1	0	1	6cell	w/	14.50	14.35	1.04	0.17	0.953	0.99
	LTE 7	QPSK20M	Rear Face	0	PCC : 20850 SCC : 21048	PCC : 1 SCC : 1	PCC : 99 SCC : 0	1	4cell	w/	14.50	13.82	1.17	-0.11	0.879	1.03
	LTE 7	QPSK20M	Rear Face	0	PCC : 21001 SCC : 21199	PCC : 1 SCC : 1	PCC : 99 SCC : 0	1	4cell	w/	14.50	13.71	1.20	0.03	0.845	1.01
	LTE 7	QPSK20M	Rear Face	0	PCC : 21152 SCC : 21350	PCC : 1 SCC : 1	PCC : 99 SCC : 0	1	4cell	w/	14.50	13.30	1.32	-0.01	0.777	1.03
	LTE 7	QPSK20M	Rear Face	0	20850	1	0	1	4cell	w/	14.50	14.47	1.01	0.12	0.993	1.00

Note: The "< 0.001" means there is no SAR value or the SAR is too low to be measured.

# SAR Test Report

Plot No.	Band	Mode	Test Position	Gap (mm)	Ch.	RB	offset	Sample	Battery	Reduction Power	Maximum Tune-up (dBm)	Conducted Power (dBm)	Scaling Factor	Power Drift	SAR 1g	Scaled 1g SAR
	LTE 12	QPSK10M	Rear Face	20	23130	1	0	1	4cell	w/o	24.50	24.20	1.07	0.03	0.249	0.27
	LTE 12	QPSK10M	Left Side	0	23130	1	0	1	4cell	w/o	24.50	24.20	1.07	0.06	<0.001	0.00
	LTE 12	QPSK10M	Right Side	0	23130	1	0	1	4cell	w/o	24.50	24.20	1.07	0.19	<0.001	0.00
	LTE 12	QPSK10M	Top Side	0	23130	1	0	1	4cell	w/o	24.50	24.20	1.07	-0.03	<0.001	0.00
	LTE 12	QPSK10M	Bottom Side	15	23130	1	0	1	4cell	w/o	24.50	24.20	1.07	-0.1	0.221	0.24
	LTE 12	QPSK10M	Rear Face	20	23130	25	0	1	4cell	w/o	23.50	23.19	1.07	-0.01	0.152	0.16
	LTE 12	QPSK10M	Left Side	0	23130	25	0	1	4cell	w/o	23.50	23.19	1.07	0.09	<0.001	0.00
	LTE 12	QPSK10M	Right Side	0	23130	25	0	1	4cell	w/o	23.50	23.19	1.07	-0.04	<0.001	0.00
	LTE 12	QPSK10M	Top Side	0	23130	25	0	1	4cell	w/o	23.50	23.19	1.07	0.17	<0.001	0.00
	LTE 12	QPSK10M	Bottom Side	15	23130	25	0	1	4cell	w/o	23.50	23.19	1.07	0.09	0.181	0.19
	LTE 12	QPSK10M	Rear Face	0	23130	1	0	1	4cell	w/	18.50	18.47	1.01	-0.03	0.746	0.75
	LTE 12	QPSK10M	Bottom Side	0	23130	1	0	1	4cell	w/	18.50	18.47	1.01	-0.07	0.422	0.43
	LTE 12	QPSK10M	Rear Face	0	23130	25	0	1	4cell	w/	18.50	18.45	1.01	-0.17	0.716	0.72
	LTE 12	QPSK10M	Bottom Side	0	23130	25	0	1	4cell	w/	18.50	18.45	1.01	0.08	0.389	0.39
	LTE 12	QPSK10M	Rear Face	0	23060	1	0	1	4cell	w/	18.50	18.28	1.05	0.12	0.706	0.74
08	LTE 12	QPSK10M	Rear Face	0	23095	1	0	1	4cell	w/	18.50	18.35	1.04	-0.06	0.748	0.78
	LTE 12	QPSK10M	Rear Face	0	23095	1	0	2	4cell	w/	18.50	18.35	1.04	-0.19	0.671	0.70
	LTE 12	QPSK10M	Rear Face	0	23095	1	0	3	4cell	w/	18.50	18.35	1.04	0	0.639	0.66
	LTE 12	QPSK10M	Rear Face	0	23095	1	0	4	4cell	w/	18.50	18.35	1.04	0.11	0.622	0.65
	LTE 12	QPSK10M	Rear Face	0	23095	1	0	1	6cell	w/	18.50	18.35	1.04	0	0.715	0.74
	LTE 13	QPSK10M	Rear Face	20	23230	1	0	1	4cell	w/o	24.50	24.28	1.05	0.05	0.191	0.20
	LTE 13	QPSK10M	Left Side	0	23230	1	0	1	4cell	w/o	24.50	24.28	1.05	0.06	<0.001	0.00
	LTE 13	QPSK10M	Right Side	0	23230	1	0	1	4cell	w/o	24.50	24.28	1.05	-0.09	<0.001	0.00
	LTE 13	QPSK10M	Top Side	0	23230	1	0	1	4cell	w/o	24.50	24.28	1.05	0.17	<0.001	0.00
	LTE 13	QPSK10M	Bottom Side	15	23230	1	0	1	4cell	w/o	24.50	24.28	1.05	-0.12	0.162	0.17
	LTE 13	QPSK10M	Rear Face	20	23230	25	0	1	4cell	w/o	23.50	23.37	1.03	-0.05	0.158	0.16
	LTE 13	QPSK10M	Left Side	0	23230	25	0	1	4cell	w/o	23.50	23.37	1.03	-0.08	<0.001	0.00
	LTE 13	QPSK10M	Right Side	0	23230	25	0	1	4cell	w/o	23.50	23.37	1.03	0.13	<0.001	0.00
	LTE 13	QPSK10M	Top Side	0	23230	25	0	1	4cell	w/o	23.50	23.37	1.03	-0.13	<0.001	0.00
	LTE 13	QPSK10M	Bottom Side	15	23230	25	0	1	4cell	w/o	23.50	23.37	1.03	-0.02	0.136	0.14
09	LTE 13	QPSK10M	Rear Face	0	23230	1	0	1	4cell	w/	18.50	18.47	1.01	-0.11	0.841	0.85
	LTE 13	QPSK10M	Bottom Side	0	23230	1	0	1	4cell	w/	18.50	18.47	1.01	0.17	0.445	0.45
	LTE 13	QPSK10M	Rear Face	0	23230	25	0	1	4cell	w/	18.50	18.43	1.02	0.17	0.809	0.83
	LTE 13	QPSK10M	Bottom Side	0	23230	25	0	1	4cell	w/	18.50	18.43	1.02	-0.06	0.422	0.43
	LTE 13	QPSK10M	Rear Face	0	23230	50	0	1	4cell	w/	18.50	18.45	1.01	0.13	0.811	0.82
	LTE 13	QPSK10M	Rear Face	0	23230	1	0	2	4cell	w/	18.50	18.47	1.01	0	0.778	0.79
	LTE 13	QPSK10M	Rear Face	0	23230	1	0	3	4cell	w/	18.50	18.47	1.01	0	0.797	0.80
	LTE 13	QPSK10M	Rear Face	0	23230	1	0	4	4cell	w/	18.50	18.47	1.01	-0.02	0.827	0.84
	LTE 13	QPSK10M	Rear Face	0	23230	1	0	1	6cell	w/	18.50	18.47	1.01	0.14	0.771	0.78
	LTE 13	QPSK10M	Rear Face	0	23230	1	0	1	4cell	w/	18.50	18.47	1.01	0.17	0.822	0.83

Note: The "< 0.001" means there is no SAR value or the SAR is too low to be measured.

# SAR Test Report

Plot No.	Band	Mode	Test Position	Gap (mm)	Ch.	RB	offset	Sample	Battery	Reduction Power	Maximum Tune-up (dBm)	Conducted Power (dBm)	Scaling Factor	Power Drift	SAR 1g	Scaled 1g SAR
	LTE 14	QPSK10M	Rear Face	20	23330	1	0	1	4cell	w/o	24.50	24.01	1.12	0.12	0.256	0.29
	LTE 14	QPSK10M	Left Side	0	23330	1	0	1	4cell	w/o	24.50	24.01	1.12	0.02	0.068	0.08
	LTE 14	QPSK10M	Right Side	0	23330	1	0	1	4cell	w/o	24.50	24.01	1.12	0.1	<0.001	0.00
	LTE 14	QPSK10M	Top Side	0	23330	1	0	1	4cell	w/o	24.50	24.01	1.12	-0.09	<0.001	0.00
	LTE 14	QPSK10M	Bottom Side	15	23330	1	0	1	4cell	w/o	24.50	24.01	1.12	-0.17	0.227	0.25
	LTE 14	QPSK10M	Rear Face	20	23330	25	0	1	4cell	w/o	23.50	23.01	1.12	-0.11	0.211	0.24
	LTE 14	QPSK10M	Left Side	0	23330	25	0	1	4cell	w/o	23.50	23.01	1.12	-0.19	<0.001	0.00
	LTE 14	QPSK10M	Right Side	0	23330	25	0	1	4cell	w/o	23.50	23.01	1.12	0.08	<0.001	0.00
	LTE 14	QPSK10M	Top Side	0	23330	25	0	1	4cell	w/o	23.50	23.01	1.12	-0.14	<0.001	0.00
	LTE 14	QPSK10M	Bottom Side	15	23330	25	0	1	4cell	w/o	23.50	23.01	1.12	0.19	0.168	0.19
10	LTE 14	QPSK10M	Rear Face	0	23330	1	0	1	4cell	w/	19.00	18.97	1.01	-0.07	0.938	0.95
	LTE 14	QPSK10M	Bottom Side	0	23330	1	0	1	4cell	w/	19.00	18.97	1.01	0.16	0.762	0.77
	LTE 14	QPSK10M	Rear Face	0	23330	25	0	1	4cell	w/	19.00	18.93	1.02	-0.02	0.907	0.93
	LTE 14	QPSK10M	Bottom Side	0	23330	25	0	1	4cell	w/	19.00	18.93	1.02	-0.19	0.666	0.68
	LTE 14	QPSK10M	Rear Face	0	23330	50	0	1	4cell	w/	19.00	18.86	1.03	0.18	0.865	0.89
	LTE 14	QPSK10M	Rear Face	0	23330	1	0	2	4cell	w/	19.00	18.97	1.01	0.14	0.913	0.92
	LTE 14	QPSK10M	Rear Face	0	23330	1	0	3	4cell	w/	19.00	18.97	1.01	0.17	0.738	0.75
	LTE 14	QPSK10M	Rear Face	0	23330	1	0	4	4cell	w/	19.00	18.97	1.01	-0.04	0.883	0.89
	LTE 14	QPSK10M	Rear Face	0	23330	1	0	1	6cell	w/	19.00	18.97	1.01	-0.07	0.841	0.85
	LTE 14	QPSK10M	Rear Face	0	23330	1	0	1	4cell	w/	19.00	18.97	1.01	0.06	0.915	0.92
	LTE 17	QPSK10M	Rear Face	20	23780	1	0	1	4cell	w/o	24.50	24.26	1.06	0.08	0.167	0.18
	LTE 17	QPSK10M	Left Side	0	23780	1	0	1	4cell	w/o	24.50	24.26	1.06	0.06	<0.001	0.00
	LTE 17	QPSK10M	Right Side	0	23780	1	0	1	4cell	w/o	24.50	24.26	1.06	0.17	<0.001	0.00
	LTE 17	QPSK10M	Top Side	0	23780	1	0	1	4cell	w/o	24.50	24.26	1.06	0.13	<0.001	0.00
	LTE 17	QPSK10M	Bottom Side	15	23780	1	0	1	4cell	w/o	24.50	24.26	1.06	-0.09	0.161	0.17
	LTE 17	QPSK10M	Rear Face	20	23780	25	0	1	4cell	w/o	23.50	23.27	1.05	-0.18	0.143	0.15
	LTE 17	QPSK10M	Left Side	0	23780	25	0	1	4cell	w/o	23.50	23.27	1.05	0.04	<0.001	0.00
	LTE 17	QPSK10M	Right Side	0	23780	25	0	1	4cell	w/o	23.50	23.27	1.05	0.13	<0.001	0.00
	LTE 17	QPSK10M	Top Side	0	23780	25	0	1	4cell	w/o	23.50	23.27	1.05	-0.12	<0.001	0.00
	LTE 17	QPSK10M	Bottom Side	15	23780	25	0	1	4cell	w/o	23.50	23.27	1.05	-0.01	0.137	0.14
11	LTE 17	QPSK10M	Rear Face	0	23780	1	0	1	4cell	w/	19.00	18.98	1.00	-0.04	0.932	0.93
	LTE 17	QPSK10M	Bottom Side	0	23780	1	0	1	4cell	w/	19.00	18.98	1.00	-0.11	0.658	0.66
	LTE 17	QPSK10M	Rear Face	0	23780	25	0	1	4cell	w/	19.00	18.90	1.02	-0.12	0.855	0.87
	LTE 17	QPSK10M	Bottom Side	0	23780	25	0	1	4cell	w/	19.00	18.90	1.02	-0.15	0.596	0.61
	LTE 17	QPSK10M	Rear Face	0	23780	50	0	1	4cell	w/	19.00	18.93	1.02	0.17	0.861	0.88
	LTE 17	QPSK10M	Rear Face	0	23790	1	0	1	4cell	w/	19.00	18.90	1.02	0.06	0.905	0.92
	LTE 17	QPSK10M	Rear Face	0	23800	1	0	1	4cell	w/	19.00	18.91	1.02	-0.12	0.829	0.85
	LTE 17	QPSK10M	Rear Face	0	23790	25	0	1	4cell	w/	19.00	18.84	1.04	0.05	0.832	0.87
	LTE 17	QPSK10M	Rear Face	0	23800	25	0	1	4cell	w/	19.00	18.79	1.05	0.13	0.812	0.85
	LTE 17	QPSK10M	Rear Face	0	23780	1	0	2	4cell	w/	19.00	18.98	1.00	-0.14	0.924	0.92
	LTE 17	QPSK10M	Rear Face	0	23780	1	0	3	4cell	w/	19.00	18.98	1.00	0.04	0.851	0.85
	LTE 17	QPSK10M	Rear Face	0	23780	1	0	4	4cell	w/	19.00	18.98	1.00	0.1	0.866	0.87
	LTE 17	QPSK10M	Rear Face	0	23790	1	0	2	4cell	w/	19.00	18.90	1.02	0.15	0.901	0.92
	LTE 17	QPSK10M	Rear Face	0	23800	1	0	2	4cell	w/	19.00	18.91	1.02	0.06	0.831	0.85
	LTE 17	QPSK10M	Rear Face	0	23790	1	0	3	4cell	w/	19.00	18.90	1.02	-0.05	0.882	0.90
	LTE 17	QPSK10M	Rear Face	0	23800	1	0	3	4cell	w/	19.00	18.91	1.02	-0.13	0.905	0.92
	LTE 17	QPSK10M	Rear Face	0	23790	1	0	4	4cell	w/	19.00	18.90	1.02	0.13	0.868	0.89
	LTE 17	QPSK10M	Rear Face	0	23800	1	0	4	4cell	w/	19.00	18.91	1.02	0.1	0.847	0.86
	LTE 17	QPSK10M	Rear Face	0	23780	1	0	1	6cell	w/	19.00	18.98	1.00	0.17	0.869	0.87
	LTE 17	QPSK10M	Rear Face	0	23790	1	0	1	6cell	w/	19.00	18.90	1.02	0.17	0.852	0.87
	LTE 17	QPSK10M	Rear Face	0	23800	1	0	1	6cell	w/	19.00	18.91	1.02	0.15	0.813	0.83
	LTE 17	QPSK10M	Rear Face	0	23780	1	0	1	4cell	w/	19.00	18.98	1.00	0.16	0.923	0.92

Note: The "< 0.001" means there is no SAR value or the SAR is too low to be measured.

# SAR Test Report

Plot No.	Band	Mode	Test Position	Gap (mm)	Ch.	RB	offset	Sample	Battery	Reduction Power	Maximum Tune-up (dBm)	Conducted Power (dBm)	Scaling Factor	Power Drift	SAR 1g	Scaled 1g SAR
	LTE 25	QPSK20M	Rear Face	20	26590	1	0	1	4cell	w/o	24.50	23.85	1.16	0	0.208	0.24
	LTE 25	QPSK20M	Left Side	0	26590	1	0	1	4cell	w/o	24.50	23.85	1.16	0.17	0.346	0.40
	LTE 25	QPSK20M	Right Side	0	26590	1	0	1	4cell	w/o	24.50	23.85	1.16	-0.05	0.678	0.79
	LTE 25	QPSK20M	Top Side	0	26590	1	0	1	4cell	w/o	24.50	23.85	1.16	-0.11	0.054	0.06
	LTE 25	QPSK20M	Bottom Side	15	26590	1	0	1	4cell	w/o	24.50	23.85	1.16	-0.18	0.164	0.19
	LTE 25	QPSK20M	Rear Face	20	26590	50	0	1	4cell	w/o	23.50	22.84	1.16	0.02	0.183	0.21
	LTE 25	QPSK20M	Left Side	0	26590	50	0	1	4cell	w/o	23.50	22.84	1.16	-0.19	0.24	0.28
	LTE 25	QPSK20M	Right Side	0	26590	50	0	1	4cell	w/o	23.50	22.84	1.16	0.1	0.502	0.58
	LTE 25	QPSK20M	Top Side	0	26590	50	0	1	4cell	w/o	23.50	22.84	1.16	0	<0.001	0.00
	LTE 25	QPSK20M	Bottom Side	15	26590	50	0	1	4cell	w/o	23.50	22.84	1.16	-0.04	0.133	0.15
12	LTE 25	QPSK20M	Rear Face	0	26590	1	0	1	4cell	w/	15.50	15.38	1.03	-0.04	1.03	<b>1.06</b>
	LTE 25	QPSK20M	Bottom Side	0	26590	1	0	1	4cell	w/	15.50	15.38	1.03	0.14	0.423	0.44
	LTE 25	QPSK20M	Rear Face	0	26590	50	0	1	4cell	w/	15.50	15.28	1.05	0	1	1.05
	LTE 25	QPSK20M	Bottom Side	0	26590	50	0	1	4cell	w/	15.50	15.28	1.05	-0.05	0.389	0.41
	LTE 25	QPSK20M	Rear Face	0	26590	100	0	1	4cell	w/	15.50	15.25	1.06	0.01	0.966	1.02
	LTE 25	QPSK20M	Rear Face	0	26140	1	0	1	4cell	w/	15.50	15.26	1.06	-0.01	0.837	0.89
	LTE 25	QPSK20M	Rear Face	0	26365	1	0	1	4cell	w/	15.50	15.15	1.08	-0.1	0.951	1.03
	LTE 25	QPSK20M	Rear Face	0	26140	50	0	1	4cell	w/	15.50	15.27	1.05	-0.07	0.985	1.03
	LTE 25	QPSK20M	Rear Face	0	26365	50	0	1	4cell	w/	15.50	15.14	1.09	0.12	0.958	1.04
	LTE 25	QPSK20M	Rear Face	0	26590	1	0	2	4cell	w/	15.50	15.38	1.03	0.17	0.929	0.96
	LTE 25	QPSK20M	Rear Face	0	26590	1	0	3	4cell	w/	15.50	15.38	1.03	-0.03	0.896	0.92
	LTE 25	QPSK20M	Rear Face	0	26590	1	0	4	4cell	w/	15.50	15.38	1.03	0.09	0.846	0.87
	LTE 25	QPSK20M	Rear Face	0	26140	1	0	2	4cell	w/	15.50	15.26	1.06	-0.01	0.747	0.79
	LTE 25	QPSK20M	Rear Face	0	26365	1	0	2	4cell	w/	15.50	15.15	1.08	-0.1	0.921	0.99
	LTE 25	QPSK20M	Rear Face	0	26140	1	0	3	4cell	w/	15.50	15.26	1.06	-0.01	0.747	0.79
	LTE 25	QPSK20M	Rear Face	0	26365	1	0	3	4cell	w/	15.50	15.15	1.08	-0.1	0.911	0.98
	LTE 25	QPSK20M	Rear Face	0	26140	1	0	4	4cell	w/	15.50	15.26	1.06	-0.01	0.737	0.78
	LTE 25	QPSK20M	Rear Face	0	26365	1	0	4	4cell	w/	15.50	15.15	1.08	-0.1	0.931	1.01
	LTE 25	QPSK20M	Rear Face	0	26590	1	0	1	6cell	w/	15.50	15.38	1.03	0.05	0.819	0.84
	LTE 25	QPSK20M	Rear Face	0	26140	1	0	1	6cell	w/	15.50	15.26	1.06	-0.01	0.777	0.82
	LTE 25	QPSK20M	Rear Face	0	26365	1	0	1	6cell	w/	15.50	15.15	1.08	-0.1	0.901	0.97
	LTE 25	QPSK20M	Rear Face	0	26590	1	0	1	4cell	w/	15.50	15.38	1.03	-0.04	0.993	1.02

Note: The "< 0.001" means there is no SAR value or the SAR is too low to be measured.



# SAR Test Report

Plot No.	Band	Mode	Test Position	Gap (mm)	Ch.	RB	offset	Sample	Battery	Reduction Power	Maximum Tune-up (dBm)	Conducted Power (dBm)	Scaling Factor	Power Drift	SAR 1g	Scaled 1g SAR
	LTE 26	QPSK15M	Rear Face	20	26965	1	0	1	4cell	w/o	24.50	24.09	1.10	0.03	0.189	0.21
	LTE 26	QPSK15M	Left Side	0	26965	1	0	1	4cell	w/o	24.50	24.09	1.10	0	<0.001	0.00
	LTE 26	QPSK15M	Right Side	0	26965	1	0	1	4cell	w/o	24.50	24.09	1.10	0	<0.001	0.00
	LTE 26	QPSK15M	Top Side	0	26965	1	0	1	4cell	w/o	24.50	24.09	1.10	0	<0.001	0.00
	LTE 26	QPSK15M	Bottom Side	15	26965	1	0	1	4cell	w/o	24.50	24.09	1.10	-0.08	0.16	0.18
	LTE 26	QPSK15M	Rear Face	20	26965	36	0	1	4cell	w/o	23.50	23.03	1.11	0.03	0.133	0.15
	LTE 26	QPSK15M	Left Side	0	26965	36	0	1	4cell	w/o	23.50	23.03	1.11	0	<0.001	0.00
	LTE 26	QPSK15M	Right Side	0	26965	36	0	1	4cell	w/o	23.50	23.03	1.11	0	<0.001	0.00
	LTE 26	QPSK15M	Top Side	0	26965	36	0	1	4cell	w/o	23.50	23.03	1.11	0	<0.001	0.00
	LTE 26	QPSK15M	Bottom Side	15	26965	36	0	1	4cell	w/o	23.50	23.03	1.11	0.02	0.133	0.15
13	LTE 26	QPSK15M	Rear Face	0	26765	1	0	1	4cell	w/	19.00	18.97	1.01	-0.03	0.936	0.95
	LTE 26	QPSK15M	Bottom Side	0	26765	1	0	1	4cell	w/	19.00	18.97	1.01	0.16	0.617	0.62
	LTE 26	QPSK15M	Rear Face	0	26765	36	0	1	4cell	w/	19.00	18.91	1.02	0	0.882	0.90
	LTE 26	QPSK15M	Bottom Side	0	26765	36	0	1	4cell	w/	19.00	18.91	1.02	0.14	0.602	0.61
	LTE 26	QPSK15M	Rear Face	0	26765	75	0	1	4cell	w/	19.00	18.86	1.03	0.06	0.852	0.88
	LTE 26	QPSK15M	Rear Face	0	26865	1	0	1	4cell	w/	19.00	18.89	1.03	0.18	0.888	0.91
	LTE 26	QPSK15M	Rear Face	0	26965	1	0	1	4cell	w/	19.00	18.93	1.02	-0.01	0.896	0.91
	LTE 26	QPSK15M	Rear Face	0	26865	36	0	1	4cell	w/	19.00	18.86	1.03	0.19	0.885	0.91
	LTE 26	QPSK15M	Rear Face	0	26965	36	0	1	4cell	w/	19.00	18.83	1.04	0.09	0.857	0.89
	LTE 26	QPSK15M	Rear Face	0	26765	1	0	2	4cell	w/	19.00	18.97	1.01	-0.03	0.902	0.91
	LTE 26	QPSK15M	Rear Face	0	26765	1	0	3	4cell	w/	19.00	18.97	1.01	0.07	0.873	0.88
	LTE 26	QPSK15M	Rear Face	0	26765	1	0	4	4cell	w/	19.00	18.97	1.01	-0.09	0.838	0.85
	LTE 26	QPSK15M	Rear Face	0	26865	1	0	2	4cell	w/	19.00	18.89	1.03	0.18	0.788	0.81
	LTE 26	QPSK15M	Rear Face	0	26965	1	0	2	4cell	w/	19.00	18.93	1.02	-0.01	0.836	0.85
	LTE 26	QPSK15M	Rear Face	0	26865	1	0	3	4cell	w/	19.00	18.89	1.03	0.18	0.838	0.86
	LTE 26	QPSK15M	Rear Face	0	26965	1	0	3	4cell	w/	19.00	18.93	1.02	-0.01	0.836	0.85
	LTE 26	QPSK15M	Rear Face	0	26865	1	0	4	4cell	w/	19.00	18.89	1.03	0.18	0.848	0.87
	LTE 26	QPSK15M	Rear Face	0	26965	1	0	4	4cell	w/	19.00	18.93	1.02	-0.01	0.816	0.83
	LTE 26	QPSK15M	Rear Face	0	26765	1	0	1	6cell	w/	19.00	18.97	1.01	0.017	0.845	0.85
	LTE 26	QPSK15M	Rear Face	0	26865	1	0	1	6cell	w/	19.00	18.89	1.03	0.18	0.858	0.88
	LTE 26	QPSK15M	Rear Face	0	26965	1	0	1	6cell	w/	19.00	18.93	1.02	-0.01	0.806	0.82
	LTE 26	QPSK15M	Rear Face	0	26765	1	0	1	4cell	w/	19.00	18.97	1.01	-0.03	0.925	0.93

Note: The "< 0.001" means there is no SAR value or the SAR is too low to be measured.

# SAR Test Report

Plot No.	Band	Mode	Test Position	Gap (mm)	Ch.	RB	offset	Sample	Battery	Reduction Power	Maximum Tune-up (dBm)	Conducted Power (dBm)	Scaling Factor	Power Drift	SAR 1g	Scaled 1g SAR
	LTE 30	QPSK10M	Rear Face	20	27710	1	0	1	4cell	w/o	23.00	22.41	1.15	0.12	0.269	0.31
	LTE 30	QPSK10M	Left Side	0	27710	1	0	1	4cell	w/o	23.00	22.41	1.15	-0.14	0.253	0.29
	LTE 30	QPSK10M	Right Side	0	27710	1	0	1	4cell	w/o	23.00	22.41	1.15	-0.17	0.105	0.12
	LTE 30	QPSK10M	Top Side	0	27710	1	0	1	4cell	w/o	23.00	22.41	1.15	0.15	0.078	0.09
	LTE 30	QPSK10M	Bottom Side	15	27710	1	0	1	4cell	w/o	23.00	22.41	1.15	-0.04	0.325	0.37
	LTE 30	QPSK10M	Rear Face	20	27710	25	0	1	4cell	w/o	22.00	21.38	1.15	-0.12	0.178	0.20
	LTE 30	QPSK10M	Left Side	0	27710	25	0	1	4cell	w/o	22.00	21.38	1.15	0.01	0.187	0.22
	LTE 30	QPSK10M	Right Side	0	27710	25	0	1	4cell	w/o	22.00	21.38	1.15	0.19	0.071	0.08
	LTE 30	QPSK10M	Top Side	0	27710	25	0	1	4cell	w/o	22.00	21.38	1.15	0.05	0.062	0.07
	LTE 30	QPSK10M	Bottom Side	15	27710	25	0	1	4cell	w/o	22.00	21.38	1.15	0.12	0.205	0.24
14	LTE 30	QPSK10M	Rear Face	0	27710	1	0	1	4cell	w/	14.00	13.89	1.03	0.12	1.01	1.04
	LTE 30	QPSK10M	Bottom Side	0	27710	1	0	1	4cell	w/	14.00	13.89	1.03	0.04	0.421	0.43
	LTE 30	QPSK10M	Rear Face	0	27710	25	0	1	4cell	w/	14.00	13.88	1.03	-0.18	0.991	1.02
	LTE 30	QPSK10M	Bottom Side	0	27710	25	0	1	4cell	w/	14.00	13.88	1.03	0.06	0.407	0.42
	LTE 30	QPSK10M	Rear Face	0	27710	50	0	1	4cell	w/	14.00	13.79	1.05	0.03	0.899	0.94
	LTE 30	QPSK10M	Rear Face	0	27710	1	0	2	4cell	w/	14.00	13.89	1.03	-0.05	0.727	0.75
	LTE 30	QPSK10M	Rear Face	0	27710	1	0	3	4cell	w/	14.00	13.89	1.03	0.07	0.711	0.73
	LTE 30	QPSK10M	Rear Face	0	27710	1	0	4	4cell	w/	14.00	13.89	1.03	-0.09	0.657	0.68
	LTE 30	QPSK10M	Rear Face	0	27710	1	0	1	6cell	w/	14.00	13.89	1.03	0.04	0.671	0.69
	LTE 30	QPSK10M	Rear Face	0	27710	1	0	1	4cell	w/	14.00	13.89	1.03	0.11	0.998	1.03
	LTE 38	QPSK20M	Rear Face	20	37850	1	0	1	4cell	w/o	24.50	23.80	1.17	0.06	0.194	0.23
	LTE 38	QPSK20M	Left Side	0	37850	1	0	1	4cell	w/o	24.50	23.80	1.17	0.04	0.238	0.28
	LTE 38	QPSK20M	Right Side	0	37850	1	0	1	4cell	w/o	24.50	23.80	1.17	-0.09	0.053	0.06
	LTE 38	QPSK20M	Top Side	0	37850	1	0	1	4cell	w/o	24.50	23.80	1.17	-0.14	0.039	0.05
	LTE 38	QPSK20M	Bottom Side	15	37850	1	0	1	4cell	w/o	24.50	23.80	1.17	0.05	0.142	0.17
	LTE 38	QPSK20M	Rear Face	20	37850	50	0	1	4cell	w/o	23.50	22.89	1.15	0.12	0.128	0.15
	LTE 38	QPSK20M	Left Side	0	37850	50	0	1	4cell	w/o	23.50	22.89	1.15	0.09	0.16	0.18
	LTE 38	QPSK20M	Right Side	0	37850	50	0	1	4cell	w/o	23.50	22.89	1.15	-0.07	0.034	0.04
	LTE 38	QPSK20M	Top Side	0	37850	50	0	1	4cell	w/o	23.50	22.89	1.15	0	<0.001	0.00
	LTE 38	QPSK20M	Bottom Side	15	37850	50	0	1	4cell	w/o	23.50	22.89	1.15	-0.04	0.099	0.11
15	LTE 38	QPSK20M	Rear Face	0	37850	1	0	1	4cell	w/	18.00	17.98	1.00	-0.1	1.04	1.04
	LTE 38	QPSK20M	Bottom Side	0	37850	1	0	1	4cell	w/	18.00	17.98	1.00	0.12	0.492	0.49
	LTE 38	QPSK20M	Rear Face	0	37850	50	0	1	4cell	w/	18.00	17.87	1.03	0.17	0.974	1.00
	LTE 38	QPSK20M	Bottom Side	0	37850	50	0	1	4cell	w/	18.00	17.87	1.03	-0.05	0.478	0.49
	LTE 38	QPSK20M	Rear Face	0	37850	100	0	1	4cell	w/	18.00	17.80	1.05	0.04	0.926	0.97
	LTE 38	QPSK20M	Rear Face	0	38000	1	0	1	4cell	w/	18.00	17.82	1.04	-0.11	0.906	0.94
	LTE 38	QPSK20M	Rear Face	0	38150	1	0	1	4cell	w/	18.00	17.77	1.05	-0.13	0.912	0.96
	LTE 38	QPSK20M	Rear Face	0	38000	50	0	1	4cell	w/	18.00	17.82	1.04	0.12	0.951	0.99
	LTE 38	QPSK20M	Rear Face	0	38150	50	0	1	4cell	w/	18.00	17.73	1.06	0.05	0.933	0.99
	LTE 38	QPSK20M	Rear Face	0	37850	1	0	2	4cell	w/	18.00	17.98	1.00	-0.01	0.739	0.74
	LTE 38	QPSK20M	Rear Face	0	37850	1	0	3	4cell	w/	18.00	17.98	1.00	0.04	0.718	0.72
	LTE 38	QPSK20M	Rear Face	0	37850	1	0	4	4cell	w/	18.00	17.98	1.00	0.06	0.725	0.73
	LTE 38	QPSK20M	Rear Face	0	37850	1	0	1	6cell	w/	18.00	17.98	1.00	-0.04	0.974	0.97
	LTE 38	QPSK20M	Rear Face	0	38000	1	0	1	6cell	w/	18.00	17.82	1.04	0.04	0.912	0.95
	LTE 38	QPSK20M	Rear Face	0	38150	1	0	1	6cell	w/	18.00	17.77	1.05	0.14	0.926	0.97
	LTE 38	QPSK20M	Rear Face	0	37850	1	0	1	4cell	w/	18.00	17.98	1.00	0.06	1.02	1.02

Note: The "< 0.001" means there is no SAR value or the SAR is too low to be measured.

# SAR Test Report

Plot No.	Band	Mode	Test Position	Gap (mm)	Ch.	RB	offset	Sample	Battery	Reduction Power	Maximum Tune-up (dBm)	Conducted Power (dBm)	Scaling Factor	Power Drift	SAR 1g	Scaled 1g SAR
	LTE 41	QPSK20M	Rear Face	20	40620	1	0	1	4cell	w/o	24.50	23.94	1.14	-0.15	0.229	0.26
	LTE 41	QPSK20M	Left Side	0	40620	1	0	1	4cell	w/o	24.50	23.94	1.14	-0.04	0.249	0.28
	LTE 41	QPSK20M	Right Side	0	40620	1	0	1	4cell	w/o	24.50	23.94	1.14	0	<0.001	0.00
	LTE 41	QPSK20M	Top Side	0	40620	1	0	1	4cell	w/o	24.50	23.94	1.14	0	<0.001	0.00
	LTE 41	QPSK20M	Bottom Side	15	40620	1	0	1	4cell	w/o	24.50	23.94	1.14	0.01	0.212	0.24
	LTE 41	QPSK20M	Rear Face	20	40620	50	0	1	4cell	w/o	23.50	22.95	1.14	0.14	0.19	0.22
	LTE 41	QPSK20M	Left Side	0	40620	50	0	1	4cell	w/o	23.50	22.95	1.14	0	0.195	0.22
	LTE 41	QPSK20M	Right Side	0	40620	50	0	1	4cell	w/o	23.50	22.95	1.14	0	<0.001	0.00
	LTE 41	QPSK20M	Top Side	0	40620	50	0	1	4cell	w/o	23.50	22.95	1.14	0	<0.001	0.00
	LTE 41	QPSK20M	Bottom Side	15	40620	50	0	1	4cell	w/o	23.50	22.95	1.14	0.16	0.121	0.14
	LTE 41	QPSK20M	Rear Face	0	40620	1	0	1	4cell	w/	17.00	16.93	1.02	0.03	0.822	0.84
	LTE 41	QPSK20M	Bottom Side	0	40620	1	0	1	4cell	w/	17.00	16.93	1.02	0.05	0.291	0.30
	LTE 41	QPSK20M	Rear Face	0	40620	50	0	1	4cell	w/	17.00	16.93	1.02	0.07	0.774	0.79
	LTE 41	QPSK20M	Bottom Side	0	40620	50	0	1	4cell	w/	17.00	16.93	1.02	-0.11	0.267	0.27
	LTE 41	QPSK20M	Rear Face	0	40620	100	0	1	4cell	w/	17.00	16.86	1.03	-0.16	0.765	0.79
	LTE 41	QPSK20M	Rear Face	0	39750	1	0	1	4cell	w/	17.00	16.86	1.03	-0.17	1.08	1.11
17	LTE 41	QPSK20M	Rear Face	0	40185	1	0	1	4cell	w/	17.00	16.85	1.04	-0.17	1.09	1.13
	LTE 41	QPSK20M	Rear Face	0	41055	1	0	1	4cell	w/	17.00	16.75	1.06	-0.13	0.754	0.80
	LTE 41	QPSK20M	Rear Face	0	41490	1	0	1	4cell	w/	17.00	16.71	1.07	-0.14	0.676	0.72
	LTE 41	QPSK20M	Rear Face	0	40185	1	0	2	4cell	w/	17.00	16.85	1.04	0.01	0.982	1.02
	LTE 41	QPSK20M	Rear Face	0	40185	1	0	3	4cell	w/	17.00	16.85	1.04	0.1	0.914	0.95
	LTE 41	QPSK20M	Rear Face	0	40185	1	0	4	4cell	w/	17.00	16.85	1.04	0.13	0.842	0.88
	LTE 41	QPSK20M	Rear Face	0	39750	1	0	2	4cell	w/	17.00	16.86	1.03	0.01	0.982	1.01
	LTE 41	QPSK20M	Rear Face	0	40620	1	0	2	4cell	w/	17.00	16.93	1.02	0.09	1.05	1.07
	LTE 41	QPSK20M	Rear Face	0	41055	1	0	2	4cell	w/	17.00	16.75	1.06	0.12	0.635	0.67
	LTE 41	QPSK20M	Rear Face	0	41490	1	0	2	4cell	w/	17.00	16.71	1.07	0.19	0.947	1.01
	LTE 41	QPSK20M	Rear Face	0	39750	1	0	3	4cell	w/	17.00	16.86	1.03	0.10	0.914	0.94
	LTE 41	QPSK20M	Rear Face	0	40620	1	0	3	4cell	w/	17.00	16.93	1.02	0.04	0.878	0.90
	LTE 41	QPSK20M	Rear Face	0	41055	1	0	3	4cell	w/	17.00	16.75	1.06	-0.02	0.829	0.88
	LTE 41	QPSK20M	Rear Face	0	41490	1	0	3	4cell	w/	17.00	16.71	1.07	-0.06	0.705	0.75
	LTE 41	QPSK20M	Rear Face	0	39750	1	0	4	4cell	w/	17.00	16.86	1.03	0.13	0.842	0.87
	LTE 41	QPSK20M	Rear Face	0	40620	1	0	4	4cell	w/	17.00	16.93	1.02	-0.16	0.625	0.64
	LTE 41	QPSK20M	Rear Face	0	41055	1	0	4	4cell	w/	17.00	16.75	1.06	-0.02	0.794	0.84
	LTE 41	QPSK20M	Rear Face	0	41490	1	0	4	4cell	w/	17.00	16.71	1.07	0.1	0.858	0.92
	LTE 41	QPSK20M	Rear Face	0	40185	1	0	1	6cell	w/	17.00	16.85	1.04	0.06	0.692	0.72
	LTE 41	QPSK20M	Rear Face	0	39750	1	0	1	6cell	w/	17.00	16.86	1.03	0.18	1.07	1.10
	LTE 41	QPSK20M	Rear Face	0	40620	1	0	1	6cell	w/	17.00	16.93	1.02	0.02	1.05	1.07
	LTE 41	QPSK20M	Rear Face	0	41055	1	0	1	6cell	w/	17.00	16.75	1.06	0.04	0.612	0.65
	LTE 41	QPSK20M	Rear Face	0	41490	1	0	1	6cell	w/	17.00	16.71	1.07	0.17	0.925	0.99
	LTE 41	QPSK20M	Rear Face	0	40185	1	0	1	4cell	w/	17.00	16.85	1.04	-0.19	1.06	1.10
	LTE 41	QPSK20M	Rear Face	0	40185	1	0	1	4cell	w/	17.00	16.85	1.04	-0.19	1.06	1.10

Note: The "< 0.001" means there is no SAR value or the SAR is too low to be measured.



# SAR Test Report

Plot No.	Band	Mode	Test Position	Gap (mm)	Ch.	RB	offset	Sample	Battery	Reduction Power	Maximum Tune-up (dBm)	Conducted Power (dBm)	Scaling Factor	Power Drift	SAR 1g	Scaled 1g SAR
	LTE 66	QPSK20M	Rear Face	20	132072	1	0	1	4cell	w/o	24.50	24.08	1.10	0.07	0.18	0.20
	LTE 66	QPSK20M	Left Side	0	132072	1	0	1	4cell	w/o	24.50	24.08	1.10	0.09	0.722	0.79
	LTE 66	QPSK20M	Right Side	0	132072	1	0	1	4cell	w/o	24.50	24.08	1.10	-0.1	0.443	0.49
	LTE 66	QPSK20M	Top Side	0	132072	1	0	1	4cell	w/o	24.50	24.08	1.10	-0.17	0.071	0.08
	LTE 66	QPSK20M	Bottom Side	15	132072	1	0	1	4cell	w/o	24.50	24.08	1.10	0.13	0.147	0.16
	LTE 66	QPSK20M	Rear Face	20	132072	50	0	1	4cell	w/o	23.50	22.97	1.13	0.19	0.143	0.16
	LTE 66	QPSK20M	Left Side	0	132072	50	0	1	4cell	w/o	23.50	22.97	1.13	-0.16	0.57	0.64
	LTE 66	QPSK20M	Right Side	0	132072	50	0	1	4cell	w/o	23.50	22.97	1.13	0.14	0.301	0.34
	LTE 66	QPSK20M	Top Side	0	132072	50	0	1	4cell	w/o	23.50	22.97	1.13	0.03	0.044	0.05
	LTE 66	QPSK20M	Bottom Side	15	132072	50	0	1	4cell	w/o	23.50	22.97	1.13	0.18	0.095	0.11
20	LTE 66	QPSK20M	Rear Face	0	132572	1	0	1	4cell	w/	16.00	15.92	1.02	0.05	0.846	<b>0.86</b>
	LTE 66	QPSK20M	Bottom Side	0	132572	1	0	1	4cell	w/	16.00	15.92	1.02	0.16	0.362	0.37
	LTE 66	QPSK20M	Rear Face	0	132572	50	0	1	4cell	w/	16.00	15.82	1.04	-0.16	0.764	0.79
	LTE 66	QPSK20M	Bottom Side	0	132572	50	0	1	4cell	w/	16.00	15.82	1.04	-0.09	0.336	0.35
	LTE 66	QPSK20M	Rear Face	0	132572	100	0	1	4cell	w/	16.00	15.79	1.05	0.03	0.466	0.49
	LTE 66	QPSK20M	Rear Face	0	132072	1	0	1	4cell	w/	16.00	15.81	1.04	0.18	0.815	0.85
	LTE 66	QPSK20M	Rear Face	0	132322	1	0	1	4cell	w/	16.00	15.82	1.04	-0.11	0.813	0.85
	LTE 66	QPSK20M	Rear Face	0	132572	1	0	2	4cell	w/	16.00	15.92	1.02	0.18	0.777	0.79
	LTE 66	QPSK20M	Rear Face	0	132572	1	0	3	4cell	w/	16.00	15.92	1.02	-0.03	0.767	0.78
	LTE 66	QPSK20M	Rear Face	0	132572	1	0	4	4cell	w/	16.00	15.92	1.02	0.03	0.778	0.79
	LTE 66	QPSK20M	Rear Face	0	132572	1	0	1	6cell	w/	16.00	15.92	1.02	0.09	0.772	0.79
	LTE 66	QPSK20M	Rear Face	0	132572	1	0	1	4cell	w/	16.00	15.92	1.02	0.05	0.839	0.86

# SAR Test Report

Plot No.	Band	Mode	Test Position	Gap (mm)	Ch.	Sample	Ant Status	Battery	Duty Cycle	Crest Factor	Maximum Tune-up (dBm)	Conducted Power (dBm)	Scaling Factor	Power Drift	SAR 1g	Scaled 1g SAR
	WLAN2.4G	802.11b	Rear Face	0	11	1	Ant 0	4cell	100.00	1.00	16.50	16.48	1.00	-0.06	0.303	0.30
	WLAN2.4G	802.11b	Left Side	0	11	1	Ant 0	4cell	100.00	1.00	16.50	16.48	1.00	0	<0.001	0.00
	WLAN2.4G	802.11b	Right Side	0	11	1	Ant 0	4cell	100.00	1.00	16.50	16.48	1.00	0.04	0.188	0.19
	WLAN2.4G	802.11b	Top Side	0	11	1	Ant 0	4cell	100.00	1.00	16.50	16.48	1.00	0	<0.001	0.00
	WLAN2.4G	802.11b	Bottom Side	0	11	1	Ant 0	4cell	100.00	1.00	16.50	16.48	1.00	0	<0.001	0.00
21	WLAN2.4G	802.11b	Rear Face	0	6	1	Ant 1	4cell	100.00	1.00	18.00	17.98	1.00	-0.07	0.524	0.52
	WLAN2.4G	802.11b	Left Side	0	6	1	Ant 1	4cell	100.00	1.00	18.00	17.98	1.00	0.12	0.095	0.10
	WLAN2.4G	802.11b	Right Side	0	6	1	Ant 1	4cell	100.00	1.00	18.00	17.98	1.00	0.01	0.051	0.05
	WLAN2.4G	802.11b	Top Side	0	6	1	Ant 1	4cell	100.00	1.00	18.00	17.98	1.00	0.16	0.456	0.46
	WLAN2.4G	802.11b	Bottom Side	0	6	1	Ant 1	4cell	100.00	1.00	18.00	17.98	1.00	0	<0.001	0.00
	WLAN2.4G	802.11n HT40	Rear Face	0	3	1	Ant 0+1	4cell	99.00	1.01	19.50	19.44	1.01	-0.04	0.348	0.35
	WLAN2.4G	802.11n HT40	Left Side	0	3	1	Ant 0+1	4cell	99.00	1.01	19.50	19.44	1.01	0.04	0.054	0.06
	WLAN2.4G	802.11n HT40	Right Side	0	3	1	Ant 0+1	4cell	99.00	1.01	19.50	19.44	1.01	0.16	0.057	0.06
	WLAN2.4G	802.11n HT40	Top Side	0	3	1	Ant 0+1	4cell	99.00	1.01	19.50	19.44	1.01	0.04	0.243	0.25
	WLAN2.4G	802.11n HT40	Bottom Side	0	3	1	Ant 0+1	4cell	99.00	1.01	19.50	19.44	1.01	-0.02	<0.001	0.00
	WLAN2.4G	802.11b	Rear Face	0	1	1	Ant 1	4cell	100.00	1.00	18.00	17.90	1.02	-0.06	0.504	0.51
	WLAN2.4G	802.11b	Rear Face	0	11	1	Ant 1	4cell	100.00	1.00	18.00	17.94	1.01	0.04	0.509	0.51
	WLAN2.4G	802.11b	Rear Face	0	12	1	Ant 1	4cell	100.00	1.00	18.00	17.97	1.01	-0.14	0.498	0.50
	WLAN2.4G	802.11b	Rear Face	0	13	1	Ant 1	4cell	100.00	1.00	18.00	17.94	1.01	0.06	0.5	0.51
	WLAN2.4G	802.11b	Rear Face	0	6	2	Ant 1	4cell	100.00	1.00	18.00	17.98	1.00	-0.04	0.491	0.49
	WLAN2.4G	802.11b	Rear Face	0	6	3	Ant 1	4cell	100.00	1.00	18.00	17.98	1.00	-0.01	0.514	0.51
	WLAN2.4G	802.11b	Rear Face	0	6	4	Ant 1	4cell	100.00	1.00	18.00	17.98	1.00	0.02	0.49	0.49
	WLAN2.4G	802.11b	Rear Face	0	6	1	Ant 1	6cell	100.00	1.00	18.00	17.98	1.00	0.06	0.508	0.51
	WLAN5.2G	802.11ac VHT80	Rear Face	0	42	1	Ant 0	4cell	99.00	1.01	14.00	13.95	1.01	-0.06	0.516	0.53
	WLAN5.2G	802.11ac VHT80	Left Side	0	42	1	Ant 0	4cell	99.00	1.01	14.00	13.95	1.01	0.04	0.04	0.04
	WLAN5.2G	802.11ac VHT80	Right Side	0	42	1	Ant 0	4cell	99.00	1.01	14.00	13.95	1.01	0.02	0.038	0.04
	WLAN5.2G	802.11ac VHT80	Top Side	0	42	1	Ant 0	4cell	99.00	1.01	14.00	13.95	1.01	0.14	0.857	0.87
	WLAN5.2G	802.11ac VHT80	Bottom Side	0	42	1	Ant 0	4cell	99.00	1.01	14.00	13.95	1.01	0	<0.001	0.00
	WLAN5.2G	802.11ac VHT80	Rear Face	0	42	1	Ant 1	4cell	97.00	1.03	13.00	12.94	1.01	0.06	0.231	0.24
	WLAN5.2G	802.11ac VHT80	Left Side	0	42	1	Ant 1	4cell	97.00	1.03	13.00	12.94	1.01	-0.01	0.066	0.07
	WLAN5.2G	802.11ac VHT80	Right Side	0	42	1	Ant 1	4cell	97.00	1.03	13.00	12.94	1.01	-0.03	0.049	0.05
22	WLAN5.2G	802.11ac VHT80	Top Side	0	42	1	Ant 1	4cell	97.00	1.03	13.00	12.94	1.01	0.02	1.06	1.10
	WLAN5.2G	802.11ac VHT80	Bottom Side	0	42	1	Ant 1	4cell	97.00	1.03	13.00	12.94	1.01	0	<0.001	0.00
	WLAN5.2G	802.11ac VHT80	Rear Face	0	42	1	Ant 0+1	4cell	97.00	1.03	16.00	15.84	1.04	-0.12	0.346	0.37
	WLAN5.2G	802.11ac VHT80	Left Side	0	42	1	Ant 0+1	4cell	97.00	1.03	16.00	15.84	1.04	0.1	0.08	0.09
	WLAN5.2G	802.11ac VHT80	Right Side	0	42	1	Ant 0+1	4cell	97.00	1.03	16.00	15.84	1.04	0.01	0.042	0.04
	WLAN5.2G	802.11ac VHT80	Top Side	0	42	1	Ant 0+1	4cell	97.00	1.03	16.00	15.84	1.04	0.06	0.753	0.81
	WLAN5.2G	802.11ac VHT80	Bottom Side	0	42	1	Ant 0+1	4cell	97.00	1.03	16.00	15.84	1.04	-0.05	<0.001	0.00
	WLAN5.2G	802.11ac VHT80	Top Side	0	42	2	Ant 1	4cell	97.00	1.03	13.00	12.94	1.01	0.04	1.02	1.06
	WLAN5.2G	802.11ac VHT80	Top Side	0	42	3	Ant 1	4cell	97.00	1.03	13.00	12.94	1.01	-0.01	1.03	1.07
	WLAN5.2G	802.11ac VHT80	Top Side	0	42	4	Ant 1	4cell	97.00	1.03	13.00	12.94	1.01	0.04	0.983	1.02
	WLAN5.2G	802.11ac VHT80	Top Side	0	42	1	Ant 1	6cell	97.00	1.03	13.00	12.94	1.01	0.11	0.99	1.03
	WLAN5.2G	802.11ac VHT80	Top Side	0	42	1	Ant 1	4cell	97.00	1.03	13.00	12.94	1.01	0.04	1.03	1.07

Note: The "< 0.001" means there is no SAR value or the SAR is too low to be measured.

# SAR Test Report

Plot No.	Band	Mode	Test Position	Gap (mm)	Ch.	Sample	Ant Status	Battery	Duty Cycle	Crest Factor	Maximum Tune-up (dBm)	Conducted Power (dBm)	Scaling Factor	Power Drift	SAR 1g	Scaled 1g SAR
	WLAN5.6G	802.11ac VHT160	Rear Face	0	114	1	Ant 0	4cell	97.00	1.03	13.00	12.91	1.02	0.06	0.21	0.22
	WLAN5.6G	802.11ac VHT160	Left Side	0	114	1	Ant 0	4cell	97.00	1.03	13.00	12.91	1.02	-0.04	0.025	0.03
	WLAN5.6G	802.11ac VHT160	Right Side	0	114	1	Ant 0	4cell	97.00	1.03	13.00	12.91	1.02	-0.12	0.055	0.06
23	WLAN5.6G	802.11ac VHT160	Top Side	0	114	1	Ant 0	4cell	97.00	1.03	13.00	12.91	1.02	0.05	0.732	0.77
	WLAN5.6G	802.11ac VHT160	Bottom Side	0	114	1	Ant 0	4cell	97.00	1.03	13.00	12.91	1.02	0	<0.001	0.00
	WLAN5.6G	802.11ac VHT160	Rear Face	0	114	1	Ant 1	4cell	97.00	1.03	12.00	11.92	1.02	0.06	0.189	0.20
	WLAN5.6G	802.11ac VHT160	Left Side	0	114	1	Ant 1	4cell	97.00	1.03	12.00	11.92	1.02	0.04	0.027	0.03
	WLAN5.6G	802.11ac VHT160	Right Side	0	114	1	Ant 1	4cell	97.00	1.03	12.00	11.92	1.02	0.16	0.038	0.04
	WLAN5.6G	802.11ac VHT160	Top Side	0	114	1	Ant 1	4cell	97.00	1.03	12.00	11.92	1.02	-0.02	0.529	0.56
	WLAN5.6G	802.11ac VHT160	Bottom Side	0	114	1	Ant 1	4cell	97.00	1.03	12.00	11.92	1.02	0	<0.001	0.00
	WLAN5.6G	802.11ac VHT160	Rear Face	0	114	1	Ant 0+1	4cell	97.00	1.03	15.00	14.95	1.01	-0.06	0.254	0.26
	WLAN5.6G	802.11ac VHT160	Left Side	0	114	1	Ant 0+1	4cell	97.00	1.03	15.00	14.95	1.01	0.04	0.032	0.03
	WLAN5.6G	802.11ac VHT160	Right Side	0	114	1	Ant 0+1	4cell	97.00	1.03	15.00	14.95	1.01	0.01	0.087	0.09
	WLAN5.6G	802.11ac VHT160	Top Side	0	114	1	Ant 0+1	4cell	97.00	1.03	15.00	14.95	1.01	0.02	0.509	0.53
	WLAN5.6G	802.11ac VHT160	Bottom Side	0	114	1	Ant 0+1	4cell	97.00	1.03	15.00	14.95	1.01	0	<0.001	0.00
	WLAN5.6G	802.11ac VHT160	Top Side	0	114	2	Ant 0	4cell	97.00	1.03	13.00	12.91	1.02	-0.1	0.714	0.75
	WLAN5.6G	802.11ac VHT160	Top Side	0	114	3	Ant 0	4cell	97.00	1.03	13.00	12.91	1.02	0.04	0.648	0.68
	WLAN5.6G	802.11ac VHT160	Top Side	0	114	4	Ant 0	4cell	97.00	1.03	13.00	12.91	1.02	0.09	0.678	0.71
	WLAN5.6G	802.11ac VHT160	Top Side	0	114	1	Ant 0	6cell	97.00	1.03	13.00	12.91	1.02	0.14	0.642	0.67
	WLAN5.8G	802.11ac VHT80	Rear Face	0	155	1	Ant 0	4cell	97.60	1.02	12.00	11.88	1.03	0.02	0.213	0.22
	WLAN5.8G	802.11ac VHT80	Left Side	0	155	1	Ant 0	4cell	97.60	1.02	12.00	11.88	1.03	0	<0.001	0.00
	WLAN5.8G	802.11ac VHT80	Right Side	0	155	1	Ant 0	4cell	97.60	1.02	12.00	11.88	1.03	-0.06	0.049	0.05
	WLAN5.8G	802.11ac VHT80	Top Side	0	155	1	Ant 0	4cell	97.60	1.02	12.00	11.88	1.03	-0.14	0.541	0.57
	WLAN5.8G	802.11ac VHT80	Bottom Side	0	155	1	Ant 0	4cell	97.60	1.02	12.00	11.88	1.03	0	<0.001	0.00
	WLAN5.8G	802.11ac VHT80	Rear Face	0	155	1	Ant 1	4cell	97.00	1.03	11.50	11.47	1.01	0.04	0.215	0.22
	WLAN5.8G	802.11ac VHT80	Left Side	0	155	1	Ant 1	4cell	97.00	1.03	11.50	11.47	1.01	0.06	0.025	0.03
	WLAN5.8G	802.11ac VHT80	Right Side	0	155	1	Ant 1	4cell	97.00	1.03	11.50	11.47	1.01	0.08	0.039	0.04
	WLAN5.8G	802.11ac VHT80	Top Side	0	155	1	Ant 1	4cell	97.00	1.03	11.50	11.47	1.01	-0.04	0.577	0.60
	WLAN5.8G	802.11ac VHT80	Bottom Side	0	155	1	Ant 1	4cell	97.00	1.03	11.50	11.47	1.01	0	<0.001	0.00
	WLAN5.8G	802.11ac VHT80	Rear Face	0	155	1	Ant 0+1	4cell	97.00	1.03	14.50	14.38	1.03	0.05	0.198	0.21
	WLAN5.8G	802.11ac VHT80	Left Side	0	155	1	Ant 0+1	4cell	97.00	1.03	14.50	14.38	1.03	0.14	0.035	0.04
	WLAN5.8G	802.11ac VHT80	Right Side	0	155	1	Ant 0+1	4cell	97.00	1.03	14.50	14.38	1.03	0.12	0.09	0.10
24	WLAN5.8G	802.11ac VHT80	Top Side	0	155	1	Ant 0+1	4cell	97.00	1.03	14.50	14.38	1.03	0.1	0.587	0.62
	WLAN5.8G	802.11ac VHT80	Bottom Side	0	155	1	Ant 0+1	4cell	97.00	1.03	14.50	14.38	1.03	0	<0.001	0.00
	WLAN5.8G	802.11ac VHT80	Top Side	0	155	2	Ant 0+1	4cell	97.00	1.03	14.50	14.38	1.03	0.1	0.579	0.61
	WLAN5.8G	802.11ac VHT80	Top Side	0	155	3	Ant 0+1	4cell	97.00	1.03	14.50	14.38	1.03	0.06	0.578	0.61
	WLAN5.8G	802.11ac VHT80	Top Side	0	155	4	Ant 0+1	4cell	97.00	1.03	14.50	14.38	1.03	-0.04	0.579	0.61
	WLAN5.8G	802.11ac VHT80	Top Side	0	155	1	Ant 0+1	6cell	97.00	1.03	14.50	14.38	1.03	-0.05	0.567	0.60
	BT	BR / EDR	Rear Face	0	0	1	Ant 1	4cell	76.80	1.30	10.50	9.81	1.17	0.06	0.059	0.09
	BT	BR / EDR	Left Side	0	0	1	Ant 1	4cell	76.80	1.30	10.50	9.81	1.17	0	<0.001	0.00
	BT	BR / EDR	Right Side	0	0	1	Ant 1	4cell	76.80	1.30	10.50	9.81	1.17	0	<0.001	0.00
25	BT	BR / EDR	Top Side	0	0	1	Ant 1	4cell	76.80	1.30	10.50	9.81	1.17	0.13	0.063	0.10
	BT	BR / EDR	Bottom Side	0	0	1	Ant 1	4cell	76.80	1.30	10.50	9.81	1.17	0	0.0041	0.01
	BT	BR / EDR	Top Side	0	39	1	Ant 1	4cell	76.80	1.30	10.50	9.52	1.25	0.04	0.051	0.08
	BT	BR / EDR	Top Side	0	78	1	Ant 1	4cell	76.80	1.30	10.50	9.72	1.20	0.06	0.054	0.08
	BT	BR / EDR	Top Side	0	0	2	Ant 1	4cell	76.80	1.30	10.50	9.81	1.17	-0.01	0.057	0.09
	BT	BR / EDR	Top Side	0	0	3	Ant 1	4cell	76.80	1.30	10.50	9.81	1.17	-0.04	0.051	0.08
	BT	BR / EDR	Top Side	0	0	4	Ant 1	4cell	76.80	1.30	10.50	9.81	1.17	0.06	0.052	0.08
	BT	BR / EDR	Top Side	0	0	1	Ant 1	6cell	76.80	1.30	10.50	9.81	1.17	-0.12	0.047	0.07

Note: The "< 0.001" means there is no SAR value or the SAR is too low to be measured.



# SAR Test Report

## Laptop PC Mode

Plot No.	Band	Mode	Test Position	Gap (mm)	Ch.	Sample	Battery	Reduction Power	Maximum Tune-up (dBm)	Conducted Power (dBm)	Scaling Factor	Power Drift	SAR 1g	Scaled 1g SAR
	WCDMA II	RMC12.2K	Bottom	0	9262	1	4cell	w/	18.50	18.43	1.02	0.18	0.614	0.63
	WCDMA II	RMC12.2K	Bottom	0	9400	1	4cell	w/	18.50	18.29	1.05	0.11	0.668	0.70
26	WCDMA II	RMC12.2K	Bottom	0	9538	1	4cell	w/	18.50	18.41	1.02	0.06	0.881	0.90
	WCDMA II	RMC12.2K	Bottom	0	9538	2	4cell	w/	18.50	18.41	1.02	0.1	0.799	0.81
	WCDMA II	RMC12.2K	Bottom	0	9538	3	4cell	w/	18.50	18.41	1.02	-0.08	0.721	0.74
	WCDMA II	RMC12.2K	Bottom	0	9538	4	4cell	w/	18.50	18.41	1.02	-0.04	0.692	0.71
	WCDMA II	RMC12.2K	Bottom	0	9262	2	4cell	w/	18.50	18.43	1.02	-0.19	0.711	0.73
	WCDMA II	RMC12.2K	Bottom	0	9400	2	4cell	w/	18.50	18.29	1.05	-0.04	0.742	0.78
	WCDMA II	RMC12.2K	Bottom	0	9538	1	6cell	w/	18.50	18.41	1.02	0.13	0.736	0.75
	WCDMA II	RMC12.2K	Bottom	0	9538	1	4cell	w/	18.50	18.41	1.02	0.06	0.876	0.89
	WCDMA IV	RMC12.2K	Bottom	0	1413	1	4cell	w/	20.00	19.94	1.01	-0.11	0.797	0.80
	WCDMA IV	RMC12.2K	Bottom	0	1312	1	4cell	w/	20.00	19.93	1.02	-0.17	0.741	0.76
27	WCDMA IV	RMC12.2K	Bottom	0	1513	1	4cell	w/	20.00	19.90	1.02	-0.14	0.97	0.99
	WCDMA IV	RMC12.2K	Bottom	0	1513	2	4cell	w/	20.00	19.90	1.02	0.11	0.865	0.88
	WCDMA IV	RMC12.2K	Bottom	0	1513	3	4cell	w/	20.00	19.90	1.02	-0.13	0.805	0.82
	WCDMA IV	RMC12.2K	Bottom	0	1513	4	4cell	w/	20.00	19.90	1.02	-0.05	0.885	0.90
	WCDMA IV	RMC12.2K	Bottom	0	1312	2	4cell	w/	20.00	19.93	1.02	-0.14	0.759	0.77
	WCDMA IV	RMC12.2K	Bottom	0	1413	2	4cell	w/	20.00	19.94	1.01	-0.16	0.861	0.87
	WCDMA IV	RMC12.2K	Bottom	0	1312	3	4cell	w/	20.00	19.93	1.02	-0.16	0.848	0.86
	WCDMA IV	RMC12.2K	Bottom	0	1413	3	4cell	w/	20.00	19.94	1.01	0.19	0.934	0.94
	WCDMA IV	RMC12.2K	Bottom	0	1312	4	4cell	w/	20.00	19.93	1.02	-0.06	0.847	0.86
	WCDMA IV	RMC12.2K	Bottom	0	1413	4	4cell	w/	20.00	19.94	1.01	0.07	0.907	0.92
	WCDMA IV	RMC12.2K	Bottom	0	1513	1	6cell	w/	20.00	19.90	1.02	-0.1	0.871	0.89
	WCDMA IV	RMC12.2K	Bottom	0	1312	1	6cell	w/	20.00	19.93	1.02	-0.02	0.824	0.84
	WCDMA IV	RMC12.2K	Bottom	0	1413	1	6cell	w/	20.00	19.94	1.01	0.02	0.879	0.89
	WCDMA IV	RMC12.2K	Bottom	0	1513	1	4cell	w/	20.00	19.90	1.02	-0.14	0.92	0.94
28	WCDMA V	RMC12.2K	Bottom	0	4233	1	4cell	w/	22.50	22.44	1.01	-0.02	1.04	1.05
	WCDMA V	RMC12.2K	Bottom	0	4132	1	4cell	w/	22.50	22.36	1.03	0.04	0.946	0.97
	WCDMA V	RMC12.2K	Bottom	0	4182	1	4cell	w/	22.50	22.42	1.02	-0.15	0.965	0.98
	WCDMA V	RMC12.2K	Bottom	0	4233	2	4cell	w/	22.50	22.44	1.01	-0.04	0.894	0.90
	WCDMA V	RMC12.2K	Bottom	0	4233	3	4cell	w/	22.50	22.44	1.01	-0.04	0.863	0.87
	WCDMA V	RMC12.2K	Bottom	0	4233	4	4cell	w/	22.50	22.44	1.01	0.11	0.781	0.79
	WCDMA V	RMC12.2K	Bottom	0	4132	2	4cell	w/	22.50	22.36	1.03	0.04	0.794	0.82
	WCDMA V	RMC12.2K	Bottom	0	4182	2	4cell	w/	22.50	22.42	1.02	0.11	0.787	0.80
	WCDMA V	RMC12.2K	Bottom	0	4132	3	4cell	w/	22.50	22.36	1.03	0.19	0.851	0.88
	WCDMA V	RMC12.2K	Bottom	0	4182	3	4cell	w/	22.50	22.42	1.02	0.02	0.885	0.90
	WCDMA V	RMC12.2K	Bottom	0	4132	4	4cell	w/	22.50	22.36	1.03	-0.17	0.901	0.93
	WCDMA V	RMC12.2K	Bottom	0	4182	4	4cell	w/	22.50	22.42	1.02	0.1	0.917	0.94
	WCDMA V	RMC12.2K	Bottom	0	4233	1	6cell	w/	22.50	22.44	1.01	-0.01	0.872	0.88
	WCDMA V	RMC12.2K	Bottom	0	4132	1	6cell	w/	22.50	22.36	1.03	0.15	0.983	1.01
	WCDMA V	RMC12.2K	Bottom	0	4182	1	6cell	w/	22.50	22.42	1.02	0.14	0.922	0.94
	WCDMA V	RMC12.2K	Bottom	0	4233	1	4cell	w/	22.50	22.44	1.01	-0.02	0.99	1.00



# SAR Test Report

Plot No.	Band	Mode	Test Position	Gap (mm)	Ch.	RB	offset	Sample	Battery	Reduction Power	Maximum Tune-up (dBm)	Conducted Power (dBm)	Scaling Factor	Power Drift	SAR 1g	Scaled 1g SAR
29	LTE 2	QPSK20M	Bottom	0	19100	1	0	1	4cell	w/	18.00	17.92	1.02	-0.11	0.838	<b>0.85</b>
	LTE 2	QPSK20M	Bottom	0	19100	50	0	1	4cell	w/	18.00	17.84	1.04	0.06	0.782	0.81
	LTE 2	QPSK20M	Bottom	0	19100	100	0	1	4cell	w/	18.00	17.71	1.07	0.04	0.756	0.81
	LTE 2	QPSK20M	Bottom	0	18700	1	0	1	4cell	w/	18.00	17.89	1.03	-0.1	0.628	0.65
	LTE 2	QPSK20M	Bottom	0	18900	1	0	1	4cell	w/	18.00	17.87	1.03	-0.16	0.697	0.72
	LTE 2	QPSK20M	Bottom	0	18700	50	0	1	4cell	w/	18.00	17.66	1.08	-0.17	0.618	0.67
	LTE 2	QPSK20M	Bottom	0	18900	50	0	1	4cell	w/	18.00	17.81	1.04	-0.13	0.676	0.70
	LTE 2	QPSK20M	Bottom	0	19100	1	0	2	4cell	w/	18.00	17.92	1.02	0.09	0.795	0.81
	LTE 2	QPSK20M	Bottom	0	19100	1	0	3	4cell	w/	18.00	17.92	1.02	-0.07	0.809	0.83
	LTE 2	QPSK20M	Bottom	0	19100	1	0	4	4cell	w/	18.00	17.92	1.02	0.19	0.766	0.78
	LTE 2	QPSK20M	Bottom	0	18700	1	0	2	4cell	w/	18.00	17.89	1.03	0.12	0.791	0.81
	LTE 2	QPSK20M	Bottom	0	18900	1	0	2	4cell	w/	18.00	17.87	1.03	-0.07	0.785	0.81
	LTE 2	QPSK20M	Bottom	0	18700	1	0	3	4cell	w/	18.00	17.89	1.03	0	0.802	0.83
	LTE 2	QPSK20M	Bottom	0	18900	1	0	3	4cell	w/	18.00	17.87	1.03	-0.15	0.798	0.82
	LTE 2	QPSK20M	Bottom	0	19100	1	0	1	6cell	w/	18.00	17.92	1.02	0.06	0.751	0.77
LTE 2	QPSK20M	Bottom	0	19100	1	0	1	4cell	w/	18.00	17.92	1.02	-0.11	0.832	0.85	
30	LTE 4	QPSK20M	Bottom	0	20300	1	0	1	4cell	w/	20.00	19.95	1.01	0.19	0.926	0.94
	LTE 4	QPSK20M	Bottom	0	20300	50	0	1	4cell	w/	20.00	19.90	1.02	0.16	0.915	0.93
	LTE 4	QPSK20M	Bottom	0	20300	100	0	1	4cell	w/	20.00	19.87	1.03	0.08	0.886	0.91
	LTE 4	QPSK20M	Bottom	0	20050	1	0	1	4cell	w/	20.00	19.85	1.04	0.05	0.906	0.94
	LTE 4	QPSK20M	Bottom	0	20175	1	0	1	4cell	w/	20.00	19.93	1.02	-0.09	0.964	<b>0.98</b>
	LTE 4	QPSK20M	Bottom	0	20050	50	0	1	4cell	w/	20.00	19.75	1.06	0.16	0.893	0.95
	LTE 4	QPSK20M	Bottom	0	20175	50	0	1	4cell	w/	20.00	19.75	1.06	-0.07	0.901	0.96
	LTE 4	QPSK20M	Bottom	0	20175	1	0	2	4cell	w/	20.00	19.93	1.02	-0.08	0.915	0.93
	LTE 4	QPSK20M	Bottom	0	20175	1	0	3	4cell	w/	20.00	19.93	1.02	-0.07	0.931	0.95
	LTE 4	QPSK20M	Bottom	0	20175	1	0	4	4cell	w/	20.00	19.93	1.02	0.08	0.909	0.93
	LTE 4	QPSK20M	Bottom	0	20050	1	0	2	4cell	w/	20.00	19.85	1.04	0.06	0.912	0.95
	LTE 4	QPSK20M	Bottom	0	20300	1	0	2	4cell	w/	20.00	19.95	1.01	0.11	0.907	0.92
	LTE 4	QPSK20M	Bottom	0	20050	1	0	3	4cell	w/	20.00	19.85	1.04	0.13	0.925	0.96
	LTE 4	QPSK20M	Bottom	0	20300	1	0	3	4cell	w/	20.00	19.95	1.01	0.16	0.912	0.92
	LTE 4	QPSK20M	Bottom	0	20050	1	0	4	4cell	w/	20.00	19.85	1.04	0.17	0.904	0.94
31	LTE 5	QPSK10M	Bottom	0	20600	1	0	1	4cell	w/	22.00	21.96	1.01	-0.11	0.935	0.94
	LTE 5	QPSK10M	Bottom	0	20600	25	0	1	4cell	w/	22.00	21.89	1.03	-0.03	0.915	0.94
	LTE 5	QPSK10M	Bottom	0	20600	50	0	1	4cell	w/	22.00	21.83	1.04	0.02	0.911	0.95
	LTE 5	QPSK10M	Bottom	0	20450	1	0	1	4cell	w/	22.00	21.83	1.04	0.03	1.01	<b>1.05</b>
	LTE 5	QPSK10M	Bottom	0	20525	1	0	1	4cell	w/	22.00	21.94	1.01	-0.04	0.924	0.93
	LTE 5	QPSK10M	Bottom	0	20450	25	0	1	4cell	w/	22.00	21.81	1.04	-0.07	0.987	1.03
	LTE 5	QPSK10M	Bottom	0	20525	25	0	1	4cell	w/	22.00	21.84	1.04	-0.01	0.889	0.92
	LTE 5	QPSK10M	Bottom	0	20450	1	0	2	4cell	w/	22.00	21.83	1.04	0.16	0.971	1.01
	LTE 5	QPSK10M	Bottom	0	20450	1	0	3	4cell	w/	22.00	21.83	1.04	0.13	0.992	1.03
	LTE 5	QPSK10M	Bottom	0	20450	1	0	4	4cell	w/	22.00	21.83	1.04	-0.11	0.982	1.02
	LTE 5	QPSK10M	Bottom	0	20525	1	0	2	4cell	w/	22.00	21.94	1.01	0.16	0.888	0.90
	LTE 5	QPSK10M	Bottom	0	20600	1	0	2	4cell	w/	22.00	21.96	1.01	0.14	0.899	0.91
	LTE 5	QPSK10M	Bottom	0	20525	1	0	3	4cell	w/	22.00	21.94	1.01	0.06	0.908	0.92
	LTE 5	QPSK10M	Bottom	0	20600	1	0	3	4cell	w/	22.00	21.96	1.01	0.15	0.918	0.93
	LTE 5	QPSK10M	Bottom	0	20525	1	0	4	4cell	w/	22.00	21.94	1.01	-0.07	0.899	0.91
LTE 5	QPSK10M	Bottom	0	20600	1	0	4	4cell	w/	22.00	21.96	1.01	-0.01	0.909	0.92	
LTE 5	QPSK10M	Bottom	0	20450	1	0	1	6cell	w/	22.00	21.83	1.04	-0.06	0.961	1.00	
LTE 5	QPSK10M	Bottom	0	20525	1	0	1	6cell	w/	22.00	21.94	1.01	-0.03	0.879	0.89	
LTE 5	QPSK10M	Bottom	0	20600	1	0	1	6cell	w/	22.00	21.96	1.01	-0.01	0.933	0.94	
LTE 5	QPSK10M	Bottom	0	20450	1	0	1	4cell	w/	22.00	21.83	1.04	0.03	0.995	1.03	





# SAR Test Report

Plot No.	Band	Mode	Test Position	Gap (mm)	Ch.	RB	offset	Sample	Battery	Reduction Power	Maximum Tune-up (dBm)	Conducted Power (dBm)	Scaling Factor	Power Drift	SAR 1g	Scaled 1g SAR
	LTE 7	QPSK20M	Bottom	0	21100	1	0	1	4cell	w/	17.00	16.92	1.02	-0.15	0.732	0.75
	LTE 7	QPSK20M	Bottom	0	21100	50	0	1	4cell	w/	17.00	16.81	1.04	0.18	0.697	0.72
	LTE 7	QPSK20M	Bottom	0	21100	100	0	1	4cell	w/	17.00	16.86	1.03	0.16	0.685	0.71
32	LTE 7	QPSK20M	Bottom	0	20850	1	0	1	4cell	w/	17.00	16.88	1.03	-0.02	0.926	0.95
	LTE 7	QPSK20M	Bottom	0	21350	1	0	1	4cell	w/	17.00	16.79	1.05	0.17	0.744	0.78
	LTE 7	QPSK20M	Bottom	0	20850	1	0	2	4cell	w/	17.00	16.88	1.03	-0.04	0.857	0.88
	LTE 7	QPSK20M	Bottom	0	20850	1	0	3	4cell	w/	17.00	16.88	1.03	0.08	0.849	0.87
	LTE 7	QPSK20M	Bottom	0	20850	1	0	4	4cell	w/	17.00	16.88	1.03	-0.11	0.853	0.88
	LTE 7	QPSK20M	Bottom	0	21100	1	0	2	4cell	w/	17.00	16.92	1.02	-0.03	0.608	0.62
	LTE 7	QPSK20M	Bottom	0	21350	1	0	2	4cell	w/	17.00	16.79	1.05	0.05	0.617	0.65
	LTE 7	QPSK20M	Bottom	0	21100	1	0	3	4cell	w/	17.00	16.92	1.02	0.06	0.699	0.71
	LTE 7	QPSK20M	Bottom	0	21350	1	0	3	4cell	w/	17.00	16.79	1.05	-0.11	0.711	0.75
	LTE 7	QPSK20M	Bottom	0	21100	1	0	4	4cell	w/	17.00	16.92	1.02	0.11	0.693	0.71
	LTE 7	QPSK20M	Bottom	0	21350	1	0	4	4cell	w/	17.00	16.79	1.05	-0.02	0.705	0.74
	LTE 7	QPSK20M	Bottom	0	20850	1	0	1	6cell	w/	17.00	16.88	1.03	-0.04	0.868	0.89
	LTE 7	QPSK20M	Bottom	0	21100	1	0	1	6cell	w/	17.00	16.92	1.02	-0.11	0.712	0.73
	LTE 7	QPSK20M	Bottom	0	21350	1	0	1	6cell	w/	17.00	16.79	1.05	-0.01	0.723	0.76
	LTE 7	QPSK20M	Bottom	0	PCC : 21001 SCC : 21199	PCC : 1 SCC : 1	PCC : 99 SCC : 0	1	4cell	w/	17.00	16.40	1.15	-0.01	0.605	0.70
	LTE 7	QPSK20M	Bottom	0	20850	1	0	1	4cell	w/	17.00	16.88	1.03	-0.02	0.921	0.95
	LTE 12	QPSK10M	Bottom	0	23130	1	0	1	4cell	w/	21.00	20.95	1.01	0.12	0.982	0.99
	LTE 12	QPSK10M	Bottom	0	23130	25	0	1	4cell	w/	21.00	20.84	1.04	0.18	0.961	1.00
	LTE 12	QPSK10M	Bottom	0	23130	50	0	1	4cell	w/	21.00	20.83	1.04	-0.06	0.97	1.01
	LTE 12	QPSK10M	Bottom	0	23060	1	0	1	4cell	w/	21.00	20.81	1.04	0.19	0.967	1.01
33	LTE 12	QPSK10M	Bottom	0	23095	1	0	1	4cell	w/	21.00	20.85	1.04	-0.14	1.01	1.05
	LTE 12	QPSK10M	Bottom	0	23060	25	0	1	4cell	w/	21.00	20.80	1.05	0.11	0.959	1.01
	LTE 12	QPSK10M	Bottom	0	23095	25	0	1	4cell	w/	21.00	20.77	1.05	-0.12	0.984	1.03
	LTE 12	QPSK10M	Bottom	0	23095	1	0	2	4cell	w/	21.00	20.85	1.04	0.11	0.987	1.03
	LTE 12	QPSK10M	Bottom	0	23095	1	0	3	4cell	w/	21.00	20.85	1.04	0.11	0.98	1.02
	LTE 12	QPSK10M	Bottom	0	23095	1	0	4	4cell	w/	21.00	20.85	1.04	0.13	0.984	1.02
	LTE 12	QPSK10M	Bottom	0	23060	1	0	2	4cell	w/	21.00	20.81	1.04	0.17	0.984	1.02
	LTE 12	QPSK10M	Bottom	0	23095	1	0	2	4cell	w/	21.00	20.85	1.04	-0.03	0.976	1.02
	LTE 12	QPSK10M	Bottom	0	23060	1	0	3	4cell	w/	21.00	20.81	1.04	0.17	0.97	1.01
	LTE 12	QPSK10M	Bottom	0	23095	1	0	3	4cell	w/	21.00	20.85	1.04	0.17	0.972	1.01
	LTE 12	QPSK10M	Bottom	0	23060	1	0	4	4cell	w/	21.00	20.81	1.04	0.1	0.978	1.02
	LTE 12	QPSK10M	Bottom	0	23095	1	0	4	4cell	w/	21.00	20.85	1.04	0.15	0.971	1.01
	LTE 12	QPSK10M	Bottom	0	23095	1	0	1	6cell	w/	21.00	20.85	1.04	-0.07	0.991	1.03
	LTE 12	QPSK10M	Bottom	0	23060	1	0	1	6cell	w/	21.00	20.81	1.04	-0.06	0.97	1.01
	LTE 12	QPSK10M	Bottom	0	23130	1	0	1	6cell	w/	21.00	20.95	1.01	-0.05	0.966	0.98
	LTE 12	QPSK10M	Bottom	0	23095	1	0	1	4cell	w/	21.00	20.85	1.04	0.11	0.986	1.03
34	LTE 13	QPSK10M	Bottom	0	23230	1	0	1	4cell	w/	22.00	21.95	1.01	-0.18	0.886	0.89
	LTE 13	QPSK10M	Bottom	0	23230	25	0	1	4cell	w/	22.00	21.89	1.03	-0.15	0.858	0.88
	LTE 13	QPSK10M	Bottom	0	23230	50	0	1	4cell	w/	22.00	21.84	1.04	0.07	0.83	0.86
	LTE 13	QPSK10M	Bottom	0	23230	1	0	2	4cell	w/	22.00	21.95	1.01	0.08	0.851	0.86
	LTE 13	QPSK10M	Bottom	0	23230	1	0	3	4cell	w/	22.00	21.95	1.01	0.05	0.873	0.88
	LTE 13	QPSK10M	Bottom	0	23230	1	0	4	4cell	w/	22.00	21.95	1.01	0.12	0.84	0.85
	LTE 13	QPSK10M	Bottom	0	23230	1	0	1	6cell	w/	22.00	21.95	1.01	0.09	0.821	0.83
	LTE 13	QPSK10M	Bottom	0	23230	1	0	1	4cell	w/	22.00	21.95	1.01	0.15	0.849	0.86
35	LTE 14	QPSK10M	Bottom	0	23330	1	0	1	4cell	w/	22.00	21.93	1.02	-0.05	0.95	0.97
	LTE 14	QPSK10M	Bottom	0	23330	25	0	1	4cell	w/	22.00	21.89	1.03	0.07	0.927	0.95
	LTE 14	QPSK10M	Bottom	0	23330	50	0	1	4cell	w/	22.00	21.83	1.04	-0.05	0.913	0.95
	LTE 14	QPSK10M	Bottom	0	23330	1	0	2	4cell	w/	22.00	21.93	1.02	-0.19	0.93	0.95
	LTE 14	QPSK10M	Bottom	0	23330	1	0	3	4cell	w/	22.00	21.93	1.02	-0.09	0.933	0.95
	LTE 14	QPSK10M	Bottom	0	23330	1	0	4	4cell	w/	22.00	21.93	1.02	-0.01	0.92	0.94
	LTE 14	QPSK10M	Bottom	0	23330	1	0	1	6cell	w/	22.00	21.93	1.02	-0.14	0.901	0.92
	LTE 14	QPSK10M	Bottom	0	23330	1	0	1	4cell	w/	22.00	21.93	1.02	0.11	0.935	0.95



# SAR Test Report

Plot No.	Band	Mode	Test Position	Gap (mm)	Ch.	RB	offset	Sample	Battery	Reduction Power	Maximum Tune-up (dBm)	Conducted Power (dBm)	Scaling Factor	Power Drift	SAR 1g	Scaled 1g SAR
	LTE 17	QPSK10M	Bottom	0	23780	1	0	1	4cell	w/	20.50	20.42	1.02	0.15	0.744	0.76
	LTE 17	QPSK10M	Bottom	0	23780	25	0	1	4cell	w/	20.50	20.37	1.03	-0.06	0.725	0.75
36	LTE 17	QPSK10M	Bottom	0	23790	1	0	1	4cell	w/	20.50	20.32	1.04	-0.02	0.761	0.79
	LTE 17	QPSK10M	Bottom	0	23800	1	0	1	4cell	w/	20.50	20.41	1.02	0.18	0.752	0.77
	LTE 17	QPSK10M	Bottom	0	23790	1	0	2	4cell	w/	20.50	20.32	1.04	-0.03	0.731	0.76
	LTE 17	QPSK10M	Bottom	0	23790	1	0	3	4cell	w/	20.50	20.32	1.04	0.01	0.701	0.73
	LTE 17	QPSK10M	Bottom	0	23790	1	0	4	4cell	w/	20.50	20.32	1.04	0.12	0.717	0.75
	LTE 17	QPSK10M	Bottom	0	23790	1	0	1	6cell	w/	20.50	20.32	1.04	-0.13	0.748	0.78
	LTE 25	QPSK20M	Bottom	0	26140	1	0	1	4cell	w/	17.50	17.47	1.01	-0.15	0.679	0.69
	LTE 25	QPSK20M	Bottom	0	26140	50	0	1	4cell	w/	17.50	17.32	1.04	0.02	0.652	0.68
	LTE 25	QPSK20M	Bottom	0	26365	1	0	1	4cell	w/	17.50	17.29	1.05	-0.06	0.725	0.76
37	LTE 25	QPSK20M	Bottom	0	26590	1	0	1	4cell	w/	17.50	17.38	1.03	-0.06	0.771	0.79
	LTE 25	QPSK20M	Bottom	0	26590	1	0	2	4cell	w/	17.50	17.38	1.03	-0.1	0.746	0.77
	LTE 25	QPSK20M	Bottom	0	26590	1	0	3	4cell	w/	17.50	17.38	1.03	-0.07	0.758	0.78
	LTE 25	QPSK20M	Bottom	0	26590	1	0	4	4cell	w/	17.50	17.38	1.03	0.17	0.751	0.77
	LTE 25	QPSK20M	Bottom	0	26590	1	0	1	6cell	w/	17.50	17.38	1.03	-0.03	0.758	0.78
	LTE 26	QPSK15M	Bottom	0	26965	1	0	1	4cell	w/	21.50	21.46	1.01	-0.17	0.775	0.78
	LTE 26	QPSK15M	Bottom	0	26965	36	0	1	4cell	w/	21.50	21.37	1.03	0.05	0.752	0.77
38	LTE 26	QPSK15M	Bottom	0	26765	1	0	1	4cell	w/	21.50	21.34	1.04	-0.02	0.843	0.88
	LTE 26	QPSK15M	Bottom	0	26865	1	0	1	4cell	w/	21.50	21.38	1.03	-0.03	0.785	0.81
	LTE 26	QPSK15M	Bottom	0	26765	1	0	2	4cell	w/	21.50	21.34	1.04	-0.07	0.764	0.79
	LTE 26	QPSK15M	Bottom	0	26765	1	0	3	4cell	w/	21.50	21.34	1.04	-0.14	0.74	0.77
	LTE 26	QPSK15M	Bottom	0	26765	1	0	4	4cell	w/	21.50	21.34	1.04	0.11	0.759	0.79
	LTE 26	QPSK15M	Bottom	0	26765	1	0	1	6cell	w/	21.50	21.34	1.04	-0.04	0.763	0.79
	LTE 26	QPSK15M	Bottom	0	26765	1	0	1	4cell	w/	21.50	21.34	1.04	-0.02	0.838	0.87
39	LTE 30	QPSK10M	Bottom	0	27710	1	0	1	4cell	w/	17.50	17.39	1.03	-0.03	0.914	0.94
	LTE 30	QPSK10M	Bottom	0	27710	25	0	1	4cell	w/	17.50	17.33	1.04	0.01	0.878	0.91
	LTE 30	QPSK10M	Bottom	0	27710	50	0	1	4cell	w/	17.50	17.30	1.05	0.05	0.851	0.89
	LTE 30	QPSK10M	Bottom	0	27710	1	0	2	4cell	w/	17.50	17.39	1.03	-0.13	0.891	0.92
	LTE 30	QPSK10M	Bottom	0	27710	1	0	3	4cell	w/	17.50	17.39	1.03	0.15	0.887	0.91
	LTE 30	QPSK10M	Bottom	0	27710	1	0	4	4cell	w/	17.50	17.39	1.03	-0.11	0.885	0.91
	LTE 30	QPSK10M	Bottom	0	27710	1	0	1	6cell	w/	17.50	17.39	1.03	0.16	0.895	0.92
	LTE 30	QPSK10M	Bottom	0	27710	1	0	1	4cell	w/	17.50	17.39	1.03	0.07	0.892	0.92
	LTE 38	QPSK20M	Bottom	0	37850	1	0	1	4cell	w/	20.00	19.87	1.03	0.14	0.832	0.86
	LTE 38	QPSK20M	Bottom	0	37850	50	0	1	4cell	w/	20.00	19.83	1.04	0.04	0.821	0.85
	LTE 38	QPSK20M	Bottom	0	37850	100	0	1	4cell	w/	20.00	19.84	1.04	-0.04	0.823	0.86
40	LTE 38	QPSK20M	Bottom	0	38000	1	0	1	4cell	w/	20.00	19.72	1.07	-0.08	0.897	0.96
	LTE 38	QPSK20M	Bottom	0	38150	1	0	1	4cell	w/	20.00	19.74	1.06	-0.14	0.817	0.87
	LTE 38	QPSK20M	Bottom	0	38000	50	0	1	4cell	w/	20.00	19.75	1.06	0.04	0.877	0.93
	LTE 38	QPSK20M	Bottom	0	38150	50	0	1	4cell	w/	20.00	19.74	1.06	-0.01	0.797	0.84
	LTE 38	QPSK20M	Bottom	0	38000	1	0	2	4cell	w/	20.00	19.72	1.07	0.04	0.857	0.92
	LTE 38	QPSK20M	Bottom	0	38000	1	0	3	4cell	w/	20.00	19.72	1.07	0.19	0.867	0.93
	LTE 38	QPSK20M	Bottom	0	38000	1	0	4	4cell	w/	20.00	19.72	1.07	0.12	0.846	0.91
	LTE 38	QPSK20M	Bottom	0	37850	1	0	2	4cell	w/	20.00	19.87	1.03	-0.16	0.796	0.82
	LTE 38	QPSK20M	Bottom	0	38150	1	0	2	4cell	w/	20.00	19.74	1.06	-0.18	0.781	0.83
	LTE 38	QPSK20M	Bottom	0	37850	1	0	3	4cell	w/	20.00	19.87	1.03	0.05	0.805	0.83
	LTE 38	QPSK20M	Bottom	0	38150	1	0	3	4cell	w/	20.00	19.74	1.06	-0.18	0.79	0.84
	LTE 38	QPSK20M	Bottom	0	37850	1	0	4	4cell	w/	20.00	19.87	1.03	0.14	0.786	0.81
	LTE 38	QPSK20M	Bottom	0	38150	1	0	4	4cell	w/	20.00	19.74	1.06	-0.14	0.771	0.82
	LTE 38	QPSK20M	Bottom	0	38000	1	0	1	6cell	w/	20.00	19.72	1.07	-0.06	0.851	0.91
	LTE 38	QPSK20M	Bottom	0	37850	1	0	1	6cell	w/	20.00	19.87	1.03	-0.05	0.789	0.81
	LTE 38	QPSK20M	Bottom	0	38150	1	0	1	6cell	w/	20.00	19.74	1.06	0.03	0.775	0.82
	LTE 38	QPSK20M	Bottom	0	38000	1	0	1	4cell	w/	20.00	19.72	1.07	-0.08	0.891	0.95



# SAR Test Report

Plot No.	Band	Mode	Test Position	Gap (mm)	Ch.	RB	offset	Sample	Battery	Reduction Power	Maximum Tune-up (dBm)	Conducted Power (dBm)	Scaling Factor	Power Drift	SAR 1g	Scaled 1g SAR
42	LTE 41	QPSK20M	Bottom	0	40620	1	0	1	4cell	w/	19.50	19.44	1.01	-0.04	0.776	<b>0.78</b>
	LTE 41	QPSK20M	Bottom	0	40620	50	0	1	4cell	w/	19.50	19.37	1.03	-0.1	0.519	0.53
	LTE 41	QPSK20M	Bottom	0	39750	1	0	1	4cell	w/	19.50	19.37	1.03	0.1	0.729	0.75
	LTE 41	QPSK20M	Bottom	0	40185	1	0	1	4cell	w/	19.50	19.30	1.05	0.13	0.577	0.61
	LTE 41	QPSK20M	Bottom	0	41055	1	0	1	4cell	w/	19.50	19.40	1.02	-0.02	0.488	0.50
	LTE 41	QPSK20M	Bottom	0	41490	1	0	1	4cell	w/	19.50	19.31	1.04	0.03	0.431	0.45
	LTE 41	QPSK20M	Bottom	0	40620	1	0	2	4cell	w/	19.50	19.44	1.01	-0.19	0.657	0.66
	LTE 41	QPSK20M	Bottom	0	40620	1	0	3	4cell	w/	19.50	19.44	1.01	0.18	0.615	0.62
	LTE 41	QPSK20M	Bottom	0	40620	1	0	4	4cell	w/	19.50	19.44	1.01	0.07	0.641	0.65
	LTE 41	QPSK20M	Bottom	0	40620	1	0	1	6cell	w/	19.50	19.44	1.01	-0.02	0.745	0.75
	LTE 66	QPSK20M	Bottom	0	132322	1	0	1	4cell	w/	19.00	18.98	1.00	0.07	0.747	0.75
	LTE 66	QPSK20M	Bottom	0	132322	50	0	1	4cell	w/	19.00	18.89	1.03	-0.19	0.733	0.75
	LTE 66	QPSK20M	Bottom	0	132322	100	0	1	4cell	w/	19.00	18.95	1.01	0.07	0.687	0.69
	LTE 66	QPSK20M	Bottom	0	132072	1	0	1	4cell	w/	19.00	18.78	1.05	0.09	0.699	0.73
45	LTE 66	QPSK20M	Bottom	0	132572	1	0	1	4cell	w/	19.00	18.81	1.04	-0.11	0.771	<b>0.80</b>
	LTE 66	QPSK20M	Bottom	0	132572	1	0	2	4cell	w/	19.00	18.81	1.04	0.12	0.749	0.78
	LTE 66	QPSK20M	Bottom	0	132572	1	0	3	4cell	w/	19.00	18.81	1.04	-0.13	0.754	0.78
	LTE 66	QPSK20M	Bottom	0	132572	1	0	4	4cell	w/	19.00	18.81	1.04	-0.08	0.752	0.78
	LTE 66	QPSK20M	Bottom	0	132572	1	0	1	6cell	w/	19.00	18.81	1.04	-0.19	0.762	0.79



# SAR Test Report

Plot No.	Band	Mode	Test Position	Gap (mm)	Ch.	Sample	Ant Status	Battery	Duty Cycle	Crest Factor	Maximum Tune-up (dBm)	Conducted Power (dBm)	Scaling Factor	Power Drift	SAR 1g	Scaled 1g SAR
	WLAN2.4G	802.11b	Bottom	0	1	1	Ant 0	4cell	100.00	1.00	16.00	15.99	1.00	-0.01	0.789	0.79
	WLAN2.4G	802.11b	Bottom	0	1	1	Ant 1	4cell	100.00	1.00	16.00	15.97	1.01	-0.02	0.733	0.74
	WLAN2.4G	802.11n HT40	Bottom	0	3	1	Ant 0+1	4cell	99.00	1.01	19.00	18.93	1.02	-0.09	0.923	0.95
46	WLAN2.4G	802.11n HT40	Bottom	0	6	1	Ant 0+1	4cell	99.00	1.01	19.00	18.86	1.03	-0.02	1.01	1.05
	WLAN2.4G	802.11n HT40	Bottom	0	9	1	Ant 0+1	4cell	99.00	1.01	19.00	18.89	1.03	0.12	0.819	0.85
	WLAN2.4G	802.11n HT40	Bottom	0	10	1	Ant 0+1	4cell	99.00	1.01	19.00	18.88	1.03	-0.1	0.802	0.83
	WLAN2.4G	802.11n HT40	Bottom	0	11	1	Ant 0+1	4cell	99.00	1.01	19.00	18.87	1.03	0.17	0.863	0.90
	WLAN2.4G	802.11n HT40	Bottom	0	6	2	Ant 0+1	4cell	99.00	1.01	19.00	18.86	1.03	-0.17	0.753	0.78
	WLAN2.4G	802.11n HT40	Bottom	0	6	3	Ant 0+1	4cell	99.00	1.01	19.00	18.86	1.03	-0.04	0.835	0.87
	WLAN2.4G	802.11n HT40	Bottom	0	6	4	Ant 0+1	4cell	99.00	1.01	19.00	18.86	1.03	0.04	0.815	0.85
	WLAN2.4G	802.11n HT40	Bottom	0	3	3	Ant 0+1	4cell	99.00	1.01	19.00	18.93	1.02	-0.09	0.878	0.90
	WLAN2.4G	802.11n HT40	Bottom	0	9	3	Ant 0+1	4cell	99.00	1.01	19.00	18.89	1.03	0.12	0.849	0.88
	WLAN2.4G	802.11n HT40	Bottom	0	10	3	Ant 0+1	4cell	99.00	1.01	19.00	18.88	1.03	-0.1	0.887	0.92
	WLAN2.4G	802.11n HT40	Bottom	0	11	3	Ant 0+1	4cell	99.00	1.01	19.00	18.87	1.03	0.17	0.863	0.90
	WLAN2.4G	802.11n HT40	Bottom	0	3	4	Ant 0+1	4cell	99.00	1.01	19.00	18.93	1.02	-0.09	0.759	0.78
	WLAN2.4G	802.11n HT40	Bottom	0	9	4	Ant 0+1	4cell	99.00	1.01	19.00	18.89	1.03	0.12	0.742	0.77
	WLAN2.4G	802.11n HT40	Bottom	0	10	4	Ant 0+1	4cell	99.00	1.01	19.00	18.88	1.03	-0.1	0.824	0.86
	WLAN2.4G	802.11n HT40	Bottom	0	11	4	Ant 0+1	4cell	99.00	1.01	19.00	18.87	1.03	0.17	0.762	0.79
	WLAN2.4G	802.11n HT40	Bottom	0	6	1	Ant 0+1	6cell	99.00	1.01	19.00	18.86	1.03	-0.02	0.929	0.97
	WLAN2.4G	802.11n HT40	Bottom	0	3	1	Ant 0+1	6cell	99.00	1.01	19.00	18.93	1.02	-0.09	0.823	0.85
	WLAN2.4G	802.11n HT40	Bottom	0	9	1	Ant 0+1	6cell	99.00	1.01	19.00	18.89	1.03	0.12	0.719	0.75
	WLAN2.4G	802.11n HT40	Bottom	0	10	1	Ant 0+1	6cell	99.00	1.01	19.00	18.88	1.03	-0.1	0.702	0.73
	WLAN2.4G	802.11n HT40	Bottom	0	11	1	Ant 0+1	6cell	99.00	1.01	19.00	18.87	1.03	0.17	0.784	0.82
	WLAN2.4G	802.11n HT40	Bottom	0	6	1	Ant 0+1	4cell	99.00	1.01	19.00	18.86	1.03	0.15	0.981	1.02
	WLAN5.3G	802.11ac VHT160	Bottom	0	50	1	Ant 0	4cell	99.00	1.01	13.00	12.90	1.02	0.18	0.722	0.74
47	WLAN5.3G	802.11ac VHT160	Bottom	0	50	1	Ant 1	4cell	97.00	1.03	15.50	15.45	1.01	-0.16	1.06	1.10
	WLAN5.3G	802.11ac VHT160	Bottom	0	50	1	Ant 0+1	4cell	97.00	1.03	16.00	15.93	1.02	0.06	0.491	0.52
	WLAN5.3G	802.11ac VHT160	Bottom	0	50	2	Ant 1	4cell	97.00	1.03	15.50	15.45	1.01	0.04	0.731	0.76
	WLAN5.3G	802.11ac VHT160	Bottom	0	50	3	Ant 1	4cell	97.00	1.03	15.50	15.45	1.01	0.09	0.964	1.00
	WLAN5.3G	802.11ac VHT160	Bottom	0	50	4	Ant 1	4cell	97.00	1.03	15.50	15.45	1.01	0.15	0.886	0.92
	WLAN5.3G	802.11ac VHT160	Bottom	0	50	1	Ant 1	6cell	97.00	1.03	15.50	15.45	1.01	0.11	0.843	0.88
	WLAN5.3G	802.11ac VHT160	Bottom	0	50	1	Ant 1	4cell	97.00	1.03	15.50	15.45	1.01	-0.16	1.01	1.05
	WLAN5.6G	802.11ac VHT160	Bottom	0	114	1	Ant 0	4cell	97.00	1.03	13.00	12.90	1.02	0.05	0.447	0.47
48	WLAN5.6G	802.11ac VHT160	Bottom	0	114	1	Ant 1	4cell	97.00	1.03	14.50	14.41	1.02	-0.09	0.686	0.72
	WLAN5.6G	802.11ac VHT160	Bottom	0	114	1	Ant 0+1	4cell	97.00	1.03	16.00	15.89	1.03	0.11	0.464	0.49
	WLAN5.6G	802.11ac VHT160	Bottom	0	114	2	Ant 1	4cell	97.00	1.03	14.50	14.41	1.02	0.05	0.516	0.54
	WLAN5.6G	802.11ac VHT160	Bottom	0	114	3	Ant 1	4cell	97.00	1.03	14.50	14.41	1.02	0.09	0.552	0.58
	WLAN5.6G	802.11ac VHT160	Bottom	0	114	4	Ant 1	4cell	97.00	1.03	14.50	14.41	1.02	-0.12	0.622	0.65
	WLAN5.6G	802.11ac VHT160	Bottom	0	114	1	Ant 1	6cell	97.00	1.03	14.50	14.41	1.02	0.13	0.652	0.68

Plot No.	Band	Mode	Test Position	Gap (mm)	Ch.	Sample	Ant Status	Battery	Duty Cycle	Crest Factor	Maximum Tune-up (dBm)	Conducted Power (dBm)	Scaling Factor	Power Drift	SAR 1g	Scaled 1g SAR
	WLAN5.8G	802.11ac VHT80	Bottom	0	155	1	Ant 0	4cell	97.60	1.02	12.00	11.96	1.01	-0.02	0.464	0.48
49	WLAN5.8G	802.11ac VHT80	Bottom	0	155	1	Ant 1	4cell	97.00	1.03	14.50	14.43	1.02	-0.18	0.87	0.91
	WLAN5.8G	802.11ac VHT80	Bottom	0	155	1	Ant 0+1	4cell	97.00	1.03	15.00	14.87	1.03	0.07	0.475	0.50
	WLAN5.8G	802.11ac VHT80	Bottom	0	155	2	Ant 1	4cell	97.00	1.03	14.50	14.43	1.02	0.09	0.582	0.61
	WLAN5.8G	802.11ac VHT80	Bottom	0	155	3	Ant 1	4cell	97.00	1.03	14.50	14.43	1.02	0.15	0.745	0.78
	WLAN5.8G	802.11ac VHT80	Bottom	0	155	4	Ant 1	4cell	97.00	1.03	14.50	14.43	1.02	0.04	0.749	0.79
	WLAN5.8G	802.11ac VHT80	Bottom	0	155	1	Ant 1	6cell	97.00	1.03	14.50	14.43	1.02	0.05	0.832	0.87
	WLAN5.8G	802.11ac VHT80	Bottom	0	155	1	Ant 1	4cell	97.00	1.03	14.50	14.43	1.02	-0.18	0.82	0.86
50	BT	BDR	Bottom	0	0	1	Ant 1	4cell	76.80	1.30	10.50	9.81	1.17	-0.14	0.153	0.23
	BT	BDR	Bottom	0	39	1	Ant 1	4cell	76.80	1.30	10.50	9.52	1.25	-0.06	0.099	0.16
	BT	BDR	Bottom	0	78	1	Ant 1	4cell	76.80	1.30	10.50	9.72	1.20	0.17	0.058	0.09
	BT	BDR	Bottom	0	0	2	Ant 1	4cell	76.80	1.30	10.50	9.81	1.17	-0.15	0.095	0.14
	BT	BDR	Bottom	0	0	3	Ant 1	4cell	76.80	1.30	10.50	9.81	1.17	0.13	0.108	0.16
	BT	BDR	Bottom	0	0	4	Ant 1	4cell	76.80	1.30	10.50	9.81	1.17	0.12	0.112	0.17
	BT	BDR	Bottom	0	0	1	Ant 1	6cell	76.80	1.30	10.50	9.81	1.17	0.05	0.106	0.16

### 4.7.3 SAR Measurement Variability

According to KDB 865664 D01, SAR measurement variability was assessed for each frequency band, which is determined by the SAR probe calibration point and tissue-equivalent medium used for the device measurements. When both head and body tissue-equivalent media are required for SAR measurements in a frequency band, the variability measurement procedures should be applied to the tissue medium with the highest measured SAR, using the highest measured SAR configuration for that tissue-equivalent medium. Alternatively, if the highest measured SAR for both head and body tissue-equivalent media are  $\leq 1.45$  W/kg and the ratio of these highest SAR values, i.e., largest divided by smallest value, is  $\leq 1.10$ , the highest SAR configuration for either head or body tissue-equivalent medium may be used to perform the repeated measurement. These additional measurements are repeated after the completion of all measurements requiring the same head or body tissue-equivalent medium in a frequency band. The test device should be returned to ambient conditions (normal room temperature) with the battery fully charged before it is re-mounted on the device holder for the repeated measurement(s) to minimize any unexpected variations in the repeated results.

SAR repeated measurement procedure:

1. When the highest measured SAR is  $< 0.80$  W/kg, repeated measurement is not required.
2. When the highest measured SAR is  $\geq 0.80$  W/kg, repeat that measurement once.
3. If the ratio of largest to smallest SAR for the original and first repeated measurements is  $> 1.20$ , or when the original or repeated measurement is  $\geq 1.45$  W/kg, perform a second repeated measurement.
4. If the ratio of largest to smallest SAR for the original, first and second repeated measurements is  $> 1.20$ , and the original, first or second repeated measurement is  $\geq 1.5$  W/kg, perform a third repeated measurement.

# SAR Test Report

## Tablet Mode

Band	Mode	Test Position	Ch.	Original Measured SAR-1g (W/kg)	1st Repeated SAR-1g (W/kg)	L/S Ratio	2nd Repeated SAR-1g (W/kg)	L/S Ratio	3rd Repeated SAR-1g (W/kg)	L/S Ratio
LTE 7	QPSK20M	Rear Face	20850	1.02	0.993	1.03	N/A	N/A	N/A	N/A
LTE 13	QPSK10M	Rear Face	23230	0.841	0.822	1.02	N/A	N/A	N/A	N/A
LTE 14	QPSK10M	Rear Face	23330	0.938	0.915	1.03	N/A	N/A	N/A	N/A
LTE 17	QPSK10M	Rear Face	23780	0.932	0.923	1.01	N/A	N/A	N/A	N/A
LTE 25	QPSK20M	Rear Face	26590	1.03	0.993	1.04	N/A	N/A	N/A	N/A
LTE 26	QPSK15M	Rear Face	26765	0.936	0.925	1.01	N/A	N/A	N/A	N/A
LTE 30	QPSK10M	Rear Face	27710	1.01	0.998	1.01	N/A	N/A	N/A	N/A
LTE 38	QPSK20M	Rear Face	37850	1.04	1.02	1.02	N/A	N/A	N/A	N/A
LTE 41	QPSK20M	Rear Face	40185	1.09	1.06	1.03	N/A	N/A	N/A	N/A
LTE 66	QPSK20M	Rear Face	132572	0.846	0.839	1.01	N/A	N/A	N/A	N/A
WLAN 5.2G	802.11ac VHT80	Top Side	42	1.06	1.03	1.03	N/A	N/A	N/A	N/A

## Laptop PC Mode

Band	Mode	Test Position	Ch.	Original Measured SAR-1g (W/kg)	1st Repeated SAR-1g (W/kg)	L/S Ratio	2nd Repeated SAR-1g (W/kg)	L/S Ratio	3rd Repeated SAR-1g (W/kg)	L/S Ratio
WCDMA II	RMC12.2K	Bottom	9538	0.881	0.876	1.01	N/A	N/A	N/A	N/A
WCDMA IV	RMC12.2K	Bottom	1513	0.97	0.92	1.05	N/A	N/A	N/A	N/A
WCDMA V	RMC12.2K	Bottom	4233	1.04	0.99	1.05	N/A	N/A	N/A	N/A
LTE 2	QPSK20M	Bottom	19100	0.838	0.832	1.01	N/A	N/A	N/A	N/A
LTE 4	QPSK20M	Bottom	20175	0.964	0.958	1.01	N/A	N/A	N/A	N/A
LTE 5	QPSK10M	Bottom	20450	1.01	0.995	1.02	N/A	N/A	N/A	N/A
LTE 7	QPSK20M	Bottom	20850	0.926	0.921	1.01	N/A	N/A	N/A	N/A
LTE 12	QPSK10M	Bottom	23095	1.01	0.986	1.02	N/A	N/A	N/A	N/A
LTE 13	QPSK10M	Bottom	23230	0.886	0.849	1.04	N/A	N/A	N/A	N/A
LTE 14	QPSK10M	Bottom	23330	0.95	0.935	1.02	N/A	N/A	N/A	N/A
LTE 26	QPSK15M	Bottom	26765	0.843	0.838	1.01	N/A	N/A	N/A	N/A
LTE 30	QPSK10M	Bottom	27710	0.914	0.892	1.02	N/A	N/A	N/A	N/A
LTE 38	QPSK20M	Bottom	38000	0.897	0.891	1.01	N/A	N/A	N/A	N/A
WLAN2.4G	802.11n HT40	Bottom	6	1.01	0.981	1.03	N/A	N/A	N/A	N/A
WLAN5.3G	802.11ac VHT160	Bottom	50	1.06	1.01	1.05	N/A	N/A	N/A	N/A
WLAN5.6G	802.11ac VHT80	Bottom	106	1.01	0.971	1.04	N/A	N/A	N/A	N/A
WLAN5.8G	802.11ac VHT80	Bottom	155	0.87	0.82	1.06	N/A	N/A	N/A	N/A

## 4.7.4 Simultaneous Multi-band Transmission Evaluation

### <Possibilities of Simultaneous Transmission>

The simultaneous transmission possibilities for this device are listed as below.

Simultaneous TX Combination	Capable Transmit Configurations	Body Exposure Condition
1	WWAN + WLAN2.4G_Ant0	Yes
2	WWAN + WLAN2.4G_Ant1	Yes
3	WWAN + WLAN5G_Ant0	Yes
4	WWAN + WLAN5G_Ant1	Yes
5	WWAN + BT_Ant1	Yes
6	WWAN + WLAN2.4G MIMO	Yes
7	WWAN + WLAN5G MIMO	Yes
8	WWAN + WLAN2.4G_Ant0 + BT_Ant1	Yes
9	WWAN + WLAN5G_Ant0 + BT_Ant1	Yes
10	WWAN + WLAN5G MIMO + BT_Ant1	Yes

#### Note :

- 1.The WLAN 2.4G and WLAN 5G cannot transmit simultaneously.
- 2.Combination 1 is covered by combination 8.
- 3.Combination 3 is covered by combination 9.
- 4.Combination 5 is covered by combination 10.
- 5.Combination 7 is covered by combination 10.

### <SAR Summation Analysis>

Simultaneous transmission SAR test exclusion is determined for each operating configuration and exposure condition according to the reported standalone SAR of each applicable simultaneous transmitting antenna. When the sum of SAR<sub>1g</sub> of all simultaneously transmitting antennas in an operating mode and exposure condition combination is within the SAR limit (SAR<sub>1g</sub> 1.6 W/kg), the simultaneous transmission SAR is not required. When the sum of SAR<sub>1g</sub> is greater than the SAR limit (SAR<sub>1g</sub> 1.6 W/kg), SAR test exclusion is determined by the SPLSR.

Refer to Appendix G

### <SAR to Peak Location Separation Ratio Analysis>

The simultaneous transmitting antennas in each operating mode and exposure condition combination are considered one pair at a time to determine the SPLSR. When SAR is measured for both antennas in the pair, the peak location separation distance is computed by the following formula.

$$\text{Peak Location Separation Distance} = \sqrt{(x_1 - x_2)^2 + (y_1 - y_2)^2 + (z_1 - z_2)^2}$$

Where (x<sub>1</sub>, y<sub>1</sub>, z<sub>1</sub>) and (x<sub>2</sub>, y<sub>2</sub>, z<sub>2</sub>) are the coordinates of the extrapolated peak SAR locations in the area or zoom scans.

When standalone test exclusion applies, SAR is estimated; the peak location is assumed to be at the feed-point or geometric center of the antenna. Due to curvatures on the SAM phantom, when SAR is estimated for one of the antennas in an antenna pair, the measured peak SAR location will be translated onto the test device to determine the peak location separation for the antenna pair.

The SPLSR is determined by the following formula.

$$\text{SPLSR} = \frac{(\text{SAR}_1 + \text{SAR}_2)^{1.5}}{R_i}$$

Where SAR<sub>1</sub> and SAR<sub>2</sub> are the highest reported or estimated SAR for each antenna in the pair, and R<sub>i</sub> is the separation distance between the peak SAR locations for the antenna pair in mm.

When the SPLSR is <= 0.04, the simultaneous transmission SAR is not required. Otherwise, the enlarged zoom scan and volume scan post-processing procedures will be performed.

Refer to Appendix H

**Test Engineer** : Tim Cheng, and Matt Cheng



## 5. Calibration of Test Equipment

Equipment	Manufacturer	Model	SN	Cal. Date	Cal. Interval
System Validation Dipole	SPEAG	D750V3	1013	Aug. 13, 2020	1 Year
System Validation Dipole	SPEAG	D835V2	4d121	Aug. 13, 2020	1 Year
System Validation Dipole	SPEAG	D1750V2	1055	Aug. 14, 2020	1 Year
System Validation Dipole	SPEAG	D1900V2	5d036	Jan. 21, 2020	1 Year
System Validation Dipole	SPEAG	D2300V2	1004	Jan. 21, 2020	1 Year
System Validation Dipole	SPEAG	D2450V2	737	Aug. 13, 2020	1 Year
System Validation Dipole	SPEAG	D2600V2	1020	Aug. 13, 2020	1 Year
System Validation Dipole	SPEAG	D5GHzV2	1019	Mar. 13, 2020	1 Year
Dosimetric E-Field Probe	SPEAG	EX3DV4	3650	Mar. 25, 2020	1 Year
Dosimetric E-Field Probe	SPEAG	EX3DV4	3971	Jan. 27, 2020	1 Year
Dosimetric E-Field Probe	SPEAG	EX3DV4	7555	Sep. 28, 2020	1 Year
Data Acquisition Electronics	SPEAG	DAE4	861	May. 27, 2020	1 Year
Data Acquisition Electronics	SPEAG	DAE4	917	Dec. 17, 2019	1 Year
Data Acquisition Electronics	SPEAG	DAE4	1589	Sep. 15, 2020	1 Year
Universal Radio Communication Tester	Anritsu	MT8821C	6201381727	Jun. 11, 2020	1 Year
Spectrum Analyzer	R&S	FSL6	102006	Mar. 26, 2020	1 Year
Thermometer	YFE	YF-160A	150601220	May. 25, 2020	1 Year
Dielectric Assessment Kit	SPEAG	DAKS-3.5	1092	May. 26, 2020	1 Year
Powersource1	SPEAG	SE_UMS_160 BA	4010	Aug. 13, 2020	1 Year

## **6. Measurement Uncertainty**

According to KDB 865664 D01, SAR measurement uncertainty analysis is required in SAR reports only when the highest measured SAR in a frequency band is  $\geq 1.5$  W/kg for 1-g SAR, and  $\geq 3.75$  W/kg for 10-g SAR. The procedures described in IEEE Std 1528-2013 should be applied. The expanded SAR measurement uncertainty must be  $\leq 30\%$ , for a confidence interval of  $k = 2$ . When the highest measured SAR within a frequency band is  $< 1.5$  W/kg for 1-g and  $< 3.75$  W/kg for 10-g, the extensive SAR measurement uncertainty analysis described in IEEE Std 1528-2013 is not required in SAR reports submitted for equipment approval. Hence, the measurement uncertainty analysis is not required in this SAR report because the test result met the condition.

### 7. Information of the Testing Laboratories

We, Bureau Veritas Consumer Products Services (H.K.) Ltd., Taoyuan Branch, were founded in 1988 to provide our best service in EMC, Radio, Telecom and Safety consultation. Our laboratories are accredited and approved according to ISO/IEC 17025.

If you have any comments, please feel free to contact us at the following:

**Taiwan Huaya Lab:**

Add: No. 19, Huaya 2nd Rd., Guishan Dist., Taoyuan City 333, Taiwan

Tel: +886-(0)3-318-3232

Fax: +886-(0)3-211-5834

**Taiwan Linkou Lab:**

Add: No. 47-2, Baodoucuokeng, Linkou Dist., New Taipei City 244, Taiwan

Tel: +886-(0)2-2605-2180

Fax: +886-(0)2-2605-2943

**Taiwan Hsinchu Lab1:**

Add: E-2, No. 1, Lixing 1st Rd., East Dist., Hsinchu City 300, Taiwan

Tel: +886-(0)3-666-8565

Fax: +886-(0)3-666-8323

**Taiwan Hsinchu Lab2:**

Add: No. 49, Ln. 206, Wende Rd., Qionglin Township, Hsinchu County 307, Taiwan

Tel: +886-(0)3-512-0595

Fax: +886-(0)3-512-0568

**Taiwan Xindian Lab:**

Add: B2F., No. 215, Sec. 3, Beixin Rd., Xindian Dist., New Taipei City 231, Taiwan

Tel: +886-(0)2-8914-5882

Fax: +886-(0)2-8914-5840

**Email:** [service.adt@tw.bureauveritas.com](mailto:service.adt@tw.bureauveritas.com)

**Web Site:** <https://ee.bureauveritas.com.tw/BVInternet/Default>

The road map of all our labs can be found in our web site also.

---END---

## **Appendix A. SAR Plots of System Verification**

The plots for system verification with largest deviation for each SAR system combination are shown as follows.

## System Check\_H750\_201127

**DUT: Dipole 750 MHz; Type: D750V3; SN: 1013**

Communication System: UID 0, CW; Frequency: 750 MHz; Duty Cycle: 1:1

Medium: H06T09N1\_1127 Medium parameters used:  $f = 750$  MHz;  $\sigma = 0.9$  S/m;  $\epsilon_r = 42.167$ ;  $\rho = 1000$  kg/m<sup>3</sup>

Ambient Temperature : 23.1 °C ; Liquid Temperature : 23 °C

DASY5 Configuration:

- Probe: EX3DV4 - SN3971; ConvF(10.6, 10.6, 10.6) @ 750 MHz; Calibrated: 2020/01/27
- Sensor-Surface: 1.4mm (Mechanical Surface Detection)
- Electronics: DAE4 Sn917; Calibrated: 2019/12/17
- Phantom: ELI Phantom\_1206; Type: QDOVA002AA;
- Measurement SW: DASY52, Version 52.10 (4); SEMCAD X Version 14.6.14 (7483)

**Pin=50mW/Area Scan (61x81x1):** Interpolated grid: dx=1.500 mm, dy=1.500 mm

Maximum value of SAR (interpolated) = 0.513 W/kg

**Pin=50mW/Zoom Scan (5x5x7)/Cube 0:** Measurement grid: dx=8mm, dy=8mm, dz=5mm

Reference Value = 25.23 V/m; Power Drift = -0.03 dB

Peak SAR (extrapolated) = 0.556 W/kg

**SAR(1 g) = 0.384 W/kg; SAR(10 g) = 0.256 W/kg** (SAR corrected for target medium)

Maximum value of SAR (measured) = 0.503 W/kg

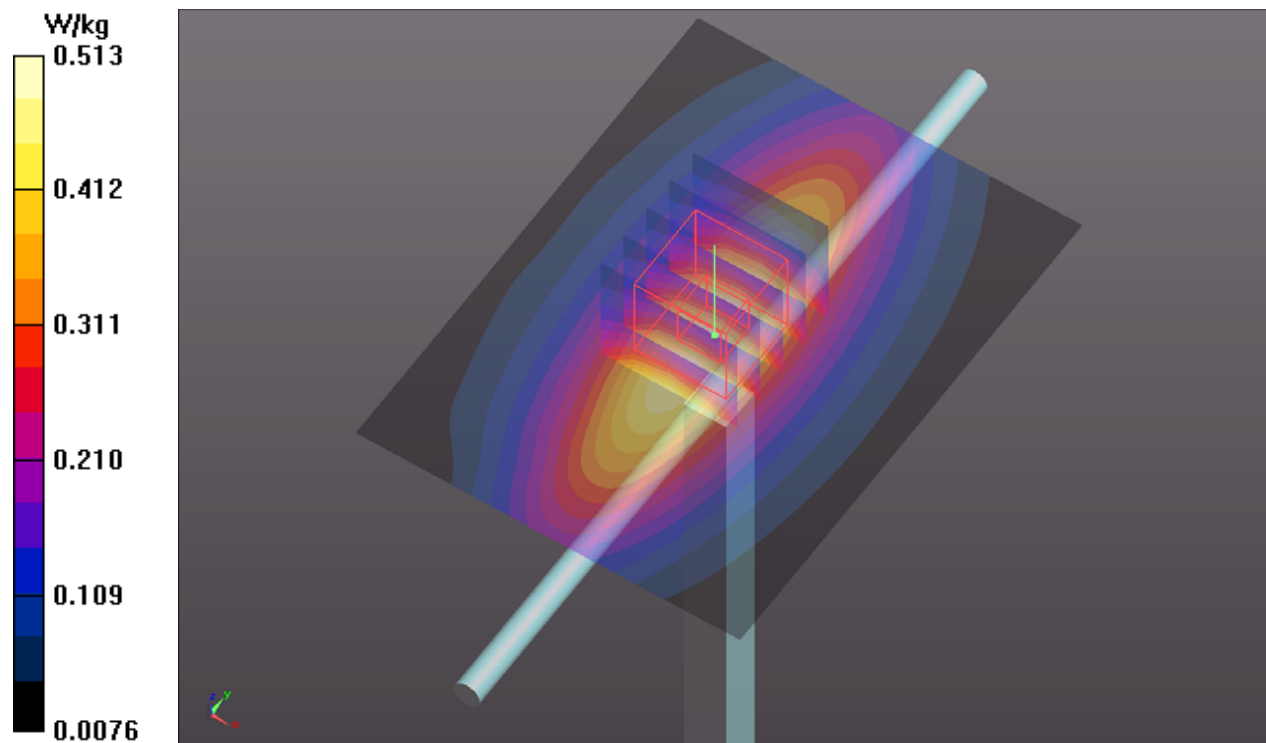

## System Check\_H835\_201125

**DUT: Dipole 835 MHz; Type: D835V2; SN: 4d121**

Communication System: UID 0, CW; Frequency: 835 MHz; Duty Cycle: 1:1  
Medium: H07T10N1\_1125 Medium parameters used:  $f = 835$  MHz;  $\sigma = 0.918$  S/m;  $\epsilon_r = 41.689$ ;  $\rho = 1000$  kg/m<sup>3</sup>  
Ambient Temperature : 23.3 °C ; Liquid Temperature : 23.2 °C

DASY5 Configuration:

- Probe: EX3DV4 - SN3971; ConvF(10.26, 10.26, 10.26) @ 835 MHz; Calibrated: 2020/01/27
- Sensor-Surface: 1.4mm (Mechanical Surface Detection)
- Electronics: DAE4 Sn917; Calibrated: 2019/12/17
- Phantom: ELI Phantom\_1206; Type: QDOVA002AA;
- Measurement SW: DASY52, Version 52.10 (4); SEMCAD X Version 14.6.14 (7483)

**Pin=50mW/Area Scan (61x61x1):** Interpolated grid: dx=1.500 mm, dy=1.500 mm  
Maximum value of SAR (interpolated) = 0.602 W/kg

**Pin=50mW/Zoom Scan (5x5x7)/Cube 0:** Measurement grid: dx=8mm, dy=8mm, dz=5mm  
Reference Value = 26.93 V/m; Power Drift = 0.00 dB  
Peak SAR (extrapolated) = 0.664 W/kg  
**SAR(1 g) = 0.470 W/kg; SAR(10 g) = 0.323 W/kg** (SAR corrected for target medium)  
Maximum value of SAR (measured) = 0.607 W/kg

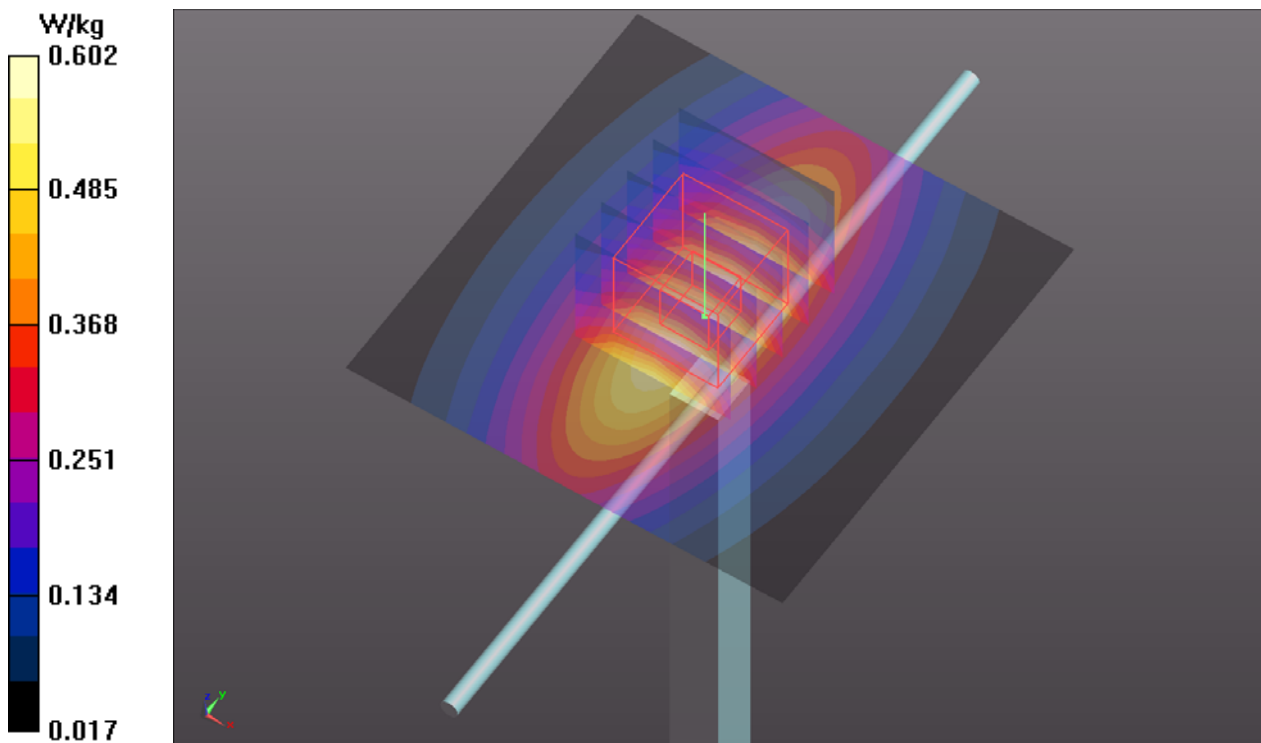

## System Check\_H1750\_201123

**DUT: Dipole 1750 MHz; Type: D1750V2; SN: 1055**

Communication System: UID 0, CW; Frequency: 1750 MHz; Duty Cycle: 1:1  
Medium: H16T20N1\_1123 Medium parameters used:  $f = 1750$  MHz;  $\sigma = 1.319$  S/m;  $\epsilon_r = 40.264$ ;  $\rho = 1000$  kg/m<sup>3</sup>  
Ambient Temperature : 23.3 °C ; Liquid Temperature : 23.2 °C

DASY5 Configuration:

- Probe: EX3DV4 - SN3971; ConvF(8.73, 8.73, 8.73) @ 1750 MHz; Calibrated: 2020/01/27
- Sensor-Surface: 1.4mm (Mechanical Surface Detection)
- Electronics: DAE4 Sn917; Calibrated: 2019/12/17
- Phantom: ELI Phantom\_1206; Type: QDOVA002AA;
- Measurement SW: DASY52, Version 52.10 (4); SEMCAD X Version 14.6.14 (7483)

**Pin=50mW/Area Scan (61x61x1):** Interpolated grid: dx=1.500 mm, dy=1.500 mm  
Maximum value of SAR (interpolated) = 2.79 W/kg

**Pin=50mW/Zoom Scan (5x5x7)/Cube 0:** Measurement grid: dx=8mm, dy=8mm, dz=5mm  
Reference Value = 47.53 V/m; Power Drift = -0.08 dB  
Peak SAR (extrapolated) = 3.20 W/kg  
**SAR(1 g) = 1.94 W/kg; SAR(10 g) = 1.07 W/kg** (SAR corrected for target medium)  
Maximum value of SAR (measured) = 2.79 W/kg

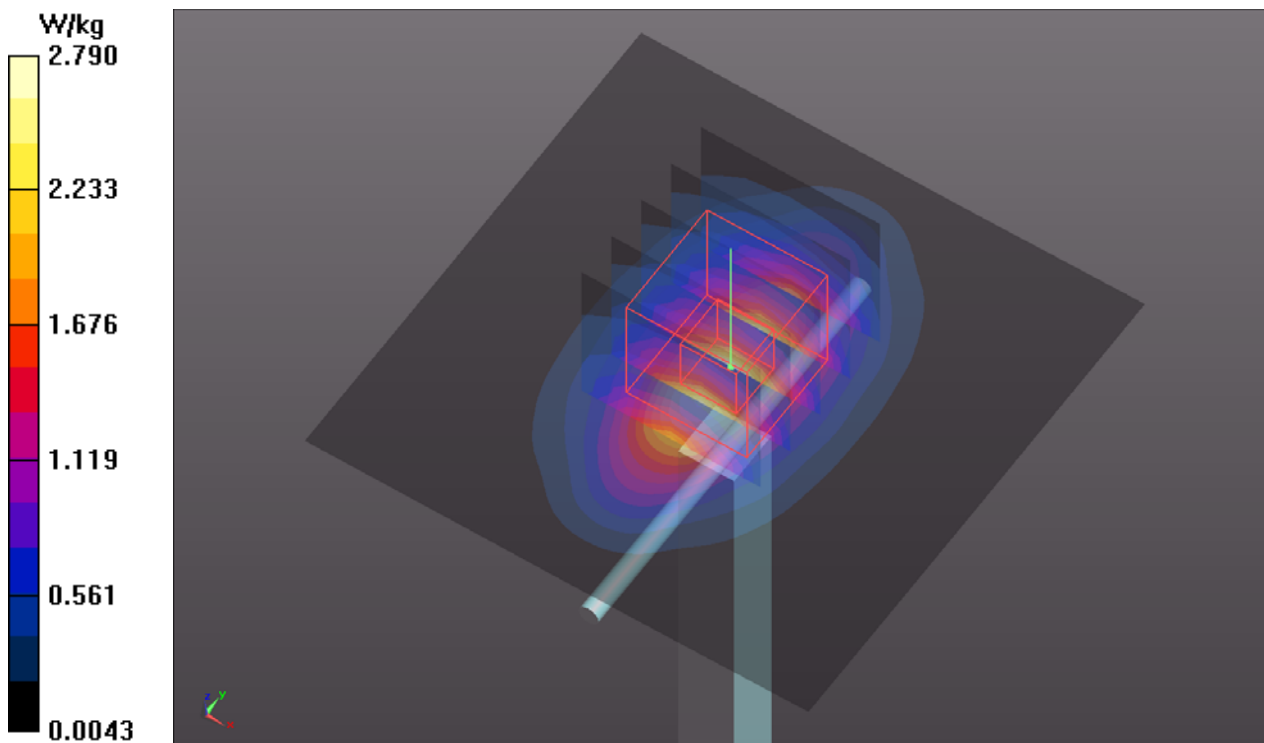

## System Check\_H1900\_201123

**DUT: Dipole 1900 MHz; Type: D1900V2; SN: 5d036**

Communication System: UID 0, CW; Frequency: 1900 MHz; Duty Cycle: 1:1

Medium: H16T20N1\_1123 Medium parameters used:  $f = 1900$  MHz;  $\sigma = 1.456$  S/m;  $\epsilon_r = 39.753$ ;  $\rho = 1000$  kg/m<sup>3</sup>

Ambient Temperature : 23.3 °C ; Liquid Temperature : 23.2 °C

DASY5 Configuration:

- Probe: EX3DV4 - SN3971; ConvF(8.54, 8.54, 8.54) @ 1900 MHz; Calibrated: 2020/01/27
- Sensor-Surface: 1.4mm (Mechanical Surface Detection)
- Electronics: DAE4 Sn917; Calibrated: 2019/12/17
- Phantom: ELI Phantom\_1206; Type: QDOVA002AA;
- Measurement SW: DASY52, Version 52.10 (4); SEMCAD X Version 14.6.14 (7483)

**Pin=50mW/Area Scan (61x61x1):** Interpolated grid: dx=1.500 mm, dy=1.500 mm

Maximum value of SAR (interpolated) = 2.91 W/kg

**Pin=50mW/Zoom Scan (5x5x7)/Cube 0:** Measurement grid: dx=8mm, dy=8mm, dz=5mm

Reference Value = 46.22 V/m; Power Drift = -0.01 dB

Peak SAR (extrapolated) = 3.39 W/kg

**SAR(1 g) = 1.84 W/kg; SAR(10 g) = 0.984 W/kg** (SAR corrected for target medium)

Maximum value of SAR (measured) = 2.88 W/kg

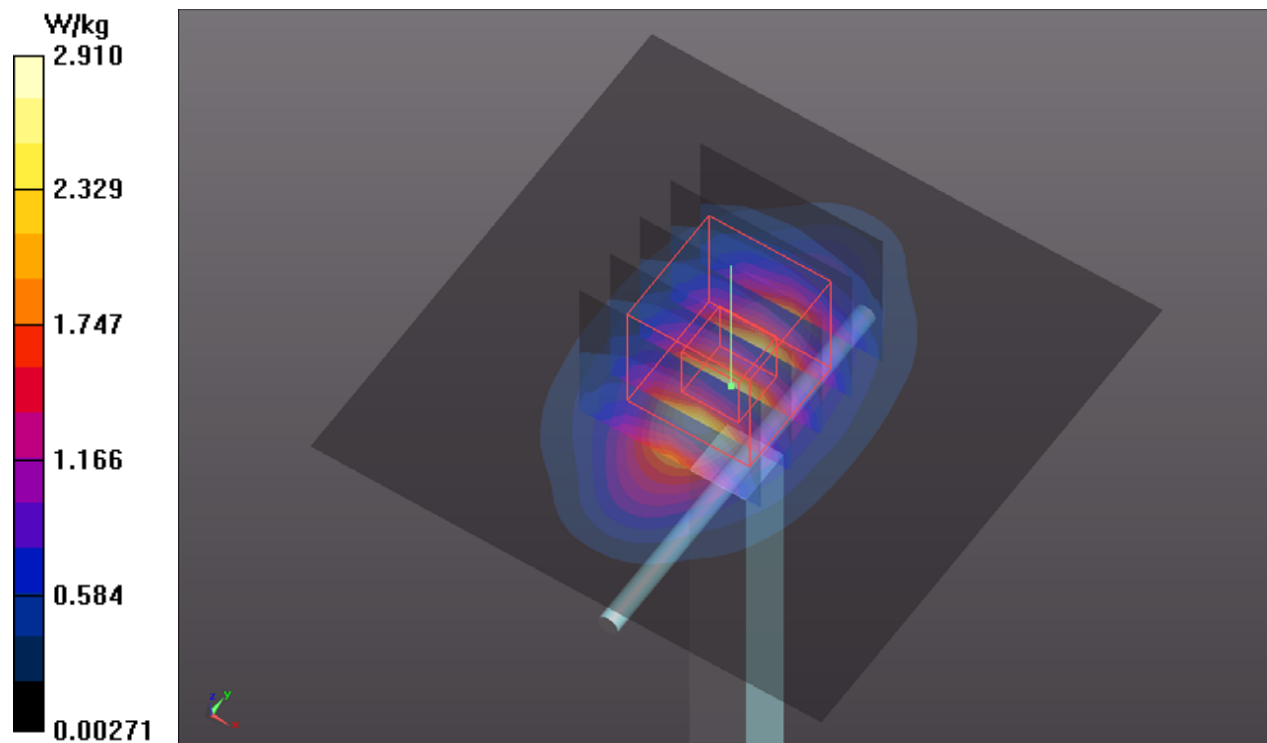



## System Check\_H2300\_201119

**DUT: Dipole 2300 MHz; Type: D2300V2; SN:1004**

Communication System: UID 0, CW; Frequency: 2300 MHz; Duty Cycle: 1:1

Medium: H19T27N1\_1119 Medium parameters used:  $f = 2300$  MHz;  $\sigma = 1.714$  S/m;  $\epsilon_r = 39.234$ ;  $\rho = 1000$  kg/m<sup>3</sup>

Ambient Temperature : 23.6 °C ; Liquid Temperature : 23.4 °C

DASY5 Configuration:

- Probe: EX3DV4 - SN3971; ConvF(8.06, 8.06, 8.06) @ 2300 MHz; Calibrated: 2020/01/27
- Sensor-Surface: 1.4mm (Mechanical Surface Detection)
- Electronics: DAE4 Sn917; Calibrated: 2019/12/17
- Phantom: ELI Phantom\_1206; Type: QDOVA002AA;
- Measurement SW: DASY52, Version 52.10 (4); SEMCAD X Version 14.6.14 (7483)

**Pin=50mW/Area Scan (81x81x1):** Interpolated grid: dx=1.200 mm, dy=1.200 mm  
Maximum value of SAR (interpolated) = 3.77 W/kg

**Pin=50mW/Zoom Scan (7x7x7)/Cube 0:** Measurement grid: dx=5mm, dy=5mm, dz=5mm

Reference Value = 47.19 V/m; Power Drift = 0.19 dB

Peak SAR (extrapolated) = 4.74 W/kg

**SAR(1 g) = 2.29 W/kg; SAR(10 g) = 1.1 W/kg** (SAR corrected for target medium)

Maximum value of SAR (measured) = 3.85 W/kg

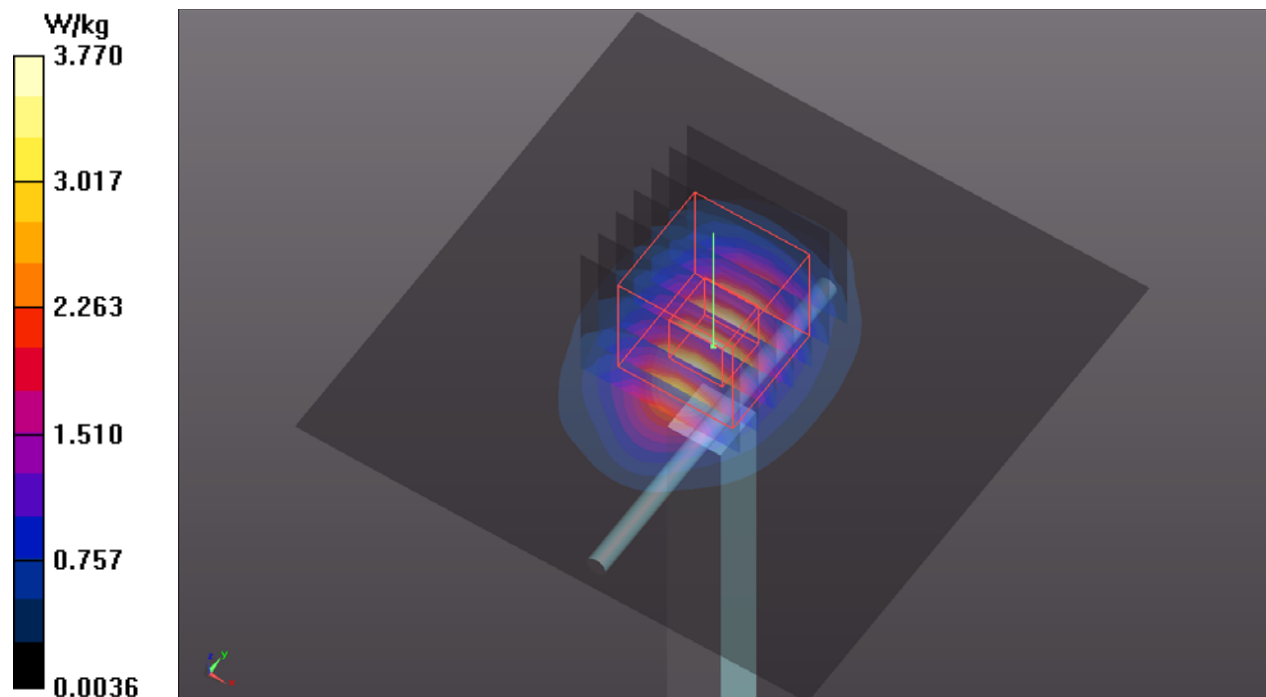

## System Check\_H2450\_201118

**DUT: Dipole 2450 MHz; Type: D2450V2; SN: 737**

Communication System: UID 0, CW; Frequency: 2450 MHz; Duty Cycle: 1:1

Medium: H19T27N1\_1118 Medium parameters used (interpolated):  $f = 2450$  MHz;  $\sigma = 1.874$  S/m;

$\epsilon_r = 37.983$ ;  $\rho = 1000$  kg/m<sup>3</sup>

Ambient Temperature : 23.9 °C ; Liquid Temperature : 23.4 °C

DASY5 Configuration:

- Probe: EX3DV4 - SN3650; ConvF(7.75, 7.75, 7.75) @ 2450 MHz; Calibrated: 2020/03/25
- Sensor-Surface: 1.4mm (Mechanical Surface Detection)
- Electronics: DAE4 Sn861; Calibrated: 2020/05/27
- Phantom: ELI Phantom\_1043; Type: QDOVA;
- Measurement SW: DASY52, Version 52.10 (4); SEMCAD X Version 14.6.14 (7483)

**Pin=50mW/Area Scan (81x81x1):** Interpolated grid: dx=1.200 mm, dy=1.200 mm

Maximum value of SAR (interpolated) = 4.10 W/kg

**Pin=50mW/Zoom Scan (7x7x7)/Cube 0:** Measurement grid: dx=5mm, dy=5mm, dz=5mm

Reference Value = 48.39 V/m; Power Drift = 0.19 dB

Peak SAR (extrapolated) = 5.12 W/kg

**SAR(1 g) = 2.47 W/kg; SAR(10 g) = 1.18 W/kg** (SAR corrected for target medium)

Maximum value of SAR (measured) = 4.19 W/kg

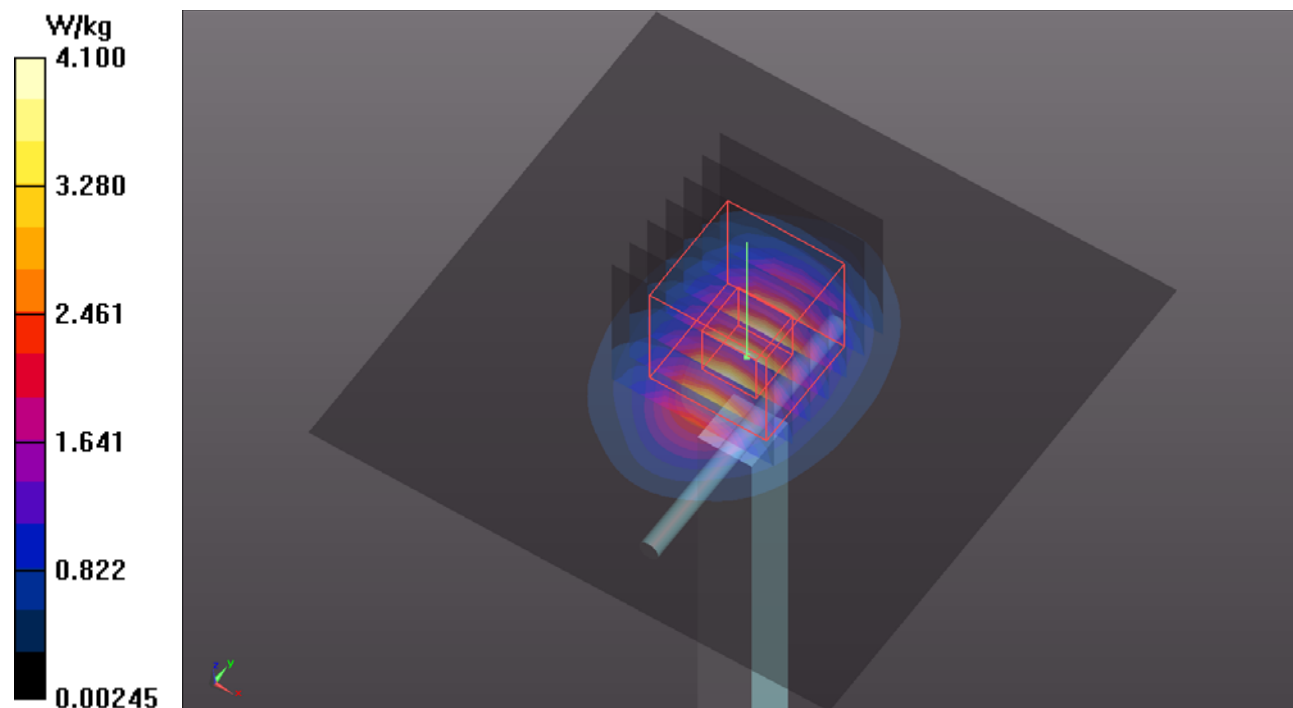

## System Check\_H2600\_201117

**DUT: Dipole 2600 MHz; Type: D2600V2; SN: 1020**

Communication System: UID 0, CW; Frequency: 2600 MHz; Duty Cycle: 1:1

Medium: H19T27N1\_1117 Medium parameters used:  $f = 2600$  MHz;  $\sigma = 2.035$  S/m;  $\epsilon_r = 38.413$ ;  $\rho = 1000$  kg/m<sup>3</sup>

Ambient Temperature : 23.9 °C ; Liquid Temperature : 23.4 °C

DASY5 Configuration:

- Probe: EX3DV4 - SN3650; ConvF(7.56, 7.56, 7.56) @ 2600 MHz; Calibrated: 2020/03/25
- Sensor-Surface: 1.4mm (Mechanical Surface Detection)
- Electronics: DAE4 Sn861; Calibrated: 2020/05/27
- Phantom: ELI Phantom\_1043; Type: QDOVA;
- Measurement SW: DASY52, Version 52.10 (4); SEMCAD X Version 14.6.14 (7483)

**Pin=50mW/Area Scan (81x81x1):** Interpolated grid: dx=1.200 mm, dy=1.200 mm  
Maximum value of SAR (interpolated) = 4.66 W/kg

**Pin=50mW/Zoom Scan (7x7x7)/Cube 0:** Measurement grid: dx=5mm, dy=5mm, dz=5mm

Reference Value = 49.12 V/m; Power Drift = -0.16 dB

Peak SAR (extrapolated) = 5.73 W/kg

**SAR(1 g) = 2.64 W/kg; SAR(10 g) = 1.19 W/kg** (SAR corrected for target medium)

Maximum value of SAR (measured) = 4.62 W/kg

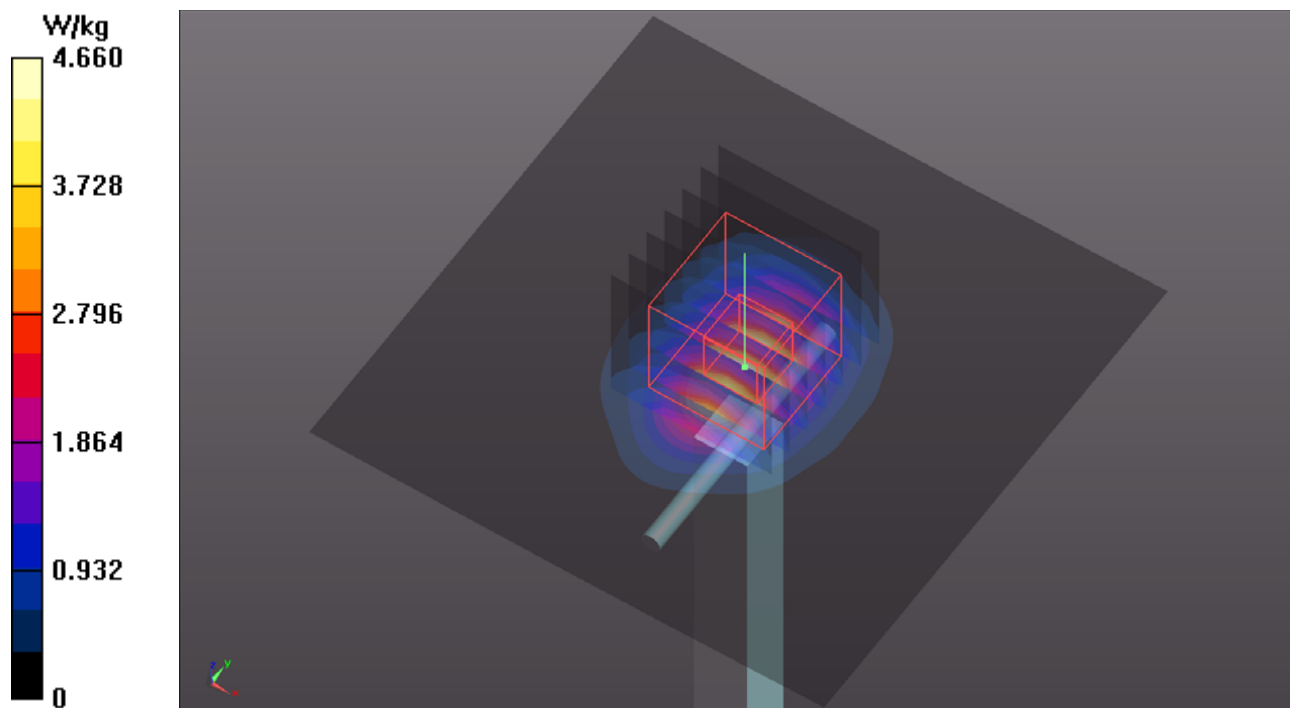

## System Check\_H5250\_201118

**DUT: Dipole 5 GHz; Type: D5GHzV2; SN: 1019**

Communication System: UID 0, CW; Frequency: 5250 MHz; Duty Cycle: 1:1

Medium: H34T60N1\_1118 Medium parameters used (interpolated):  $f = 5250$  MHz;  $\sigma = 4.713$  S/m;

$\epsilon_r = 36.082$ ;  $\rho = 1000$  kg/m<sup>3</sup>

Ambient Temperature : 23.9 °C ; Liquid Temperature : 23.4 °C

DASY5 Configuration:

- Probe: EX3DV4 - SN3650; ConvF(5.39, 5.39, 5.39) @ 5250 MHz; Calibrated: 2020/03/25
- Sensor-Surface: 1.4mm (Mechanical Surface Detection)
- Electronics: DAE4 Sn861; Calibrated: 2020/05/27
- Phantom: ELI Phantom\_1043; Type: QDOVA;
- Measurement SW: DASY52, Version 52.10 (4); SEMCAD X Version 14.6.14 (7483)

**Pin=50mW/Area Scan (91x91x1):** Interpolated grid: dx=1.000 mm, dy=1.000 mm

Maximum value of SAR (interpolated) = 9.48 W/kg

**Pin=50mW/Zoom Scan (7x7x7)/Cube 0:** Measurement grid: dx=4mm, dy=4mm, dz=1.4mm

Reference Value = 50.96 V/m; Power Drift = -0.02 dB

Peak SAR (extrapolated) = 16.5 W/kg

**SAR(1 g) = 4.2 W/kg; SAR(10 g) = 1.21 W/kg** (SAR corrected for target medium)

Maximum value of SAR (measured) = 10.6 W/kg

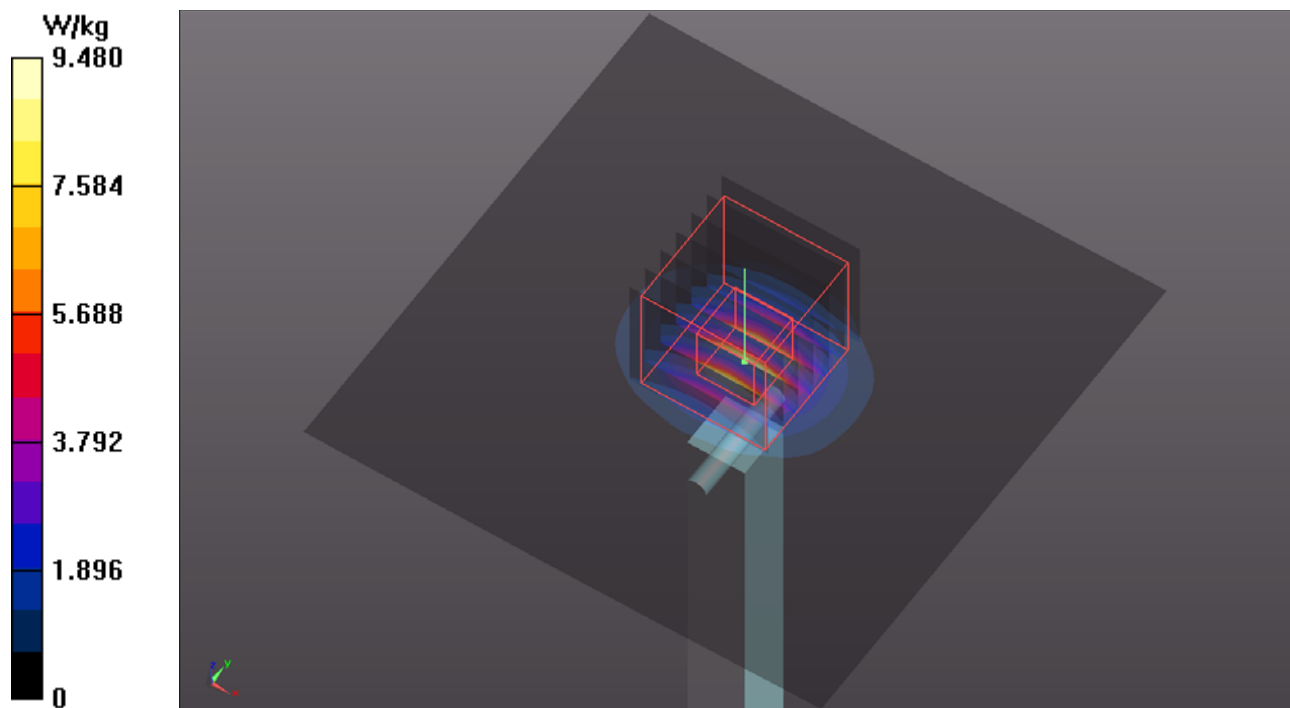

## System Check\_H5600\_201118

**DUT: Dipole 5 GHz; Type: D5GHzV2; SN: 1019**

Communication System: UID 0, CW; Frequency: 5600 MHz; Duty Cycle: 1:1

Medium: H34T60N1\_1118 Medium parameters used:  $f = 5600$  MHz;  $\sigma = 5.054$  S/m;  $\epsilon_r = 35.608$ ;  $\rho = 1000$  kg/m<sup>3</sup>

Ambient Temperature : 23.9 °C ; Liquid Temperature : 23.4 °C

DASY5 Configuration:

- Probe: EX3DV4 - SN3650; ConvF(4.88, 4.88, 4.88) @ 5600 MHz; Calibrated: 2020/03/25
- Sensor-Surface: 1.4mm (Mechanical Surface Detection)
- Electronics: DAE4 Sn861; Calibrated: 2020/05/27
- Phantom: ELI Phantom\_1043; Type: QDOVA;
- Measurement SW: DASY52, Version 52.10 (4); SEMCAD X Version 14.6.14 (7483)

**Pin=50mW/Area Scan (91x91x1):** Interpolated grid: dx=1.000 mm, dy=1.000 mm  
Maximum value of SAR (interpolated) = 11.1 W/kg

**Pin=50mW/Zoom Scan (7x7x7)/Cube 0:** Measurement grid: dx=4mm, dy=4mm, dz=1.4mm  
Reference Value = 52.81 V/m; Power Drift = -0.17 dB  
Peak SAR (extrapolated) = 19.9 W/kg  
**SAR(1 g) = 4.56 W/kg; SAR(10 g) = 1.27 W/kg** (SAR corrected for target medium)  
Maximum value of SAR (measured) = 12.1 W/kg

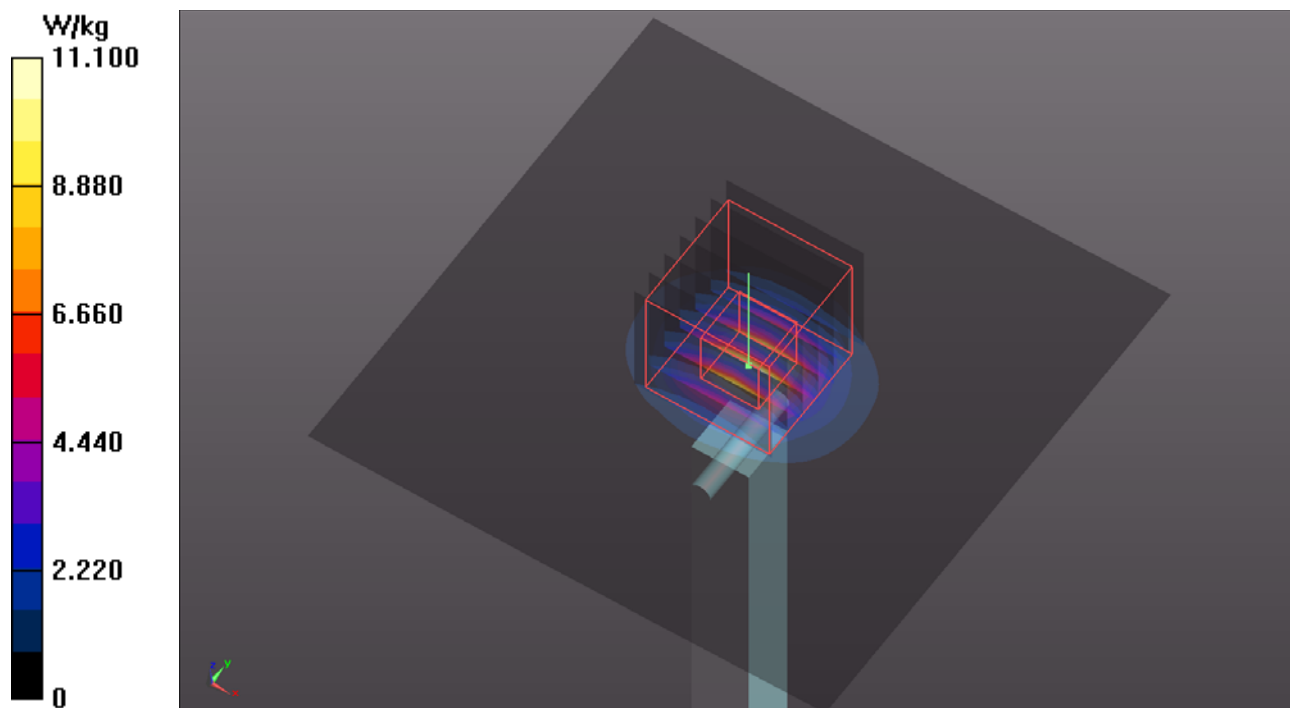

## System Check\_H5750\_201119

**DUT: Dipole 5 GHz; Type: D5GHzV2; SN: 1019**

Communication System: UID 0, CW; Frequency: 5750 MHz; Duty Cycle: 1:1

Medium: H34T60N1\_1119 Medium parameters used:  $f = 5750$  MHz;  $\sigma = 5.061$  S/m;  $\epsilon_r = 35.952$ ;  $\rho = 1000$  kg/m<sup>3</sup>

Ambient Temperature : 23.6 °C ; Liquid Temperature : 23.4 °C

DASY5 Configuration:

- Probe: EX3DV4 - SN3971; ConvF(5.05, 5.05, 5.05) @ 5750 MHz; Calibrated: 2020/01/27
- Sensor-Surface: 1.4mm (Mechanical Surface Detection)
- Electronics: DAE4 Sn917; Calibrated: 2019/12/17
- Phantom: ELI Phantom\_1206; Type: QDOVA002AA;
- Measurement SW: DASY52, Version 52.10 (4); SEMCAD X Version 14.6.14 (7483)

**Pin=50mW/Area Scan (91x91x1):** Interpolated grid: dx=1.000 mm, dy=1.000 mm

Maximum value of SAR (interpolated) = 9.21 W/kg

**Pin=50mW/Zoom Scan (7x7x7)/Cube 0:** Measurement grid: dx=4mm, dy=4mm, dz=1.4mm

Reference Value = 44.11 V/m; Power Drift = 0.09 dB

Peak SAR (extrapolated) = 16.8 W/kg

**SAR(1 g) = 3.72 W/kg; SAR(10 g) = 1.06 W/kg** (SAR corrected for target medium)

Maximum value of SAR (measured) = 9.73 W/kg

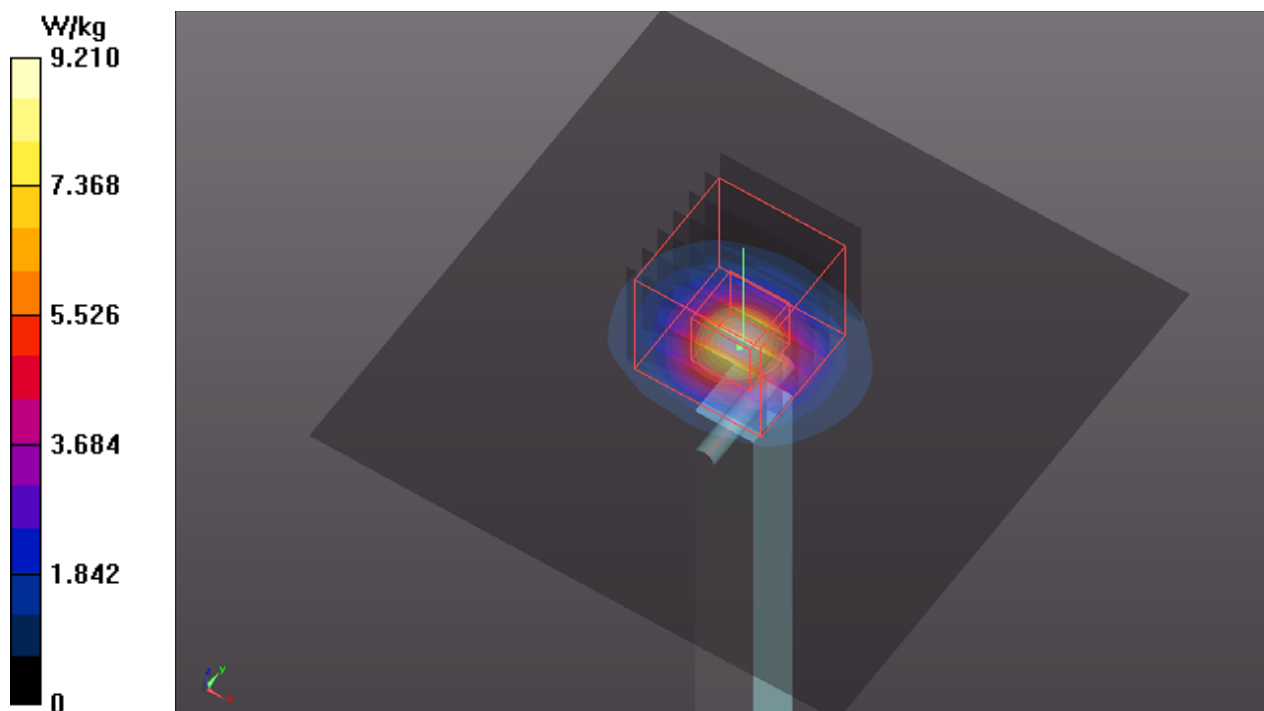

### Appendix B. SAR Plots of SAR Measurement

The SAR plots for highest measured SAR in each exposure configuration, wireless mode and frequency band combination, and measured SAR > 1.5 W/kg are shown as follows.

### P01 WCDMA II\_RMC12.2K\_Rear Face\_0mm\_Ch9538\_Sample 1\_Battery 4cell\_P-Sensor\_w

**DUT: BEDW-WTW-P20100106**

Communication System: UID 10011 - CAB, UMTS-FDD (WCDMA); Frequency: 1907.6 MHz; Duty Cycle: 1:1.95  
Medium: H16T20N1\_1125 Medium parameters used:  $f = 1908$  MHz;  $\sigma = 1.462$  S/m;  $\epsilon_r = 38.36$ ;  $\rho = 1000$  kg/m<sup>3</sup>  
Ambient Temperature : 23.3 °C ; Liquid Temperature : 23.2 °C

DASY5 Configuration:

- Probe: EX3DV4 - SN3971; ConvF(8.54, 8.54, 8.54) @ 1907.6 MHz; Calibrated: 2020/01/27
- Sensor-Surface: 1.4mm (Mechanical Surface Detection)
- Electronics: DAE4 Sn917; Calibrated: 2019/12/17
- Phantom: ELI Phantom\_1206; Type: QDOVA002AA;
- Measurement SW: DASY52, Version 52.10 (4); SEMCAD X Version 14.6.14 (7483)

**Area Scan (71x241x1):** Interpolated grid: dx=1.500 mm, dy=1.500 mm  
Maximum value of SAR (interpolated) = 1.02 W/kg

**Zoom Scan (5x5x7)/Cube 0:** Measurement grid: dx=8mm, dy=8mm, dz=5mm  
Reference Value = 21.42 V/m; Power Drift = 0.08 dB  
Peak SAR (extrapolated) = 1.74 W/kg  
**SAR(1 g) = 0.684 W/kg; SAR(10 g) = 0.294 W/kg** (SAR corrected for target medium)  
Smallest distance from peaks to all points 3 dB below = 8.2 mm  
Ratio of SAR at M2 to SAR at M1 = 44%  
Maximum value of SAR (measured) = 1.29 W/kg

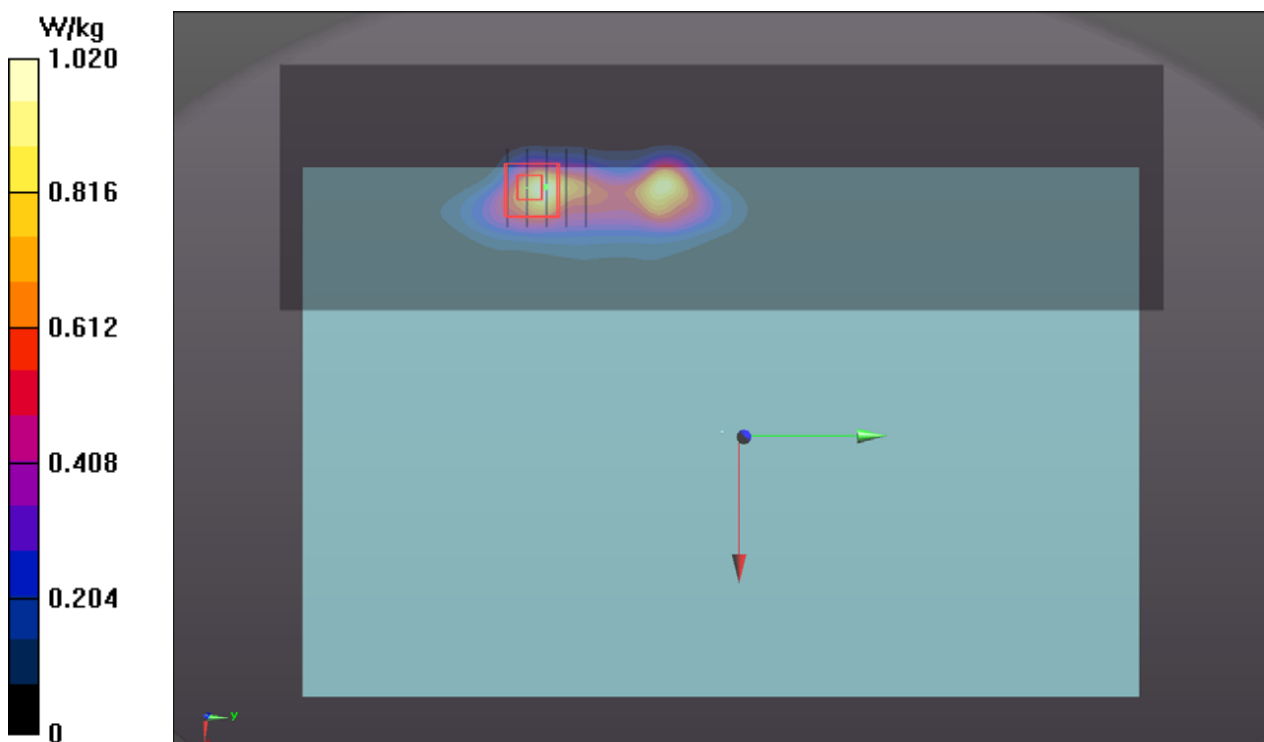



## P02 WCDMA IV\_RMC12.2K\_Rear Face\_0mm\_Ch1513\_Sample 1\_Battery 4cell\_P-Sensor\_w

**DUT: BEDW-WTW-P20100106**

Communication System: UID 10011 - CAB, UMTS-FDD (WCDMA); Frequency: 1752.6 MHz; Duty Cycle: 1:1.95

Medium: H16T20N1\_1125 Medium parameters used:  $f = 1753$  MHz;  $\sigma = 1.328$  S/m;  $\epsilon_r = 38.928$ ;  $\rho = 1000$  kg/m<sup>3</sup>

Ambient Temperature : 23.3 °C ; Liquid Temperature : 23.2 °C

DASY5 Configuration:

- Probe: EX3DV4 - SN3971; ConvF(8.73, 8.73, 8.73) @ 1752.6 MHz; Calibrated: 2020/01/27
- Sensor-Surface: 1.4mm (Mechanical Surface Detection)
- Electronics: DAE4 Sn917; Calibrated: 2019/12/17
- Phantom: ELI Phantom\_1206; Type: QDOVA002AA;
- Measurement SW: DASY52, Version 52.10 (4); SEMCAD X Version 14.6.14 (7483)

**Area Scan (71x241x1):** Interpolated grid: dx=1.500 mm, dy=1.500 mm

Maximum value of SAR (interpolated) = 0.988 W/kg

**Zoom Scan (5x5x7)/Cube 0:** Measurement grid: dx=8mm, dy=8mm, dz=5mm

Reference Value = 27.45 V/m; Power Drift = 0.09 dB

Peak SAR (extrapolated) = 1.85 W/kg

**SAR(1 g) = 0.725 W/kg; SAR(10 g) = 0.303 W/kg** (SAR corrected for target medium)

Smallest distance from peaks to all points 3 dB below = 10.4 mm

Ratio of SAR at M2 to SAR at M1 = 38.9%

Maximum value of SAR (measured) = 1.24 W/kg

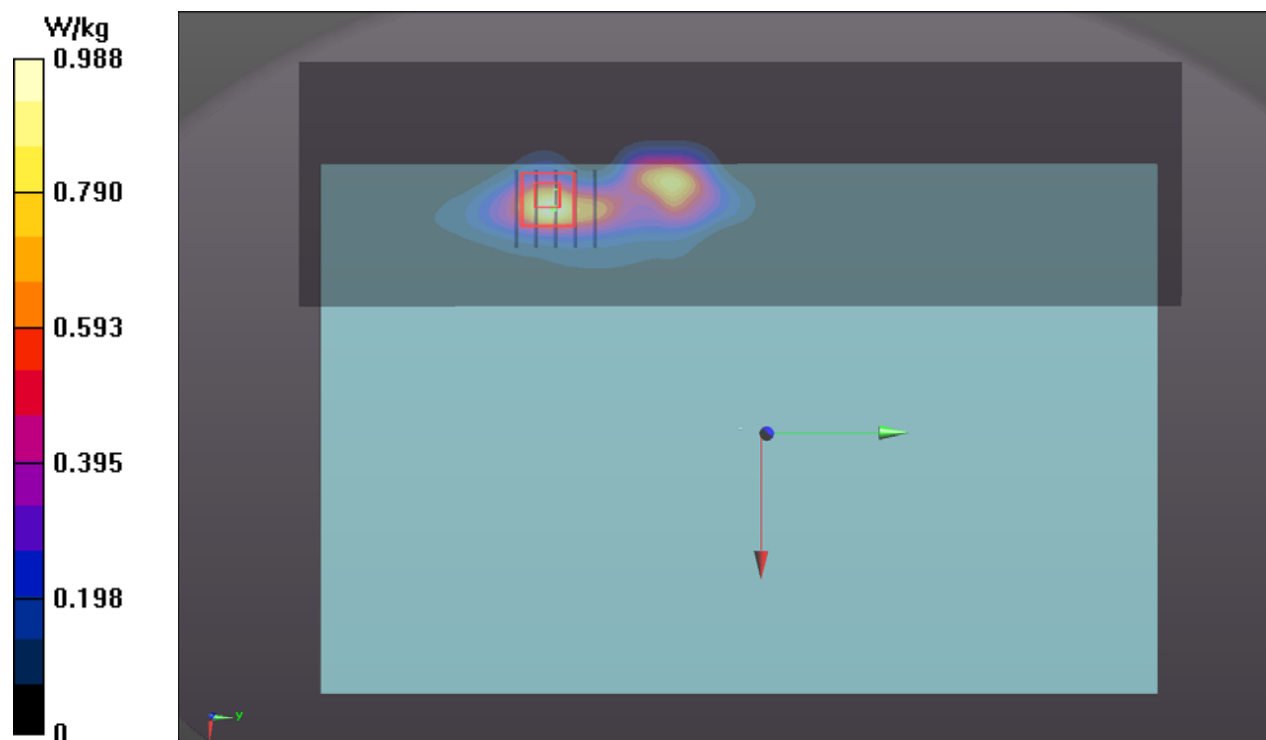

### P03 WCDMA V\_RMC12.2K\_Rear Face\_0mm\_Ch4132\_Sample 1\_Battery 4cell\_P-Sensor\_w

**DUT: BEDW-WTW-P20100106**

Communication System: UID 10011 - CAB, UMTS-FDD (WCDMA); Frequency: 826.4 MHz; Duty Cycle: 1:1.95

Medium: H07T10N1\_1125 Medium parameters used (interpolated):  $f = 826.4$  MHz;  $\sigma = 0.91$  S/m;

$\epsilon_r = 41.798$ ;  $\rho = 1000$  kg/m<sup>3</sup>

Ambient Temperature : 23.3 °C ; Liquid Temperature : 23.2 °C

DASY5 Configuration:

- Probe: EX3DV4 - SN3971; ConvF(10.26, 10.26, 10.26) @ 826.4 MHz; Calibrated: 2020/01/27
- Sensor-Surface: 1.4mm (Mechanical Surface Detection)
- Electronics: DAE4 Sn917; Calibrated: 2019/12/17
- Phantom: ELI Phantom\_1206; Type: QDOVA002AA;
- Measurement SW: DASY52, Version 52.10 (4); SEMCAD X Version 14.6.14 (7483)

**Area Scan (71x241x1):** Interpolated grid: dx=1.500 mm, dy=1.500 mm

Maximum value of SAR (interpolated) = 0.819 W/kg

**Zoom Scan (5x5x7)/Cube 0:** Measurement grid: dx=8mm, dy=8mm, dz=5mm

Reference Value = 30.40 V/m; Power Drift = -0.06 dB

Peak SAR (extrapolated) = 1.86 W/kg

**SAR(1 g) = 0.774 W/kg; SAR(10 g) = 0.381 W/kg** (SAR corrected for target medium)

Smallest distance from peaks to all points 3 dB below = 11.8 mm

Ratio of SAR at M2 to SAR at M1 = 52.6%

Maximum value of SAR (measured) = 1.24 W/kg

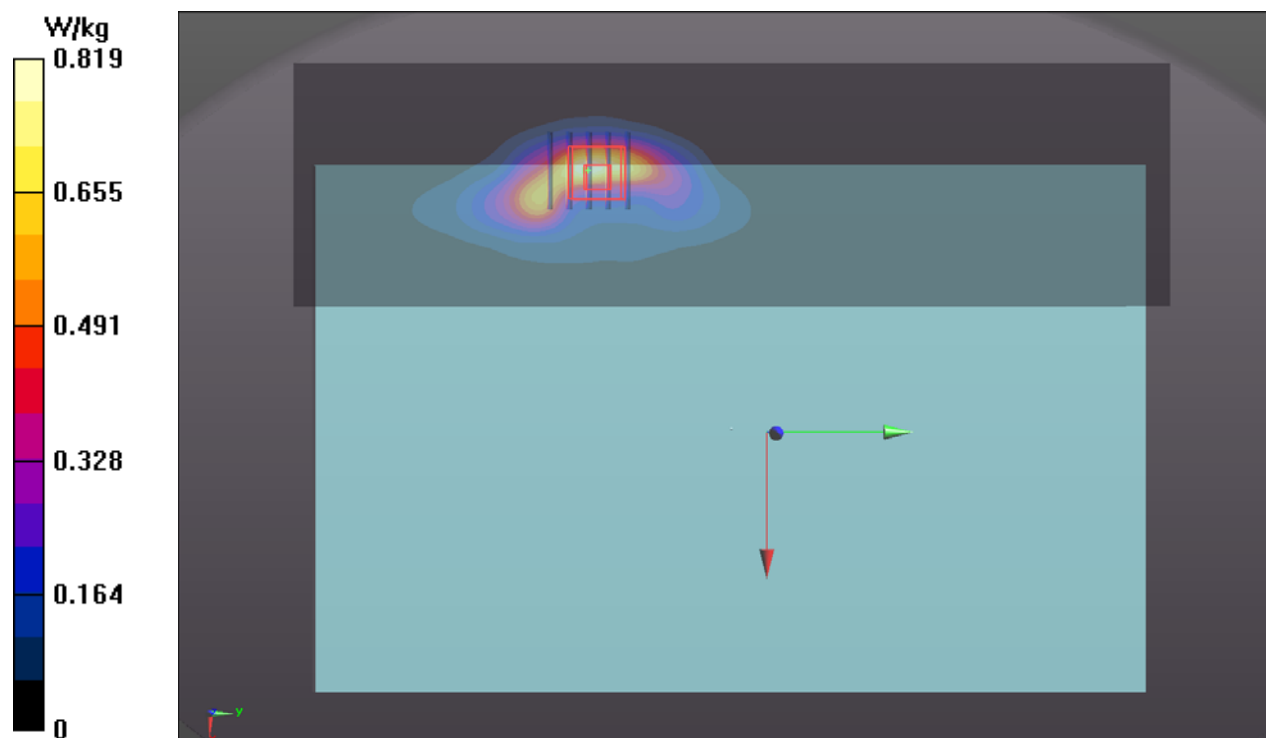

# P04 LTE 2\_QPSK20M\_Rear Face\_0mm\_Ch19100\_1RB\_OS0\_Sample 1\_Battery 4cell\_P-Sensor\_w

**DUT: BEDW-WTW-P20100106**

Communication System: UID 10169 - CAE, LTE-FDD (SC-FDMA, 1 RB, 20 MHz, QPSK);  
Frequency: 1900 MHz; Duty Cycle: 1:3.74

Medium: H16T20N1\_1125 Medium parameters used:  $f = 1900$  MHz;  $\sigma = 1.455$  S/m;  $\epsilon_r = 38.385$ ;  $\rho = 1000$  kg/m<sup>3</sup>

Ambient Temperature : 23.3 °C ; Liquid Temperature : 23.2 °C

DASY5 Configuration:

- Probe: EX3DV4 - SN3971; ConvF(8.54, 8.54, 8.54) @ 1900 MHz; Calibrated: 2020/01/27
- Sensor-Surface: 1.4mm (Mechanical Surface Detection)
- Electronics: DAE4 Sn917; Calibrated: 2019/12/17
- Phantom: ELI Phantom\_1206; Type: QDOVA002AA;
- Measurement SW: DASY52, Version 52.10 (4); SEMCAD X Version 14.6.14 (7483)

**Area Scan (71x241x1):** Interpolated grid: dx=1.500 mm, dy=1.500 mm

Maximum value of SAR (interpolated) = 0.872 W/kg

**Zoom Scan (5x5x7)/Cube 0:** Measurement grid: dx=8mm, dy=8mm, dz=5mm

Reference Value = 19.84 V/m; Power Drift = 0.06 dB

Peak SAR (extrapolated) = 1.93 W/kg

**SAR(1 g) = 0.772 W/kg; SAR(10 g) = 0.318 W/kg** (SAR corrected for target medium)

Smallest distance from peaks to all points 3 dB below = 12.4 mm

Ratio of SAR at M2 to SAR at M1 = 39.4%

Maximum value of SAR (measured) = 1.48 W/kg

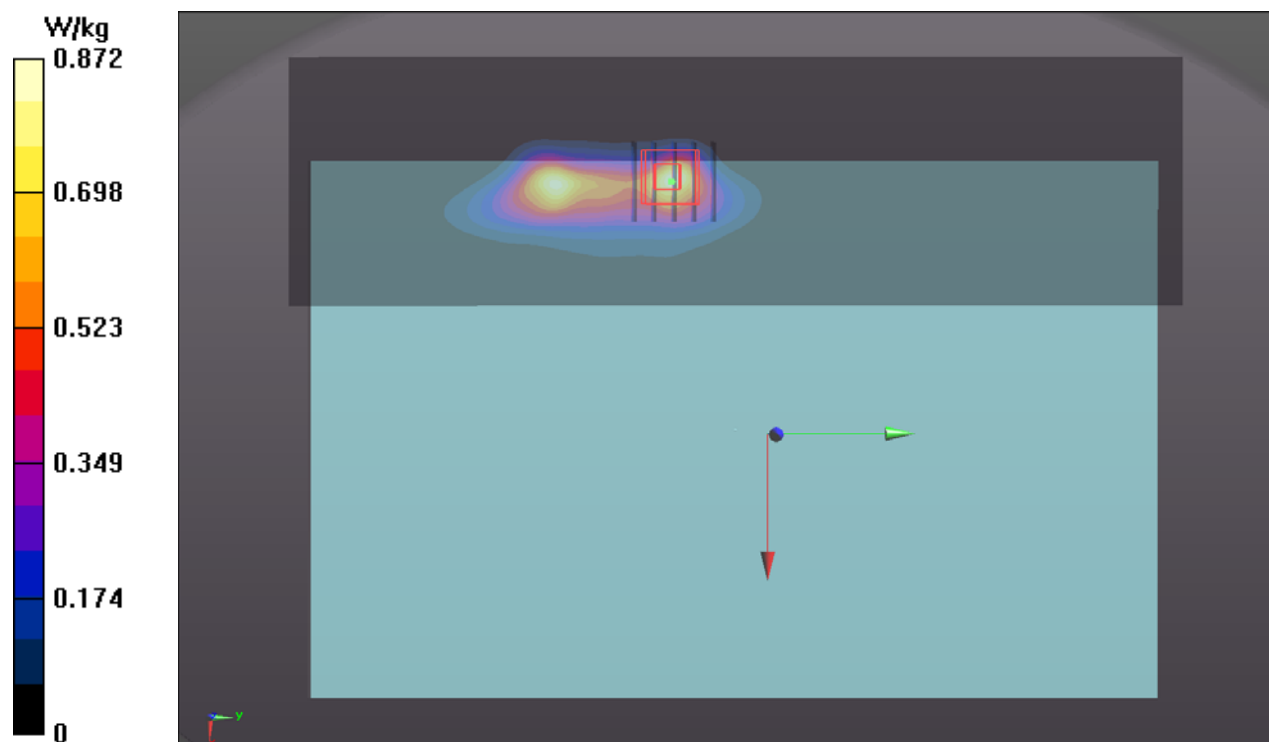

### P05 LTE 4\_QPSK20M\_Rear Face\_0mm\_Ch20300\_1RB\_OS0\_Sample 1\_Battery 4cell\_P-Sensor\_w

**DUT: BEDW-WTW-P20100106**

Communication System: UID 10169 - CAE, LTE-FDD (SC-FDMA, 1 RB, 20 MHz, QPSK);  
Frequency: 1745 MHz; Duty Cycle: 1:3.74

Medium: H16T20N1\_1126 Medium parameters used (interpolated):  $f = 1745$  MHz;  $\sigma = 1.321$  S/m;  
 $\epsilon_r = 39.361$ ;  $\rho = 1000$  kg/m<sup>3</sup>

Ambient Temperature : 23.3 °C ; Liquid Temperature : 23.2 °C

DASY5 Configuration:

- Probe: EX3DV4 - SN3971; ConvF(8.73, 8.73, 8.73) @ 1745 MHz; Calibrated: 2020/01/27
- Sensor-Surface: 1.4mm (Mechanical Surface Detection)
- Electronics: DAE4 Sn917; Calibrated: 2019/12/17
- Phantom: ELI Phantom\_1206; Type: QDOVA002AA;
- Measurement SW: DASY52, Version 52.10 (4); SEMCAD X Version 14.6.14 (7483)

**Area Scan (71x241x1):** Interpolated grid: dx=1.500 mm, dy=1.500 mm

Maximum value of SAR (interpolated) = 0.928 W/kg

**Zoom Scan (5x5x7)/Cube 0:** Measurement grid: dx=8mm, dy=8mm, dz=5mm

Reference Value = 26.61 V/m; Power Drift = 0.02 dB

Peak SAR (extrapolated) = 1.99 W/kg

**SAR(1 g) = 0.776 W/kg; SAR(10 g) = 0.312 W/kg** (SAR corrected for target medium)

Smallest distance from peaks to all points 3 dB below = 14.8 mm

Ratio of SAR at M2 to SAR at M1 = 41.4%

Maximum value of SAR (measured) = 1.64 W/kg

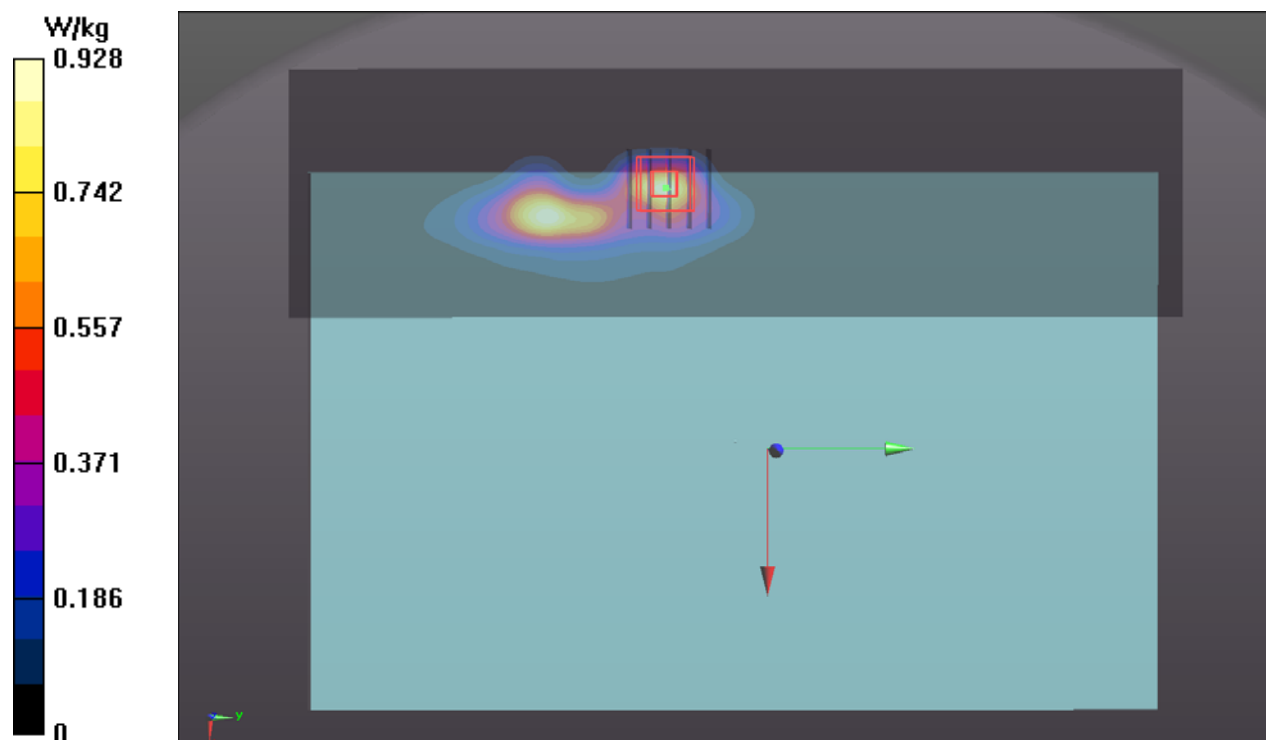

### P06 LTE 5\_QPSK10M\_Rear Face\_0mm\_Ch20450\_1RB\_OS0\_Sample 1\_Battery 4cell\_P-Sensor\_w

**DUT: BEDW-WTW-P20100106**

Communication System: UID 10175 - CAG, LTE-FDD (SC-FDMA, 1 RB, 10 MHz, QPSK);  
Frequency: 829 MHz; Duty Cycle: 1:3.74  
Medium: H07T10N3\_1126 Medium parameters used:  $f = 829$  MHz;  $\sigma = 0.903$  S/m;  $\epsilon_r = 42.464$ ;  $\rho = 1000$  kg/m<sup>3</sup>  
Ambient Temperature : 23.3 °C ; Liquid Temperature : 23.2 °C

DASY5 Configuration:

- Probe: EX3DV4 - SN3971; ConvF(10.26, 10.26, 10.26) @ 829 MHz; Calibrated: 2020/01/27
- Sensor-Surface: 1.4mm (Mechanical Surface Detection)
- Electronics: DAE4 Sn917; Calibrated: 2019/12/17
- Phantom: ELI Phantom\_1206; Type: QDOVA002AA;
- Measurement SW: DASY52, Version 52.10 (4); SEMCAD X Version 14.6.14 (7483)

**Area Scan (71x241x1):** Interpolated grid: dx=1.500 mm, dy=1.500 mm  
Maximum value of SAR (interpolated) = 0.869 W/kg

**Zoom Scan (5x5x7)/Cube 0:** Measurement grid: dx=8mm, dy=8mm, dz=5mm  
Reference Value = 31.62 V/m; Power Drift = -0.02 dB  
Peak SAR (extrapolated) = 1.94 W/kg  
**SAR(1 g) = 0.766 W/kg; SAR(10 g) = 0.369 W/kg** (SAR corrected for target medium)  
Smallest distance from peaks to all points 3 dB below = 10.4 mm  
Ratio of SAR at M2 to SAR at M1 = 43.4%  
Maximum value of SAR (measured) = 1.22 W/kg

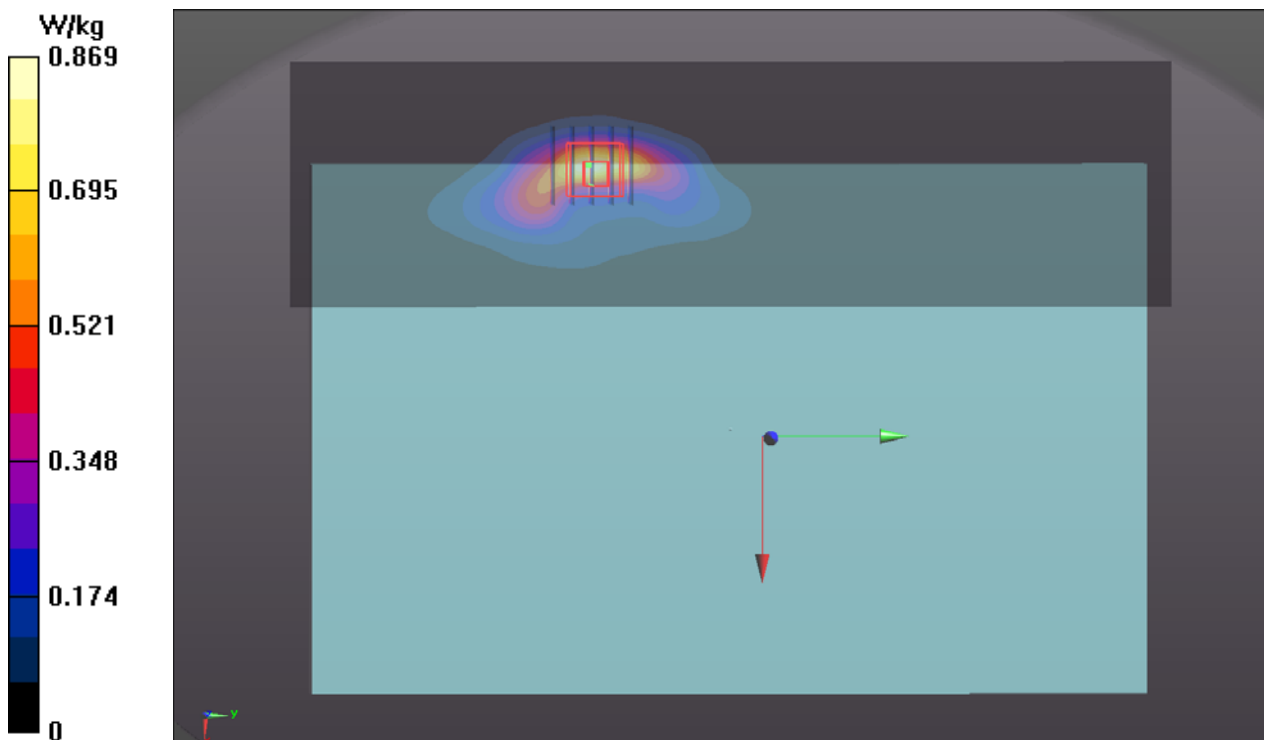

# P07 LTE 7\_QPSK20M\_Rear Face\_0mm\_Ch20850\_1RB\_OS0\_Sample 1\_Battery 4cell\_P-Sensor\_w

**DUT: BEDW-WTW-P20100106**

Communication System: UID 10169 - CAE, LTE-FDD (SC-FDMA, 1 RB, 20 MHz, QPSK);  
Frequency: 2510 MHz; Duty Cycle: 1:3.74

Medium: H19T27N1\_1127 Medium parameters used:  $f = 2510$  MHz;  $\sigma = 1.945$  S/m;  $\epsilon_r = 38.149$ ;  $\rho = 1000$  kg/m<sup>3</sup>

Ambient Temperature : 23.1 °C ; Liquid Temperature : 23 °C

DASY5 Configuration:

- Probe: EX3DV4 - SN3971; ConvF(7.71, 7.71, 7.71) @ 2510 MHz; Calibrated: 2020/01/27
- Sensor-Surface: 1.4mm (Mechanical Surface Detection)
- Electronics: DAE4 Sn917; Calibrated: 2019/12/17
- Phantom: ELI Phantom\_1206; Type: QDOVA002AA;
- Measurement SW: DASY52, Version 52.10 (4); SEMCAD X Version 14.6.14 (7483)

**Area Scan (91x301x1):** Interpolated grid: dx=1.200 mm, dy=1.200 mm

Maximum value of SAR (interpolated) = 1.06 W/kg

**Zoom Scan (7x7x7)/Cube 0:** Measurement grid: dx=5mm, dy=5mm, dz=5mm

Reference Value = 23.82 V/m; Power Drift = 0.07 dB

Peak SAR (extrapolated) = 2.99 W/kg

**SAR(1 g) = 1.02 W/kg; SAR(10 g) = 0.403 W/kg** (SAR corrected for target medium)

Smallest distance from peaks to all points 3 dB below = 9.7 mm

Ratio of SAR at M2 to SAR at M1 = 37.8%

Maximum value of SAR (measured) = 2.06 W/kg

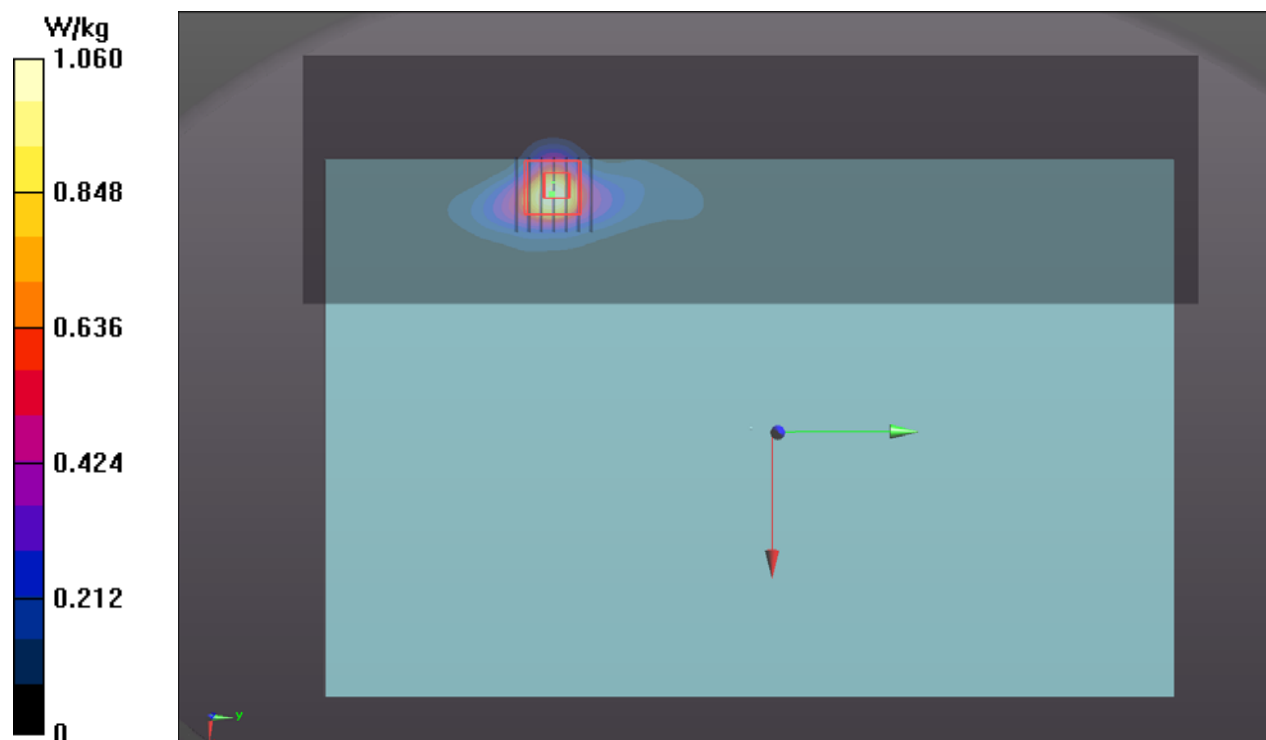

### P08 LTE 12\_QPSK10M\_Rear Face\_0mm\_Ch23095\_1RB\_OS0\_Sample 1\_Battery 4cell\_P-Sensor\_w

**DUT: BEDW-WTW-P20100106**

Communication System: UID 10175 - CAG, LTE-FDD (SC-FDMA, 1 RB, 10 MHz, QPSK);  
Frequency: 707.5 MHz; Duty Cycle: 1:3.74  
Medium: H06T09N1\_1127 Medium parameters used (interpolated):  $f = 707.5$  MHz;  $\sigma = 0.854$  S/m;  
 $\epsilon_r = 42.95$ ;  $\rho = 1000$  kg/m<sup>3</sup>  
Ambient Temperature : 23.1 °C ; Liquid Temperature : 23 °C

DASY5 Configuration:

- Probe: EX3DV4 - SN3971; ConvF(10.6, 10.6, 10.6) @ 707.5 MHz; Calibrated: 2020/01/27
- Sensor-Surface: 1.4mm (Mechanical Surface Detection)
- Electronics: DAE4 Sn917; Calibrated: 2019/12/17
- Phantom: ELI Phantom\_1206; Type: QDOVA002AA;
- Measurement SW: DASY52, Version 52.10 (4); SEMCAD X Version 14.6.14 (7483)

**Area Scan (71x241x1):** Interpolated grid: dx=1.500 mm, dy=1.500 mm  
Maximum value of SAR (interpolated) = 0.833 W/kg

**Zoom Scan (5x5x7)/Cube 0:** Measurement grid: dx=8mm, dy=8mm, dz=5mm  
Reference Value = 30.23 V/m; Power Drift = -0.06 dB  
Peak SAR (extrapolated) = 1.71 W/kg  
**SAR(1 g) = 0.748 W/kg; SAR(10 g) = 0.357 W/kg** (SAR corrected for target medium)  
Smallest distance from peaks to all points 3 dB below = 12.8 mm  
Ratio of SAR at M2 to SAR at M1 = 49%  
Maximum value of SAR (measured) = 1.23 W/kg

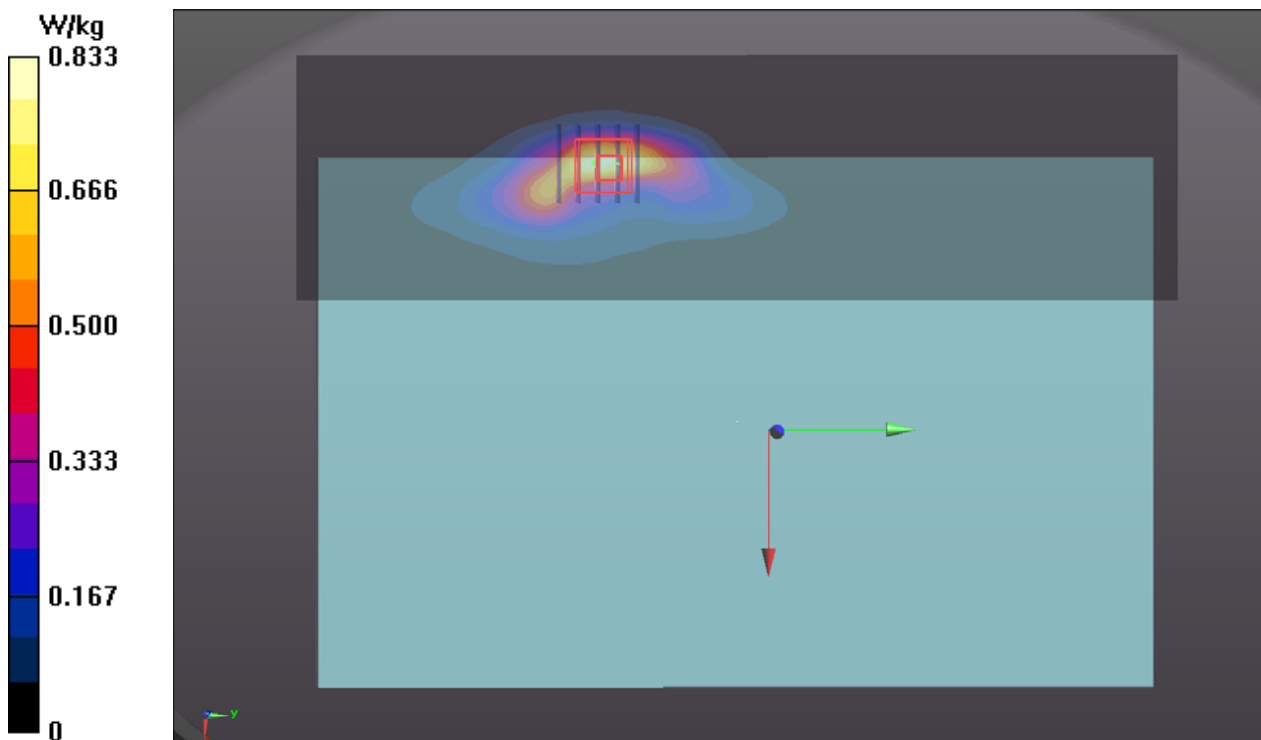

# P09 LTE 13\_QPSK10M\_Rear Face\_0mm\_Ch23230\_1RB\_OS0\_Sample 1\_Battery 4cell\_P-Sensor\_w

**DUT: BEDW-WTW-P20100106**

Communication System: UID 10175 - CAG, LTE-FDD (SC-FDMA, 1 RB, 10 MHz, QPSK);  
Frequency: 782 MHz; Duty Cycle: 1:3.74  
Medium: H06T09N1\_1128 Medium parameters used:  $f = 782$  MHz;  $\sigma = 0.918$  S/m;  $\epsilon_r = 43.076$ ;  $\rho = 1000$  kg/m<sup>3</sup>  
Ambient Temperature : 23.4 °C ; Liquid Temperature : 23.2 °C

DASY5 Configuration:

- Probe: EX3DV4 - SN3971; ConvF(10.6, 10.6, 10.6) @ 782 MHz; Calibrated: 2020/01/27
- Sensor-Surface: 1.4mm (Mechanical Surface Detection)
- Electronics: DAE4 Sn917; Calibrated: 2019/12/17
- Phantom: ELI Phantom\_1206; Type: QDOVA002AA;
- Measurement SW: DASY52, Version 52.10 (4); SEMCAD X Version 14.6.14 (7483)

**Area Scan (71x241x1):** Interpolated grid: dx=1.500 mm, dy=1.500 mm  
Maximum value of SAR (interpolated) = 0.935 W/kg

**Zoom Scan (5x5x7)/Cube 0:** Measurement grid: dx=8mm, dy=8mm, dz=5mm  
Reference Value = 31.55 V/m; Power Drift = -0.11 dB  
Peak SAR (extrapolated) = 1.86 W/kg  
**SAR(1 g) = 0.841 W/kg; SAR(10 g) = 0.409 W/kg** (SAR corrected for target medium)  
Smallest distance from peaks to all points 3 dB below = 11.8 mm  
Ratio of SAR at M2 to SAR at M1 = 49.5%  
Maximum value of SAR (measured) = 1.40 W/kg

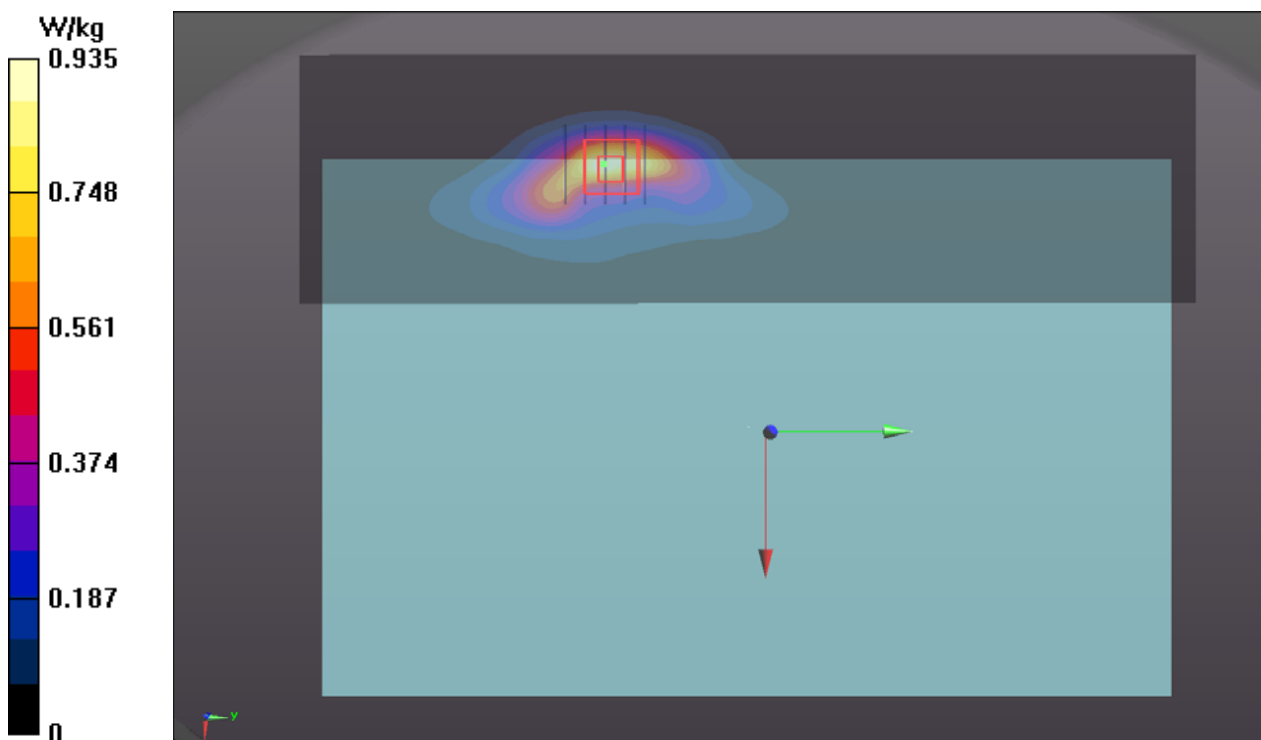



# P10 LTE 14\_QPSK10M\_Rear Face\_0mm\_Ch23330\_1RB\_OS0\_Sample 1\_Battery 4cell\_P-Sensor\_w

**DUT: BEDW-WTW-P20100106**

Communication System: UID 10175 - CAG, LTE-FDD (SC-FDMA, 1 RB, 10 MHz, QPSK);  
Frequency: 793 MHz; Duty Cycle: 1:3.74  
Medium: H06T09N1\_1128 Medium parameters used:  $f = 793$  MHz;  $\sigma = 0.929$  S/m;  $\epsilon_r = 42.944$ ;  $\rho = 1000$  kg/m<sup>3</sup>  
Ambient Temperature : 23.4 °C ; Liquid Temperature : 23.2 °C

DASY5 Configuration:

- Probe: EX3DV4 - SN3971; ConvF(10.6, 10.6, 10.6) @ 793 MHz; Calibrated: 2020/01/27
- Sensor-Surface: 1.4mm (Mechanical Surface Detection)
- Electronics: DAE4 Sn917; Calibrated: 2019/12/17
- Phantom: ELI Phantom\_1206; Type: QDOVA002AA;
- Measurement SW: DASY52, Version 52.10 (4); SEMCAD X Version 14.6.14 (7483)

**Area Scan (71x241x1):** Interpolated grid: dx=1.500 mm, dy=1.500 mm  
Maximum value of SAR (interpolated) = 1.09 W/kg

**Zoom Scan (5x5x7)/Cube 0:** Measurement grid: dx=8mm, dy=8mm, dz=5mm  
Reference Value = 33.41 V/m; Power Drift = -0.07 dB  
Peak SAR (extrapolated) = 2.10 W/kg  
**SAR(1 g) = 0.938 W/kg; SAR(10 g) = 0.457 W/kg** (SAR corrected for target medium)  
Smallest distance from peaks to all points 3 dB below = 12.8 mm  
Ratio of SAR at M2 to SAR at M1 = 50.2%  
Maximum value of SAR (measured) = 1.53 W/kg

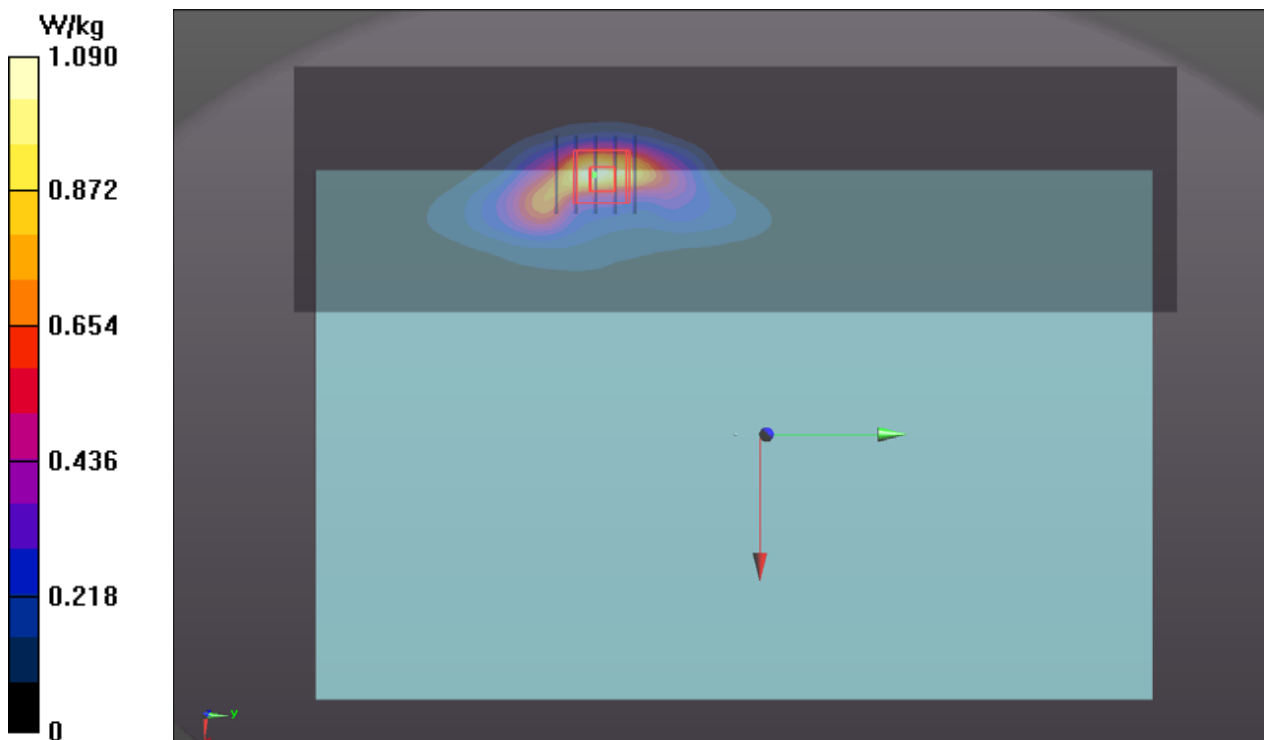

### P11 LTE 17\_QPSK10M\_Rear Face\_0mm\_Ch23780\_1RB\_OS0\_Sample 1\_Battery 4cell\_P-Sensor\_w

**DUT: BEDW-WTW-P20100106**

Communication System: UID 10175 - CAG, LTE-FDD (SC-FDMA, 1 RB, 10 MHz, QPSK);  
Frequency: 709 MHz; Duty Cycle: 1:3.74  
Medium: H06T09N1\_1128 Medium parameters used:  $f = 709$  MHz;  $\sigma = 0.849$  S/m;  $\epsilon_r = 44.006$ ;  $\rho = 1000$  kg/m<sup>3</sup>  
Ambient Temperature : 23.4 °C ; Liquid Temperature : 23.2 °C

DASY5 Configuration:

- Probe: EX3DV4 - SN3971; ConvF(10.6, 10.6, 10.6) @ 709 MHz; Calibrated: 2020/01/27
- Sensor-Surface: 1.4mm (Mechanical Surface Detection)
- Electronics: DAE4 Sn917; Calibrated: 2019/12/17
- Phantom: ELI Phantom\_1206; Type: QDOVA002AA;
- Measurement SW: DASY52, Version 52.10 (4); SEMCAD X Version 14.6.14 (7483)

**Area Scan (71x241x1):** Interpolated grid: dx=1.500 mm, dy=1.500 mm  
Maximum value of SAR (interpolated) = 1.06 W/kg

**Zoom Scan (5x5x7)/Cube 0:** Measurement grid: dx=8mm, dy=8mm, dz=5mm  
Reference Value = 33.41 V/m; Power Drift = -0.04 dB  
Peak SAR (extrapolated) = 1.98 W/kg  
**SAR(1 g) = 0.932 W/kg; SAR(10 g) = 0.447 W/kg** (SAR corrected for target medium)  
Smallest distance from peaks to all points 3 dB below = 12.8 mm  
Ratio of SAR at M2 to SAR at M1 = 49.1%  
Maximum value of SAR (measured) = 1.45 W/kg

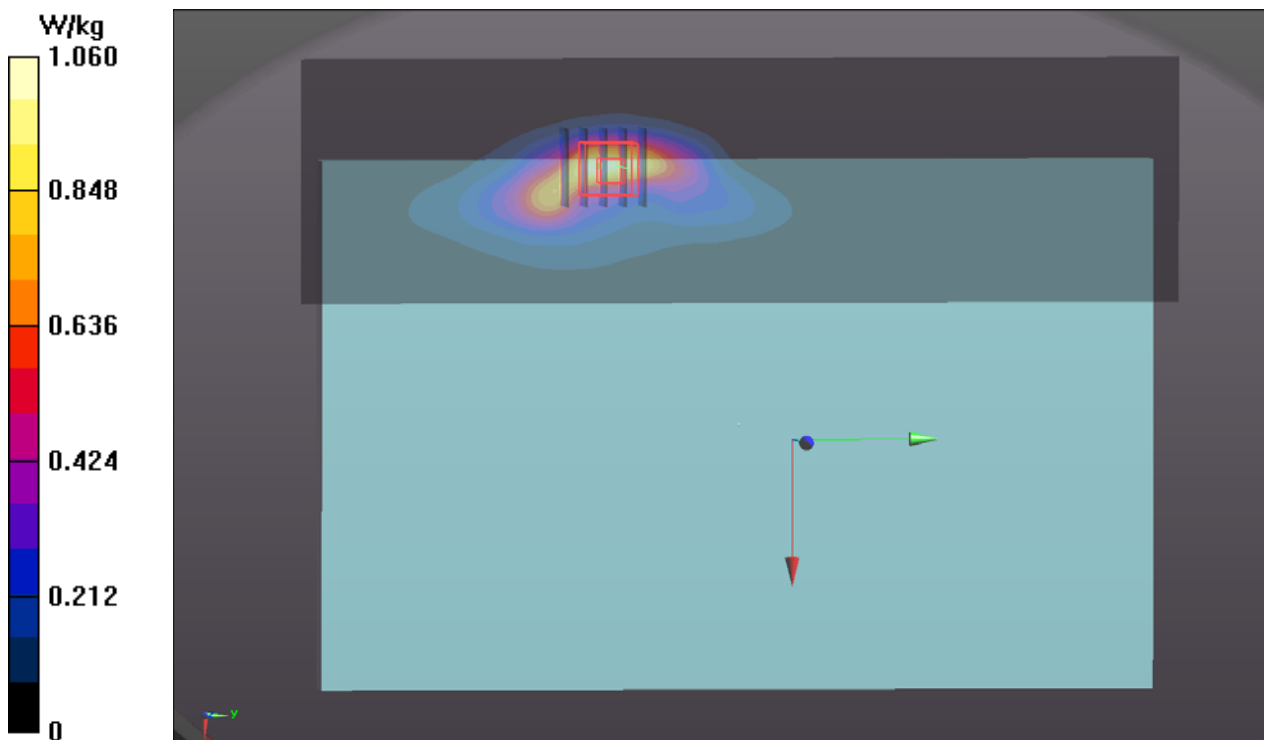

## **P12 LTE 25\_QPSK20M\_Rear Face\_0mm\_Ch26590\_1RB\_OS0\_Sample 1\_Battery 4cell\_P-Sensor\_w**

**DUT: BEDW-WTW-P20100106**

Communication System: UID 10169 - CAE, LTE-FDD (SC-FDMA, 1 RB, 20 MHz, QPSK);  
Frequency: 1905 MHz; Duty Cycle: 1:3.74

Medium: H16T20N2\_1129 Medium parameters used (interpolated):  $f = 1905$  MHz;  $\sigma = 1.46$  S/m;  $\epsilon_r = 40.885$ ;  $\rho = 1000$  kg/m<sup>3</sup>

Ambient Temperature : 23.6 °C ; Liquid Temperature : 23.4 °C

DASY5 Configuration:

- Probe: EX3DV4 - SN7555; ConvF(8.42, 8.42, 8.42) @ 1905 MHz; Calibrated: 2020/09/28
- Sensor-Surface: 1.4mm (Mechanical Surface Detection)
- Electronics: DAE4 Sn1589; Calibrated: 2020/09/15
- Phantom: ELI Phantom\_1039; Type: QDOVA;
- Measurement SW: DASY52, Version 52.10 (4); SEMCAD X Version 14.6.14 (7483)

**Area Scan (71x241x1):** Interpolated grid: dx=1.500 mm, dy=1.500 mm

Maximum value of SAR (interpolated) = 1.55 W/kg

**Zoom Scan (5x5x7)/Cube 0:** Measurement grid: dx=8mm, dy=8mm, dz=5mm

Reference Value = 24.13 V/m; Power Drift = -0.04 dB

Peak SAR (extrapolated) = 2.77 W/kg

**SAR(1 g) = 1.03 W/kg; SAR(10 g) = 0.414 W/kg** (SAR corrected for target medium)

Smallest distance from peaks to all points 3 dB below = 8.8 mm

Ratio of SAR at M2 to SAR at M1 = 37.1%

Maximum value of SAR (measured) = 2.13 W/kg

**Zoom Scan (5x5x7)/Cube 1:** Measurement grid: dx=8mm, dy=8mm, dz=5mm

Reference Value = 24.13 V/m; Power Drift = -0.04 dB

Peak SAR (extrapolated) = 1.72 W/kg

**SAR(1 g) = 0.682 W/kg; SAR(10 g) = 0.302 W/kg** (SAR corrected for target medium)

Smallest distance from peaks to all points 3 dB below = 9.3 mm

Ratio of SAR at M2 to SAR at M1 = 39.4%

Maximum value of SAR (measured) = 1.16 W/kg

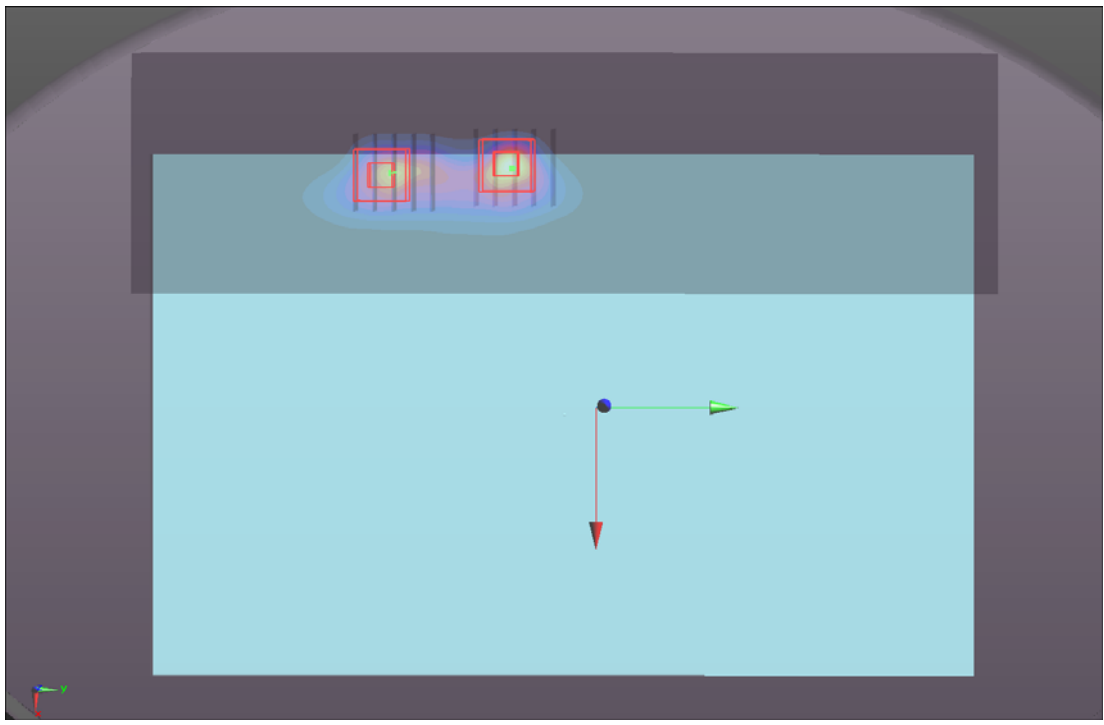
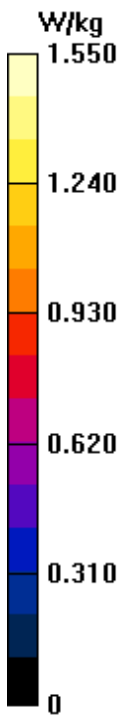

### P13 LTE 26\_QPSK15M\_Rear Face\_0mm\_Ch26765\_1RB\_OS0\_Sample 1\_Battery 4cell\_P-Sensor\_w

**DUT: BEDW-WTW-P20100106**

Communication System: UID 10181 - CAE, LTE-FDD (SC-FDMA, 1 RB, 15 MHz, QPSK);  
Frequency: 821.5 MHz; Duty Cycle: 1:3.74  
Medium: H07T10N1\_1129 Medium parameters used (interpolated):  $f = 821.5$  MHz;  $\sigma = 0.906$  S/m;  
 $\epsilon_r = 42.205$ ;  $\rho = 1000$  kg/m<sup>3</sup>  
Ambient Temperature : 23.6 °C ; Liquid Temperature : 23.4 °C

DASY5 Configuration:

- Probe: EX3DV4 - SN7555; ConvF(9.69, 9.69, 9.69) @ 821.5 MHz; Calibrated: 2020/09/28
- Sensor-Surface: 1.4mm (Mechanical Surface Detection)
- Electronics: DAE4 Sn1589; Calibrated: 2020/09/15
- Phantom: ELI Phantom\_1039; Type: QDOVA;
- Measurement SW: DASY52, Version 52.10 (4); SEMCAD X Version 14.6.14 (7483)

**Area Scan (71x241x1):** Interpolated grid: dx=1.500 mm, dy=1.500 mm  
Maximum value of SAR (interpolated) = 1.22 W/kg

**Zoom Scan (5x5x7)/Cube 0:** Measurement grid: dx=8mm, dy=8mm, dz=5mm  
Reference Value = 33.46 V/m; Power Drift = -0.03 dB  
Peak SAR (extrapolated) = 2.37 W/kg  
**SAR(1 g) = 0.936 W/kg; SAR(10 g) = 0.443 W/kg** (SAR corrected for target medium)  
Smallest distance from peaks to all points 3 dB below = 8.4 mm  
Ratio of SAR at M2 to SAR at M1 = 39.2%  
Maximum value of SAR (measured) = 1.83 W/kg

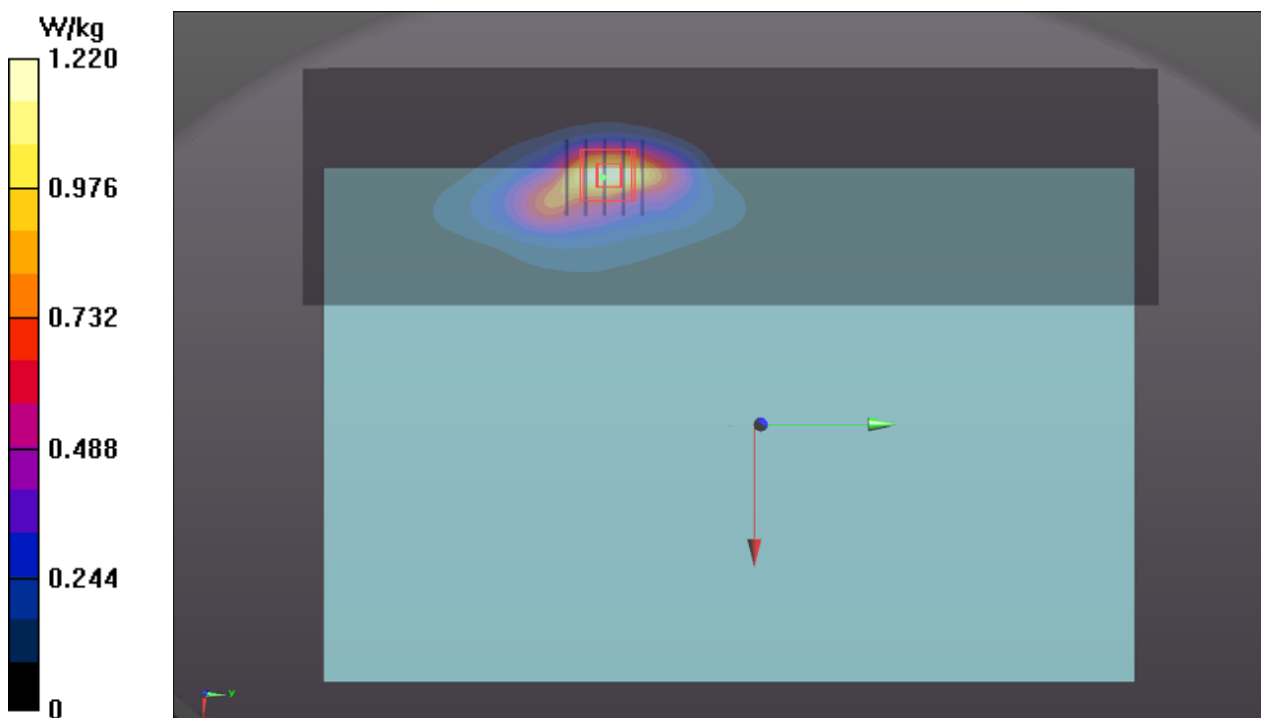

# P14 LTE 30\_QPSK10M\_Rear Face\_0mm\_Ch27710\_1RB\_OS0\_Sample 1\_Battery\_4cell

**DUT: BEDW-WTW-P20100106**

Communication System: UID 10175 - CAG, LTE-FDD (SC-FDMA, 1 RB, 10 MHz, QPSK);  
Frequency: 2310 MHz; Duty Cycle: 1:3.74

Medium: H19T27N1\_1119 Medium parameters used:  $f = 2310$  MHz;  $\sigma = 1.724$  S/m;  $\epsilon_r = 39.184$ ;  $\rho = 1000$  kg/m<sup>3</sup>

Ambient Temperature : 23.6 °C ; Liquid Temperature : 23.4 °C

DASY5 Configuration:

- Probe: EX3DV4 - SN3971; ConvF(8.06, 8.06, 8.06) @ 2310 MHz; Calibrated: 2020/01/27
- Sensor-Surface: 1.4mm (Mechanical Surface Detection)
- Electronics: DAE4 Sn917; Calibrated: 2019/12/17
- Phantom: ELI Phantom\_1206; Type: QDOVA002AA;
- Measurement SW: DASY52, Version 52.10 (4); SEMCAD X Version 14.6.14 (7483)

**Area Scan (71x301x1):** Interpolated grid: dx=1.200 mm, dy=1.200 mm  
Maximum value of SAR (interpolated) = 2.09 W/kg

**Zoom Scan (7x7x7)/Cube 0:** Measurement grid: dx=5mm, dy=5mm, dz=5mm

Reference Value = 35.88 V/m; Power Drift = 0.12 dB

Peak SAR (extrapolated) = 3.17 W/kg

**SAR(1 g) = 1.01 W/kg; SAR(10 g) = 0.454 W/kg** (SAR corrected for target medium)

Smallest distance from peaks to all points 3 dB below = 6.3 mm

Ratio of SAR at M2 to SAR at M1 = 39.1%

Maximum value of SAR (measured) = 2.32 W/kg

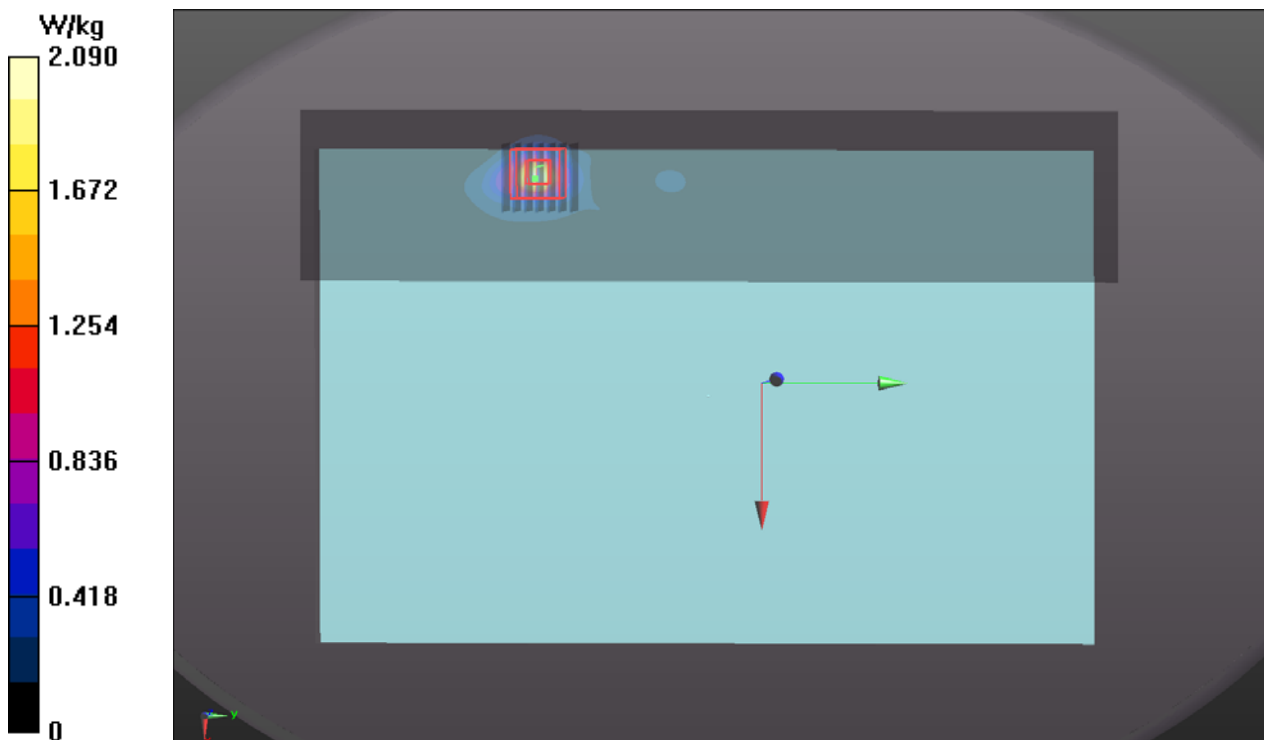

### P15 LTE 38\_QPSK20M\_Rear Face\_0mm\_Ch37850\_1RB\_OS0\_Sample 1\_Battery 4cell\_P-Sensor\_w

**DUT: BEDW-WTW-P20100106**

Communication System: UID 10172 - CAG, LTE-TDD (SC-FDMA, 1 RB, 20 MHz, QPSK);  
Frequency: 2580 MHz; Duty Cycle: 1:8.33

Medium: H19T27N1\_1117 Medium parameters used:  $f = 2580$  MHz;  $\sigma = 2.012$  S/m;  $\epsilon_r = 38.472$ ;  $\rho = 1000$  kg/m<sup>3</sup>

Ambient Temperature : 23.9 °C ; Liquid Temperature : 23.4 °C

DASY5 Configuration:

- Probe: EX3DV4 - SN3650; ConvF(7.56, 7.56, 7.56) @ 2580 MHz; Calibrated: 2020/03/25
- Sensor-Surface: 1.4mm (Mechanical Surface Detection)
- Electronics: DAE4 Sn861; Calibrated: 2020/05/27
- Phantom: ELI Phantom\_1043; Type: QDOVA;
- Measurement SW: DASY52, Version 52.10 (4); SEMCAD X Version 14.6.14 (7483)

**Area Scan (71x301x1):** Interpolated grid: dx=1.200 mm, dy=1.200 mm  
Maximum value of SAR (interpolated) = 1.80 W/kg

**Zoom Scan (7x7x7)/Cube 0:** Measurement grid: dx=5mm, dy=5mm, dz=5mm

Reference Value = 31.19 V/m; Power Drift = -0.10 dB

Peak SAR (extrapolated) = 2.77 W/kg

**SAR(1 g) = 1.04 W/kg; SAR(10 g) = 0.414 W/kg** (SAR corrected for target medium)

Smallest distance from peaks to all points 3 dB below = 7.2 mm

Ratio of SAR at M2 to SAR at M1 = 38.6%

Maximum value of SAR (measured) = 2.08 W/kg

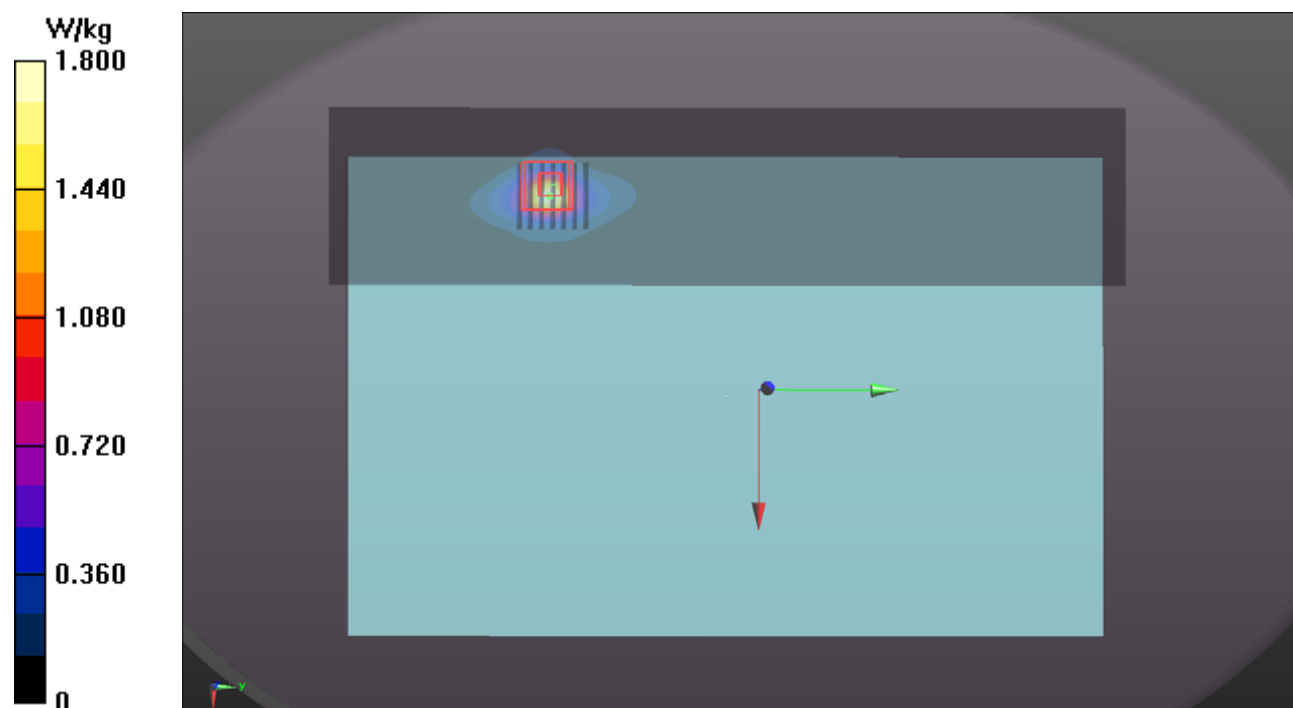

# P17 LTE 41\_QPSK20M\_Rear Face\_0mm\_Ch40185\_1RB\_OS0\_Sample 1\_Battery\_4cell\_P-Sensor\_w

**DUT: BEDW-WTW-P20100106**

Communication System: UID 10172 - CAG, LTE-TDD (SC-FDMA, 1 RB, 20 MHz, QPSK);  
Frequency: 2549.5 MHz; Duty Cycle: 1:8.33

Medium: H19T27N1\_1119 Medium parameters used:  $f = 2550$  MHz;  $\sigma = 1.976$  S/m;  $\epsilon_r = 38.334$ ;  $\rho = 1000$  kg/m<sup>3</sup>

Ambient Temperature : 23.6 °C ; Liquid Temperature : 23.4 °C

DASY5 Configuration:

- Probe: EX3DV4 - SN3971; ConvF(7.71, 7.71, 7.71) @ 2549.5 MHz; Calibrated: 2020/01/27
- Sensor-Surface: 1.4mm (Mechanical Surface Detection)
- Electronics: DAE4 Sn917; Calibrated: 2019/12/17
- Phantom: ELI Phantom\_1206; Type: QDOVA002AA;
- Measurement SW: DASY52, Version 52.10 (4); SEMCAD X Version 14.6.14 (7483)

**Area Scan (71x301x1):** Interpolated grid: dx=1.200 mm, dy=1.200 mm

Maximum value of SAR (interpolated) = 2.04 W/kg

**Zoom Scan (7x7x7)/Cube 0:** Measurement grid: dx=5mm, dy=5mm, dz=5mm

Reference Value = 31.57 V/m; Power Drift = -0.17 dB

Peak SAR (extrapolated) = 3.20 W/kg

**SAR(1 g) = 1.09 W/kg; SAR(10 g) = 0.409 W/kg** (SAR corrected for target medium)

Smallest distance from peaks to all points 3 dB below = 6.7 mm

Ratio of SAR at M2 to SAR at M1 = 37.3%

Maximum value of SAR (measured) = 2.22 W/kg

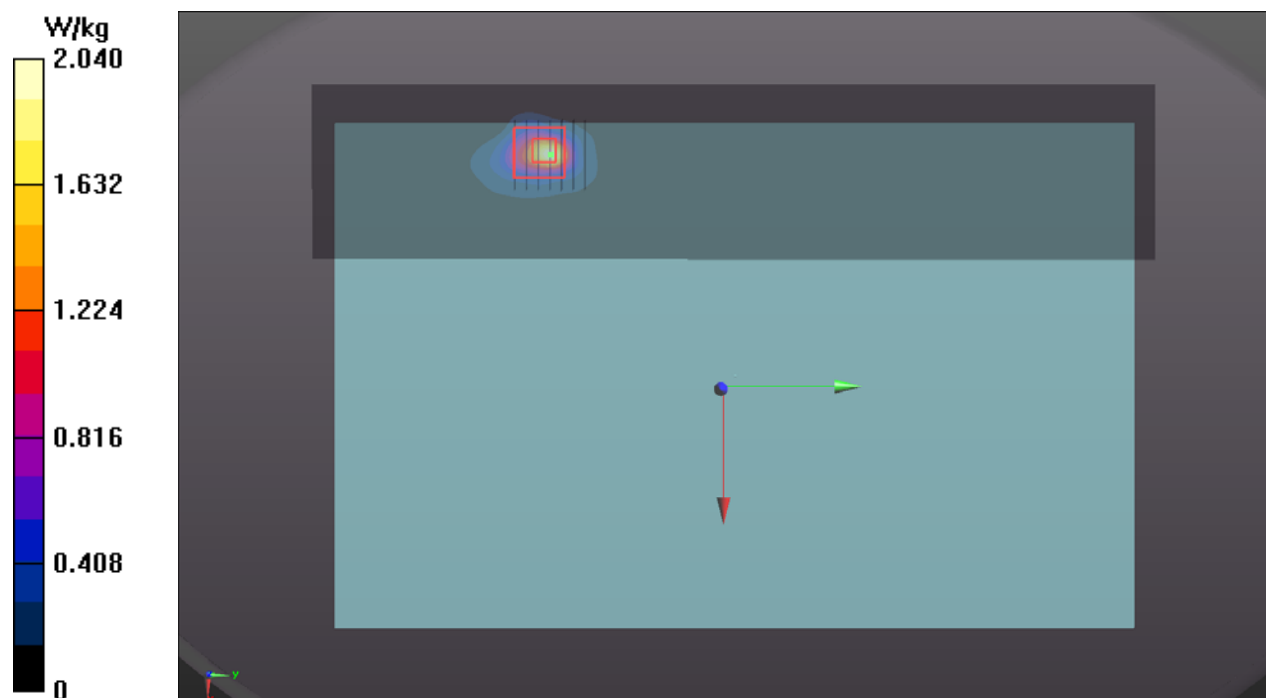



### P20 LTE 66\_QPSK20M\_Rear Face\_0mm\_Ch132572\_1RB\_OS0\_Sample 1\_Battery 4cell\_P-Sensor\_w

**DUT: BEDW-WTW-P20100106**

Communication System: UID 10169 - CAE, LTE-FDD (SC-FDMA, 1 RB, 20 MHz, QPSK);  
Frequency: 1770 MHz; Duty Cycle: 1:3.74

Medium: H16T20N2\_1129 Medium parameters used:  $f = 1770$  MHz;  $\sigma = 1.343$  S/m;  $\epsilon_r = 41.188$ ;  $\rho = 1000$  kg/m<sup>3</sup>

Ambient Temperature : 23.6 °C ; Liquid Temperature : 23.4 °C

DASY5 Configuration:

- Probe: EX3DV4 - SN7555; ConvF(8.6, 8.6, 8.6) @ 1770 MHz; Calibrated: 2020/09/28
- Sensor-Surface: 1.4mm (Mechanical Surface Detection)
- Electronics: DAE4 Sn1589; Calibrated: 2020/09/15
- Phantom: ELI Phantom\_1039; Type: QDOVA;
- Measurement SW: DASY52, Version 52.10 (4); SEMCAD X Version 14.6.14 (7483)

**Area Scan (71x241x1):** Interpolated grid: dx=1.500 mm, dy=1.500 mm

Maximum value of SAR (interpolated) = 1.32 W/kg

**Zoom Scan (5x5x7)/Cube 0:** Measurement grid: dx=8mm, dy=8mm, dz=5mm

Reference Value = 25.82 V/m; Power Drift = 0.05 dB

Peak SAR (extrapolated) = 2.11 W/kg

**SAR(1 g) = 0.846 W/kg; SAR(10 g) = 0.338 W/kg** (SAR corrected for target medium)

Smallest distance from peaks to all points 3 dB below = 8.8 mm

Ratio of SAR at M2 to SAR at M1 = 41%

Maximum value of SAR (measured) = 1.74 W/kg

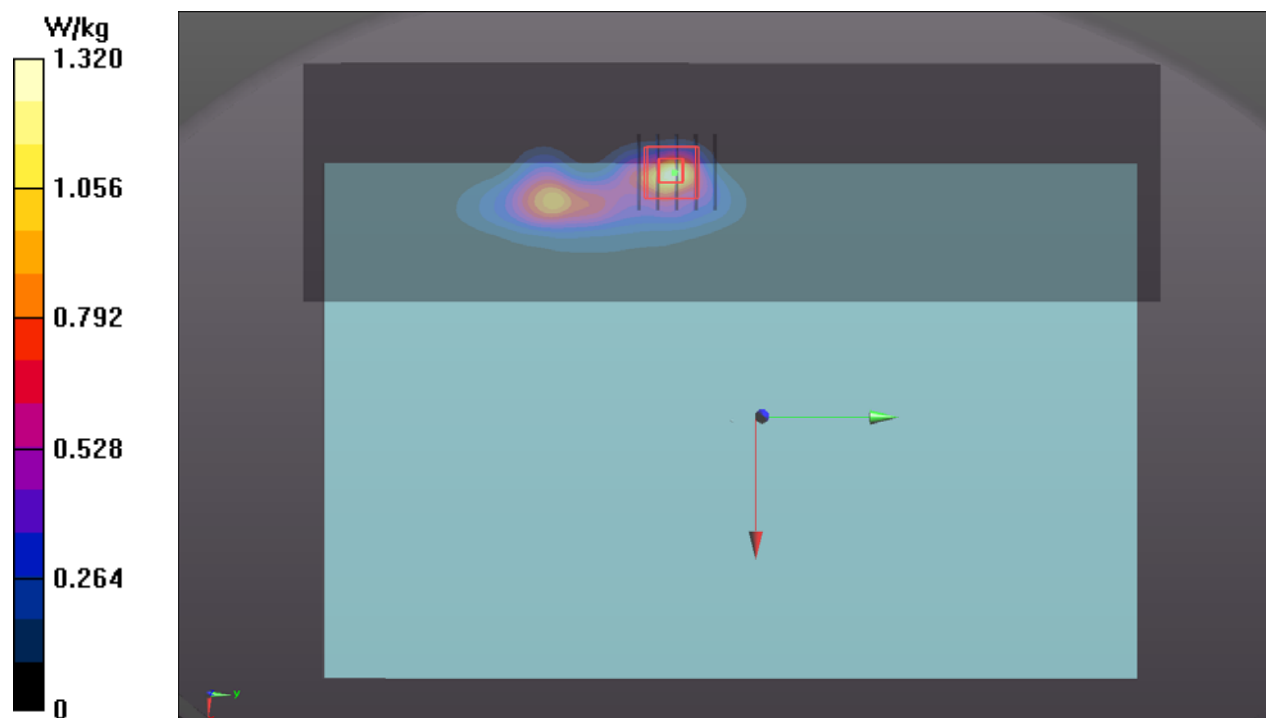

## P21 WLAN2.4G\_802.11b\_Rear Face\_0mm\_Ch6\_Sample 1\_Ant 1\_Battery 4cell

**DUT: BEDW-WTW-P20100106**

Communication System: UID 10012 - CAB, IEEE 802.11b WiFi 2.4 GHz (DSSS, 1 Mbps);

Frequency: 2437 MHz; Duty Cycle: 1:1

Medium: H19T27N1\_1118 Medium parameters used (interpolated):  $f = 2437$  MHz;  $\sigma = 1.861$  S/m;  $\epsilon_r = 38.033$ ;  $\rho = 1000$  kg/m<sup>3</sup>

Ambient Temperature : 23.9 °C ; Liquid Temperature : 23.4 °C

DASY5 Configuration:

- Probe: EX3DV4 - SN3650; ConvF(7.75, 7.75, 7.75) @ 2437 MHz; Calibrated: 2020/03/25
- Sensor-Surface: 1.4mm (Mechanical Surface Detection)
- Electronics: DAE4 Sn861; Calibrated: 2020/05/27
- Phantom: ELI Phantom\_1043; Type: QDOVA;
- Measurement SW: DASY52, Version 52.10 (4); SEMCAD X Version 14.6.14 (7483)

**Area Scan (71x301x1):** Interpolated grid: dx=1.200 mm, dy=1.200 mm

Maximum value of SAR (interpolated) = 1.04 W/kg

**Zoom Scan (7x7x7)/Cube 0:** Measurement grid: dx=5mm, dy=5mm, dz=5mm

Reference Value = 22.08 V/m; Power Drift = -0.07 dB

Peak SAR (extrapolated) = 1.14 W/kg

**SAR(1 g) = 0.524 W/kg; SAR(10 g) = 0.271 W/kg** (SAR corrected for target medium)

Smallest distance from peaks to all points 3 dB below = 6.3 mm

Ratio of SAR at M2 to SAR at M1 = 44.6%

Maximum value of SAR (measured) = 0.872 W/kg

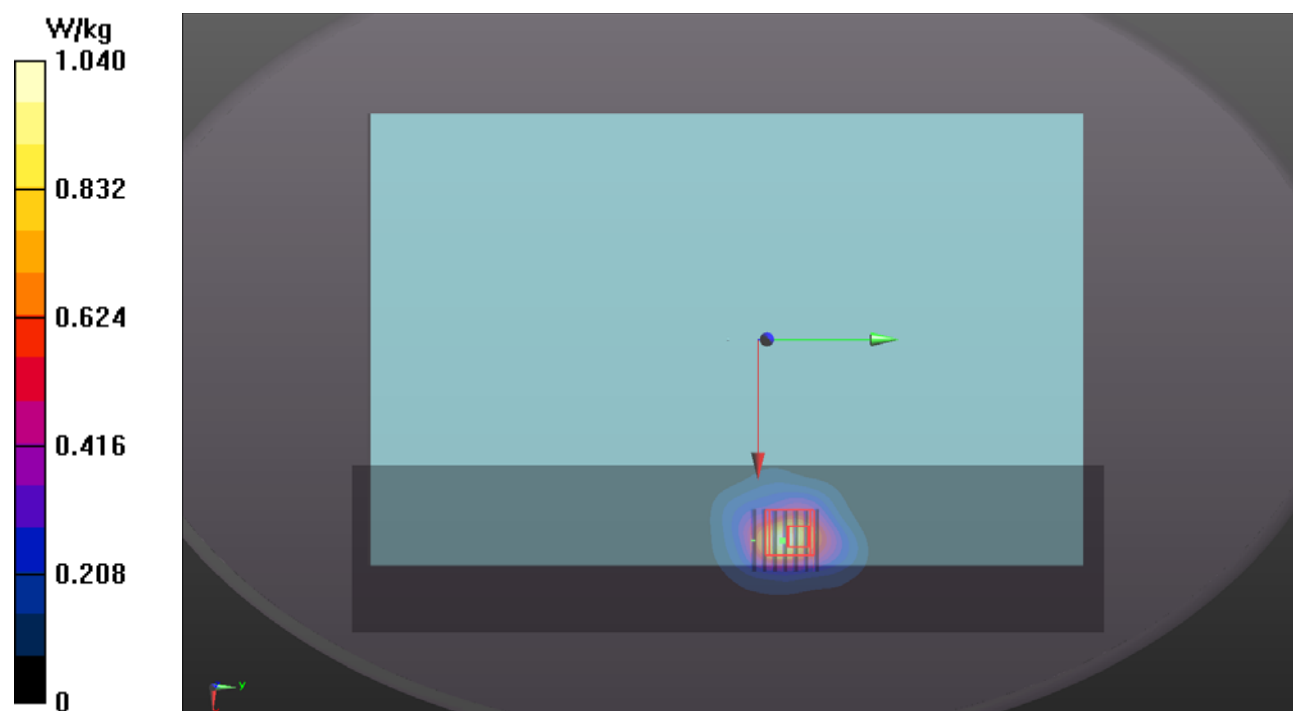

## P22 WLAN5.2G\_802.11ac VHT80\_Top Side\_0mm\_Ch42\_Sample 1\_Ant 1\_Battery 4cell

### DUT: BEDW-WTW-P20100106

Communication System: UID 10544 - AAC, IEEE 802.11ac WiFi (80MHz, MCS0); Frequency: 5210 MHz; Duty Cycle: 1:1.03  
Medium: H34T60N1\_1118 Medium parameters used (interpolated):  $f = 5210 \text{ MHz}$ ;  $\sigma = 4.673 \text{ S/m}$ ;  $\epsilon_r = 36.165$ ;  $\rho = 1000 \text{ kg/m}^3$   
Ambient Temperature :  $23.9 \text{ }^\circ\text{C}$  ; Liquid Temperature :  $23.4 \text{ }^\circ\text{C}$

### DASY5 Configuration:

- Probe: EX3DV4 - SN3650; ConvF(5.39, 5.39, 5.39) @ 5210 MHz; Calibrated: 2020/03/25
- Sensor-Surface: 1.4mm (Mechanical Surface Detection)
- Electronics: DAE4 Sn861; Calibrated: 2020/05/27
- Phantom: ELI Phantom\_1043; Type: QDOVA;
- Measurement SW: DASY52, Version 52.10 (4); SEMCAD X Version 14.6.14 (7483)

**Area Scan (81x361x1):** Interpolated grid:  $dx=1.000 \text{ mm}$ ,  $dy=1.000 \text{ mm}$   
Maximum value of SAR (interpolated) =  $1.65 \text{ W/kg}$

**Zoom Scan (7x7x7)/Cube 0:** Measurement grid:  $dx=4\text{mm}$ ,  $dy=4\text{mm}$ ,  $dz=1.4\text{mm}$   
Reference Value =  $20.45 \text{ V/m}$ ; Power Drift =  $0.02 \text{ dB}$   
Peak SAR (extrapolated) =  $3.75 \text{ W/kg}$   
**SAR(1 g) =  $1.06 \text{ W/kg}$ ; SAR(10 g) =  $0.299 \text{ W/kg}$**  (SAR corrected for target medium)  
Smallest distance from peaks to all points 3 dB below =  $5.6 \text{ mm}$   
Ratio of SAR at M2 to SAR at M1 =  $68.4\%$   
Maximum value of SAR (measured) =  $2.46 \text{ W/kg}$

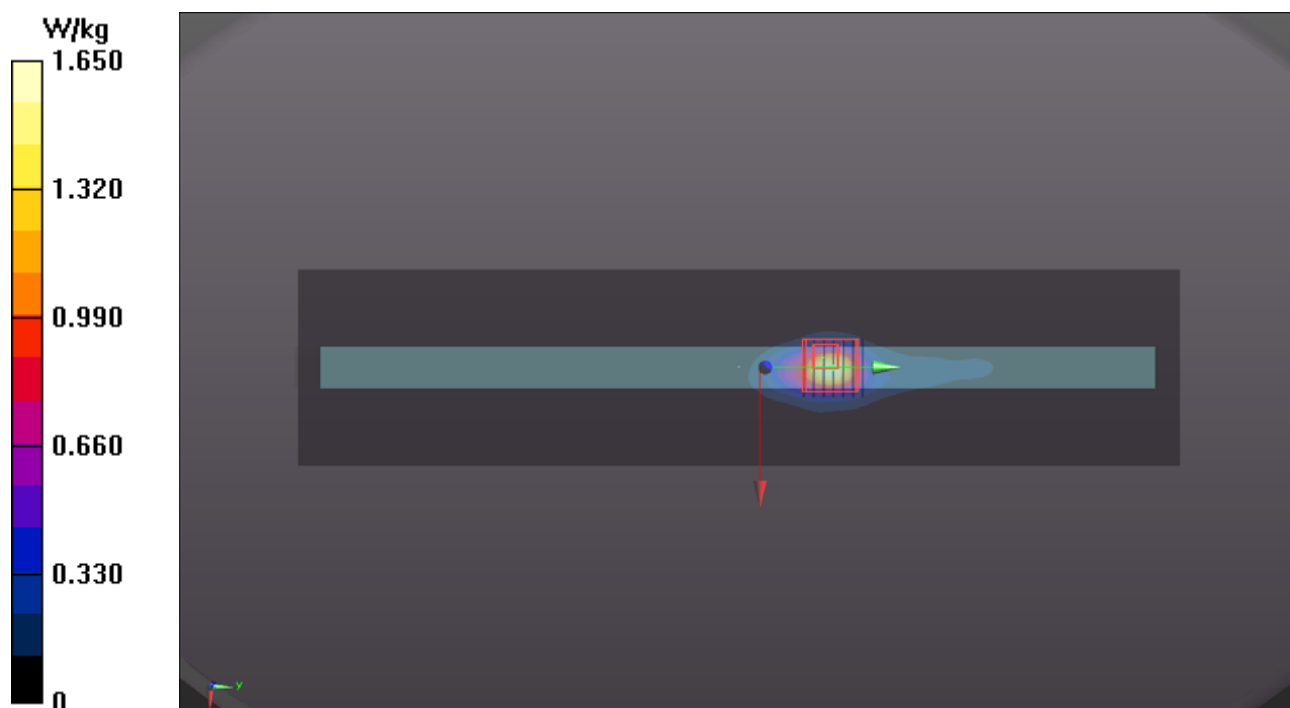

## P23 WLAN5.6G\_802.11ac VHT160\_Top Side\_0mm\_Ch114\_Sample 1\_Ant 0\_Battery 4cell

**DUT: BEDW-WTW-P20100106**

Communication System: UID 10554 - AAD, IEEE 802.11ac WiFi (160MHz, MCS0); Frequency: 5570 MHz; Duty Cycle: 1:1.03

Medium: H34T60N1\_1118 Medium parameters used (interpolated):  $f = 5570$  MHz;  $\sigma = 5.015$  S/m;  $\epsilon_r = 35.63$ ;  $\rho = 1000$  kg/m<sup>3</sup>

Ambient Temperature : 23.9 °C; Liquid Temperature : 23.4 °C

DASY5 Configuration:

- Probe: EX3DV4 - SN3650; ConvF(4.88, 4.88, 4.88) @ 5570 MHz; Calibrated: 2020/03/25
- Sensor-Surface: 1.4mm (Mechanical Surface Detection)
- Electronics: DAE4 Sn861; Calibrated: 2020/05/27
- Phantom: ELI Phantom\_1043; Type: QDOVA;
- Measurement SW: DASY52, Version 52.10 (4); SEMCAD X Version 14.6.14 (7483)

**Area Scan (81x361x1):** Interpolated grid: dx=1.000 mm, dy=1.000 mm

Maximum value of SAR (interpolated) = 1.37 W/kg

**Zoom Scan (7x7x7)/Cube 0:** Measurement grid: dx=4mm, dy=4mm, dz=1.4mm

Reference Value = 16.63 V/m; Power Drift = 0.05 dB

Peak SAR (extrapolated) = 2.98 W/kg

**SAR(1 g) = 0.732 W/kg; SAR(10 g) = 0.206 W/kg** (SAR corrected for target medium)

Smallest distance from peaks to all points 3 dB below = 5.6 mm

Ratio of SAR at M2 to SAR at M1 = 64.5%

Maximum value of SAR (measured) = 1.70 W/kg

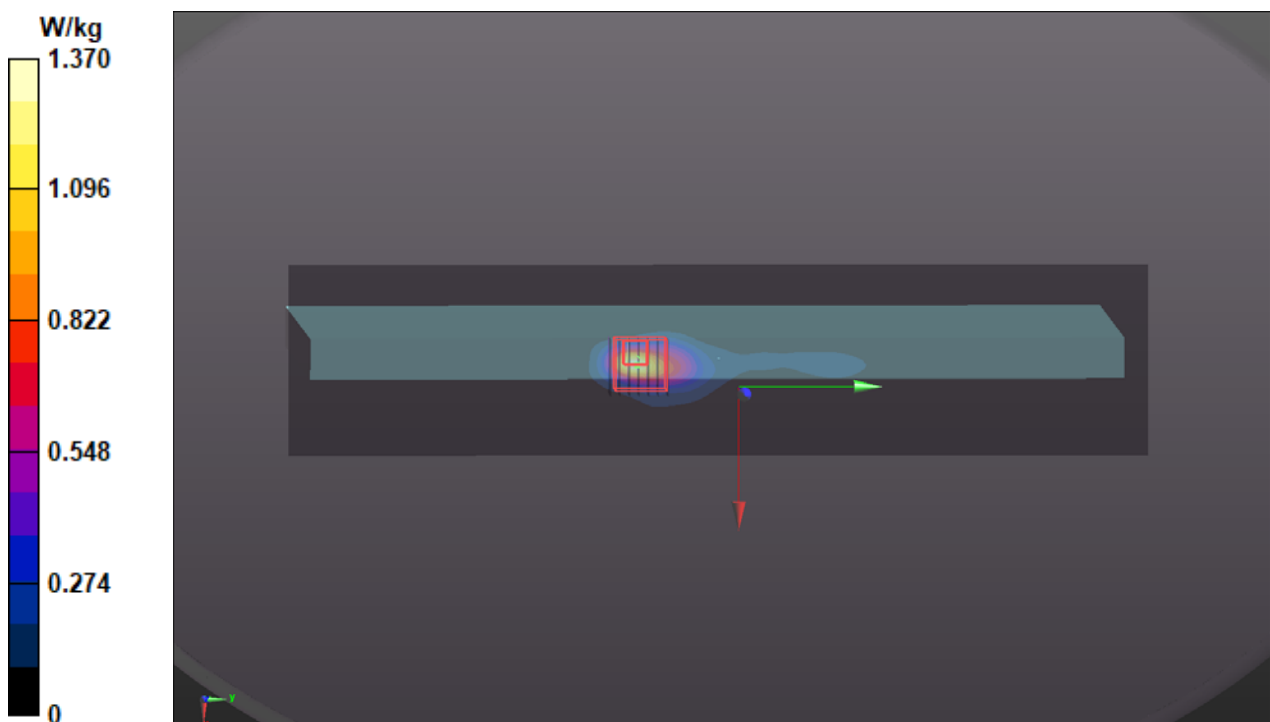

## P24 WLAN5.8G\_802.11ac VHT80\_Top Side\_0mm\_Ch155\_Sample 1\_Ant 0+1\_Battery 4cell

**DUT: BEDW-WTW-P20100106**

Communication System: UID 10544 - AAC, IEEE 802.11ac WiFi (80MHz, MCS0); Frequency: 5775 MHz; Duty Cycle: 1:1.03

Medium: H34T60N1\_1118 Medium parameters used:  $f = 5775$  MHz;  $\sigma = 5.213$  S/m;  $\epsilon_r = 35.365$ ;  $\rho = 1000$  kg/m<sup>3</sup>

Ambient Temperature : 23.9 °C ; Liquid Temperature : 23.4 °C

DASY5 Configuration:

- Probe: EX3DV4 - SN3650; ConvF(5.1, 5.1, 5.1) @ 5775 MHz; Calibrated: 2020/03/25
- Sensor-Surface: 1.4mm (Mechanical Surface Detection)
- Electronics: DAE4 Sn861; Calibrated: 2020/05/27
- Phantom: ELI Phantom\_1043; Type: QDOVA;
- Measurement SW: DASY52, Version 52.10 (4); SEMCAD X Version 14.6.14 (7483)

**Area Scan (81x361x1):** Interpolated grid: dx=1.000 mm, dy=1.000 mm

Maximum value of SAR (interpolated) = 1.24 W/kg

**Zoom Scan (7x7x7)/Cube 0:** Measurement grid: dx=4mm, dy=4mm, dz=1.4mm

Reference Value = 15.56 V/m; Power Drift = 0.10 dB

Peak SAR (extrapolated) = 2.52 W/kg

**SAR(1 g) = 0.587 W/kg; SAR(10 g) = 0.158 W/kg** (SAR corrected for target medium)

Smallest distance from peaks to all points 3 dB below = 6.1 mm

Ratio of SAR at M2 to SAR at M1 = 63%

Maximum value of SAR (measured) = 1.45 W/kg

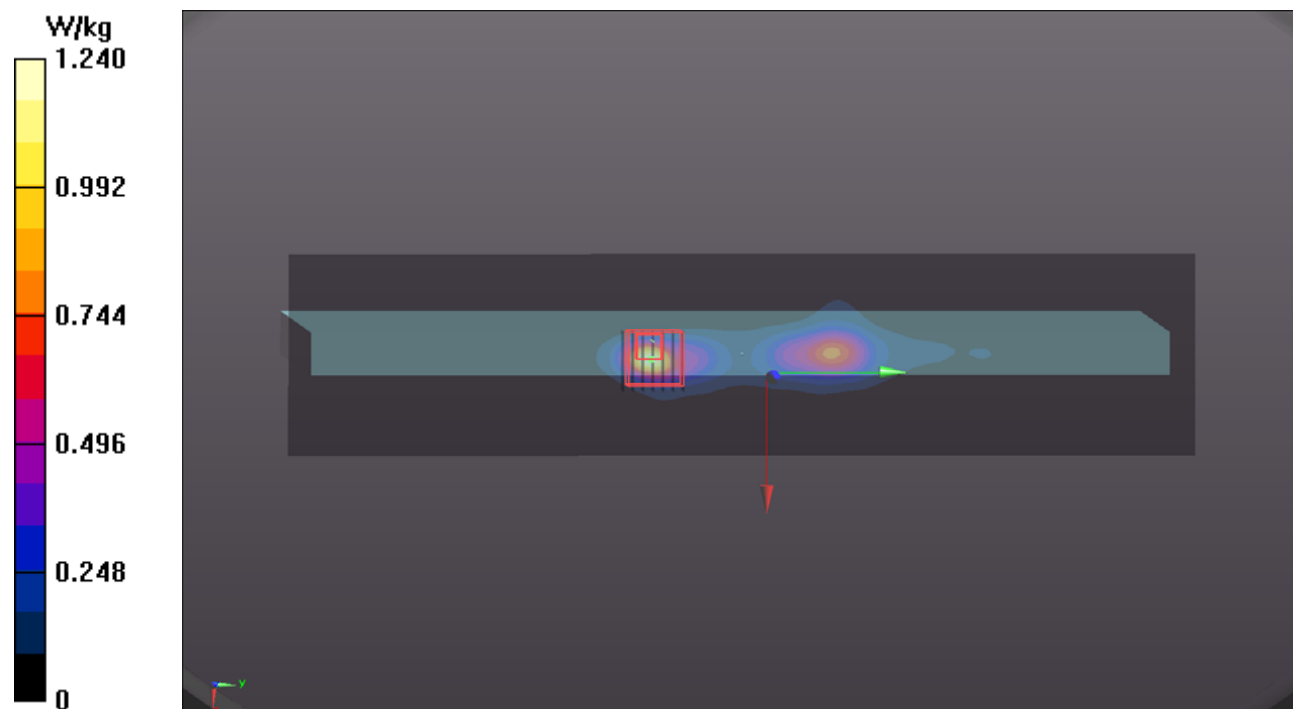

## P25 BT\_BDR\_Top Side\_0mm\_Ch0\_Sample 1\_Ant 1\_Battery 4cell

**DUT: BEDW-WTW-P20100106**

Communication System: UID 10032 - CAA, IEEE 802.15.1 Bluetooth (GFSK, DH5); Frequency: 2402 MHz; Duty Cycle: 1:1.3

Medium: H19T27N1\_1118 Medium parameters used (interpolated):  $f = 2402$  MHz;  $\sigma = 1.828$  S/m;  $\epsilon_r = 38.178$ ;  $\rho = 1000$  kg/m<sup>3</sup>

Ambient Temperature : 23.9 °C ; Liquid Temperature : 23.4 °C

DASY5 Configuration:

- Probe: EX3DV4 - SN3650; ConvF(7.75, 7.75, 7.75) @ 2402 MHz; Calibrated: 2020/03/25
- Sensor-Surface: 1.4mm (Mechanical Surface Detection)
- Electronics: DAE4 Sn861; Calibrated: 2020/05/27
- Phantom: ELI Phantom\_1043; Type: QDOVA;
- Measurement SW: DASY52, Version 52.10 (4); SEMCAD X Version 14.6.14 (7483)

**Area Scan (81x361x1):** Interpolated grid: dx=1.000 mm, dy=1.000 mm

Maximum value of SAR (interpolated) = 0.125 W/kg

**Zoom Scan (7x7x7)/Cube 0:** Measurement grid: dx=4mm, dy=4mm, dz=1.4mm

Reference Value = 7.809 V/m; Power Drift = 0.13 dB

Peak SAR (extrapolated) = 0.148 W/kg

**SAR(1 g) = 0.063 W/kg; SAR(10 g) = 0.027 W/kg** (SAR corrected for target medium)

Smallest distance from peaks to all points 3 dB below = 7.6 mm

Ratio of SAR at M2 to SAR at M1 = 79.7%

Maximum value of SAR (measured) = 0.114 W/kg

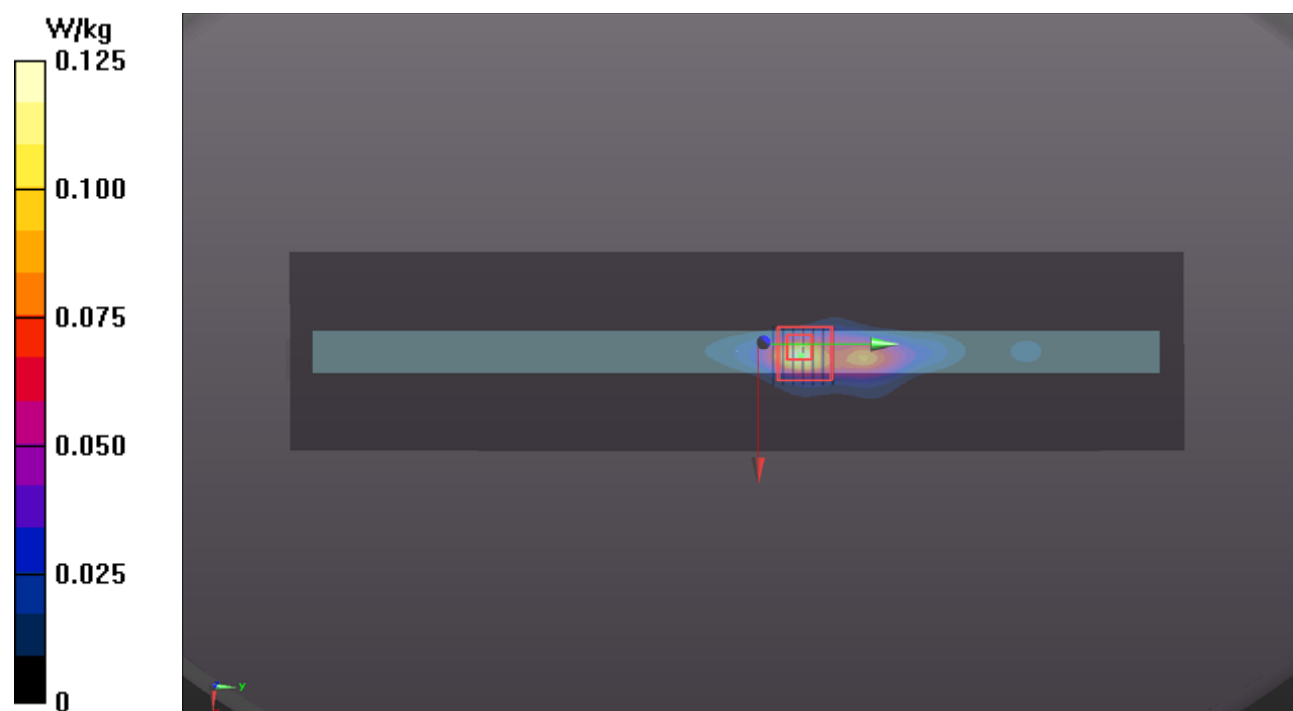

## P26 WCDMA II\_RMC12.2K\_Bottom\_0mm\_Ch9538\_Sample 1\_Battery 4cell\_P-Sensor\_w

**DUT: BEDW-WTW-P20100106**

Communication System: UID 10011 - CAB, UMTS-FDD (WCDMA); Frequency: 1907.6 MHz; Duty Cycle: 1:1.95

Medium: H16T20N1\_1123 Medium parameters used:  $f = 1908$  MHz;  $\sigma = 1.466$  S/m;  $\epsilon_r = 39.706$ ;  $\rho = 1000$  kg/m<sup>3</sup>

Ambient Temperature : 23.3 °C ; Liquid Temperature : 23.2°C

DASY5 Configuration:

- Probe: EX3DV4 - SN3971; ConvF(8.54, 8.54, 8.54) @ 1907.6 MHz; Calibrated: 2020/01/27
- Sensor-Surface: 1.4mm (Mechanical Surface Detection)
- Electronics: DAE4 Sn917; Calibrated: 2019/12/17
- Phantom: ELI Phantom\_1206; Type: QDOVA002AA;
- Measurement SW: DASY52, Version 52.10 (4); SEMCAD X Version 14.6.14 (7483)

**Area Scan (61x241x1):** Interpolated grid: dx=1.500 mm, dy=1.500 mm

Maximum value of SAR (interpolated) = 1.69 W/kg

**Zoom Scan (5x5x7)/Cube 0:** Measurement grid: dx=8mm, dy=8mm, dz=5mm

Reference Value = 31.64 V/m; Power Drift = 0.06 dB

Peak SAR (extrapolated) = 1.96 W/kg

**SAR(1 g) = 0.881 W/kg; SAR(10 g) = 0.423 W/kg** (SAR corrected for target medium)

Smallest distance from peaks to all points 3 dB below = 8.4 mm

Ratio of SAR at M2 to SAR at M1 = 48.3%

Maximum value of SAR (measured) = 1.65 W/kg

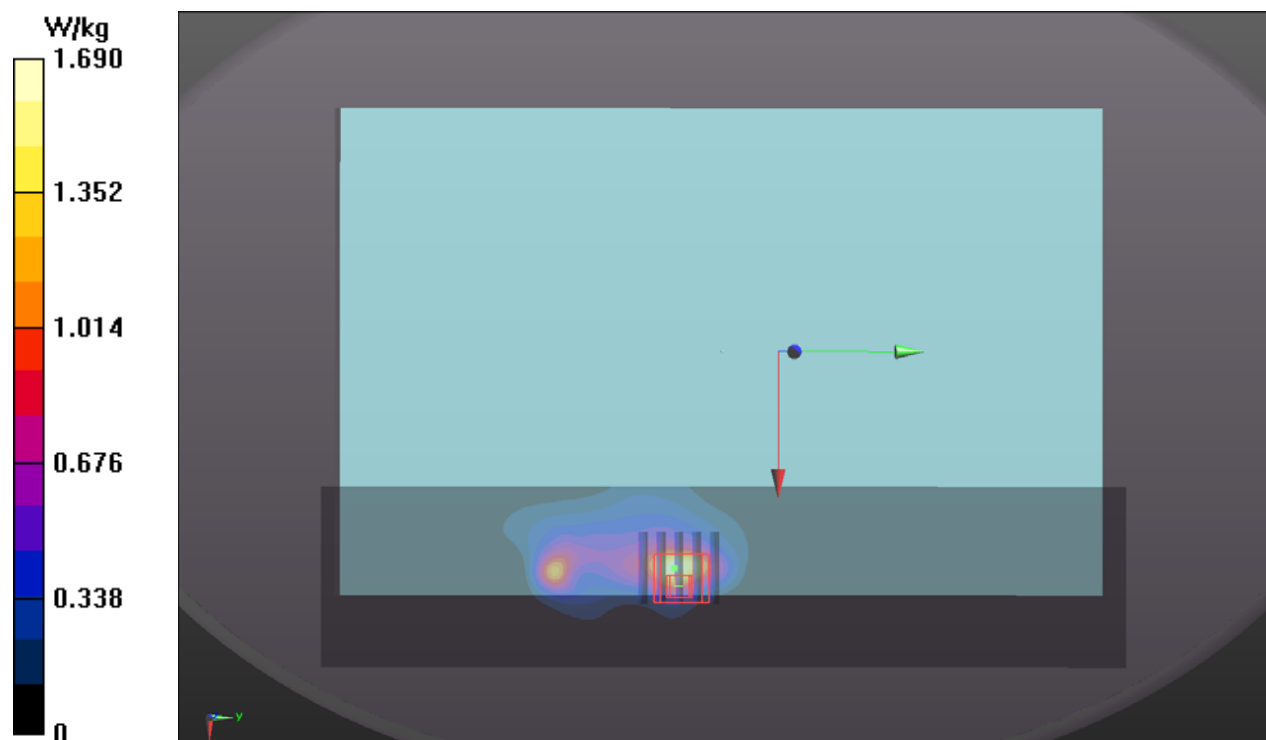

## P27 WCDMA IV\_RMC12.2K\_Bottom\_0mm\_Ch1513\_Sample 1\_Battery 4cell\_P-Sensor\_w

**DUT: BEDW-WTW-P20100106**

Communication System: UID 10011 - CAB, UMTS-FDD (WCDMA); Frequency: 1752.6 MHz; Duty Cycle: 1:1.95

Medium: H16T20N1\_1123 Medium parameters used:  $f = 1753$  MHz;  $\sigma = 1.321$  S/m;  $\epsilon_r = 40.256$ ;  $\rho = 1000$  kg/m<sup>3</sup>

Ambient Temperature : 23.3 °C ; Liquid Temperature : 23.2 °C

DASY5 Configuration:

- Probe: EX3DV4 - SN3971; ConvF(8.73, 8.73, 8.73) @ 1752.6 MHz; Calibrated: 2020/01/27
- Sensor-Surface: 1.4mm (Mechanical Surface Detection)
- Electronics: DAE4 Sn917; Calibrated: 2019/12/17
- Phantom: ELI Phantom\_1206; Type: QDOVA002AA;
- Measurement SW: DASY52, Version 52.10 (4); SEMCAD X Version 14.6.14 (7483)

**Area Scan (61x241x1):** Interpolated grid: dx=1.500 mm, dy=1.500 mm

Maximum value of SAR (interpolated) = 1.44 W/kg

**Zoom Scan (5x5x7)/Cube 0:** Measurement grid: dx=8mm, dy=8mm, dz=5mm

Reference Value = 31.36 V/m; Power Drift = -0.14 dB

Peak SAR (extrapolated) = 1.97 W/kg

**SAR(1 g) = 0.970 W/kg; SAR(10 g) = 0.451 W/kg** (SAR corrected for target medium)

Smallest distance from peaks to all points 3 dB below = 8.4 mm

Ratio of SAR at M2 to SAR at M1 = 49.9%

Maximum value of SAR (measured) = 1.68 W/kg

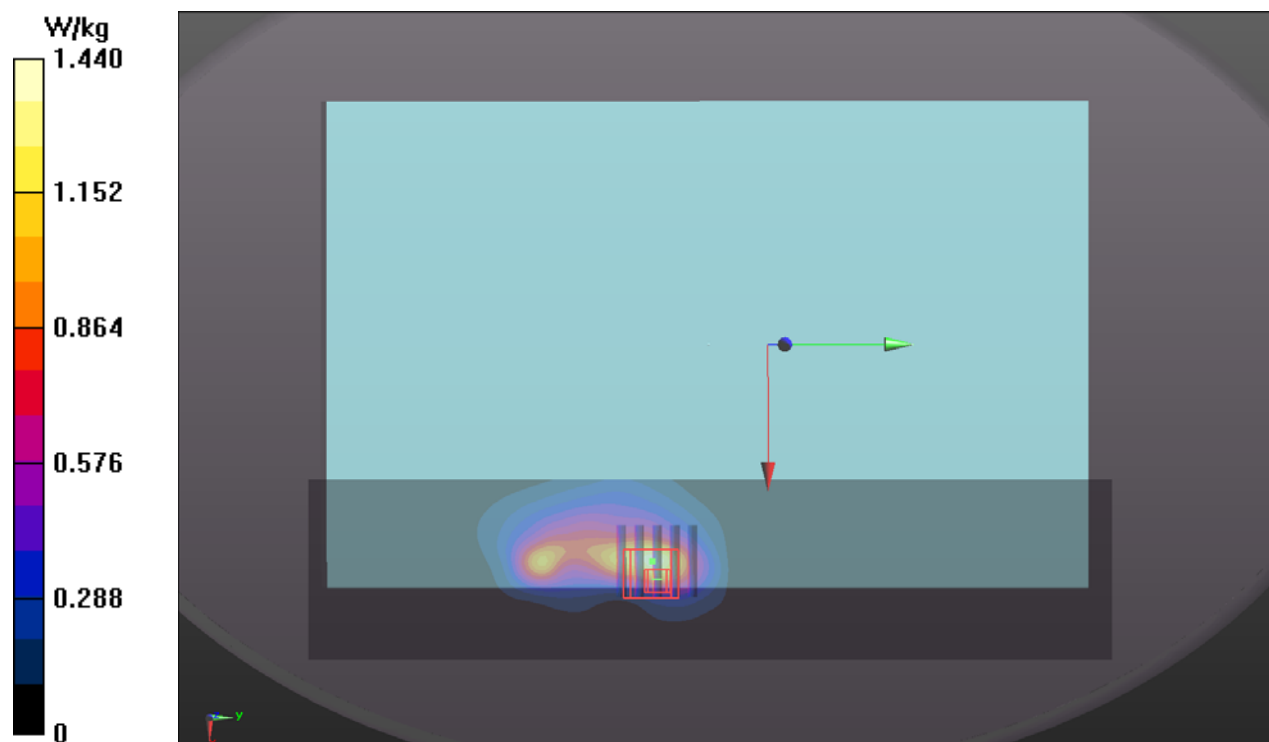



## P28 WCDMA V\_RMC12.2K\_Bottom\_0mm\_Ch4233\_Sample 1\_Battery 4cell\_P-Sensor\_w

**DUT: BEDW-WTW-P20100106**

Communication System: UID 10011 - CAB, UMTS-FDD (WCDMA); Frequency: 846.6 MHz; Duty Cycle: 1:1.95

Medium: H07T10N1\_1122 Medium parameters used:  $f = 847$  MHz;  $\sigma = 0.932$  S/m;  $\epsilon_r = 41.787$ ;  $\rho = 1000$  kg/m<sup>3</sup>

Ambient Temperature : 23.8 °C ; Liquid Temperature : 23.6 °C

DASY5 Configuration:

- Probe: EX3DV4 - SN3971; ConvF(10.26, 10.26, 10.26) @ 846.6 MHz; Calibrated: 2020/01/27
- Sensor-Surface: 1.4mm (Mechanical Surface Detection)
- Electronics: DAE4 Sn917; Calibrated: 2019/12/17
- Phantom: ELI Phantom\_1206; Type: QDOVA002AA;
- Measurement SW: DASY52, Version 52.10 (4); SEMCAD X Version 14.6.14 (7483)

**Area Scan (61x241x1):** Interpolated grid: dx=1.500 mm, dy=1.500 mm

Maximum value of SAR (interpolated) = 1.49 W/kg

**Zoom Scan (5x5x7)/Cube 0:** Measurement grid: dx=8mm, dy=8mm, dz=5mm

Reference Value = 36.34 V/m; Power Drift = -0.02 dB

Peak SAR (extrapolated) = 1.96 W/kg

**SAR(1 g) = 1.04 W/kg; SAR(10 g) = 0.564 W/kg** (SAR corrected for target medium)

Smallest distance from peaks to all points 3 dB below = 11.5 mm

Ratio of SAR at M2 to SAR at M1 = 53.9%

Maximum value of SAR (measured) = 1.65 W/kg

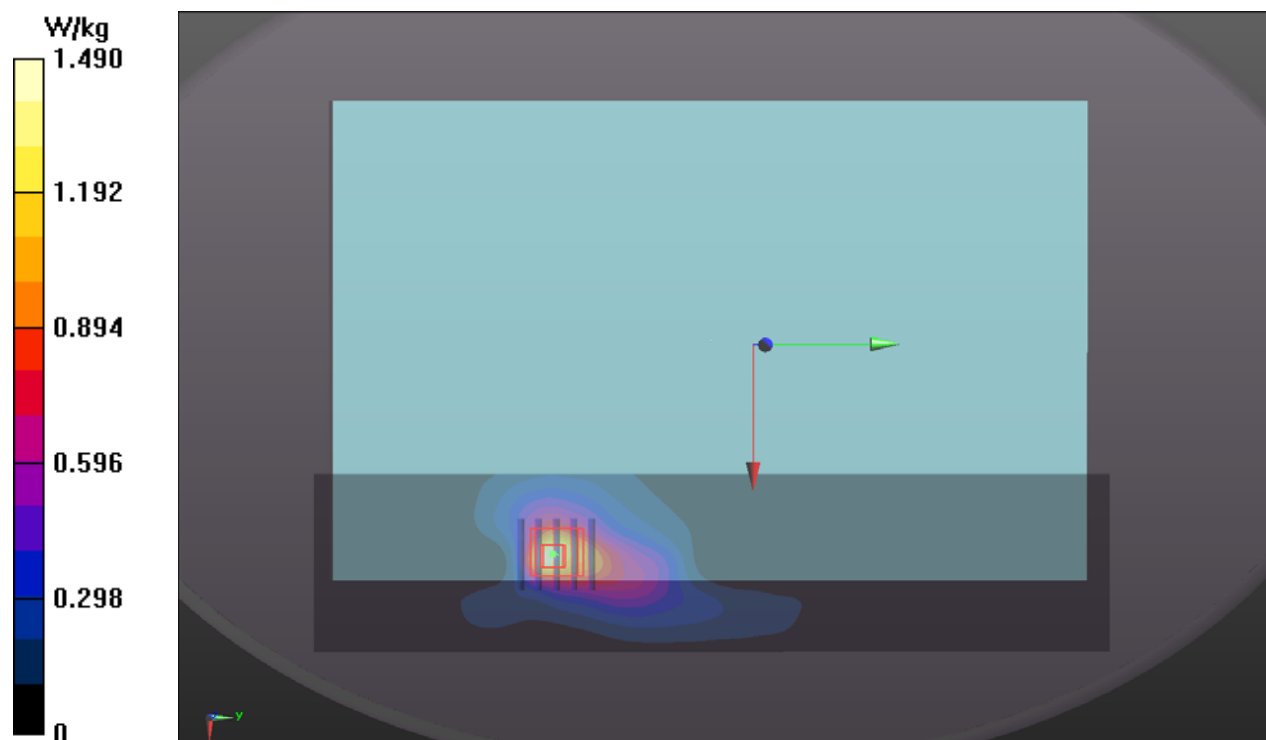

### P29 LTE 2\_QPSK20M\_Bottom\_0mm\_Ch19100\_1RB\_OS0\_Sample 1\_Battery 4cell\_P-Sensor\_w

**DUT: BEDW-WTW-P20100106**

Communication System: UID 10169 - CAE, LTE-FDD (SC-FDMA, 1 RB, 20 MHz, QPSK);  
Frequency: 1900 MHz; Duty Cycle: 1:3.74

Medium: H16T20N1\_1123 Medium parameters used:  $f = 1900$  MHz;  $\sigma = 1.456$  S/m;  $\epsilon_r = 39.753$ ;  $\rho = 1000$  kg/m<sup>3</sup>

Ambient Temperature : 23.3 °C ; Liquid Temperature : 23.2 °C

DASY5 Configuration:

- Probe: EX3DV4 - SN3971; ConvF(8.54, 8.54, 8.54) @ 1900 MHz; Calibrated: 2020/01/27
- Sensor-Surface: 1.4mm (Mechanical Surface Detection)
- Electronics: DAE4 Sn917; Calibrated: 2019/12/17
- Phantom: ELI Phantom\_1206; Type: QDOVA002AA;
- Measurement SW: DASY52, Version 52.10 (4); SEMCAD X Version 14.6.14 (7483)

**Area Scan (61x241x1):** Interpolated grid: dx=1.500 mm, dy=1.500 mm

Maximum value of SAR (interpolated) = 1.63 W/kg

**Zoom Scan (5x5x7)/Cube 0:** Measurement grid: dx=8mm, dy=8mm, dz=5mm

Reference Value = 34.01 V/m; Power Drift = -0.11 dB

Peak SAR (extrapolated) = 1.82 W/kg

**SAR(1 g) = 0.838 W/kg; SAR(10 g) = 0.419 W/kg** (SAR corrected for target medium)

Smallest distance from peaks to all points 3 dB below = 8.2 mm

Ratio of SAR at M2 to SAR at M1 = 50.9%

Maximum value of SAR (measured) = 1.47 W/kg

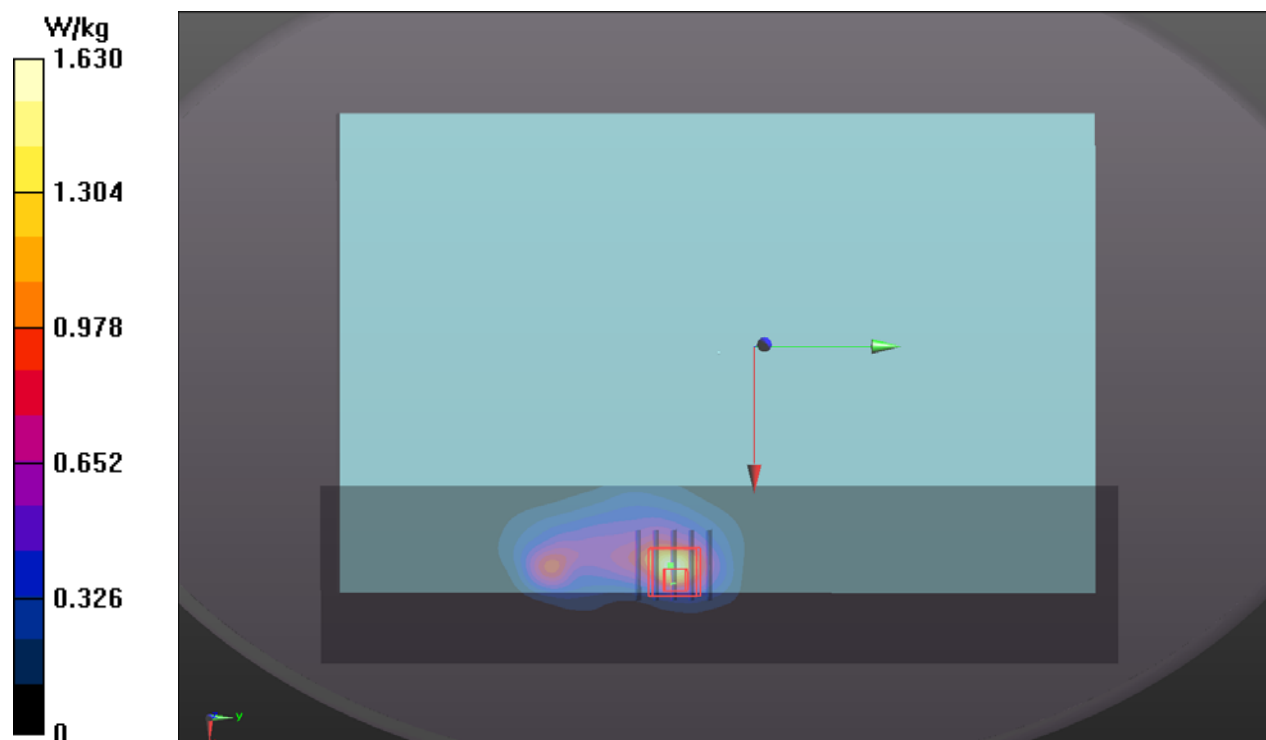

### P30 LTE 4\_QPSK20M\_Bottom\_0mm\_Ch20175\_1RB\_OS0\_Sample 1\_Battery 4cell\_P-Sensor\_w

**DUT: BEDW-WTW-P20100106**

Communication System: UID 10169 - CAE, LTE-FDD (SC-FDMA, 1 RB, 20 MHz, QPSK);  
Frequency: 1732.5 MHz; Duty Cycle: 1:3.74

Medium: H16T20N1\_1124 Medium parameters used:  $f = 1733$  MHz;  $\sigma = 1.304$  S/m;  $\epsilon_r = 39.075$ ;  $\rho = 1000$  kg/m<sup>3</sup>

Ambient Temperature : 23.7 °C ; Liquid Temperature : 23.5 °C

DASY5 Configuration:

- Probe: EX3DV4 - SN3971; ConvF(8.73, 8.73, 8.73) @ 1732.5 MHz; Calibrated: 2020/01/27
- Sensor-Surface: 1.4mm (Mechanical Surface Detection)
- Electronics: DAE4 Sn917; Calibrated: 2019/12/17
- Phantom: ELI Phantom\_1206; Type: QDOVA002AA;
- Measurement SW: DASY52, Version 52.10 (4); SEMCAD X Version 14.6.14 (7483)

**Area Scan (61x241x1):** Interpolated grid: dx=1.500 mm, dy=1.500 mm

Maximum value of SAR (interpolated) = 1.73 W/kg

**Zoom Scan (5x5x7)/Cube 0:** Measurement grid: dx=8mm, dy=8mm, dz=5mm

Reference Value = 34.66 V/m; Power Drift = -0.09 dB

Peak SAR (extrapolated) = 1.97 W/kg

**SAR(1 g) = 0.964 W/kg; SAR(10 g) = 0.464 W/kg** (SAR corrected for target medium)

Smallest distance from peaks to all points 3 dB below = 8.4 mm

Ratio of SAR at M2 to SAR at M1 = 51.3%

Maximum value of SAR (measured) = 1.67 W/kg

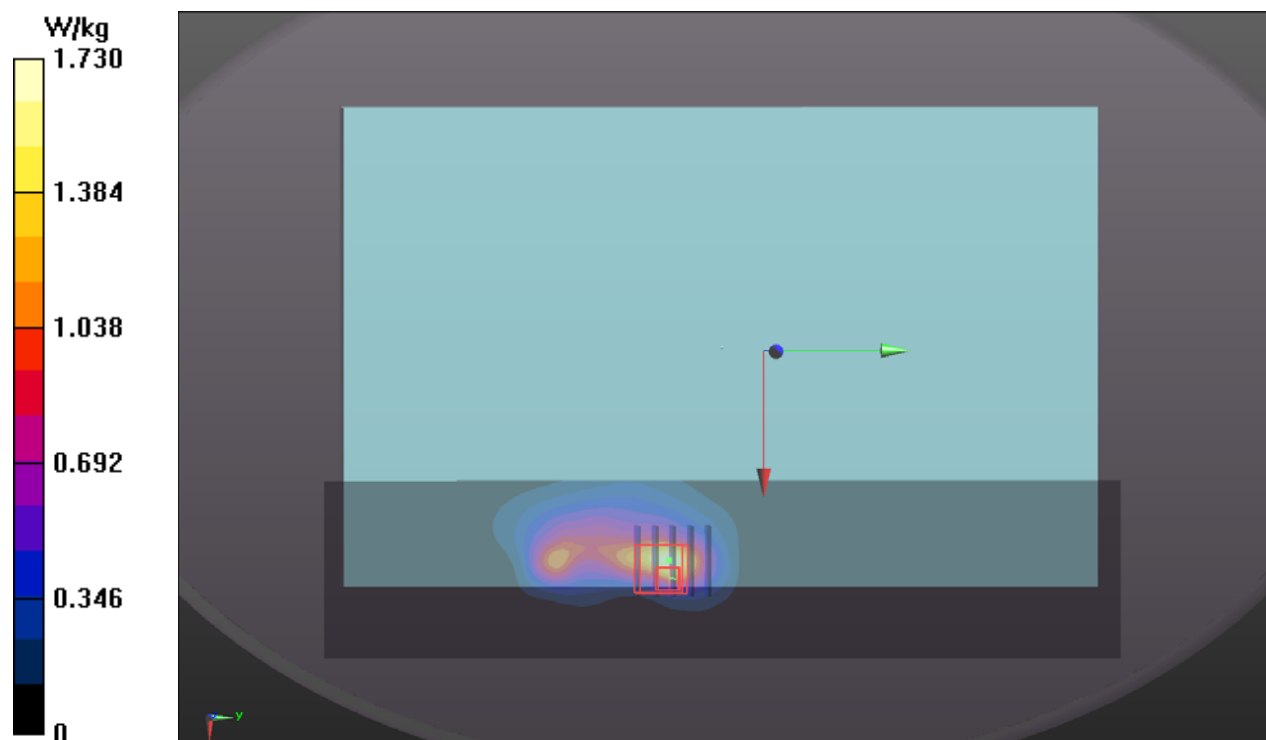

### P31 LTE 5\_QPSK10M\_Bottom\_0mm\_Ch20450\_1RB\_OS0\_Sample 1\_Battery 4cell\_P-Sensor\_w

**DUT: BEDW-WTW-P20100106**

Communication System: UID 10175 - CAG, LTE-FDD (SC-FDMA, 1 RB, 10 MHz, QPSK);  
Frequency: 829 MHz; Duty Cycle: 1:3.74  
Medium: H07T10N1\_1122 Medium parameters used:  $f = 829$  MHz;  $\sigma = 0.916$  S/m;  $\epsilon_r = 42.007$ ;  $\rho = 1000$  kg/m<sup>3</sup>  
Ambient Temperature : 23.8 °C ; Liquid Temperature : 23.6 °C

DASY5 Configuration:

- Probe: EX3DV4 - SN3971; ConvF(10.26, 10.26, 10.26) @ 829 MHz; Calibrated: 2020/01/27
- Sensor-Surface: 1.4mm (Mechanical Surface Detection)
- Electronics: DAE4 Sn917; Calibrated: 2019/12/17
- Phantom: ELI Phantom\_1206; Type: QDOVA002AA;
- Measurement SW: DASY52, Version 52.10 (4); SEMCAD X Version 14.6.14 (7483)

**Area Scan (61x241x1):** Interpolated grid: dx=1.500 mm, dy=1.500 mm  
Maximum value of SAR (interpolated) = 1.61 W/kg

**Zoom Scan (5x5x7)/Cube 0:** Measurement grid: dx=8mm, dy=8mm, dz=5mm  
Reference Value = 39.67 V/m; Power Drift = 0.03 dB  
Peak SAR (extrapolated) = 2.17 W/kg  
**SAR(1 g) = 1.01 W/kg; SAR(10 g) = 0.609 W/kg** (SAR corrected for target medium)  
Smallest distance from peaks to all points 3 dB below = 11.5 mm  
Ratio of SAR at M2 to SAR at M1 = 53.7%  
Maximum value of SAR (measured) = 1.81 W/kg

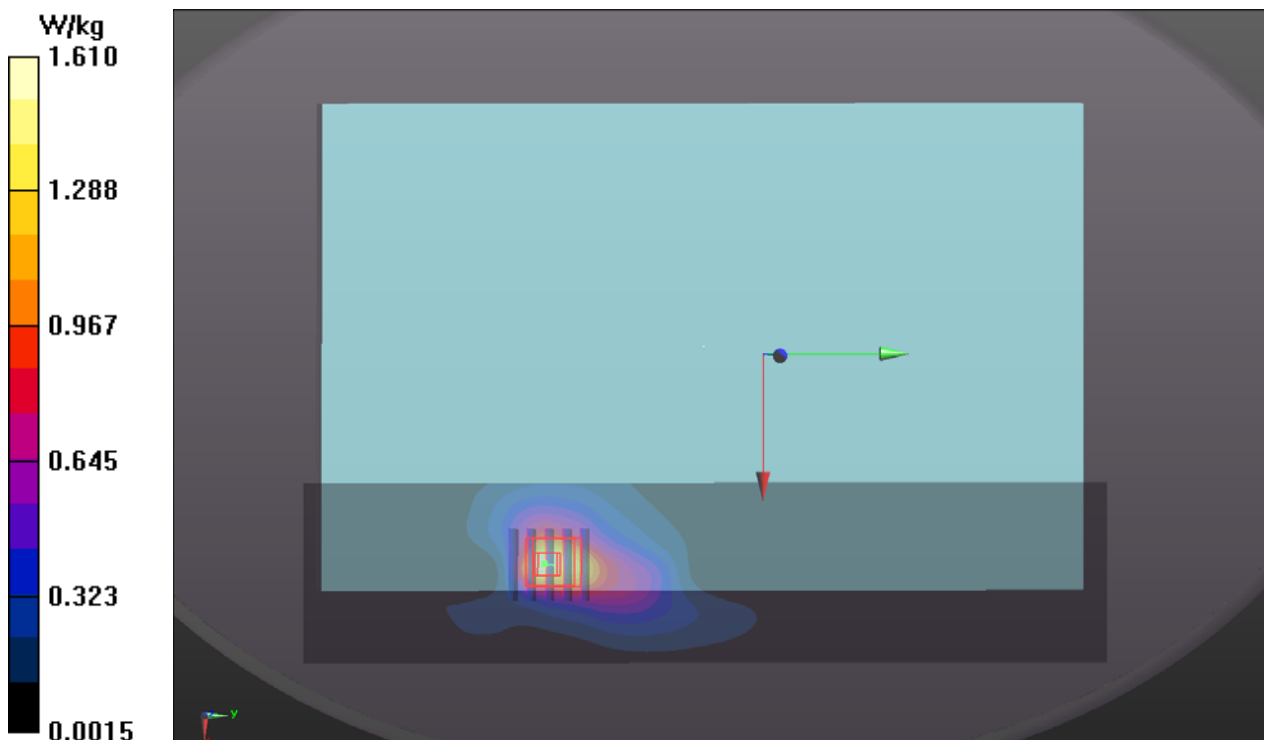

### P32 LTE 7\_QPSK20M\_Bottom\_0mm\_Ch20850\_1RB\_OS0\_Sample 1\_Battery 4cell\_P-Sensor\_w

**DUT: BEDW-WTW-P20100106**

Communication System: UID 10169 - CAE, LTE-FDD (SC-FDMA, 1 RB, 20 MHz, QPSK);  
Frequency: 2510 MHz; Duty Cycle: 1:3.74

Medium: H19T27N1\_1122 Medium parameters used:  $f = 2510$  MHz;  $\sigma = 1.949$  S/m;  $\epsilon_r = 38.136$ ;  $\rho = 1000$  kg/m<sup>3</sup>

Ambient Temperature : 23.8 °C ; Liquid Temperature : 23.6 °C

DASY5 Configuration:

- Probe: EX3DV4 - SN3971; ConvF(7.71, 7.71, 7.71) @ 2510 MHz; Calibrated: 2020/01/27
- Sensor-Surface: 1.4mm (Mechanical Surface Detection)
- Electronics: DAE4 Sn917; Calibrated: 2019/12/17
- Phantom: ELI Phantom\_1206; Type: QDOVA002AA;
- Measurement SW: DASY52, Version 52.10 (4); SEMCAD X Version 14.6.14 (7483)

**Area Scan (71x301x1):** Interpolated grid: dx=1.200 mm, dy=1.200 mm

Maximum value of SAR (interpolated) = 1.54 W/kg

**Zoom Scan (7x7x7)/Cube 0:** Measurement grid: dx=5mm, dy=5mm, dz=5mm

Reference Value = 25.82 V/m; Power Drift = -0.02 dB

Peak SAR (extrapolated) = 2.32 W/kg

**SAR(1 g) = 0.926 W/kg; SAR(10 g) = 0.425 W/kg** (SAR corrected for target medium)

Smallest distance from peaks to all points 3 dB below = 8.1 mm

Ratio of SAR at M2 to SAR at M1 = 40.7%

Maximum value of SAR (measured) = 1.73 W/kg

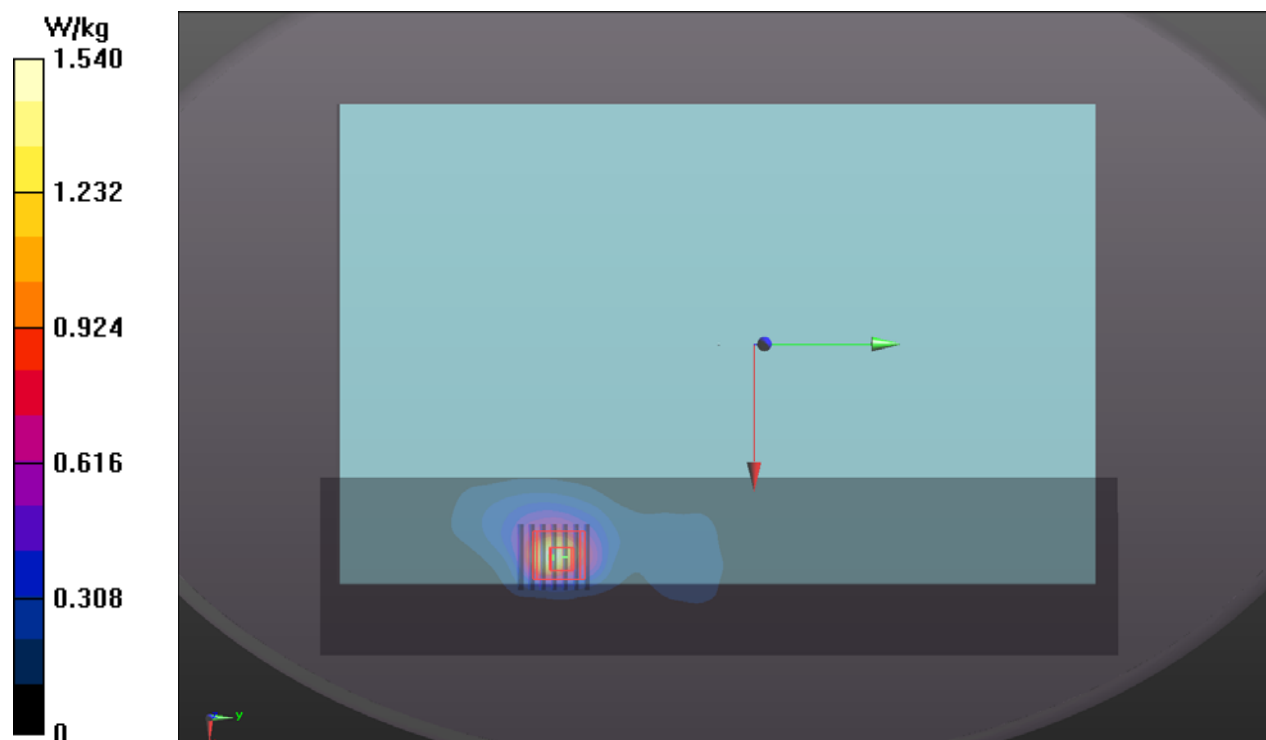

### P33 LTE 12\_QPSK10M\_Bottom\_0mm\_Ch23095\_1RB\_OS0\_Sample 1\_Battery 4cell\_P-Sensor\_w

**DUT: BEDW-WTW-P20100106**

Communication System: UID 10175 - CAG, LTE-FDD (SC-FDMA, 1 RB, 10 MHz, QPSK);  
Frequency: 707.5 MHz; Duty Cycle: 1:3.74  
Medium: H06T09N1\_1121 Medium parameters used (interpolated):  $f = 707.5$  MHz;  $\sigma = 0.854$  S/m;  
 $\epsilon_r = 42.95$ ;  $\rho = 1000$  kg/m<sup>3</sup>  
Ambient Temperature : 23.3 °C ; Liquid Temperature : 23 °C

DASY5 Configuration:

- Probe: EX3DV4 - SN3971; ConvF(10.6, 10.6, 10.6) @ 707.5 MHz; Calibrated: 2020/01/27
- Sensor-Surface: 1.4mm (Mechanical Surface Detection)
- Electronics: DAE4 Sn917; Calibrated: 2019/12/17
- Phantom: ELI Phantom\_1206; Type: QDOVA002AA;
- Measurement SW: DASY52, Version 52.10 (4); SEMCAD X Version 14.6.14 (7483)

**Area Scan (61x241x1):** Interpolated grid: dx=1.500 mm, dy=1.500 mm  
Maximum value of SAR (interpolated) = 1.17 W/kg

**Zoom Scan (5x5x7)/Cube 0:** Measurement grid: dx=8mm, dy=8mm, dz=5mm  
Reference Value = 36.73 V/m; Power Drift = -0.14 dB  
Peak SAR (extrapolated) = 1.93 W/kg  
**SAR(1 g) = 1.01 W/kg; SAR(10 g) = 0.601 W/kg** (SAR corrected for target medium)  
Smallest distance from peaks to all points 3 dB below = 10.1 mm  
Ratio of SAR at M2 to SAR at M1 = 57.1%  
Maximum value of SAR (measured) = 1.51 W/kg

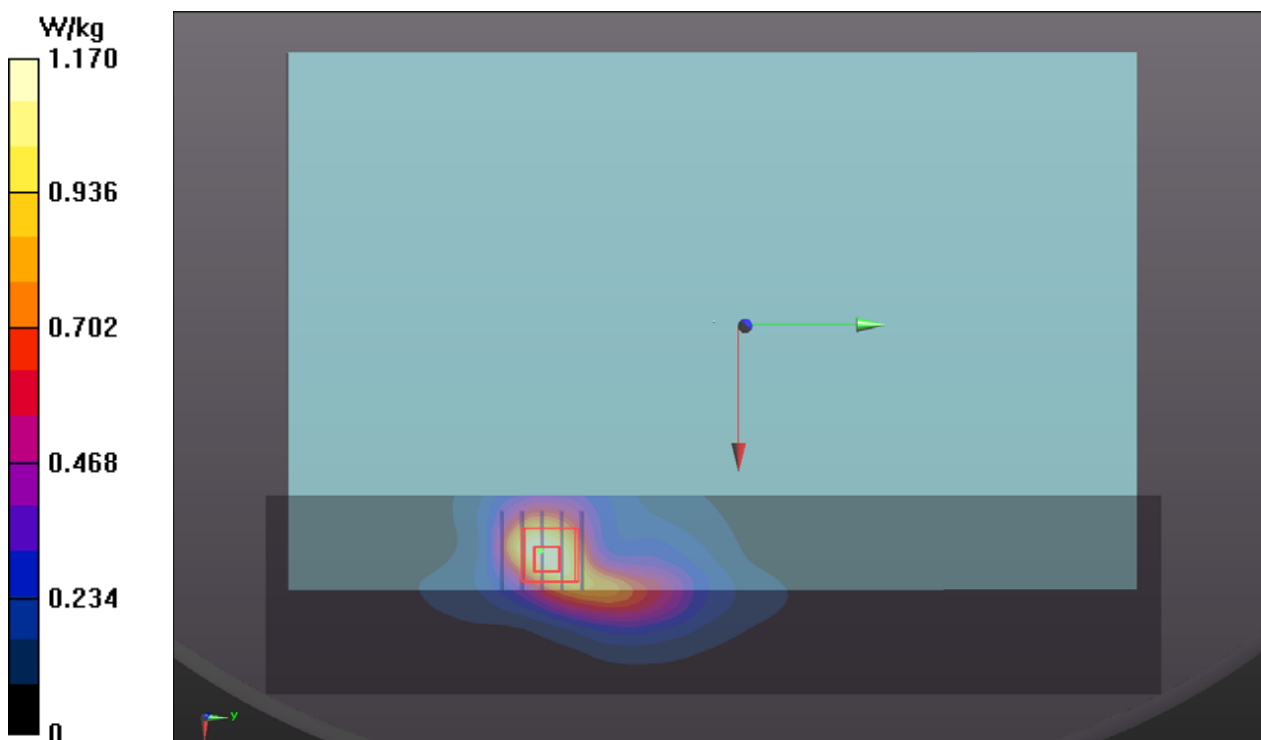

### P34 LTE 13\_QPSK10M\_Bottom\_0mm\_Ch23230\_1RB\_OS0\_Sample 1\_Battery 4cell\_P-Sensor\_w

**DUT: BEDW-WTW-P20100106**

Communication System: UID 10175 - CAG, LTE-FDD (SC-FDMA, 1 RB, 10 MHz, QPSK);  
Frequency: 782 MHz; Duty Cycle: 1:3.74  
Medium: H06T09N1\_1121 Medium parameters used:  $f = 782$  MHz;  $\sigma = 0.931$  S/m;  $\epsilon_r = 42.287$ ;  $\rho = 1000$  kg/m<sup>3</sup>  
Ambient Temperature : 23.3 °C ; Liquid Temperature : 23 °C

DASY5 Configuration:

- Probe: EX3DV4 - SN3971; ConvF(10.6, 10.6, 10.6) @ 782 MHz; Calibrated: 2020/01/27
- Sensor-Surface: 1.4mm (Mechanical Surface Detection)
- Electronics: DAE4 Sn917; Calibrated: 2019/12/17
- Phantom: ELI Phantom\_1206; Type: QDOVA002AA;
- Measurement SW: DASY52, Version 52.10 (4); SEMCAD X Version 14.6.14 (7483)

**Area Scan (61x241x1):** Interpolated grid: dx=1.500 mm, dy=1.500 mm  
Maximum value of SAR (interpolated) = 1.09 W/kg

**Zoom Scan (5x5x7)/Cube 0:** Measurement grid: dx=8mm, dy=8mm, dz=5mm  
Reference Value = 32.48 V/m; Power Drift = -0.18 dB  
Peak SAR (extrapolated) = 1.64 W/kg  
**SAR(1 g) = 0.886 W/kg; SAR(10 g) = 0.495 W/kg** (SAR corrected for target medium)  
Smallest distance from peaks to all points 3 dB below = 9.3 mm  
Ratio of SAR at M2 to SAR at M1 = 55.5%  
Maximum value of SAR (measured) = 1.30 W/kg

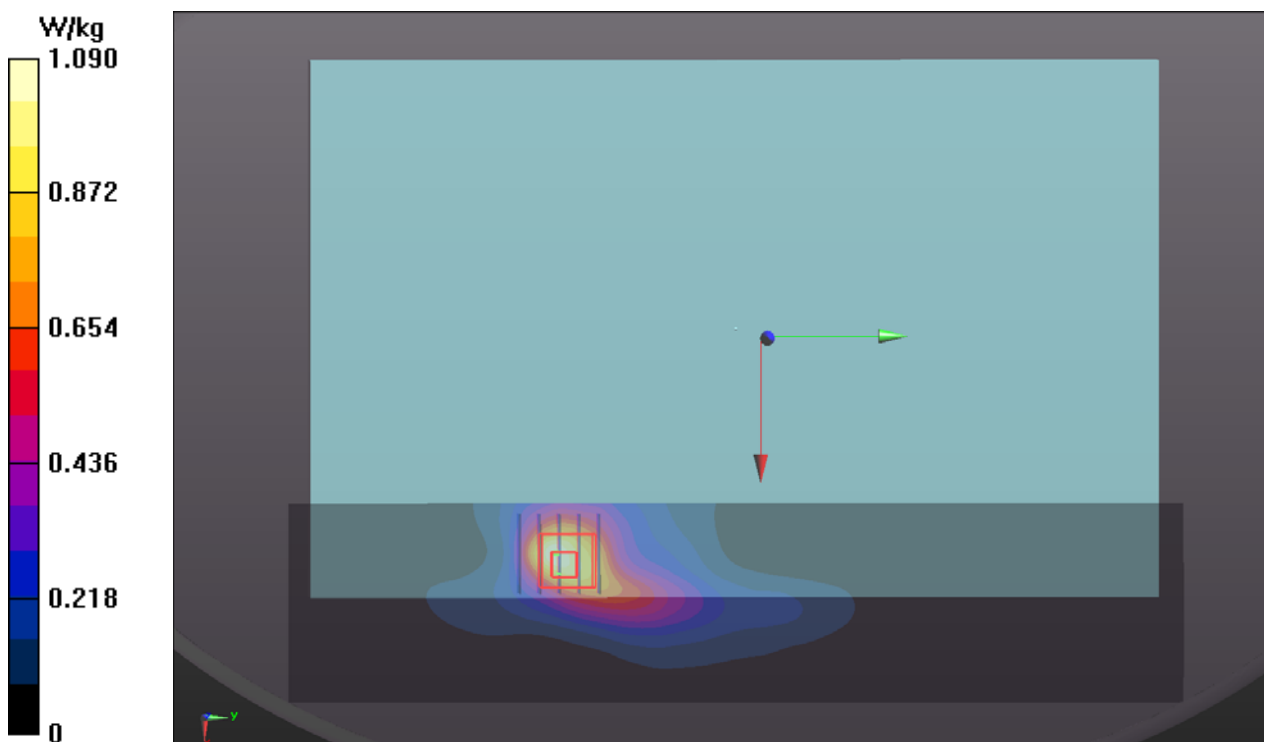

### P35 LTE 14\_QPSK10M\_Bottom\_0mm\_Ch23330\_1RB\_OS0\_Sample 1\_Battery 4cell\_P-Sensor\_w

**DUT: BEDW-WTW-P20100106**

Communication System: UID 10175 - CAG, LTE-FDD (SC-FDMA, 1 RB, 10 MHz, QPSK);  
Frequency: 793 MHz; Duty Cycle: 1:3.74  
Medium: H06T09N1\_1121 Medium parameters used:  $f = 793$  MHz;  $\sigma = 0.938$  S/m;  $\epsilon_r = 42.201$ ;  $\rho = 1000$  kg/m<sup>3</sup>  
Ambient Temperature : 23.3 °C ; Liquid Temperature : 23 °C

DASY5 Configuration:

- Probe: EX3DV4 - SN3971; ConvF(10.6, 10.6, 10.6) @ 793 MHz; Calibrated: 2020/01/27
- Sensor-Surface: 1.4mm (Mechanical Surface Detection)
- Electronics: DAE4 Sn917; Calibrated: 2019/12/17
- Phantom: ELI Phantom\_1206; Type: QDOVA002AA;
- Measurement SW: DASY52, Version 52.10 (4); SEMCAD X Version 14.6.14 (7483)

**Area Scan (61x241x1):** Interpolated grid: dx=1.500 mm, dy=1.500 mm  
Maximum value of SAR (interpolated) = 1.18 W/kg

**Zoom Scan (5x5x7)/Cube 0:** Measurement grid: dx=8mm, dy=8mm, dz=5mm  
Reference Value = 33.83 V/m; Power Drift = -0.05 dB  
Peak SAR (extrapolated) = 1.76 W/kg  
**SAR(1 g) = 0.950 W/kg; SAR(10 g) = 0.531 W/kg** (SAR corrected for target medium)  
Smallest distance from peaks to all points 3 dB below = 10.7 mm  
Ratio of SAR at M2 to SAR at M1 = 54.9%  
Maximum value of SAR (measured) = 1.42 W/kg

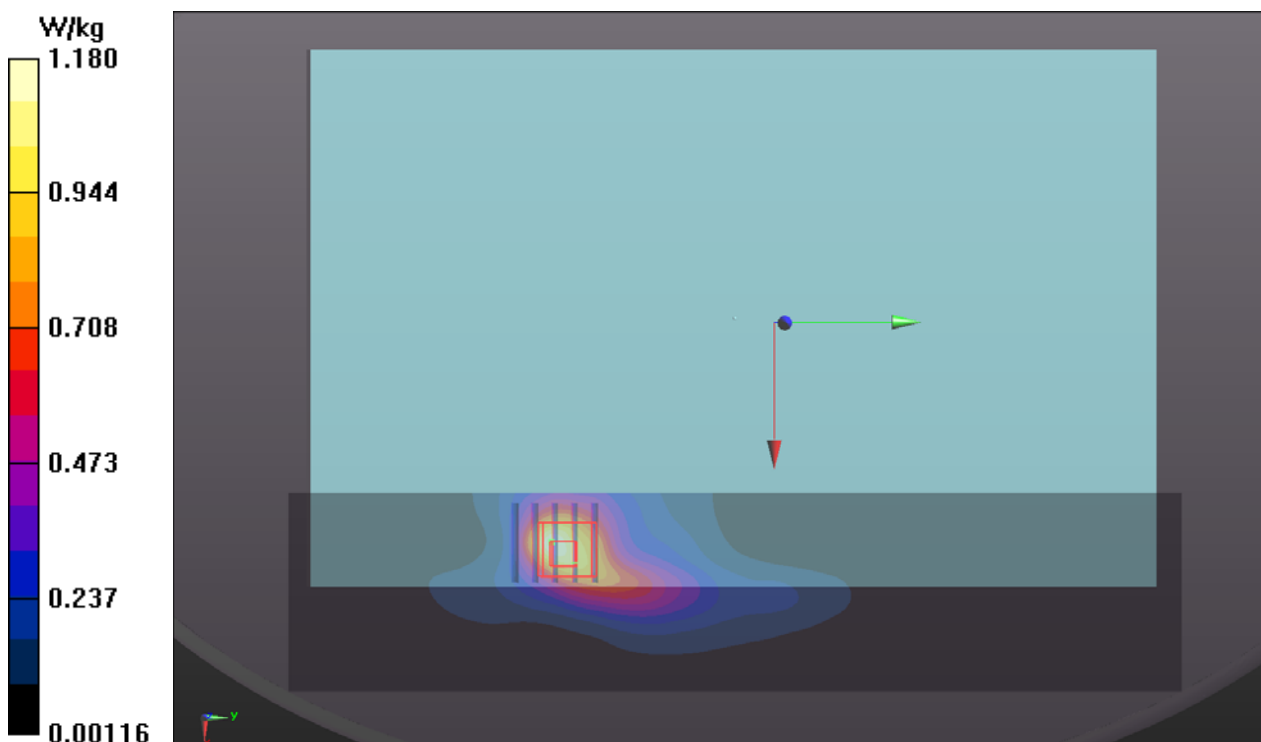



### P36 LTE 17\_QPSK10M\_Bottom\_0mm\_Ch23790\_1RB\_OS0\_Sample 1\_Battery 4cell\_P-Sensor\_w

**DUT: BEDW-WTW-P20100106**

Communication System: UID 10175 - CAG, LTE-FDD (SC-FDMA, 1 RB, 10 MHz, QPSK);  
Frequency: 710 MHz; Duty Cycle: 1:3.74  
Medium: H06T09N1\_1121 Medium parameters used:  $f = 710$  MHz;  $\sigma = 0.855$  S/m;  $\epsilon_r = 42.873$ ;  $\rho = 1000$  kg/m<sup>3</sup>  
Ambient Temperature : 23.3 °C ; Liquid Temperature : 23 °C

DASY5 Configuration:

- Probe: EX3DV4 - SN3971; ConvF(10.6, 10.6, 10.6) @ 710 MHz; Calibrated: 2020/01/27
- Sensor-Surface: 1.4mm (Mechanical Surface Detection)
- Electronics: DAE4 Sn917; Calibrated: 2019/12/17
- Phantom: ELI Phantom\_1206; Type: QDOVA002AA;
- Measurement SW: DASY52, Version 52.10 (4); SEMCAD X Version 14.6.14 (7483)

**Area Scan (61x241x1):** Interpolated grid: dx=1.500 mm, dy=1.500 mm  
Maximum value of SAR (interpolated) = 0.842 W/kg

**Zoom Scan (5x5x7)/Cube 0:** Measurement grid: dx=8mm, dy=8mm, dz=5mm  
Reference Value = 30.81 V/m; Power Drift = -0.02 dB  
Peak SAR (extrapolated) = 1.37 W/kg  
**SAR(1 g) = 0.761 W/kg; SAR(10 g) = 0.425 W/kg** (SAR corrected for target medium)  
Smallest distance from peaks to all points 3 dB below = 10.1 mm  
Ratio of SAR at M2 to SAR at M1 = 57.4%  
Maximum value of SAR (measured) = 1.07 W/kg

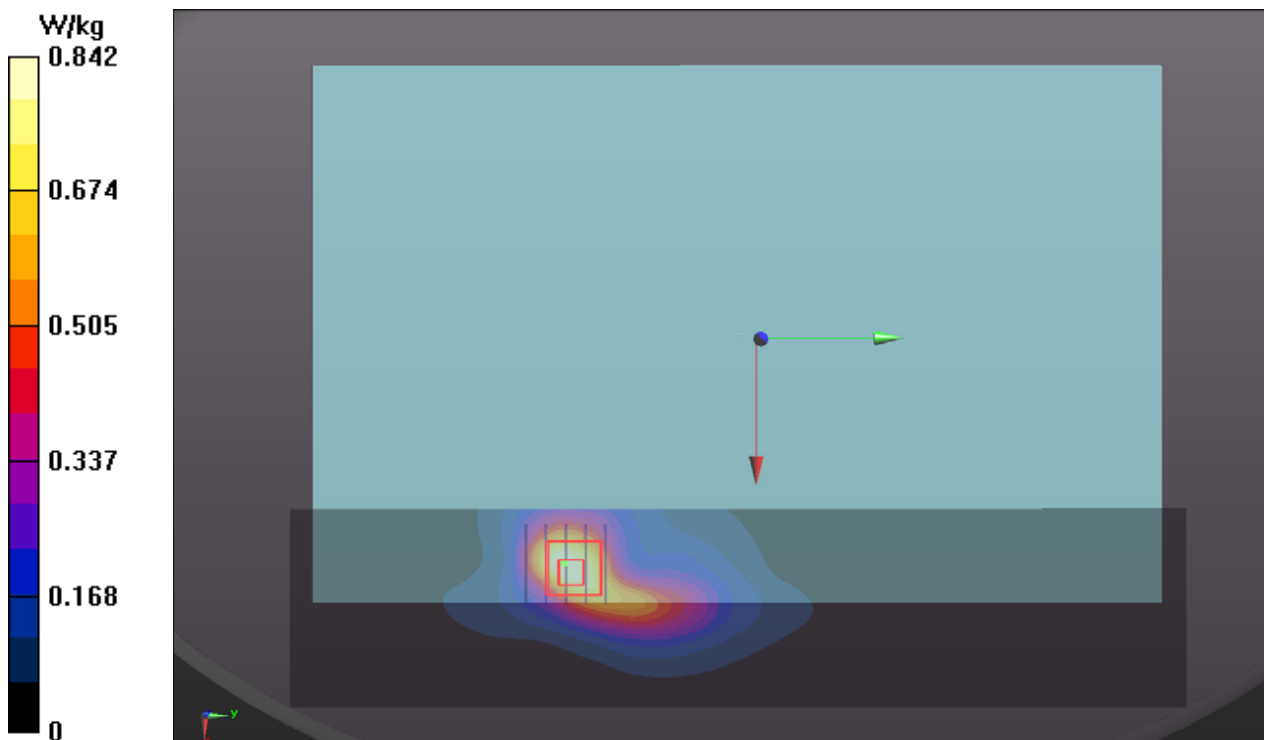

### P37 LTE 25\_QPSK20M\_Bottom\_0mm\_Ch26590\_1RB\_OS0\_Sample 1\_Battery 4cell\_P-Sensor\_w

**DUT: BEDW-WTW-P20100106**

Communication System: UID 10169 - CAE, LTE-FDD (SC-FDMA, 1 RB, 20 MHz, QPSK);  
Frequency: 1905 MHz; Duty Cycle: 1:3.74  
Medium: H16T20N1\_1123 Medium parameters used (interpolated):  $f = 1905$  MHz;  $\sigma = 1.463$  S/m;  
 $\epsilon_r = 39.718$ ;  $\rho = 1000$  kg/m<sup>3</sup>  
Ambient Temperature : 23.3 °C ; Liquid Temperature : 23.2 °C

DASY5 Configuration:

- Probe: EX3DV4 - SN3971; ConvF(8.54, 8.54, 8.54) @ 1905 MHz; Calibrated: 2020/01/27
- Sensor-Surface: 1.4mm (Mechanical Surface Detection)
- Electronics: DAE4 Sn917; Calibrated: 2019/12/17
- Phantom: ELI Phantom\_1206; Type: QDOVA002AA;
- Measurement SW: DASY52, Version 52.10 (4); SEMCAD X Version 14.6.14 (7483)

**Area Scan (61x241x1):** Interpolated grid: dx=1.500 mm, dy=1.500 mm  
Maximum value of SAR (interpolated) = 1.53 W/kg

**Zoom Scan (5x5x7)/Cube 0:** Measurement grid: dx=8mm, dy=8mm, dz=5mm  
Reference Value = 31.59 V/m; Power Drift = -0.06 dB  
Peak SAR (extrapolated) = 1.68 W/kg  
**SAR(1 g) = 0.771 W/kg; SAR(10 g) = 0.383 W/kg** (SAR corrected for target medium)  
Smallest distance from peaks to all points 3 dB below = 8.3 mm  
Ratio of SAR at M2 to SAR at M1 = 51.1%  
Maximum value of SAR (measured) = 1.35 W/kg

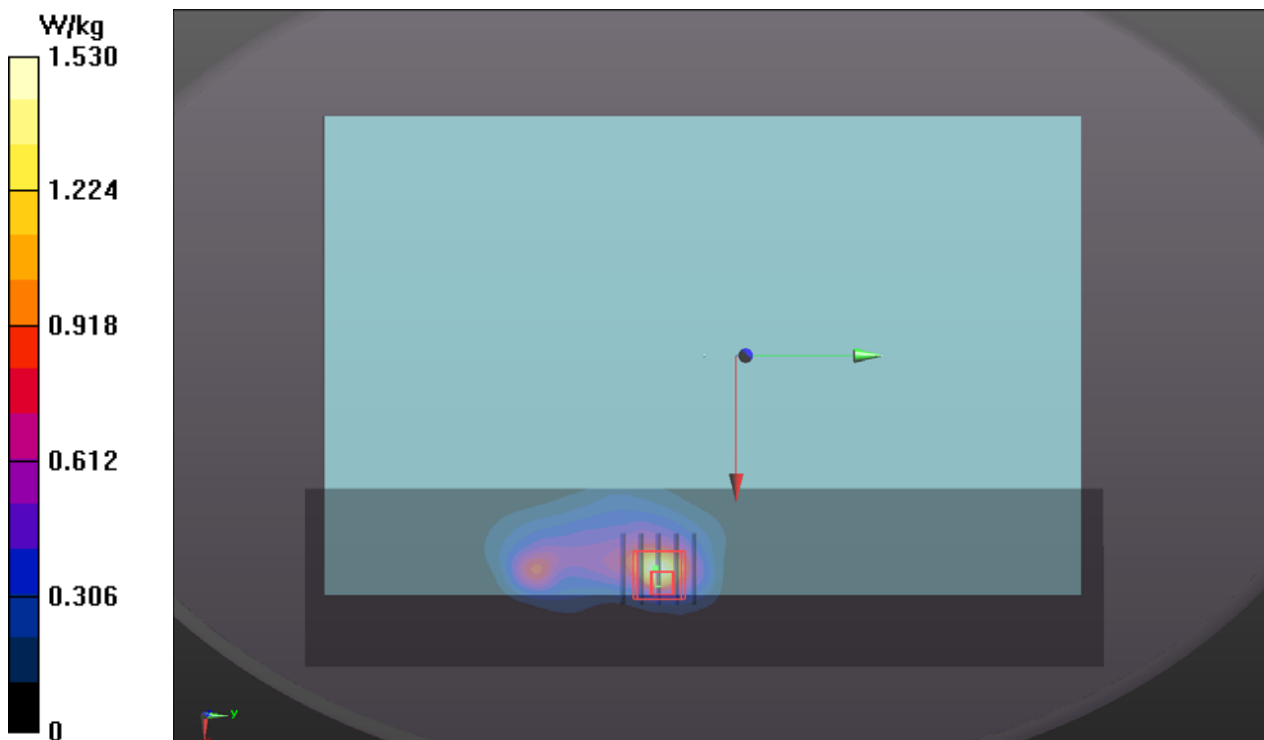

### P38 LTE 26\_QPSK15M\_Bottom\_0mm\_Ch26765\_1RB\_OS0\_Sample 1\_Battery 4cell\_P-Sensor\_w

**DUT: BEDW-WTW-P20100106**

Communication System: UID 10181 - CAE, LTE-FDD (SC-FDMA, 1 RB, 15 MHz, QPSK);  
Frequency: 821.5 MHz; Duty Cycle: 1:3.74  
Medium: H07T10N1\_1122 Medium parameters used (interpolated):  $f = 821.5$  MHz;  $\sigma = 0.909$  S/m;  
 $\epsilon_r = 42.094$ ;  $\rho = 1000$  kg/m<sup>3</sup>  
Ambient Temperature : 23.8 °C ; Liquid Temperature : 23.6 °C

DASY5 Configuration:

- Probe: EX3DV4 - SN3971; ConvF(10.26, 10.26, 10.26) @ 821.5 MHz; Calibrated: 2020/01/27
- Sensor-Surface: 1.4mm (Mechanical Surface Detection)
- Electronics: DAE4 Sn917; Calibrated: 2019/12/17
- Phantom: ELI Phantom\_1206; Type: QDOVA002AA;
- Measurement SW: DASY52, Version 52.10 (4); SEMCAD X Version 14.6.14 (7483)

**Area Scan (61x241x1):** Interpolated grid: dx=1.500 mm, dy=1.500 mm  
Maximum value of SAR (interpolated) = 1.19 W/kg

**Zoom Scan (5x5x7)/Cube 0:** Measurement grid: dx=8mm, dy=8mm, dz=5mm  
Reference Value = 34.08 V/m; Power Drift = -0.02 dB  
Peak SAR (extrapolated) = 1.55 W/kg  
**SAR(1 g) = 0.843 W/kg; SAR(10 g) = 0.462 W/kg** (SAR corrected for target medium)  
Smallest distance from peaks to all points 3 dB below = 11.6 mm  
Ratio of SAR at M2 to SAR at M1 = 54.7%  
Maximum value of SAR (measured) = 1.29 W/kg

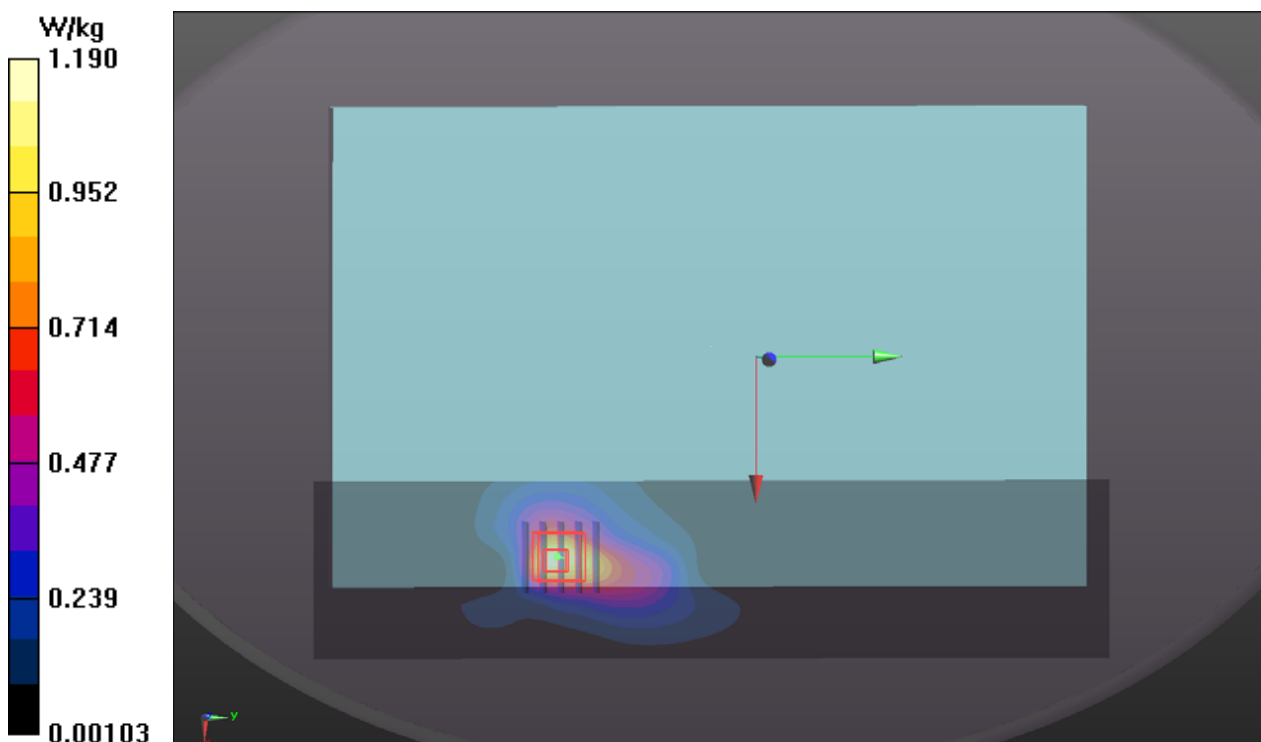

### P39 LTE 30\_QPSK10M\_Bottom\_0mm\_Ch27710\_1RB\_OS0\_Sample 1\_Battery 4cell\_P-Sensor\_w

**DUT: BEDW-WTW-P20100106**

Communication System: UID 10175 - CAG, LTE-FDD (SC-FDMA, 1 RB, 10 MHz, QPSK);  
Frequency: 2310 MHz; Duty Cycle: 1:3.74  
Medium: H19T27N1\_1120 Medium parameters used:  $f = 2310$  MHz;  $\sigma = 1.74$  S/m;  $\epsilon_r = 38.831$ ;  $\rho = 1000$  kg/m<sup>3</sup>  
Ambient Temperature : 23.4 °C ; Liquid Temperature : 23.1 °C

DASY5 Configuration:

- Probe: EX3DV4 - SN3971; ConvF(8.06, 8.06, 8.06) @ 2310 MHz; Calibrated: 2020/01/27
- Sensor-Surface: 1.4mm (Mechanical Surface Detection)
- Electronics: DAE4 Sn917; Calibrated: 2019/12/17
- Phantom: ELI Phantom\_1206; Type: QDOVA002AA;
- Measurement SW: DASY52, Version 52.10 (4); SEMCAD X Version 14.6.14 (7483)

**Area Scan (71x301x1):** Interpolated grid:  $dx=1.200$  mm,  $dy=1.200$  mm  
Maximum value of SAR (interpolated) = 1.15 W/kg

**Zoom Scan (7x7x7)/Cube 0:** Measurement grid:  $dx=5$ mm,  $dy=5$ mm,  $dz=5$ mm  
Reference Value = 25.82 V/m; Power Drift = -0.03 dB  
Peak SAR (extrapolated) = 2.19 W/kg  
**SAR(1 g) = 0.914 W/kg; SAR(10 g) = 0.449 W/kg** (SAR corrected for target medium)  
Smallest distance from peaks to all points 3 dB below = 8.1 mm  
Ratio of SAR at M2 to SAR at M1 = 43.1%  
Maximum value of SAR (measured) = 1.62 W/kg

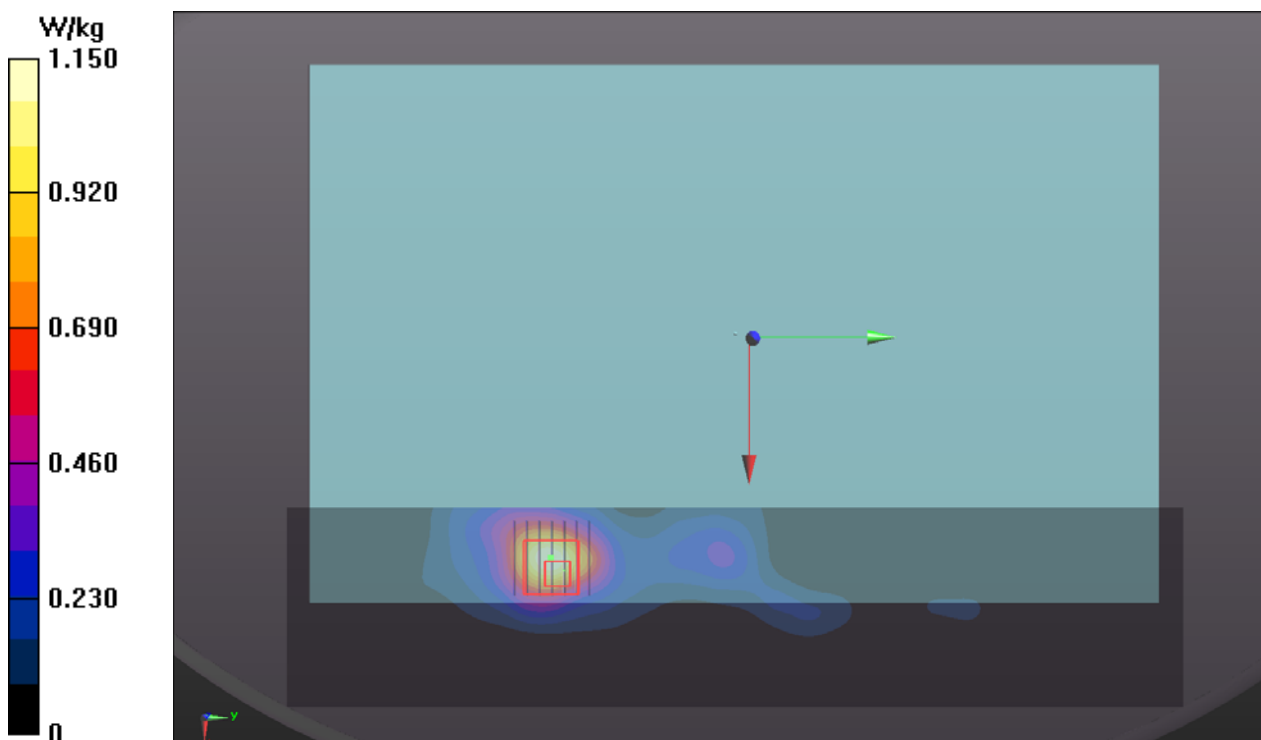

### P40 LTE 38\_QPSK20M\_Bottom\_0mm\_Ch38000\_1RB\_OS0\_Sample 1\_Battery 4cell\_P-Sensor\_w

**DUT: BEDW-WTW-P20100106**

Communication System: UID 10172 - CAG, LTE-TDD (SC-FDMA, 1 RB, 20 MHz, QPSK);  
Frequency: 2595 MHz; Duty Cycle: 1:8.33  
Medium: H19T27N1\_1122 Medium parameters used (interpolated):  $f = 2595$  MHz;  $\sigma = 2.046$  S/m;  
 $\epsilon_r = 37.822$ ;  $\rho = 1000$  kg/m<sup>3</sup>  
Ambient Temperature : 23.8 °C ; Liquid Temperature : 23.6 °C

DASY5 Configuration:

- Probe: EX3DV4 - SN3971; ConvF(7.71, 7.71, 7.71) @ 2595 MHz; Calibrated: 2020/01/27
- Sensor-Surface: 1.4mm (Mechanical Surface Detection)
- Electronics: DAE4 Sn917; Calibrated: 2019/12/17
- Phantom: ELI Phantom\_1206; Type: QDOVA002AA;
- Measurement SW: DASY52, Version 52.10 (4); SEMCAD X Version 14.6.14 (7483)

**Area Scan (71x301x1):** Interpolated grid: dx=1.200 mm, dy=1.200 mm  
Maximum value of SAR (interpolated) = 1.53 W/kg

**Zoom Scan (7x7x7)/Cube 0:** Measurement grid: dx=5mm, dy=5mm, dz=5mm  
Reference Value = 25.17 V/m; Power Drift = -0.08 dB  
Peak SAR (extrapolated) = 2.32 W/kg  
**SAR(1 g) = 0.897 W/kg; SAR(10 g) = 0.406 W/kg** (SAR corrected for target medium)  
Smallest distance from peaks to all points 3 dB below = 7.6 mm  
Ratio of SAR at M2 to SAR at M1 = 39.1%  
Maximum value of SAR (measured) = 1.71 W/kg

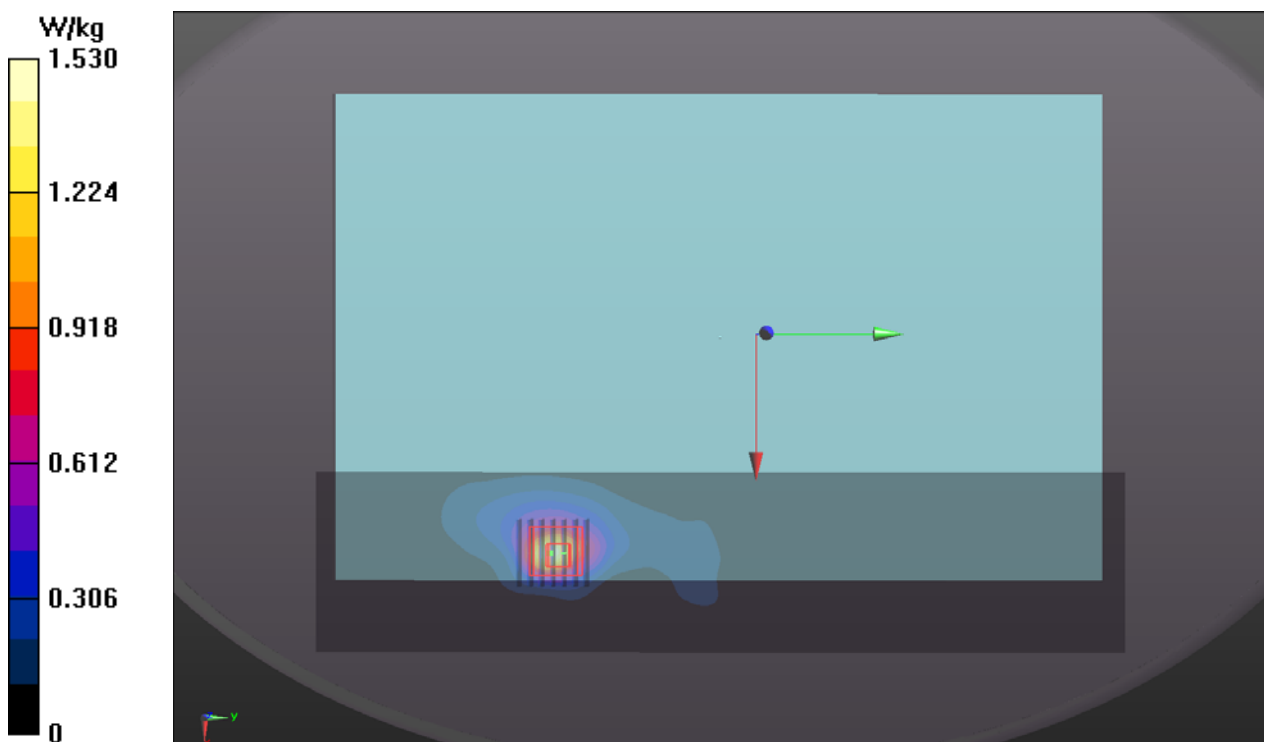

### P42 LTE 41\_QPSK20M\_Bottom\_0mm\_Ch40620\_1RB\_OS0\_Sample 1\_Battery 4cell\_P-Sensor\_w

**DUT: BEDW-WTW-P20100106**

Communication System: UID 10172 - CAG, LTE-TDD (SC-FDMA, 1 RB, 20 MHz, QPSK);  
Frequency: 2593 MHz; Duty Cycle: 1:8.33  
Medium: H19T27N1\_1122 Medium parameters used (interpolated):  $f = 2593$  MHz;  $\sigma = 2.044$  S/m;  
 $\epsilon_r = 37.826$ ;  $\rho = 1000$  kg/m<sup>3</sup>  
Ambient Temperature : 23.8 °C; Liquid Temperature : 23.6 °C

DASY5 Configuration:

- Probe: EX3DV4 - SN3971; ConvF(7.71, 7.71, 7.71) @ 2593 MHz; Calibrated: 2020/01/27
- Sensor-Surface: 1.4mm (Mechanical Surface Detection)
- Electronics: DAE4 Sn917; Calibrated: 2019/12/17
- Phantom: ELI Phantom\_1206; Type: QDOVA002AA;
- Measurement SW: DASY52, Version 52.10 (4); SEMCAD X Version 14.6.14 (7483)

**Area Scan (71x301x1):** Interpolated grid: dx=1.200 mm, dy=1.200 mm  
Maximum value of SAR (interpolated) = 1.30 W/kg

**Zoom Scan (7x7x7)/Cube 0:** Measurement grid: dx=5mm, dy=5mm, dz=5mm  
Reference Value = 23.47 V/m; Power Drift = -0.04 dB  
Peak SAR (extrapolated) = 2.00 W/kg  
**SAR(1 g) = 0.776 W/kg; SAR(10 g) = 0.355 W/kg** (SAR corrected for target medium)  
Smallest distance from peaks to all points 3 dB below = 7.6 mm  
Ratio of SAR at M2 to SAR at M1 = 39.3%  
Maximum value of SAR (measured) = 1.47 W/kg

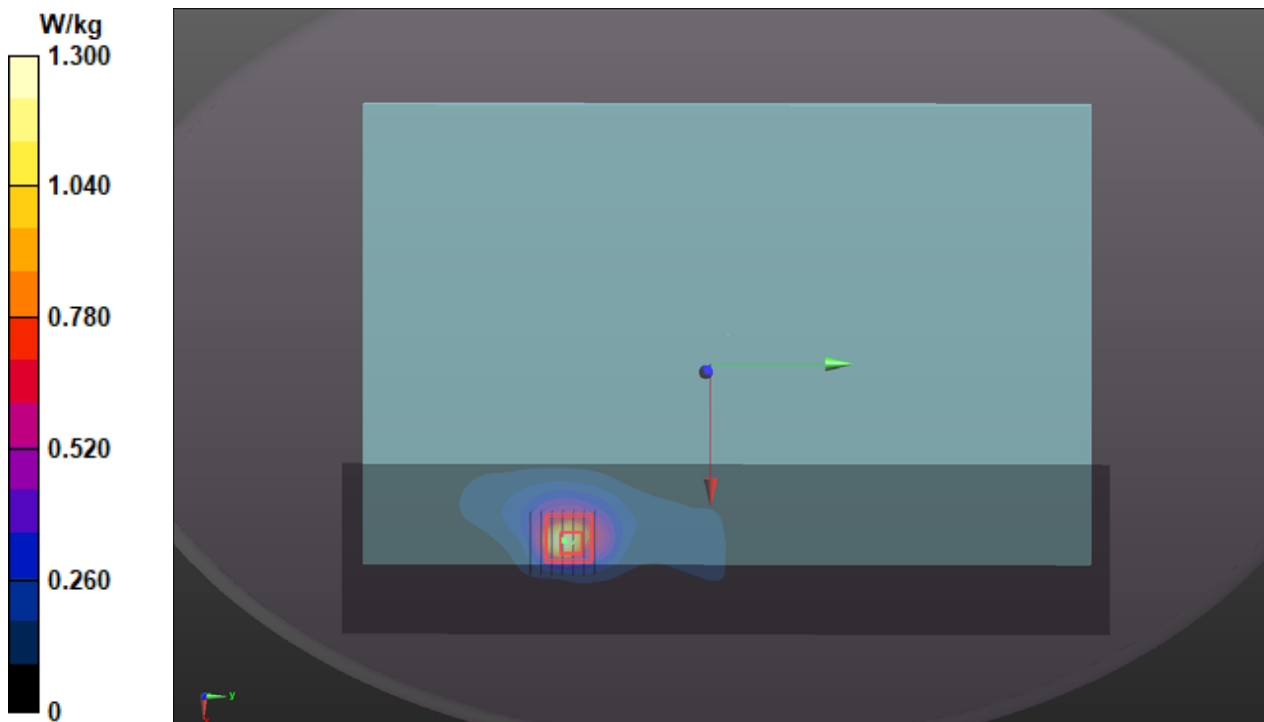

### P45 LTE 66\_QPSK20M\_Bottom\_0mm\_Ch132572\_1RB\_OS0\_Sample 1\_Battery 4cell\_P-Sensor\_w

**DUT: BEDW-WTW-P20100106**

Communication System: UID 10169 - CAE, LTE-FDD (SC-FDMA, 1 RB, 20 MHz, QPSK);  
Frequency: 1770 MHz; Duty Cycle: 1:3.74

Medium: H16T20N1\_1124 Medium parameters used:  $f = 1770$  MHz;  $\sigma = 1.326$  S/m;  $\epsilon_r = 38.914$ ;  $\rho = 1000$  kg/m<sup>3</sup>

Ambient Temperature : 23.7 °C ; Liquid Temperature : 23.5 °C

DASY5 Configuration:

- Probe: EX3DV4 - SN3971; ConvF(8.73, 8.73, 8.73) @ 1770 MHz; Calibrated: 2020/01/27
- Sensor-Surface: 1.4mm (Mechanical Surface Detection)
- Electronics: DAE4 Sn917; Calibrated: 2019/12/17
- Phantom: ELI Phantom\_1206; Type: QDOVA002AA;
- Measurement SW: DASY52, Version 52.10 (4); SEMCAD X Version 14.6.14 (7483)

**Area Scan (61x241x1):** Interpolated grid: dx=1.500 mm, dy=1.500 mm

Maximum value of SAR (interpolated) = 1.41 W/kg

**Zoom Scan (5x5x7)/Cube 0:** Measurement grid: dx=8mm, dy=8mm, dz=5mm

Reference Value = 31.02 V/m; Power Drift = -0.11 dB

Peak SAR (extrapolated) = 1.59 W/kg

**SAR(1 g) = 0.771 W/kg; SAR(10 g) = 0.367 W/kg** (SAR corrected for target medium)

Smallest distance from peaks to all points 3 dB below = 8.4 mm

Ratio of SAR at M2 to SAR at M1 = 51.2%

Maximum value of SAR (measured) = 1.35 W/kg

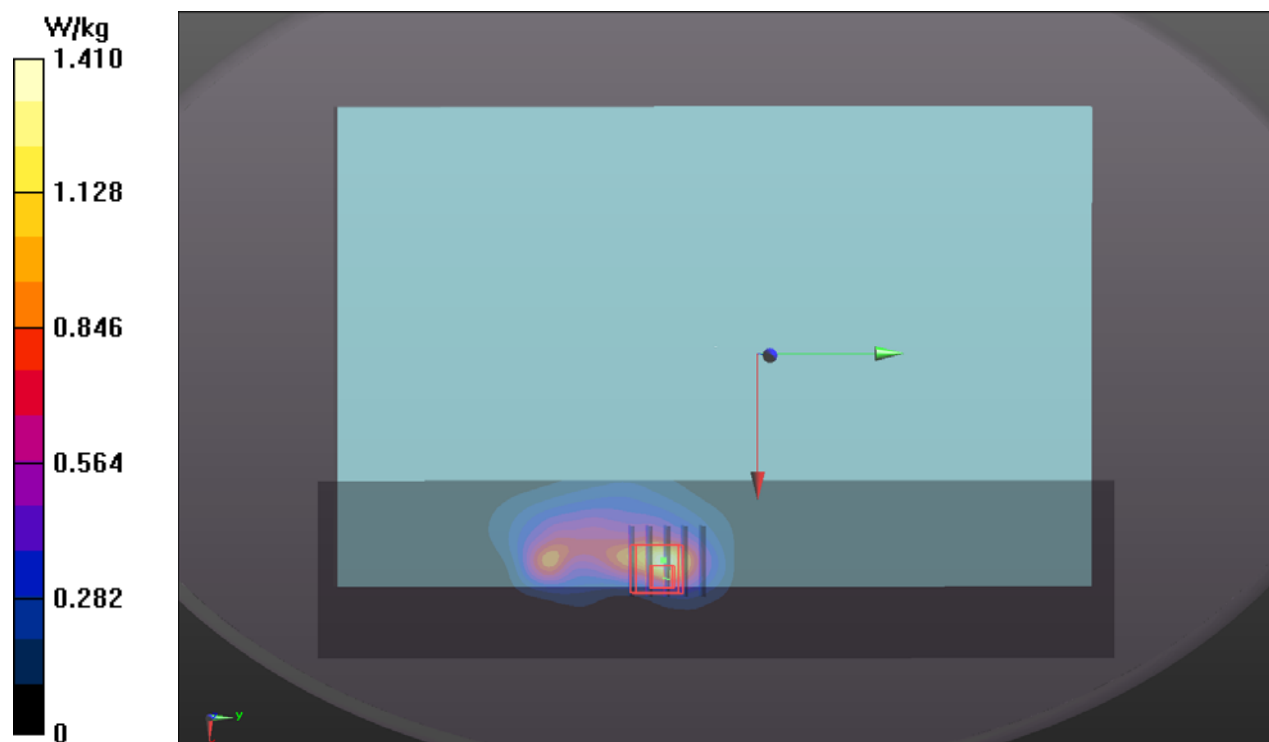

## P46 WLAN2.4G\_802.11n HT40\_Bottom\_0mm\_Ch6\_Sample 1\_Ant 0+1\_Battery 4cell

**DUT: BEDW-WTW-P20100106**

Communication System: UID 10599 - AAC, IEEE 802.11n (HT Mixed, 40MHz, MCS0);  
Frequency: 2437 MHz; Duty Cycle: 1:1.01  
Medium: H19T27N1\_1120 Medium parameters used (interpolated):  $f = 2437$  MHz;  $\sigma = 1.871$  S/m;  
 $\epsilon_r = 38.384$ ;  $\rho = 1000$  kg/m<sup>3</sup>  
Ambient Temperature : 23.4 °C ; Liquid Temperature : 23.1 °C

DASY5 Configuration:

- Probe: EX3DV4 - SN3971; ConvF(8, 8, 8) @ 2437 MHz; Calibrated: 2020/01/27
- Sensor-Surface: 1.4mm (Mechanical Surface Detection)
- Electronics: DAE4 Sn917; Calibrated: 2019/12/17
- Phantom: ELI Phantom\_1206; Type: QDOVA002AA;
- Measurement SW: DASY52, Version 52.10 (4); SEMCAD X Version 14.6.14 (7483)

**Area Scan (71x301x1):** Interpolated grid: dx=1.200 mm, dy=1.200 mm  
Maximum value of SAR (interpolated) = 1.28 W/kg

**Zoom Scan (7x7x7)/Cube 0:** Measurement grid: dx=5mm, dy=5mm, dz=5mm  
Reference Value = 20.66 V/m; Power Drift = -0.02 dB  
Peak SAR (extrapolated) = 2.76 W/kg  
**SAR(1 g) = 1.01 W/kg; SAR(10 g) = 0.399 W/kg** (SAR corrected for target medium)  
Smallest distance from peaks to all points 3 dB below = 5.4 mm  
Ratio of SAR at M2 to SAR at M1 = 42%  
Maximum value of SAR (measured) = 2.09 W/kg

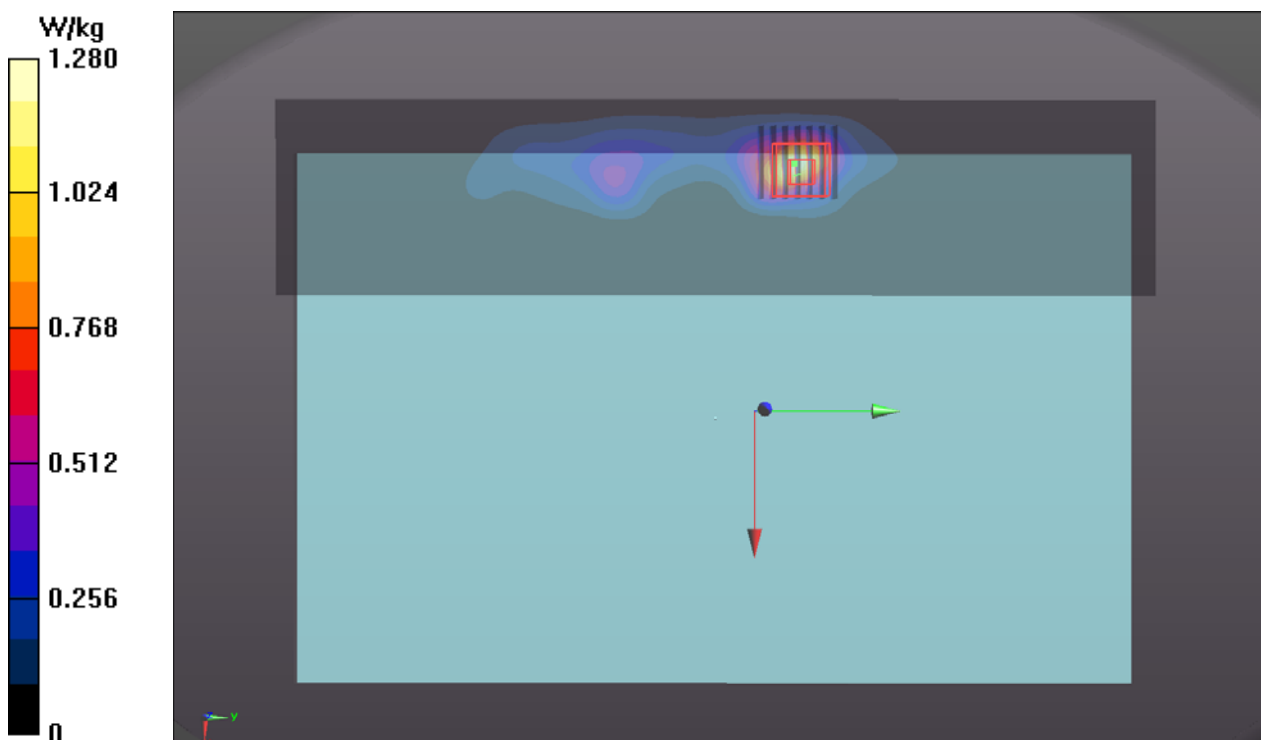



### P47 WLAN5.3G\_802.11ac VHT160\_Bottom\_0mm\_Ch50\_Sample 1\_Ant 1\_Battery 4cell

**DUT: BEDW-WTW-P20100106**

Communication System: UID 10554 - AAD, IEEE 802.11ac WiFi (160MHz, MCS0); Frequency: 5250 MHz; Duty Cycle: 1:1.03

Medium: H34T60N1\_1119 Medium parameters used (interpolated):  $f = 5250 \text{ MHz}$ ;  $\sigma = 4.573 \text{ S/m}$ ;  $\epsilon_r = 36.637$ ;  $\rho = 1000 \text{ kg/m}^3$

Ambient Temperature : 23.6 °C ; Liquid Temperature : 23.4 °C

DASY5 Configuration:

- Probe: EX3DV4 - SN3971; ConvF(5.28, 5.28, 5.28) @ 5250 MHz; Calibrated: 2020/01/27
- Sensor-Surface: 1.4mm (Mechanical Surface Detection)
- Electronics: DAE4 Sn917; Calibrated: 2019/12/17
- Phantom: ELI Phantom\_1206; Type: QDOVA002AA;
- Measurement SW: DASY52, Version 52.10 (4); SEMCAD X Version 14.6.14 (7483)

**Area Scan (81x361x1):** Interpolated grid:  $dx=1.000 \text{ mm}$ ,  $dy=1.000 \text{ mm}$

Maximum value of SAR (interpolated) = 1.79 W/kg

**Zoom Scan (7x7x7)/Cube 0:** Measurement grid:  $dx=4\text{mm}$ ,  $dy=4\text{mm}$ ,  $dz=1.4\text{mm}$

Reference Value = 19.57 V/m; Power Drift = -0.16 dB

Peak SAR (extrapolated) = 4.66 W/kg

**SAR(1 g) = 1.06 W/kg; SAR(10 g) = 0.323 W/kg** (SAR corrected for target medium)

Smallest distance from peaks to all points 3 dB below = 4.2 mm

Ratio of SAR at M2 to SAR at M1 = 69.4%

Maximum value of SAR (measured) = 2.50 W/kg

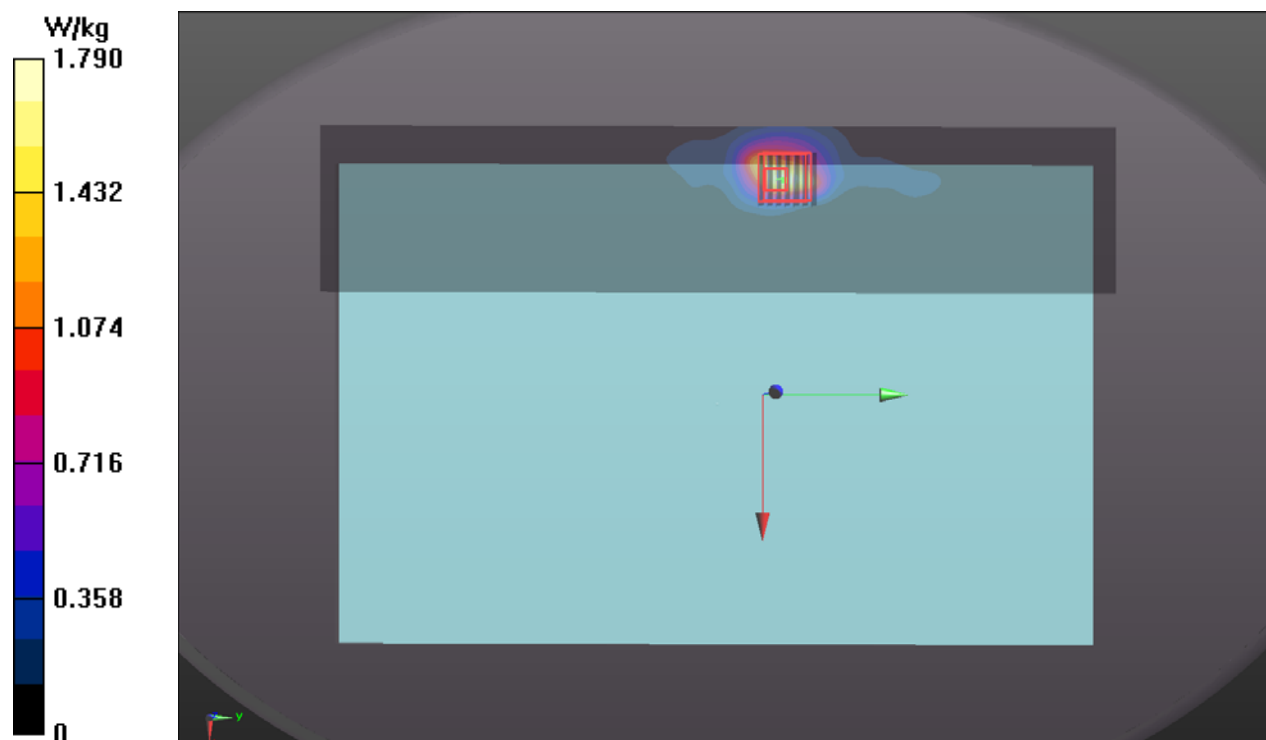

### P48 WLAN5.6G\_802.11av VHT160\_Bottom\_0mm\_Ch114\_Sample 1\_Ant 1\_Battery 4cell

**DUT: BEDW-WTW-P20100106**

Communication System: UID 10554 - AAD, IEEE 802.11ac WiFi (160MHz, MCS0); Frequency: 5570 MHz; Duty Cycle: 1:1.03

Medium: H34T60N2\_1120 Medium parameters used (interpolated):  $f = 5570$  MHz;  $\sigma = 4.839$  S/m;  $\epsilon_r = 34.003$ ;  $\rho = 1000$  kg/m<sup>3</sup>

Ambient Temperature : 23.4 °C ; Liquid Temperature : 23.1 °C

DASY5 Configuration:

- Probe: EX3DV4 - SN3971; ConvF(4.89, 4.89, 4.89) @ 5570 MHz; Calibrated: 2020/01/27
- Sensor-Surface: 1.4mm (Mechanical Surface Detection)
- Electronics: DAE4 Sn917; Calibrated: 2019/12/17
- Phantom: ELI Phantom\_1206; Type: QDOVA002AA;
- Measurement SW: DASY52, Version 52.10 (4); SEMCAD X Version 14.6.14 (7483)

**Area Scan (81x361x1):** Interpolated grid: dx=1.000 mm, dy=1.000 mm

Maximum value of SAR (interpolated) = 0.888 W/kg

**Zoom Scan (7x7x7)/Cube 0:** Measurement grid: dx=4mm, dy=4mm, dz=1.4mm

Reference Value = 14.24 V/m; Power Drift = -0.09 dB

Peak SAR (extrapolated) = 3.12 W/kg

**SAR(1 g) = 0.686 W/kg; SAR(10 g) = 0.212 W/kg** (SAR corrected for target medium)

Smallest distance from peaks to all points 3 dB below = 4.7 mm

Ratio of SAR at M2 to SAR at M1 = 65.9%

Maximum value of SAR (measured) = 1.92 W/kg

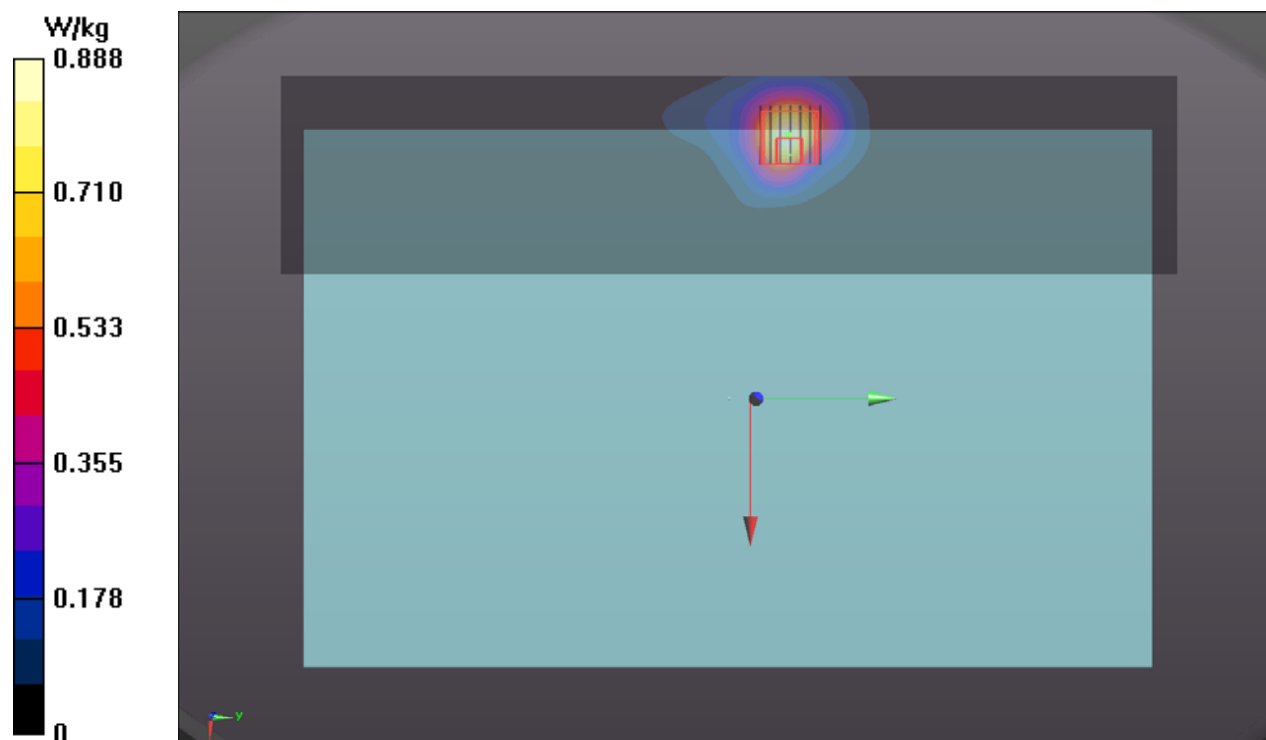

### P49 WLAN5.8G\_802.11ac VHT80\_Bottom\_0mm\_Ch155\_Sample 1\_Ant 1\_Battery 4cell

**DUT: BEDW-WTW-P20100106**

Communication System: UID 10544 - AAC, IEEE 802.11ac WiFi (80MHz, MCS0); Frequency: 5775 MHz; Duty Cycle: 1:1.03

Medium: H34T60N1\_1119 Medium parameters used:  $f = 5775$  MHz;  $\sigma = 5.086$  S/m;  $\epsilon_r = 35.926$ ;  $\rho = 1000$  kg/m<sup>3</sup>

Ambient Temperature : 23.6 °C ; Liquid Temperature : 23.4 °C

DASY5 Configuration:

- Probe: EX3DV4 - SN3971; ConvF(5.05, 5.05, 5.05) @ 5775 MHz; Calibrated: 2020/01/27
- Sensor-Surface: 1.4mm (Mechanical Surface Detection)
- Electronics: DAE4 Sn917; Calibrated: 2019/12/17
- Phantom: ELI Phantom\_1206; Type: QDOVA002AA;
- Measurement SW: DASY52, Version 52.10 (4); SEMCAD X Version 14.6.14 (7483)

**Area Scan (81x361x1):** Interpolated grid: dx=1.000 mm, dy=1.000 mm

Maximum value of SAR (interpolated) = 1.93 W/kg

**Zoom Scan (7x7x7)/Cube 0:** Measurement grid: dx=4mm, dy=4mm, dz=1.4mm

Reference Value = 19.56 V/m; Power Drift = -0.18 dB

Peak SAR (extrapolated) = 5.48 W/kg

**SAR(1 g) = 0.870 W/kg; SAR(10 g) = 0.246 W/kg** (SAR corrected for target medium)

Smallest distance from peaks to all points 3 dB below = 4.3 mm

Ratio of SAR at M2 to SAR at M1 = 60%

Maximum value of SAR (measured) = 2.77 W/kg

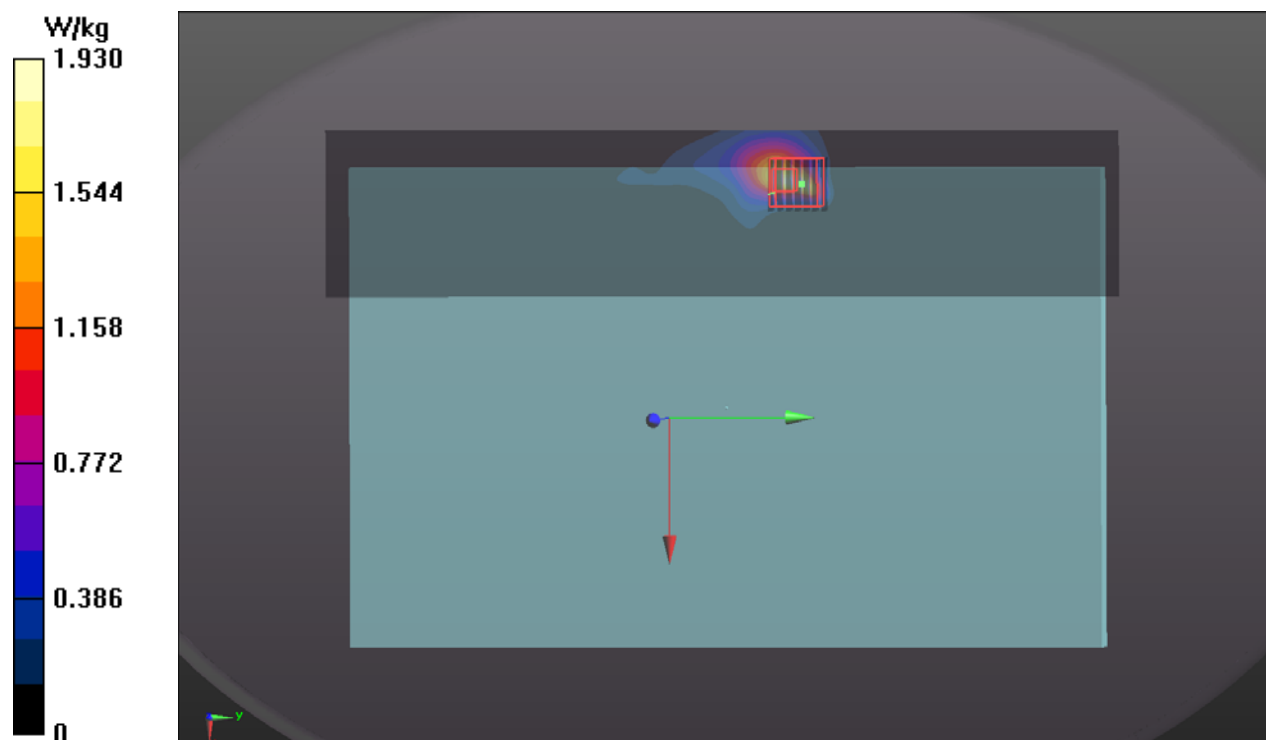

## P50 BT\_BDR\_Bottom\_0mm\_Ch0\_Sample 1\_Ant 1\_Battery 4cell

**DUT: BEDW-WTW-P20100106**

Communication System: UID 10032 - CAA, IEEE 802.15.1 Bluetooth (GFSK, DH5); Frequency: 2402 MHz; Duty Cycle: 1:1.3

Medium: H19T27N1\_1120 Medium parameters used (interpolated):  $f = 2402$  MHz;  $\sigma = 1.835$  S/m;  $\epsilon_r = 38.543$ ;  $\rho = 1000$  kg/m<sup>3</sup>

Ambient Temperature : 23.4 °C ; Liquid Temperature : 23.1 °C

DASY5 Configuration:

- Probe: EX3DV4 - SN3971; ConvF(8, 8, 8) @ 2402 MHz; Calibrated: 2020/01/27
- Sensor-Surface: 1.4mm (Mechanical Surface Detection)
- Electronics: DAE4 Sn917; Calibrated: 2019/12/17
- Phantom: ELI Phantom\_1206; Type: QDOVA002AA;
- Measurement SW: DASY52, Version 52.10 (4); SEMCAD X Version 14.6.14 (7483)

**Area Scan (71x301x1):** Interpolated grid: dx=1.200 mm, dy=1.200 mm

Maximum value of SAR (interpolated) = 0.155 W/kg

**Zoom Scan (7x7x7)/Cube 0:** Measurement grid: dx=5mm, dy=5mm, dz=5mm

Reference Value = 8.211 V/m; Power Drift = -0.14 dB

Peak SAR (extrapolated) = 0.405 W/kg

**SAR(1 g) = 0.153 W/kg; SAR(10 g) = 0.060 W/kg** (SAR corrected for target medium)

Smallest distance from peaks to all points 3 dB below = 8.5 mm

Ratio of SAR at M2 to SAR at M1 = 44.2%

Maximum value of SAR (measured) = 0.301 W/kg

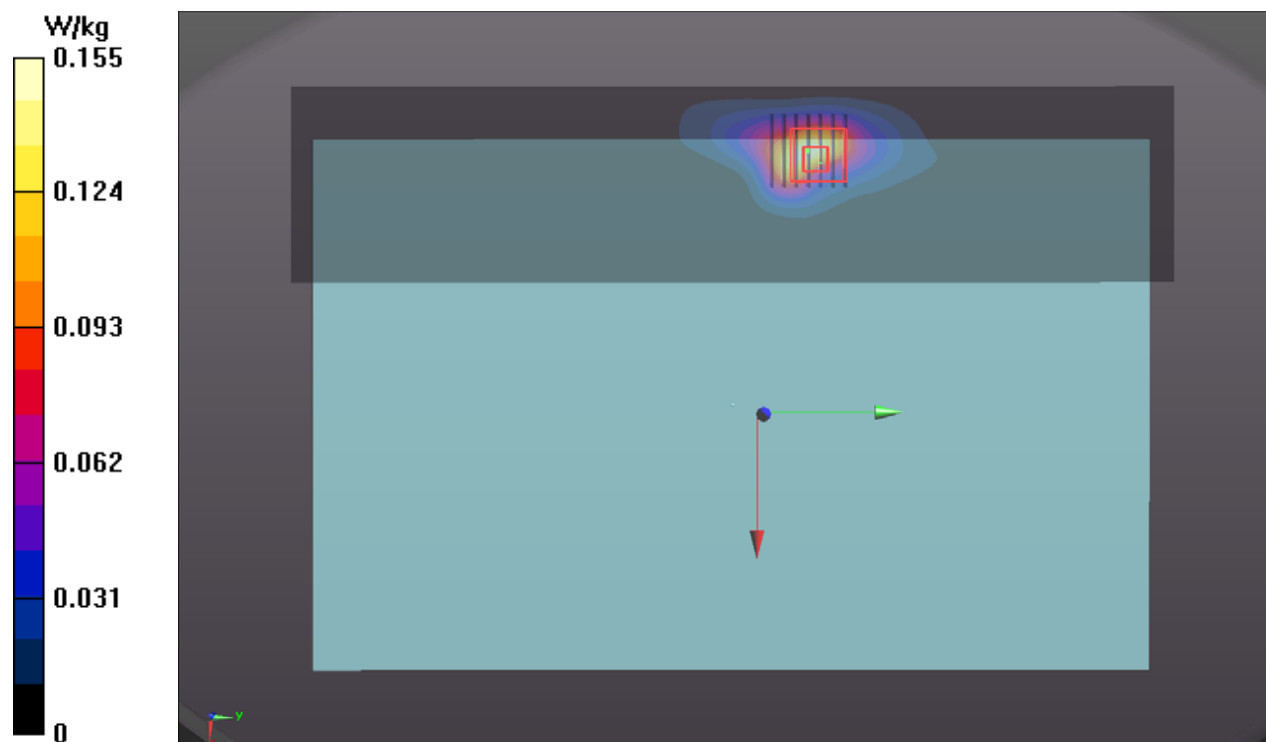

## **Appendix C. Calibration Certificate for Probe and Dipole**

The SPEAG calibration certificates are shown as follows.



Accredited by the Swiss Accreditation Service (SAS)  
The Swiss Accreditation Service is one of the signatories to the EA  
Multilateral Agreement for the recognition of calibration certificates

Accreditation No.: **SCS 0108**

Client **B.V. ADT (Auden)**

Certificate No: **D750V3-1013\_Aug20**

## CALIBRATION CERTIFICATE

Object **D750V3 - SN:1013**

Calibration procedure(s) **QA CAL-05.v11  
Calibration Procedure for SAR Validation Sources between 0.7-3 GHz**

Calibration date: **August 13, 2020**

This calibration certificate documents the traceability to national standards, which realize the physical units of measurements (SI).  
The measurements and the uncertainties with confidence probability are given on the following pages and are part of the certificate.

All calibrations have been conducted in the closed laboratory facility: environment temperature ( $22 \pm 3$ )°C and humidity < 70%.

Calibration Equipment used (M&TE critical for calibration)

Primary Standards	ID #	Cal Date (Certificate No.)	Scheduled Calibration
Power meter NRP	SN: 104778	01-Apr-20 (No. 217-03100/03101)	Apr-21
Power sensor NRP-Z91	SN: 103244	01-Apr-20 (No. 217-03100)	Apr-21
Power sensor NRP-Z91	SN: 103245	01-Apr-20 (No. 217-03101)	Apr-21
Reference 20 dB Attenuator	SN: BH9394 (20k)	31-Mar-20 (No. 217-03106)	Apr-21
Type-N mismatch combination	SN: 310982 / 06327	31-Mar-20 (No. 217-03104)	Apr-21
Reference Probe EX3DV4	SN: 7349	29-Jun-20 (No. EX3-7349_Jun20)	Jun-21
DAE4	SN: 601	27-Dec-19 (No. DAE4-601_Dec19)	Dec-20

Secondary Standards	ID #	Check Date (in house)	Scheduled Check
Power meter E4419B	SN: GB39512475	30-Oct-14 (in house check Feb-19)	In house check: Oct-20
Power sensor HP 8481A	SN: US37292783	07-Oct-15 (in house check Oct-18)	In house check: Oct-20
Power sensor HP 8481A	SN: MY41092317	07-Oct-15 (in house check Oct-18)	In house check: Oct-20
RF generator R&S SMT-06	SN: 100972	15-Jun-15 (in house check Oct-18)	In house check: Oct-20
Network Analyzer Agilent E8358A	SN: US41080477	31-Mar-14 (in house check Oct-19)	In house check: Oct-20

	Name	Function	Signature
Calibrated by:	Jeffrey Katzman	Laboratory Technician	
Approved by:	Katja Pokovic	Technical Manager	

Issued: August 14, 2020

This calibration certificate shall not be reproduced except in full without written approval of the laboratory.