

SAR Test Report

Report No. : SFBEDW-WTW-P20080369
Applicant : HON HAI Precision Ind. Co., Ltd.
Address : 5F-1, 5 Hsin-An Road Hsinchu, Science-Based Industrial Park, Hsinchu,
Taiwan, R.O.C
Product : LTE M.2 Module
FCC ID : MCLT77W968-D11
Brand : FOXCONN
Model No. : T77W968
Standards : FCC 47 CFR Part 2 (2.1093), IEEE C95.1:1992, IEEE Std 1528:2013
KDB 865664 D01 v01r04, KDB 865664 D02 v01r02
KDB 248227 D01 v02r02, KDB 447498 D01 v06, KDB 616217 D04 v01r02
KDB 941225 D01 v03r01, KDB 941225 D05 v02r05, KDB 941225 D05A v01r02
Sample Received Date : Aug. 21, 2020
Date of Testing : Nov. 08, 2020 ~ Nov. 28, 2020
Lab Address : No. 47-2, 14th Ling, Chia Pau Vil., Lin Kou Dist., New Taipei City, Taiwan
Test Location : No. 19, Hwa Ya 2nd Rd., Wen Hwa Vil., Kwei Shan Dist., Taoyuan City, Taiwan

CERTIFICATION: The above equipment have been tested by **Bureau Veritas Consumer Products Services (H.K.) Ltd., Taoyuan Branch–Lin Kou Laboratories**, and found compliance with the requirement of the above standards. The test record, data evaluation & Equipment Under Test (EUT) configurations represented herein are true and accurate accounts of the measurements of the sample's SAR characteristics under the conditions specified in this report. It should not be reproduced except in full, without the written approval of our laboratory. The client should not use it to claim product certification, approval, or endorsement by TAF or any government agencies.

Prepared By : 
 Shelly Hsueh / Specialist

Approved By : 
 Gordon Lin / Manager



FCC Accredited No.: TW0003

This report is for your exclusive use. Any copying or replication of this report to or for any other person or entity, or use of our name or trademark, is permitted only with our prior written permission. This report sets forth our findings solely with respect to the test samples identified herein. The results set forth in this report are not indicative or representative of the quality or characteristics of the lot from which a test sample was taken or any similar or identical product unless specifically and expressly noted. Our report includes all of the tests requested by you and the results thereof based upon the information that you provided to us. You have 60 days from date of issuance of this report to notify us of any material error or omission caused by our negligence, provided, however, that such notice shall be in writing and shall specifically address the issue you wish to raise. A failure to raise such issue within the prescribed time shall constitute your unqualified acceptance of the completeness of this report, the tests conducted and the correctness of the report contents. Unless specific mention, the uncertainty of measurement has been explicitly taken into account to declare the compliance or non-compliance to the specification.

Table of Contents

Release Control Record	3
1. Summary of Maximum SAR Value	4
2. Description of Equipment Under Test	6
3. SAR Measurement System	8
3.1 Definition of Specific Absorption Rate (SAR)	8
3.2 SPEAG DASY6 System	8
3.2.1 Robot.....	9
3.2.2 Probes.....	10
3.2.3 Data Acquisition Electronics (DAE)	10
3.2.4 Phantoms	10
3.2.5 Device Holder.....	11
3.2.6 System Validation Dipoles.....	12
3.2.7 Power Source.....	12
3.2.8 Tissue Simulating Liquids.....	13
3.3 SAR System Verification	15
3.4 SAR Measurement Procedure	16
3.4.1 Area Scan and Zoom Scan Procedure.....	16
3.4.2 Volume Scan Procedure.....	17
3.4.3 Power Drift Monitoring.....	18
3.4.4 Spatial Peak SAR Evaluation	18
3.4.5 SAR Averaged Methods	18
4. SAR Measurement Evaluation	19
4.1 EUT Configuration and Setting.....	19
4.2 EUT Testing Position	28
4.2.1 Body Exposure Conditions	28
4.3 Tissue Verification	29
4.4 System Validation.....	30
4.5 System Verification.....	31
4.6 Maximum Output Power.....	31
4.6.1 Maximum Target Conducted Power	31
4.6.2 Measured Conducted Power Result.....	31
4.7 SAR Testing Results	32
4.7.1 SAR Test Reduction Considerations	32
4.7.2 SAR Results for Body Exposure Condition	34
4.7.3 SAR Measurement Variability.....	40
4.7.4 Simultaneous Multi-band Transmission Evaluation	41
5. Calibration of Test Equipment.....	43
6. Measurement Uncertainty.....	44
7. Information of the Testing Laboratories.....	48
Appendix A. SAR Plots of System Verification	
Appendix B. SAR Plots of SAR Measurement	
Appendix C. Calibration Certificate for Probe and Dipole	
Appendix D. Photographs of EUT and Setup	
Appendix E. Maximum Target Conducted Power	
Appendix F. Measured Conducted Power Result	
Appendix G. Analysis of Simultaneous Transmission SAR	
Appendix H. SAR to Peak Location Separation Ratio Analysis	



Release Control Record

Report No.	Reason for Change	Date Issued
SFBEDW-WTW-P20080369	Initial release	Dec. 07, 2020

SAR Test Report

1. Summary of Maximum SAR Value

Equipment Class	Table Mode		Laptop Mode	
	Mode	Highest SAR-1g Body (W/kg)	Mode	Highest SAR-1g Body (W/kg)
PCE	WCDMA II	0.36	WCDMA II	0
	WCDMA IV	1.19	WCDMA IV	0
	WCDMA V	0.67	WCDMA V	0
	LTE 2	0.72	LTE 2	N/A
	LTE 4	1.20	LTE 4	N/A
	LTE 5	0.80	LTE 5	N/A
	LTE 7	1.19	LTE 7	0
	LTE 12 / 17	1.36	LTE 12 / 17	0
	LTE 13	0.78	LTE 13	0
	LTE 14	1.11	LTE 14	0
	LTE 25	0.42	LTE 25 / 2	0
	LTE 26	0.81	LTE 26 / 5	0
	LTE 30	1.01	LTE 30	0
	LTE 38	0.97	LTE 38	N/A
LTE 41	1.03	LTE 41 / 38	0	
LTE 66	1.26	LTE 66 / 4	0	
DTS	2.4G WLAN	0	2.4G WLAN	N/A
NII	5.3G WLAN	0	5.3G WLAN	N/A
	5.6G WLAN	0	5.6G WLAN	N/A
	5.8G WLAN	0	5.8G WLAN	N/A
DSS	Bluetooth	0	Bluetooth	N/A

Highest Simultaneous Transmission SAR	Highest SAR-1g Body/Limb (W/kg)	
	Table Mode	Laptop Mode
	1.45	N/A

SAR Test Report

Note:

1. The SAR criteria (**Head & Body: SAR-1g1.6 W/kg, and Extremity: SAR-10g 4.0 W/kg**) for general population/uncontrolled exposure is specified in FCC 47 CFR part 2 (2.1093) and ANSI/IEEE C95.1-1992.
2. For SAR test result of WLAN / BT module AX201D2W, only left side, right side and top side of tablet mode are tested in this report, the other test data please refer to Intel Report No.: 200914-02.TR06 & 200914-02.TR07.
3. This device supports both LTE band 12 and band 17. The frequency span of LTE band 12 can completely cover LTE band 17, and they has the same tune-up power. SAR was tested for LTE band 12 only for tablet and laptop mode.
4. This device supports both LTE band 66 and band 4. The frequency span of LTE band 66 can completely cover LTE band 4, and they has the same tune-up power. SAR was tested for LTE band 66 only for laptop mode.
5. This device supports both LTE band 25 and band 2. The frequency span of LTE band 25 can completely cover LTE band 2, and they has the same tune-up power. SAR was tested for LTE band 25 only for laptop mode.
6. This device supports both LTE band 26 and band 5. The frequency span of LTE band 26 can completely cover LTE band 5, and they has the same tune-up power. SAR was tested for LTE band 26 only for laptop mode.
7. This device supports both LTE band 41 and band 38. The frequency span of LTE band 41 can completely cover LTE band 38, and they has the same tune-up power. SAR was tested for LTE band 41 only for laptop mode.

SAR Test Report

2. Description of Equipment Under Test

EUT Type	LTE M.2 Module
FCC ID	MCLT77W968-D11
Brand Name	FOXCONN
Model Name	T77W968
Tx Frequency Bands (Unit: MHz)	WCDMA Band II : 1852.4 ~ 1907.6 WCDMA Band IV : 1712.4 ~ 1752.6 WCDMA Band V : 826.4 ~ 846.6 LTE Band 2 : 1850.7 ~ 1909.3 (BW: 1.4M, 3M, 5M, 10M, 15M, 20M) LTE Band 4 : 1710.7 ~ 1754.3 (BW: 1.4M, 3M, 5M, 10M, 15M, 20M) LTE Band 5 : 824.7 ~ 848.3 (BW: 1.4M, 3M, 5M, 10M) LTE Band 7 : 2502.5 ~ 2567.5 (BW: 5M, 10M, 15M, 20M) LTE Band 12 : 699.7 ~ 715.3 (BW: 1.4M, 3M, 5M, 10M) LTE Band 13 : 779.5 ~ 784.5 (BW: 5M, 10M) LTE Band 14 : 790.5 ~ 795.5 (BW: 5M, 10M) LTE Band 17 : 706.5 ~ 713.5 (BW: 5M, 10M) LTE Band 25 : 1850.7 ~ 1914.3 (BW: 1.4M, 3M, 5M, 10M, 15M, 20M) LTE Band 26 : 814.7 ~ 848.3 (BW: 1.4M, 3M, 5M, 10M, 15M) (LTE Band 30 : 2307.5 ~ 2312.5 (BW: 5M, 10M) LTE Band 38 : 2572.5 ~ 2617.5 (BW: 5M, 10M, 15M, 20M) LTE Band 41 : 2498.5 ~ 2687.5 (BW: 5M, 10M, 15M, 20M) LTE Band 66 : 1710.7 ~ 1779.3 (BW: 1.4M, 3M, 5M, 10M, 15M, 20M) WLAN : 2412 ~ 2462, 5180 ~ 5240, 5260 ~ 5320, 5500 ~ 5700, 5745 ~ 5825 Bluetooth : 2402 ~ 2480
Uplink Modulations	WCDMA : QPSK LTE : QPSK, 16QAM, 64QAM
Maximum Tune-up Conducted Power (Unit: dBm)	Please refer to section 4.6.1 of this report
Antenna Type	Refer to Note as below
EUT Stage	Engineering Sample

Note:

1. The EUT is authorized for use in specific End-product. Please refer to below for more details.

Product	Brand	Model
Portable Computer	DELL	P136G

2. For SAR test result of WLAN / BT module AX201D2W, please refer to Intel Report No.: 200914-02.TR06 & 200914-02.TR07.

SAR Test Report

3. The antenna information of End-product is listed as below.

<WWAN>

Ant. Type	Manuf.	Parts Number	WWAN Antenna Gain (dBi)													
			WCDMA II / LTE 2	WCDMA IV / LTE 4	WCDMA V / LTE 5	LTE 7	LTE 12	LTE 13	LTE 14	LTE 17	LTE 25	LTE 26	LTE 30	LTE 38	LTE 41	LTE 66
PIFA	WNC	81ELAW15.G06 (DC33002H40L)	-2.1	-5.49	-2.15	2.89	-11.54	-4.72	-4.22	-11.54	-0.91	-2.15	1.27	-1.27	2.89	-4.88
	Speed	F-0G-FH-6119-01-00	0.18	-0.46	-5.84	-0.75	-3.17	-0.12	0.18	-3.17	0.47	-6.24	0.97	2.78	-0.28	-0.46

<WLAN>

Antenna information				Peak gain w/ cable loss (dBi)			
Vendor	Type	Antenna Part number (Main)	Antenna Part number (Aux)	BT/WLAN 2.4 GHz	WLAN 5.15~5.35 GHz	WLAN 5.47~5.725 GHz	WLAN 5.725~5.85 GHz
Speed	PIFA	F-0G-FH-6119-003-00 (DC33002H81L)	F-0G-FH-6119-003-00 (DC33002H81L)	0.16	0.67	1.42	1.61
WNC	PIFA	81ELAW15.G08 (DC33002H71L)	81ELAW15.G08 (DC33002H71L)	0.59	2.05	.076	1.5
Hong-BO Co., Ltd.	PIFA	260-24329 (DC33002H30L)	260-24329 (DC33002H30L)	0.84	0.27	0.04	0.76

4. The above EUT information is declared by manufacturer and for more detailed features description please refers to the manufacturer's specifications or User's Manual.

3. SAR Measurement System

3.1 Definition of Specific Absorption Rate (SAR)

SAR is related to the rate at which energy is absorbed per unit mass in an object exposed to a radio field. The SAR distribution in a biological body is complicated and is usually carried out by experimental techniques or numerical modeling. The standard recommends limits for two tiers of groups, occupational/controlled and general population/uncontrolled, based on a person's awareness and ability to exercise control over his or her exposure. In general, occupational/controlled exposure limits are higher than the limits for general population/uncontrolled.

The SAR definition is the time derivative (rate) of the incremental energy (dW) absorbed by (dissipated in) an incremental mass (dm) contained in a volume element (dv) of a given density (ρ). The equation description is as below:

$$\text{SAR} = \frac{d}{dt} \left(\frac{dW}{dm} \right) = \frac{d}{dt} \left(\frac{dW}{\rho dv} \right)$$

SAR is expressed in units of Watts per kilogram (W/kg)

SAR measurement can be related to the electrical field in the tissue by

$$\text{SAR} = \frac{\sigma |E|^2}{\rho}$$

Where: σ is the conductivity of the tissue, ρ is the mass density of the tissue and E is the RMS electrical field strength.

3.2 SPEAG DASY6 System

DASY6 system consists of high precision robot, probe alignment sensor, phantom, robot controller, controlled measurement server and near-field probe. The robot includes six axes that can move to the precision position of the DASY6 software defined. The DASY6 software can define the area that is detected by the probe. The robot is connected to controlled box. Controlled measurement server is connected to the controlled robot box. The DAE includes amplifier, signal multiplexing, AD converter, offset measurement and surface detection. It is connected to the Electro-optical coupler (ECO). The ECO performs the conversion from the optical into digital electric signal of the DAE and transfers data to the PC.

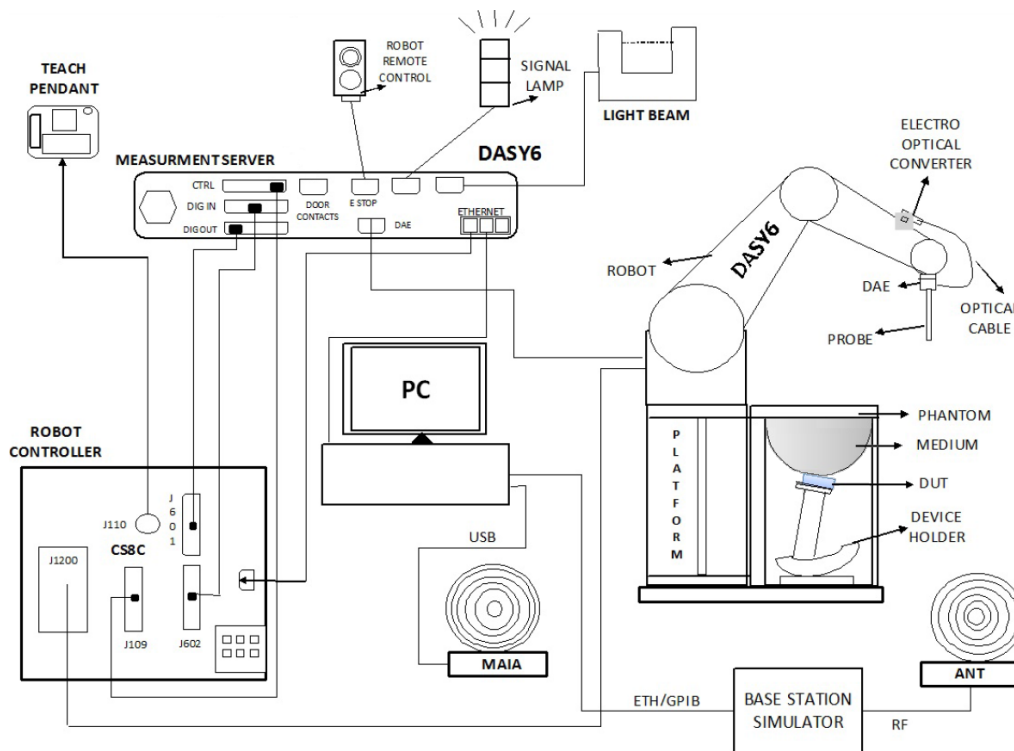

Fig-3.1 SPEAG DASY6 System Setup

3.2.1 Robot

The DASY6 system uses the high precision robots from Stäubli SA (France). For the 6-axis controller system, the robot controller version of CS8c from Stäubli is used. The Stäubli robot series have many features that are important for our application:

- High precision (repeatability ± 0.035 mm)
- High reliability (industrial design)
- Jerk-free straight movements
- Low ELF interference (the closed metallic construction shields against motor control fields)



Fig-3.2 SPEAG DASY6 System

SAR Test Report

3.2.2 Probes

The SAR measurement is conducted with the dosimetric probe. The probe is specially designed and calibrated for use in liquid with high permittivity. The dosimetric probe has special calibration in liquid at different frequency.

Model	EX3DV4	
Construction	Symmetrical design with triangular core. Built-in shielding against static charges. PEEK enclosure material (resistant to organic solvents, e.g., DGBE).	
Frequency	4 MHz to 10 GHz Linearity: ± 0.2 dB	
Directivity	± 0.1 dB in TSL (rotation around probe axis) ± 0.3 dB in TSL (rotation normal to probe axis)	
Dynamic Range	10 μ W/g to 100 mW/g Linearity: ± 0.2 dB (noise: typically < 1 μ W/g)	
Dimensions	Overall length: 337 mm (Tip: 20 mm) Tip diameter: 2.5 mm (Body: 12 mm) Typical distance from probe tip to dipole centers: 1 mm	

3.2.3 Data Acquisition Electronics (DAE)

Model	DAE3, DAE4	
Construction	Signal amplifier, multiplexer, A/D converter and control logic. Serial optical link for communication with DASY embedded system (fully remote controlled). Two step probe touch detector for mechanical surface detection and emergency robot stop.	
Measurement Range	-100 to +300 mV (16 bit resolution and two range settings: 4mV, 400mV)	
Input Offset Voltage	$< 5\mu$ V (with auto zero)	
Input Bias Current	< 50 fA	
Dimensions	60 x 60 x 68 mm	

3.2.4 Phantoms

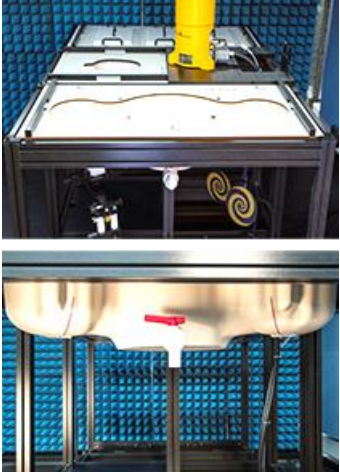
Model	SAM-Twin Phantom	
Construction	The shell corresponds to the specifications of the Specific Anthropomorphic Mannequin (SAM) phantom defined in IEEE Std 1528 and IEC 62209-1. It enables the dosimetric evaluation of left and right hand phone usage as well as body-mounted usage at the flat phantom region. A cover prevents evaporation of the liquid. Reference markings on the phantom allow the complete setup of all predefined phantom positions and measurement grids by teaching three points with the robot.	
Material	Vinylester, fiberglass reinforced (VE-GF)	
Shell Thickness	2 \pm 0.2 mm (6 \pm 0.2 mm at ear point)	
Dimensions	Length: 1000 mm Width: 500 mm Height: adjustable feet	
Filling Volume	approx. 25 liters	

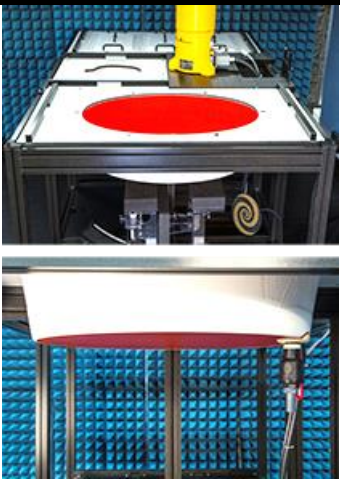
Model	ELI	
Construction	The ELI phantom is used for compliance testing of handheld and body-mounted wireless devices. ELI is fully compatible with the IEC 62209-2 standard and all known tissue simulating liquids. ELI has been optimized regarding its performance and can be integrated into our standard phantom tables. A cover prevents evaporation of the liquid. Reference markings on the phantom allow installation of the complete setup, including all predefined phantom positions and measurement grids, by teaching three points. The phantom is compatible with all SPEAG dosimetric probes and dipoles.	
Material	Vinylester, fiberglass reinforced (VE-GF)	
Shell Thickness	2.0 ± 0.2 mm (bottom plate)	
Dimensions	Major axis: 600 mm Minor axis: 400 mm	
Filling Volume	approx. 30 liters	

3.2.5 Device Holder

Model	MD4HHTV5 - Mounting Device for Hand-Held Transmitters	
Construction	In combination with the Twin SAM or ELI phantoms, the Mounting Device for Hand-Held Transmitters enables rotation of the mounted transmitter device to specified spherical coordinates. At the heads, the rotation axis is at the ear opening. Transmitter devices can be easily and accurately positioned according to IEC 62209-1, IEEE 1528, FCC, or other specifications. The device holder can be locked for positioning at different phantom sections (left head, right head, flat).	
Material	Polyoxymethylene (POM)	

Model	MDA4WTV5 - Mounting Device Adaptor for Ultra Wide Transmitters	
Construction	An upgrade kit to Mounting Device to enable easy mounting of wider devices like big smart-phones, e-books, small tablets, etc. It holds devices with width up to 140 mm.	
Material	Polyoxymethylene (POM)	

Model	MDA4SPV6 - Mounting Device Adaptor for Smart Phones	
Construction	The solid low-density MDA4SPV6 adaptor assuring no impact on the DUT radiation performance and is conform with any DUT design and shape.	
Material	ROHACELL	

SAR Test Report

Model	MD4LAPV5 - Mounting Device for Laptops and other Body-Worn Transmitters	
Construction	In combination with the Twin SAM or ELI phantoms, the Mounting Device (Body-Worn) enables testing of transmitter devices according to IEC 62209-2 specifications. The device holder can be locked for positioning at a flat phantom section.	
Material	Polyoxymethylene (POM), PET-G, Foam	

3.2.6 System Validation Dipoles

Model	D-Serial	
Construction	Symmetrical dipole with 1/4 balun. Enables measurement of feed point impedance with NWA. Matched for use near flat phantoms filled with tissue simulating solutions.	
Frequency	750 MHz to 5800 MHz	
Return Loss	> 20 dB	
Power Capability	> 100 W (f < 1GHz), > 40 W (f > 1GHz)	

3.2.7 Power Source

Model	Powersource1	
Signal Type	Continuous Wave	
Operating Frequencies	600 MHz to 5850 MHz	
Output Power	-5.0 dBm to +17.0 dBm	
Power Supply	5V DC, via USB jack	
Power Consumption	<3 W	
Applications	System performance check and validation with a CW signal.	

SAR Test Report

3.2.8 Tissue Simulating Liquids

For SAR measurement of the field distribution inside the phantom, the phantom must be filled with homogeneous tissue simulating liquid to a depth of at least 15 cm. For head SAR testing, the liquid height from the ear reference point (ERP) of the phantom to the liquid top surface is larger than 15 cm. For body SAR testing, the liquid height from the center of the flat phantom to the liquid top surface is larger than 15 cm. The nominal dielectric values of the tissue simulating liquids in the phantom and the tolerance of 10 % are listed in Table-3.1.

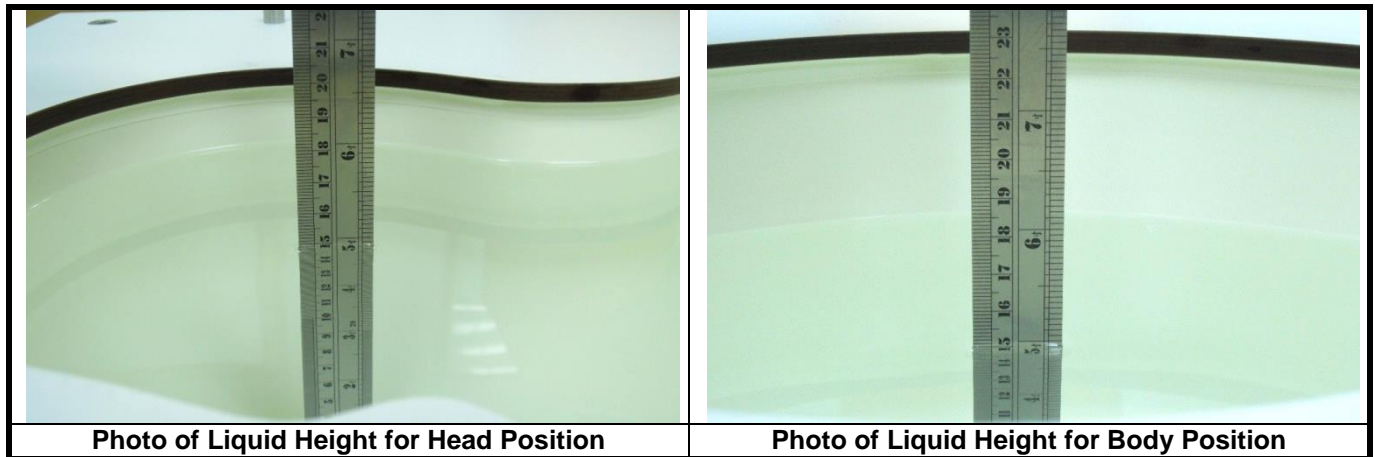

Table-3.1 Targets of Tissue Simulating Liquid

Frequency (MHz)	Target Permittivity	Range of $\pm 10\%$	Target Conductivity	Range of $\pm 10\%$
450	43.5	39.2 ~ 47.9	0.87	0.78 ~ 0.96
750	41.9	37.7 ~ 46.1	0.89	0.80 ~ 0.98
835	41.5	37.4 ~ 45.7	0.90	0.81 ~ 0.99
900	41.5	37.4 ~ 45.7	0.97	0.87 ~ 1.07
1450	40.5	36.5 ~ 44.6	1.20	1.08 ~ 1.32
1500	40.4	36.4 ~ 44.4	1.23	1.11 ~ 1.35
1640	40.2	36.2 ~ 44.2	1.31	1.18 ~ 1.44
1750	40.1	36.1 ~ 44.1	1.37	1.23 ~ 1.51
1800	40.0	36.0 ~ 44.0	1.40	1.26 ~ 1.54
1900	40.0	36.0 ~ 44.0	1.40	1.26 ~ 1.54
2000	40.0	36.0 ~ 44.0	1.40	1.26 ~ 1.54
2100	39.8	35.8 ~ 43.8	1.49	1.34 ~ 1.64
2300	39.5	35.6 ~ 43.5	1.67	1.50 ~ 1.84
2450	39.2	35.3 ~ 43.1	1.80	1.62 ~ 1.98
2600	39.0	35.1 ~ 42.9	1.96	1.76 ~ 2.16
3000	38.5	34.7 ~ 42.4	2.40	2.16 ~ 2.64
3500	37.9	34.1 ~ 41.7	2.91	2.62 ~ 3.20
4000	37.4	33.7 ~ 41.1	3.43	3.09 ~ 3.77
4500	36.8	33.1 ~ 40.5	3.94	3.55 ~ 4.33
5000	36.2	32.6 ~ 39.8	4.45	4.01 ~ 4.90
5200	36.0	32.4 ~ 39.6	4.66	4.19 ~ 5.13
5400	35.8	32.2 ~ 39.4	4.86	4.37 ~ 5.35
5600	35.5	32.0 ~ 39.1	5.07	4.56 ~ 5.58
5800	35.3	31.8 ~ 38.8	5.27	4.74 ~ 5.80
6000	35.1	31.6 ~ 38.6	5.48	4.93 ~ 6.03

SAR Test Report

The dielectric properties of the tissue simulating liquids are defined in IEC 62209-1 and IEC 62209-2. The dielectric properties of the tissue simulating liquids were verified prior to the SAR evaluation using a dielectric assessment kit and a network analyzer.

Since the range of $\pm 10\%$ of the required target values is used to measure relative permittivity and conductivity, the SAR correction procedure is applied to correct measured SAR for the deviations in permittivity and conductivity. Only positive correction has been used to scale up the measured SAR, and SAR result would not be corrected if the correction Δ SAR has a negative sign.

The following table gives the recipes for tissue simulating liquids.

Table-3.2 Recipes of Tissue Simulating Liquid

Tissue Type	Bactericide	DGBE	HEC	NaCl	Sucrose	Triton X-100	Water	Diethylene Glycol Mono-hexylether
H750	0.2	-	0.2	1.5	56.0	-	42.1	-
H835	0.2	-	0.2	1.5	57.0	-	41.1	-
H900	0.2	-	0.2	1.4	58.0	-	40.2	-
H1450	-	43.3	-	0.6	-	-	56.1	-
H1640	-	45.8	-	0.5	-	-	53.7	-
H1750	-	47.0	-	0.4	-	-	52.6	-
H1800	-	44.5	-	0.3	-	-	55.2	-
H1900	-	44.5	-	0.2	-	-	55.3	-
H2000	-	44.5	-	0.1	-	-	55.4	-
H2300	-	44.9	-	0.1	-	-	55.0	-
H2450	-	45.0	-	0.1	-	-	54.9	-
H2600	-	45.1	-	0.1	-	-	54.8	-
H3500	-	8.0	-	0.2	-	20.0	71.8	-
H5G	-	-	-	-	-	17.2	65.5	17.3

3.3 SAR System Verification

The system check verifies that the system operates within its specifications. It is performed daily or before every SAR measurement. The system check uses normal SAR measurements in the flat section of the phantom with a matched dipole at a specified distance. The system verification setup is shown as below.

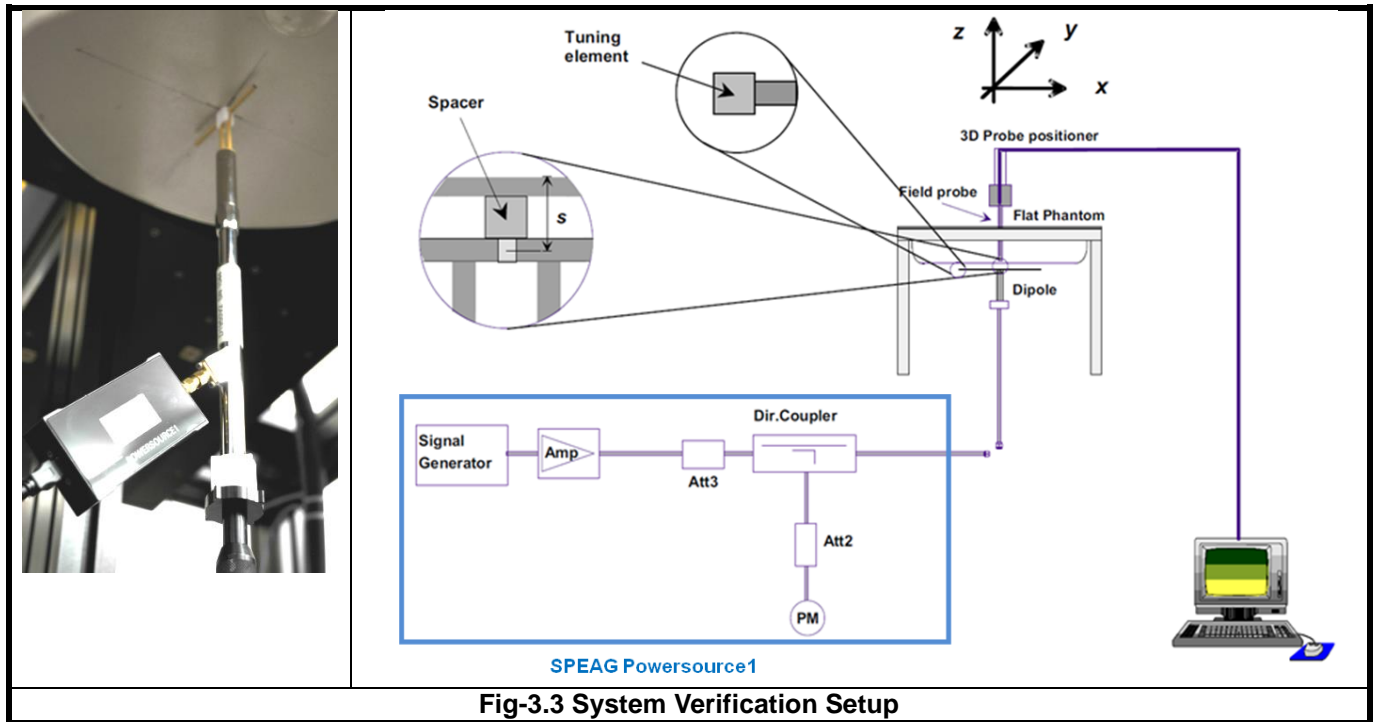

Fig-3.3 System Verification Setup

The SPEAG Powersource1 is a portable and very stable RF source providing a continuous wave (CW) signal. It is designed for conducting SAR system checks and SAR system validation of DASY and is compatible with IEC 62209-1, IEC 62209-2 and IEEE Std 1528 standards. The Powersource1 has been calibrated by SPEAG's ISO/IEC 17025-accredited calibration center. When using Powersource1, the setup can be simplified, as shown in Fig-3.3. The signal purity is warranted by design. Since the Powersource1 is calibrated, no additional equipment is needed and the Powersource1 can directly be connected to the SMA connector of the dipole without a cable as all separate components (signal generator, amplifier, coupler and power meter) are built into the unit.

The validation dipole is placed beneath the flat phantom with the specific spacer in place. The distance spacer is touch the phantom surface with a light pressure at the reference marking and be oriented parallel to the long side of the phantom. The Powersource1 is adjusted for the desired forward power of 17 dBm at the dipole connector and the RF output power would be turned on. After system check testing, the SAR result will be normalized to 1W forward input power and compared with the reference SAR value derived from validation dipole certificate report. The deviation of system check should be within 10 %.

3.4 SAR Measurement Procedure

According to the SAR test standard, the recommended procedure for assessing the peak spatial-average SAR value consists of the following steps:

- (a) Power reference measurement
- (b) Area scan
- (c) Zoom scan
- (d) Power drift measurement

The SAR measurement procedures for each of test conditions are as follows:

- (a) Make EUT to transmit maximum output power
- (b) Measure conducted output power through RF cable
- (c) Place the EUT in the specific position of phantom
- (d) Perform SAR testing steps on the DASY system
- (e) Record the SAR value

3.4.1 Area Scan and Zoom Scan Procedure

First area scan is used to locate the approximate location(s) of the local peak SAR value(s). The measurement grid within an area scan is defined by the grid extent, grid step size and grid offset. Next, in order to determine the EM field distribution in a three-dimensional spatial extension, zoom scan is required. The zoom scan is performed around the highest E-field value to determine the averaged SAR-distribution.

Measure the local SAR at a test point at 1.4 mm of the inner surface of the phantom recommended by SEPAG. The area scan (two-dimensional SAR distribution) is performed cover at least an area larger than the projection of the EUT or antenna. The measurement resolution and spatial resolution for interpolation shall be chosen to allow identification of the local peak locations to within one-half of the linear dimension of the corresponding side of the zoom scan volume. Following table provides the measurement parameters required for the area scan.

Parameter	$f \leq 3 \text{ GHz}$	$3 \text{ GHz} < f \leq 6 \text{ GHz}$
Maximum distance from closest measurement point to phantom surface	5 ± 1	$\delta \ln(2)/2 \pm 0.5$
Maximum probe angle from probe axis to phantom surface normal at the measurement location	$30^\circ \pm 1^\circ$	$20^\circ \pm 1^\circ$
Maximum area scan spatial resolution: $\Delta x_{\text{Area}}, \Delta y_{\text{Area}}$	$\leq 2 \text{ GHz: } \leq 15 \text{ mm}$ $2 - 3 \text{ GHz: } \leq 12 \text{ mm}$	$3 - 4 \text{ GHz: } \leq 12 \text{ mm}$ $4 - 6 \text{ GHz: } \leq 10 \text{ mm}$

From the scanned SAR distribution, identify the position of the maximum SAR value, in addition identify the positions of any local maxima with SAR values within 2 dB of the maximum value that will not be within the zoom scan of other peaks. Additional peaks shall be measured only when the primary peak is within 2 dB of the SAR compliance limit (e.g. 1 W/kg for 1.6 W/kg, 1 g limit; or 1.26 W/kg for 2 W/kg, 10 g limit).

The zoom scan (three-dimensional SAR distribution) is performed at the local maxima locations identified in previous area scan procedure. The zoom scan volume must be larger than the required minimum dimensions. When graded grids are used, which only applies in the direction normal to the phantom surface, the initial grid separation closest to the phantom surface and subsequent graded grid increment ratios must satisfy the required protocols. The 1-g SAR averaging volume must be fully contained within the zoom scan measurement volume boundaries; otherwise, the measurement must be repeated by shifting or expanding the zoom scan volume. The similar requirements also apply to 10-g SAR measurements. Following table provides the measurement parameters required for the zoom scan.

Parameter		$f \leq 3$ GHz	$3 \text{ GHz} < f \leq 6$ GHz
Maximum zoom scan spatial resolution: $\Delta x_{\text{Zoom}}, \Delta y_{\text{Zoom}}$		≤ 2 GHz: ≤ 8 mm 2 – 3 GHz: ≤ 5 mm	3 – 4 GHz: ≤ 5 mm 4 – 6 GHz: ≤ 4 mm
Maximum zoom scan spatial resolution, normal to phantom surface	<i>uniform grid:</i> $\Delta z_{\text{Zoom}}(n)$	≤ 5 mm	3 – 4 GHz: ≤ 4 mm 4 – 5 GHz: ≤ 3 mm 5 – 6 GHz: ≤ 2 mm
	<i>graded grids:</i> $\Delta z_{\text{Zoom}}(1)$	≤ 4 mm	3 – 4 GHz: ≤ 3.0 mm 4 – 5 GHz: ≤ 2.5 mm 5 – 6 GHz: ≤ 2.0 mm
	$\Delta z_{\text{Zoom}}(n>1)$	$\leq 1.5 \cdot \Delta z_{\text{Zoom}}(n-1)$ mm	
Minimum zoom scan volume (x, y, z)		≥ 30 mm	3 – 4 GHz: ≥ 28 mm 4 – 5 GHz: ≥ 25 mm 5 – 6 GHz: ≥ 22 mm

Per IEC 62209-2 AMD1, the successively higher resolution zoom scan is required if the zoom scan measured as defined above complies with both of the following criteria, or if the peak spatial-average SAR is below 0.1 W/kg, no additional measurements are needed:

- (1) The smallest horizontal distance from the local SAR peaks to all points 3 dB below the SAR peak shall be larger than the horizontal grid steps in both x and y directions ($\Delta x, \Delta y$). This shall be checked for the measured zoom scan plane conformal to the phantom at the distance z_{M1} .
- (2) The ratio of the SAR at the second measured point (M2) to the SAR at the closest measured point (M1) at the x-y location of the measured maximum SAR value shall be at least 30 %.

If one or both of the above criteria are not met, the zoom scan measurement shall be repeated using a finer resolution. New horizontal and vertical grid steps shall be determined from the measured SAR distribution so that the above criteria are met. Compliance with the above two criteria shall be demonstrated for the new measured zoom scan.

3.4.2 Volume Scan Procedure

The volume scan is used for assess overlapping SAR distributions for antennas transmitting in different frequency bands. It is equivalent to an oversized zoom scan used in standalone measurements. The measurement volume will be used to enclose all the simultaneous transmitting antennas. For antennas transmitting simultaneously in different frequency bands, the volume scan is measured separately in each frequency band. In order to sum correctly to compute the 1g aggregate SAR, the EUT remain in the same test position for all measurements and all volume scan use the same spatial resolution and grid spacing. When all volume scan were completed, the software, SEMCAD postprocessor can combine and subsequently superpose these measurement data to calculating the multiband SAR.

3.4.3 Power Drift Monitoring

All SAR testing is under the EUT install full charged battery and transmit maximum output power. In DASY measurement software, the power reference measurement and power drift measurement procedures are used for monitoring the power drift of EUT during SAR test. Both these procedures measure the field at a specified reference position before and after the SAR testing. The software will calculate the field difference in dB. If the power drift more than 5%, the SAR will be retested.

3.4.4 Spatial Peak SAR Evaluation

The procedure for spatial peak SAR evaluation has been implemented according to the test standard. It can be conducted for 1g and 10g, as well as for user-specific masses. The DASY software includes all numerical procedures necessary to evaluate the spatial peak SAR value.

The base for the evaluation is a "cube" measurement. The measured volume must include the 1g and 10g cubes with the highest averaged SAR values. For that purpose, the center of the measured volume is aligned to the interpolated peak SAR value of a previously performed area scan.

The entire evaluation of the spatial peak values is performed within the post-processing engine (SEMCAD). The system always gives the maximum values for the 1g and 10g cubes. The algorithm to find the cube with highest averaged SAR is divided into the following stages:

- (a) Extraction of the measured data (grid and values) from the Zoom Scan
- (b) Calculation of the SAR value at every measurement point based on all stored data (A/D values and measurement parameters)
- (c) Generation of a high-resolution mesh within the measured volume
- (d) Interpolation of all measured values from the measurement grid to the high-resolution grid
- (e) Extrapolation of the entire 3-D field distribution to the phantom surface over the distance from sensor to surface
- (f) Calculation of the averaged SAR within masses of 1g and 10g

3.4.5 SAR Averaged Methods

In DASY, the interpolation and extrapolation are both based on the modified Quadratic Shepard's method. The interpolation scheme combines a least-square fitted function method and a weighted average method which are the two basic types of computational interpolation and approximation.

Extrapolation routines are used to obtain SAR values between the lowest measurement points and the inner phantom surface. The extrapolation distance is determined by the surface detection distance and the probe sensor offset. The uncertainty increases with the extrapolation distance. To keep the uncertainty within 1% for the 1 g and 10 g cubes, the extrapolation distance should not be larger than 5 mm.

4. SAR Measurement Evaluation

4.1 EUT Configuration and Setting

<Considerations Related to Gravity-Sensor>

The device supports WLAN capabilities. It is designed with a G-sensor which can trigger/not trigger power reduction for SAR compliance. The power levels for all wireless technologies and the power reduction please refer to section 4.6 of this report.

Gravity-Sensor Guidance(TCB Workshop November 2019)

The following guidance should be applied to laptops/tablets that use Hall Effect or gravity sensors to detect lid angle for the purpose of power reduction

- With the lid is in closed mode (0 degrees), open the screen in 10 degree steps until laptop mode is obtained
- Lower the screen 5 degrees. Closed mode should be reobtained. If not keep lowering in 5 degree steps.
- Open the screen in 1 degree steps until laptop mode is reobtained
- Continue opening the screen in 1 degree steps until at least 5 degrees past where laptop mode was obtained
- Then continue opening the screen in 10 degree steps until tablet mode is obtained
- Power measurements should be taken at each step
- Reverse this procedure going from tablet mode back down to closed mode

Depending on triggering mechanism the degree steps may need to be varied to verify mechanism operation

The Illustration of Lid Angle vs. Operating modes

DUT operating mode	View Angle
Tablet mode	190 degree < Lid Angle < 360 degree
Notebook mode	0 degree< Lid Angle < 190 degree

SAR Test Report

<Considerations Related to Proximity Sensor>

The device supports WWAN, WLAN, and Bluetooth capabilities. It is designed with a proximity sensor which can trigger/not trigger power reduction for WCDMA and LTE on Top Side of EUT for SAR compliance. Others RF capability (WLAN and Bluetooth) have no power reduction. The power levels for all wireless technologies and the power reduction please refer to section 4.6 of this report.

Proximity Sensor Triggering Distances (KDB 616217 D04 §6.2)

The proximity sensor triggering distance was determined per KDB 616217 for rear face and applicable edge. Summary for power verification per distance was tabulated in the below table.

Output Power Verification in dBm for EUT Top Edge											
Distance (mm)	22	23	24	25	26	27	28	29	30	31	32
WCDMA II	18.5	18.5	19.0	18.7	19.0	18.7	23.7	23.5	23.8	23.8	23.8
WCDMA IV	21.9	21.7	21.4	21.7	21.5	21.7	23.9	24.2	24.0	24.0	23.8
WCDMA V	20.8	20.6	20.6	20.6	20.7	20.9	23.8	24.0	23.7	23.9	24.0
LTE 2	19.7	19.3	19.6	19.5	19.8	19.3	23.3	23.4	23.8	23.4	23.8
LTE 4	21.8	21.9	21.7	21.8	22.1	22.0	23.5	23.7	23.5	23.7	23.7
LTE 5	20.6	20.7	20.6	20.7	20.6	20.7	23.7	23.7	23.4	23.4	23.3
LTE 7	18.7	19.0	18.6	19.0	18.7	18.5	24.3	24.3	24.3	23.9	24.4
LTE 13	22.3	22.4	22.0	22.0	22.4	22.0	23.5	23.9	23.8	23.5	24.0
LTE 14	21.2	21.1	21.4	21.0	21.1	21.1	23.6	23.7	23.7	23.9	23.7
LTE 25	18.7	18.6	18.8	19.0	18.7	18.9	23.2	23.7	23.7	23.5	23.4
LTE 26	21.0	21.4	21.4	21.4	21.4	21.3	23.8	23.6	23.4	23.8	23.9
LTE 30	18.7	18.6	18.7	18.7	18.8	18.5	22.6	22.7	22.4	22.6	22.8
LTE 38	20.4	20.6	20.6	20.6	20.3	20.4	23.9	24.0	24.2	24.3	24.2
LTE 41	19.9	20.1	20.0	20.1	20.1	20.4	24.4	24.2	24.0	24.1	24.2
LTE 66	21.8	21.9	22.0	21.9	21.6	21.8	23.7	23.8	23.8	23.7	23.5

Proximity Sensor Coverage (KDB 616217 D04 §6.3)

Since the proximity sensor is collocated with antenna in one component, the procedure for proximity sensor coverage is not required.

Proximity Sensor Tilt Angle Influences (KDB 616217 D04 §6.4)

The proximity sensor tilt angle influence was determined per KDB 616217 for applicable edge. Summary for proximity sensor tilt angle influence is shown in below.

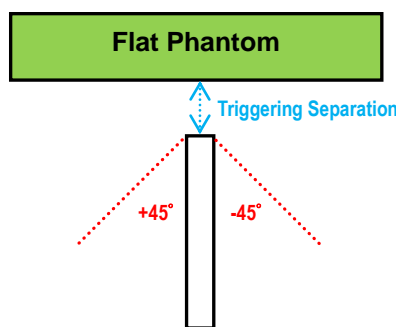

Orientation	Separation Distance (mm)	Tilt Angle										
		-45°	-40°	-30°	-20°	-10°	0°	10°	20°	30°	40°	45°
Top Edge	26	X	X	X	X	O	O	O	O	O	O	O
Top Edge	12	O	O	O	O	O	O	O	O	O	O	O

Summary for Proximity Sensor Triggering Test

According to the procedures noticed in KDB 616217 D04, the proximity sensor triggering distance is 24 mm for EUT Top Side. The separation distance of 10 mm determined by the smallest triggering distance on Top Side is used to access the tilt angle influence and the sensor does not release during ± 45 degree. Therefore, the smallest separation distance for tilt angle influence is 10 mm for the Top Side. The conservation triggering distances based on the separation distance for the sensor trigger / not triggered as EUT with power reduction at 0 mm, and EUT without power reduction at 9 mm for EUT Top Side were used to test SAR.

The power reduction is depends on the proximity sensor input. For a steady SAR test, the power reduction was enabled or disabled manually by engineering software during SAR testing.

<Connections between EUT and System Simulator>

For WWAN SAR testing, the EUT was linked and controlled by base station emulator. Communication between the EUT and the emulator was established by air link. The distance between the EUT and the communicating antenna of the emulator is larger than 50 cm and the output power radiated from the emulator antenna is at least 30 dB smaller than the output power of EUT. The EUT was set from the emulator to radiate maximum output power during SAR testing.

<Considerations Related to WCDMA for Setup and Testing>

Release 5 HSDPA Data Devices

The 3G SAR test reduction procedure is applied to body SAR with 12.2 kbps RMC as the primary mode. Otherwise, body SAR for HSDPA is measured using an FRC with H-Set 1 in Sub-test 1 and a 12.2 kbps RMC configured in Test Loop Mode 1, for the highest reported SAR configuration in 12.2 kbps RMC without HSDPA. HSDPA is configured according to the applicable UE category of a test device. The number of HS-DSCH/HS-PDSCHs, HARQ processes, minimum inter-TTI interval, transport block sizes and RV coding sequence are defined by the H-set. To maintain a consistent test configuration and stable transmission conditions, QPSK is used in the H-set for SAR testing. HS-DPCCH should be configured with a CQI feedback cycle of 4 ms and a CQI repetition factor of 2 to maintain a constant rate of active CQI slots. DPCCH and DPDCH gain factors (β_c , β_d), and HS-DPCCH power offset parameters (Δ_{ACK} , Δ_{NACK} , Δ_{CQI}) are set according to values indicated in below. The CQI value is determined by the UE category, transport block size, number of HS-PDSCHs and modulation used in the H-set.

SAR Test Report

Sub-test	β_c	β_d	β_d (SF)	β_c/β_d	$\beta_{HS}^{(1)(2)}$	CM ⁽³⁾ (dB)	MPR ⁽³⁾ (dB)
1	2/15	15/15	64	2/15	4/15	0.0	0.0
2	12/15 ⁽⁴⁾	15/15 ⁽⁴⁾	64	12/15 ⁽⁴⁾	24/15	1.0	0.0
3	15/15	8/15	64	15/8	30/15	1.5	0.5
4	15/15	4/15	64	15/4	30/15	1.5	0.5

Note 1: Δ_{ACK} , Δ_{NACK} and $\Delta_{CQI} = 30/15$ with $\beta_{HS} = 30/15 * \beta_c$.
 Note 2: For the HS-DPCCH power mask requirement test in clause 5.2C, 5.7A, and the Error Vector Magnitude (EVM) with HS-DPCCH test in clause 5.13.1A, and HSDPA EVM with phase discontinuity in clause 5.13.1AA, Δ_{ACK} and $\Delta_{NACK} = 30/15$ with $\beta_{HS} = 30/15 * \beta_c$, and $\Delta_{CQI} = 24/15$ with $\beta_{HS} = 24/15 * \beta_c$.
 Note 3: CM = 1 for $\beta_c/\beta_d = 12/15, \beta_{HS}/\beta_c = 24/15$. For all other combinations of DPDCH, DPCCH and HS-DPCCH the MPR is based on the relative CM difference. This is applicable for only UEs that support HSDPA in release 6 and later releases.
 Note 4: For subtest 2 the β_c/β_d ratio of 12/15 for the TFC during the measurement period (TF1, TF0) is achieved by setting the signalled gain factors for the reference TFC (TF1, TF1) to $\beta_c = 11/15$ and $\beta_d = 15/15$.

Release 6 HSPA Data Devices

The 3G SAR test reduction procedure is applied to body SAR with 12.2 kbps RMC as the primary mode. Otherwise, body SAR for HSPA is measured with E-DCH Sub-test 5, using H-Set 1 and QPSK for FRC and a 12.2 kbps RMC configured in Test Loop Mode 1 and power control algorithm 2, according to the highest reported body SAR configuration in 12.2 kbps RMC without HSPA. When VOIP applies to head exposure, the 3G SAR test reduction procedure is applied with 12.2 kbps RMC as the primary mode. Otherwise, the same HSPA configuration used for body SAR measurements are applied to head exposure testing. Due to inner loop power control requirements in HSPA, a communication test set is required for output power and SAR tests. The 12.2 kbps RMC, FRC H-set 1 and E-DCH configurations for HSPA are configured according to the β values indicated in below.

Sub-test	β_c	β_d	β_d (SF)	β_c/β_d	$\beta_{HS}^{(1)}$	β_{ec}	$\beta_{ed}^{(4)(5)}$	β_{ed} (SF)	β_{ed} (Codes)	CM ⁽²⁾ (dB)	MPR ⁽²⁾⁽⁶⁾ (dB)	AG ⁽⁵⁾ Index	E-TFCI
1	11/15 ⁽³⁾	15/15 ⁽³⁾	64	11/15 ⁽³⁾	22/15	209/225	1309/225	4	1	1.0	0.0	20	75
2	6/15	15/15	64	6/15	12/15	12/15	94/75	4	1	3.0	2.0	12	67
3	15/15	9/15	64	15/9	30/15	30/15	$\beta_{ed1}: 47/15$ $\beta_{ed2}: 47/15$	4 4	2	2.0	1.0	15	92
4	2/15	15/15	64	2/15	4/15	2/15	56/75	4	1	3.0	2.0	17	71
5	15/15	0	-	-	5/15	5/15	47/15	4	1	1.0	0.0	12	67

Note 1: For sub-test 1 to 4, Δ_{ACK} , Δ_{NACK} and $\Delta_{CQI} = 30/15$ with $\beta_{HS} = 30/15 * \beta_c$. For sub-test 5, Δ_{ACK} , Δ_{NACK} and $\Delta_{CQI} = 5/15$ with $\beta_{HS} = 5/15 * \beta_c$.
 Note 2: CM = 1 for $\beta_c/\beta_d = 12/15, \beta_{HS}/\beta_c = 24/15$. For all other combinations of DPDCH, DPCCH, HS-DPCCH, E-DPDCH and E-DPCCH the MPR is based on the relative CM difference.
 Note 3: For subtest 1 the β_c/β_d ratio of 11/15 for the TFC during the measurement period (TF1, TF0) is achieved by setting the signalled gain factors for the reference TFC (TF1, TF1) to $\beta_c = 10/15$ and $\beta_d = 15/15$.
 Note 4: In case of testing by UE using E-DPDCH Physical Layer category 1, Sub-test 3 is omitted according to TS25.306 Table 5.1g.
 Note 5: β_{ed} can not be set directly; it is set by Absolute Grant Value.
 Note 6: For subtests 2, 3 and 4, UE may perform E-DPDCH power scaling at max power which could result in slightly smaller MPR values.

DC-HSDPA SAR Guidance

The 3G SAR test reduction procedure is applied to DC-HSDPA with 12.2 kbps RMC as the primary mode. Otherwise, when SAR is required for Rel. 5 HSDPA, SAR is required for Rel. 8 DC-HSDPA. Power is measured for DC-HSDPA according to the H-Set 12, FRC configuration in Table C.8.1.12 of 3GPP TS 34.121-1 to determine SAR test reduction. A primary and a secondary serving HS-DSCH Cell are required to perform the power measurement and for the results to be acceptable.

SAR Test Report

<Considerations Related to LTE for Setup and Testing>

This device contains LTE transmitter which follows 3GPP standards, is category 3, supports both QPSK and QAM modulations, and supported LTE band and channel bandwidth is listed in below. The output power was tested per 3GPP TS 36.521-1 maximum transmit procedures for both QPSK and QAM modulation. The results please refer to section 4.6 of this report.

EUT Supported LTE Band and Channel Bandwidth						
LTE Band	BW 1.4 MHz	BW 3 MHz	BW 5 MHz	BW 10 MHz	BW 15 MHz	BW 20 MHz
2	V	V	V	V	V	V
4	V	V	V	V	V	V
5	V	V	V	V		
7			V	V	V	V
12	V	V	V	V		
13			V	V		
14			V	V		
17			V	V		
25	V	V	V	V	V	V
26	V	V	V	V	V	
30			V	V		
38			V	V	V	V
41			V	V	V	V
66	V	V	V	V	V	V

The LTE maximum power reduction (MPR) in accordance with 3GPP TS 36.101 is active all times during LTE operation. The allowed MPR for the maximum output power is specified in below.

Modulation	Channel Bandwidth / RB Configurations						LTE MPR Setting (dB)
	BW 1.4 MHz	BW 3 MHz	BW 5 MHz	BW 10 MHz	BW 15 MHz	BW 20 MHz	
QPSK	> 5	> 4	> 8	> 12	> 16	> 18	1
16QAM	<= 5	<= 4	<= 8	<= 12	<= 16	<= 18	1
16QAM	> 5	> 4	> 8	> 12	> 16	> 18	2
64QAM	<= 5	<= 4	<= 8	<= 12	<= 16	<= 18	2
64QAM	> 5	> 4	> 8	> 12	> 16	> 18	3

Note: MPR is according to the standard and implemented in the circuit (mandatory).

In addition, the device is compliant with additional maximum power reduction (A-MPR) requirements defined in 3GPP TS 36.101 section 6.2.4 that was disabled for all FCC compliance testing.

During LTE SAR testing, the related parameters of operating band, channel bandwidth, uplink channel number, modulation type, and RB was set in base station simulator. When the EUT has registered and communicated to base station simulator, the simulator set to make EUT transmitting the maximum radiated power.

SAR Test Report

TDD-LTE Setup Configurations

According to KDB 941225 D05, SAR testing for TDD-LTE device must be tested using a fixed periodic duty factor according to the highest transmission duty factor implemented for the device and supported by the defined 3GPP TDD-LTE configurations. The TDD-LTE of this device supports frame structure type 2 defined in 3GPP TS 36.211 section 4.2, and the frame structure configuration can be referred to below.

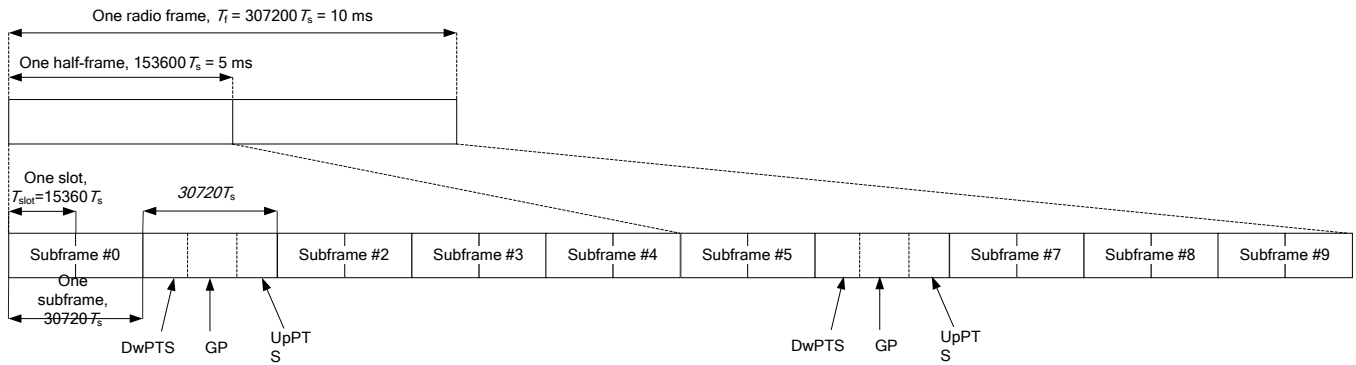

3GPP TS 36.211 Figure 4.2-1: Frame Structure Type 2

Special Subframe Configuration	Normal Cyclic Prefix in Downlink			Extended Cyclic Prefix in Downlink		
	DwPTS	UpPTS		DwPTS	UpPTS	
		Normal Cyclic Prefix in Uplink	Extended Cyclic Prefix in Uplink		Normal Cyclic Prefix in Uplink	Extended Cyclic Prefix in Uplink
0	$6592 \cdot T_s$	$2192 \cdot T_s$	$2560 \cdot T_s$	$7680 \cdot T_s$	$2192 \cdot T_s$	$2560 \cdot T_s$
1	$19760 \cdot T_s$			$20480 \cdot T_s$		
2	$21952 \cdot T_s$			$23040 \cdot T_s$		
3	$24144 \cdot T_s$			$25600 \cdot T_s$		
4	$26336 \cdot T_s$			$7680 \cdot T_s$		
5	$6592 \cdot T_s$	$4384 \cdot T_s$	$5120 \cdot T_s$	$20480 \cdot T_s$	$4384 \cdot T_s$	$5120 \cdot T_s$
6	$19760 \cdot T_s$			$23040 \cdot T_s$		
7	$21952 \cdot T_s$			$12800 \cdot T_s$		
8	$24144 \cdot T_s$			-		
9	$13168 \cdot T_s$	-	-	-	-	-

3GPP TS 36.211 Table 4.2-1: Configuration of Special Subframe

Uplink-Downlink Configuration	Downlink-to-Uplink Switch-Point Periodicity	Subframe Number										
		0	1	2	3	4	5	6	7	8	9	
0	5 ms	D	S	U	U	U	D	S	U	U	U	
1	5 ms	D	S	U	U	D	D	S	U	U	D	
2	5 ms	D	S	U	D	D	D	S	U	D	D	
3	10 ms	D	S	U	U	U	D	D	D	D	D	
4	10 ms	D	S	U	U	D	D	D	D	D	D	
5	10 ms	D	S	U	D	D	D	D	D	D	D	
6	5 ms	D	S	U	U	U	D	S	U	U	D	

3GPP TS 36.211 Table 4.2-2: Uplink-Downlink Configurations

SAR Test Report

The variety of different TD-LTE uplink-downlink configurations allows a network operator to allocate the network's capacity between uplink and downlink traffic to meet the needs of the network. The uplink duty cycle of these seven configurations can readily be computed and shown in below.

UL-DL Configuration	0	1	2	3	4	5	6
Highest Duty-Cycle	63.33%	43.33%	23.33%	31.67%	21.67%	11.67%	53.33%

LTE Downlink Carrier Aggregation(CA)Setup Configurations

LTE Carrier Aggregation (CA) was defined in 3GPP release 10 and higher. The LTE device in CA mode has one Primary Component Carrier (PCC) and one or more Secondary Component Carriers (SCC). PCC acts as the anchor carrier and can optionally cross-schedule data transmission on SCC. The RRC connection is only handled by one cell, the PCC for downlink and uplink communications. After making a data connection to the PCC, the LTE device adds the SCC on the downlink only. All uplink communications and acknowledgements remain identical to release 8 specifications on the PCC.

<SAR Test Exclusion Evaluations for LTE Downlink CA>

According to Nov 2017 TCB Workshop, SAR test exclusion for LTE downlink Carrier Aggregation is determined by power measurements according to the number of component carriers (CCs) supported by the product implementation. The downlink Carrier Aggregation configurations are tabulated in separate columns. DL CA would be listed in the columns corresponding to Intra Band contiguous, Intra Band Non-contiguous, 2bands/2CCs, 2bands/3CCs, 2bands/4CCs, 3bands/3CCs, 3bands/4CCs, 3bands/5CC, 4bands/4CCs and 4bands/5CC. The CA/CC combinations in each columns are sorted so that frequency bands listed in subsequent columns on each row are ascending subsets, as following LTE Downlink CA table and LTE Downlink CA (4*4 MIMO) table ; i.e., columns to the right correspond to increasing number of frequency bands and CCs.



SAR Test Report

	Intra Band		Inter Band								
	Contiguous	2CC Non-Contiguous	2 Bands / 2CC	2 Bands / 3CC	3 Bands / 3CC	2 Bands / 4CC	3 Bands / 4CC	4 Bands / 4CC	3 Bands / 5CC	4 Bands / 5CC	
LTE Downlink CA- Configure	CA_5B			CA_5B-66A CA_5B-30A CA_2A-5B CA_2A-66A-66A	CA_2A-30A-66A	CA_2A-2A-5B	CA_2A-5B-30A CA_5B-30A-66A CA_2A-5B-66A CA_5B-66A-66A CA_2A-5A-66A-66A				
				CA_2A-2A-5A CA_5A-66C CA_5A-66B		CA_2A-2A-66C	CA_2A-5A-66C		CA_2A-2A-5A-66C		
			CA_2A-13A CA_2A-66A CA_2A-46A				CA_2A-2A-66B CA_5B-66C	CA_2A-5A-66B		CA_2A-2A-5A-66B CA_2A-5B-66C CA_2A-13A-46D CA_2A-46D-66A	
									CA_5B-30A-66A-66A CA_13A-46D-66A		
			CA_13A-66A CA_2A-5A CA_30A-66A		CA_5A-30A-66A CA_30A-66A-66A		CA_2A-2A-5A-66A CA_2A-2A-30A-66A				
			CA_5A-30A CA_5A-66A		CA_5A-66A-66A CA_2A-5A-30A CA_2A-5A-66A		CA_2A-30A-66A-66A CA_2A-2A-5A-30A		CA_2A-5A-30A-66A		
			CA_2A-12A CA_2A-30A CA_12A-30A CA_12A-66A CA_2A-2A	CA_2A-12A-30A CA_2A-12A-66A					CA_2A-12A-30A-66A		
				CA_2A-2A-66A CA_2A-2A-30A CA_2A-2A-13A CA_13A-66A-66A CA_2A-66A-66A	CA_2A-13A-66A	CA_2A-2A-66A-66A	CA_2A-2A-13A-66A CA_2A-13A-66A-66A CA_2A-13A-66A-66A		CA_2A-13A-66B CA_2A-13A-66C		
	CA_66B			CA_13A-66B CA_2A-66B					CA_2A-13A-66B		
	CA_66C			CA_13A-66C CA_2A-66C					CA_2A-13A-66C		
									CA_2A-12A-66A-66A CA_5A-30A-66A-66A CA_12A-30A-66A-66A		
		CA_66A-66A		CA_5A-66A CA_12A-66A-66A CA_12A-30A-66A					CA_12A-30A-66A-66A		
			CA_4A-13A CA_2A-4A			CA_2A-4A-13A CA_2A-4A-5A CA_2A-14A-30A	CA_2A-2A-66A-66A				
				CA_2A-2A-4A CA_2A-2A-5A CA_2A-4A-4A CA_4A-4A-5A CA_14A-66A-66A							
			CA_2A-14A CA_2A-29A CA_4A-4A CA_4A-46A CA_13A-46A CA_14A-30A CA_14A-66A CA_25A-26A CA_25A-25A CA_30A-29A CA_66A-29A CA_66A-46A								
		CA_66A-66B CA_66A-66C									
		CA_41C									

• Only yellow highlighted cells need power measurement.

4.2 EUT Testing Position

4.2.1 Body Exposure Conditions

For full-size tablet, according to KDB 616217 D04, SAR evaluation is required for back surface and edges of the devices. The back surface and edges of the tablet are tested with the tablet touching the phantom. Exposures from antennas through the front surface of the display section of a tablet are generally limited to the user's hands. Exposures to hands for typical consumer transmitters used in tablets are not expected to exceed the extremity SAR limit; therefore, SAR evaluation for the front surface of tablet display screens are generally not necessary. When voice mode is supported on a tablet and it is limited to speaker mode or headset operations only, additional SAR testing for this type of voice use is not required.

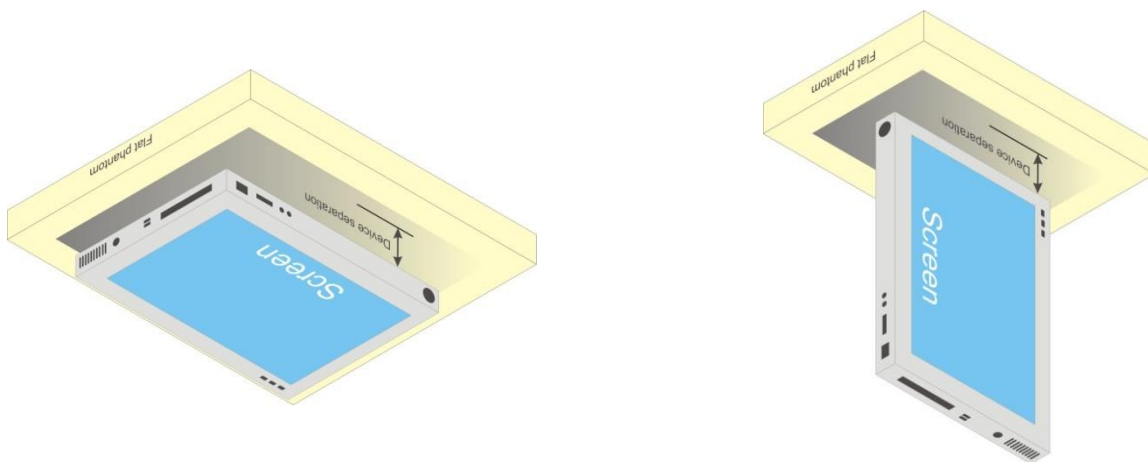

Fig-4.1 Illustration for Tablet Setup

For laptop PC, according to KDB 616217 D04, SAR evaluation is required for the bottom surface of the keyboard. This EUT was tested in the base of EUT directly against the flat phantom. The required minimum test separation distance for incorporating transmitters and antennas into laptop computer display is determined with the display screen opened at an angle of 90° to the keyboard compartment.

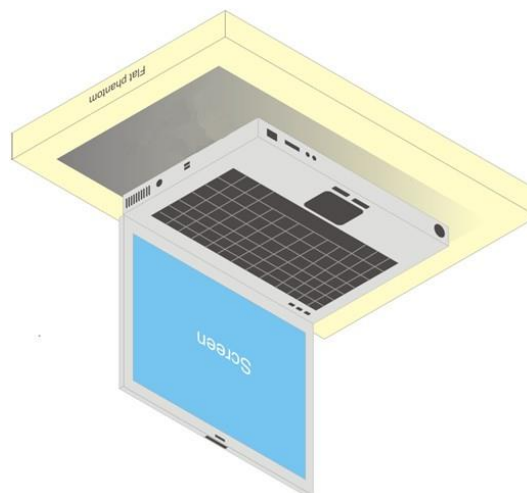

Fig-4.2 Illustration for Laptop Setup

4.3 Tissue Verification

The measuring results for tissue simulating liquid are shown as below.

Frequency (MHz)	Liquid Temp. (°C)	Measured Conductivity (σ)	Measured Permittivity (ϵ_r)	Target Conductivity (σ)	Target Permittivity (ϵ_r)	Conductivity Deviation (%)	Permittivity Deviation (%)	Test Date
750	23.3	0.897	42.647	0.89	41.9	0.79	1.78	Nov. 10, 2020
750	23.3	0.91	43.195	0.89	41.9	2.25	3.09	Nov. 11, 2020
750	23.2	0.894	42.717	0.89	41.9	0.45	1.95	Nov. 13, 2020
750	23.3	0.899	43.562	0.89	41.9	1.01	3.97	Nov. 13, 2020
750	23.1	0.89	43.431	0.89	41.9	0.00	3.65	Nov. 15, 2020
835	23.3	0.919	41.759	0.9	41.5	2.11	0.62	Nov. 09, 2020
835	23.3	0.918	41.689	0.9	41.5	2.00	0.46	Nov. 11, 2020
835	23.3	0.915	41.768	0.9	41.5	1.67	0.65	Nov. 14, 2020
1750	23.3	1.328	40.124	1.37	40.1	-3.07	0.06	Nov. 08, 2020
1750	23.3	1.325	38.941	1.37	40.1	-3.28	-2.89	Nov. 09, 2020
1750	23.2	1.316	40.109	1.37	40.1	-3.94	0.02	Nov. 12, 2020
1750	23.3	1.328	40.126	1.37	40.1	-3.07	0.06	Nov. 13, 2020
1900	23.3	1.458	39.578	1.4	40	4.14	-1.05	Nov. 08, 2020
1900	23.3	1.455	38.385	1.4	40	3.93	-4.04	Nov. 09, 2020
1900	23.2	1.459	40.619	1.4	40	4.21	1.55	Nov. 12, 2020
1900	23.3	1.456	39.753	1.4	40	4.00	-0.62	Nov. 14, 2020
2300	23.3	1.73	38.874	1.67	39.5	3.59	-1.58	Nov. 10, 2020
2300	23.2	1.71	40.377	1.67	39.5	2.40	2.22	Nov. 12, 2020
2300	23.3	1.74	38.873	1.67	39.5	4.19	-1.59	Nov. 14, 2020
2450	23.2	1.824	38.456	1.8	39.2	1.33	-1.90	Nov. 28, 2020
2600	23.3	2.037	38.8	1.96	39	3.93	-0.51	Nov. 08, 2020
2600	23.2	2.037	38.8	1.96	39	3.93	-0.51	Nov. 09, 2020
2600	23.3	2.045	37.845	1.96	39	4.34	-2.96	Nov. 14, 2020
3500	23.3	2.89	36.442	2.91	37.9	-0.69	-3.85	Nov. 14, 2020
3500	23.1	2.893	36.469	2.91	37.9	-0.58	-3.78	Nov. 15, 2020
3700	23.3	3.037	36.247	3.12	37.7	-2.66	-3.85	Nov. 14, 2020
3700	23.1	3.039	36.271	3.12	37.7	-2.60	-3.79	Nov. 15, 2020
5250	23.2	4.781	34.499	4.71	35.9	1.51	-3.90	Nov. 28, 2020
5600	23.2	5.148	34.006	5.07	35.5	1.54	-4.21	Nov. 28, 2020
5750	23.2	5.293	33.858	5.22	35.4	1.40	-4.36	Nov. 28, 2020

Note:

The dielectric properties of the tissue simulating liquid have been measured within 24 hours before the SAR testing and within $\pm 10\%$ of the target values. Liquid temperature during the SAR testing has kept within $\pm 2^\circ\text{C}$.

SAR Test Report

4.4 System Validation

The SAR measurement system was validated according to procedures in KDB 865664 D01. The validation status in tabulated summary is as below.

Test Date	Probe S/N	Calibration Point	Measured Conductivity (σ)	Measured Permittivity (ϵ_r)	Validation for CW			Validation for Modulation		
					Sensitivity Range	Probe Linearity	Probe Isotropy	Modulation Type	Duty Factor	PAR
Nov. 10, 2020	3971	750	0.897	42.647	Pass	Pass	Pass	N/A	N/A	N/A
Nov. 11, 2020	3971	750	0.91	43.195	Pass	Pass	Pass	N/A	N/A	N/A
Nov. 13, 2020	3971	750	0.894	42.717	Pass	Pass	Pass	N/A	N/A	N/A
Nov. 13, 2020	7472	750	0.899	43.562	Pass	Pass	Pass	N/A	N/A	N/A
Nov. 15, 2020	7472	750	0.89	43.431	Pass	Pass	Pass	N/A	N/A	N/A
Nov. 09, 2020	7472	835	0.919	41.759	Pass	Pass	Pass	N/A	N/A	N/A
Nov. 11, 2020	3971	835	0.918	41.689	Pass	Pass	Pass	N/A	N/A	N/A
Nov. 14, 2020	7472	835	0.915	41.768	Pass	Pass	Pass	N/A	N/A	N/A
Nov. 08, 2020	7472	1750	1.328	40.124	Pass	Pass	Pass	N/A	N/A	N/A
Nov. 09, 2020	3971	1750	1.325	38.941	Pass	Pass	Pass	N/A	N/A	N/A
Nov. 12, 2020	3971	1750	1.316	40.109	Pass	Pass	Pass	N/A	N/A	N/A
Nov. 13, 2020	7472	1750	1.328	40.126	Pass	Pass	Pass	N/A	N/A	N/A
Nov. 08, 2020	7472	1900	1.458	39.578	Pass	Pass	Pass	N/A	N/A	N/A
Nov. 09, 2020	3971	1900	1.455	38.385	Pass	Pass	Pass	N/A	N/A	N/A
Nov. 12, 2020	3971	1900	1.459	40.619	Pass	Pass	Pass	N/A	N/A	N/A
Nov. 14, 2020	7472	1900	1.456	39.753	Pass	Pass	Pass	N/A	N/A	N/A
Nov. 10, 2020	3971	2300	1.73	38.874	Pass	Pass	Pass	N/A	N/A	N/A
Nov. 12, 2020	3971	2300	1.71	40.377	Pass	Pass	Pass	N/A	N/A	N/A
Nov. 14, 2020	7472	2300	1.74	38.873	Pass	Pass	Pass	N/A	N/A	N/A
Nov. 28, 2020	3820	2450	1.824	38.456	Pass	Pass	Pass	OFDM	N/A	Pass
Nov. 08, 2020	7472	2600	2.037	38.8	Pass	Pass	Pass	N/A	N/A	N/A
Nov. 09, 2020	7472	2600	2.037	38.8	Pass	Pass	Pass	N/A	N/A	N/A
Nov. 14, 2020	7472	2600	2.045	37.845	Pass	Pass	Pass	N/A	N/A	N/A
Nov. 14, 2020	7472	3500	2.89	36.442	Pass	Pass	Pass	N/A	N/A	N/A
Nov. 15, 2020	7472	3500	2.893	36.469	Pass	Pass	Pass	N/A	N/A	N/A
Nov. 14, 2020	7472	3700	3.037	36.247	Pass	Pass	Pass	N/A	N/A	N/A
Nov. 15, 2020	7472	3700	3.039	36.271	Pass	Pass	Pass	N/A	N/A	N/A
Nov. 28, 2020	3820	5250	4.781	34.499	Pass	Pass	Pass	OFDM	N/A	Pass
Nov. 28, 2020	3820	5600	5.148	34.006	Pass	Pass	Pass	OFDM	N/A	Pass
Nov. 28, 2020	3820	5750	5.293	33.858	Pass	Pass	Pass	OFDM	N/A	Pass

SAR Test Report

4.5 System Verification

The measuring result for system verification is tabulated as below.

Test Date	Frequency (MHz)	1W Target SAR-1g (W/kg)	Measured SAR-1g (W/kg)	Normalized to 1W SAR-1g (W/kg)	Deviation (%)	Dipole S/N	Probe S/N	DAE S/N
Nov. 10, 2020	750	8.48	0.393	7.86	-7.31	1013	3971	917
Nov. 11, 2020	750	8.48	0.399	7.98	-5.90	1013	3971	917
Nov. 13, 2020	750	8.48	0.398	7.96	-6.13	1013	3971	917
Nov. 13, 2020	750	8.48	0.409	8.18	-3.54	1013	7472	1585
Nov. 15, 2020	750	8.48	0.403	8.06	-4.95	1013	7472	1585
Nov. 09, 2020	835	9.52	0.509	10.18	6.93	4d121	7472	1585
Nov. 11, 2020	835	9.52	0.457	9.14	-3.99	4d121	3971	917
Nov. 14, 2020	835	9.52	0.456	9.12	-4.20	4d121	7472	1585
Nov. 08, 2020	1750	36.00	1.81	36.20	0.56	1055	7472	1585
Nov. 09, 2020	1750	36.00	1.79	35.80	-0.56	1055	3971	917
Nov. 12, 2020	1750	36.00	1.81	36.20	0.56	1055	3971	917
Nov. 13, 2020	1750	36.00	1.79	35.80	-0.56	1055	7472	1585
Nov. 08, 2020	1900	40.30	1.95	39.00	-3.23	5d036	7472	1585
Nov. 09, 2020	1900	40.30	1.92	38.40	-4.71	5d036	3971	917
Nov. 12, 2020	1900	40.30	1.94	38.80	-3.72	5d036	3971	917
Nov. 14, 2020	1900	40.30	1.91	38.20	-5.21	5d036	7472	1585
Nov. 10, 2020	2300	48.80	2.38	47.60	-2.46	1004	3971	917
Nov. 12, 2020	2300	48.80	2.41	48.20	-1.23	1004	3971	917
Nov. 14, 2020	2300	48.80	2.62	52.40	7.38	1004	7472	1585
Nov. 28, 2020	2450	51.60	2.67	53.40	3.49	737	3820	1431
Nov. 08, 2020	2600	55.50	2.67	53.40	-3.78	1020	7472	1585
Nov. 09, 2020	2600	55.50	2.58	51.60	-7.03	1020	7472	1585
Nov. 14, 2020	2600	55.50	2.7	54.00	-2.70	1020	7472	1585
Nov. 14, 2020	3500	67.40	3.14	62.80	-6.82	1007	7472	1585
Nov. 15, 2020	3500	67.40	3.16	63.20	-6.23	1007	7472	1585
Nov. 14, 2020	3700	66.50	3.41	68.20	2.56	1074	7472	1585
Nov. 15, 2020	3700	66.50	3.38	67.60	1.65	1074	7472	1585
Nov. 28, 2020	5250	79.70	4.35	87.00	9.16	1019	3820	1431
Nov. 28, 2020	5600	83.80	4.57	91.40	9.07	1019	3820	1431
Nov. 28, 2020	5750	80.40	4.21	84.20	4.73	1019	3820	1431

Note:

Comparing to the reference SAR value provided by SPEAG in dipole calibration certificate, the deviation of system check results is within its specification of 10 %. The result indicates the system check can meet the variation criterion and the plots please refer to Appendix A of this report.

4.6 Maximum Output Power

4.6.1 Maximum Target Conducted Power

Refer to Appendix E.

4.6.2 Measured Conducted Power Result

Refer to Appendix F.

Note:

The WLAN Power information please refer to Intel Report No.: 200914-01.TR03 & 200914-01.TR04.

4.7 SAR Testing Results

4.7.1 SAR Test Reduction Considerations

<KDB 447498 D01, General RF Exposure Guidance>

Testing of other required channels within the operating mode of a frequency band is not required when the reported SAR for the mid-band or highest output power channel is:

- (1) ≤ 0.8 W/kg or 2.0 W/kg, for 1-g or 10-g respectively, when the transmission band is ≤ 100 MHz
- (2) ≤ 0.6 W/kg or 1.5 W/kg, for 1-g or 10-g respectively, when the transmission band is between 100 MHz and 200 MHz
- (3) ≤ 0.4 W/kg or 1.0 W/kg, for 1-g or 10-g respectively, when the transmission band is ≥ 200 MHz

When SAR is not measured at the maximum power level allowed for production units, the measured SAR will be scaled to the maximum tune-up tolerance limit to determine compliance. The scaling factor for the tune-up power is defined as maximum tune-up limit (mW) / measured conducted power (mW). The reported SAR would be calculated by measured SAR x tune-up power scaling factor.

The SAR has been measured with highest transmission duty factor supported by the test mode tools for WLAN and/or Bluetooth. When the transmission duty factor could not achieve 100%, the reported SAR will be scaled to 100% transmission duty factor to determine compliance at the maximum tune-up power. The scaling factor for the duty factor is defined as 100% / transmission duty cycle (%). The reported SAR would be calculated by measured SAR x tune-up power scaling factor x duty cycle scaling factor.

<KDB 941225 D01, 3G SAR Measurement Procedures>

The mode tested for SAR is referred to as the primary mode. The equivalent modes considered for SAR test reduction are denoted as secondary modes. Both primary and secondary modes must be in the same frequency band. When the maximum output power and tune-up tolerance specified for production units in a secondary mode is $\leq 1/4$ dB higher than the primary mode or when the highest reported SAR of the primary mode is scaled by the ratio of specified maximum output power and tune-up tolerance of secondary to primary mode and the adjusted SAR is ≤ 1.2 W/kg, SAR measurement is not required for the secondary mode.

<KDB 941225 D05, SAR Evaluation Considerations for LTE Devices>

- (1) QPSK with 1 RB and 50% RB allocation

Start with the largest channel bandwidth and measure SAR, using the RB offset and required test channel combination with the highest maximum output power among RB offsets at the upper edge, middle and lower edge of each required test channel. When the reported SAR is ≤ 0.8 W/kg, testing of the remaining RB offset configurations and required test channels is not required; otherwise, SAR is required for the remaining required test channels and only for the RB offset configuration with the highest output power for that channel. When the reported SAR of a required test channel is > 1.45 W/kg, SAR is required for all three RB offset configurations for that required test channel.

SAR Test Report

(2) QPSK with 100% RB allocation

SAR is not required when the highest maximum output power for 100% RB allocation is less than the highest maximum output power in 50% and 1 RB allocations and the highest reported SAR for 1 RB and 50% RB allocation are ≤ 0.8 W/kg. Otherwise, SAR is measured for the highest output power channel; and if the reported SAR is > 1.45 W/kg, the remaining required test channels must also be tested.

(3) Higher order modulations

SAR is required only when the highest maximum output power for the configuration in the higher order modulation is $> 1/2$ dB higher than the same configuration in QPSK or when the reported SAR for the QPSK configuration is > 1.45 W/kg.

(4) Other channel bandwidth

SAR is required when the highest maximum output power of the smaller channel bandwidth is $> 1/2$ dB higher than the equivalent channel configurations in the largest channel bandwidth configuration or the reported SAR of a configuration for the largest channel bandwidth is > 1.45 W/kg.

<Power Confirmation for SAR Test Exclusion for LTE Downlink CA>

According to KDB 941225 D05A, the uplink maximum output power below was measured with downlink CA active on the channel with highest measured maximum output power when downlink CA is inactive. The downlink SCC channel was paired with the uplink channel as normal operation. For intra-band contiguous CA, the downlink channel spacing between the component carriers was set to multiple of 300 kHz less than the nominal channel spacing per section 5.4.1A of 3GPP TS36.521. For intra-band non-contiguous CA, the downlink channel spacing between the component carriers was set to maximum separation from PCC and remain fully within the downlink transmission band. For Inter-band CA, the SCC downlink channel was set to near the middle of its transmission band.

Power Measurements for Inter-Band Downlink CA

Refer to Appendix F.

Summary for SAR Test Exclusion for LTE Downlink CA

Per power confirmation results in above, the uplink maximum output power with downlink CA active remains within the specified tune-up tolerance and not more than 0.25 dB higher than the maximum output power with downlink CA inactive. According to KDB 941225 D05A, the SAR test exclusion applies to LTE downlink CA operation.

SAR Test Report

4.7.2 SAR Results for Body Exposure Condition

Tablet Mode

Plot No.	Band	Mode	Test Position	Gap (mm)	Ch.	Ant Brand	P-Sensor	Max. Tune-up Power (dBm)	Measured Conducted Power (dBm)	Scaling Factor	Power Drift (dB)	Measured SAR-1g (W/kg)	Scaled SAR-1g (W/kg)
	WCDMA II	RMC12.2K	Rear Face	0	9400	WNC	w/o	24.50	23.83	1.17	0.02	0.136	0.16
	WCDMA II	RMC12.2K	Left Side	0	9400	WNC	w/o	24.50	23.83	1.17	-0.08	0.141	0.16
	WCDMA II	RMC12.2K	Right Side	0	9400	WNC	w/o	24.50	23.83	1.17	0.1	0.206	0.24
	WCDMA II	RMC12.2K	Top Side	11	9400	WNC	w/o	24.50	23.83	1.17	0.15	0.251	0.29
	WCDMA II	RMC12.2K	Bottom Side	0	9400	WNC	w/o	24.50	23.83	1.17	0	<0.001	0.00
	WCDMA II	RMC12.2K	Top Side	0	9400	WNC	w/	19.00	18.96	1.01	-0.11	0.295	0.30
01	WCDMA II	RMC12.2K	Top Side	0	9262	WNC	w/	19.00	18.87	1.03	0.07	0.352	0.36
	WCDMA II	RMC12.2K	Top Side	0	9538	WNC	w/	19.00	18.90	1.02	0.05	0.283	0.29
	WCDMA II	RMC12.2K	Top Side	0	9262	SPEED	w/	19.00	18.87	1.03	0.17	0.281	0.29
	WCDMA IV	RMC12.2K	Rear Face	0	1413	WNC	w/o	24.50	24.33	1.04	-0.04	0.111	0.12
	WCDMA IV	RMC12.2K	Left Side	0	1413	WNC	w/o	24.50	24.33	1.04	-0.11	0.184	0.19
	WCDMA IV	RMC12.2K	Right Side	0	1413	WNC	w/o	24.50	24.33	1.04	-0.02	0.661	0.69
	WCDMA IV	RMC12.2K	Top Side	11	1413	WNC	w/o	24.50	24.33	1.04	-0.17	0.282	0.29
	WCDMA IV	RMC12.2K	Bottom Side	0	1413	WNC	w/o	24.50	24.33	1.04	0	<0.001	0.00
	WCDMA IV	RMC12.2K	Top Side	0	1413	WNC	w/	22.00	21.88	1.03	0.18	1.07	1.10
	WCDMA IV	RMC12.2K	Top Side	0	1312	WNC	w/	22.00	21.97	1.01	0.15	0.751	0.76
02	WCDMA IV	RMC12.2K	Top Side	0	1513	WNC	w/	22.00	21.90	1.02	-0.14	1.17	1.19
	WCDMA IV	RMC12.2K	Top Side	0	1513	SPEED	w/	22.00	21.90	1.02	-0.12	1.12	1.14
	WCDMA IV	RMC12.2K	Top Side	0	1312	SPEED	w/	22.00	21.97	1.01	0.04	0.924	0.93
	WCDMA IV	RMC12.2K	Top Side	0	1413	SPEED	w/	22.00	21.88	1.03	0.08	0.961	0.99
	WCDMA IV	RMC12.2K	Top Side	0	1513	WNC	w/	22.00	21.90	1.02	0.02	1.15	1.17
	WCDMA V	RMC12.2K	Rear Face	0	4233	WNC	w/o	24.50	24.17	1.08	-0.13	0.066	0.07
	WCDMA V	RMC12.2K	Left Side	0	4233	WNC	w/o	24.50	24.17	1.08	0.11	0.232	0.25
	WCDMA V	RMC12.2K	Right Side	0	4233	WNC	w/o	24.50	24.17	1.08	0.1	0.461	0.50
	WCDMA V	RMC12.2K	Top Side	11	4233	WNC	w/o	24.50	24.17	1.08	0.08	0.251	0.27
	WCDMA V	RMC12.2K	Bottom Side	0	4233	WNC	w/o	24.50	24.17	1.08	0	<0.001	0.00
	WCDMA V	RMC12.2K	Top Side	0	4233	WNC	w/	21.00	20.96	1.01	0.05	0.626	0.63
03	WCDMA V	RMC12.2K	Top Side	0	4132	WNC	w/	21.00	20.85	1.04	-0.07	0.649	0.67
	WCDMA V	RMC12.2K	Top Side	0	4182	WNC	w/	21.00	20.95	1.01	0.16	0.501	0.51
	WCDMA V	RMC12.2K	Top Side	0	4132	SPEED	w/	21.00	20.85	1.04	0.13	0.637	0.66

Note: The "< 0.001" means there is no SAR value or the SAR is too low to be measured.

Plot No.	Band	Mode	Test Position	Gap (mm)	Ch.	RB#	RB Offset	Ant Brand	P-Sensor	Max. Tune-up Power (dBm)	Measured Conducted Power (dBm)	Scaling Factor	Power Drift (dB)	Measured SAR-1g (W/kg)	Scaled SAR-1g (W/kg)
	LTE 2	QPSK20M	Rear Face	0	19100	1	0	WNC	w/o	24.50	23.80	1.17	0.02	0.143	0.17
	LTE 2	QPSK20M	Left Side	0	19100	1	0	WNC	w/o	24.50	23.80	1.17	0.17	0.141	0.16
	LTE 2	QPSK20M	Right Side	0	19100	1	0	WNC	w/o	24.50	23.80	1.17	0.18	0.355	0.42
	LTE 2	QPSK20M	Top Side	11	19100	1	0	WNC	w/o	24.50	23.80	1.17	0.15	0.152	0.18
	LTE 2	QPSK20M	Bottom Side	0	19100	1	0	WNC	w/o	24.50	23.80	1.17	0	<0.001	0.00
	LTE 2	QPSK20M	Rear Face	0	19100	50	0	WNC	w/o	23.50	22.84	1.16	-0.02	0.112	0.13
	LTE 2	QPSK20M	Left Side	0	19100	50	0	WNC	w/o	23.50	22.84	1.16	-0.11	0.133	0.15
	LTE 2	QPSK20M	Right Side	0	19100	50	0	WNC	w/o	23.50	22.84	1.16	0.05	0.231	0.27
	LTE 2	QPSK20M	Top Side	11	19100	50	0	WNC	w/o	23.50	22.84	1.16	0.02	0.106	0.12
	LTE 2	QPSK20M	Bottom Side	0	19100	50	0	WNC	w/o	23.50	22.84	1.16	0	<0.001	0.00
04	LTE 2	QPSK20M	Top Side	0	19100	1	0	WNC	w/	20.00	19.80	1.05	0.1	0.684	0.72
	LTE 2	QPSK20M	Top Side	0	19100	50	0	WNC	w/	19.00	18.67	1.08	-0.08	0.303	0.33
	LTE 2	QPSK20M	Top Side	0	18700	1	0	WNC	w/	20.00	19.53	1.11	-0.05	0.608	0.67
	LTE 2	QPSK20M	Top Side	0	18900	1	0	WNC	w/	20.00	19.39	1.15	0.02	0.617	0.71
	LTE 2	QPSK20M	Top Side	0	19100	1	0	SPEED	w/	20.00	19.80	1.05	0.03	0.678	0.71
	LTE 4	QPSK20M	Rear Face	0	20175	1	0	WNC	w/o	24.50	23.79	1.18	0.04	0.083	0.10
	LTE 4	QPSK20M	Left Side	0	20175	1	0	WNC	w/o	24.50	23.79	1.18	-0.06	0.15	0.18
	LTE 4	QPSK20M	Right Side	0	20175	1	0	WNC	w/o	24.50	23.79	1.18	0.04	0.376	0.44
	LTE 4	QPSK20M	Top Side	11	20175	1	0	WNC	w/o	24.50	23.79	1.18	-0.03	0.179	0.21
	LTE 4	QPSK20M	Bottom Side	0	20175	1	0	WNC	w/o	24.50	23.79	1.18	0	<0.001	0.00
	LTE 4	QPSK20M	Rear Face	0	20175	50	0	WNC	w/o	23.50	22.68	1.21	0.12	0.06	0.07
	LTE 4	QPSK20M	Left Side	0	20175	50	0	WNC	w/o	23.50	22.68	1.21	-0.08	0.12	0.15
	LTE 4	QPSK20M	Right Side	0	20175	50	0	WNC	w/o	23.50	22.68	1.21	0.16	0.271	0.33
	LTE 4	QPSK20M	Top Side	11	20175	50	0	WNC	w/o	23.50	22.68	1.21	0.04	0.166	0.20
	LTE 4	QPSK20M	Bottom Side	0	20175	50	0	WNC	w/o	23.50	22.68	1.21	0	<0.001	0.00
	LTE 4	QPSK20M	Top Side	0	20050	1	0	WNC	w/	22.50	22.38	1.03	0.14	0.988	1.02
	LTE 4	QPSK20M	Top Side	0	20050	50	0	WNC	w/	21.50	21.33	1.04	-0.12	0.732	0.76
	LTE 4	QPSK20M	Top Side	0	20050	100	0	WNC	w/	21.50	21.24	1.06	-0.1	0.607	0.64
	LTE 4	QPSK20M	Top Side	0	20175	1	0	WNC	w/	22.50	22.10	1.10	-0.09	0.854	0.94
05	LTE 4	QPSK20M	Top Side	0	20300	1	0	WNC	w/	22.50	22.24	1.06	0.11	1.13	1.20
	LTE 4	QPSK20M	Top Side	0	20300	1	0	SPEED	w/	22.50	22.24	1.06	-0.16	1.06	1.12
	LTE 4	QPSK20M	Top Side	0	20050	1	0	SPEED	w/	22.50	22.38	1.03	-0.16	1.04	1.07
	LTE 4	QPSK20M	Top Side	0	20175	1	0	SPEED	w/	22.50	22.10	1.10	-0.16	0.998	1.10
	LTE 4	QPSK20M	Top Side	0	20300	1	0	WNC	w/	22.50	22.24	1.06	0.07	1.11	1.18

Note: The "< 0.001" means there is no SAR value or the SAR is too low to be measured.

SAR Test Report

Plot No.	Band	Mode	Test Position	Gap (mm)	Ch.	RB#	RB Offset	Ant Brand	P-Sensor	Max. Tune-up Power (dBm)	Measured Conducted Power (dBm)	Scaling Factor	Power Drift (dB)	Measured SAR-1g (W/kg)	Scaled SAR-1g (W/kg)	
	LTE 5	QPSK10M	Rear Face	0	20525	1	0	WNC	w/o	24.50	23.72	1.20	0.02	0.056	0.07	
	LTE 5	QPSK10M	Left Side	0	20525	1	0	WNC	w/o	24.50	23.72	1.20	-0.15	0.276	0.33	
	LTE 5	QPSK10M	Right Side	0	20525	1	0	WNC	w/o	24.50	23.72	1.20	0.13	0.115	0.14	
	LTE 5	QPSK10M	Top Side	11	20525	1	0	WNC	w/o	24.50	23.72	1.20	0.01	0.201	0.24	
	LTE 5	QPSK10M	Bottom Side	0	20525	1	0	WNC	w/o	24.50	23.72	1.20	0	<0.001	0.00	
	LTE 5	QPSK10M	Rear Face	0	20525	25	0	WNC	w/o	23.50	22.66	1.21	0.05	0.043	0.05	
	LTE 5	QPSK10M	Left Side	0	20525	25	0	WNC	w/o	23.50	22.66	1.21	0.11	0.196	0.24	
	LTE 5	QPSK10M	Right Side	0	20525	25	0	WNC	w/o	23.50	22.66	1.21	0.02	0.078	0.09	
	LTE 5	QPSK10M	Top Side	11	20525	25	0	WNC	w/o	23.50	22.66	1.21	0.06	0.171	0.21	
	LTE 5	QPSK10M	Bottom Side	0	20525	25	0	WNC	w/o	23.50	22.66	1.21	0	<0.001	0.00	
	LTE 5	QPSK10M	Top Side	0	20525	1	0	WNC	w/	21.00	20.87	1.03	0.15	0.636	0.66	
	LTE 5	QPSK10M	Top Side	0	20525	25	0	WNC	w/	20.00	19.87	1.03	0.02	0.438	0.45	
	LTE 5	QPSK10M	Top Side	0	20525	50	0	WNC	w/	20.00	19.76	1.06	-0.08	0.479	0.51	
06	LTE 5	QPSK10M	Top Side	0	20450	1	0	WNC	w/	21.00	20.68	1.08	-0.12	0.743	0.80	
	LTE 5	QPSK10M	Top Side	0	20600	1	0	WNC	w/	21.00	20.69	1.07	0.15	0.665	0.71	
	LTE 5	QPSK10M	Top Side	0	20450	1	0	SPEED	w/	21.00	20.68	1.08	0.11	0.701	0.76	
	LTE 7	QPSK20M	Rear Face	0	20850	1	0	WNC	w/o	24.50	24.40	1.02	0.13	0.303	0.31	
	LTE 7	QPSK20M	Left Side	0	20850	1	0	WNC	w/o	24.50	24.40	1.02	0.12	0.385	0.39	
	LTE 7	QPSK20M	Right Side	0	20850	1	0	WNC	w/o	24.50	24.40	1.02	-0.08	0.744	0.76	
	LTE 7	QPSK20M	Top Side	11	20850	1	0	WNC	w/o	24.50	24.40	1.02	0.01	0.596	0.61	
	LTE 7	QPSK20M	Bottom Side	0	20850	1	0	WNC	w/o	24.50	24.40	1.02	0	<0.001	0.00	
	LTE 7	QPSK20M	Rear Face	0	20850	50	0	WNC	w/o	23.50	23.20	1.07	0.17	0.212	0.23	
	LTE 7	QPSK20M	Left Side	0	20850	50	0	WNC	w/o	23.50	23.20	1.07	-0.02	0.321	0.34	
	LTE 7	QPSK20M	Right Side	0	20850	50	0	WNC	w/o	23.50	23.20	1.07	0.01	0.559	0.60	
	LTE 7	QPSK20M	Top Side	11	20850	50	0	WNC	w/o	23.50	23.20	1.07	0.19	0.521	0.56	
	LTE 7	QPSK20M	Bottom Side	0	20850	50	0	WNC	w/o	23.50	23.20	1.07	0	<0.001	0.00	
07	LTE 7	QPSK20M	Top Side	0	20850	1	0	WNC	w/	19.00	18.95	1.01	-0.05	1.18	1.19	
	LTE 7	QPSK20M	Top Side	0	20850	50	0	WNC	w/	18.00	17.96	1.01	0.11	0.885	0.89	
	LTE 7	QPSK20M	Top Side	0	20850	100	0	WNC	w/	18.00	17.95	1.01	0.01	0.993	1.00	
	LTE 7	QPSK20M	Top Side	0	21100	1	0	WNC	w/	19.00	18.90	1.02	-0.08	0.903	0.92	
	LTE 7	QPSK20M	Top Side	0	21350	1	0	WNC	w/	19.00	18.91	1.02	0.03	0.953	0.97	
	LTE 7	QPSK20M	Top Side	0	21100	50	0	WNC	w/	18.00	17.91	1.02	-0.02	0.811	0.83	
	LTE 7	QPSK20M	Top Side	0	21350	50	0	WNC	w/	18.00	17.77	1.05	-0.08	0.838	0.88	
	LTE 7	QPSK20M	Top Side	0	20850	1	0	SPEED	w/	19.00	18.95	1.01	0.05	1.15	1.16	
	LTE 7	QPSK20M	Top Side	0	21100	1	0	SPEED	w/	19.00	18.90	1.02	0.03	0.992	1.01	
	LTE 7	QPSK20M	Top Side	0	21350	1	0	SPEED	w/	19.00	18.91	1.02	-0.02	0.947	0.97	
	LTE 7	QPSK20M	Top Side	0	20850	1	0	WNC	w/	19.00	18.95	1.01	-0.07	1.16	1.17	
	LTE 12	QPSK10M	Rear Face	0	23095	1	0	WNC	w/o	24.50	24.11	1.09	0.07	0.063	0.07	
	LTE 12	QPSK10M	Left Side	0	23095	1	0	WNC	w/o	24.50	24.11	1.09	0.01	0.032	0.03	
	LTE 12	QPSK10M	Right Side	0	23095	1	0	WNC	w/o	24.50	24.11	1.09	0.11	0.095	0.10	
08	LTE 12	QPSK10M	Top Side	0	23095	1	0	WNC	w/o	24.50	24.11	1.09	-0.12	1.25	1.36	
	LTE 12	QPSK10M	Bottom Side	0	23095	1	0	WNC	w/o	24.50	24.11	1.09	0	<0.001	0.00	
	LTE 12	QPSK10M	Rear Face	0	23095	25	0	WNC	w/o	23.50	23.22	1.07	-0.15	0.053	0.06	
	LTE 12	QPSK10M	Left Side	0	23095	25	0	WNC	w/o	23.50	23.22	1.07	-0.03	<0.001	0.00	
	LTE 12	QPSK10M	Right Side	0	23095	25	0	WNC	w/o	23.50	23.22	1.07	0.19	0.148	0.16	
	LTE 12	QPSK10M	Top Side	0	23095	25	0	WNC	w/o	23.50	23.22	1.07	-0.14	1	1.07	
	LTE 12	QPSK10M	Bottom Side	0	23095	25	0	WNC	w/o	23.50	23.22	1.07	0	<0.001	0.00	
	LTE 12	QPSK10M	Top Side	0	23095	50	0	WNC	w/o	23.50	23.16	1.08	-0.07	1.09	1.18	
	LTE 12	QPSK10M	Top Side	0	23060	1	0	WNC	w/o	24.50	24.08	1.10	-0.15	0.648	0.71	
	LTE 12	QPSK10M	Top Side	0	23130	1	0	WNC	w/o	24.50	24.09	1.10	-0.12	0.585	0.64	
	LTE 12	QPSK10M	Top Side	0	23060	25	0	WNC	w/o	23.50	23.09	1.10	-0.08	0.871	0.96	
	LTE 12	QPSK10M	Top Side	0	23130	25	0	WNC	w/o	23.50	23.14	1.09	0.12	0.917	1.00	
	LTE 12	QPSK10M	Top Side	0	23095	1	0	SPEED	w/o	24.50	24.11	1.09	0.17	1.19	1.30	
	LTE 12	QPSK10M	Top Side	0	23060	1	0	SPEED	w/o	24.50	24.08	1.10	0	1.06	1.17	
	LTE 12	QPSK10M	Top Side	0	23130	1	0	SPEED	w/o	24.50	24.09	1.10	-0.12	1.03	1.13	
	LTE 12	QPSK10M	Top Side	0	23095	1	0	WNC	w/o	24.50	24.11	1.09	0.19	1.19	1.30	
		LTE 13	QPSK10M	Rear Face	0	23230	1	0	WNC	w/o	24.50	24.02	1.12	-0.02	0.115	0.13
		LTE 13	QPSK10M	Left Side	0	23230	1	0	WNC	w/o	24.50	24.02	1.12	-0.05	0.156	0.17
		LTE 13	QPSK10M	Right Side	0	23230	1	0	WNC	w/o	24.50	24.02	1.12	0.13	0.682	0.76
		LTE 13	QPSK10M	Top Side	11	23230	1	0	WNC	w/o	24.50	24.02	1.12	0.16	0.185	0.21
	LTE 13	QPSK10M	Bottom Side	0	23230	1	0	WNC	w/o	24.50	24.02	1.12	0	<0.001	0.00	
	LTE 13	QPSK10M	Rear Face	0	23230	25	0	WNC	w/o	23.50	23.12	1.09	-0.15	0.077	0.08	
	LTE 13	QPSK10M	Left Side	0	23230	25	0	WNC	w/o	23.50	23.12	1.09	-0.11	0.044	0.05	
	LTE 13	QPSK10M	Right Side	0	23230	25	0	WNC	w/o	23.50	23.12	1.09	-0.07	0.446	0.49	
	LTE 13	QPSK10M	Top Side	11	23230	25	0	WNC	w/o	23.50	23.12	1.09	-0.13	0.166	0.18	
	LTE 13	QPSK10M	Bottom Side	0	23230	25	0	WNC	w/o	23.50	23.12	1.09	0	<0.001	0.00	
09	LTE 13	QPSK10M	Top Side	0	23230	1	0	WNC	w/	22.50	22.42	1.02	0.15	0.763	0.78	
	LTE 13	QPSK10M	Top Side	0	23230	25	0	WNC	w/	21.50	21.45	1.01	-0.09	0.539	0.54	
	LTE 13	QPSK10M	Top Side	0	23230	1	0	SPEED	w/	22.50	22.42	1.02	-0.14	0.734	0.75	

Note: The "< 0.001" means there is no SAR value or the SAR is too low to be measured.

SAR Test Report

Plot No.	Band	Mode	Test Position	Gap (mm)	Ch.	RB#	RB Offset	Ant Brand	P-Sensor	Max. Tune-up Power (dBm)	Measured Conducted Power (dBm)	Scaling Factor	Power Drift (dB)	Measured SAR-1g (W/kg)	Scaled SAR-1g (W/kg)
	LTE 14	QPSK10M	Rear Face	0	23330	1	0	WNC	w/o	24.50	24.12	1.09	0.02	0.167	0.18
	LTE 14	QPSK10M	Left Side	0	23330	1	0	WNC	w/o	24.50	24.12	1.09	-0.15	0.151	0.16
	LTE 14	QPSK10M	Right Side	0	23330	1	0	WNC	w/o	24.50	24.12	1.09	0.18	0.226	0.25
	LTE 14	QPSK10M	Top Side	11	23330	1	0	WNC	w/o	24.50	24.12	1.09	0.01	0.371	0.40
	LTE 14	QPSK10M	Bottom Side	0	23330	1	0	WNC	w/o	24.50	24.12	1.09	0	<0.001	0.00
	LTE 14	QPSK10M	Rear Face	0	23330	25	0	WNC	w/o	23.50	23.03	1.11	0.07	0.231	0.26
	LTE 14	QPSK10M	Left Side	0	23330	25	0	WNC	w/o	23.50	23.03	1.11	-0.05	<0.001	0.00
	LTE 14	QPSK10M	Right Side	0	23330	25	0	WNC	w/o	23.50	23.03	1.11	0.02	0.137	0.15
	LTE 14	QPSK10M	Top Side	11	23330	25	0	WNC	w/o	23.50	23.03	1.11	0.08	0.238	0.26
	LTE 14	QPSK10M	Bottom Side	0	23330	25	0	WNC	w/o	23.50	23.03	1.11	0	<0.001	0.00
10	LTE 14	QPSK10M	Top Side	0	23330	1	0	WNC	w/	21.50	21.48	1.00	-0.02	1.11	1.11
	LTE 14	QPSK10M	Top Side	0	23330	25	0	WNC	w/	20.50	20.48	1.00	0.18	0.865	0.87
	LTE 14	QPSK10M	Top Side	0	23330	50	0	WNC	w/	20.50	20.39	1.03	0.08	0.843	0.87
	LTE 14	QPSK10M	Top Side	0	23330	1	0	SPEED	w/	21.50	21.48	1.00	-0.01	0.829	0.83
	LTE 14	QPSK10M	Top Side	0	23330	1	0	WNC	w/	21.50	21.48	1.00	0.05	1.08	1.08
	LTE 25	QPSK20M	Rear Face	0	26365	1	0	WNC	w/o	24.50	23.71	1.20	0.02	0.136	0.16
	LTE 25	QPSK20M	Left Side	0	26365	1	0	WNC	w/o	24.50	23.71	1.20	-0.05	0.129	0.15
	LTE 25	QPSK20M	Right Side	0	26365	1	0	WNC	w/o	24.50	23.71	1.20	0.05	0.259	0.31
	LTE 25	QPSK20M	Top Side	11	26365	1	0	WNC	w/o	24.50	23.71	1.20	0.15	0.168	0.20
	LTE 25	QPSK20M	Bottom Side	0	26365	1	0	WNC	w/o	24.50	23.71	1.20	0	<0.001	0.00
	LTE 25	QPSK20M	Rear Face	0	26365	50	0	WNC	w/o	23.50	22.70	1.20	0.08	0.112	0.13
	LTE 25	QPSK20M	Left Side	0	26365	50	0	WNC	w/o	23.50	22.70	1.20	0.15	0.092	0.11
	LTE 25	QPSK20M	Right Side	0	26365	50	0	WNC	w/o	23.50	22.70	1.20	-0.01	0.231	0.28
	LTE 25	QPSK20M	Top Side	11	26365	50	0	WNC	w/o	23.50	22.70	1.20	-0.15	0.133	0.16
	LTE 25	QPSK20M	Bottom Side	0	26365	50	0	WNC	w/o	23.50	22.70	1.20	0	<0.001	0.00
	LTE 25	QPSK20M	Top Side	0	26365	1	0	WNC	w/	19.50	19.12	1.09	0.02	0.329	0.36
	LTE 25	QPSK20M	Top Side	0	26365	50	0	WNC	w/	18.50	18.18	1.08	-0.02	0.233	0.25
11	LTE 25	QPSK20M	Top Side	0	26140	1	0	WNC	w/	19.50	18.80	1.17	0.06	0.359	0.42
	LTE 25	QPSK20M	Top Side	0	26590	1	0	WNC	w/	19.50	19.04	1.11	0.17	0.282	0.31
	LTE 25	QPSK20M	Top Side	0	26140	1	0	SPEED	w/	19.50	18.80	1.17	0.05	0.351	0.41
	LTE 26	QPSK15M	Rear Face	0	26765	1	0	WNC	w/o	24.50	23.90	1.15	0.02	0.097	0.11
	LTE 26	QPSK15M	Left Side	0	26765	1	0	WNC	w/o	24.50	23.90	1.15	-0.08	0.171	0.20
	LTE 26	QPSK15M	Right Side	0	26765	1	0	WNC	w/o	24.50	23.90	1.15	-0.1	0.136	0.16
	LTE 26	QPSK15M	Top Side	11	26765	1	0	WNC	w/o	24.50	23.90	1.15	0.15	0.213	0.24
	LTE 26	QPSK15M	Bottom Side	0	26765	1	0	WNC	w/o	24.50	23.90	1.15	0	<0.001	0.00
	LTE 26	QPSK15M	Rear Face	0	26765	36	0	WNC	w/o	23.50	22.87	1.16	-0.11	0.088	0.08
	LTE 26	QPSK15M	Left Side	0	26765	36	0	WNC	w/o	23.50	22.87	1.16	0.17	0.133	0.15
	LTE 26	QPSK15M	Right Side	0	26765	36	0	WNC	w/o	23.50	22.87	1.16	0.02	0.073	0.08
	LTE 26	QPSK15M	Top Side	11	26765	36	0	WNC	w/o	23.50	22.87	1.16	0.15	0.155	0.18
	LTE 26	QPSK15M	Bottom Side	0	26765	36	0	WNC	w/o	23.50	22.87	1.16	0	<0.001	0.00
	LTE 26	QPSK15M	Top Side	0	26765	1	0	WNC	w/	21.50	21.49	1.00	0.13	0.465	0.47
	LTE 26	QPSK15M	Top Side	0	26765	36	0	WNC	w/	20.50	20.47	1.01	0.15	0.363	0.37
	LTE 26	QPSK15M	Top Side	0	26765	75	0	WNC	w/	20.50	20.41	1.02	0.08	0.656	0.67
12	LTE 26	QPSK15M	Top Side	0	26865	1	0	WNC	w/	21.50	21.43	1.02	-0.12	0.799	0.81
	LTE 26	QPSK15M	Top Side	0	26965	1	0	WNC	w/	21.50	21.48	1.00	0.18	0.671	0.67
	LTE 26	QPSK15M	Top Side	0	26865	1	0	SPEED	w/	21.50	21.43	1.02	0.1	0.717	0.73
	LTE 26	QPSK15M	Top Side	0	26765	1	0	SPEED	w/	21.50	21.49	1.00	0.12	0.646	0.65
	LTE 26	QPSK15M	Top Side	0	26965	1	0	SPEED	w/	21.50	21.48	1.00	0.15	0.675	0.68
	LTE 30	QPSK10M	Rear Face	0	27710	1	0	WNC	w/o	23.00	22.81	1.04	0.14	0.131	0.14
	LTE 30	QPSK10M	Left Side	0	27710	1	0	WNC	w/o	23.00	22.81	1.04	0.19	0.268	0.28
	LTE 30	QPSK10M	Right Side	0	27710	1	0	WNC	w/o	23.00	22.81	1.04	0.16	0.219	0.23
	LTE 30	QPSK10M	Top Side	11	27710	1	0	WNC	w/o	23.00	22.81	1.04	0.08	0.381	0.40
	LTE 30	QPSK10M	Bottom Side	0	27710	1	0	WNC	w/o	23.00	22.81	1.04	0	<0.001	0.00
	LTE 30	QPSK10M	Rear Face	0	27710	25	0	WNC	w/o	22.00	21.76	1.06	-0.1	0.106	0.11
	LTE 30	QPSK10M	Left Side	0	27710	25	0	WNC	w/o	22.00	21.76	1.06	-0.16	0.241	0.26
	LTE 30	QPSK10M	Right Side	0	27710	25	0	WNC	w/o	22.00	21.76	1.06	0.12	0.167	0.18
	LTE 30	QPSK10M	Top Side	11	27710	25	0	WNC	w/o	22.00	21.76	1.06	-0.05	0.308	0.33
	LTE 30	QPSK10M	Bottom Side	0	27710	25	0	WNC	w/o	22.00	21.76	1.06	0	<0.001	0.00
13	LTE 30	QPSK10M	Top Side	0	27710	1	0	WNC	w/	19.00	18.89	1.03	0.11	0.978	1.01
	LTE 30	QPSK10M	Top Side	0	27710	25	0	WNC	w/	18.00	17.89	1.03	0.02	0.864	0.89
	LTE 30	QPSK10M	Top Side	0	27710	50	0	WNC	w/	18.00	17.76	1.06	0.07	0.821	0.87
	LTE 30	QPSK10M	Top Side	0	27710	1	0	SPEED	w/	19.00	18.89	1.03	0.13	0.935	0.96
	LTE 30	QPSK10M	Top Side	0	27710	1	0	WNC	w/	19.00	18.89	1.03	0.11	0.972	1.00
	LTE 38	QPSK20M	Rear Face	0	38000	1	0	WNC	w/o	24.50	24.42	1.02	-0.02	0.136	0.14
	LTE 38	QPSK20M	Left Side	0	38000	1	0	WNC	w/o	24.50	24.42	1.02	-0.06	0.21	0.21
	LTE 38	QPSK20M	Right Side	0	38000	1	0	WNC	w/o	24.50	24.42	1.02	0.14	0.314	0.32
	LTE 38	QPSK20M	Top Side	11	38000	1	0	WNC	w/o	24.50	24.42	1.02	0.13	0.273	0.28
	LTE 38	QPSK20M	Bottom Side	0	38000	1	0	WNC	w/o	24.50	24.42	1.02	0	<0.001	0.00
	LTE 38	QPSK20M	Rear Face	0	38000	50	0	WNC	w/o	23.50	23.31	1.04	-0.16	0.118	0.12
	LTE 38	QPSK20M	Left Side	0	38000	50	0	WNC	w/o	23.50	23.31	1.04	-0.13	0.194	0.20
	LTE 38	QPSK20M	Right Side	0	38000	50	0	WNC	w/o	23.50	23.31	1.04	0.02	0.221	0.23
	LTE 38	QPSK20M	Top Side	11	38000	50	0	WNC	w/o	23.50	23.31	1.04	0.02	0.24	0.25
	LTE 38	QPSK20M	Bottom Side	0	38000	50	0	WNC	w/o	23.50	23.31	1.04	0	<0.001	0.00
	LTE 38	QPSK20M	Top Side	0	38000	1	0	WNC	w/	21.00	20.91	1.02	0.19	0.868	0.89
	LTE 38	QPSK20M	Top Side	0	38000	50	0	WNC	w/	20.00	19.93	1.02	-0.15	0.611	0.62
	LTE 38	QPSK20M	Top Side	0	37850	1	0	WNC	w/	21.00	20.71	1.07	0.16	0.905	0.97
	LTE 38	QPSK20M	Top Side	0	38150	1	0	WNC	w/	21.00	20.88	1.03	0.15	0.521	0.54
14	LTE 38	QPSK20M	Top Side	0	37850	1	0	SPEED	w/	21.00	20.71	1.07	-0.11	0.911	0.97

Note: The "< 0.001" means there is no SAR value or the SAR is too low to be measured.

SAR Test Report

Plot No.	Band	Mode	Test Position	Gap (mm)	Ch.	RB#	RB Offset	Ant Brand	P-Sensor	Max. Tune-up Power (dBm)	Measured Conducted Power (dBm)	Scaling Factor	Power Drift (dB)	Measured SAR-1g (W/kg)	Scaled SAR-1g (W/kg)
	LTE 41	QPSK20M	Rear Face	0	41055	1	0	WNC	w/o	24.50	24.43	1.02	0.11	0.138	0.14
	LTE 41	QPSK20M	Left Side	0	41055	1	0	WNC	w/o	24.50	24.43	1.02	-0.16	0.211	0.22
	LTE 41	QPSK20M	Right Side	0	41055	1	0	WNC	w/o	24.50	24.43	1.02	-0.04	0.322	0.33
	LTE 41	QPSK20M	Top Side	11	41055	1	0	WNC	w/o	24.50	24.43	1.02	-0.11	0.271	0.28
	LTE 41	QPSK20M	Bottom Side	0	41055	1	0	WNC	w/o	24.50	24.43	1.02	0	<0.001	0.00
	LTE 41	QPSK20M	Rear Face	0	41055	50	0	WNC	w/o	23.50	23.28	1.05	0.19	0.118	0.12
	LTE 41	QPSK20M	Left Side	0	41055	50	0	WNC	w/o	23.50	23.28	1.05	0.13	0.196	0.21
	LTE 41	QPSK20M	Right Side	0	41055	50	0	WNC	w/o	23.50	23.28	1.05	-0.14	0.223	0.23
	LTE 41	QPSK20M	Top Side	11	41055	50	0	WNC	w/o	23.50	23.28	1.05	0.01	0.241	0.25
	LTE 41	QPSK20M	Bottom Side	0	41055	50	0	WNC	w/o	23.50	23.28	1.05	0	<0.001	0.00
	LTE 41	QPSK20M	Top Side	0	41055	1	0	WNC	w/	20.50	20.43	1.02	0.08	0.722	0.74
	LTE 41	QPSK20M	Top Side	0	41055	50	0	WNC	w/	19.50	19.48	1.00	0.18	0.618	0.62
	LTE 41	QPSK20M	Top Side	0	41055	100	0	WNC	w/	19.50	19.32	1.04	0.17	0.615	0.64
	LTE 41	QPSK20M	Top Side	0	39750	1	0	WNC	w/	20.50	20.32	1.04	0.05	0.868	0.90
	LTE 41	QPSK20M	Top Side	0	39790	1	0	WNC	w/	20.50	20.41	1.02	-0.05	0.769	0.78
16	LTE 41	QPSK20M	Top Side	0	40185	1	0	WNC	w/	20.50	19.98	1.13	-0.02	0.91	1.03
	LTE 41	QPSK20M	Top Side	0	40620	1	0	WNC	w/	20.50	20.39	1.03	0.08	0.691	0.71
	LTE 41	QPSK20M	Top Side	0	41490	1	0	WNC	w/	20.50	20.14	1.09	0.02	0.621	0.68
	LTE 41	QPSK20M	Top Side	0	40185	1	0	SPEED	w/	20.50	19.98	1.13	-0.15	0.883	1.00
	LTE 41	QPSK20M	Top Side	0	39750	1	0	SPEED	w/	20.50	20.32	1.04	-0.05	0.843	0.88
	LTE 41	QPSK20M	Top Side	0	39790	1	0	SPEED	w/	20.50	20.41	1.02	-0.07	0.748	0.76
	LTE 41	QPSK20M	Top Side	0	40620	1	0	SPEED	w/	20.50	20.39	1.03	-0.19	0.672	0.69
	LTE 41	QPSK20M	Top Side	0	41055	1	0	SPEED	w/	20.50	20.43	1.02	0.01	0.701	0.72
	LTE 41	QPSK20M	Top Side	0	41490	1	0	SPEED	w/	20.50	20.14	1.09	0.15	0.605	0.66
	LTE 41	QPSK20M	Top Side	0	40185	1	0	WNC	w/	20.50	19.98	1.13	0.05	0.897	1.01

Note: The "< 0.001" means there is no SAR value or the SAR is too low to be measured.

Plot No.	Band	Mode	Test Position	Gap (mm)	Ch.	RB#	RB Offset	Ant Brand	P-Sensor	Max. Tune-up Power (dBm)	Measured Conducted Power (dBm)	Scaling Factor	Power Drift (dB)	Measured SAR-1g (W/kg)	Scaled SAR-1g (W/kg)
	LTE 66	QPSK20M	Rear Face	0	132322	1	0	WNC	w/o	24.50	23.95	1.14	-0.18	0.101	0.12
	LTE 66	QPSK20M	Left Side	0	132322	1	0	WNC	w/o	24.50	23.95	1.14	0.07	0.259	0.30
	LTE 66	QPSK20M	Right Side	0	132322	1	0	WNC	w/o	24.50	23.95	1.14	-0.17	0.564	0.64
	LTE 66	QPSK20M	Top Side	11	132322	1	0	WNC	w/o	24.50	23.95	1.14	0.19	0.295	0.34
	LTE 66	QPSK20M	Bottom Side	0	132322	1	0	WNC	w/o	24.50	23.95	1.14	0	<0.001	0.00
	LTE 66	QPSK20M	Rear Face	0	132322	50	0	WNC	w/o	23.50	22.95	1.14	0.03	0.073	0.08
	LTE 66	QPSK20M	Left Side	0	132322	50	0	WNC	w/o	23.50	22.95	1.14	-0.17	0.182	0.21
	LTE 66	QPSK20M	Right Side	0	132322	50	0	WNC	w/o	23.50	22.95	1.14	0.03	0.609	0.69
	LTE 66	QPSK20M	Top Side	11	132322	50	0	WNC	w/o	23.50	22.95	1.14	-0.12	0.214	0.24
	LTE 66	QPSK20M	Bottom Side	0	132322	50	0	WNC	w/o	23.50	22.95	1.14	0	<0.001	0.00
19	LTE 66	QPSK20M	Top Side	0	132322	1	0	WNC	w/	22.00	21.96	1.01	-0.13	1.25	1.26
	LTE 66	QPSK20M	Top Side	0	132322	50	0	WNC	w/	21.00	20.95	1.01	-0.02	0.745	0.75
	LTE 66	QPSK20M	Top Side	0	132322	100	0	WNC	w/	21.00	20.82	1.04	0.17	1.09	1.13
	LTE 66	QPSK20M	Top Side	0	132072	1	0	WNC	w/	22.00	21.84	1.04	0.04	0.811	0.84
	LTE 66	QPSK20M	Top Side	0	132572	1	0	WNC	w/	22.00	21.89	1.03	-0.08	1.16	1.19
	LTE 66	QPSK20M	Top Side	0	132322	1	0	SPEED	w/	22.00	21.96	1.01	0.08	1.17	1.18
	LTE 66	QPSK20M	Top Side	0	132072	1	0	SPEED	w/	22.00	21.84	1.04	0.01	1.12	1.16
	LTE 66	QPSK20M	Top Side	0	132572	1	0	SPEED	w/	22.00	21.89	1.03	0.03	1.1	1.13
	LTE 66	QPSK20M	Top Side	0	132322	1	0	WNC	w/	22.00	21.96	1.01	0.07	1.2	1.21

Note: The "< 0.001" means there is no SAR value or the SAR is too low to be measured.

SAR Test Report

Plot No.	Band	Mode	Test Position	Gap (mm)	Ch.	Ant Brand	Ant Status	Duty Cycle	Crest Factor	Max. Tune-up Power (dBm)	Measured Conducted Power (dBm)	Scaling Factor	Power Drift (dB)	Measured SAR-1g (W/kg)	Scaled SAR-1g (W/kg)
	WLAN2.4G	802.11b	Left Side	0	6	SPEED	Ant 0	100	1	13.00	12.96	1.01	0	<0.001	0.00
	WLAN2.4G	802.11b	Right Side	0	6	SPEED	Ant 0	100	1	13.00	12.96	1.01	0	<0.001	0.00
	WLAN2.4G	802.11b	Top Side	0	6	SPEED	Ant 0	100	1	13.00	12.96	1.01	0	<0.001	0.00
	WLAN2.4G	802.11b	Left Side	0	11	SPEED	Ant 1	100	1	13.00	12.97	1.01	0	<0.001	0.00
	WLAN2.4G	802.11b	Right Side	0	11	SPEED	Ant 1	100	1	13.00	12.97	1.01	0	<0.001	0.00
	WLAN2.4G	802.11b	Top Side	0	11	SPEED	Ant 1	100	1	13.00	12.97	1.01	0	<0.001	0.00
	WLAN2.4G	802.11b	Right Side	0	1	SPEED	Ant 0	100	1	13.00	12.90	1.02	0	<0.001	0.00
	WLAN2.4G	802.11b	Right Side	0	11	SPEED	Ant 0	100	1	13.00	12.88	1.03	0	<0.001	0.00
	WLAN2.4G	802.11b	Right Side	0	6	WNC	Ant 0	100	1	13.00	12.96	1.01	0	<0.001	0.00
	WLAN2.4G	802.11b	Right Side	0	6	HB	Ant 0	100	1	13.00	12.96	1.01	0	<0.001	0.00
	WLAN5.3G	802.11ac VHT160	Left Side	0	50	SPEED	Ant 0	100	1	10.50	10.42	1.02	0	<0.001	0.00
	WLAN5.3G	802.11ac VHT160	Right Side	0	50	SPEED	Ant 0	100	1	10.50	10.42	1.02	0	<0.001	0.00
	WLAN5.3G	802.11ac VHT160	Top Side	0	50	SPEED	Ant 0	100	1	10.50	10.42	1.02	0	<0.001	0.00
	WLAN5.3G	802.11ac VHT160	Left Side	0	50	SPEED	Ant 1	100	1	10.50	10.36	1.03	0	<0.001	0.00
	WLAN5.3G	802.11ac VHT160	Right Side	0	50	SPEED	Ant 1	100	1	10.50	10.36	1.03	0	<0.001	0.00
	WLAN5.3G	802.11ac VHT160	Top Side	0	50	SPEED	Ant 1	100	1	10.50	10.36	1.03	0	<0.001	0.00
	WLAN5.3G	802.11ac VHT160	Right Side	0	50	WNC	Ant 0	100	1	10.50	10.44	1.01	0	<0.001	0.00
	WLAN5.3G	802.11ac VHT160	Right Side	0	50	HB	Ant 0	100	1	10.50	10.32	1.04	0	<0.001	0.00
	WLAN5.6G	802.11ac VHT160	Left Side	0	114	SPEED	Ant 0	100	1	9.00	8.82	1.04	0	<0.001	0.00
	WLAN5.6G	802.11ac VHT160	Right Side	0	114	SPEED	Ant 0	100	1	9.00	8.82	1.04	0	<0.001	0.00
	WLAN5.6G	802.11ac VHT160	Top Side	0	114	SPEED	Ant 0	100	1	9.00	8.82	1.04	0	<0.001	0.00
	WLAN5.6G	802.11ac VHT160	Left Side	0	114	SPEED	Ant 1	100	1	9.00	8.84	1.04	0	<0.001	0.00
	WLAN5.6G	802.11ac VHT160	Right Side	0	114	SPEED	Ant 1	100	1	9.00	8.84	1.04	0	<0.001	0.00
	WLAN5.6G	802.11ac VHT160	Top Side	0	114	SPEED	Ant 1	100	1	9.00	8.84	1.04	0	<0.001	0.00
	WLAN5.6G	802.11ac VHT160	Right Side	0	114	WNC	Ant 0	100	1	10.50	10.49	1.00	0	<0.001	0.00
	WLAN5.6G	802.11ac VHT160	Right Side	0	114	HB	Ant 0	100	1	9.00	8.97	1.01	0	<0.001	0.00
	WLAN5.8G	802.11ac VHT80	Left Side	0	155	SPEED	Ant 0	100	1	10.50	10.33	1.04	0	<0.001	0.00
	WLAN5.8G	802.11ac VHT80	Right Side	0	155	SPEED	Ant 0	100	1	10.50	10.33	1.04	0	<0.001	0.00
	WLAN5.8G	802.11ac VHT80	Top Side	0	155	SPEED	Ant 0	100	1	10.50	10.33	1.04	0	<0.001	0.00
	WLAN5.8G	802.11ac VHT80	Left Side	0	155	SPEED	Ant 1	100	1	10.50	10.45	1.01	0	<0.001	0.00
	WLAN5.8G	802.11ac VHT80	Right Side	0	155	SPEED	Ant 1	100	1	10.50	10.45	1.01	0	<0.001	0.00
	WLAN5.8G	802.11ac VHT80	Top Side	0	155	SPEED	Ant 1	100	1	10.50	10.45	1.01	0	<0.001	0.00
	WLAN5.8G	802.11ac VHT80	Right Side	0	155	WNC	Ant 0	100	1	9.50	9.42	1.02	0	<0.001	0.00
	WLAN5.8G	802.11ac VHT80	Right Side	0	155	HB	Ant 0	100	1	10.50	10.47	1.01	0	<0.001	0.00
	BT	BR	Left Side	0	78	SPEED	Ant 1	78	1.28	10.50	9.85	1.16	0	<0.001	0.00
	BT	BR	Right Side	0	78	SPEED	Ant 1	78	1.28	10.50	9.85	1.16	0	<0.001	0.00
	BT	BR	Top Side	0	78	SPEED	Ant 1	78	1.28	10.50	9.85	1.16	0	<0.001	0.00
	BT	BR	Left Side	0	0	SPEED	Ant 1	78	1.28	10.50	9.85	1.16	0	<0.001	0.00
	BT	BR	Left Side	0	39	SPEED	Ant 1	78	1.28	10.50	9.85	1.16	0	<0.001	0.00
	BT	BR	Left Side	0	78	WNC	Ant 1	78	1.28	10.50	10.08	1.10	0	<0.001	0.00
	BT	BR	Left Side	0	78	HB	Ant 1	78	1.28	10.50	10.50	1.00	0	<0.001	0.00

Note:

1. The “< 0.001” means there is no SAR value or the SAR is too low to be measured.
2. For SAR test result of WLAN / BT module AX201D2W, only left side, right side and top side of tablet mode is tested in this report, the other test data please refer to Intel Report No.: 200914-02.TR06 & 200914-02.TR07.

SAR Test Report

Laptop Mode

Plot No.	Band	Mode	Test Position	Gap (mm)	Ch.	Ant Brand	Max. Tune-up Power (dBm)	Measured Conducted Power (dBm)	Scaling Factor	Power Drift (dB)	Measured SAR-1g (W/kg)	Scaled SAR-1g (W/kg)
	WCDMA II	RMC12.2K	Bottom	0	9400	WNC	24.50	23.83	1.17	0	<0.001	24.50
	WCDMA II	RMC12.2K	Bottom	0	9262	WNC	24.50	23.73	1.19	0	<0.001	24.50
	WCDMA II	RMC12.2K	Bottom	0	9538	WNC	24.50	23.70	1.20	0	<0.001	24.50
	WCDMA II	RMC12.2K	Bottom	0	9400	SPEED	24.50	23.83	1.17	0	<0.001	24.50
	WCDMA IV	RMC12.2K	Bottom	0	1413	WNC	24.50	24.33	1.04	0	<0.001	24.50
	WCDMA IV	RMC12.2K	Bottom	0	1312	WNC	24.50	24.07	1.10	0	<0.001	24.50
	WCDMA IV	RMC12.2K	Bottom	0	1513	WNC	24.50	24.00	1.12	0	<0.001	24.50
	WCDMA IV	RMC12.2K	Bottom	0	1413	SPEED	24.50	24.33	1.04	0	<0.001	24.50
	WCDMA V	RMC12.2K	Bottom	0	4233	WNC	24.50	24.17	1.08	0	<0.001	24.50
	WCDMA V	RMC12.2K	Bottom	0	4132	WNC	24.50	23.99	1.12	0	<0.001	24.50
	WCDMA V	RMC12.2K	Bottom	0	4182	WNC	24.50	24.11	1.09	0	<0.001	24.50
	WCDMA V	RMC12.2K	Bottom	0	4233	SPEED	24.50	24.17	1.08	0	<0.001	24.50

Note: The “< 0.001” means there is no SAR value or the SAR is too low to be measured.

Plot No.	Band	Mode	Test Position	Gap (mm)	Ch.	RB#	RB Offset	Ant Brand	Max. Tune-up Power (dBm)	Measured Conducted Power (dBm)	Scaling Factor	Power Drift (dB)	Measured SAR-1g (W/kg)	Scaled SAR-1g (W/kg)
	LTE 7	QPSK20M	Bottom	0	20850	1	0	WNC	24.50	24.40	1.02	0	<0.001	0.00
	LTE 7	QPSK20M	Bottom	0	20850	50	0	WNC	23.50	23.20	1.07	0	<0.001	0.00
	LTE 7	QPSK20M	Bottom	0	21100	1	0	WNC	24.50	24.09	1.10	0	<0.001	0.00
	LTE 7	QPSK20M	Bottom	0	21350	1	0	WNC	24.50	24.22	1.07	0	<0.001	0.00
	LTE 7	QPSK20M	Bottom	0	20850	1	0	SPEED	24.50	24.40	1.02	0	<0.001	0.00
	LTE 12	QPSK10M	Bottom	0	23095	1	0	WNC	24.50	24.11	1.09	0	<0.001	0.00
	LTE 12	QPSK10M	Bottom	0	23095	25	0	WNC	23.50	23.22	1.07	0	<0.001	0.00
	LTE 12	QPSK10M	Bottom	0	23060	1	0	WNC	24.50	24.08	1.10	0	<0.001	0.00
	LTE 12	QPSK10M	Bottom	0	23130	1	0	WNC	24.50	24.09	1.10	0	<0.001	0.00
	LTE 12	QPSK10M	Bottom	0	23095	1	0	SPEED	24.50	24.11	1.09	0	<0.001	0.00
	LTE 13	QPSK10M	Bottom	0	23230	1	0	WNC	24.50	24.02	1.12	0	<0.001	0.00
	LTE 13	QPSK10M	Bottom	0	23230	25	0	WNC	23.50	23.12	1.09	0	<0.001	0.00
	LTE 13	QPSK10M	Bottom	0	23230	1	0	SPEED	24.50	24.02	1.12	0	<0.001	0.00
	LTE 14	QPSK10M	Bottom	0	23330	1	0	WNC	24.50	24.12	1.09	0	<0.001	0.00
	LTE 14	QPSK10M	Bottom	0	23330	25	0	WNC	23.50	23.03	1.11	0	<0.001	0.00
	LTE 14	QPSK10M	Bottom	0	23330	1	0	SPEED	24.50	24.12	1.09	0	<0.001	0.00
	LTE 25	QPSK20M	Bottom	0	26365	1	0	WNC	24.50	23.71	1.20	0	<0.001	0.00
	LTE 25	QPSK20M	Bottom	0	26365	50	0	WNC	23.50	22.70	1.20	0	<0.001	0.00
	LTE 25	QPSK20M	Bottom	0	26140	1	0	WNC	24.50	23.35	1.30	0	<0.001	0.00
	LTE 25	QPSK20M	Bottom	0	26590	1	0	WNC	24.50	23.64	1.22	0	<0.001	0.00
	LTE 25	QPSK20M	Bottom	0	26590	1	0	SPEED	24.50	23.64	1.22	0	<0.001	0.00
	LTE 26	QPSK15M	Bottom	0	26765	1	0	WNC	24.50	23.90	1.15	0	<0.001	0.00
	LTE 26	QPSK15M	Bottom	0	26765	36	0	WNC	23.50	22.87	1.16	0	<0.001	0.00
	LTE 26	QPSK15M	Bottom	0	26865	1	0	WNC	24.50	23.68	1.21	0	<0.001	0.00
	LTE 26	QPSK15M	Bottom	0	26965	1	0	WNC	24.50	23.77	1.18	0	<0.001	0.00
	LTE 26	QPSK15M	Bottom	0	26765	1	0	SPEED	24.50	23.90	1.15	0	<0.001	0.00
	LTE 30	QPSK10M	Bottom	0	27710	1	0	WNC	23.00	22.81	1.04	0	<0.001	0.00
	LTE 30	QPSK10M	Bottom	0	27710	25	0	WNC	22.00	21.76	1.06	0	<0.001	0.00
	LTE 30	QPSK10M	Bottom	0	27710	1	0	SPEED	23.00	22.81	1.04	0	<0.001	0.00
	LTE 41	QPSK20M	Bottom	0	41055	1	0	WNC	24.50	24.43	1.02	0	<0.001	0.00
	LTE 41	QPSK20M	Bottom	0	41055	50	0	WNC	23.50	23.28	1.05	0	<0.001	0.00
	LTE 41	QPSK20M	Bottom	0	39750	1	0	WNC	24.50	24.30	1.05	0	<0.001	0.00
	LTE 41	QPSK20M	Bottom	0	40185	1	0	WNC	24.50	24.00	1.12	0	<0.001	0.00
	LTE 41	QPSK20M	Bottom	0	40620	1	0	WNC	24.50	24.11	1.09	0	<0.001	0.00
	LTE 41	QPSK20M	Bottom	0	41490	1	0	WNC	24.50	23.95	1.14	0	<0.001	0.00
	LTE 41	QPSK20M	Bottom	0	40620	1	0	SPEED	24.50	24.11	1.09	0	<0.001	0.00
	LTE 66	QPSK20M	Bottom	0	132322	1	0	WNC	24.50	23.95	1.14	0	<0.001	0.00
	LTE 66	QPSK20M	Bottom	0	132322	50	0	WNC	23.50	22.95	1.14	0	<0.001	0.00
	LTE 66	QPSK20M	Bottom	0	132072	1	0	WNC	24.50	23.94	1.14	0	<0.001	0.00
	LTE 66	QPSK20M	Bottom	0	132572	1	0	WNC	24.50	23.91	1.15	0	<0.001	0.00
	LTE 66	QPSK20M	Bottom	0	132572	1	0	SPEED	24.50	23.91	1.15	0	<0.001	0.00

Note: The “< 0.001” means there is no SAR value or the SAR is too low to be measured.

SAR Test Report

4.7.3 SAR Measurement Variability

According to KDB 865664 D01, SAR measurement variability was assessed for each frequency band, which is determined by the SAR probe calibration point and tissue-equivalent medium used for the device measurements. When both head and body tissue-equivalent media are required for SAR measurements in a frequency band, the variability measurement procedures should be applied to the tissue medium with the highest measured SAR, using the highest measured SAR configuration for that tissue-equivalent medium. Alternatively, if the highest measured SAR for both head and body tissue-equivalent media are ≤ 1.45 W/kg and the ratio of these highest SAR values, i.e., largest divided by smallest value, is ≤ 1.10 , the highest SAR configuration for either head or body tissue-equivalent medium maybe used to perform the repeated measurement. These additional measurements are repeated after the completion of all measurements requiring the same head or body tissue-equivalent medium in a frequency band. The test device should be returned to ambient conditions (normal room temperature) with the battery fully charged before it is re-mounted on the device holder for the repeated measurement(s) to minimize any unexpected variations in the repeated results.

SAR repeated measurement procedure:

1. When the highest measured SAR is < 0.80 W/kg, repeated measurement is not required.
2. When the highest measured SAR is ≥ 0.80 W/kg, repeat that measurement once.
3. If the ratio of largest to smallest SAR for the original and first repeated measurements is > 1.20 , or when the original or repeated measurement is ≥ 1.45 W/kg, perform a second repeated measurement.
4. If the ratio of largest to smallest SAR for the original, first and second repeated measurements is > 1.20 , and the original, first or second repeated measurement is ≥ 1.5 W/kg, perform a third repeated measurement.

Band	Mode	Test Position	Ch.	Original Measured SAR-1g (W/kg)	1st Repeated SAR-1g (W/kg)	L/S Ratio	2nd Repeated SAR-1g (W/kg)	L/S Ratio	3rd Repeated SAR-1g (W/kg)	L/S Ratio
WCDMA IV	RMC12.2K	Top Side	1513	1.17	1.15	1.02	N/A	N/A	N/A	N/A
LTE 4	QPSK20M	Top Side	20300	1.13	1.11	1.02	N/A	N/A	N/A	N/A
LTE 7	QPSK20M	Top Side	20850	1.18	1.16	1.02	N/A	N/A	N/A	N/A
LTE 12	QPSK10M	Top Side	23095	1.25	1.19	1.05	N/A	N/A	N/A	N/A
LTE 14	QPSK10M	Top Side	23330	1.11	1.08	1.03	N/A	N/A	N/A	N/A
LTE 30	QPSK10M	Top Side	27710	0.978	0.972	1.01	N/A	N/A	N/A	N/A
LTE 41	QPSK20M	Top Side	40185	0.91	0.897	1.01	N/A	N/A	N/A	N/A
LTE 66	QPSK20M	Top Side	132322	1.25	1.2	1.04	N/A	N/A	N/A	N/A

SAR Test Report

4.7.4 Simultaneous Multi-band Transmission Evaluation

<Possibilities of Simultaneous Transmission>

The simultaneous transmission possibilities for this device are listed as below.

Simultaneous TX Combination	Capable Transmit Configurations	Body Exposure Condition
1	WWAN + WLAN2.4G Ant 0 + BT Ant 1	Yes
2	WWAN + WLAN2.4G Ant 0 + WLAN2.4G Ant 1	Yes
3	WWAN + WLAN5G Ant 0 + WLAN5G Ant 1	Yes

Note :

1. The WLAN 2.4G and WLAN 5G cannot transmit simultaneously.

<SAR Summation Analysis>

Simultaneous transmission SAR test exclusion is determined for each operating configuration and exposure condition according to the reported standalone SAR of each applicable simultaneous transmitting antenna. When the sum of SAR_{1g} of all simultaneously transmitting antennas in an operating mode and exposure condition combination is within the SAR limit(SAR_{1g} 1.6 W/kg), the simultaneous transmission SAR is not required. When the sum of SAR_{1g} is greater than the SAR limit (SAR_{1g} 1.6 W/kg), SAR test exclusion is determined by the SPLSR.

Note :

1. There is no co-location SAR evaluation requirement for laptop mode between WWAN and WLAN due to the WWAN Bottom SAR is too low to be measured and the bystander SAR only are required for WWAN . The WLAN co-location SAR evaluation for laptop mode please refer to Intel Report No.: 200914-02.TR06 & 200914-02.TR07.
2. Regarding to WLAN SPLSR calculation for tablet mode please refer to Intel Report No.: 200914-02.TR06 & 200914-02.TR07.

Refer to Appendix G

SAR Test Report

<SAR to Peak Location Separation Ratio Analysis>

The simultaneous transmitting antennas in each operating mode and exposure condition combination are considered one pair at a time to determine the SPLSR. When SAR is measured for both antennas in the pair, the peak location separation distance is computed by the following formula.

$$\text{Peak Location Separation Distance} = \sqrt{(x_1 - x_2)^2 + (y_1 - y_2)^2 + (z_1 - z_2)^2}$$

Where (x_1, y_1, z_1) and (x_2, y_2, z_2) are the coordinates of the extrapolated peak SAR locations in the area or zoom scans.

When standalone test exclusion applies, SAR is estimated; the peak location is assumed to be at the feed-point or geometric center of the antenna. Due to curvatures on the SAM phantom, when SAR is estimated for one of the antennas in an antenna pair, the measured peak SAR location will be translated onto the test device to determine the peak location separation for the antenna pair.

The SPLSR is determined by the following formula.

$$\text{SPLSR} = \frac{(\text{SAR}_1 + \text{SAR}_2)^{1.5}}{R_i}$$

Where SAR_1 and SAR_2 are the highest reported or estimated SAR for each antenna in the pair, and R_i is the separation distance between the peak SAR locations for the antenna pair in mm.

When the SPLSR is ≤ 0.04 , the simultaneous transmission SAR is not required. Otherwise, the enlarged zoom scan and volume scan post-processing procedures will be performed.

Refer to Appendix H

Test Engineer : Gary Chao, and James Chu

5. Calibration of Test Equipment

Equipment	Manufacturer	Model	SN	Cal. Date	Cal. Interval
System Validation Dipole	SPEAG	D750V3	1013	Aug. 13, 2020	1 Year
System Validation Dipole	SPEAG	D835V2	4d121	Aug. 13, 2020	1 Year
System Validation Dipole	SPEAG	D1750V2	1055	Aug. 14, 2020	1 Year
System Validation Dipole	SPEAG	D1900V2	5d036	Jan. 21, 2020	1 Year
System Validation Dipole	SPEAG	D2300V2	1004	Jan. 21, 2020	1 Year
System Validation Dipole	SPEAG	D2450V2	737	Aug. 13, 2020	1 Year
System Validation Dipole	SPEAG	D2600V2	1020	Aug. 13, 2020	1 Year
System Validation Dipole	SPEAG	D3500V2	1007	Feb. 25, 2020	1 Year
System Validation Dipole	SPEAG	D3700V2	1074	May. 04, 2020	1 Year
System Validation Dipole	SPEAG	D5GHzV2	1019	Mar. 13, 2020	1 Year
Dosimetric E-Field Probe	SPEAG	EX3DV4	3820	Jun. 25, 2020	1 Year
Dosimetric E-Field Probe	SPEAG	EX3DV4	3971	Jan. 27, 2020	1 Year
Dosimetric E-Field Probe	SPEAG	EX3DV4	7472	Aug. 24, 2020	1 Year
Data Acquisition Electronics	SPEAG	DAE4	1431	Mar. 18, 2020	1 Year
Data Acquisition Electronics	SPEAG	DAE4	917	Dec. 17, 2019	1 Year
Data Acquisition Electronics	SPEAG	DAE4	1585	May. 28, 2020	1 Year
Universal Radio Communication Tester	Anritsu	MT8821C	6201502978	Jul. 09, 2020	1 Year
Universal Radio Communication Tester	R&S	CMW500	164864	Apr. 16, 2020	1 Year
Spectrum Analyzer	R&S	FSL6	102006	Mar. 26, 2020	1 Year
Power Meter	Anritsu	ML2495A	1218009	Jun. 24, 2020	1 Year
Power Sensor	Anritsu	MA2411B	1207252	Jun. 24, 2020	1 Year
Universal Wireless Test Set	Anritsu	MT8870A/MU8 87000A	6201699387	Oct. 07, 2019	1 Year
Thermometer	YFE	YF-160A	150601220	May. 25, 2020	1 Year
Dielectric Assessment Kit	SPEAG	DAKS-3.5	1092	May. 26, 2020	1 Year
Powersource1	SPEAG	SE_UMS_160 BA	4010	Aug. 13, 2020	1 Year

6. Measurement Uncertainty

Source of Uncertainty	Uncertainty (± %)	Probability Distribution	Divisor	Ci (1g)	Ci (10g)	Standard Uncertainty (± %, 1g)	Standard Uncertainty (± %, 10g)	Vi
Measurement System								
Probe Calibration	6.0	Normal	1	1	1	6.0	6.0	∞
Axial Isotropy	4.7	Rectangular	√3	√0.5	√0.5	1.9	1.9	∞
Hemispherical Isotropy	9.6	Rectangular	√3	√0.5	√0.5	3.9	3.9	∞
Boundary Effect	1.0	Rectangular	√3	1	1	0.6	0.6	∞
Linearity	4.7	Rectangular	√3	1	1	2.7	2.7	∞
Detection Limits	0.25	Rectangular	√3	1	1	0.14	0.14	∞
Probe Modulation Response	4.8	Rectangular	√3	1	1	2.8	2.8	∞
Readout Electronics	0.3	Normal	1	1	1	0.3	0.3	∞
Response Time	0.0	Rectangular	√3	1	1	0.0	0.0	∞
Integration Time	1.7	Rectangular	√3	1	1	1.0	1.0	∞
RF Ambient Conditions – Noise	3.0	Rectangular	√3	1	1	1.7	1.7	∞
RF Ambient Conditions – Reflections	3.0	Rectangular	√3	1	1	1.7	1.7	∞
Probe Positioner Mechanical Tolerance	0.02	Rectangular	√3	1	1	0.01	0.01	∞
Probe Positioning with Respect to Phantom	0.4	Rectangular	√3	1	1	0.2	0.2	∞
Post-processing	2.0	Rectangular	√3	1	1	1.2	1.2	∞
Test Sample Related								
Test Sample Positioning	2.82 / 1.60	Normal	1	1	1	2.8	1.6	35
Device Holder Uncertainty	2.55 / 2.76	Normal	1	1	1	2.6	2.8	7
Power Drift of Measurement	5.0	Rectangular	√3	1	1	2.9	2.9	∞
PowerScaling	0.0	Rectangular	√3	1	1	0.0	0.0	∞
Phantom and Setup								
Phantom Uncertainty (Shape and Thickness Tolerances)	5.7	Rectangular	√3	1	1	3.3	3.3	∞
Liquid Conductivity (Temperature Uncertainty)	2.58	Rectangular	√3	0.78	0.71	1.2	1.1	∞
Liquid Conductivity (Measured)	2.95	Normal	1	0.78	0.71	2.3	2.1	61
Liquid Permittivity (Temperature Uncertainty)	1.97	Rectangular	√3	0.23	0.26	0.3	0.3	∞
Liquid Permittivity (Measured)	3.04	Normal	1	0.23	0.26	0.7	0.8	47
Combined Standard Uncertainty						± 10.9 %	± 10.7 %	
Expanded Uncertainty (K=2)						± 21.8 %	± 21.4 %	

Head SAR Uncertainty Budget for Frequency Range of 300 MHz to 3 GHz

SAR Test Report

Source of Uncertainty	Uncertainty (± %)	Probability Distribution	Divisor	Ci (1g)	Ci (10g)	Standard Uncertainty (± %, 1g)	Standard Uncertainty (± %, 10g)	Vi
Measurement System								
Probe Calibration	6.55	Normal	1	1	1	6.55	6.55	∞
Axial Isotropy	4.7	Rectangular	√3	0.7	0.7	1.9	1.9	∞
Hemispherical Isotropy	9.6	Rectangular	√3	0.7	0.7	3.9	3.9	∞
Boundary Effect	2.0	Rectangular	√3	1	1	1.2	1.2	∞
Linearity	4.7	Rectangular	√3	1	1	2.7	2.7	∞
Detection Limits	0.25	Rectangular	√3	1	1	0.14	0.14	∞
Probe Modulation Response	4.8	Rectangular	√3	1	1	2.8	2.8	∞
Readout Electronics	0.3	Normal	1	1	1	0.3	0.3	∞
Response Time	0.0	Rectangular	√3	1	1	0.0	0.0	∞
Integration Time	1.7	Rectangular	√3	1	1	1.0	1.0	∞
RF Ambient Conditions – Noise	3.0	Rectangular	√3	1	1	1.7	1.7	∞
RF Ambient Conditions – Reflections	3.0	Rectangular	√3	1	1	1.7	1.7	∞
Probe Positioner Mechanical Tolerance	0.04	Rectangular	√3	1	1	0.02	0.02	∞
Probe Positioning with Respect to Phantom	0.8	Rectangular	√3	1	1	0.5	0.5	∞
Post-processing	4.0	Rectangular	√3	1	1	2.3	2.3	∞
Test Sample Related								
Test Sample Positioning	2.82 / 1.60	Normal	1	1	1	2.8	1.6	35
Device Holder Uncertainty	2.55 / 2.76	Normal	1	1	1	2.6	2.8	7
Power Drift of Measurement	5.0	Rectangular	√3	1	1	2.9	2.9	∞
PowerScaling	0.0	Rectangular	√3	1	1	0.0	0.0	∞
Phantom and Setup								
Phantom Uncertainty (Shape and Thickness Tolerances)	6.2	Rectangular	√3	1	1	3.6	3.6	∞
Liquid Conductivity (Temperature Uncertainty)	2.58	Rectangular	√3	0.78	0.71	1.2	1.1	∞
Liquid Conductivity (Measured)	2.95	Normal	1	0.78	0.71	2.3	2.1	61
Liquid Permittivity (Temperature Uncertainty)	1.97	Rectangular	√3	0.23	0.26	0.3	0.3	∞
Liquid Permittivity (Measured)	3.04	Normal	1	0.23	0.26	0.7	0.8	47
Combined Standard Uncertainty						± 11.6 %	± 11.3 %	
Expanded Uncertainty (K=2)						± 23.2 %	± 22.6 %	

Head SAR Uncertainty Budget for Frequency Range of 3 GHz to 6 GHz

SAR Test Report

Source of Uncertainty	Uncertainty (± %)	Probability Distribution	Divisor	Ci (1g)	Ci (10g)	Standard Uncertainty (± %, 1g)	Standard Uncertainty (± %, 10g)	Vi
Measurement System								
Probe Calibration	6.0	Normal	1	1	1	6.0	6.0	∞
Axial Isotropy	4.7	Rectangular	√3	√0.5	√0.5	1.9	1.9	∞
Hemispherical Isotropy	9.6	Rectangular	√3	√0.5	√0.5	3.9	3.9	∞
Boundary Effect	1.0	Rectangular	√3	1	1	0.6	0.6	∞
Linearity	4.7	Rectangular	√3	1	1	2.7	2.7	∞
Detection Limits	0.25	Rectangular	√3	1	1	0.14	0.14	∞
Probe Modulation Response	4.8	Rectangular	√3	1	1	2.8	2.8	∞
Readout Electronics	0.3	Normal	1	1	1	0.3	0.3	∞
Response Time	0.0	Rectangular	√3	1	1	0.0	0.0	∞
Integration Time	1.7	Rectangular	√3	1	1	1.0	1.0	∞
RF Ambient Conditions – Noise	3.0	Rectangular	√3	1	1	1.7	1.7	∞
RF Ambient Conditions – Reflections	3.0	Rectangular	√3	1	1	1.7	1.7	∞
Probe Positioner Mechanical Tolerance	0.02	Rectangular	√3	1	1	0.01	0.01	∞
Probe Positioning with Respect to Phantom	0.4	Rectangular	√3	1	1	0.2	0.2	∞
Post-processing	2.0	Rectangular	√3	1	1	1.2	1.2	∞
Test Sample Related								
Test Sample Positioning	3.68 / 1.73	Normal	1	1	1	3.7	1.7	29
Device Holder Uncertainty	2.55 / 2.76	Normal	1	1	1	2.6	2.8	7
Power Drift of Measurement	5.0	Rectangular	√3	1	1	2.9	2.9	∞
PowerScaling	0.0	Rectangular	√3	1	1	0.0	0.0	∞
Phantom and Setup								
Phantom Uncertainty (Shape and Thickness Tolerances)	7.2	Rectangular	√3	1	1	4.2	4.2	∞
Liquid Conductivity (Temperature Uncertainty)	2.58	Rectangular	√3	0.78	0.71	1.2	1.1	∞
Liquid Conductivity (Measured)	2.95	Normal	1	0.78	0.71	2.3	2.1	61
Liquid Permittivity (Temperature Uncertainty)	1.97	Rectangular	√3	0.23	0.26	0.3	0.3	∞
Liquid Permittivity (Measured)	3.04	Normal	1	0.23	0.26	0.7	0.8	47
Combined Standard Uncertainty						± 11.5 %	± 11.0 %	
Expanded Uncertainty (K=2)						± 23.0 %	± 22.0 %	

Body SAR Uncertainty Budget for Frequency Range of 300 MHz to 3 GHz

SAR Test Report

Source of Uncertainty	Uncertainty (± %)	Probability Distribution	Divisor	Ci (1g)	Ci (10g)	Standard Uncertainty (± %, 1g)	Standard Uncertainty (± %, 10g)	Vi
Measurement System								
Probe Calibration	6.55	Normal	1	1	1	6.55	6.55	∞
Axial Isotropy	4.7	Rectangular	√3	0.7	0.7	1.9	1.9	∞
Hemispherical Isotropy	9.6	Rectangular	√3	0.7	0.7	3.9	3.9	∞
Boundary Effect	2.0	Rectangular	√3	1	1	1.2	1.2	∞
Linearity	4.7	Rectangular	√3	1	1	2.7	2.7	∞
Detection Limits	0.25	Rectangular	√3	1	1	0.14	0.14	∞
Probe Modulation Response	4.8	Rectangular	√3	1	1	2.8	2.8	∞
Readout Electronics	0.3	Normal	1	1	1	0.3	0.3	∞
Response Time	0.0	Rectangular	√3	1	1	0.0	0.0	∞
Integration Time	1.7	Rectangular	√3	1	1	1.0	1.0	∞
RF Ambient Conditions – Noise	3.0	Rectangular	√3	1	1	1.7	1.7	∞
RF Ambient Conditions – Reflections	3.0	Rectangular	√3	1	1	1.7	1.7	∞
Probe Positioner Mechanical Tolerance	0.04	Rectangular	√3	1	1	0.02	0.02	∞
Probe Positioning with Respect to Phantom	0.8	Rectangular	√3	1	1	0.5	0.5	∞
Post-processing	4.0	Rectangular	√3	1	1	2.3	2.3	∞
Test Sample Related								
Test Sample Positioning	3.68 / 1.73	Normal	1	1	1	3.7	1.7	29
Device Holder Uncertainty	2.55 / 2.76	Normal	1	1	1	2.6	2.8	7
Power Drift of Measurement	5.0	Rectangular	√3	1	1	2.9	2.9	∞
PowerScaling	0.0	Rectangular	√3	1	1	0.0	0.0	∞
Phantom and Setup								
Phantom Uncertainty (Shape and Thickness Tolerances)	7.6	Rectangular	√3	1	1	4.4	4.4	∞
Liquid Conductivity (Temperature Uncertainty)	2.58	Rectangular	√3	0.78	0.71	1.2	1.1	∞
Liquid Conductivity (Measured)	2.95	Normal	1	0.78	0.71	2.3	2.1	61
Liquid Permittivity (Temperature Uncertainty)	1.97	Rectangular	√3	0.23	0.26	0.3	0.3	∞
Liquid Permittivity (Measured)	3.04	Normal	1	0.23	0.26	0.7	0.8	47
Combined Standard Uncertainty						± 12.1 %	± 11.6 %	
Expanded Uncertainty (K=2)						± 24.2 %	± 23.2 %	

Body SAR Uncertainty Budget for Frequency Range of 3 GHz to 6 GHz

7. Information of the Testing Laboratories

We, Bureau Veritas Consumer Products Services (H.K.) Ltd., Taoyuan Branch, were founded in 1988 to provide our best service in EMC, Radio, Telecom and Safety consultation. Our laboratories are accredited and approved according to ISO/IEC 17025.

If you have any comments, please feel free to contact us at the following:

Taiwan Huaya Lab:

Add: No. 19, Huaya 2nd Rd., Guishan Dist., Taoyuan City 333, Taiwan

Tel: +886-(0)3-318-3232

Fax: +886-(0)3-211-5834

Taiwan Linkou Lab:

Add: No. 47-2, Baodoucuokeng, Linkou Dist., New Taipei City 244, Taiwan

Tel: +886-(0)2-2605-2180

Fax: +886-(0)2-2605-2943

Taiwan Hsinchu Lab1:

Add: E-2, No. 1, Lixing 1st Rd., East Dist., Hsinchu City 300, Taiwan

Tel: +886-(0)3-666-8565

Fax: +886-(0)3-666-8323

Taiwan Hsinchu Lab2:

Add: No. 49, Ln. 206, Wende Rd., Qionglin Township, Hsinchu County 307, Taiwan

Tel: +886-(0)3-512-0595

Fax: +886-(0)3-512-0568

Taiwan Xindian Lab:

Add: B2F., No. 215, Sec. 3, Beixin Rd., Xindian Dist., New Taipei City 231, Taiwan

Tel: +886-(0)2-8914-5882

Fax: +886-(0)2-8914-5840

Email: service.adt@tw.bureauveritas.com

Web Site: <https://ee.bureauveritas.com.tw/BVInternet/Default>

The road map of all our labs can be found in our web site also.

---END---

Appendix A. SAR Plots of System Verification

The plots for system verification with largest deviation for each SAR system combination are shown as follows.

System Check_H750_201110

DUT: Dipole 750 MHz; Type: D750V3; SN: 1013

Communication System: UID 0, CW; Frequency: 750 MHz; Duty Cycle: 1:1

Medium: H06T09N1_1110 Medium parameters used: $f = 750$ MHz; $\sigma = 0.897$ S/m; $\epsilon_r = 42.647$; $\rho = 1000$ kg/m³

Ambient Temperature : 23.6 °C ; Liquid Temperature : 23.3 °C

DASY5 Configuration:

- Probe: EX3DV4 - SN3971; ConvF(10.6, 10.6, 10.6) @ 750 MHz; Calibrated: 2020/01/27
- Sensor-Surface: 1.4mm (Mechanical Surface Detection)
- Electronics: DAE4 Sn917; Calibrated: 2019/12/17
- Phantom: ELI Phantom_1206; Type: QDOVA002AA;
- Measurement SW: DASY52, Version 52.10 (4); SEMCAD X Version 14.6.14 (7483)

Pin=50mW/Area Scan (61x81x1): Interpolated grid: dx=1.500 mm, dy=1.500 mm

Maximum value of SAR (interpolated) = 0.524 W/kg

Pin=50mW/Zoom Scan (5x5x7)/Cube 0: Measurement grid: dx=8mm, dy=8mm, dz=5mm

Reference Value = 25.07 V/m; Power Drift = 0.08 dB

Peak SAR (extrapolated) = 0.591 W/kg

SAR(1 g) = 0.393 W/kg; SAR(10 g) = 0.259 W/kg (SAR corrected for target medium)

Maximum value of SAR (measured) = 0.525 W/kg

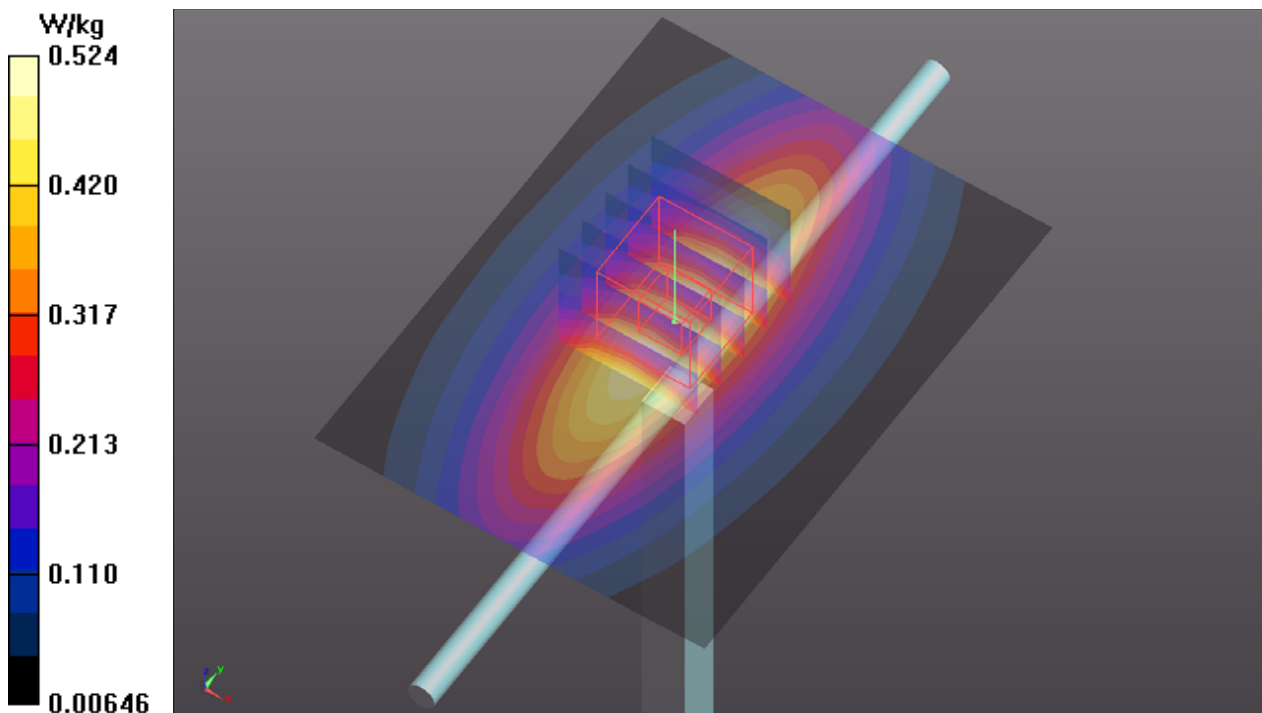

System Check_H835_201109

DUT: Dipole 835 MHz; Type: D835V2; SN: 4d121

Communication System: UID 0, CW; Frequency: 835 MHz; Duty Cycle: 1:1

Medium: H07T10N1_1109 Medium parameters used: $f = 835$ MHz; $\sigma = 0.919$ S/m; $\epsilon_r = 41.759$; $\rho = 1000$ kg/m³

Ambient Temperature : 23.8 °C ; Liquid Temperature : 23.3 °C

DASY5 Configuration:

- Probe: EX3DV4 - SN7472; ConvF(10.11, 10.11, 10.11) @ 835 MHz; Calibrated: 2020/08/24
- Sensor-Surface: 1.4mm (Mechanical Surface Detection)
- Electronics: DAE4 Sn1585; Calibrated: 2020/05/28
- Phantom: ELI Phantom_1245; Type: QDOVA002AA;
- Measurement SW: DASY52, Version 52.10 (4); SEMCAD X Version 14.6.14 (7483)

Pin=50mW/Area Scan (61x61x1): Interpolated grid: dx=1.500 mm, dy=1.500 mm

Maximum value of SAR (interpolated) = 0.692 W/kg

Pin=50mW/Zoom Scan (5x5x7)/Cube 0: Measurement grid: dx=8mm, dy=8mm, dz=5mm

Reference Value = 28.17 V/m; Power Drift = 0.01 dB

Peak SAR (extrapolated) = 0.775 W/kg

SAR(1 g) = 0.509 W/kg; SAR(10 g) = 0.334 W/kg (SAR corrected for target medium)

Maximum value of SAR (measured) = 0.686 W/kg

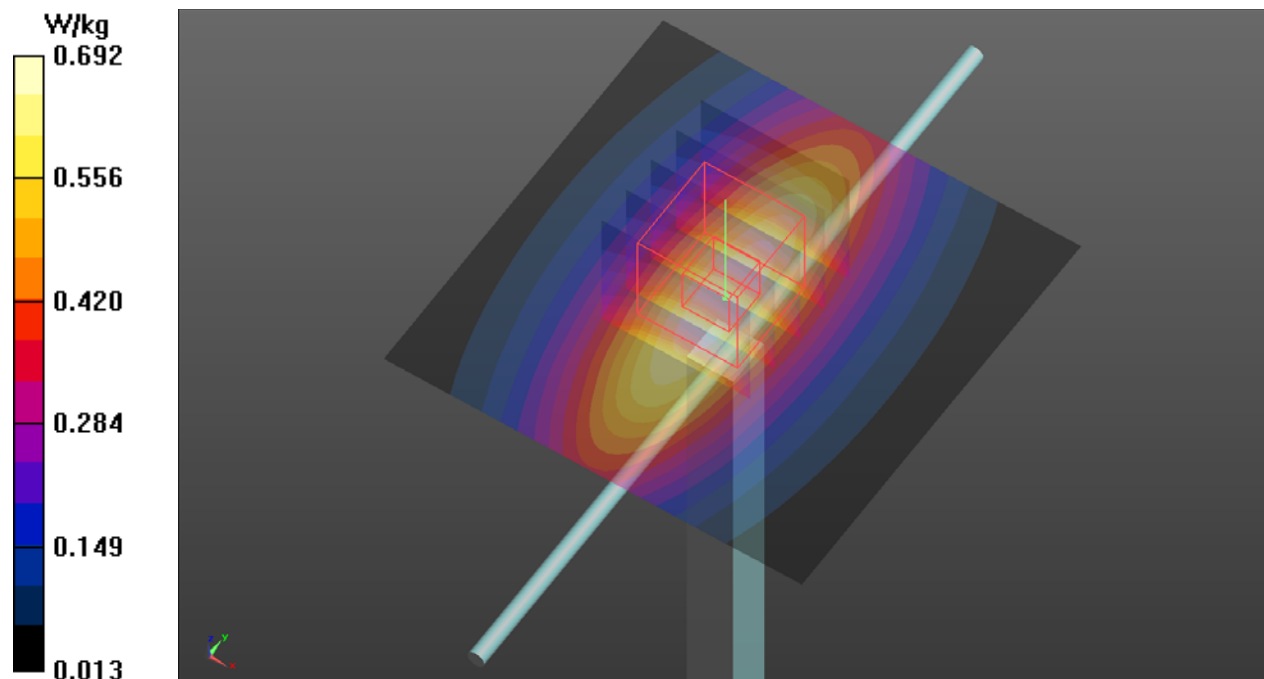

System Check_H1750_201108

DUT: Dipole 1750 MHz; Type: D1750V2; SN: 1055

Communication System: UID 0, CW; Frequency: 1750 MHz; Duty Cycle: 1:1

Medium: H16T20N1_1108 Medium parameters used: $f = 1750$ MHz; $\sigma = 1.328$ S/m; $\epsilon_r = 40.124$; $\rho = 1000$ kg/m³

Ambient Temperature : 23.8 °C ; Liquid Temperature : 23.3 °C

DASY5 Configuration:

- Probe: EX3DV4 - SN7472; ConvF(8.74, 8.74, 8.74) @ 1750 MHz; Calibrated: 2020/08/24
- Sensor-Surface: 1.4mm (Mechanical Surface Detection)
- Electronics: DAE4 Sn1585; Calibrated: 2020/05/28
- Phantom: ELI Phantom_1245; Type: QDOVA002AA;
- Measurement SW: DASY52, Version 52.10 (4); SEMCAD X Version 14.6.14 (7483)

Pin=50mW/Area Scan (61x61x1): Interpolated grid: dx=1.500 mm, dy=1.500 mm

Maximum value of SAR (interpolated) = 2.61 W/kg

Pin=50mW/Zoom Scan (5x5x7)/Cube 0: Measurement grid: dx=8mm, dy=8mm, dz=5mm

Reference Value = 44.83 V/m; Power Drift = 0.03 dB

Peak SAR (extrapolated) = 3.23 W/kg

SAR(1 g) = 1.81 W/kg; SAR(10 g) = 0.939 W/kg (SAR corrected for target medium)

Maximum value of SAR (measured) = 2.67 W/kg

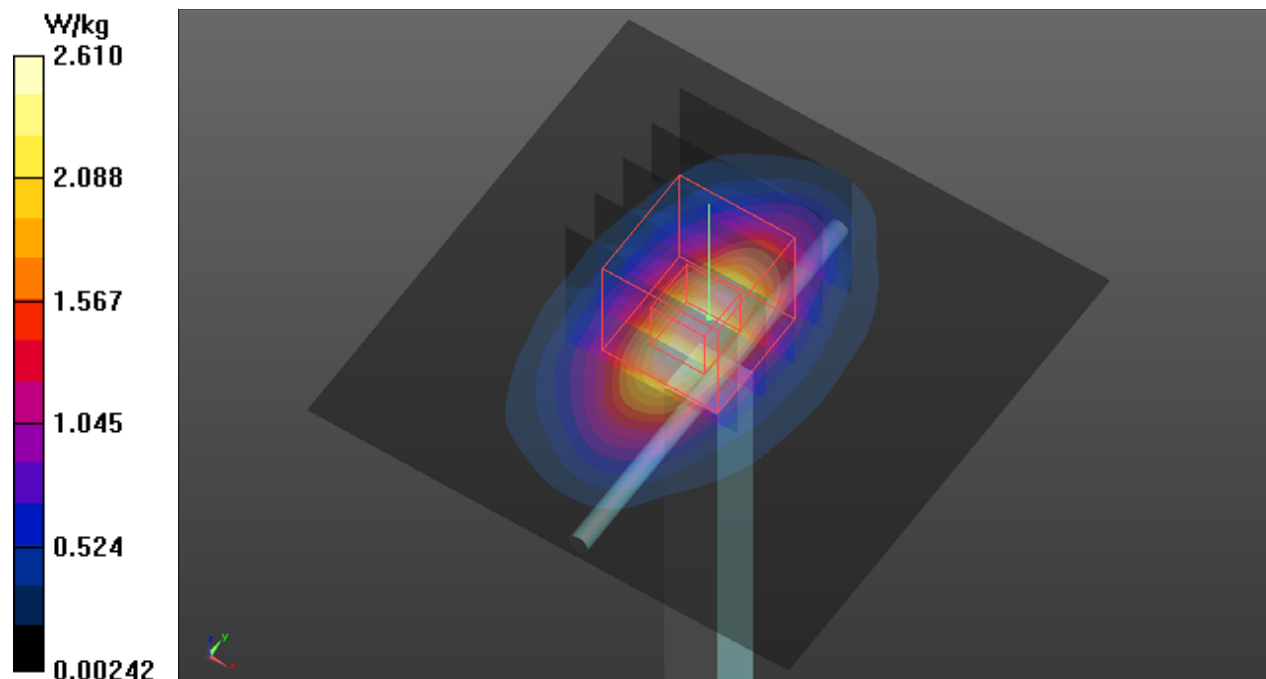

System Check_H1900_201114

DUT: Dipole 1900 MHz; Type: D1900V2; SN: 5d036

Communication System: UID 0, CW; Frequency: 1900 MHz; Duty Cycle: 1:1

Medium: H16T20N1_1114 Medium parameters used: $f = 1900$ MHz; $\sigma = 1.456$ S/m; $\epsilon_r = 39.753$; $\rho = 1000$ kg/m³

Ambient Temperature : 23.8 °C ; Liquid Temperature : 23.3 °C

DASY5 Configuration:

- Probe: EX3DV4 - SN7472; ConvF(8.35, 8.35, 8.35) @ 1900 MHz; Calibrated: 2020/08/24
- Sensor-Surface: 1.4mm (Mechanical Surface Detection)
- Electronics: DAE4 Sn1585; Calibrated: 2020/05/28
- Phantom: ELI Phantom_1245; Type: QDOVA002AA;
- Measurement SW: DASY52, Version 52.10 (4); SEMCAD X Version 14.6.14 (7483)

Pin=50mW/Area Scan (61x61x1): Interpolated grid: dx=1.500 mm, dy=1.500 mm

Maximum value of SAR (interpolated) = 3.06 W/kg

Pin=50mW/Zoom Scan (5x5x7)/Cube 0: Measurement grid: dx=8mm, dy=8mm, dz=5mm

Reference Value = 45.09 V/m; Power Drift = -0.12 dB

Peak SAR (extrapolated) = 3.59 W/kg

SAR(1 g) = 1.91 W/kg; SAR(10 g) = 1.01 W/kg (SAR corrected for target medium)

Maximum value of SAR (measured) = 3.01 W/kg

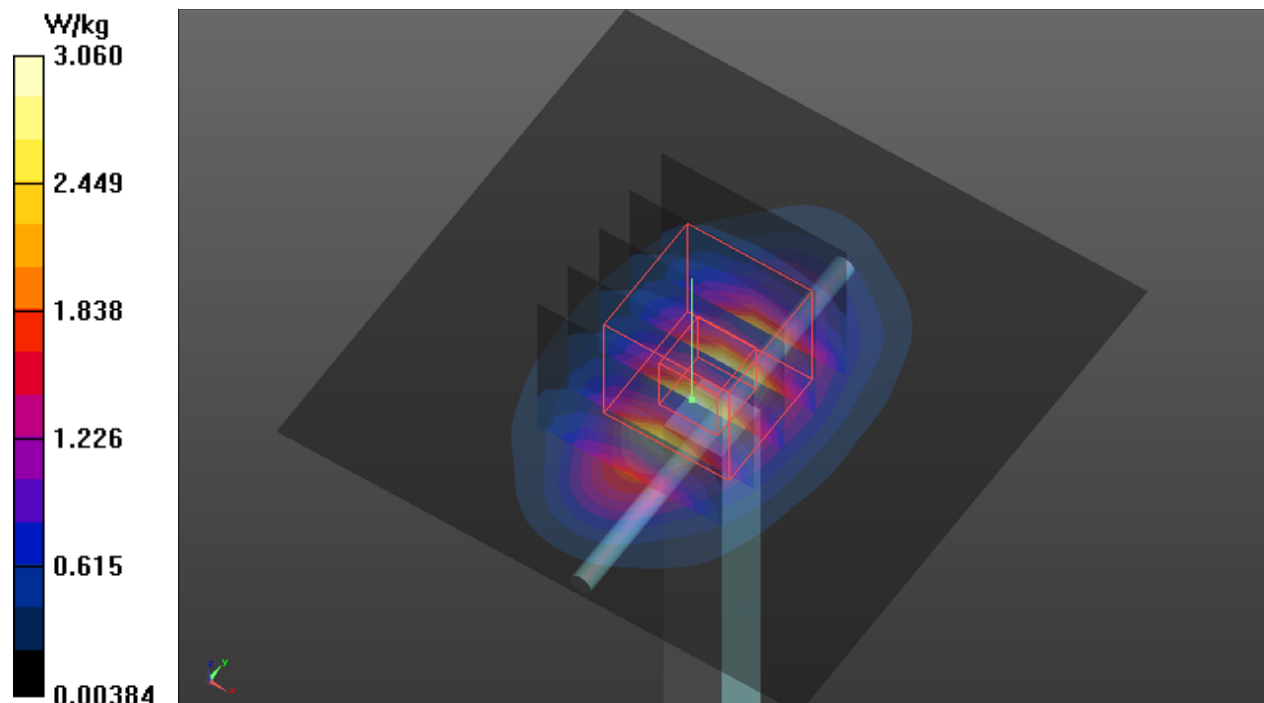

System Check_H2300_201114

DUT: Dipole 2300 MHz; Type: D2300V2; SN:1004

Communication System: UID 0, CW; Frequency: 2300 MHz; Duty Cycle: 1:1

Medium: H19T27N1_1114 Medium parameters used: $f = 2300$ MHz; $\sigma = 1.74$ S/m; $\epsilon_r = 38.873$; $\rho = 1000$ kg/m³

Ambient Temperature : 23.8 °C ; Liquid Temperature : 23.3 °C

DASY5 Configuration:

- Probe: EX3DV4 - SN7472; ConvF(7.94, 7.94, 7.94) @ 2300 MHz; Calibrated: 2020/08/24
- Sensor-Surface: 1.4mm (Mechanical Surface Detection)
- Electronics: DAE4 Sn1585; Calibrated: 2020/05/28
- Phantom: ELI Phantom_1245; Type: QDOVA002AA;
- Measurement SW: DASY52, Version 52.10 (4); SEMCAD X Version 14.6.14 (7483)

Pin=50mW/Area Scan (81x81x1): Interpolated grid: dx=1.200 mm, dy=1.200 mm
Maximum value of SAR (interpolated) = 4.33 W/kg

Pin=50mW/Zoom Scan (7x7x7)/Cube 0: Measurement grid: dx=5mm, dy=5mm, dz=5mm

Reference Value = 51.61 V/m; Power Drift = -0.11 dB

Peak SAR (extrapolated) = 5.28 W/kg

SAR(1 g) = 2.62 W/kg; SAR(10 g) = 1.28 W/kg (SAR corrected for target medium)

Maximum value of SAR (measured) = 4.33 W/kg

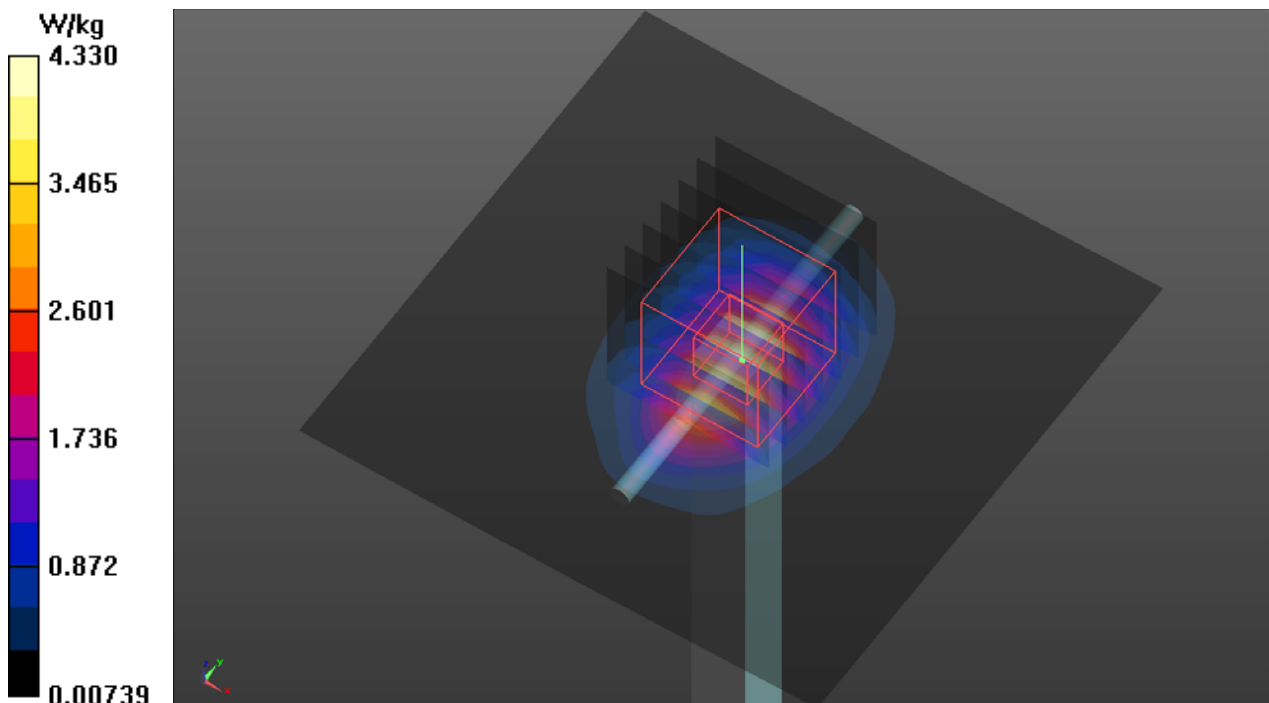

System Check_H2450_201128

DUT: Dipole 2450 MHz; Type: D2450V2; SN: 737

Communication System: UID 0, CW; Frequency: 2450 MHz; Duty Cycle: 1:1

Medium: H19T27N1_1128 Medium parameters used (interpolated): $f = 2450$ MHz; $\sigma = 1.824$ S/m;

$\epsilon_r = 38.456$; $\rho = 1000$ kg/m³

Ambient Temperature : 23.3 °C ; Liquid Temperature : 23.2 °C

DASY5 Configuration:

- Probe: EX3DV4 - SN3820; ConvF(6.85, 6.85, 6.85) @ 2450 MHz; Calibrated: 2020/06/25
- Sensor-Surface: 1.4mm (Mechanical Surface Detection)
- Electronics: DAE4 Sn1431; Calibrated: 2020/03/18
- Phantom: ELI Phantom_1043; Type: QDOVA;
- Measurement SW: DASY52, Version 52.10 (4); SEMCAD X Version 14.6.14 (7483)

Pin=50mW/Area Scan (81x81x1): Interpolated grid: dx=1.200 mm, dy=1.200 mm

Maximum value of SAR (interpolated) = 4.59 W/kg

Pin=50mW/Zoom Scan (7x7x7)/Cube 0: Measurement grid: dx=5mm, dy=5mm, dz=5mm

Reference Value = 51.33 V/m; Power Drift = -0.12 dB

Peak SAR (extrapolated) = 5.45 W/kg

SAR(1 g) = 2.67 W/kg; SAR(10 g) = 1.29 W/kg (SAR corrected for target medium)

Maximum value of SAR (measured) = 4.44 W/kg

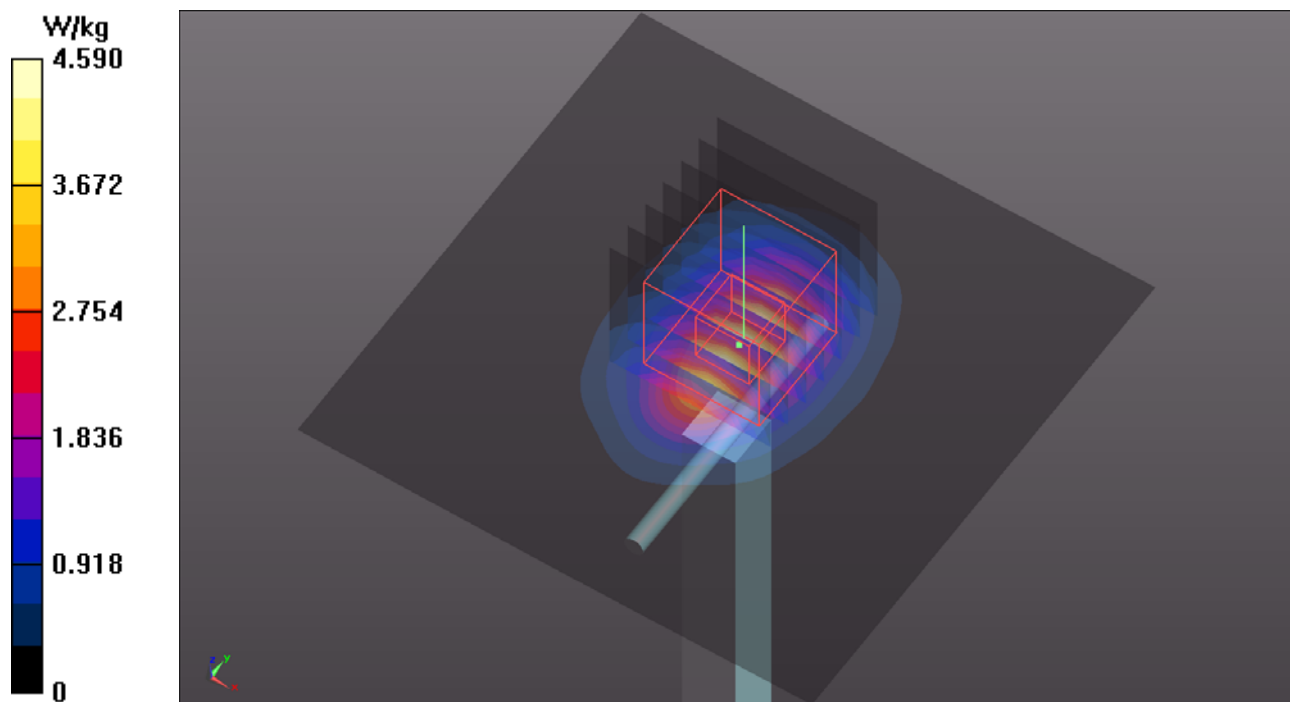

System Check_H2600_201109

DUT: Dipole 2600 MHz; Type: D2600V2; SN: 1020

Communication System: UID 0, CW; Frequency: 2600 MHz; Duty Cycle: 1:1

Medium: H19T27N1_1109 Medium parameters used: $f = 2600$ MHz; $\sigma = 2.037$ S/m; $\epsilon_r = 38.8$; $\rho = 1000$ kg/m³

Ambient Temperature : 23.7 °C ; Liquid Temperature : 23.2 °C

DASY5 Configuration:

- Probe: EX3DV4 - SN7472; ConvF(7.53, 7.53, 7.53) @ 2600 MHz; Calibrated: 2020/08/24
- Sensor-Surface: 1.4mm (Mechanical Surface Detection)
- Electronics: DAE4 Sn1585; Calibrated: 2020/05/28
- Phantom: ELI Phantom_1245; Type: QDOVA002AA;
- Measurement SW: DASY52, Version 52.10 (4); SEMCAD X Version 14.6.14 (7483)

Pin=50mW/Area Scan (81x81x1): Interpolated grid: dx=1.200 mm, dy=1.200 mm

Maximum value of SAR (interpolated) = 4.26 W/kg

Pin=50mW/Zoom Scan (7x7x7)/Cube 0: Measurement grid: dx=5mm, dy=5mm, dz=5mm

Reference Value = 47.37 V/m; Power Drift = -0.12 dB

Peak SAR (extrapolated) = 5.50 W/kg

SAR(1 g) = 2.58 W/kg; SAR(10 g) = 1.22 W/kg (SAR corrected for target medium)

Maximum value of SAR (measured) = 4.38 W/kg

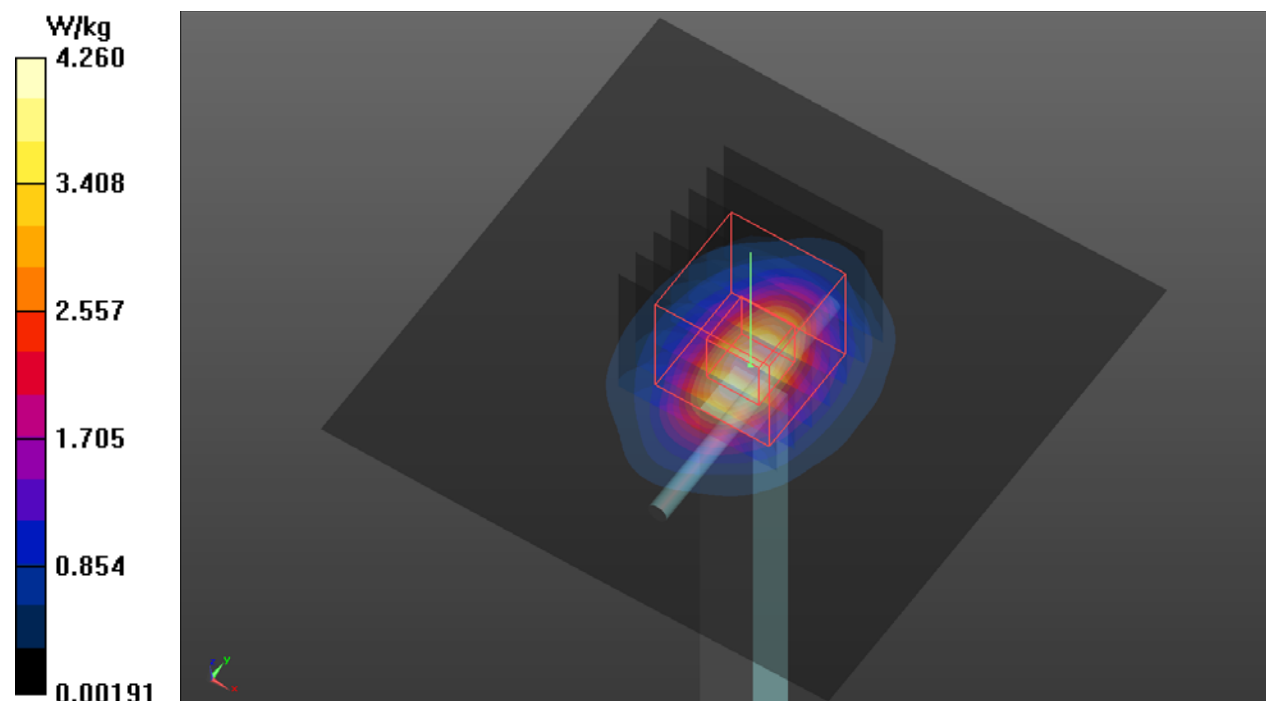

System Check_H5250_201128

DUT: Dipole 5 GHz; Type: D5GHzV2; SN: 1019

Communication System: UID 0, CW; Frequency: 5250 MHz; Duty Cycle: 1:1

Medium: H34T60N1_1128 Medium parameters used (interpolated): $f = 5250$ MHz; $\sigma = 4.781$ S/m;

$\epsilon_r = 34.499$; $\rho = 1000$ kg/m³

Ambient Temperature : 23.3 °C ; Liquid Temperature : 23.2 °C

DASY5 Configuration:

- Probe: EX3DV4 - SN3820; ConvF(4.75, 4.75, 4.75) @ 5250 MHz; Calibrated: 2020/06/25
- Sensor-Surface: 1.4mm (Mechanical Surface Detection)
- Electronics: DAE4 Sn1431; Calibrated: 2020/03/18
- Phantom: ELI Phantom_1043; Type: QDOVA;
- Measurement SW: DASY52, Version 52.10 (4); SEMCAD X Version 14.6.14 (7483)

Pin=50mW/Area Scan (91x91x1): Interpolated grid: dx=1.000 mm, dy=1.000 mm

Maximum value of SAR (interpolated) = 10.2 W/kg

Pin=50mW/Zoom Scan (7x7x7)/Cube 0: Measurement grid: dx=4mm, dy=4mm, dz=1.4mm

Reference Value = 47.08 V/m; Power Drift = -0.20 dB

Peak SAR (extrapolated) = 17.0 W/kg

SAR(1 g) = 4.35 W/kg; SAR(10 g) = 1.26 W/kg (SAR corrected for target medium)

Maximum value of SAR (measured) = 10.8 W/kg

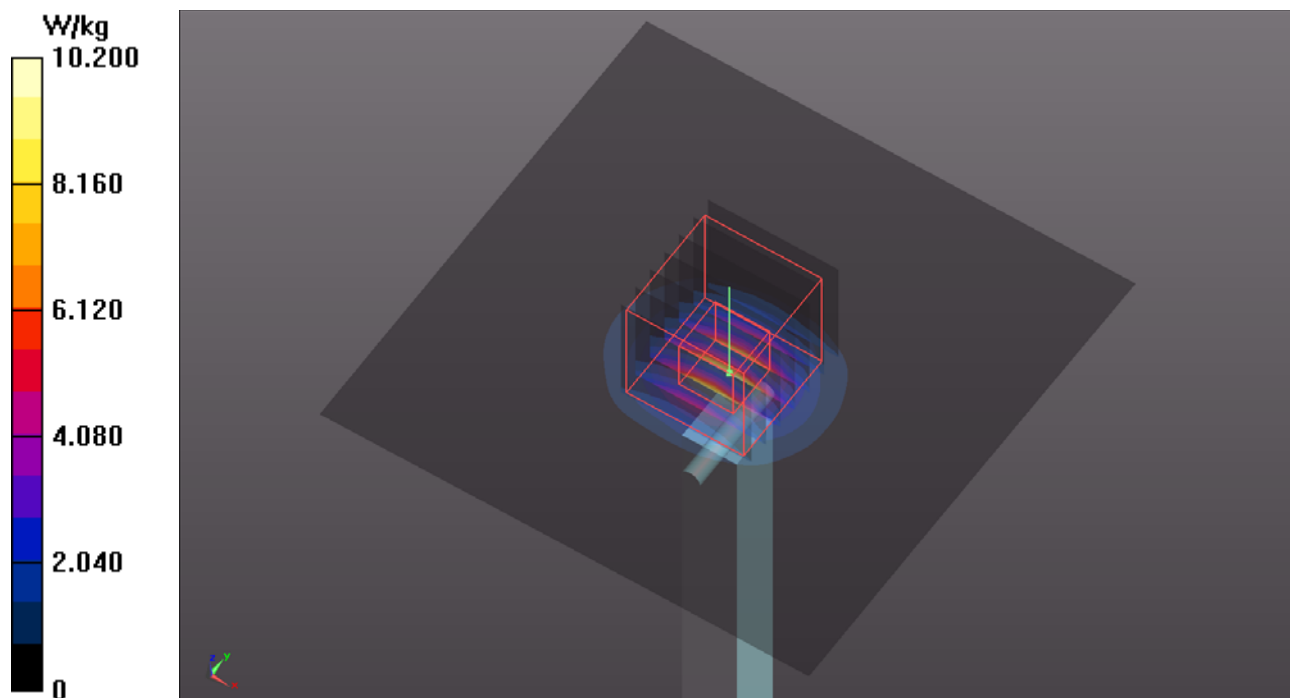

System Check_H5600_201128

DUT: Dipole 5 GHz; Type: D5GHzV2; SN: 1019

Communication System: UID 0, CW; Frequency: 5600 MHz; Duty Cycle: 1:1

Medium: H34T60N1_1128 Medium parameters used: $f = 5600$ MHz; $\sigma = 5.148$ S/m; $\epsilon_r = 34.006$; $\rho = 1000$ kg/m³

Ambient Temperature : 23.3 °C ; Liquid Temperature : 23.2 °C

DASY5 Configuration:

- Probe: EX3DV4 - SN3820; ConvF(4.37, 4.37, 4.37) @ 5600 MHz; Calibrated: 2020/06/25
- Sensor-Surface: 1.4mm (Mechanical Surface Detection)
- Electronics: DAE4 Sn1431; Calibrated: 2020/03/18
- Phantom: ELI Phantom_1043; Type: QDOVA;
- Measurement SW: DASY52, Version 52.10 (4); SEMCAD X Version 14.6.14 (7483)

Pin=50mW/Area Scan (91x91x1): Interpolated grid: dx=1.000 mm, dy=1.000 mm

Maximum value of SAR (interpolated) = 11.1 W/kg

Pin=50mW/Zoom Scan (7x7x7)/Cube 0: Measurement grid: dx=4mm, dy=4mm, dz=1.4mm

Reference Value = 47.51 V/m; Power Drift = -0.18 dB

Peak SAR (extrapolated) = 19.5 W/kg

SAR(1 g) = 4.57 W/kg; SAR(10 g) = 1.31 W/kg (SAR corrected for target medium)

Maximum value of SAR (measured) = 11.7 W/kg

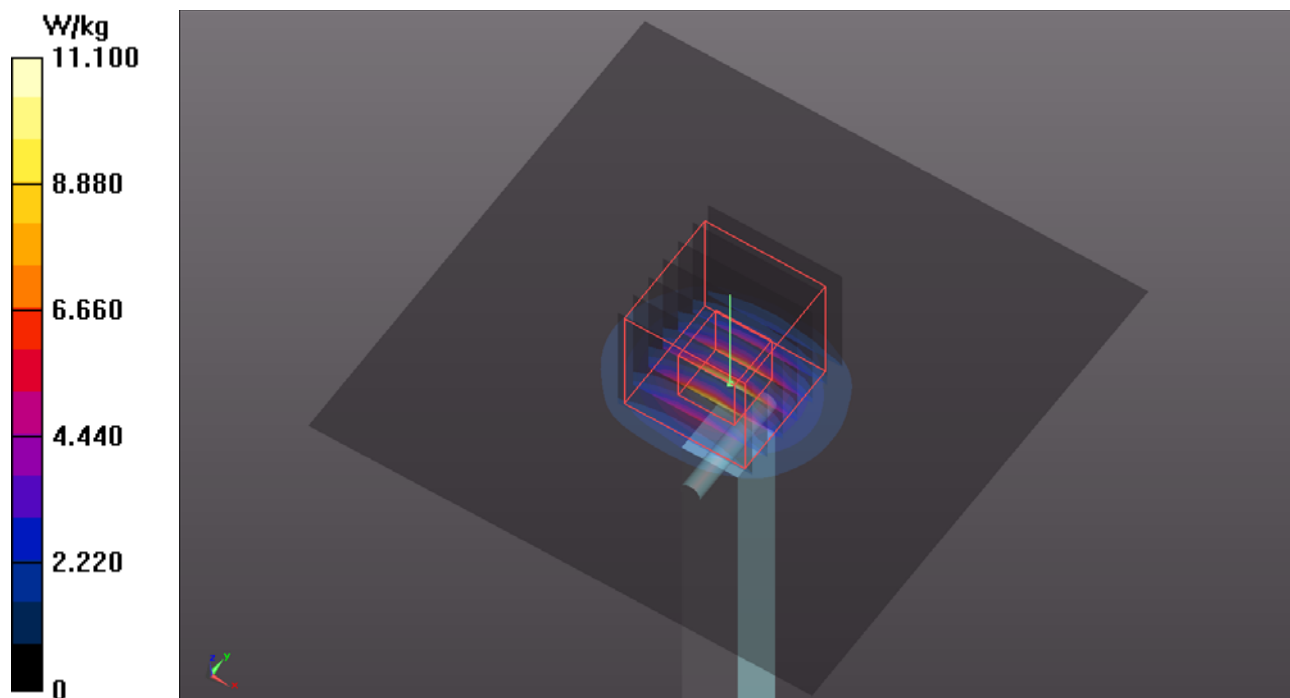

System Check_H5750_201128

DUT: Dipole 5 GHz; Type: D5GHzV2; SN: 1019

Communication System: UID 0, CW; Frequency: 5750 MHz; Duty Cycle: 1:1

Medium: H34T60N1_1128 Medium parameters used: $f = 5750$ MHz; $\sigma = 5.293$ S/m; $\epsilon_r = 33.858$; $\rho = 1000$ kg/m³

Ambient Temperature : 23.3 °C ; Liquid Temperature : 23.2 °C

DASY5 Configuration:

- Probe: EX3DV4 - SN3820; ConvF(4.4, 4.4, 4.4) @ 5750 MHz; Calibrated: 2020/06/25
- Sensor-Surface: 1.4mm (Mechanical Surface Detection)
- Electronics: DAE4 Sn1431; Calibrated: 2020/03/18
- Phantom: ELI Phantom_1043; Type: QDOVA;
- Measurement SW: DASY52, Version 52.10 (4); SEMCAD X Version 14.6.14 (7483)

Pin=50mW/Area Scan (91x91x1): Interpolated grid: dx=1.000 mm, dy=1.000 mm
Maximum value of SAR (interpolated) = 10.3 W/kg

Pin=50mW/Zoom Scan (7x7x7)/Cube 0: Measurement grid: dx=4mm, dy=4mm, dz=1.4mm
Reference Value = 45.04 V/m; Power Drift = -0.18 dB
Peak SAR (extrapolated) = 19.1 W/kg
SAR(1 g) = 4.21 W/kg; SAR(10 g) = 1.19 W/kg (SAR corrected for target medium)
Maximum value of SAR (measured) = 11.0 W/kg

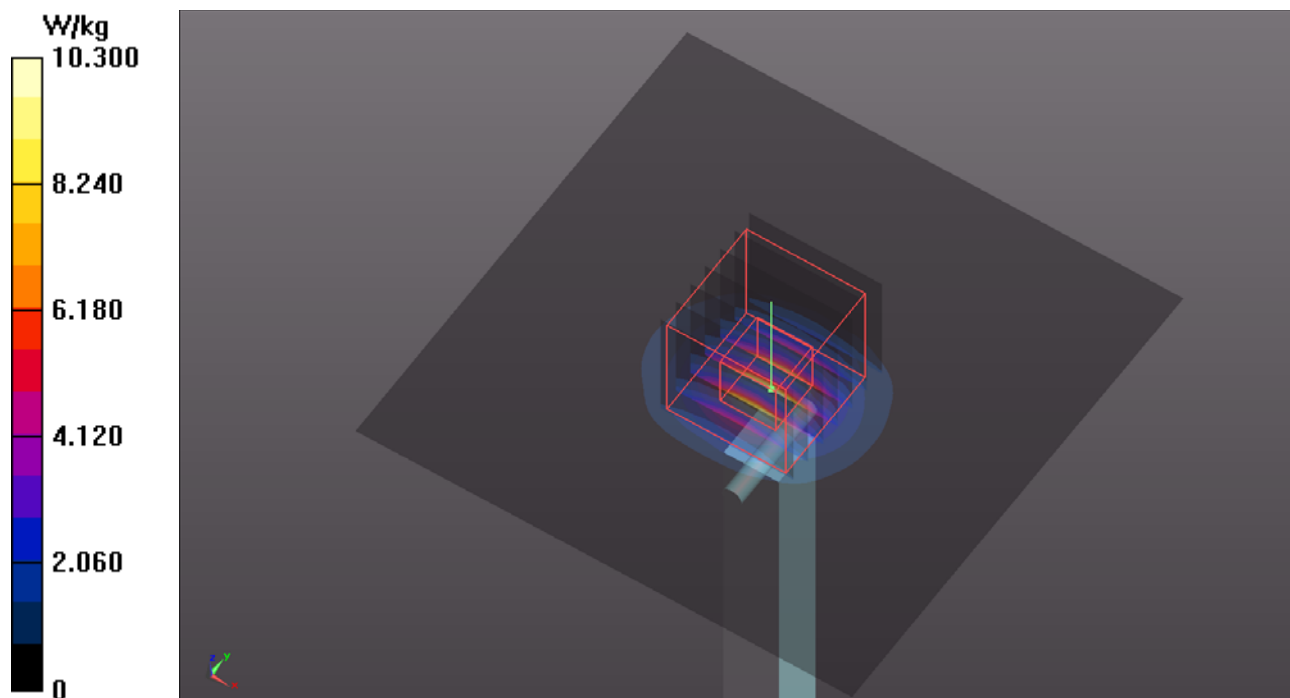

Appendix B. SAR Plots of SAR Measurement

The SAR plots for highest measured SAR in each exposure configuration, wireless mode and frequency band combination, and measured SAR > 1.5 W/kg are shown as follows.

P01 WCDMA II_RMC12.2K_Top Side_0mm_Ch9262_Vendor WNC_P-Sensor_w

DUT: BEDW-WTW-P20080369

Communication System: UID 10011 - CAB, UMTS-FDD (WCDMA); Frequency: 1852.4 MHz; Duty Cycle: 1:1.95
Medium: H16T20N1_1108 Medium parameters used (interpolated): $f = 1852.4$ MHz; $\sigma = 1.418$ S/m; $\epsilon_r = 39.731$; $\rho = 1000$ kg/m³
Ambient Temperature : 23.8 °C ; Liquid Temperature : 23.3 °C

DASY5 Configuration:

- Probe: EX3DV4 - SN7472; ConvF(8.35, 8.35, 8.35) @ 1852.4 MHz; Calibrated: 2020/08/24
- Sensor-Surface: 1.4mm (Mechanical Surface Detection)
- Electronics: DAE4 Sn1585; Calibrated: 2020/05/28
- Phantom: ELI Phantom_1245; Type: QDOVA002AA;
- Measurement SW: DASY52, Version 52.10 (4); SEMCAD X Version 14.6.14 (7483)

Area Scan (61x241x1): Interpolated grid: dx=1.500 mm, dy=1.500 mm
Maximum value of SAR (interpolated) = 0.679 W/kg

Zoom Scan (5x5x7)/Cube 0: Measurement grid: dx=8mm, dy=8mm, dz=5mm
Reference Value = 19.01 V/m; Power Drift = 0.07 dB
Peak SAR (extrapolated) = 0.719 W/kg
SAR(1 g) = 0.352 W/kg; SAR(10 g) = 0.193 W/kg (SAR corrected for target medium)
Smallest distance from peaks to all points 3 dB below = 8.1 mm
Ratio of SAR at M2 to SAR at M1 = 49.2%
Maximum value of SAR (measured) = 0.529 W/kg

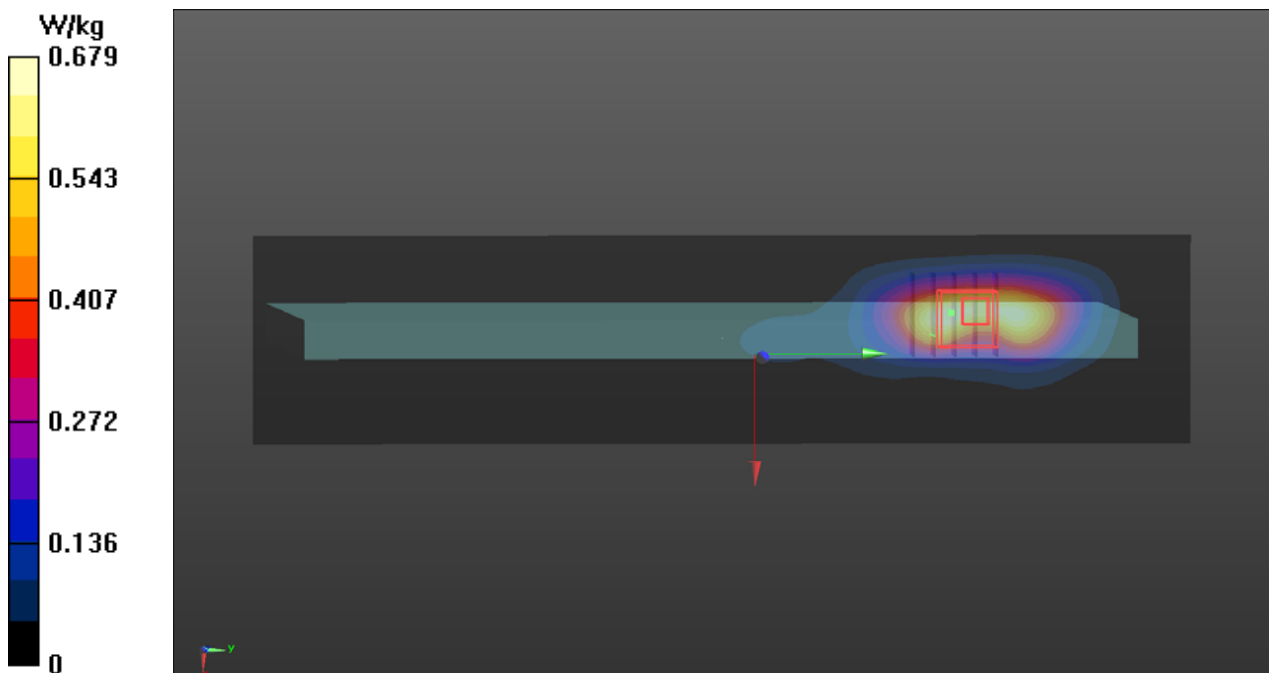

P02 WCDMA IV_RMC12.2K_Top Side_0mm_Ch1513_Vendor WNC_P-Sensor_w

DUT: BEDW-WTW-P20080369

Communication System: UID 10011 - CAB, UMTS-FDD (WCDMA); Frequency: 1752.6 MHz; Duty Cycle: 1:1.95

Medium: H16T20N1_1109 Medium parameters used: $f = 1753$ MHz; $\sigma = 1.328$ S/m; $\epsilon_r = 38.928$; $\rho = 1000$ kg/m³

Ambient Temperature : 23.6 °C ; Liquid Temperature : 23.3 °C

DASY5 Configuration:

- Probe: EX3DV4 - SN3971; ConvF(8.73, 8.73, 8.73) @ 1752.6 MHz; Calibrated: 2020/01/27
- Sensor-Surface: 1.4mm (Mechanical Surface Detection)
- Electronics: DAE4 Sn917; Calibrated: 2019/12/17
- Phantom: ELI Phantom_1206; Type: QDOVA002AA;
- Measurement SW: DASY52, Version 52.10 (4); SEMCAD X Version 14.6.14 (7483)

Area Scan (41x241x1): Interpolated grid: dx=1.500 mm, dy=1.500 mm
Maximum value of SAR (interpolated) = 1.39 W/kg

Zoom Scan (5x5x7)/Cube 0: Measurement grid: dx=8mm, dy=8mm, dz=5mm

Reference Value = 27.57 V/m; Power Drift = -0.14 dB

Peak SAR (extrapolated) = 2.22 W/kg

SAR(1 g) = 1.17 W/kg; SAR(10 g) = 0.600 W/kg (SAR corrected for target medium)

Smallest distance from peaks to all points 3 dB below = 8.2 mm

Ratio of SAR at M2 to SAR at M1 = 49.6%

Maximum value of SAR (measured) = 1.81 W/kg

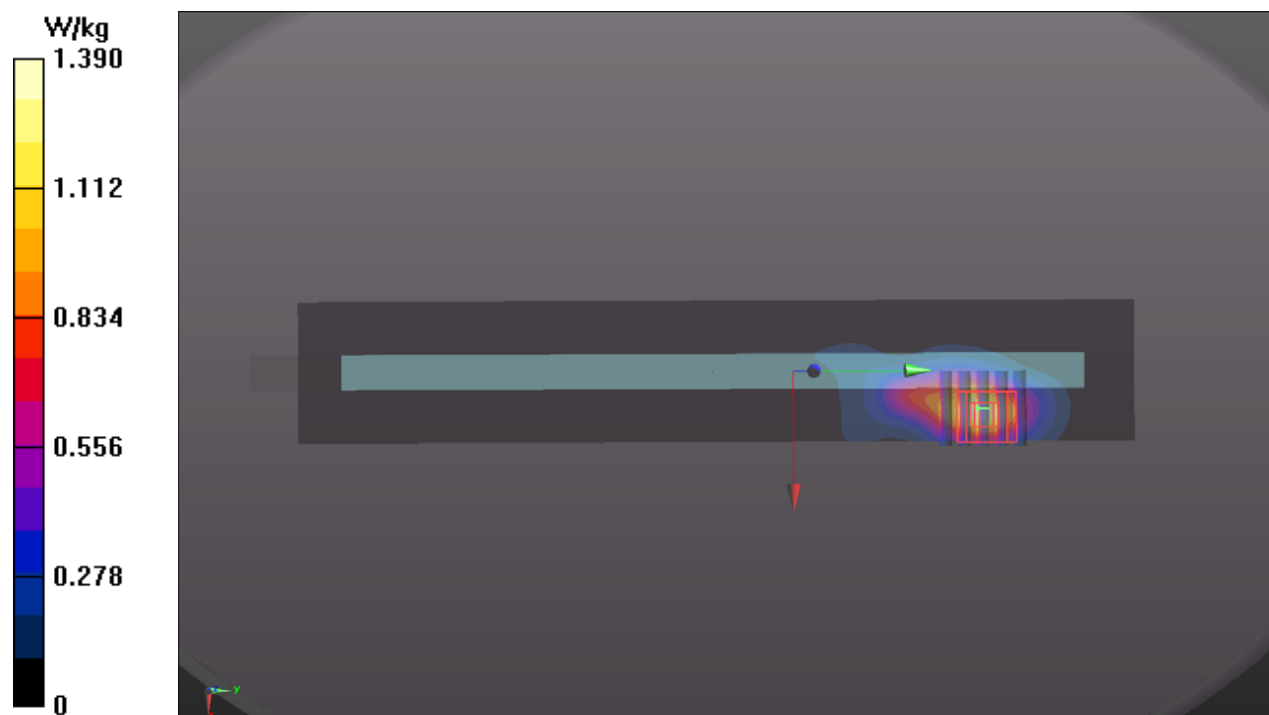

P03 WCDMA V_RMC12.2K_Top Side_0mm_Ch4132_Vendor WNC_P-Sensor_w

DUT: BEDW-WTW-P20080369

Communication System: UID 10011 - CAB, UMTS-FDD (WCDMA); Frequency: 826.4 MHz; Duty Cycle: 1:1.95

Medium: H07T10N1_1111 Medium parameters used (interpolated): $f = 826.4$ MHz; $\sigma = 0.91$ S/m;

$\epsilon_r = 41.798$; $\rho = 1000$ kg/m³

Ambient Temperature : 23.6 °C ; Liquid Temperature : 23.3 °C

DASY5 Configuration:

- Probe: EX3DV4 - SN3971; ConvF(10.26, 10.26, 10.26) @ 826.4 MHz; Calibrated: 2020/01/27
- Sensor-Surface: 1.4mm (Mechanical Surface Detection)
- Electronics: DAE4 Sn917; Calibrated: 2019/12/17
- Phantom: ELI Phantom_1206; Type: QDOVA002AA;
- Measurement SW: DASY52, Version 52.10 (4); SEMCAD X Version 14.6.14 (7483)

Area Scan (41x241x1): Interpolated grid: dx=1.500 mm, dy=1.500 mm

Maximum value of SAR (interpolated) = 0.760 W/kg

Zoom Scan (5x5x7)/Cube 0: Measurement grid: dx=8mm, dy=8mm, dz=5mm

Reference Value = 27.34 V/m; Power Drift = -0.07 dB

Peak SAR (extrapolated) = 1.23 W/kg

SAR(1 g) = 0.649 W/kg; SAR(10 g) = 0.340 W/kg (SAR corrected for target medium)

Smallest distance from peaks to all points 3 dB below = 8.2 mm

Ratio of SAR at M2 to SAR at M1 = 56.6%

Maximum value of SAR (measured) = 0.967 W/kg

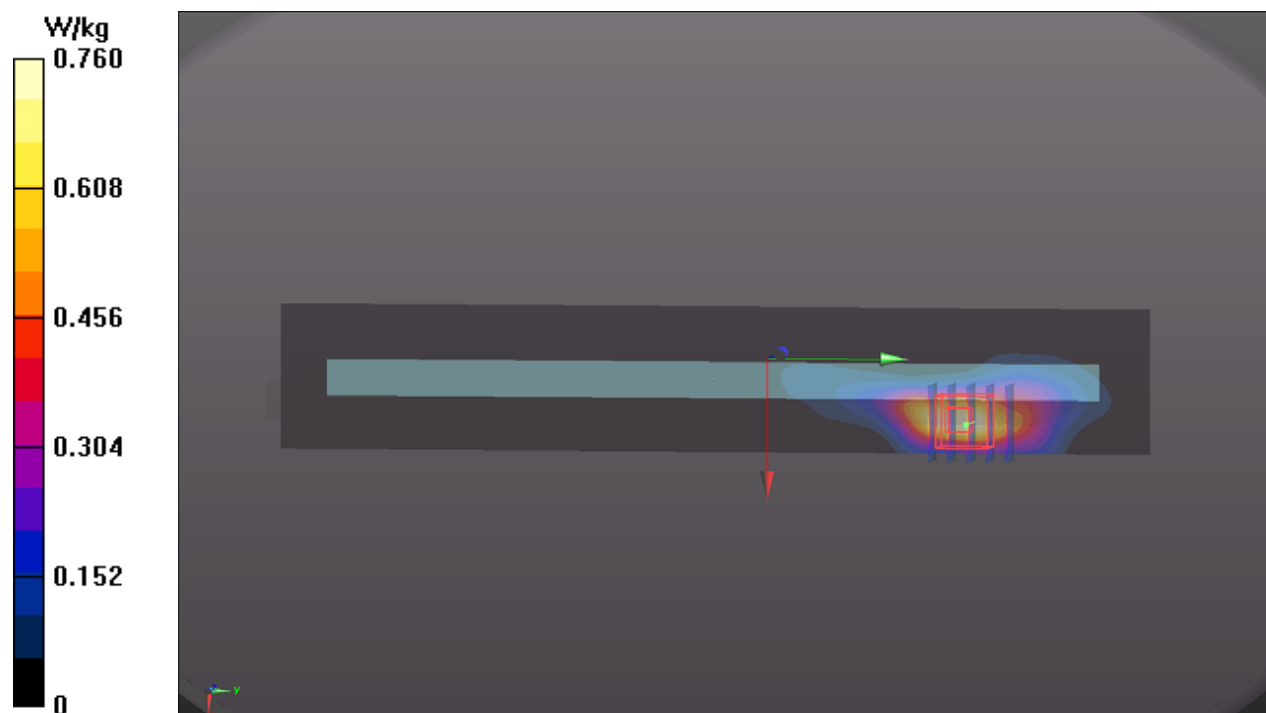

P04 LTE 2_QPSK20M_Top Side_0mm_Ch19100_1RB_OS0_Vendor WNC_P-Sensor_w

DUT: BEDW-WTW-P20080369

Communication System: UID 10169 - CAE, LTE-FDD (SC-FDMA, 1 RB, 20 MHz, QPSK);
Frequency: 1900 MHz; Duty Cycle: 1:3.74

Medium: H16T20N1_1108 Medium parameters used: $f = 1900$ MHz; $\sigma = 1.458$ S/m; $\epsilon_r = 39.578$; $\rho = 1000$ kg/m³

Ambient Temperature : 23.8 °C ; Liquid Temperature : 23.3 °C

DASY5 Configuration:

- Probe: EX3DV4 - SN7472; ConvF(8.35, 8.35, 8.35) @ 1900 MHz; Calibrated: 2020/08/24
- Sensor-Surface: 1.4mm (Mechanical Surface Detection)
- Electronics: DAE4 Sn1585; Calibrated: 2020/05/28
- Phantom: ELI Phantom_1245; Type: QDOVA002AA;
- Measurement SW: DASY52, Version 52.10 (4); SEMCAD X Version 14.6.14 (7483)

Area Scan (61x241x1): Interpolated grid: dx=1.500 mm, dy=1.500 mm

Maximum value of SAR (interpolated) = 1.11 W/kg

Zoom Scan (5x5x7)/Cube 0: Measurement grid: dx=8mm, dy=8mm, dz=5mm

Reference Value = 25.82 V/m; Power Drift = 0.10 dB

Peak SAR (extrapolated) = 1.48 W/kg

SAR(1 g) = 0.684 W/kg; SAR(10 g) = 0.342 W/kg (SAR corrected for target medium)

Smallest distance from peaks to all points 3 dB below = 9.3 mm

Ratio of SAR at M2 to SAR at M1 = 46.3%

Maximum value of SAR (measured) = 1.21 W/kg

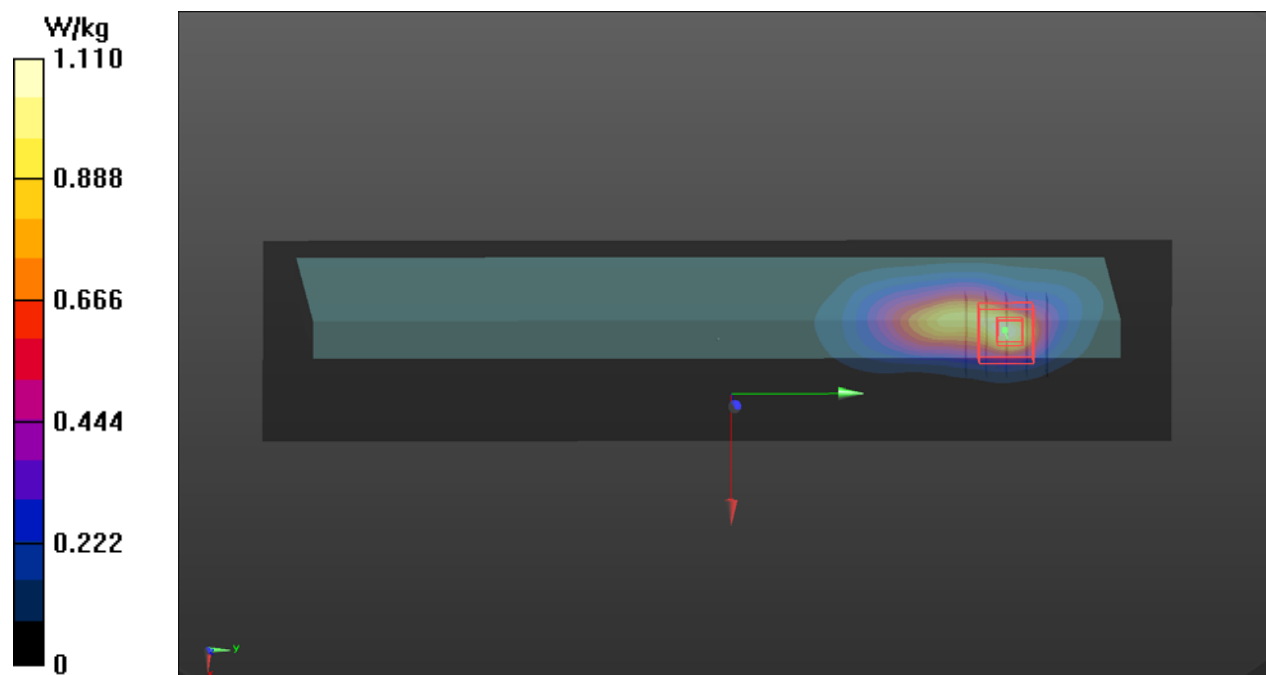

P05 LTE 4_QPSK20M_Top Side_0mm_Ch20300_1RB_OS0_Vendor WNC_P-Sensor_w

DUT: BEDW-WTW-P20080369

Communication System: UID 10169 - CAE, LTE-FDD (SC-FDMA, 1 RB, 20 MHz, QPSK);
Frequency: 1745 MHz; Duty Cycle: 1:3.74
Medium: H16T20N1_1109 Medium parameters used (interpolated): $f = 1745$ MHz; $\sigma = 1.32$ S/m; $\epsilon_r = 38.963$; $\rho = 1000$ kg/m³
Ambient Temperature : 23.6 °C ; Liquid Temperature : 23.3 °C

DASY5 Configuration:

- Probe: EX3DV4 - SN3971; ConvF(8.73, 8.73, 8.73) @ 1745 MHz; Calibrated: 2020/01/27
- Sensor-Surface: 1.4mm (Mechanical Surface Detection)
- Electronics: DAE4 Sn917; Calibrated: 2019/12/17
- Phantom: ELI Phantom_1206; Type: QDOVA002AA;
- Measurement SW: DASY52, Version 52.10 (4); SEMCAD X Version 14.6.14 (7483)

Area Scan (41x241x1): Interpolated grid: dx=1.500 mm, dy=1.500 mm
Maximum value of SAR (interpolated) = 2.12 W/kg

Zoom Scan (5x5x7)/Cube 0: Measurement grid: dx=8mm, dy=8mm, dz=5mm
Reference Value = 36.76 V/m; Power Drift = 0.11 dB
Peak SAR (extrapolated) = 2.44 W/kg
SAR(1 g) = 1.13 W/kg; SAR(10 g) = 0.555 W/kg (SAR corrected for target medium)
Smallest distance from peaks to all points 3 dB below = 8.2 mm
Ratio of SAR at M2 to SAR at M1 = 47.5%
Maximum value of SAR (measured) = 1.92 W/kg

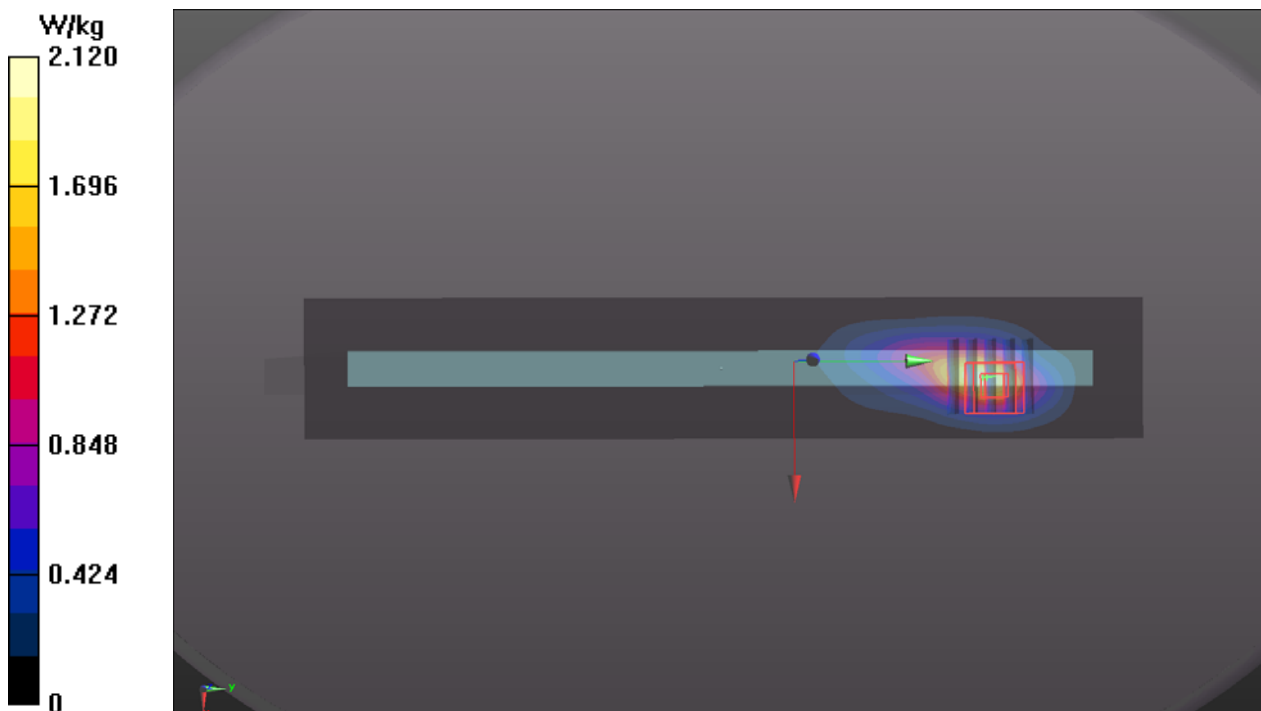

P06 LTE 5_QPSK10M_Top Side_0mm_Ch20450_1RB_OS0_Vendor WNC_P-Sensor_w

DUT: BEDW-WTW-P20080369

Communication System: UID 10175 - CAG, LTE-FDD (SC-FDMA, 1 RB, 10 MHz, QPSK);
Frequency: 829 MHz; Duty Cycle: 1:3.74
Medium: H07T10N1_1109 Medium parameters used: $f = 829$ MHz; $\sigma = 0.914$ S/m; $\epsilon_r = 41.836$; $\rho = 1000$ kg/m³
Ambient Temperature : 23.8 °C ; Liquid Temperature : 23.3 °C

DASY5 Configuration:

- Probe: EX3DV4 - SN7472; ConvF(10.11, 10.11, 10.11) @ 829 MHz; Calibrated: 2020/08/24
- Sensor-Surface: 1.4mm (Mechanical Surface Detection)
- Electronics: DAE4 Sn1585; Calibrated: 2020/05/28
- Phantom: ELI Phantom_1245; Type: QDOVA002AA;
- Measurement SW: DASY52, Version 52.10 (4); SEMCAD X Version 14.6.14 (7483)

Area Scan (61x241x1): Interpolated grid: dx=1.500 mm, dy=1.500 mm
Maximum value of SAR (interpolated) = 1.18 W/kg

Zoom Scan (5x5x7)/Cube 0: Measurement grid: dx=8mm, dy=8mm, dz=5mm
Reference Value = 37.24 V/m; Power Drift = -0.12 dB
Peak SAR (extrapolated) = 1.59 W/kg
SAR(1 g) = 0.743 W/kg; SAR(10 g) = 0.358 W/kg (SAR corrected for target medium)
Smallest distance from peaks to all points 3 dB below = 8.1 mm
Ratio of SAR at M2 to SAR at M1 = 49.1%
Maximum value of SAR (measured) = 1.18 W/kg

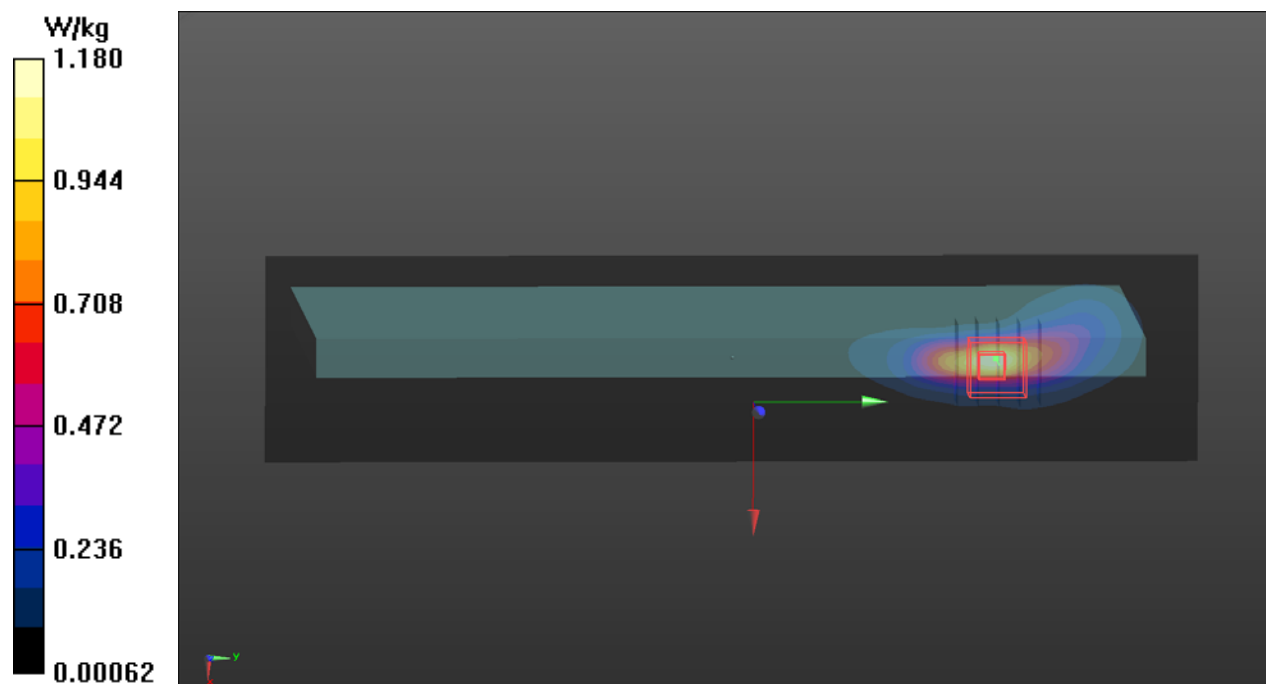

P07 LTE 7_QPSK20M_Top Side_0mm_Ch20850_1RB_OS0_Vendor WNC_P-Sensor_w

DUT: BEDW-WTW-P20080369

Communication System: UID 10169 - CAE, LTE-FDD (SC-FDMA, 1 RB, 20 MHz, QPSK);
Frequency: 2510 MHz; Duty Cycle: 1:3.74
Medium: H19T27N1_1109 Medium parameters used: $f = 2510$ MHz; $\sigma = 1.938$ S/m; $\epsilon_r = 39.11$; $\rho = 1000$ kg/m³
Ambient Temperature : 23.8 °C ; Liquid Temperature : 23.3 °C

DASY5 Configuration:

- Probe: EX3DV4 - SN7472; ConvF(7.53, 7.53, 7.53) @ 2510 MHz; Calibrated: 2020/08/24
- Sensor-Surface: 1.4mm (Mechanical Surface Detection)
- Electronics: DAE4 Sn1585; Calibrated: 2020/05/28
- Phantom: ELI Phantom_1245; Type: QDOVA002AA;
- Measurement SW: DASY52, Version 52.10 (4); SEMCAD X Version 14.6.14 (7483)

Area Scan (71x301x1): Interpolated grid: dx=1.200 mm, dy=1.200 mm
Maximum value of SAR (interpolated) = 1.89 W/kg

Zoom Scan (7x7x7)/Cube 0: Measurement grid: dx=5mm, dy=5mm, dz=5mm
Reference Value = 31.95 V/m; Power Drift = -0.05 dB
Peak SAR (extrapolated) = 2.81 W/kg
SAR(1 g) = 1.18 W/kg; SAR(10 g) = 0.584 W/kg (SAR corrected for target medium)
Smallest distance from peaks to all points 3 dB below = 7.1 mm
Ratio of SAR at M2 to SAR at M1 = 44.2%
Maximum value of SAR (measured) = 2.20 W/kg

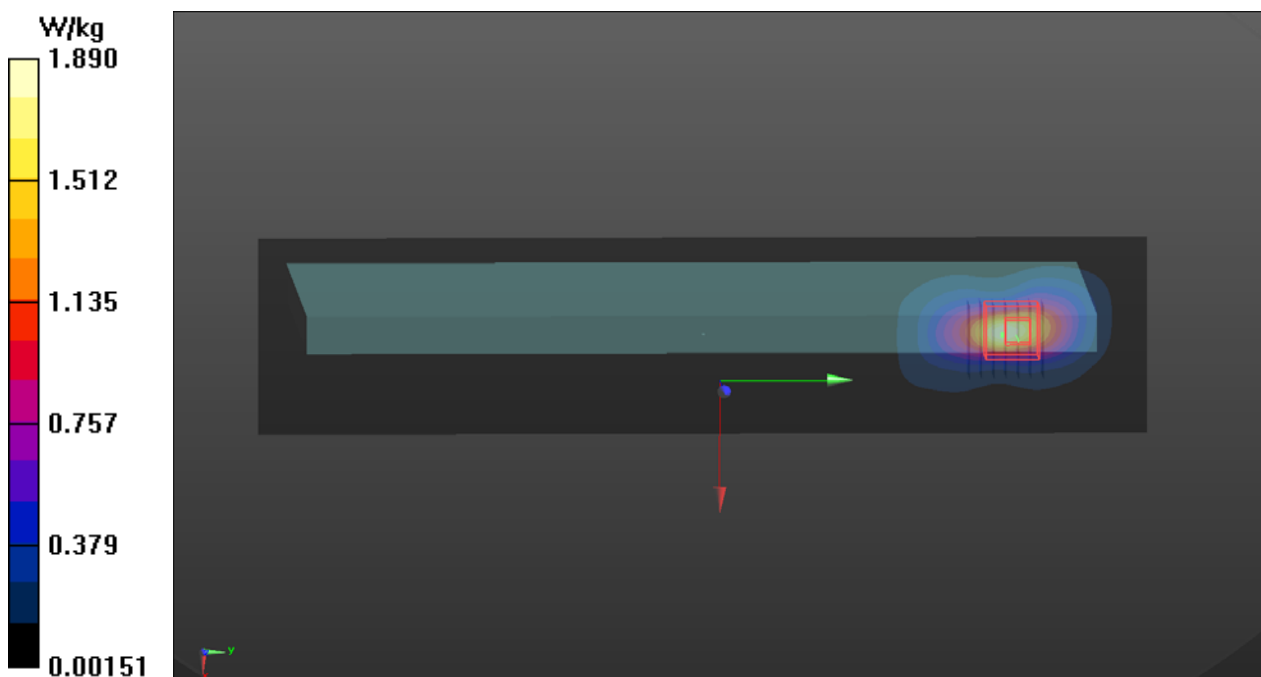

P08 LTE 12_QPSK10M_Top Side_0mm_Ch23095_1RB_OS0_Vendor WNC_P-Sensor_w_o

DUT: BEDW-WTW-P20080369

Communication System: UID 10175 - CAG, LTE-FDD (SC-FDMA, 1 RB, 10 MHz, QPSK);
Frequency: 707.5 MHz; Duty Cycle: 1:3.74
Medium: H06T09N1_1115 Medium parameters used (interpolated): $f = 707.5$ MHz; $\sigma = 0.855$ S/m;
 $\epsilon_r = 44.011$; $\rho = 1000$ kg/m³
Ambient Temperature : 23.7 °C ; Liquid Temperature : 23.1 °C

DASY5 Configuration:

- Probe: EX3DV4 - SN7472; ConvF(10.54, 10.54, 10.54) @ 707.5 MHz; Calibrated: 2020/08/24
- Sensor-Surface: 1.4mm (Mechanical Surface Detection)
- Electronics: DAE4 Sn1585; Calibrated: 2020/05/28
- Phantom: ELI Phantom_1245; Type: QDOVA002AA;
- Measurement SW: DASY52, Version 52.10 (4); SEMCAD X Version 14.6.14 (7483)

Area Scan (41x241x1): Interpolated grid: dx=1.500 mm, dy=1.500 mm
Maximum value of SAR (interpolated) = 1.94 W/kg

Zoom Scan (5x5x7)/Cube 0: Measurement grid: dx=8mm, dy=8mm, dz=5mm
Reference Value = 45.94 V/m; Power Drift = -0.12 dB
Peak SAR (extrapolated) = 3.11 W/kg
SAR(1 g) = 1.25 W/kg; SAR(10 g) = 0.574 W/kg (SAR corrected for target medium)
Smallest distance from peaks to all points 3 dB below = 8.1 mm
Ratio of SAR at M2 to SAR at M1 = 44.6%
Maximum value of SAR (measured) = 2.42 W/kg

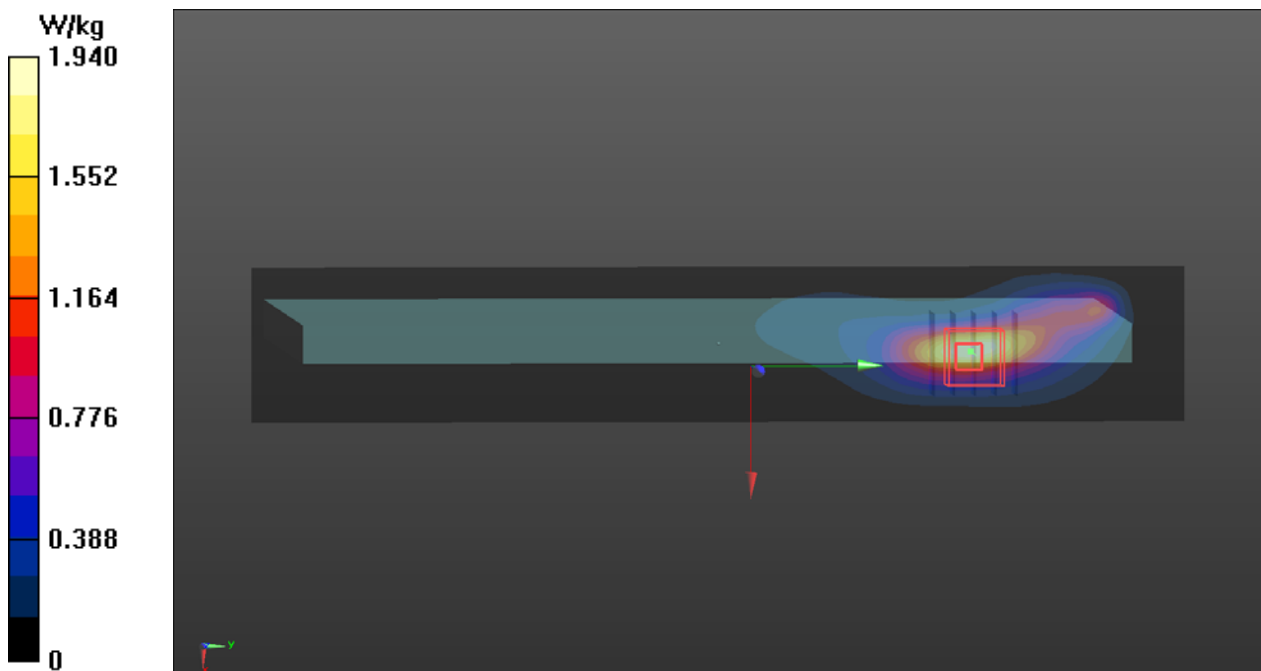

P09 LTE 13_QPSK10M_Top Side_0mm_Ch23230_1RB_OS0_Vendor WNC_P-Sensor_w

DUT: BEDW-WTW-P20080369

Communication System: UID 10175 - CAG, LTE-FDD (SC-FDMA, 1 RB, 10 MHz, QPSK);
Frequency: 782 MHz; Duty Cycle: 1:3.74
Medium: H06T09N1_1110 Medium parameters used: $f = 782 \text{ MHz}$; $\sigma = 0.927 \text{ S/m}$; $\epsilon_r = 42.219$; $\rho = 1000 \text{ kg/m}^3$
Ambient Temperature : $23.6 \text{ }^\circ\text{C}$; Liquid Temperature : $23.3 \text{ }^\circ\text{C}$

DASY5 Configuration:

- Probe: EX3DV4 - SN3971; ConvF(10.6, 10.6, 10.6) @ 782 MHz; Calibrated: 2020/01/27
- Sensor-Surface: 1.4mm (Mechanical Surface Detection)
- Electronics: DAE4 Sn917; Calibrated: 2019/12/17
- Phantom: ELI Phantom_1206; Type: QDOVA002AA;
- Measurement SW: DASY52, Version 52.10 (4); SEMCAD X Version 14.6.14 (7483)

Area Scan (41x241x1): Interpolated grid: $dx=1.500 \text{ mm}$, $dy=1.500 \text{ mm}$
Maximum value of SAR (interpolated) = 1.25 W/kg

Zoom Scan (5x5x7)/Cube 0: Measurement grid: $dx=8\text{mm}$, $dy=8\text{mm}$, $dz=5\text{mm}$
Reference Value = 38.43 V/m ; Power Drift = 0.15 dB
Peak SAR (extrapolated) = 1.52 W/kg
SAR(1 g) = 0.763 W/kg ; SAR(10 g) = 0.396 W/kg (SAR corrected for target medium)
Smallest distance from peaks to all points 3 dB below = 8.4 mm
Ratio of SAR at M2 to SAR at M1 = 52.3%
Maximum value of SAR (measured) = 1.29 W/kg

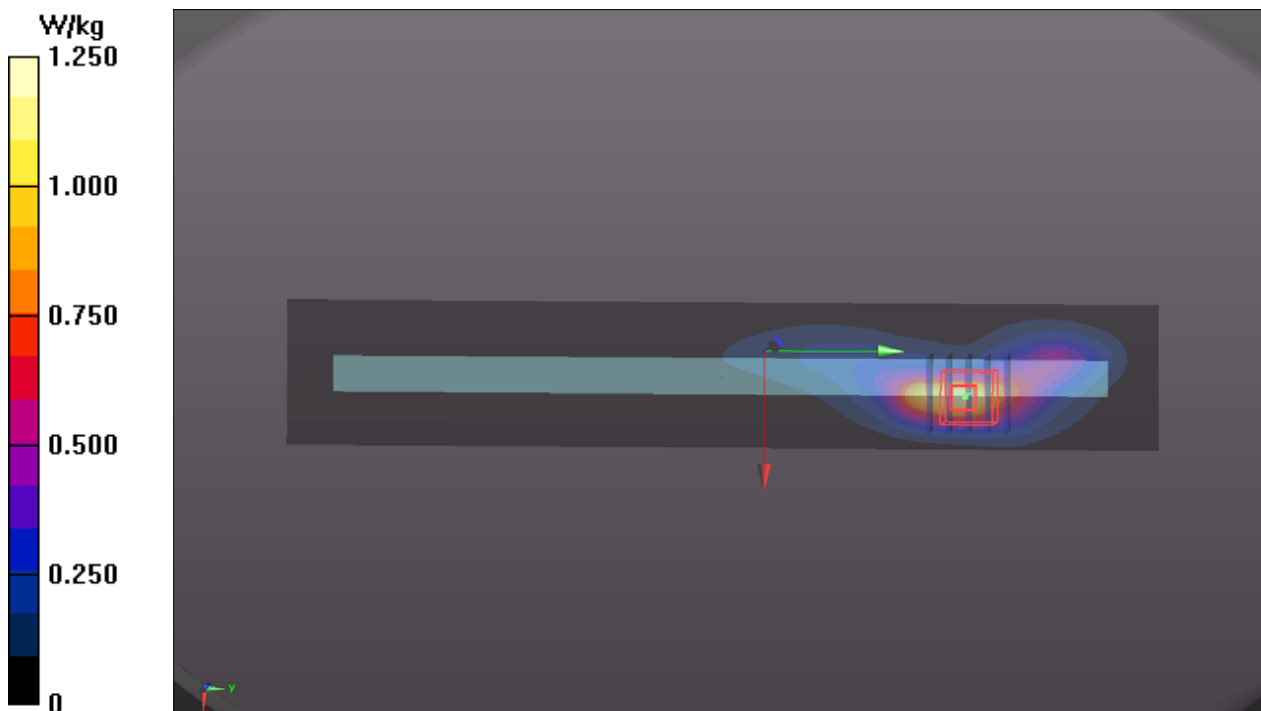

P10 LTE 14_QPSK10M_Top Side_0mm_Ch23330_1RB_OS0_Vendor WNC_P-Sensor_w

DUT: BEDW-WTW-P20080369

Communication System: UID 10175 - CAG, LTE-FDD (SC-FDMA, 1 RB, 10 MHz, QPSK);
Frequency: 793 MHz; Duty Cycle: 1:3.74
Medium: H06T09N1_1115 Medium parameters used: $f = 793 \text{ MHz}$; $\sigma = 0.926 \text{ S/m}$; $\epsilon_r = 42.856$; $\rho = 1000 \text{ kg/m}^3$
Ambient Temperature : $23.8 \text{ }^\circ\text{C}$; Liquid Temperature : $23.3 \text{ }^\circ\text{C}$

DASY5 Configuration:
- Probe: EX3DV4 - SN7472; ConvF(10.54, 10.54, 10.54) @ 793 MHz; Calibrated: 2020/08/24
- Sensor-Surface: 1.4mm (Mechanical Surface Detection)
- Electronics: DAE4 Sn1585; Calibrated: 2020/05/28
- Phantom: ELI Phantom_1245; Type: QDOVA002AA;
- Measurement SW: DASY52, Version 52.10 (4); SEMCAD X Version 14.6.14 (7483)

Area Scan (41x241x1): Interpolated grid: $dx=1.500 \text{ mm}$, $dy=1.500 \text{ mm}$
Maximum value of SAR (interpolated) = 1.86 W/kg

Zoom Scan (5x5x7)/Cube 0: Measurement grid: $dx=8\text{mm}$, $dy=8\text{mm}$, $dz=5\text{mm}$
Reference Value = 45.13 V/m ; Power Drift = -0.02 dB
Peak SAR (extrapolated) = 2.52 W/kg
SAR(1 g) = 1.11 W/kg ; SAR(10 g) = 0.532 W/kg (SAR corrected for target medium)
Smallest distance from peaks to all points 3 dB below = 8.1 mm
Ratio of SAR at M2 to SAR at M1 = 48.5%
Maximum value of SAR (measured) = 1.82 W/kg

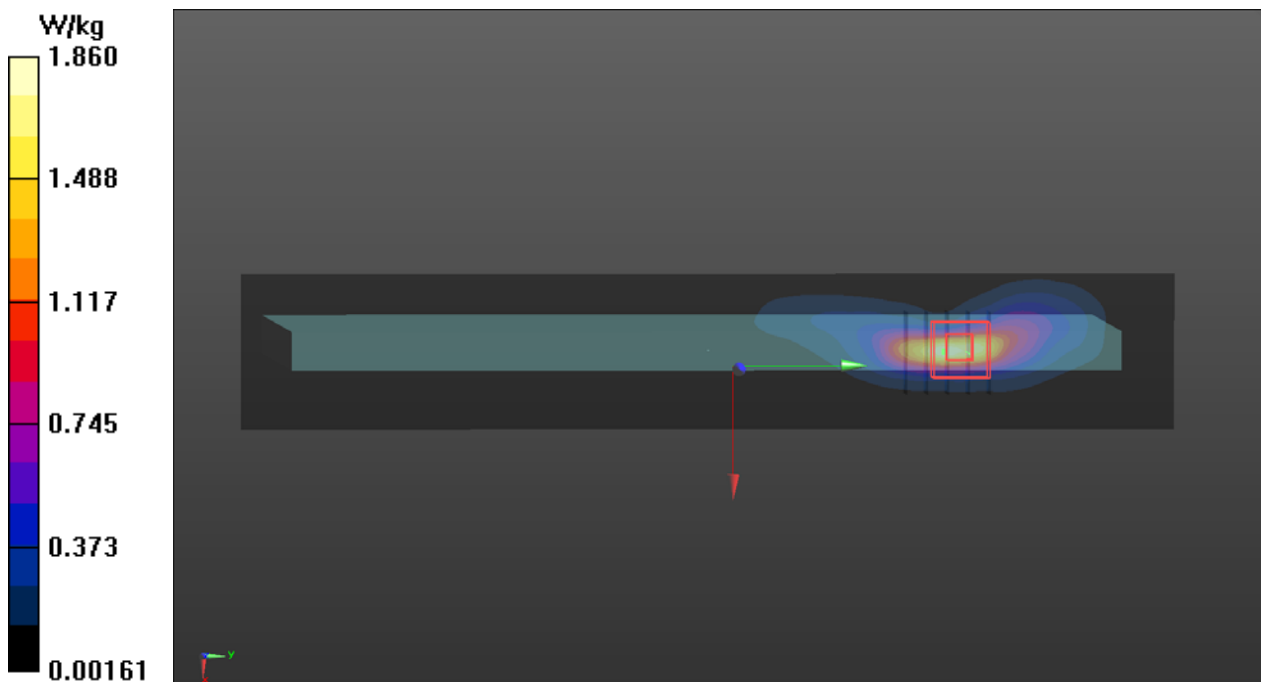

P11 LTE 25_QPSK20M_Top Side_0mm_Ch26140_1RB_OS0_Vendor WNC_P-Sensor_w

DUT: BEDW-WTW-P20080369

Communication System: UID 10169 - CAE, LTE-FDD (SC-FDMA, 1 RB, 20 MHz, QPSK);
Frequency: 1860 MHz; Duty Cycle: 1:3.74

Medium: H16T20N1_1108 Medium parameters used: $f = 1860$ MHz; $\sigma = 1.425$ S/m; $\epsilon_r = 39.697$; $\rho = 1000$ kg/m³

Ambient Temperature : 23.8 °C ; Liquid Temperature : 23.3 °C

DASY5 Configuration:

- Probe: EX3DV4 - SN7472; ConvF(8.35, 8.35, 8.35) @ 1860 MHz; Calibrated: 2020/08/24
- Sensor-Surface: 1.4mm (Mechanical Surface Detection)
- Electronics: DAE4 Sn1585; Calibrated: 2020/05/28
- Phantom: ELI Phantom_1245; Type: QDOVA002AA;
- Measurement SW: DASY52, Version 52.10 (4); SEMCAD X Version 14.6.14 (7483)

Area Scan (61x241x1): Interpolated grid: dx=1.500 mm, dy=1.500 mm

Maximum value of SAR (interpolated) = 0.687 W/kg

Zoom Scan (5x5x7)/Cube 0: Measurement grid: dx=8mm, dy=8mm, dz=5mm

Reference Value = 19.14 V/m; Power Drift = 0.06 dB

Peak SAR (extrapolated) = 0.709 W/kg

SAR(1 g) = 0.359 W/kg; SAR(10 g) = 0.189 W/kg (SAR corrected for target medium)

Smallest distance from peaks to all points 3 dB below = 8.1 mm

Ratio of SAR at M2 to SAR at M1 = 54.6%

Maximum value of SAR (measured) = 0.539 W/kg

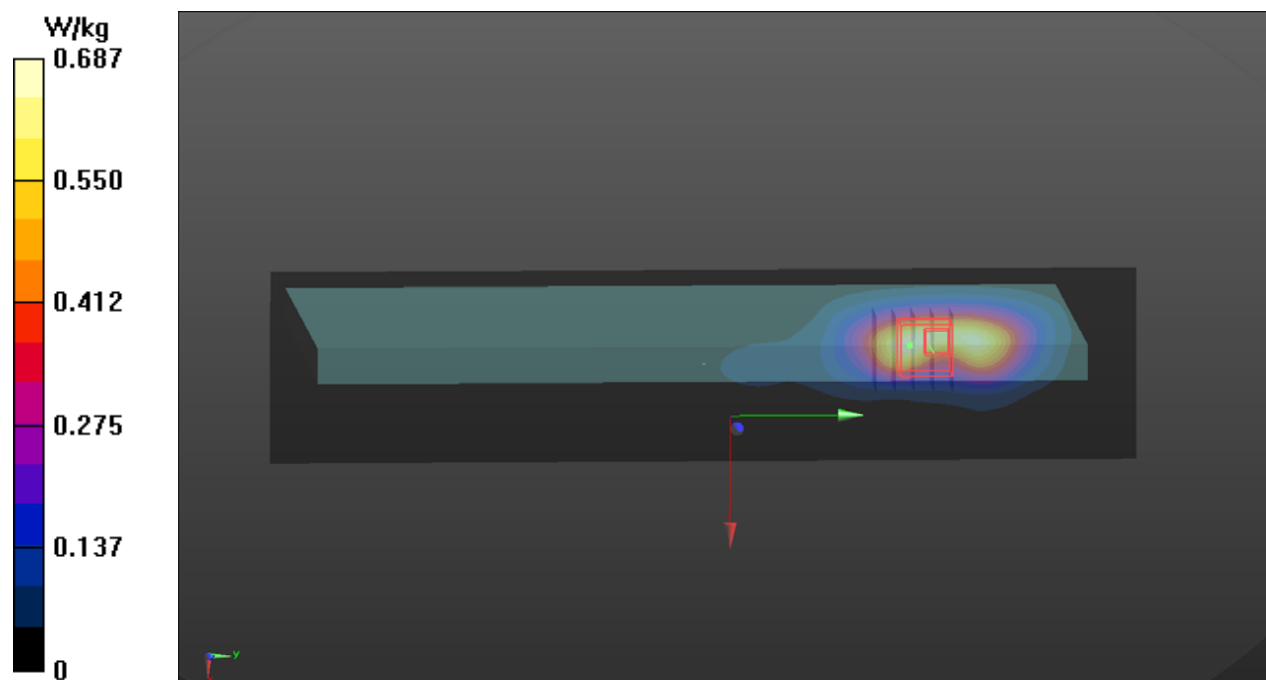

P12 LTE 26_QPSK15M_Top Side_0mm_Ch26865_1RB_OS0_Vendor WNC_P-Sensor_w

DUT: BEDW-WTW-P20080369

Communication System: UID 10181 - CAE, LTE-FDD (SC-FDMA, 1 RB, 15 MHz, QPSK);
Frequency: 831.5 MHz; Duty Cycle: 1:3.74
Medium: H07T10N1_1109 Medium parameters used (interpolated): $f = 831.5$ MHz; $\sigma = 0.916$ S/m;
 $\epsilon_r = 41.805$; $\rho = 1000$ kg/m³
Ambient Temperature : 23.8 °C ; Liquid Temperature : 23.3 °C

DASY5 Configuration:

- Probe: EX3DV4 - SN7472; ConvF(10.11, 10.11, 10.11) @ 831.5 MHz; Calibrated: 2020/08/24
- Sensor-Surface: 1.4mm (Mechanical Surface Detection)
- Electronics: DAE4 Sn1585; Calibrated: 2020/05/28
- Phantom: ELI Phantom_1245; Type: QDOVA002AA;
- Measurement SW: DASY52, Version 52.10 (4); SEMCAD X Version 14.6.14 (7483)

Area Scan (61x241x1): Interpolated grid: dx=1.500 mm, dy=1.500 mm
Maximum value of SAR (interpolated) = 1.27 W/kg

Zoom Scan (5x5x7)/Cube 0: Measurement grid: dx=8mm, dy=8mm, dz=5mm
Reference Value = 38.83 V/m; Power Drift = -0.12 dB
Peak SAR (extrapolated) = 1.72 W/kg
SAR(1 g) = 0.799 W/kg; SAR(10 g) = 0.385 W/kg (SAR corrected for target medium)
Smallest distance from peaks to all points 3 dB below = 8.1 mm
Ratio of SAR at M2 to SAR at M1 = 49.3%
Maximum value of SAR (measured) = 1.27 W/kg

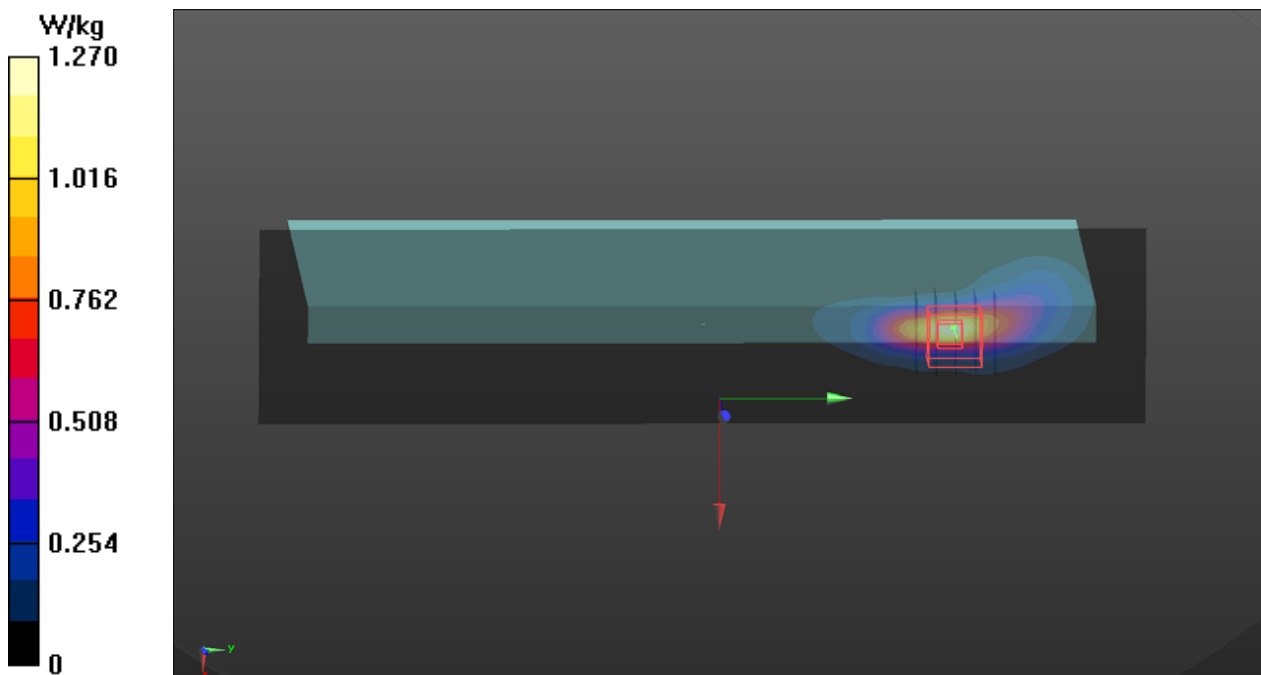

P13 LTE 30_QPSK10M_Top Side_0mm_Ch27710_1RB_OS0_Vendor WNC_P-Sensor_w

DUT: BEDW-WTW-P20080369

Communication System: UID 10175 - CAG, LTE-FDD (SC-FDMA, 1 RB, 10 MHz, QPSK);
Frequency: 2310 MHz; Duty Cycle: 1:3.74
Medium: H19T27N1_1110 Medium parameters used: $f = 2310$ MHz; $\sigma = 1.74$ S/m; $\epsilon_r = 38.831$; $\rho = 1000$ kg/m³
Ambient Temperature : 23.6 °C ; Liquid Temperature : 23.3 °C

DASY5 Configuration:

- Probe: EX3DV4 - SN3971; ConvF(8.06, 8.06, 8.06) @ 2310 MHz; Calibrated: 2020/01/27
- Sensor-Surface: 1.4mm (Mechanical Surface Detection)
- Electronics: DAE4 Sn917; Calibrated: 2019/12/17
- Phantom: ELI Phantom_1206; Type: QDOVA002AA;
- Measurement SW: DASY52, Version 52.10 (4); SEMCAD X Version 14.6.14 (7483)

Area Scan (51x301x1): Interpolated grid: $dx=1.200$ mm, $dy=1.200$ mm
Maximum value of SAR (interpolated) = 1.55 W/kg

Zoom Scan (7x7x7)/Cube 0: Measurement grid: $dx=5$ mm, $dy=5$ mm, $dz=5$ mm
Reference Value = 27.57 V/m; Power Drift = 0.11 dB
Peak SAR (extrapolated) = 2.07 W/kg
SAR(1 g) = 0.978 W/kg; SAR(10 g) = 0.474 W/kg (SAR corrected for target medium)
Smallest distance from peaks to all points 3 dB below = 8.1 mm
Ratio of SAR at M2 to SAR at M1 = 50.4%
Maximum value of SAR (measured) = 1.66 W/kg

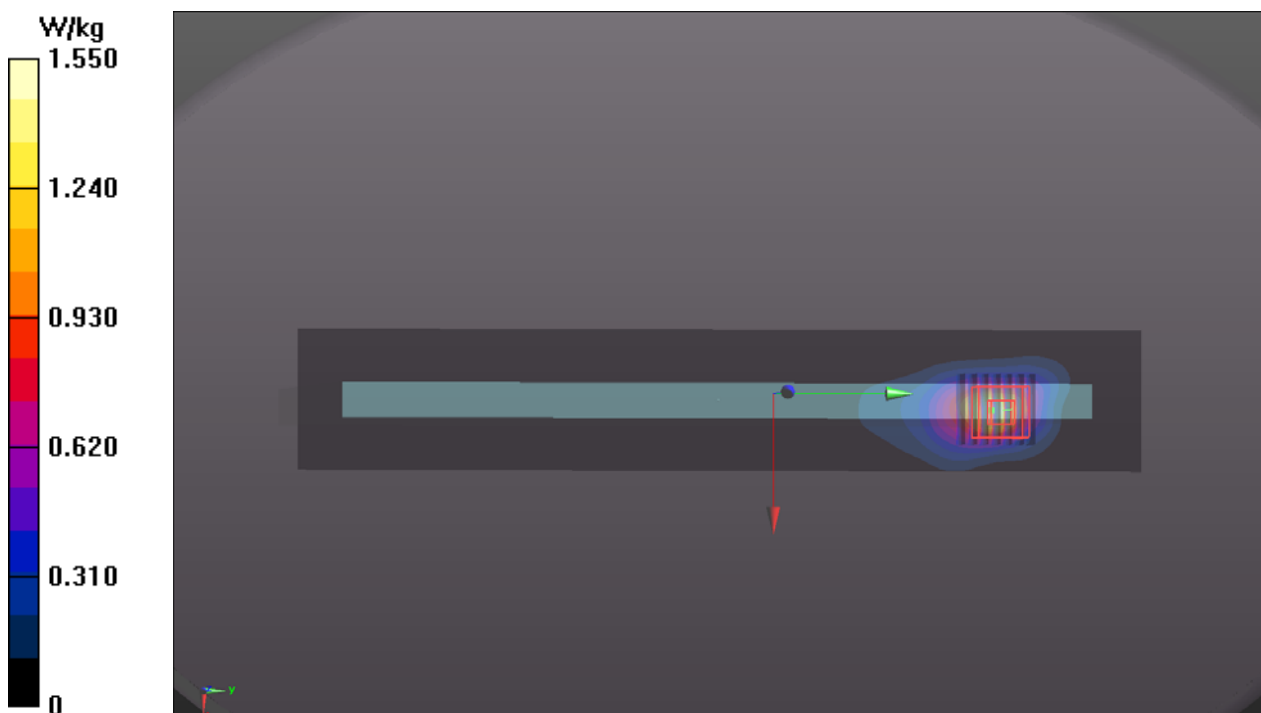

P14 LTE 38_QPSK20M_Top Side_0mm_Ch37850_1RB_OS0_Vendor Speed_P-Sensor_w

DUT: BEDW-WTW-P20080369

Communication System: UID 10172 - CAG, LTE-TDD (SC-FDMA, 1 RB, 20 MHz, QPSK);
Frequency: 2580 MHz; Duty Cycle: 1:8.33

Medium: H19T27N1_1109 Medium parameters used: $f = 2580$ MHz; $\sigma = 2.016$ S/m; $\epsilon_r = 38.854$; $\rho = 1000$ kg/m³

Ambient Temperature : 23.8 °C ; Liquid Temperature : 23.3 °C

DASY5 Configuration:

- Probe: EX3DV4 - SN7472; ConvF(7.53, 7.53, 7.53) @ 2580 MHz; Calibrated: 2020/08/24
- Sensor-Surface: 1.4mm (Mechanical Surface Detection)
- Electronics: DAE4 Sn1585; Calibrated: 2020/05/28
- Phantom: ELI Phantom_1245; Type: QDOVA002AA;
- Measurement SW: DASY52, Version 52.10 (4); SEMCAD X Version 14.6.14 (7483)

Area Scan (71x301x1): Interpolated grid: dx=1.200 mm, dy=1.200 mm

Maximum value of SAR (interpolated) = 1.51 W/kg

Zoom Scan (7x7x7)/Cube 0: Measurement grid: dx=5mm, dy=5mm, dz=5mm

Reference Value = 23.14 V/m; Power Drift = -0.11 dB

Peak SAR (extrapolated) = 2.17 W/kg

SAR(1 g) = 0.911 W/kg; SAR(10 g) = 0.426 W/kg (SAR corrected for target medium)

Smallest distance from peaks to all points 3 dB below = 7.1 mm

Ratio of SAR at M2 to SAR at M1 = 42.8%

Maximum value of SAR (measured) = 1.67 W/kg

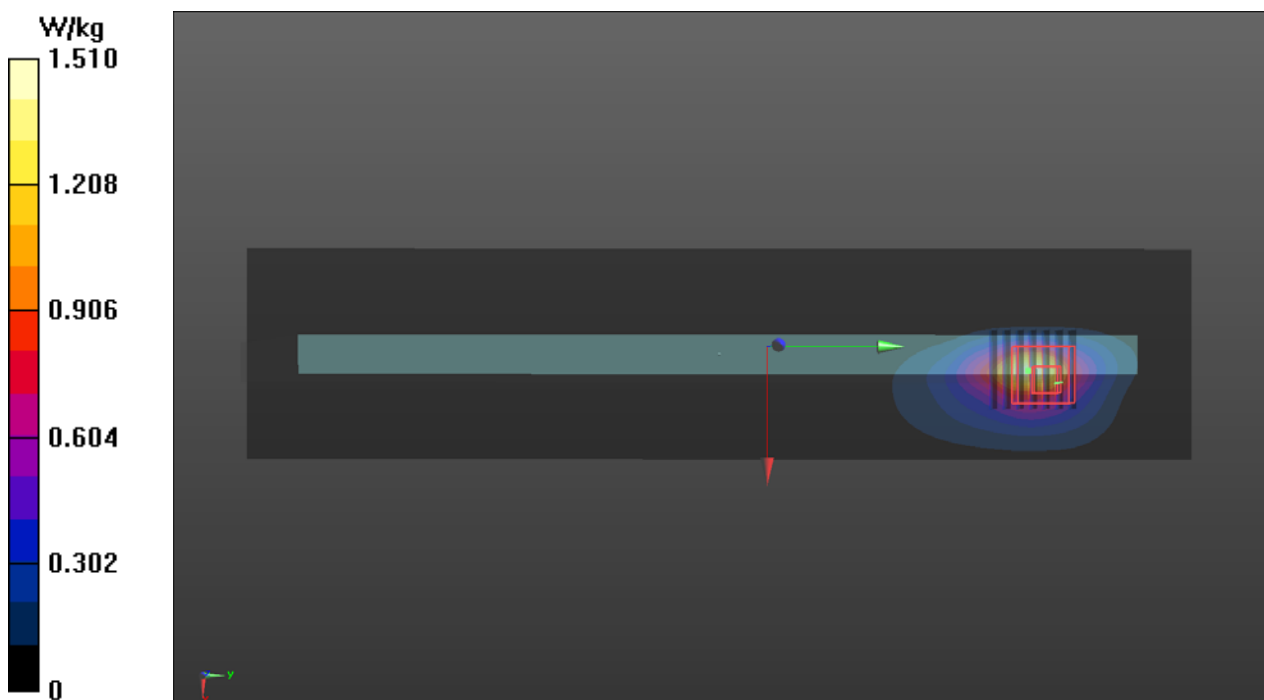

P16 LTE 41_QPSK20M_Top Side_0mm_Ch40185_1RB_OS0_Vendor WNC_P-Sensor_w

DUT: BEDW-WTW-P20080369

Communication System: UID 10172 - CAG, LTE-TDD (SC-FDMA, 1 RB, 20 MHz, QPSK);
Frequency: 2549.5 MHz; Duty Cycle: 1:8.33

Medium: H19T27N1_1109 Medium parameters used: $f = 2550$ MHz; $\sigma = 1.982$ S/m; $\epsilon_r = 38.935$; $\rho = 1000$ kg/m³

Ambient Temperature : 23.8 °C ; Liquid Temperature : 23.3 °C

DASY5 Configuration:

- Probe: EX3DV4 - SN7472; ConvF(7.53, 7.53, 7.53) @ 2549.5 MHz; Calibrated: 2020/08/24
- Sensor-Surface: 1.4mm (Mechanical Surface Detection)
- Electronics: DAE4 Sn1585; Calibrated: 2020/05/28
- Phantom: ELI Phantom_1245; Type: QDOVA002AA;
- Measurement SW: DASY52, Version 52.10 (4); SEMCAD X Version 14.6.14 (7483)

Area Scan (71x301x1): Interpolated grid: dx=1.200 mm, dy=1.200 mm

Maximum value of SAR (interpolated) = 1.39 W/kg

Zoom Scan (7x7x7)/Cube 0: Measurement grid: dx=5mm, dy=5mm, dz=5mm

Reference Value = 26.93 V/m; Power Drift = -0.02 dB

Peak SAR (extrapolated) = 2.23 W/kg

SAR(1 g) = 0.910 W/kg; SAR(10 g) = 0.426 W/kg (SAR corrected for target medium)

Smallest distance from peaks to all points 3 dB below = 7.3 mm

Ratio of SAR at M2 to SAR at M1 = 41.8%

Maximum value of SAR (measured) = 1.74 W/kg

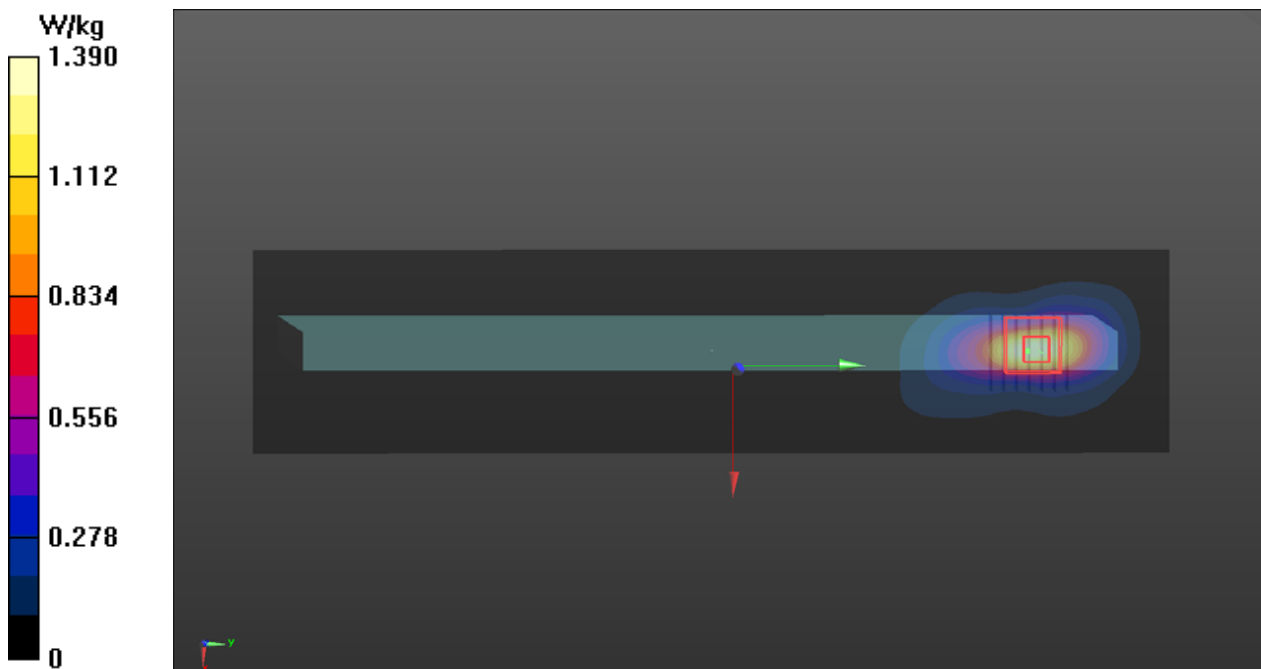

P19 LTE 66_QPSK20M_Top Side_0mm_Ch132322_1RB_OS0_Vendor WNC_P-Sensor_w

DUT: BEDW-WTW-P20080369

Communication System: UID 10169 - CAE, LTE-FDD (SC-FDMA, 1 RB, 20 MHz, QPSK);
Frequency: 1745 MHz; Duty Cycle: 1:3.74
Medium: H16T20N1_1112 Medium parameters used (interpolated): $f = 1745$ MHz; $\sigma = 1.326$ S/m;
 $\epsilon_r = 41.159$; $\rho = 1000$ kg/m³
Ambient Temperature : 23.8 °C ; Liquid Temperature : 23.2 °C

DASY5 Configuration:

- Probe: EX3DV4 - SN3971; ConvF(8.73, 8.73, 8.73) @ 1745 MHz; Calibrated: 2020/01/27
- Sensor-Surface: 1.4mm (Mechanical Surface Detection)
- Electronics: DAE4 Sn917; Calibrated: 2019/12/17
- Phantom: ELI Phantom_1206; Type: QDOVA002AA;
- Measurement SW: DASY52, Version 52.10 (4); SEMCAD X Version 14.6.14 (7483)

Area Scan (41x241x1): Interpolated grid: dx=1.500 mm, dy=1.500 mm
Maximum value of SAR (interpolated) = 2.00 W/kg

Zoom Scan (5x5x7)/Cube 0: Measurement grid: dx=8mm, dy=8mm, dz=5mm
Reference Value = 34.70 V/m; Power Drift = -0.13 dB
Peak SAR (extrapolated) = 2.73 W/kg
SAR(1 g) = 1.25 W/kg; SAR(10 g) = 0.579 W/kg (SAR corrected for target medium)
Smallest distance from peaks to all points 3 dB below = 8.1 mm
Ratio of SAR at M2 to SAR at M1 = 47%
Maximum value of SAR (measured) = 2.24 W/kg

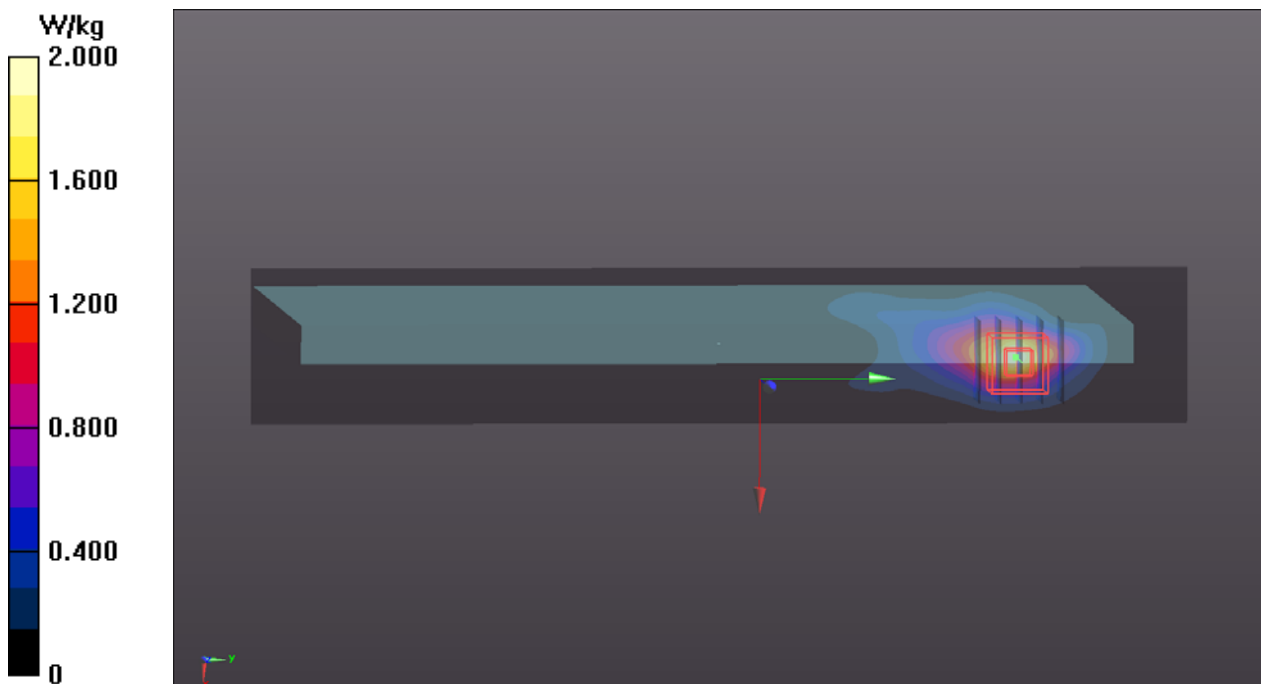

Appendix C. Calibration Certificate for Probe and Dipole

The SPEAG calibration certificates are shown as follows.



Accredited by the Swiss Accreditation Service (SAS)
The Swiss Accreditation Service is one of the signatories to the EA
Multilateral Agreement for the recognition of calibration certificates

Accreditation No.: **SCS 0108**

Client **B.V. ADT (Auden)**

Certificate No: **D750V3-1013_Aug20**

CALIBRATION CERTIFICATE

Object **D750V3 - SN:1013**

Calibration procedure(s) **QA CAL-05.v11
Calibration Procedure for SAR Validation Sources between 0.7-3 GHz**

Calibration date: **August 13, 2020**

This calibration certificate documents the traceability to national standards, which realize the physical units of measurements (SI).
The measurements and the uncertainties with confidence probability are given on the following pages and are part of the certificate.

All calibrations have been conducted in the closed laboratory facility: environment temperature (22 ± 3)°C and humidity < 70%.

Calibration Equipment used (M&TE critical for calibration)

Primary Standards	ID #	Cal Date (Certificate No.)	Scheduled Calibration
Power meter NRP	SN: 104778	01-Apr-20 (No. 217-03100/03101)	Apr-21
Power sensor NRP-Z91	SN: 103244	01-Apr-20 (No. 217-03100)	Apr-21
Power sensor NRP-Z91	SN: 103245	01-Apr-20 (No. 217-03101)	Apr-21
Reference 20 dB Attenuator	SN: BH9394 (20k)	31-Mar-20 (No. 217-03106)	Apr-21
Type-N mismatch combination	SN: 310982 / 06327	31-Mar-20 (No. 217-03104)	Apr-21
Reference Probe EX3DV4	SN: 7349	29-Jun-20 (No. EX3-7349_Jun20)	Jun-21
DAE4	SN: 601	27-Dec-19 (No. DAE4-601_Dec19)	Dec-20

Secondary Standards	ID #	Check Date (in house)	Scheduled Check
Power meter E4419B	SN: GB39512475	30-Oct-14 (in house check Feb-19)	In house check: Oct-20
Power sensor HP 8481A	SN: US37292783	07-Oct-15 (in house check Oct-18)	In house check: Oct-20
Power sensor HP 8481A	SN: MY41092317	07-Oct-15 (in house check Oct-18)	In house check: Oct-20
RF generator R&S SMT-06	SN: 100972	15-Jun-15 (in house check Oct-18)	In house check: Oct-20
Network Analyzer Agilent E8358A	SN: US41080477	31-Mar-14 (in house check Oct-19)	In house check: Oct-20

	Name	Function	Signature
Calibrated by:	Jeffrey Katzman	Laboratory Technician	
Approved by:	Katja Pokovic	Technical Manager	

Issued: August 14, 2020

This calibration certificate shall not be reproduced except in full without written approval of the laboratory.



Accredited by the Swiss Accreditation Service (SAS)

The Swiss Accreditation Service is one of the signatories to the EA Multilateral Agreement for the recognition of calibration certificates

Glossary:

TSL	tissue simulating liquid
ConvF	sensitivity in TSL / NORM x,y,z
N/A	not applicable or not measured

Calibration is Performed According to the Following Standards:

- IEEE Std 1528-2013, "IEEE Recommended Practice for Determining the Peak Spatial-Averaged Specific Absorption Rate (SAR) in the Human Head from Wireless Communications Devices: Measurement Techniques", June 2013
- IEC 62209-1, "Measurement procedure for the assessment of Specific Absorption Rate (SAR) from hand-held and body-mounted devices used next to the ear (frequency range of 300 MHz to 6 GHz)", July 2016
- IEC 62209-2, "Procedure to determine the Specific Absorption Rate (SAR) for wireless communication devices used in close proximity to the human body (frequency range of 30 MHz to 6 GHz)", March 2010
- KDB 865664, "SAR Measurement Requirements for 100 MHz to 6 GHz"

Additional Documentation:

- DASY4/5 System Handbook

Methods Applied and Interpretation of Parameters:

- Measurement Conditions:** Further details are available from the Validation Report at the end of the certificate. All figures stated in the certificate are valid at the frequency indicated.
- Antenna Parameters with TSL:** The dipole is mounted with the spacer to position its feed point exactly below the center marking of the flat phantom section, with the arms oriented parallel to the body axis.
- Feed Point Impedance and Return Loss:** These parameters are measured with the dipole positioned under the liquid filled phantom. The impedance stated is transformed from the measurement at the SMA connector to the feed point. The Return Loss ensures low reflected power. No uncertainty required.
- Electrical Delay:** One-way delay between the SMA connector and the antenna feed point. No uncertainty required.
- SAR measured:** SAR measured at the stated antenna input power.
- SAR normalized:** SAR as measured, normalized to an input power of 1 W at the antenna connector.
- SAR for nominal TSL parameters:** The measured TSL parameters are used to calculate the nominal SAR result.

The reported uncertainty of measurement is stated as the standard uncertainty of measurement multiplied by the coverage factor $k=2$, which for a normal distribution corresponds to a coverage probability of approximately 95%.

Measurement Conditions

DASY system configuration, as far as not given on page 1.

DASY Version	DASY5	V52.10.4
Extrapolation	Advanced Extrapolation	
Phantom	Modular Flat Phantom	
Distance Dipole Center - TSL	15 mm	with Spacer
Zoom Scan Resolution	dx, dy, dz = 5 mm	
Frequency	750 MHz ± 1 MHz	

Head TSL parameters

The following parameters and calculations were applied.

	Temperature	Permittivity	Conductivity
Nominal Head TSL parameters	22.0 °C	41.9	0.89 mho/m
Measured Head TSL parameters	(22.0 ± 0.2) °C	42.4 ± 6 %	0.91 mho/m ± 6 %
Head TSL temperature change during test	< 0.5 °C	----	----

SAR result with Head TSL

SAR averaged over 1 cm³ (1 g) of Head TSL	Condition	
SAR measured	250 mW input power	2.15 W/kg
SAR for nominal Head TSL parameters	normalized to 1W	8.48 W/kg ± 17.0 % (k=2)

SAR averaged over 10 cm³ (10 g) of Head TSL	condition	
SAR measured	250 mW input power	1.40 W/kg
SAR for nominal Head TSL parameters	normalized to 1W	5.53 W/kg ± 16.5 % (k=2)

Appendix (Additional assessments outside the scope of SCS 0108)

Antenna Parameters with Head TSL

Impedance, transformed to feed point	53.0 Ω - 0.8 j Ω
Return Loss	- 30.5 dB

General Antenna Parameters and Design

Electrical Delay (one direction)	1.036 ns
----------------------------------	----------

After long term use with 100W radiated power, only a slight warming of the dipole near the feedpoint can be measured.

The dipole is made of standard semirigid coaxial cable. The center conductor of the feeding line is directly connected to the second arm of the dipole. The antenna is therefore short-circuited for DC-signals. On some of the dipoles, small end caps are added to the dipole arms in order to improve matching when loaded according to the position as explained in the "Measurement Conditions" paragraph. The SAR data are not affected by this change. The overall dipole length is still according to the Standard.

No excessive force must be applied to the dipole arms, because they might bend or the soldered connections near the feedpoint may be damaged.

Additional EUT Data

Manufactured by	SPEAG
-----------------	-------

DASY5 Validation Report for Head TSL

Date: 13.08.2020

Test Laboratory: SPEAG, Zurich, Switzerland

DUT: Dipole 750 MHz; Type: D750V3; Serial: D750V3 - SN:1013

Communication System: UID 0 - CW; Frequency: 750 MHz

Medium parameters used: $f = 750$ MHz; $\sigma = 0.91$ S/m; $\epsilon_r = 42.4$; $\rho = 1000$ kg/m³

Phantom section: Flat Section

Measurement Standard: DASY5 (IEEE/IEC/ANSI C63.19-2011)

DASY52 Configuration:

- Probe: EX3DV4 - SN7349; ConvF(9.97, 9.97, 9.97) @ 750 MHz; Calibrated: 29.06.2020
- Sensor-Surface: 1.4mm (Mechanical Surface Detection)
- Electronics: DAE4 Sn601; Calibrated: 27.12.2019
- Phantom: Flat Phantom 4.9 (front); Type: QD 00L P49 AA; Serial: 1001
- DASY52 52.10.4(1527); SEMCAD X 14.6.14(7483)

Dipole Calibration for Head Tissue/Pin=250 mW, d=15mm/Zoom Scan (7x7x7)/Cube 0:

Measurement grid: dx=5mm, dy=5mm, dz=5mm

Reference Value = 59.14 V/m; Power Drift = -0.06 dB

Peak SAR (extrapolated) = 3.22 W/kg

SAR(1 g) = 2.15 W/kg; SAR(10 g) = 1.4 W/kg

Smallest distance from peaks to all points 3 dB below = 17 mm

Ratio of SAR at M2 to SAR at M1 = 66.8%

Maximum value of SAR (measured) = 2.83 W/kg

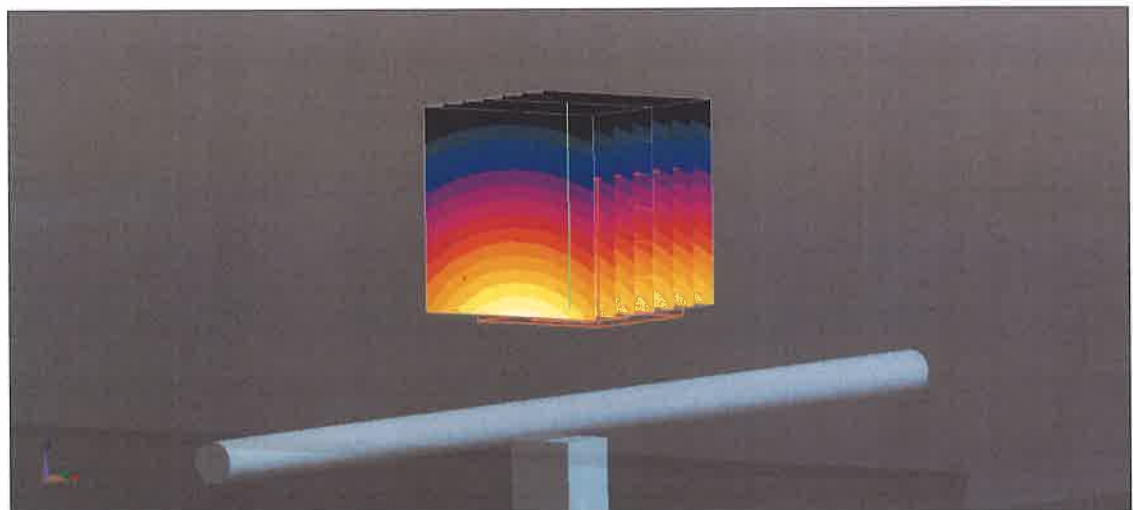
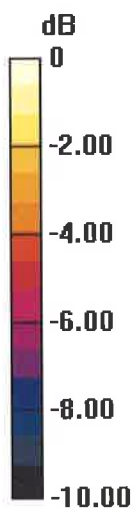

0 dB = 2.83 W/kg = 4.52 dBW/kg

Impedance Measurement Plot for Head TSL

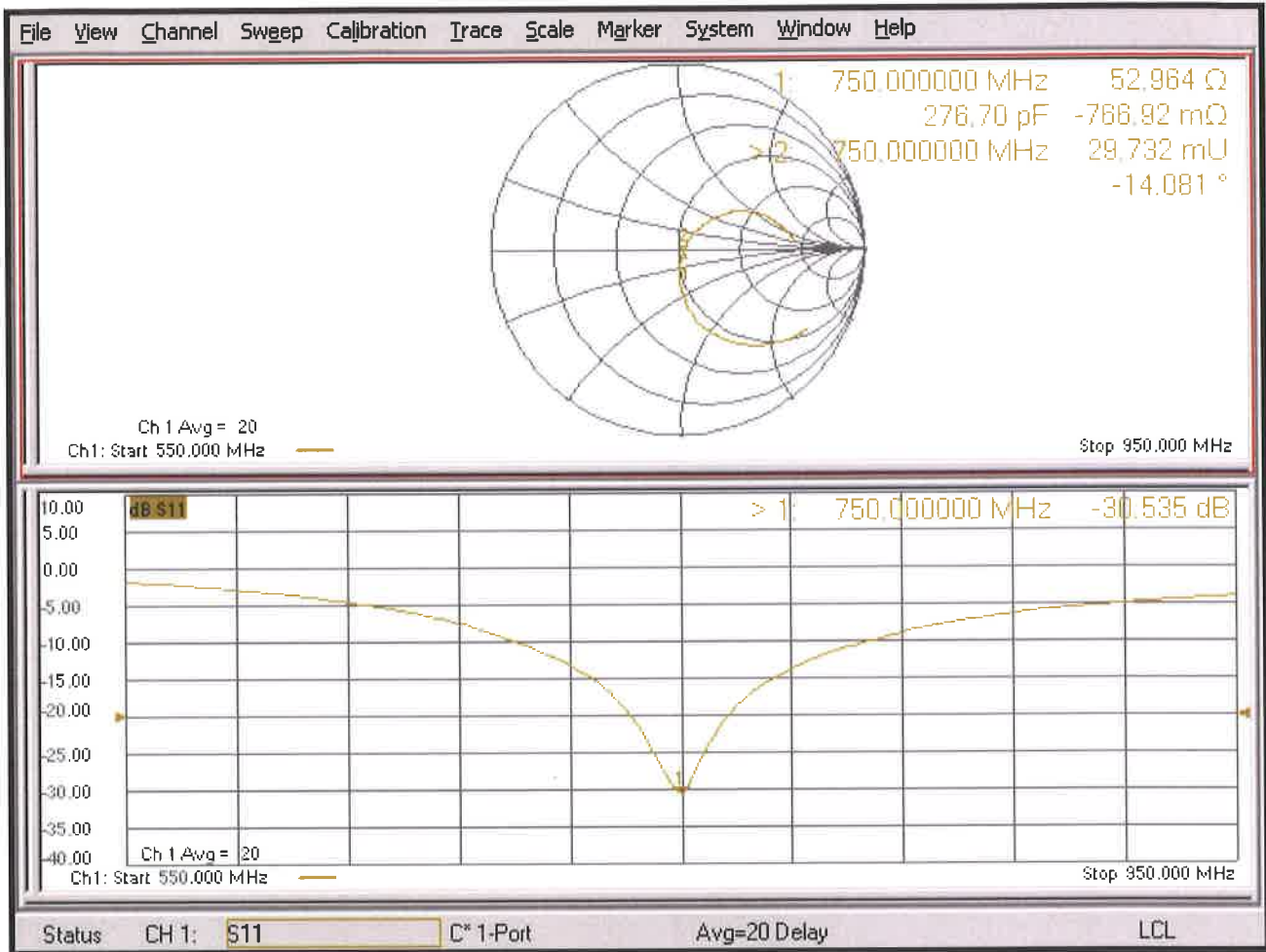



Accredited by the Swiss Accreditation Service (SAS)
The Swiss Accreditation Service is one of the signatories to the EA
Multilateral Agreement for the recognition of calibration certificates

Accreditation No.: **SCS 0108**

Client **B.V. ADT (Auden)**

Certificate No: **D835V2-4d121_Aug20**

CALIBRATION CERTIFICATE

Object **D835V2 - SN:4d121**

Calibration procedure(s) **QA CAL-05.v11
Calibration Procedure for SAR Validation Sources between 0.7-3 GHz**

Calibration date: **August 13, 2020**

This calibration certificate documents the traceability to national standards, which realize the physical units of measurements (SI).
The measurements and the uncertainties with confidence probability are given on the following pages and are part of the certificate.

All calibrations have been conducted in the closed laboratory facility: environment temperature (22 ± 3)°C and humidity < 70%.

Calibration Equipment used (M&TE critical for calibration)

Primary Standards	ID #	Cal Date (Certificate No.)	Scheduled Calibration
Power meter NRP	SN: 104778	01-Apr-20 (No. 217-03100/03101)	Apr-21
Power sensor NRP-Z91	SN: 103244	01-Apr-20 (No. 217-03100)	Apr-21
Power sensor NRP-Z91	SN: 103245	01-Apr-20 (No. 217-03101)	Apr-21
Reference 20 dB Attenuator	SN: BH9394 (20k)	31-Mar-20 (No. 217-03106)	Apr-21
Type-N mismatch combination	SN: 310982 / 06327	31-Mar-20 (No. 217-03104)	Apr-21
Reference Probe EX3DV4	SN: 7349	29-Jun-20 (No. EX3-7349_Jun20)	Jun-21
DAE4	SN: 601	27-Dec-19 (No. DAE4-601_Dec19)	Dec-20

Secondary Standards	ID #	Check Date (in house)	Scheduled Check
Power meter E4419B	SN: GB39512475	30-Oct-14 (in house check Feb-19)	In house check: Oct-20
Power sensor HP 8481A	SN: US37292783	07-Oct-15 (in house check Oct-18)	In house check: Oct-20
Power sensor HP 8481A	SN: MY41092317	07-Oct-15 (in house check Oct-18)	In house check: Oct-20
RF generator R&S SMT-06	SN: 100972	15-Jun-15 (in house check Oct-18)	In house check: Oct-20
Network Analyzer Agilent E8358A	SN: US41080477	31-Mar-14 (in house check Oct-19)	In house check: Oct-20

Calibrated by: **Jeffrey Katzman** **Jeffrey Katzman** **Laboratory Technician**

Approved by: **Katja Pokovic** **Katja Pokovic** **Technical Manager**

Signature
J. Katzman
K. Pokovic

Issued: August 14, 2020

This calibration certificate shall not be reproduced except in full without written approval of the laboratory.



Accredited by the Swiss Accreditation Service (SAS)
The Swiss Accreditation Service is one of the signatories to the EA
Multilateral Agreement for the recognition of calibration certificates

Accreditation No.: **SCS 0108**

Glossary:

TSL	tissue simulating liquid
ConvF	sensitivity in TSL / NORM x,y,z
N/A	not applicable or not measured

Calibration is Performed According to the Following Standards:

- IEEE Std 1528-2013, "IEEE Recommended Practice for Determining the Peak Spatial-Averaged Specific Absorption Rate (SAR) in the Human Head from Wireless Communications Devices: Measurement Techniques", June 2013
- IEC 62209-1, "Measurement procedure for the assessment of Specific Absorption Rate (SAR) from hand-held and body-mounted devices used next to the ear (frequency range of 300 MHz to 6 GHz)", July 2016
- IEC 62209-2, "Procedure to determine the Specific Absorption Rate (SAR) for wireless communication devices used in close proximity to the human body (frequency range of 30 MHz to 6 GHz)", March 2010
- KDB 865664, "SAR Measurement Requirements for 100 MHz to 6 GHz"

Additional Documentation:

- DASY4/5 System Handbook

Methods Applied and Interpretation of Parameters:

- Measurement Conditions:** Further details are available from the Validation Report at the end of the certificate. All figures stated in the certificate are valid at the frequency indicated.
- Antenna Parameters with TSL:** The dipole is mounted with the spacer to position its feed point exactly below the center marking of the flat phantom section, with the arms oriented parallel to the body axis.
- Feed Point Impedance and Return Loss:** These parameters are measured with the dipole positioned under the liquid filled phantom. The impedance stated is transformed from the measurement at the SMA connector to the feed point. The Return Loss ensures low reflected power. No uncertainty required.
- Electrical Delay:** One-way delay between the SMA connector and the antenna feed point. No uncertainty required.
- SAR measured:** SAR measured at the stated antenna input power.
- SAR normalized:** SAR as measured, normalized to an input power of 1 W at the antenna connector.
- SAR for nominal TSL parameters:** The measured TSL parameters are used to calculate the nominal SAR result.

The reported uncertainty of measurement is stated as the standard uncertainty of measurement multiplied by the coverage factor $k=2$, which for a normal distribution corresponds to a coverage probability of approximately 95%.

Measurement Conditions

DASY system configuration, as far as not given on page 1.

DASY Version	DASY5	V52.10.4
Extrapolation	Advanced Extrapolation	
Phantom	Modular Flat Phantom	
Distance Dipole Center - TSL	15 mm	with Spacer
Zoom Scan Resolution	dx, dy, dz = 5 mm	
Frequency	835 MHz \pm 1 MHz	

Head TSL parameters

The following parameters and calculations were applied.

	Temperature	Permittivity	Conductivity
Nominal Head TSL parameters	22.0 °C	41.5	0.90 mho/m
Measured Head TSL parameters	(22.0 \pm 0.2) °C	42.2 \pm 6 %	0.93 mho/m \pm 6 %
Head TSL temperature change during test	< 0.5 °C	----	----

SAR result with Head TSL

SAR averaged over 1 cm³ (1 g) of Head TSL	Condition	
SAR measured	250 mW input power	2.43 W/kg
SAR for nominal Head TSL parameters	normalized to 1W	9.52 W/kg \pm 17.0 % (k=2)

SAR averaged over 10 cm³ (10 g) of Head TSL	condition	
SAR measured	250 mW input power	1.58 W/kg
SAR for nominal Head TSL parameters	normalized to 1W	6.21 W/kg \pm 16.5 % (k=2)

Appendix (Additional assessments outside the scope of SCS 0108)

Antenna Parameters with Head TSL

Impedance, transformed to feed point	49.8 Ω - 3.4 j Ω
Return Loss	- 29.4 dB

General Antenna Parameters and Design

Electrical Delay (one direction)	1.394 ns
----------------------------------	----------

After long term use with 100W radiated power, only a slight warming of the dipole near the feedpoint can be measured.

The dipole is made of standard semirigid coaxial cable. The center conductor of the feeding line is directly connected to the second arm of the dipole. The antenna is therefore short-circuited for DC-signals. On some of the dipoles, small end caps are added to the dipole arms in order to improve matching when loaded according to the position as explained in the "Measurement Conditions" paragraph. The SAR data are not affected by this change. The overall dipole length is still according to the Standard.

No excessive force must be applied to the dipole arms, because they might bend or the soldered connections near the feedpoint may be damaged.

Additional EUT Data

Manufactured by	SPEAG
-----------------	-------

DASY5 Validation Report for Head TSL

Date: 13.08.2020

Test Laboratory: SPEAG, Zurich, Switzerland

DUT: Dipole 835 MHz; Type: D835V2; Serial: D835V2 - SN:4d121

Communication System: UID 0 - CW; Frequency: 835 MHz

Medium parameters used: $f = 835$ MHz; $\sigma = 0.93$ S/m; $\epsilon_r = 42.2$; $\rho = 1000$ kg/m³

Phantom section: Flat Section

Measurement Standard: DASY5 (IEEE/IEC/ANSI C63.19-2011)

DASY52 Configuration:

- Probe: EX3DV4 - SN7349; ConvF(9.69, 9.69, 9.69) @ 835 MHz; Calibrated: 29.06.2020
- Sensor-Surface: 1.4mm (Mechanical Surface Detection)
- Electronics: DAE4 Sn601; Calibrated: 27.12.2019
- Phantom: Flat Phantom 4.9 (front); Type: QD 00L P49 AA; Serial: 1001
- DASY52 52.10.4(1527); SEMCAD X 14.6.14(7483)

Dipole Calibration for Head Tissue/Pin=250 mW, d=15mm/Zoom Scan (7x7x7)/Cube 0:

Measurement grid: dx=5mm, dy=5mm, dz=5mm

Reference Value = 62.61 V/m; Power Drift = -0.05 dB

Peak SAR (extrapolated) = 3.60 W/kg

SAR(1 g) = 2.43 W/kg; SAR(10 g) = 1.58 W/kg

Smallest distance from peaks to all points 3 dB below = 17 mm

Ratio of SAR at M2 to SAR at M1 = 67.5%

Maximum value of SAR (measured) = 3.21 W/kg



0 dB = 3.21 W/kg = 5.07 dBW/kg

Impedance Measurement Plot for Head TSL

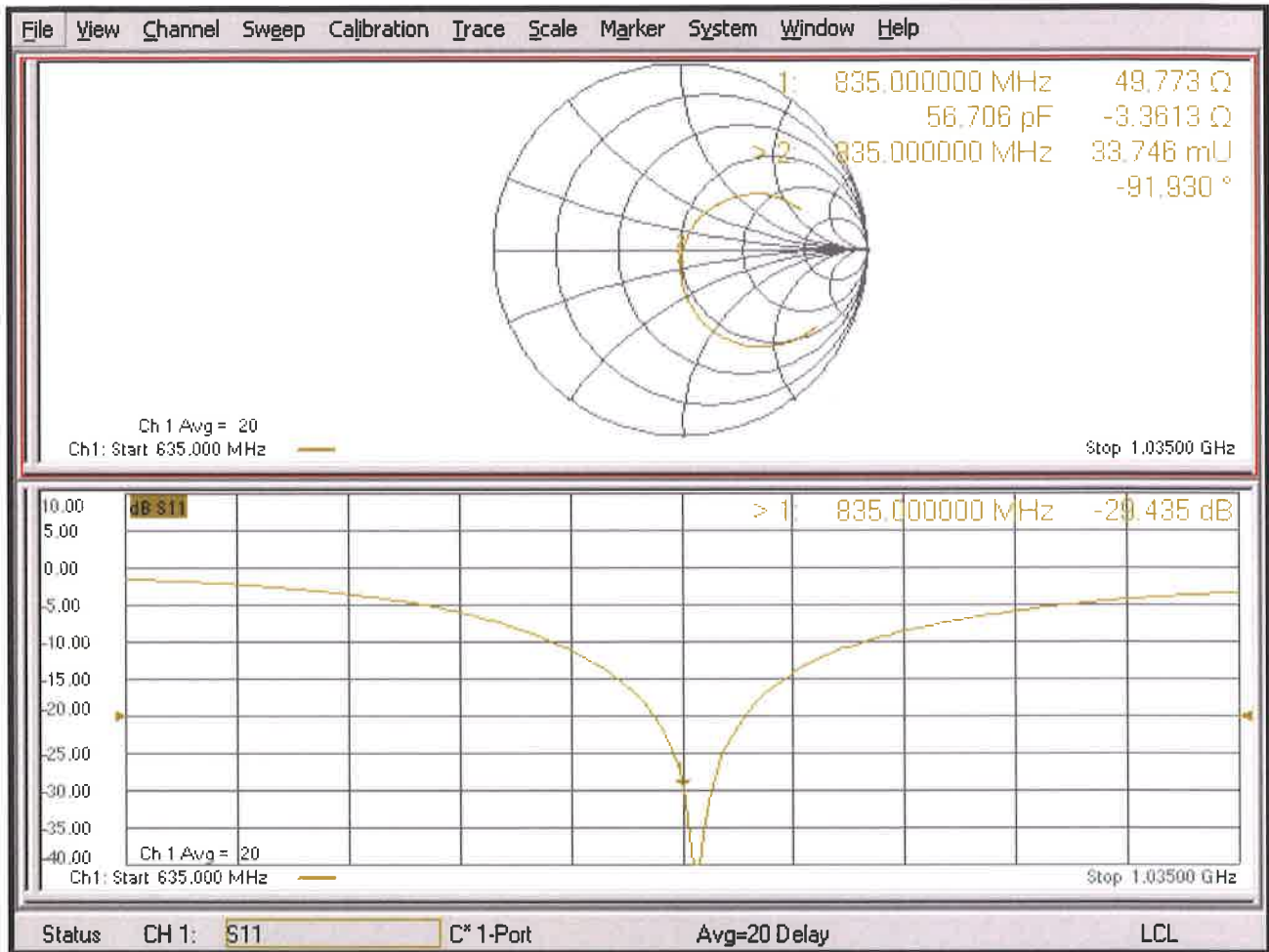



Accredited by the Swiss Accreditation Service (SAS)
The Swiss Accreditation Service is one of the signatories to the EA
Multilateral Agreement for the recognition of calibration certificates

Accreditation No.: **SCS 0108**

Client **B.V. ADT (Auden)**

Certificate No: **D1750V2-1055_Aug20**

CALIBRATION CERTIFICATE

Object **D1750V2 - SN:1055**

Calibration procedure(s) **QA CAL-05.v11
Calibration Procedure for SAR Validation Sources between 0.7-3 GHz**

Calibration date: **August 14, 2020**

This calibration certificate documents the traceability to national standards, which realize the physical units of measurements (SI).
The measurements and the uncertainties with confidence probability are given on the following pages and are part of the certificate.

All calibrations have been conducted in the closed laboratory facility: environment temperature (22 ± 3)°C and humidity < 70%.

Calibration Equipment used (M&TE critical for calibration)

Primary Standards	ID #	Cal Date (Certificate No.)	Scheduled Calibration
Power meter NRP	SN: 104778	01-Apr-20 (No. 217-03100/03101)	Apr-21
Power sensor NRP-Z91	SN: 103244	01-Apr-20 (No. 217-03100)	Apr-21
Power sensor NRP-Z91	SN: 103245	01-Apr-20 (No. 217-03101)	Apr-21
Reference 20 dB Attenuator	SN: BH9394 (20k)	31-Mar-20 (No. 217-03106)	Apr-21
Type-N mismatch combination	SN: 310982 / 06327	31-Mar-20 (No. 217-03104)	Apr-21
Reference Probe EX3DV4	SN: 7349	29-Jun-20 (No. EX3-7349_Jun20)	Jun-21
DAE4	SN: 601	27-Dec-19 (No. DAE4-601_Dec19)	Dec-20

Secondary Standards	ID #	Check Date (in house)	Scheduled Check
Power meter E4419B	SN: GB39512475	30-Oct-14 (in house check Feb-19)	In house check: Oct-20
Power sensor HP 8481A	SN: US37292783	07-Oct-15 (in house check Oct-18)	In house check: Oct-20
Power sensor HP 8481A	SN: MY41092317	07-Oct-15 (in house check Oct-18)	In house check: Oct-20
RF generator R&S SMT-06	SN: 100972	15-Jun-15 (in house check Oct-18)	In house check: Oct-20
Network Analyzer Agilent E8358A	SN: US41080477	31-Mar-14 (in house check Oct-19)	In house check: Oct-20

Calibrated by: **Claudio Leubler** **Laboratory Technician**

Signature

Approved by: **Katja Pokovic** **Technical Manager**

Issued: August 14, 2020

This calibration certificate shall not be reproduced except in full without written approval of the laboratory.



Accredited by the Swiss Accreditation Service (SAS)
The Swiss Accreditation Service is one of the signatories to the EA
Multilateral Agreement for the recognition of calibration certificates

Accreditation No.: **SCS 0108**

Glossary:

TSL	tissue simulating liquid
ConvF	sensitivity in TSL / NORM x,y,z
N/A	not applicable or not measured

Calibration is Performed According to the Following Standards:

- IEEE Std 1528-2013, "IEEE Recommended Practice for Determining the Peak Spatial-Averaged Specific Absorption Rate (SAR) in the Human Head from Wireless Communications Devices: Measurement Techniques", June 2013
- IEC 62209-1, "Measurement procedure for the assessment of Specific Absorption Rate (SAR) from hand-held and body-mounted devices used next to the ear (frequency range of 300 MHz to 6 GHz)", July 2016
- IEC 62209-2, "Procedure to determine the Specific Absorption Rate (SAR) for wireless communication devices used in close proximity to the human body (frequency range of 30 MHz to 6 GHz)", March 2010
- KDB 865664, "SAR Measurement Requirements for 100 MHz to 6 GHz"

Additional Documentation:

- DASY4/5 System Handbook

Methods Applied and Interpretation of Parameters:

- Measurement Conditions:** Further details are available from the Validation Report at the end of the certificate. All figures stated in the certificate are valid at the frequency indicated.
- Antenna Parameters with TSL:** The dipole is mounted with the spacer to position its feed point exactly below the center marking of the flat phantom section, with the arms oriented parallel to the body axis.
- Feed Point Impedance and Return Loss:** These parameters are measured with the dipole positioned under the liquid filled phantom. The impedance stated is transformed from the measurement at the SMA connector to the feed point. The Return Loss ensures low reflected power. No uncertainty required.
- Electrical Delay:** One-way delay between the SMA connector and the antenna feed point. No uncertainty required.
- SAR measured:** SAR measured at the stated antenna input power.
- SAR normalized:** SAR as measured, normalized to an input power of 1 W at the antenna connector.
- SAR for nominal TSL parameters:** The measured TSL parameters are used to calculate the nominal SAR result.

The reported uncertainty of measurement is stated as the standard uncertainty of measurement multiplied by the coverage factor $k=2$, which for a normal distribution corresponds to a coverage probability of approximately 95%.

Measurement Conditions

DASY system configuration, as far as not given on page 1.

DASY Version	DASY5	V52.10.4
Extrapolation	Advanced Extrapolation	
Phantom	Modular Flat Phantom	
Distance Dipole Center - TSL	10 mm	with Spacer
Zoom Scan Resolution	dx, dy, dz = 5 mm	
Frequency	1750 MHz \pm 1 MHz	

Head TSL parameters

The following parameters and calculations were applied.

	Temperature	Permittivity	Conductivity
Nominal Head TSL parameters	22.0 °C	40.1	1.37 mho/m
Measured Head TSL parameters	(22.0 \pm 0.2) °C	40.4 \pm 6 %	1.35 mho/m \pm 6 %
Head TSL temperature change during test	< 0.5 °C	----	----

SAR result with Head TSL

SAR averaged over 1 cm ³ (1 g) of Head TSL	Condition	
SAR measured	250 mW input power	8.89 W/kg
SAR for nominal Head TSL parameters	normalized to 1W	36.0 W/kg \pm 17.0 % (k=2)

SAR averaged over 10 cm ³ (10 g) of Head TSL	condition	
SAR measured	250 mW input power	4.69 W/kg
SAR for nominal Head TSL parameters	normalized to 1W	18.9 W/kg \pm 16.5 % (k=2)

Appendix (Additional assessments outside the scope of SCS 0108)

Antenna Parameters with Head TSL

Impedance, transformed to feed point	50.3 Ω + 0.8 j Ω
Return Loss	- 41.5 dB

General Antenna Parameters and Design

Electrical Delay (one direction)	1.223 ns
----------------------------------	----------

After long term use with 100W radiated power, only a slight warming of the dipole near the feedpoint can be measured.

The dipole is made of standard semirigid coaxial cable. The center conductor of the feeding line is directly connected to the second arm of the dipole. The antenna is therefore short-circuited for DC-signals. On some of the dipoles, small end caps are added to the dipole arms in order to improve matching when loaded according to the position as explained in the "Measurement Conditions" paragraph. The SAR data are not affected by this change. The overall dipole length is still according to the Standard.

No excessive force must be applied to the dipole arms, because they might bend or the soldered connections near the feedpoint may be damaged.

Additional EUT Data

Manufactured by	SPEAG
-----------------	-------

DASY5 Validation Report for Head TSL

Date: 14.08.2020

Test Laboratory: SPEAG, Zurich, Switzerland

DUT: Dipole 1750 MHz; Type: D1750V2; Serial: D1750V2 - SN:1055

Communication System: UID 0 - CW; Frequency: 1750 MHz

Medium parameters used: $f = 1750$ MHz; $\sigma = 1.35$ S/m; $\epsilon_r = 40.4$; $\rho = 1000$ kg/m³

Phantom section: Flat Section

Measurement Standard: DASY5 (IEEE/IEC/ANSI C63.19-2011)

DASY52 Configuration:

- Probe: EX3DV4 - SN7349; ConvF(8.58, 8.58, 8.58) @ 1750 MHz; Calibrated: 29.06.2020
- Sensor-Surface: 1.4mm (Mechanical Surface Detection)
- Electronics: DAE4 Sn601; Calibrated: 27.12.2019
- Phantom: Flat Phantom 5.0 (front); Type: QD 000 P50 AA; Serial: 1001
- DASY52 52.10.4(1527); SEMCAD X 14.6.14(7483)

Dipole Calibration for Head Tissue/Pin=250 mW, d=10mm/Zoom Scan (7x7x7)/Cube 0:

Measurement grid: dx=5mm, dy=5mm, dz=5mm

Reference Value = 105.6 V/m; Power Drift = -0.03 dB

Peak SAR (extrapolated) = 16.6 W/kg

SAR(1 g) = 8.89 W/kg; SAR(10 g) = 4.69 W/kg

Smallest distance from peaks to all points 3 dB below = 10 mm

Ratio of SAR at M2 to SAR at M1 = 54%

Maximum value of SAR (measured) = 13.9 W/kg

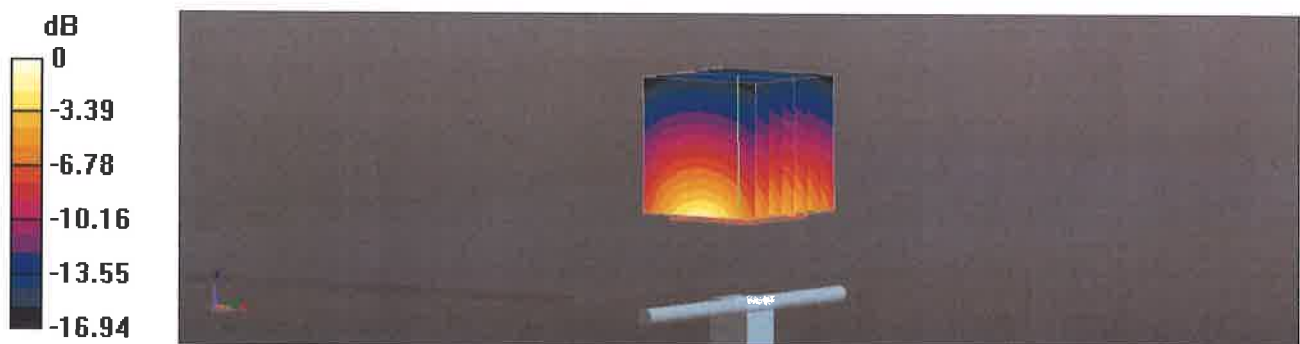

0 dB = 13.9 W/kg = 11.43 dBW/kg

Impedance Measurement Plot for Head TSL

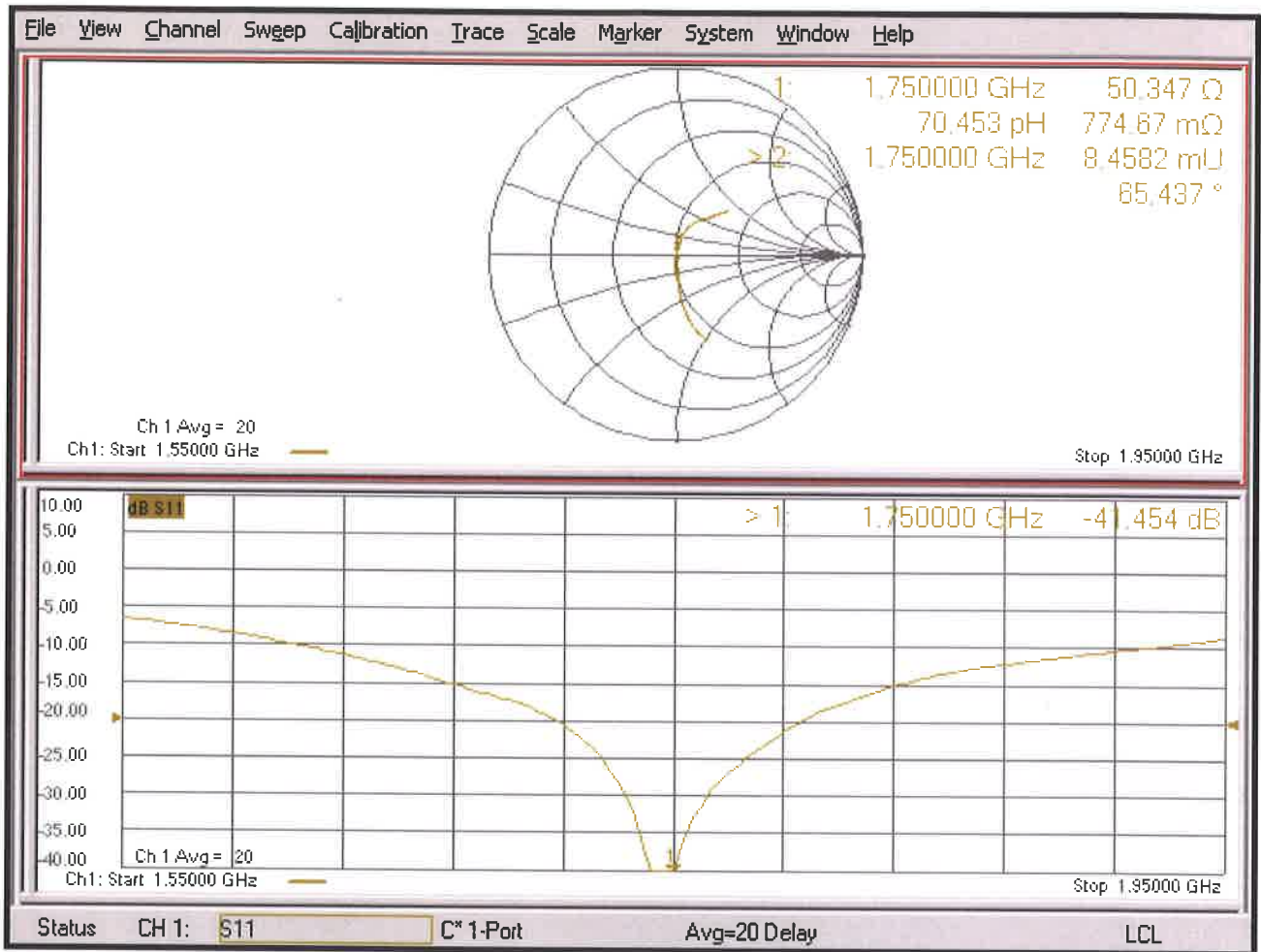



Accredited by the Swiss Accreditation Service (SAS)
The Swiss Accreditation Service is one of the signatories to the EA
Multilateral Agreement for the recognition of calibration certificates

Accreditation No.: **SCS 0108**

Client **B.V. ADT (Auden)**

Certificate No: **D1900V2-5d036_Jan20**

CALIBRATION CERTIFICATE

Object **D1900V2 - SN:5d036**

Calibration procedure(s) **QA CAL-05.v11
Calibration Procedure for SAR Validation Sources between 0.7-3 GHz**

Calibration date: **January 21, 2020**

This calibration certificate documents the traceability to national standards, which realize the physical units of measurements (SI).
The measurements and the uncertainties with confidence probability are given on the following pages and are part of the certificate.

All calibrations have been conducted in the closed laboratory facility: environment temperature (22 ± 3)°C and humidity < 70%.

Calibration Equipment used (M&TE critical for calibration)

Primary Standards	ID #	Cal Date (Certificate No.)	Scheduled Calibration
Power meter NRP	SN: 104778	03-Apr-19 (No. 217-02892/02893)	Apr-20
Power sensor NRP-Z91	SN: 103244	03-Apr-19 (No. 217-02892)	Apr-20
Power sensor NRP-Z91	SN: 103245	03-Apr-19 (No. 217-02893)	Apr-20
Reference 20 dB Attenuator	SN: 5058 (20k)	04-Apr-19 (No. 217-02894)	Apr-20
Type-N mismatch combination	SN: 5047.2 / 06327	04-Apr-19 (No. 217-02895)	Apr-20
Reference Probe EX3DV4	SN: 7349	31-Dec-19 (No. EX3-7349_Dec19)	Dec-20
DAE4	SN: 601	27-Dec-19 (No. DAE4-601_Dec19)	Dec-20

Secondary Standards	ID #	Check Date (in house)	Scheduled Check
Power meter E4419B	SN: GB39512475	30-Oct-14 (in house check Feb-19)	In house check: Oct-20
Power sensor HP 8481A	SN: US37292783	07-Oct-15 (in house check Oct-18)	In house check: Oct-20
Power sensor HP 8481A	SN: MY41092317	07-Oct-15 (in house check Oct-18)	In house check: Oct-20
RF generator R&S SMT-06	SN: 100972	15-Jun-15 (in house check Oct-18)	In house check: Oct-20
Network Analyzer Agilent E8358A	SN: US41080477	31-Mar-14 (in house check Oct-19)	In house check: Oct-20

Calibrated by: **Claudio Leubler** **Laboratory Technician**

Signature

Approved by: **Katja Pokovic** **Technical Manager**

Issued: January 22, 2020

This calibration certificate shall not be reproduced except in full without written approval of the laboratory.



Accredited by the Swiss Accreditation Service (SAS)

The Swiss Accreditation Service is one of the signatories to the EA Multilateral Agreement for the recognition of calibration certificates

Glossary:

TSL	tissue simulating liquid
ConvF	sensitivity in TSL / NORM x,y,z
N/A	not applicable or not measured

Calibration is Performed According to the Following Standards:

- IEEE Std 1528-2013, "IEEE Recommended Practice for Determining the Peak Spatial-Averaged Specific Absorption Rate (SAR) in the Human Head from Wireless Communications Devices: Measurement Techniques", June 2013
- IEC 62209-1, "Measurement procedure for the assessment of Specific Absorption Rate (SAR) from hand-held and body-mounted devices used next to the ear (frequency range of 300 MHz to 6 GHz)", July 2016
- IEC 62209-2, "Procedure to determine the Specific Absorption Rate (SAR) for wireless communication devices used in close proximity to the human body (frequency range of 30 MHz to 6 GHz)", March 2010
- KDB 865664, "SAR Measurement Requirements for 100 MHz to 6 GHz"

Additional Documentation:

- DASY4/5 System Handbook

Methods Applied and Interpretation of Parameters:

- Measurement Conditions:** Further details are available from the Validation Report at the end of the certificate. All figures stated in the certificate are valid at the frequency indicated.
- Antenna Parameters with TSL:** The dipole is mounted with the spacer to position its feed point exactly below the center marking of the flat phantom section, with the arms oriented parallel to the body axis.
- Feed Point Impedance and Return Loss:** These parameters are measured with the dipole positioned under the liquid filled phantom. The impedance stated is transformed from the measurement at the SMA connector to the feed point. The Return Loss ensures low reflected power. No uncertainty required.
- Electrical Delay:** One-way delay between the SMA connector and the antenna feed point. No uncertainty required.
- SAR measured:** SAR measured at the stated antenna input power.
- SAR normalized:** SAR as measured, normalized to an input power of 1 W at the antenna connector.
- SAR for nominal TSL parameters:** The measured TSL parameters are used to calculate the nominal SAR result.

The reported uncertainty of measurement is stated as the standard uncertainty of measurement multiplied by the coverage factor $k=2$, which for a normal distribution corresponds to a coverage probability of approximately 95%.

Measurement Conditions

DASY system configuration, as far as not given on page 1.

DASY Version	DASY5	V52.10.3
Extrapolation	Advanced Extrapolation	
Phantom	Modular Flat Phantom	
Distance Dipole Center - TSL	10 mm	with Spacer
Zoom Scan Resolution	dx, dy, dz = 5 mm	
Frequency	1900 MHz ± 1 MHz	

Head TSL parameters

The following parameters and calculations were applied.

	Temperature	Permittivity	Conductivity
Nominal Head TSL parameters	22.0 °C	40.0	1.40 mho/m
Measured Head TSL parameters	(22.0 ± 0.2) °C	41.4 ± 6 %	1.39 mho/m ± 6 %
Head TSL temperature change during test	< 0.5 °C	----	----

SAR result with Head TSL

SAR averaged over 1 cm³ (1 g) of Head TSL	Condition	
SAR measured	250 mW input power	9.95 W/kg
SAR for nominal Head TSL parameters	normalized to 1W	40.3 W/kg ± 17.0 % (k=2)

SAR averaged over 10 cm³ (10 g) of Head TSL	condition	
SAR measured	250 mW input power	5.18 W/kg
SAR for nominal Head TSL parameters	normalized to 1W	20.9 W/kg ± 16.5 % (k=2)

Appendix (Additional assessments outside the scope of SCS 0108)

Antenna Parameters with Head TSL

Impedance, transformed to feed point	50.8 Ω + 5.4 j Ω
Return Loss	- 25.3 dB

General Antenna Parameters and Design

Electrical Delay (one direction)	1.195 ns
----------------------------------	----------

After long term use with 100W radiated power, only a slight warming of the dipole near the feedpoint can be measured.

The dipole is made of standard semirigid coaxial cable. The center conductor of the feeding line is directly connected to the second arm of the dipole. The antenna is therefore short-circuited for DC-signals. On some of the dipoles, small end caps are added to the dipole arms in order to improve matching when loaded according to the position as explained in the "Measurement Conditions" paragraph. The SAR data are not affected by this change. The overall dipole length is still according to the Standard.

No excessive force must be applied to the dipole arms, because they might bend or the soldered connections near the feedpoint may be damaged.

Additional EUT Data

Manufactured by	SPEAG
-----------------	-------

DASY5 Validation Report for Head TSL

Date: 21.01.2020

Test Laboratory: SPEAG, Zurich, Switzerland

DUT: Dipole 1900 MHz; Type: D1900V2; Serial: D1900V2 - SN:5d036

Communication System: UID 0 - CW; Frequency: 1900 MHz

Medium parameters used: $f = 1900$ MHz; $\sigma = 1.39$ S/m; $\epsilon_r = 41.4$; $\rho = 1000$ kg/m³

Phantom section: Flat Section

Measurement Standard: DASY5 (IEEE/IEC/ANSI C63.19-2011)

DASY52 Configuration:

- Probe: EX3DV4 - SN7349; ConvF(8.6, 8.6, 8.6) @ 1900 MHz; Calibrated: 31.12.2019
- Sensor-Surface: 1.4mm (Mechanical Surface Detection)
- Electronics: DAE4 Sn601; Calibrated: 27.12.2019
- Phantom: Flat Phantom 5.0 (front); Type: QD 000 P50 AA; Serial: 1001
- DASY52 52.10.3(1513); SEMCAD X 14.6.13(7474)

Dipole Calibration for Head Tissue/Pin=250 mW, d=10mm/Zoom Scan (7x7x7)/Cube 0:

Measurement grid: dx=5mm, dy=5mm, dz=5mm

Reference Value = 109.0 V/m; Power Drift = 0.02 dB

Peak SAR (extrapolated) = 18.6 W/kg

SAR(1 g) = 9.95 W/kg; SAR(10 g) = 5.18 W/kg

Smallest distance from peaks to all points 3 dB below = 9.8 mm

Ratio of SAR at M2 to SAR at M1 = 54.4%

Maximum value of SAR (measured) = 15.5 W/kg

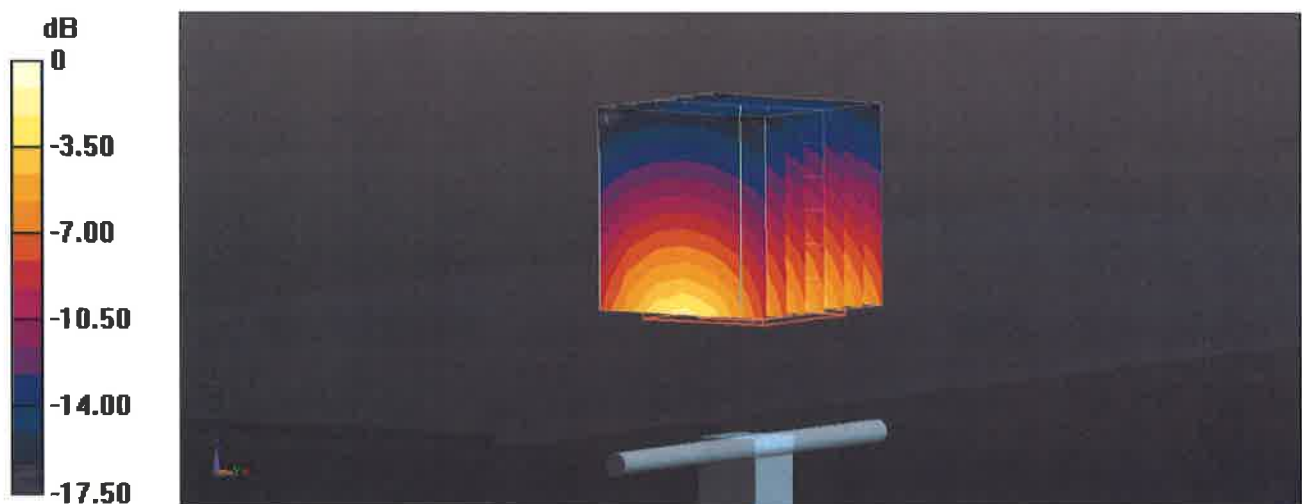

0 dB = 15.5 W/kg = 11.90 dBW/kg

Impedance Measurement Plot for Head TSL

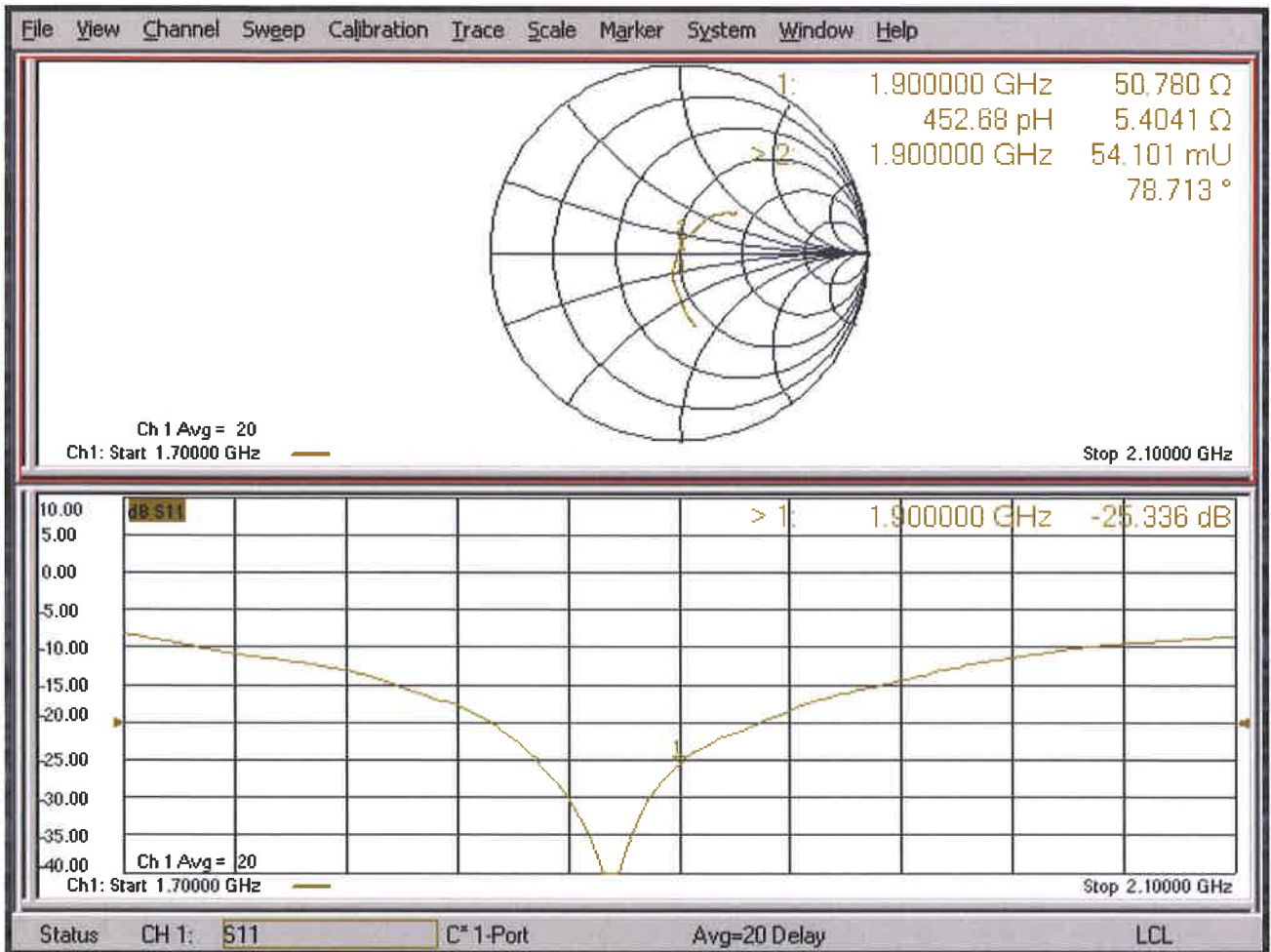



Accredited by the Swiss Accreditation Service (SAS)
The Swiss Accreditation Service is one of the signatories to the EA
Multilateral Agreement for the recognition of calibration certificates

Accreditation No.: **SCS 0108**

Client **B.V. ADT (Auden)**

Certificate No: **D2300V2-1004_Jan20**

CALIBRATION CERTIFICATE

Object **D2300V2 - SN:1004**

Calibration procedure(s) **QA CAL-05.v11
Calibration Procedure for SAR Validation Sources between 0.7-3 GHz**

Calibration date: **January 21, 2020**

This calibration certificate documents the traceability to national standards, which realize the physical units of measurements (SI).
The measurements and the uncertainties with confidence probability are given on the following pages and are part of the certificate.

All calibrations have been conducted in the closed laboratory facility: environment temperature (22 ± 3)°C and humidity < 70%.

Calibration Equipment used (M&TE critical for calibration)

Primary Standards	ID #	Cal Date (Certificate No.)	Scheduled Calibration
Power meter NRP	SN: 104778	03-Apr-19 (No. 217-02892/02893)	Apr-20
Power sensor NRP-Z91	SN: 103244	03-Apr-19 (No. 217-02892)	Apr-20
Power sensor NRP-Z91	SN: 103245	03-Apr-19 (No. 217-02893)	Apr-20
Reference 20 dB Attenuator	SN: 5058 (20k)	04-Apr-19 (No. 217-02894)	Apr-20
Type-N mismatch combination	SN: 5047.2 / 06327	04-Apr-19 (No. 217-02895)	Apr-20
Reference Probe EX3DV4	SN: 7349	31-Dec-19 (No. EX3-7349_Dec19)	Dec-20
DAE4	SN: 601	27-Dec-19 (No. DAE4-601_Dec19)	Dec-20

Secondary Standards	ID #	Check Date (in house)	Scheduled Check
Power meter E4419B	SN: GB39512475	30-Oct-14 (in house check Feb-19)	In house check: Oct-20
Power sensor HP 8481A	SN: US37292783	07-Oct-15 (in house check Oct-18)	In house check: Oct-20
Power sensor HP 8481A	SN: MY41092317	07-Oct-15 (in house check Oct-18)	In house check: Oct-20
RF generator R&S SMT-06	SN: 100972	15-Jun-15 (in house check Oct-18)	In house check: Oct-20
Network Analyzer Agilent E8358A	SN: US41080477	31-Mar-14 (in house check Oct-19)	In house check: Oct-20

Calibrated by: **Claudio Leubler** Laboratory Technician

Signature

Approved by: **Katja Pokovic** Technical Manager

Issued: January 22, 2020

This calibration certificate shall not be reproduced except in full without written approval of the laboratory.