

FCC Test Report (PART 24)

Report No.: RF170428E06-1

FCC ID: MCLT77W676

Test Model: T77W676

Received Date: Apr. 28, 2017

Test Date: June 12 to July 12, 2017

Issued Date: July 27, 2017

Applicant: HON HAI PRECISION IND. CO., LTD.

Address: 5F-1,5 Hsin-An Road Hsinchu, Science-Based Industrial Park Taiwan,
R.O.C.

Issued By: Bureau Veritas Consumer Products Services (H.K.) Ltd., Taoyuan Branch
Hsin Chu Laboratory

Lab Address: E-2, No.1, Li Hsin 1st Road, Hsinchu Science Park, Hsinchu City 300,
Taiwan R.O.C.

Test Lab (A): Bureau Veritas Consumer Products Services (H.K.) Ltd., Taoyuan Branch
Hsin Chu Laboratory

Test Location: E-2, No.1, Li Hsin 1st Road, Hsinchu Science Park, Hsinchu City 300,
Taiwan R.O.C.

Test Lab (B): Bureau Veritas Consumer Products Services (H.K.) Ltd., Taoyuan Branch
Lin Kou Laboratories

Test Location: No.19, Hwa Ya 2nd Rd., Wen Hwa Vil., Kwei Shan Dist., Taoyuan City
33383, TAIWAN (R.O.C.)



This report is for your exclusive use. Any copying or replication of this report to or for any other person or entity, or use of our name or trademark, is permitted only with our prior written permission. This report sets forth our findings solely with respect to the test samples identified herein. The results set forth in this report are not indicative or representative of the quality or characteristics of the lot from which a test sample was taken or any similar or identical product unless specifically and expressly noted. Our report includes all of the tests requested by you and the results thereof based upon the information that you provided to us. You have 60 days from date of issuance of this report to notify us of any material error or omission caused by our negligence, provided, however, that such notice shall be in writing and shall specifically address the issue you wish to raise. A failure to raise such issue within the prescribed time shall constitute your unqualified acceptance of the completeness of this report, the tests conducted and the correctness of the report contents. Unless specific mention, the uncertainty of measurement has been explicitly taken into account to declare the compliance or non-compliance to the specification. The report must not be used by the client to claim product certification, approval, or endorsement by TAF or any government agencies. The report must not be used by the client to claim product certification, approval, or endorsement by TAF or any government agencies. This report contains all test data (Except Effective radiated power and Radiated Spurious Emissions) that was produced under subcontract by Bureau Veritas Consumer Products Services (H.K.) Ltd., Taoyuan Branch Lin Kou Laboratories.

Table of Contents

Release Control Record	3
1 Certificate of Conformity	4
2 Summary of Test Results	5
2.1 Measurement Uncertainty	5
2.2 Test Site and Instruments	6
3 General Information	9
3.1 General Description of EUT	9
3.2 Configuration of System under Test	14
3.2.1 Description Of Support Units	15
3.3 Test Mode Applicability and Tested Channel Detail	16
3.4 EUT Operating Conditions	20
3.5 General Description of Applied Standards	21
4 Test Types and Results	22
4.1 Output Power Measurement	22
4.1.1 Limits of Output Power Measurement	22
4.1.2 Test Procedures	22
4.1.3 Test Setup	23
4.1.4 Test Results	24
4.2 Frequency Stability Measurement	34
4.2.1 Limits of Frequency Stability Measurement	34
4.2.2 Test Procedure	34
4.2.3 Test Setup	34
4.2.4 Test Results (Subcontract Item)	35
4.3 Occupied Bandwidth Measurement	37
4.3.1 Test Procedure	37
4.3.2 Test Setup	37
4.3.3 Test Result (-26dB Bandwidth, Subcontract Item)	38
4.3.4 Test Result (Occupied Bandwidth, Subcontract Item)	43
4.4 Band Edge Measurement	48
4.4.1 Limits of Band Edge Measurement	48
4.4.2 Test Setup	48
4.4.3 Test Procedures	48
4.4.4 Test Results (Subcontract Item)	49
4.5 Peak to Average Ratio	62
4.5.1 Limits of Peak to Average Ratio Measurement	62
4.5.2 Test Setup	62
4.5.3 Test Procedures	62
4.5.4 Test Results (Subcontract Item)	63
4.6 Conducted Spurious Emissions	68
4.6.1 Limits of Conducted Spurious Emissions Measurement	68
4.6.2 Test Setup	68
4.6.3 Test Procedure	68
4.6.4 Test Results (Subcontract Item)	69
4.7 Radiated Emission Measurement	72
4.7.1 Limits of Radiated Emission Measurement	72
4.7.2 Test Procedure	72
4.7.3 Deviation from Test Standard	72
4.7.4 Test Setup	73
4.7.5 Test Results	74
5 Pictures of Test Arrangements	99
Appendix – Information on the Testing Laboratories	100

Release Control Record

Issue No.	Description	Date Issued
RF170428E06-1	Original release.	July 27, 2017

1 Certificate of Conformity

Product: LTE Cat9 PCI Express M.2 Module

Brand: FOXCONN

Test Model: T77W676

Sample Status: ENGINEERING SAMPLE

Applicant: HON HAI PRECISION IND. CO., LTD.

Test Date: June 12 to July 12, 2017

Standards: FCC Part 24

The above equipment has been tested by **Bureau Veritas Consumer Products Services (H.K.) Ltd., Taoyuan Branch**, and found compliance with the requirement of the above standards. The test record, data evaluation & Equipment Under Test (EUT) configurations represented herein are true and accurate accounts of the measurements of the sample's EMC characteristics under the conditions specified in this report. This report contains all test data (Except Effective radiated power and Radiated Spurious Emissions) that was produced under subcontract by Bureau Veritas Consumer Products Services (H.K.) Ltd., Taoyuan Branch Lin Kou Laboratories.

Prepared by :



Date:

July 27, 2017

Claire Kuan / Specialist

Approved by :

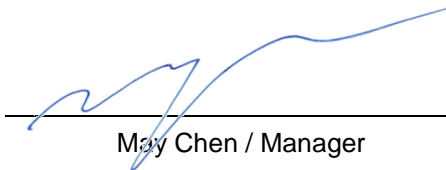

Date:

July 27, 2017

May Chen / Manager

2 Summary of Test Results

Applied Standard: FCC Part 24 & Part 2			
FCC Clause	Test Item	Result	Remarks
2.1046 24.232	Equivalent Isotropically Radiated Power	PASS	Meet the requirement of limit.
2.1046 24.232(d)	Peak To Average Ratio	PASS	Meet the requirement of limit.
2.1055 24.235	Frequency Stability	PASS	Meet the requirement of limit.
2.1049 24.238(b)	Occupied Bandwidth	PASS	Meet the requirement of limit.
24.238(b)	Band Edge Measurements	PASS	Meet the requirement of limit.
2.1051 24.238	Conducted Spurious Emissions	PASS	Meet the requirement of limit.
2.1053 24.238	Radiated Spurious Emissions	PASS	Meet the requirement of limit. Minimum passing margin is -31.11dB at 16920MHz.

2.1 Measurement Uncertainty

Where relevant, the following measurement uncertainty levels have been estimated for tests performed on the EUT as specified in CISPR 16-4-2:

Measurement	Frequency	Expanded Uncertainty (k=2) (\pm)
Radiated Emissions up to 1 GHz	30MHz ~ 1GHz	5.32 dB
Radiated Emissions above 1 GHz	1GHz ~ 6GHz	5.14 dB
	6GHz ~ 18GHz	5.04 dB
	18GHz ~ 40GHz	5.25 dB

2.2 Test Site and Instruments

For radiated spurious emissions test:

DESCRIPTION & MANUFACTURER	MODEL NO.	SERIAL NO.	CALIBRATED DATE	CALIBRATED UNTIL
Test Receiver Agilent	N9038A	MY50010156	Aug. 18, 2016	Aug. 17, 2017
Pre-Amplifier ^(*) EMCI	EMC001340	980142	Jan. 20, 2016	Jan. 19, 2018
Loop Antenna ^(*) Electro-Metrics	EM-6879	264	Dec. 16, 2016	Dec. 15, 2018
RF Cable	NA	LOOPCAB-001 LOOPCAB-002	Jan. 17, 2017	Jan. 16, 2018
Pre-Amplifier Mini-Circuits	ZFL-1000VH2B	AMP-ZFL-05	May 06, 2017	May 05, 2018
Trilog Broadband Antenna SCHWARZBECK	VULB 9168	9168-361	Dec. 29, 2016	Dec. 28, 2017
RF Cable	8D	966-3-1 966-3-2 966-3-3	Apr. 01, 2017	Mar. 31, 2018
Fixed attenuator Mini-Circuits	UNAT-5+	PAD-3m-3-01	Oct. 05, 2016	Oct. 04, 2017
Horn_Antenna SCHWARZBECK	BBHA9120-D	9120D-406	Dec. 28, 2016	Dec. 27, 2017
Pre-Amplifier EMCI	EMC12630SE	980384	Feb. 02, 2017	Feb. 01, 2018
RF Cable	EMC104-SM-SM-1200 EMC104-SM-SM-2000 EMC104-SM-SM-5000	160922 150317 150322	Feb. 02, 2017 Mar. 29, 2017 Mar. 29, 2017	Feb. 01, 2018 Mar. 28, 2018 Mar. 28, 2018
Spectrum Analyzer Keysight	N9030A	MY54490520	July 29, 2016	July 28, 2017
Pre-Amplifier EMCI	EMC184045SE	980386	Feb. 02, 2017	Feb. 01, 2018
Horn_Antenna SCHWARZBECK	BBHA 9170	BBHA9170608	Dec. 15, 2016	Dec. 14, 2017
RF Cable	SUCOFLEX 102	36432/2 36433/2	Jan. 15, 2017	Jan. 14, 2018
Software	ADT_Radiated_V8.7.08	NA	NA	NA
Antenna Tower & Turn Table Max-Full	MF-7802	MF780208406	NA	NA
Boresight Antenna Fixture	FBA-01	FBA-SIP01	NA	NA

Note:

1. The calibration interval of the above test instruments is 12 months and the calibrations are traceable to NML/ROC and NIST/USA.
2. *The calibration interval of the above test instruments is 24 months and the calibrations are traceable to NML/ROC and NIST/USA.
3. The test was performed in 966 Chamber No. 3.
4. The FCC Site Registration No. is 147459
5. The CANADA Site Registration No. is 20331-1
6. Tested Date: June 21 to July 12, 2017

For Radiated power test:

DESCRIPTION & MANUFACTURER	MODEL NO.	SERIAL NO.	CALIBRATED DATE	CALIBRATED UNTIL
Spectrum Analyzer R&S	FSV40	100964	June 28, 2016	June 27, 2017
Spectrum Analyzer Keysight	N9030A	MY54490570	July 06, 2016	July 05, 2017
AC Power Source Extech Electronics	6502	1140503	NA	NA
Temperature & Humidity Chamber TERCHY	MHU-225AU	911033	Dec. 02, 2016	Dec. 01, 2017
DC Power Supply GOOD WILL INSTRUMENT CO., LTD.	GPC - 3030D	7700087	NA	NA
ESG Vector signal generator Agilent	E4438C	Y45094468/005 506 602 UK6 UNJ	Nov. 25, 2016	Nov. 24, 2017
Power meter Anritsu	ML2495A	1014008	May 11, 2017	May 10, 2018
Power sensor Anritsu	MA2411B	0917122	May 11, 2017	May 10, 2018
Software	ADT_RF Test Software V6.6.5.4	NA	NA	NA
Digital Multimeter FLUKE	87III	73680266	Nov. 10, 2016	Nov. 09, 2017

- NOTE:**
1. The test was performed in Oven room 1.
 2. The calibration interval of the above test instruments is 12 months and the calibrations are traceable to NML/ROC and NIST/USA.
 3. Tested Date: June 23, 2017

For other test items:

Description & Manufacturer	Model No.	Serial No.	Cal. Date	Cal. Due
Test Receiver ROHDE & SCHWARZ	ESIB7	100187	May 02, 2017	May 01, 2018
Spectrum Analyzer ROHDE & SCHWARZ	FSP40	100041	Nov. 16, 2016	Nov. 15, 2017
BILOG Antenna SCHWARZBECK	VULB9168	9168-171	Dec. 28, 2016	Dec. 27, 2017
HORN Antenna SCHWARZBECK	9120D	209	Dec. 27, 2016	Dec. 26, 2017
HORN Antenna SCHWARZBECK	BBHA 9170	BBHA9170241	Dec. 14, 2016	Dec. 13, 2017
Preamplifier Agilent	8447D	2944A10738	Aug. 22, 2016	Aug. 21, 2017
Preamplifier Agilent	8449B	3008A01963	Aug. 22, 2016	Aug. 21, 2017
RF signal cable HUBER+SUHNER	SUCOFLEX 104	Cable-CH3-03 (214378)	Aug. 22, 2016	Aug. 21, 2017
RF signal cable HUBER+SUHNER	SUCOFLEX 106	Cable-CH3-03 (309224+12738)	Aug. 22, 2016	Aug. 21, 2017
Software BV ADT	ADT_Radiated_ V7.6.15.9.4	NA	NA	NA
Antenna Tower inn-co GmbH	MA 4000	013303	NA	NA
Antenna Tower Controller BV ADT	AT100	AT93021702	NA	NA
Turn Table BV ADT	TT100	TT93021702	NA	NA
Turn Table Controller BV ADT	SC100	SC93021702	NA	NA
WIT Standard Temperature And Humidity Chamber	TH-4S-C	W981030	Jun. 07, 2017	Jun. 06, 2018
Mini-Circuits Power Splitter	ZN2PD-9G	NA	Aug. 11, 2016	Aug. 10, 2017
JFW 20dB attenuation	50HF-020-SMA	NA	NA	NA

- Note: 1. The calibration interval of the above test instruments is 12 months and the calibrations are traceable to NML/ROC and NIST/USA.
 2. The test was performed in HwaYa Chamber 3.
 3. The horn antenna and preamplifier (model: 8449B) are used only for the measurement of emission frequency above 1GHz if tested.
 4. The FCC Site Registration No. is 988962.
 5. The IC Site Registration No. is IC 7450F-3.
 6. Tested Date: June 12 to 15, 2017

3 General Information

3.1 General Description of EUT

Product	LTE Cat9 PCI Express M.2 Module	
Brand	FOXCONN	
Test Model	T77W676	
Status of EUT	ENGINEERING SAMPLE	
Power Supply Rating	DC 5V from host equipment	
Modulation Type	WCDMA, HSDPA, HSUPA	BPSK
	LTE Band 2	QPSK, 16QAM
	LTE Band 25	QPSK, 16QAM
Operating Frequency	WCDMA, HSDPA, HSUPA	1852.4MHz ~1907.6MHz
	LTE Band 2	1850.7MHz ~ 1909.3MHz
	LTE Band 25	1850.7MHz ~ 1914.3MHz
Max. EIRP Power	WCDMA	816.58mW(29.12dBm)
	LTE Band 2 (Channel Bandwidth 1.4MHz)	582.1mW(27.65dBm)
	LTE Band 2 (Channel Bandwidth 3MHz)	590.2mW(27.71dBm)
	LTE Band 2 (Channel Bandwidth 5MHz)	580.76mW(27.64dBm)
	LTE Band 2 (Channel Bandwidth 10MHz)	583.45mW(27.66dBm)
	LTE Band 2 (Channel Bandwidth 15MHz)	597.04mW(27.76dBm)
	LTE Band 2 (Channel Bandwidth 20MHz)	613.76mW(27.88dBm)
	LTE Band 25 (Channel Bandwidth 1.4MHz)	711.21mW(28.52dBm)
	LTE Band 25 (Channel Bandwidth 3MHz)	717.79mW(28.56dBm)
	LTE Band 25 (Channel Bandwidth 5MHz)	746.45mW(28.73dBm)
	LTE Band 25 (Channel Bandwidth 10MHz)	743.02mW(28.71dBm)
	LTE Band 25 (Channel Bandwidth 15MHz)	751.62mW(28.76dBm)
	LTE Band 25 (Channel Bandwidth 20MHz)	737.9mW(28.68dBm)

Emission Designator	WCDMA	4M20F9W
	LTE Band 2 (Channel Bandwidth 1.4MHz)	QPSK: 1M09G7D 16QAM: 1M09D7W
	LTE Band 2 (Channel Bandwidth 3MHz)	QPSK: 2M70G7D 16QAM: 2M70D7W
	LTE Band 2 (Channel Bandwidth 5MHz)	QPSK: 4M49G7D 16QAM: 4M49D7W
	LTE Band 2 (Channel Bandwidth 10MHz)	QPSK: 9M00G7D 16QAM: 8M99D7W
	LTE Band 2 (Channel Bandwidth 15MHz)	QPSK: 13M6G7D 16QAM: 13M5D7W
	LTE Band 2 (Channel Bandwidth 20MHz)	QPSK: 18M1G7D 16QAM: 18M1D7W
	LTE Band 25 (Channel Bandwidth 1.4MHz)	QPSK: 1M09G7D 16QAM: 1M09D7W
	LTE Band 25 (Channel Bandwidth 3MHz)	QPSK: 2M70G7D 16QAM: 2M70D7W
	LTE Band 25 (Channel Bandwidth 5MHz)	QPSK: 4M49G7D 16QAM: 4M49D7W
	LTE Band 25 (Channel Bandwidth 10MHz)	QPSK: 8M97G7D 16QAM: 8M97D7W
	LTE Band 25 (Channel Bandwidth 15MHz)	QPSK: 13M5G7D 16QAM: 13M5D7W
	LTE Band 25 (Channel Bandwidth 20MHz)	QPSK: 18M0G7D 16QAM: 18M0D7W
	Antenna Type	Refer to Note
Antenna Connector	Refer to Note	
Accessory Device	NA	
Data Cable Supplied	NA	

Note:

1. The EUT is a WWAN device.
2. The antennas provided to the EUT, please refer to the following table:

Antenna NO.	Brand	Model	Gain(dBi) Including cable loss	Frequency range	Antenna Type	Connecter Type	Cable Length
1	TongDa	T-543-8201115-2	3.08 4.74	791~960MHz 1447.9~1606MHz	PIFA	I-PEX MHF IV	100mm
2	TongDa	T-543-8201115-1	4.17	698~803MHz	PIFA	I-PEX MHF IV	100mm
3	TongDa	T-543-8201115-3	5.99	1710~2700MHz	PIFA	I-PEX MHF IV	100mm
4	HongBo	260-23671	-1.33	703-748MHz	PIFA	I-PEX MHF IV	315mm
			-3.23	815-830MHz			
			-3.37	832-862MHz			
			-2.27	824-849MHz			
			-3.11	880-915MHz			
			-4.15	1448-1463MHz			
			-0.64	1710-1785MHz			
			0.18	1850-1915MHz			
	0.57	1920-1980MHz					
	HongBo	260-23672	-3.71	758-803MHz	PIFA	I-PEX MHF IV	439mm
			-0.95	860-875MHz			
			-3.07	791-821MHz			
			-0.97	869-894MHz			
			-3.5	925-960MHz			
			-5.32	1496-1511MHz			
-0.09			1805-1880MHz				
0.16	1930-1995MHz						
-0.8	2110-2170MHz						

Antenna NO.	Brand	Model	Gain(dBi) Including cable loss	Frequency range	Antenna Type	Connecter Type	Cable Length
5	SPEED	F.0G.UH-6010-003-00	-2.81	703-748MHz	PIFA	I-PEX MHF IV	315mm
			-1.53	815-830MHz			
			-1.96	832-862MHz			
			-2.59	880-915MHz			
			-4.19	1448-1463MHz			
			1.23	1710-1785MHz			
			0.26	1850-1883MHz			
			1.16	1915-1980MHz			
	SPEED	F.0G.UH-6010-004-00	-2.67	758-803MHz	PIFA	I-PEX MHF IV	439mm
			-2.42	791-821MHz			
			-2.33	860-894MHz			
			-0.58	925-960MHz			
			-0.17	1496-1511MHz			
			0.83	1805-1880MHz			
-2.72			1930-1995MHz				
-1.67			2110-2170MHz				
6	HongBo	260-23675	-2.68	703-748MHz	PIFA	I-PEX MHF IV	363mm
			-0.88	815-830MHz			
			-1.66	832-862MHz			
			-1.23	824-849MHz			
			1.35	880-915MHz			
			0.8	1448-1463MHz			
			2.03	1710-1785MHz			
			2.02	1850-1915MHz			
			0.57	1920-1980MHz			
	HongBo	260-23676	-2.86	758-803MHz	PIFA	I-PEX MHF IV	522mm
			0.51	860-875MHz			
			-1.19	791-821MHz			
			0.48	869-894MHz			
			-2.29	925-960MHz			
			-4.52	1496-1511MHz			
			-0.09	1805-1880MHz			
			-0.22	1930-1995MHz			
			-0.42	2110-2170MHz			

Antenna NO.	Brand	Model	Gain(dBi) Including cable loss	Frequency range	Antenna Type	Connector Type	Cable Length
7	SPEED	F.0G.UH-6011-003-00	-3.21	703-748MHz	PIFA	I-PEX MHF IV	363mm
			-2.73	815-830MHz			
			-2.48	832-862MHz			
			-3.32	880-915MHz			
			-1.86	1448-1463MHz			
			-0.57	1710-1785MHz			
			-0.63	1850-1883MHz			
			0.44	1915-1980MHz			
	SPEED	F.0G.UH-6011-004-00	-4	758-803MHz	PIFA	I-PEX MHF IV	522mm
			-3.43	791-821MHz			
			-1.22	860-894MHz			
			-2.06	925-960MHz			
			-1.83	1496-1511MHz			
			0.48	1805-1880MHz			
-0.2	1930-1995MHz						
			-2.87	2110-2170MHz			

Set 1~3 were chosen for final test.

3. The above EUT information is declared by manufacturer and for more detailed features description, please refer to the manufacturer's specifications or User's Manual.

3.2 Configuration of System under Test

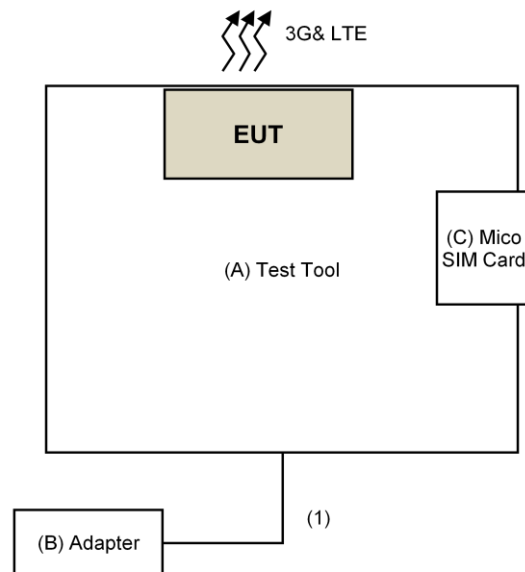

Remote Site

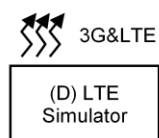

3.2.1 Description Of Support Units

The EUT has been tested as an independent unit together with other necessary accessories or support units. The following support units or accessories were used to form a representative test configuration during the tests.

ID	Product	Brand	Model No.	Serial No.	FCC ID	Remarks
A.	Test Tool	Foxconn	NA	NA	NA	Supplied by client
B.	USB Adapter	ASUS	EXA1205UA	NA	NA	Provided by Lab
C.	Mico SIM Card	NA	NA	NA	NA	Provided by Lab
D.	LTE Simulator	Keysight	E7515-10910	NA	NA	Provided by Lab

Note:

1. All power cords of the above support units are non-shielded (1.8m).

ID	Descriptions	Qty.	Length (m)	Shielding (Yes/No)	Cores (Qty.)	Remarks
1.	USB Cable	1	1	Yes	0	Supplied by client

3.3 Test Mode Applicability and Tested Channel Detail

Pre-Scan has been conducted to determine the worst-case mode from all possible combinations between available modulations, data rates, XYZ axis and antenna ports

The worst case was found when positioned on X-plane. Following channel(s) was (were) selected for the final test as listed below:

WCDMA II MODE

Test Item	Available Channel	Tested Channel	Mode
EIRP	9262 to 9538	9262, 9400, 9538	WCDMA
Frequency Stability	9262 to 9538	9400	WCDMA
Occupied Bandwidth	9262 to 9538	9262, 9400, 9538	WCDMA
Band Edge	9262 to 9538	9262, 9538	WCDMA
Peak to Average Ratio	9262 to 9538	9262, 9400, 9538	WCDMA
Conducted Emission	9262 to 9538	9400	WCDMA
Radiated Emission Below 1GHz	9262 to 9538	9400	WCDMA
Radiated Emission Above 1GHz	9262 to 9538	9400	WCDMA

LTE BAND 2 MODE

TEST ITEM	AVAILABLE CHANNEL	TESTED CHANNEL	CHANNEL BANDWIDTH	MODULATION	MODE
EIRP	18607 to 19193	18607, 18900 19193	1.4MHz	QPSK	1RB / 0 RB offset
	18615 to 19185	18615, 18900, 19185	3MHz	QPSK	1RB / 0 RB offset
	18625 to 19175	18625, 18900, 19175	5MHz	QPSK	1RB / 0 RB offset
	18650 to 19150	18650, 18900, 19150	10MHz	QPSK	1RB / 0 RB offset
	18675 to 19125	18675, 18900, 19125	15MHz	QPSK	1RB / 0 RB offset
	18700 to 19100	18700, 18900, 19100	20MHz	QPSK	1RB / 0 RB offset
Frequency Stability	18607 to 19193	18900	1.4MHz	QPSK	-
	18615 to 19185	18900	3MHz	QPSK	-
	18625 to 19175	18900	5MHz	QPSK	-
	18650 to 19150	18900	10MHz	QPSK	-
	18675 to 19125	18900	15MHz	QPSK	-
	18700 to 19100	18900	20MHz	QPSK	-
Occupied Bandwidth	18607 to 19193	18607, 18900 19193	1.4MHz	QPSK / 16QAM	Full RB
	18615 to 19185	18615, 18900, 19185	3MHz	QPSK / 16QAM	Full RB
	18625 to 19175	18625, 18900, 19175	5MHz	QPSK / 16QAM	Full RB
	18650 to 19150	18650, 18900, 19150	10MHz	QPSK / 16QAM	Full RB
	18675 to 19125	18675, 18900, 19125	15MHz	QPSK / 16QAM	Full RB
	18700 to 19100	18700, 18900, 19100	20MHz	QPSK / 16QAM	Full RB
Peak to Average Ratio	18607 to 19193	18607, 18900 19193	1.4MHz	QPSK / 16QAM	Full RB
	18615 to 19185	18615, 18900, 19185	3MHz	QPSK / 16QAM	Full RB
	18625 to 19175	18625, 18900, 19175	5MHz	QPSK / 16QAM	Full RB
	18650 to 19150	18650, 18900, 19150	10MHz	QPSK / 16QAM	Full RB
	18675 to 19125	18675, 18900, 19125	15MHz	QPSK / 16QAM	Full RB
	18700 to 19100	18700, 18900, 19100	20MHz	QPSK / 16QAM	Full RB
Band Edge	18607 to 19193	18607	1.4MHz	QPSK	1 RB / 0 RB Offset
		19193			1 RB / 5 RB Offset
		18607, 19193			6 RB / 0 RB Offset
	18615 to 19185	18615	3MHz	QPSK	1 RB / 0 RB Offset
		19185			1 RB / 14 RB Offset
		18615, 19185			15 RB / 0 RB Offset
	18625 to 19175	18625,	5MHz	QPSK	1 RB / 0 RB Offset
		19175			1 RB / 24 RB Offset
		18625, 19175			25 RB / 0 RB Offset
	18650 to 19150	18650	10MHz	QPSK	1 RB / 0 RB Offset
		19150			1 RB / 49 RB Offset
		18650, 19150			50 RB / 0 RB Offset
	18675 to 19125	18675,	15MHz	QPSK	1 RB / 0 RB Offset
		19125			1 RB / 74 RB Offset
		18675, 19125			75 RB / 0 RB Offset
	18700 to 19100	18700.	20MHz	QPSK	1 RB / 0 RB Offset
		19100			1 RB / 99 RB Offset
		18700. 19100			100 RB / 0 RB Offset

TEST ITEM	AVAILABLE CHANNEL	TESTED CHANNEL	CHANNEL BANDWIDTH	MODULATION	MODE
Condcudeted Emission	18607 to 19193	18900	1.4MHz	QPSK	1 RB / 0 RB Offset
	18615 to 19185	18900	3MHz	QPSK	1 RB / 0 RB Offset
	18625 to 19175	18900	5MHz	QPSK	1 RB / 0 RB Offset
	18650 to 19150	18900	10MHz	QPSK	1 RB / 0 RB Offset
	18675 to 19125	18900	15MHz	QPSK	1 RB / 0 RB Offset
	18700 to 19100	18900	20MHz	QPSK	1 RB / 0 RB Offset
Radiated Emission	18607 to 19193	18900	1.4MHz	QPSK	1 RB / 0 RB Offset
	18615 to 19185	18900	3MHz	QPSK	1 RB / 0 RB Offset
	18625 to 19175	18900	5MHz	QPSK	1 RB / 0 RB Offset
	18650 to 19150	18900	10MHz	QPSK	1 RB / 0 RB Offset
	18675 to 19125	18900	15MHz	QPSK	1 RB / 0 RB Offset
	18700 to 19100	18900	20MHz	QPSK	1 RB / 0 RB Offset

LTE BAND 25 MODE

TEST ITEM	AVAILABLE CHANNEL	TESTED CHANNEL	CHANNEL BANDWIDTH	MODULATION	MODE
EIRP	26047 to 26683	26047, 26365, 26683	1.4MHz	QPSK	1RB / 0 RB offset
	26055 to 26675	26055, 26365, 26675	3MHz	QPSK	1RB / 0 RB offset
	26065 to 26665	26065, 26365, 26665	5MHz	QPSK	1RB / 0 RB offset
	26090 to 26640	26090, 26365, 26640	10MHz	QPSK	1RB / 0 RB offset
	26115 to 26615	26115, 26365, 26615	15MHz	QPSK	1RB / 0 RB offset
	26140 to 26590	26140, 26365, 26590	20MHz	QPSK	1RB / 0 RB offset
Frequency Stability	26047 to 26683	26365	1.4MHz	QPSK	-
	26055 to 26675	26365	3MHz	QPSK	-
	26065 to 26665	26365	5MHz	QPSK	-
	26090 to 26640	26365	10MHz	QPSK	-
	26115 to 26615	26365	15MHz	QPSK	-
	26140 to 26590	26365	20MHz	QPSK	-
Occupied Bandwidth	26047 to 26683	26047, 26365, 26683	1.4MHz	QPSK / 16QAM	Full RB
	26055 to 26675	26055, 26365, 26675	3MHz	QPSK / 16QAM	Full RB
	26065 to 26665	26065, 26365, 26665	5MHz	QPSK / 16QAM	Full RB
	26090 to 26640	26090, 26365, 26640	10MHz	QPSK / 16QAM	Full RB
	26115 to 26615	26115, 26365, 26615	15MHz	QPSK / 16QAM	Full RB
	26140 to 26590	26140, 26365, 26590	20MHz	QPSK / 16QAM	Full RB
Peak to Average Ratio	26047 to 26683	26047, 26365, 26683	1.4MHz	QPSK / 16QAM	Full RB
	26055 to 26675	26055, 26365, 26675	3MHz	QPSK / 16QAM	Full RB
	26065 to 26665	26065, 26365, 26665	5MHz	QPSK / 16QAM	Full RB
	26090 to 26640	26090, 26365, 26640	10MHz	QPSK / 16QAM	Full RB
	26115 to 26615	26115, 26365, 26615	15MHz	QPSK / 16QAM	Full RB
	26140 to 26590	26140, 26365, 26590	20MHz	QPSK / 16QAM	Full RB
Band Edge	18607 to 19193	26047	1.4MHz	QPSK	1 RB / 0 RB Offset
		26683			1 RB / 5 RB Offset
		26047, 26683			6 RB / 0 RB Offset
	18615 to 19185	26055	3MHz	QPSK	1 RB / 0 RB Offset
		26675			1 RB / 14 RB Offset
		26055, 26675			15 RB / 0 RB Offset
	18625 to 19175	26065	5MHz	QPSK	1 RB / 0 RB Offset
		26665			1 RB / 24 RB Offset
		26065, 26665			25 RB / 0 RB Offset
	18650 to 19150	26090	10MHz	QPSK	1 RB / 0 RB Offset
		26640			1 RB / 49 RB Offset
		26090, 26640			50 RB / 0 RB Offset
	18675 to 19125	26115	15MHz	QPSK	1 RB / 0 RB Offset
		26615			1 RB / 74 RB Offset
		26115, 26615			75 RB / 0 RB Offset
	18700 to 19100	26140	20MHz	QPSK	1 RB / 0 RB Offset
		26590			1 RB / 99 RB Offset
		26140, 26590			100 RB / 0 RB Offset

TEST ITEM	AVAILABLE CHANNEL	TESTED CHANNEL	CHANNEL BANDWIDTH	MODULATION	MODE
Conducuted Emission	18607 to 19193	26365	1.4MHz	QPSK	1RB / 0 RB offset
	18615 to 19185	26365	3MHz	QPSK	1RB / 0 RB offset
	18625 to 19175	26365	5MHz	QPSK	1RB / 0 RB offset
	18650 to 19150	26365	10MHz	QPSK	1RB / 0 RB offset
	18675 to 19125	26365	15MHz	QPSK	1RB / 0 RB offset
	18700 to 19100	26365	20MHz	QPSK	1RB / 0 RB offset
Radiated Emission	18607 to 19193	26365	1.4MHz	QPSK	1RB / 0 RB offset
	18615 to 19185	26365	3MHz	QPSK	1RB / 0 RB offset
	18625 to 19175	26365	5MHz	QPSK	1RB / 0 RB offset
	18650 to 19150	26365	10MHz	QPSK	1RB / 0 RB offset
	18675 to 19125	26365	15MHz	QPSK	1RB / 0 RB offset
	18700 to 19100	26365	20MHz	QPSK	1RB / 0 RB offset

NOTE:

All supported modulation types were evaluated. The Worst case of QPSK was selected. Therefore, the Output power, Frequency Stability, Emission Mask, Conducuted Emission and Radiated Emission were presented under QPSK mode only.

Test Condition:

Test Item	Environmental Conditions	Input Power	Tested By
EIRP	25deg. C, 63%RH	120Vac, 60Hz	Weiwei Lo
Frequency Stability	23deg. C, 68%RH	120Vac, 60Hz	Anson Lin
Occupied Bandwidth	23deg. C, 68%RH	120Vac, 60Hz	Anson Lin
Band Edge	23deg. C, 68%RH	120Vac, 60Hz	Anson Lin
Peak to Average Ratio	23deg. C, 68%RH	120Vac, 60Hz	Anson Lin
Conducuted Emission	23deg. C, 68%RH	120Vac, 60Hz	Anson Lin
Radiated Emission Below 1GHz	25deg. C, 66%RH	120Vac, 60Hz	Weiwei Lo
Radiated Emission Above 1GHz	23deg. C, 68%RH	120Vac, 60Hz	Weiwei Lo

3.4 EUT Operating Conditions

The communication simulator station system controlled a EUT to export maximum output power under transmission mode and specific channel frequency

3.5 General Description of Applied Standards

The EUT is a RF Product. According to the specifications of the manufacturer, it must comply with the requirements of the following standards:

FCC 47 CFR Part 2

FCC 47 CFR Part 24

KDB 971168 D01 Power Meas License Digital Systems v02r02

ANSI/TIA/EIA-603-D 2010

NOTE: All test items have been performed and recorded as per the above standards.

4 Test Types and Results

4.1 Output Power Measurement

4.1.1 Limits of Output Power Measurement

Mobile / Portable station are limited to 2 watts e.i.r.p.

4.1.2 Test Procedures

Conducted Power Measurement:

The EUT was set up for the maximum power with WCDMA & LTE link data modulation and link up with simulator. Set the EUT to transmit under low, middle and high channel and record the power level shown on simulator.

EIRP Measurement:

- a. All measurements were done at low, middle and high operational frequency range. Set the RBW \geq OBW and VBW \geq 3xRBW.
- b. Substitution method is used for EIRP measurement. In the semi-anechoic chamber, EUT placed on the 0.8m/1.5m height of Turn Table, rotated the table around 360 degrees to search the maximum radiation power and receiver antenna shall be rotated vertical and horizontal polarization and moved height from 1m to 4m to find the maximum polar radiated power. The "Read Value" is the spectrum reading the maximum power value.
- c. The substitution antenna is substituted for EUT at the same position and signals generator export the CW signal to the substitution antenna via a TX cable. Rotated the Turn Table and moved receiving antenna to find the maximum radiation power. Adjust output power level of S.G to get a Value of spectrum reading equal to "Read Value" of step b. Record the power level of S.G
- d. EIRP = Output power level of S.G – TX cable loss + Antenna gain of substitution antenna.

Note: The worst case vertical or horizontal polarization have been investigated and reported in this report.

4.1.3 Test Setup

CONDUCTED POWER MEASUREMENT:



ERP/EIRP MEASUREMENT:

For ERP/EIRP below 1GHz

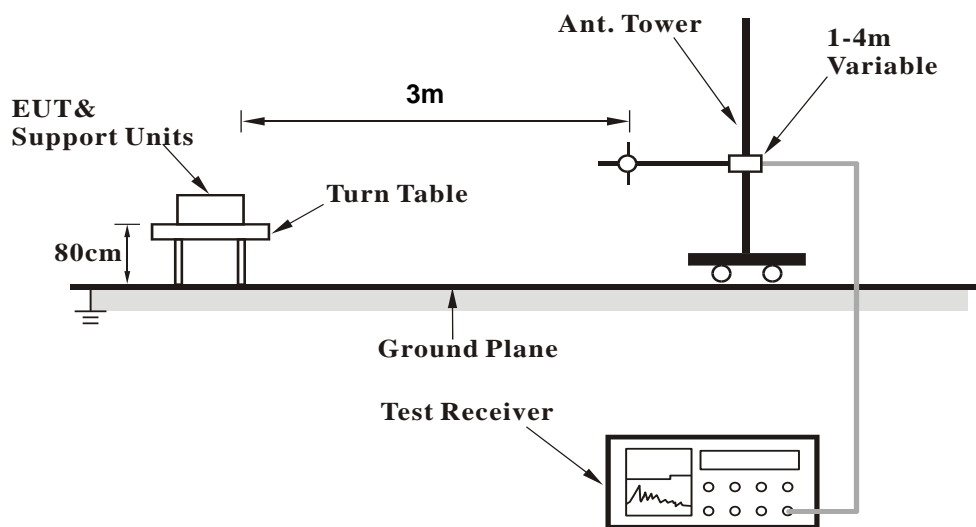

For ERP/EIRP above 1GHz

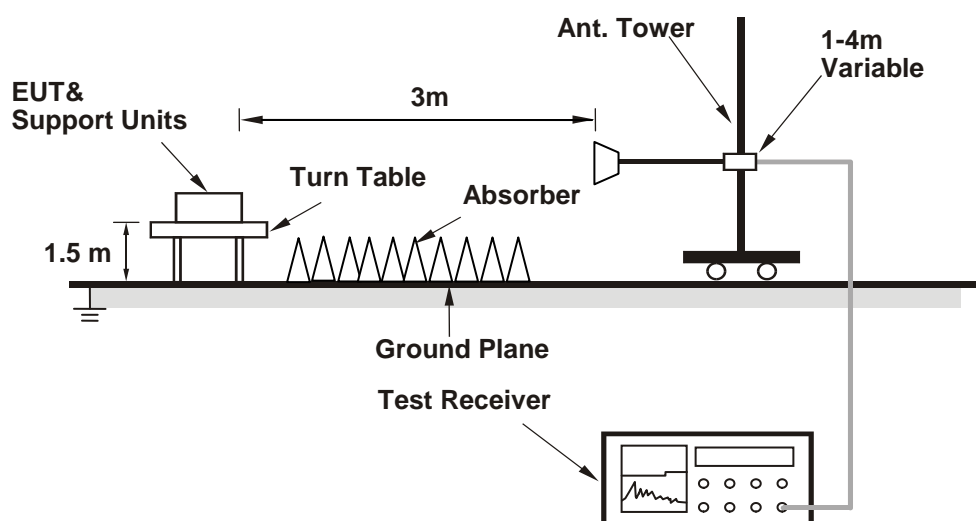

For the actual test configuration, please refer to the attached file (Test Setup Photo).

4.1.4 Test Results

CONDUCTED OUTPUT POWER (dBm)

(Subcontract Item)

Band	WCDMA II		
	Channel	9262	9400
Frequency (MHz)	1852.4	1880.0	1907.6
RMC	24.64	24.63	24.68
HSDPA Subtest-1	23.58	23.56	23.60
HSDPA Subtest-2	23.60	23.59	23.63
HSDPA Subtest-3	23.17	23.15	23.29
HSDPA Subtest-4	23.14	23.13	23.18
HSUPA Subtest-1	23.60	23.59	23.63
HSUPA Subtest-2	21.62	21.61	21.70
HSUPA Subtest-3	22.62	22.60	22.65
HSUPA Subtest-4	21.55	21.54	21.66
HSUPA Subtest-5	23.61	23.60	23.65

LTE Band 2

Band / BW	RB Size	RB Offset	QPSK			3GPP MPR (dB)	16QAM			3GPP MPR (dB)	
			Low CH	Mid CH	High CH		Low CH	Mid CH	High CH		
			18607	18900	19193		20407	20525	20643		
			1850.7	1880	1909.3		824.7	836.5	848.3		
			MHz	MHz	MHz						
2 / 1.4M	1	0	24.22	24.37	23.97	0	23.25	23.43	22.98	1	
	1	2	23.43	23.70	23.26	0	22.50	22.70	22.30	1	
	1	5	23.32	23.51	23.11	0	22.27	22.50	22.34	1	
	3	0	23.80	24.01	23.39	0	22.88	23.04	22.36	1	
	3	1	23.57	23.85	23.29	0	22.64	22.81	22.23	1	
	3	3	23.50	23.70	23.21	0	22.51	22.70	22.19	1	
	6	0	22.88	23.09	22.42	1	21.83	22.10	21.59	2	

Band / BW	RB Size	RB Offset	QPSK			3GPP MPR (dB)	16QAM			3GPP MPR (dB)	
			Low CH	Mid CH	High CH		Low CH	Mid CH	High CH		
			18615	18900	19185		18615	18900	19185		
			1851.5	1880	1908.5		1851.5	1880	1908.5		
			MHz	MHz	MHz						
2 / 3M	1	0	24.28	24.44	24.03	0	23.31	23.48	23.05	1	
	1	7	23.67	23.77	23.44	0	22.59	22.76	22.35	1	
	1	14	23.35	23.57	23.07	0	22.25	22.59	22.24	1	
	8	0	22.84	23.10	22.69	1	21.80	22.05	21.52	2	
	8	3	22.77	22.94	22.49	1	21.69	21.90	21.35	2	
	8	7	22.59	22.84	22.34	1	21.52	21.77	21.27	2	
	15	0	22.94	23.20	22.80	1	22.03	22.14	21.74	2	

Band / BW	RB Size	RB Offset	QPSK			3GPP MPR (dB)	16QAM			3GPP MPR (dB)	
			Low CH	Mid CH	High CH		Low CH	Mid CH	High CH		
			18625	18900	19175		18625	18900	19175		
			1852.5	1880	1907.5		1852.5	1880	1907.5		
			MHz	MHz	MHz						
2 / 5M	1	0	24.34	24.49	24.09	0	23.37	23.54	23.10	1	
	1	12	23.54	23.81	23.40	0	22.73	22.84	22.31	1	
	1	24	23.35	23.62	23.12	0	22.49	22.61	22.04	1	
	12	0	23.02	23.16	22.80	1	22.01	22.16	21.76	2	
	12	6	22.90	23.02	22.57	1	21.78	21.97	21.46	2	
	12	13	22.69	22.90	22.47	1	21.71	21.86	21.44	2	
	25	0	22.96	23.24	22.74	1	22.10	22.24	21.60	2	

Band / BW	RB Size	RB Offset	QPSK			3GPP MPR (dB)	16QAM			3GPP MPR (dB)
			Low CH	Mid CH	High CH		Low CH	Mid CH	High CH	
			18650	18900	19150		18650	18900	19150	
			1855	1880	1905		1855	1880	1905	
			MHz	MHz	MHz		MHz	MHz	MHz	
2 / 10M	1	0	24.38	24.53	24.13	0	23.44	23.59	23.19	1
	1	24	23.68	23.87	23.44	0	22.85	22.93	22.56	1
	1	49	23.47	23.71	23.29	0	22.51	22.75	22.22	1
	25	0	23.10	23.25	22.87	1	22.09	22.28	21.84	2
	25	12	22.93	23.12	22.72	1	21.98	22.11	21.65	2
	25	25	22.80	23.02	22.63	1	21.74	22.02	21.59	2
	50	0	23.12	23.38	22.91	1	22.19	22.35	21.95	2

Band / BW	RB Size	RB Offset	QPSK			3GPP MPR (dB)	16QAM			3GPP MPR (dB)
			Low CH	Mid CH	High CH		Low CH	Mid CH	High CH	
			18675	18900	19125		18675	18900	19125	
			1857.5	1880	1902.5		1857.5	1880	1902.5	
			MHz	MHz	MHz		MHz	MHz	MHz	
2 / 15M	1	0	24.44	24.59	24.21	0	23.49	23.64	23.25	1
	1	37	23.81	23.94	23.53	0	22.87	23.00	22.62	1
	1	74	23.63	23.78	23.41	0	22.73	22.82	22.50	1
	36	0	23.18	23.38	22.90	1	22.18	22.38	21.87	2
	36	19	23.08	23.26	22.87	1	22.01	22.23	21.77	2
	36	39	22.95	23.16	22.76	1	21.97	22.12	21.72	2
	75	0	23.32	23.45	23.00	1	22.29	22.48	21.93	2

Band / BW	RB Size	RB Offset	QPSK			3GPP MPR (dB)	16QAM			3GPP MPR (dB)
			Low CH	Mid CH	High CH		Low CH	Mid CH	High CH	
			18700	18900	19100		18700	18900	19100	
			1860	1880	1900		1860	1880	1900	
			MHz	MHz	MHz		MHz	MHz	MHz	
2 / 20M	1	0	24.50	24.64	24.27	0	23.54	23.69	23.31	1
	1	50	23.95	24.02	23.65	0	22.92	23.05	22.64	1
	1	99	23.78	23.86	23.44	0	22.69	22.88	22.49	1
	50	0	23.29	23.48	23.08	1	22.38	22.48	22.05	2
	50	25	23.20	23.36	22.99	1	22.17	22.34	21.97	2
	50	50	23.05	23.28	22.94	1	22.02	22.26	21.89	2
	100	0	23.43	23.55	23.15	1	22.43	22.56	22.12	2

LTE Band 25

Band / BW	RB Size	RB Offset	QPSK			3GPP MPR (dB)	16QAM			3GPP MPR (dB)	
			Low CH	Mid CH	High CH		Low CH	Mid CH	High CH		
			26047	26365	26683		26047	26365	26683		
			1850.7	1882.5	1914.3		1850.7	1882.5	1914.3		
			MHz	MHz	MHz						
25 / 1.4M	1	0	23.77	24.10	24.15	0	22.86	23.14	23.20	1	
	1	2	23.62	23.93	24.00	0	22.72	23.00	23.08	1	
	1	5	23.49	23.72	23.88	0	22.54	22.81	22.90	1	
	3	0	23.66	23.91	24.08	0	22.58	22.92	23.00	1	
	3	1	23.55	23.87	23.95	0	22.47	22.87	22.95	1	
	3	3	23.47	23.78	23.87	0	22.40	22.74	22.81	1	
	6	0	22.25	22.58	22.63	1	21.24	21.56	21.68	2	

Band / BW	RB Size	RB Offset	QPSK			3GPP MPR (dB)	16QAM			3GPP MPR (dB)	
			Low CH	Mid CH	High CH		Low CH	Mid CH	High CH		
			26055	26365	26675		26055	26365	26675		
			1851.5	1882.5	1913.5		1851.5	1882.5	1913.5		
			MHz	MHz	MHz						
25 / 3M	1	0	23.84	24.15	24.20	0	22.90	23.17	23.23	1	
	1	7	23.69	23.98	24.10	0	22.71	23.03	23.11	1	
	1	14	23.63	23.82	23.92	0	22.54	22.87	22.94	1	
	8	0	22.61	22.90	22.99	1	21.56	21.82	22.00	2	
	8	3	22.52	22.84	22.87	1	21.46	21.77	21.86	2	
	8	7	22.44	22.76	22.81	1	21.41	21.66	21.77	2	
	15	0	22.41	22.69	22.76	1	21.36	21.63	21.71	2	

Band / BW	RB Size	RB Offset	QPSK			3GPP MPR (dB)	16QAM			3GPP MPR (dB)	
			Low CH	Mid CH	High CH		Low CH	Mid CH	High CH		
			26065	26365	26665		26065	26365	26665		
			1852.5	1882.5	1912.5		1852.5	1882.5	1912.5		
			MHz	MHz	MHz						
25 / 5M	1	0	23.97	24.21	24.26	0	22.98	23.26	23.31	1	
	1	12	23.85	24.07	24.17	0	22.83	23.13	23.21	1	
	1	24	23.62	23.93	24.03	0	22.58	22.94	23.07	1	
	12	0	22.70	22.98	23.06	1	21.68	21.97	22.12	2	
	12	6	22.66	22.93	23.02	1	21.62	21.90	21.95	2	
	12	13	22.58	22.83	22.88	1	21.56	21.83	21.90	2	
	25	0	22.56	22.78	22.85	1	21.50	21.78	21.83	2	

Band / BW	RB Size	RB Offset	QPSK			3GPP MPR (dB)	16QAM			3GPP MPR (dB)
			Low CH	Mid CH	High CH		Low CH	Mid CH	High CH	
			26090	26365	26640		26090	26365	26640	
			1855	1882.5	1910		1855	1882.5	1910	
			MHz	MHz	MHz		MHz	MHz	MHz	
25 / 10M	1	0	24.38	24.53	24.13	0	23.44	23.59	23.19	1
	1	24	23.68	23.87	23.44	0	22.85	22.93	22.56	1
	1	49	23.47	23.71	23.29	0	22.51	22.75	22.22	1
	25	0	23.10	23.25	22.87	1	22.09	22.28	21.84	2
	25	12	22.93	23.12	22.72	1	21.98	22.11	21.65	2
	25	25	22.80	23.02	22.63	1	21.74	22.02	21.59	2
	50	0	23.12	23.38	22.91	1	22.19	22.35	21.95	2

Band / BW	RB Size	RB Offset	QPSK			3GPP MPR (dB)	16QAM			3GPP MPR (dB)
			Low CH	Mid CH	High CH		Low CH	Mid CH	High CH	
			26115	26365	26615		26115	26365	26615	
			1857.5	1882.5	1907.5		1857.5	1882.5	1907.5	
			MHz	MHz	MHz		MHz	MHz	MHz	
25 / 15M	1	0	24.12	24.31	24.36	0	23.13	23.36	23.41	1
	1	37	23.98	24.21	24.29	0	22.96	23.23	23.29	1
	1	74	23.90	24.09	24.19	0	22.86	23.09	23.15	1
	36	0	22.96	23.20	23.33	1	22.00	22.19	22.30	36
	36	19	22.92	23.16	23.22	1	21.91	22.14	22.22	36
	36	39	22.88	23.10	23.14	1	21.82	22.07	22.12	36
	75	0	22.86	23.05	23.12	1	21.81	22.03	22.07	75

Band / BW	RB Size	RB Offset	QPSK			3GPP MPR (dB)	16QAM			3GPP MPR (dB)
			Low CH	Mid CH	High CH		Low CH	Mid CH	High CH	
			26140	26365	26590		26140	26365	26590	
			1860	1882.5	1905		1860	1882.5	1905	
			MHz	MHz	MHz		MHz	MHz	MHz	
25 / 20M	1	0	24.18	24.37	24.41	0	23.21	23.42	23.46	1
	1	50	24.08	24.27	24.36	0	23.08	23.32	23.39	1
	1	99	24.00	24.16	24.21	0	23.01	23.18	23.24	1
	50	0	23.18	23.30	23.38	1	22.17	22.30	22.35	2
	50	25	23.08	23.27	23.30	1	22.05	22.27	22.32	2
	50	50	23.03	23.22	23.26	1	21.98	22.22	22.27	2
	100	0	23.00	23.19	23.24	1	21.95	22.19	22.23	2

EIRP POWER

WCDMA

Channel	Frequency (MHz)	Antenna Polarization	LVL (dBm)	Correction Factor(dB)	EIRP(dBm)	EIRP(mW)
9262	1852.4	H	22.34	6.63	28.97	788.86
9400	1880	H	22.44	6.68	29.12	816.58
9538	1907.6	H	22.33	6.73	29.06	805.38

Note: The worst case vertical or horizontal polarization have been investigated and find the worst is horizontal.

LTE Band 2 / 1.4M

Channel	Frequency (MHz)	Antenna Polarization	LVL (dBm)	Correction Factor(dB)	EIRP(dBm)	EIRP(mW)
18607	1850.7	H	20.54	6.63	27.17	521.19
18900	1880	H	20.97	6.68	27.65	582.10
19193	1909.3	H	20.66	6.73	27.39	548.28

Note: The worst case vertical or horizontal polarization have been investigated and find the worst is horizontal.

LTE Band 2 / 3M

Channel	Frequency (MHz)	Antenna Polarization	LVL (dBm)	Correction Factor(dB)	EIRP(dBm)	EIRP(mW)
18615	1851.5	H	20.60	6.63	27.23	528.45
18900	1880	H	21.03	6.68	27.71	590.20
19185	1908.5	H	20.75	6.73	27.48	559.76

Note: The worst case vertical or horizontal polarization have been investigated and find the worst is horizontal.

LTE Band 2 / 5M

Channel	Frequency (MHz)	Antenna Polarization	LVL (dBm)	Correction Factor(dB)	EIRP(dBm)	EIRP(mW)
18625	1852.5	H	20.65	6.63	27.28	534.56
18900	1880	H	20.96	6.68	27.64	580.76
19175	1907.5	H	20.78	6.73	27.51	563.64

Note: The worst case vertical or horizontal polarization have been investigated and find the worst is horizontal.

LTE Band 2 / 10M

Channel	Frequency (MHz)	Antenna Polarization	LVL (dBm)	Correction Factor(dB)	EIRP(dBm)	EIRP(mW)
18650	1855	H	20.67	6.64	27.31	538.27
18900	1880	H	20.98	6.68	27.66	583.45
19150	1905	H	20.86	6.73	27.59	574.12

Note: The worst case vertical or horizontal polarization have been investigated and find the worst is horizontal.

LTE Band 2 / 15M

Channel	Frequency (MHz)	Antenna Polarization	LVL (dBm)	Correction Factor(dB)	EIRP(dBm)	EIRP(mW)
18675	1857.5	H	20.85	6.64	27.49	561.05
18900	1880	H	21.08	6.68	27.76	597.04
19125	1902.5	H	21.00	6.72	27.72	591.56

Note: The worst case vertical or horizontal polarization have been investigated and find the worst is horizontal.

LTE Band 2 / 20M

Channel	Frequency (MHz)	Antenna Polarization	LVL (dBm)	Correction Factor(dB)	EIRP(dBm)	EIRP(mW)
18700	1860	H	20.93	6.65	27.58	572.80
18900	1880	H	21.01	6.68	27.69	587.49
19100	1900	H	21.16	6.72	27.88	613.76

Note: The worst case vertical or horizontal polarization have been investigated and find the worst is horizontal.

LTE Band 25 / 1.4M

Channel	Frequency (MHz)	Antenna Polarization	LVL (dBm)	Correction Factor(dB)	EIRP(dBm)	EIRP(mW)
26047	1850.7	H	21.82	6.63	28.45	699.84
26365	1882.5	H	21.84	6.68	28.52	711.21
26683	1914.3	H	21.64	6.73	28.37	687.07

Note: The worst case vertical or horizontal polarization have been investigated and find the worst is horizontal.

LTE Band 25 / 3M

Channel	Frequency (MHz)	Antenna Polarization	LVL (dBm)	Correction Factor(dB)	EIRP(dBm)	EIRP(mW)
26055	1851.5	H	21.86	6.63	28.49	706.32
26365	1882.5	H	21.88	6.68	28.56	717.79
26675	1913.5	H	21.58	6.73	28.31	677.64

Note: The worst case vertical or horizontal polarization have been investigated and find the worst is horizontal.

LTE Band 25 / 5M

Channel	Frequency (MHz)	Antenna Polarization	LVL (dBm)	Correction Factor(dB)	EIRP(dBm)	EIRP(mW)
26065	1852.5	H	21.95	6.63	28.58	721.11
26365	1882.5	H	22.05	6.68	28.73	746.45
26665	1912.5	H	21.69	6.73	28.42	695.02

Note: The worst case vertical or horizontal polarization have been investigated and find the worst is horizontal.

LTE Band 25 / 10M

Channel	Frequency (MHz)	Antenna Polarization	LVL (dBm)	Correction Factor(dB)	EIRP(dBm)	EIRP(mW)
26090	1855	H	21.98	6.64	28.62	727.78
26365	1882.5	H	22.03	6.68	28.71	743.02
26640	1910	H	21.58	6.73	28.31	677.64

Note: The worst case vertical or horizontal polarization have been investigated and find the worst is horizontal.

LTE Band 25 / 15M

Channel	Frequency (MHz)	Antenna Polarization	LVL (dBm)	Correction Factor(dB)	EIRP(dBm)	EIRP(mW)
26115	1857.5	H	22.05	6.64	28.69	739.61
16365	1882.5	H	22.08	6.68	28.76	751.62
16615	1907.5	H	21.80	6.72	28.52	711.21

Note: The worst case vertical or horizontal polarization have been investigated and find the worst is horizontal.

LTE Band 25 / 20M

Channel	Frequency (MHz)	Antenna Polarization	LVL (dBm)	Correction Factor(dB)	EIRP(dBm)	EIRP(mW)
26140	1860	H	21.97	6.65	28.62	727.78
26365	1882.5	H	22.00	6.68	28.68	737.90
26590	1905	H	21.70	6.72	28.42	695.02

Note: The worst case vertical or horizontal polarization have been investigated and find the worst is horizontal.

4.2 Frequency Stability Measurement

4.2.1 Limits of Frequency Stability Measurement

The frequency stability shall be sufficient to ensure that the fundamental emission stays within the authorized frequency block.

4.2.2 Test Procedure

- a. Device is placed at the oven room. The oven room could control the temperatures and humidity. Power warm up is at least 15 min and power applied should perform before recording frequency error.
- b. EUT is connected the external power supply to control the DC input power. The test voltage range is from minimum to maximum working voltage. Each step shall be record the frequency error rate.
- c. The temperature range step is 10 degrees in this test items. All temperature levels shall be hold the ± 0.5 °C during the measurement testing. The each temperature step shall be at least 0.5 hours, consider the EUT could be test under the stability condition.

NOTE: The frequency error was recorded frequency error from the communication simulator.

4.2.3 Test Setup

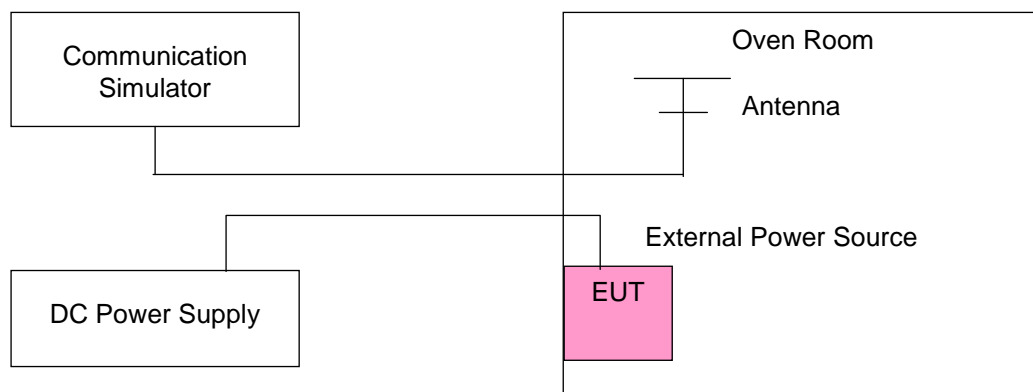

4.2.4 Test Results (Subcontract Item)

WCDMA

Frequency Error vs. Voltage

Voltage (Volts)	Frequency Error (ppm)	Limit (ppm)
	WCDMA	
3.3	0.001	2.5
2.805	0.002	2.5
3.795	0.001	2.5

Frequency Error vs. Temperature.

TEMP. (°C)	Frequency Error (ppm)	Limit (ppm)
	WCDMA	
-30	0.001	2.5
-20	0.001	2.5
-10	0.001	2.5
0	0.002	2.5
10	0.002	2.5
20	-0.001	2.5
30	-0.002	2.5
40	-0.001	2.5
50	-0.001	2.5

LTE

Frequency Error vs. Voltage

Voltage (Volts)	Frequency Error (ppm)												Limit (ppm)
	LTE Band 2						LTE Band 25						
	1.4MHz	3MHz	5MHz	10MHz	15MHz	20MHz	1.4MHz	3MHz	5MHz	10MHz	15MHz	20MHz	
3.3	0.002	0.002	0.001	0.002	0.001	0.002	0.001	0.001	0.001	0.002	0.001	0.001	2.5
2.805	0.001	0.001	0.002	0.001	0.002	0.001	0.002	0.001	0.001	0.001	0.001	0.002	2.5
3.795	0.001	0.002	0.001	0.001	0.001	0.001	0.001	0.002	0.002	0.002	0.002	0.002	2.5

Frequency Error vs. Temperature

Temp. (°C)	Frequency Error (ppm)												Limit (ppm)
	LTE Band 5						LTE Band 26						
	1.4MHz	3MHz	5MHz	10MHz	15MHz	20MHz	1.4MHz	3MHz	5MHz	10MHz	15MHz	20MHz	
-30	0.001	0.002	0.001	0.002	0.001	0.002	0.001	0.002	0.001	0.001	0.001	0.002	2.5
-20	0.001	0.001	0.002	0.001	0.002	0.002	0.001	0.001	0.002	0.001	0.002	0.002	2.5
-10	0.001	0.001	0.001	0.002	0.001	0.001	0.002	0.001	0.002	0.001	0.002	0.002	2.5
0	0.002	0.001	0.001	0.002	0.001	0.002	0.001	0.001	0.002	0.001	0.001	0.002	2.5
10	0.001	0.001	0.001	0.001	0.001	0.001	0.001	0.002	0.001	0.002	0.002	0.002	2.5
20	-0.001	-0.002	-0.002	-0.001	-0.001	-0.001	-0.001	-0.001	-0.001	-0.002	-0.001	-0.001	2.5
30	-0.001	-0.002	-0.001	-0.001	-0.002	-0.002	-0.002	-0.001	-0.002	-0.001	-0.001	-0.001	2.5
40	-0.001	-0.002	-0.002	-0.001	-0.002	-0.002	-0.001	-0.002	-0.001	-0.001	-0.001	-0.001	2.5
50	-0.001	-0.002	-0.002	-0.001	-0.002	-0.001	-0.001	-0.002	-0.002	-0.001	-0.002	-0.001	2.5

4.3 Occupied Bandwidth Measurement

4.3.1 Test Procedure

All measurements were done at low, middle and high operational frequency range. The communication simulator station system controlled a EUT to export maximum output power under transmission mode and specific channel frequency. Use OBW measurement function of Spectrum analyzer to measure 99 % occupied bandwidth.

4.3.2 Test Setup

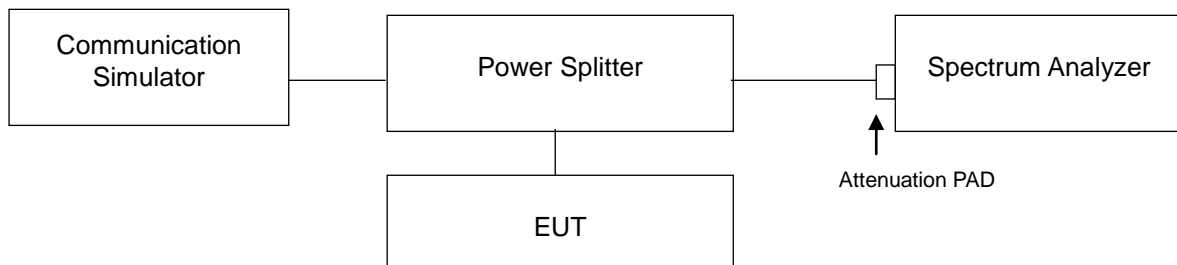

4.3.3 Test Result (-26dB Bandwidth, Subcontract Item)

Channel	FREQ. (MHz)	-26dB Bandwidth (MHz)
		WCDMA
9262	1852.4	4.84
9400	1880.0	4.77
9538	1907.6	4.85

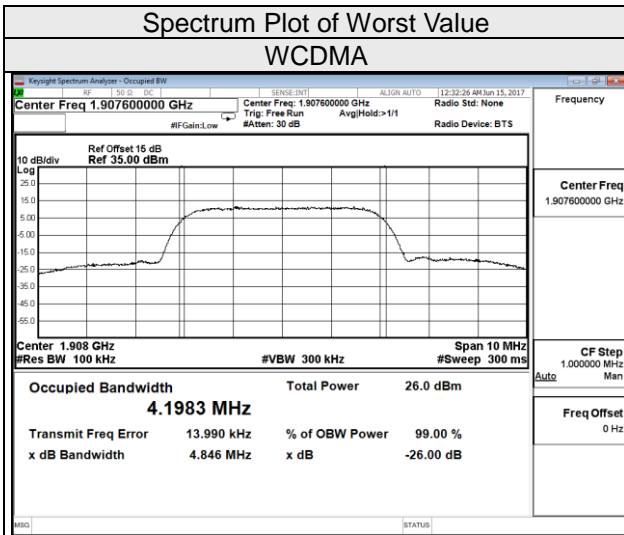

LTE Band 2							
Channel Bandwidth 1.4MHz				Channel Bandwidth 3MHz			
Channel	Frequency (MHz)	-26dB Bandwidth (MHz)		Channel	Frequency (MHz)	-26dB Bandwidth (MHz)	
		QPSK	16QAM			QPSK	16QAM
18607	1850.7	1.24	1.23	18615	1851.5	2.95	2.96
18900	1880	1.22	1.22	18900	1880	2.94	2.94
19193	1909.3	1.22	1.22	19185	1907.5	2.98	2.96
Channel Bandwidth 5MHz				Channel Bandwidth 10MHz			
Channel	Frequency (MHz)	-26dB Bandwidth (MHz)		Channel	Frequency (MHz)	-26dB Bandwidth (MHz)	
		QPSK	16QAM			QPSK	16QAM
18625	1852.5	4.82	4.82	18650	1855	9.56	9.59
18900	1880	4.82	4.81	18900	1880	9.53	9.53
19175	1907.5	4.85	4.83	19150	1905	10.25	9.64
Channel Bandwidth 15MHz				Channel Bandwidth 20MHz			
Channel	Frequency (MHz)	-26dB Bandwidth (MHz)		Channel	Frequency (MHz)	-26dB Bandwidth (MHz)	
		QPSK	16QAM			QPSK	16QAM
18675	1857.5	14.42	14.28	18700	1860	20.03	19.11
18900	1880	14.42	14.30	18900	1880	19.55	19.11
19125	1902.5	20.18	16.70	19100	1900	25.33	21.91

Spectrum Plot of Worst Value

1.4MHz / QPSK

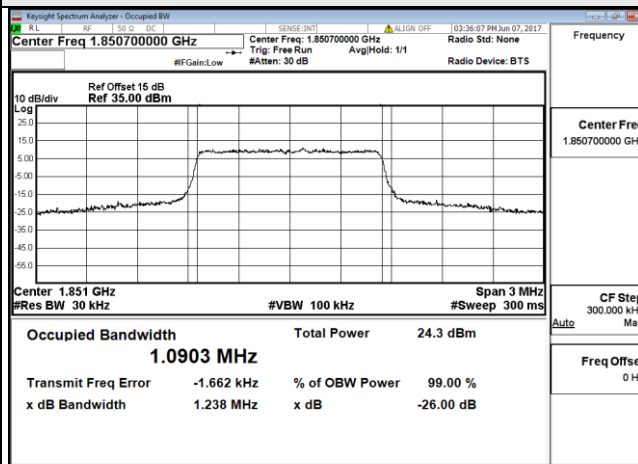

3MHz / QPSK

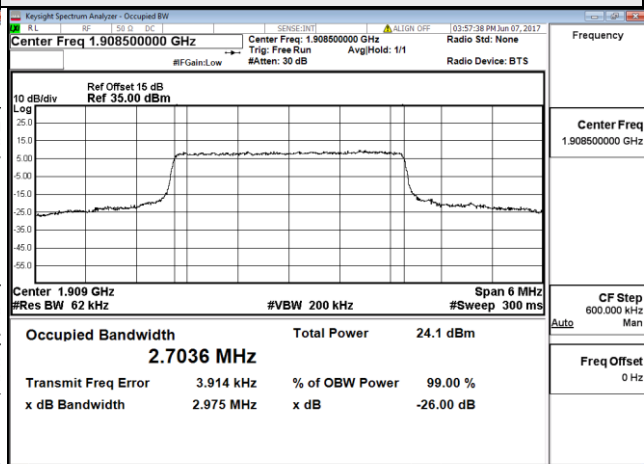

5MHz / QPSK

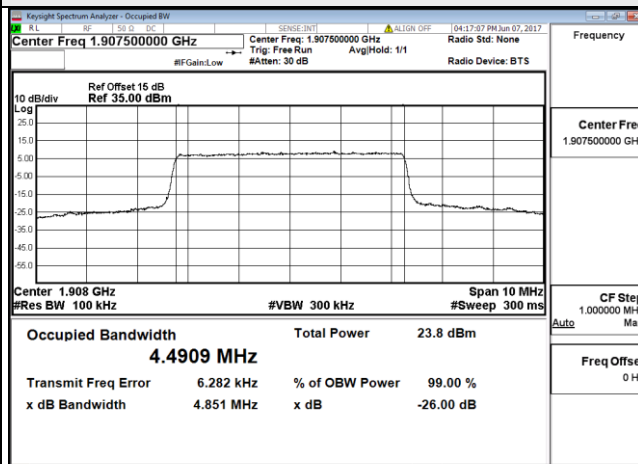

10MHz / QPSK

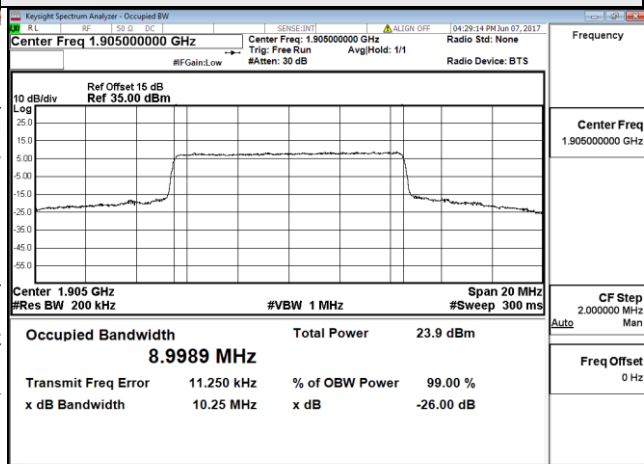

15MHz / QPSK

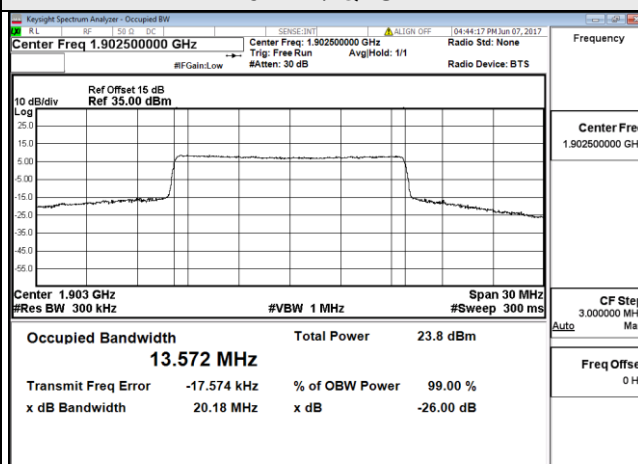

20MHz / QPSK

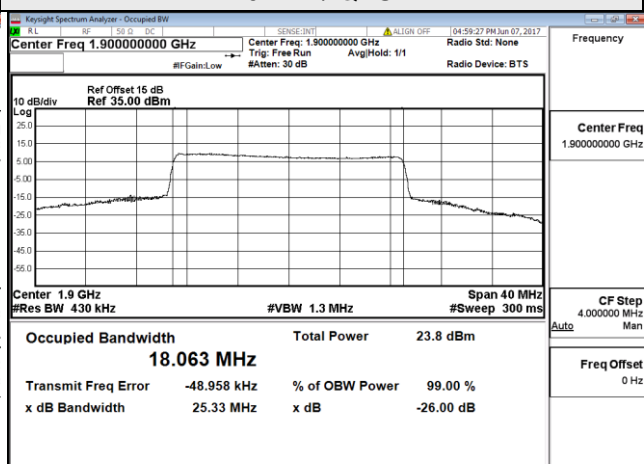

LTE Band 25							
Channel Bandwidth 1.4MHz				Channel Bandwidth 3MHz			
Channel	Frequency (MHz)	-26dB Bandwidth (MHz)		Channel	Frequency (MHz)	-26dB Bandwidth (MHz)	
		QPSK	16QAM			QPSK	16QAM
26047	1850.7	1.22	1.21	26055	1851.5	2.91	2.93
26365	1882.5	1.22	1.21	26365	1882.5	2.91	2.93
26683	1914.3	1.22	1.21	26675	1913.5	2.94	2.93
Channel Bandwidth 5MHz				Channel Bandwidth 10MHz			
Channel	Frequency (MHz)	-26dB Bandwidth (MHz)		Channel	Frequency (MHz)	-26dB Bandwidth (MHz)	
		QPSK	16QAM			QPSK	16QAM
26065	1852.5	4.82	4.81	26090	1855	9.50	9.53
26365	1882.5	4.80	4.80	26365	1882.5	9.51	9.52
26665	1912.5	4.82	4.81	26640	1910	9.51	9.53
Channel Bandwidth 15MHz				Channel Bandwidth 20MHz			
Channel	Frequency (MHz)	-26dB Bandwidth (MHz)		Channel	Frequency (MHz)	-26dB Bandwidth (MHz)	
		QPSK	16QAM			QPSK	16QAM
26615	1857.5	14.28	14.25	26140	1860	19.07	19.07
26365	1882.5	14.25	14.25	26365	1882.5	19.07	19.06
26615	1907.5	14.26	14.24	26590	1905	19.14	19.07

Spectrum Plot of Worst Value

1.4MHz / QPSK

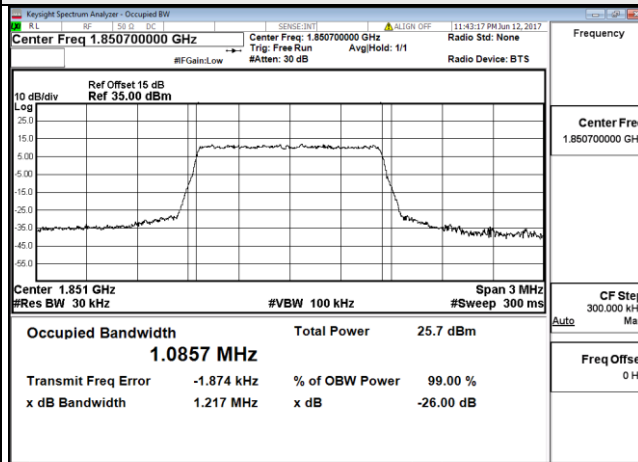

3MHz / QPSK

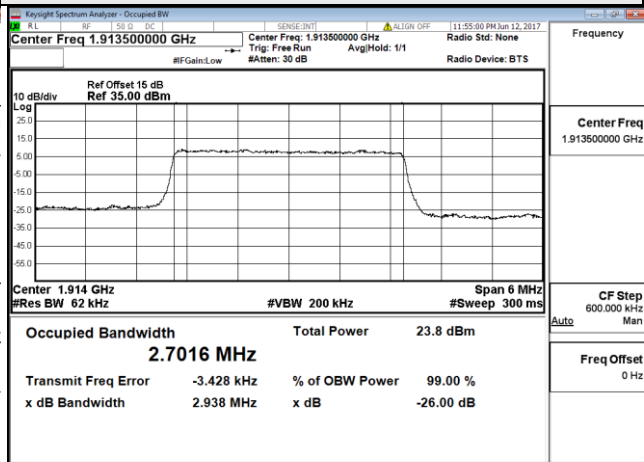

5MHz / QPSK

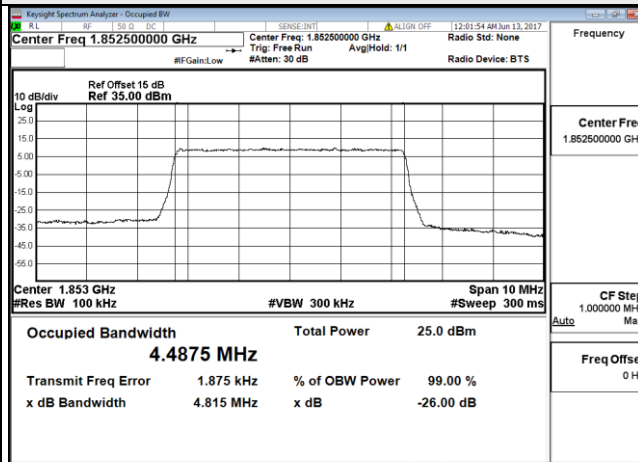

10MHz / 16QAM

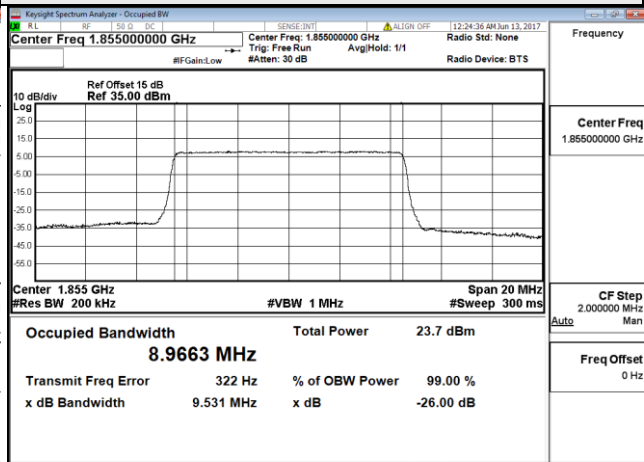

15MHz / QPSK

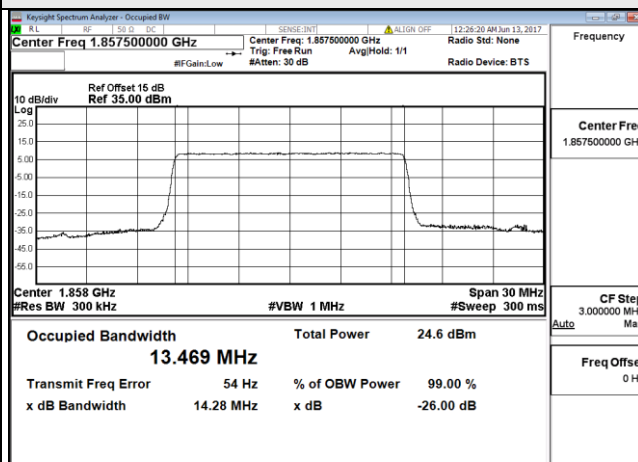

20MHz / QPSK

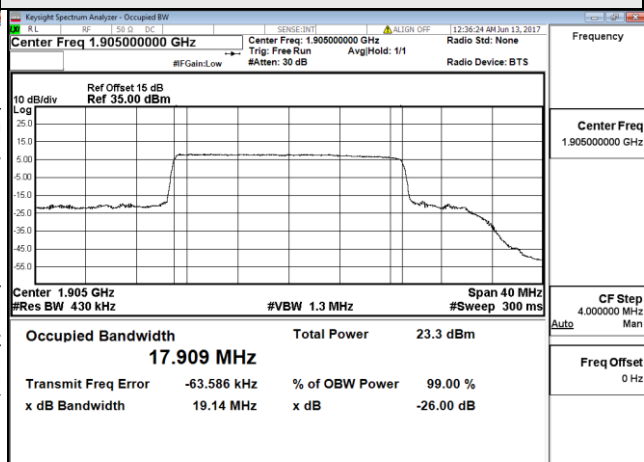

4.3.4 Test Result (Occupied Bandwidth, Subcontract Item)

Channel	FREQ. (MHz)	99% Occupied Bandwidth (MHz)
		WCDMA
9262	1852.4	4.20
9400	1880.0	4.18
9538	1907.6	4.20

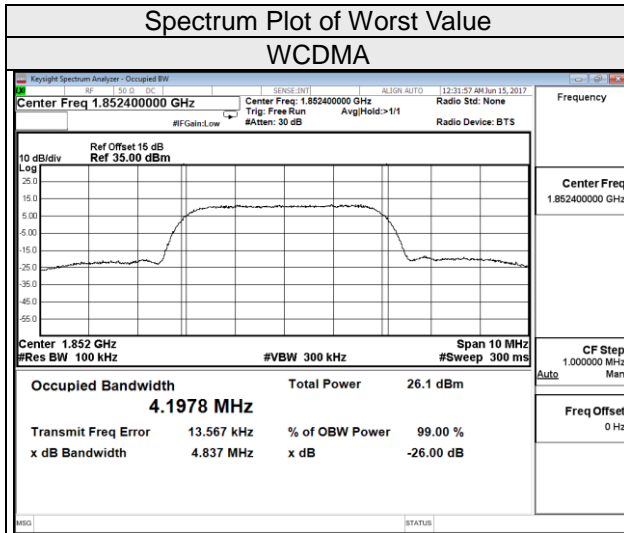

LTE Band 2							
Channel Bandwidth 1.4MHz				Channel Bandwidth 3MHz			
Channel	Frequency (MHz)	99% Occupied Bandwidth (MHz)		Channel	Frequency (MHz)	99% Occupied Bandwidth (MHz)	
		QPSK	16QAM			QPSK	16QAM
18607	1850.7	1.09	1.09	18615	1851.5	2.70	2.70
18900	1880	1.09	1.09	18900	1880	2.70	2.70
19193	1909.3	1.09	1.09	19185	1907.5	2.70	2.70
Channel Bandwidth 5MHz				Channel Bandwidth 10MHz			
Channel	Frequency (MHz)	99% Occupied Bandwidth (MHz)		Channel	Frequency (MHz)	99% Occupied Bandwidth (MHz)	
		QPSK	16QAM			QPSK	16QAM
18625	1852.5	4.49	4.49	18650	1855	8.97	8.97
18900	1880	4.49	4.49	18900	1880	8.98	8.98
19175	1907.5	4.49	4.49	19150	1905	9.00	8.99
Channel Bandwidth 15MHz				Channel Bandwidth 20MHz			
Channel	Frequency (MHz)	99% Occupied Bandwidth (MHz)		Channel	Frequency (MHz)	99% Occupied Bandwidth (MHz)	
		QPSK	16QAM			QPSK	16QAM
18675	1857.5	13.45	13.43	18700	1860	17.90	17.91
18900	1880	13.52	13.50	18900	1880	18.05	18.04
19125	1902.5	13.57	13.54	19100	1900	18.06	18.05

Spectrum Plot of Worst Value

1.4MHz / QPSK

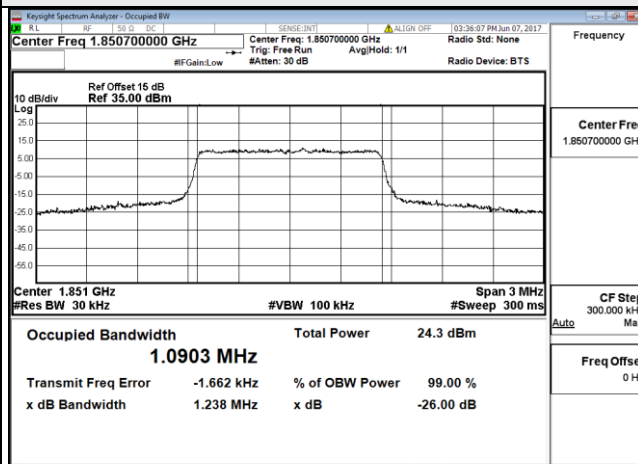

3MHz / QPSK

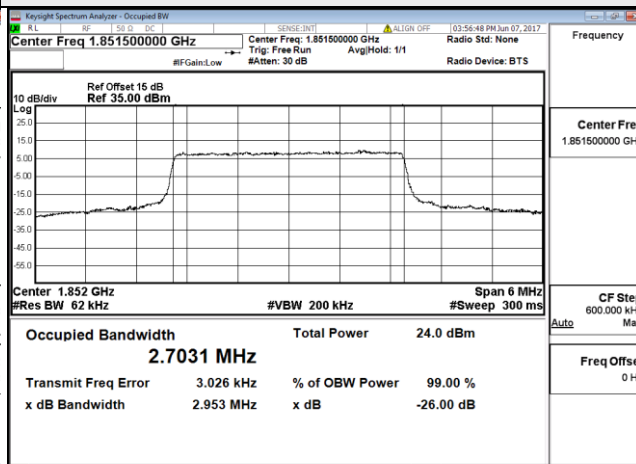

5MHz / QPSK

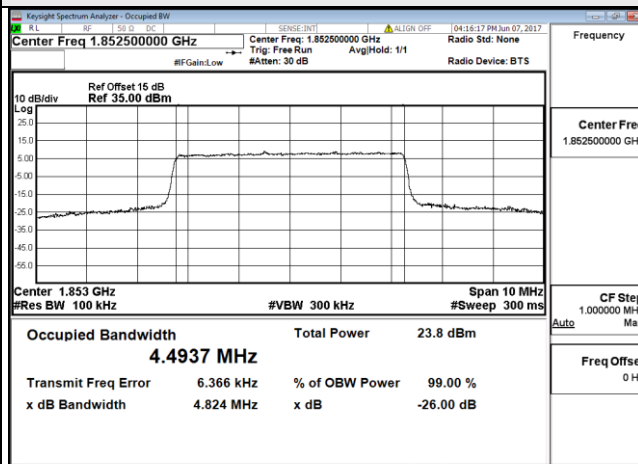

10MHz / QPSK

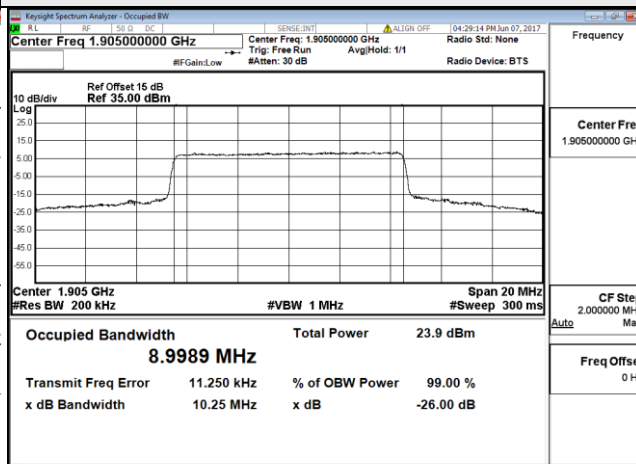

15MHz / QPSK

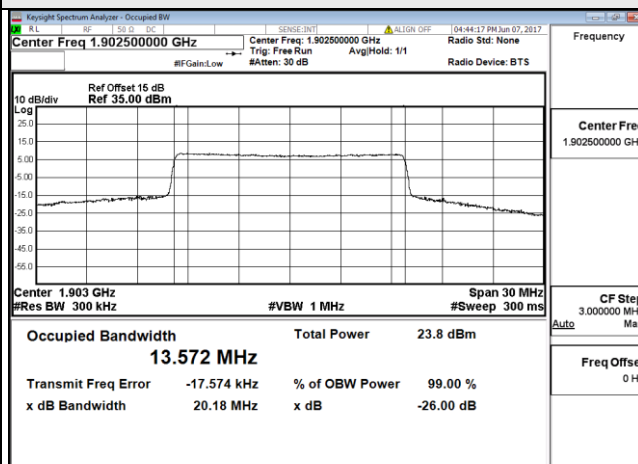

20MHz / QPSK

