

## FCC Test Report (Part 90S)

**Report No.:** RF170428E06-3

**FCC ID:** MCLT77W676

**Test Model:** T77W676

**Received Date:** Apr. 28, 2017

**Test Date:** June 12 to 27, 2017

**Issued Date:** July 27, 2017

**Applicant:** HON HAI PRECISION IND. CO., LTD.

**Address:** 5F-1,5 Hsin-An Road Hsinchu, Science-Based Industrial Park Taiwan,  
R.O.C.

**Issued By:** Bureau Veritas Consumer Products Services (H.K.) Ltd., Taoyuan Branch  
Hsin Chu Laboratory

**Lab Address:** E-2, No.1, Li Hsin 1st Road, Hsinchu Science Park, Hsinchu City 300,  
Taiwan R.O.C.

**Test Lab (A):** Bureau Veritas Consumer Products Services (H.K.) Ltd., Taoyuan Branch  
Hsin Chu Laboratory

**Test Location:** E-2, No.1, Li Hsin 1st Road, Hsinchu Science Park, Hsinchu City 300,  
Taiwan R.O.C.

**Test Lab (B):** Bureau Veritas Consumer Products Services (H.K.) Ltd., Taoyuan Branch  
Lin Kou Laboratories

**Test Location:** No.19, Hwa Ya 2nd Rd., Wen Hwa Vil., Kwei Shan Dist., Taoyuan City  
33383, TAIWAN (R.O.C.)



This report is for your exclusive use. Any copying or replication of this report to or for any other person or entity, or use of our name or trademark, is permitted only with our prior written permission. This report sets forth our findings solely with respect to the test samples identified herein. The results set forth in this report are not indicative or representative of the quality or characteristics of the lot from which a test sample was taken or any similar or identical product unless specifically and expressly noted. Our report includes all of the tests requested by you and the results thereof based upon the information that you provided to us. You have 60 days from date of issuance of this report to notify us of any material error or omission caused by our negligence, provided, however, that such notice shall be in writing and shall specifically address the issue you wish to raise. A failure to raise such issue within the prescribed time shall constitute your unqualified acceptance of the completeness of this report, the tests conducted and the correctness of the report contents. Unless specific mention, the uncertainty of measurement has been explicitly taken into account to declare the compliance or non-compliance to the specification. The report must not be used by the client to claim product certification, approval, or endorsement by any government agencies. This report contains all test data (Except Effective radiated power and Radiated Spurious Emissions) that was produced under subcontract by Bureau Veritas Consumer Products Services (H.K.) Ltd., Taoyuan Branch Lin Kou Laboratories.

## Table of Contents

<b>Release Control Record</b> .....	<b>3</b>
<b>1 Certificate of Conformity</b> .....	<b>4</b>
<b>2 Summary of Test Results</b> .....	<b>5</b>
2.1 Measurement Uncertainty .....	5
2.2 Test Site and Instruments .....	6
<b>3 General Information</b> .....	<b>10</b>
3.1 General Description of EUT .....	10
3.2 Configuration of System under Test .....	14
3.2.1 Description of Support Units .....	15
3.3 Test Mode Applicability and Tested Channel Detail .....	16
3.4 EUT Operating Conditions .....	18
3.5 General Description of Applied Standards .....	18
<b>4 Test Types and Results</b> .....	<b>19</b>
4.1 Output Power Measurement .....	19
4.1.1 Limits of Output Power Measurement and Antenna Height .....	19
4.1.2 Test Procedures .....	19
4.1.3 Test Setup .....	20
4.1.4 Test Results .....	21
4.2 Frequency Stability Measurement .....	24
4.2.1 Limits of Frequency Stability Measurement .....	24
4.2.2 Test Procedure .....	24
4.2.3 Test Setup .....	24
4.2.4 Test Results (Subcontract Item) .....	25
4.3 Occupied Bandwidth Measurement .....	26
4.3.1 Limits of Occupied Bandwidth Measurement .....	26
4.3.2 Test Procedure .....	26
4.3.3 Test Setup .....	26
4.3.4 Test Result (-26dB Bandwidth, Subcontract Item) .....	27
4.3.5 Test Result (Occupied Bandwidth, Subcontract Item) .....	28
4.4 Emission Mask Measurement .....	29
4.4.1 Limits of Emission Mask Measurement .....	29
4.4.2 Test Procedures .....	29
4.4.3 Test Setup .....	29
4.4.4 Test Results (Subcontract Item) .....	30
4.5 Conducted Spurious Emissions .....	38
4.5.1 Limits of Conducted Spurious Emissions Measurement .....	38
4.5.2 Test Setup .....	38
4.5.3 Test Procedure .....	38
4.5.4 Test Results (Subcontract Item) .....	39
4.6 Radiated Emission Measurement .....	40
4.6.1 Limits of Radiated Emission Measurement .....	40
4.6.2 Test Procedure .....	40
4.6.3 Deviation from Test Standard .....	40
4.6.4 Test Setup .....	41
4.6.5 Test Results .....	42
<b>5 Pictures of Test Arrangements</b> .....	<b>50</b>
<b>Appendix – Information on the Testing Laboratories</b> .....	<b>51</b>



### Release Control Record

Issue No.	Description	Date Issued
RF170428E06-3	Original release	July 27, 2017

## 1 Certificate of Conformity

**Product:** LTE Cat9 PCI Express M.2 Module

**Brand:** FOXCONN

**Test Model:** T77W676

**Sample Status:** ENGINEERING SAMPLE

**Applicant:** HON HAI PRECISION IND. CO., LTD.

**Test Date:** June 12 to 27, 2017

**Standards:** FCC Part 90, Subpart S  
FCC Part 2

The above equipment has been tested by **Bureau Veritas Consumer Products Services (H.K.) Ltd., Taoyuan Branch**, and found compliance with the requirement of the above standards. The test record, data evaluation & Equipment Under Test (EUT) configurations represented herein are true and accurate accounts of the measurements of the sample's EMC characteristics under the conditions specified in this report. This report contains all test data (Except Effective radiated power and Radiated Spurious Emissions) that was produced under subcontract by Bureau Veritas Consumer Products Services (H.K.) Ltd., Taoyuan Branch Lin Kou Laboratories.

**Prepared by :**  \_\_\_\_\_, **Date:** July 27, 2017  
Claire Kuan / Specialist

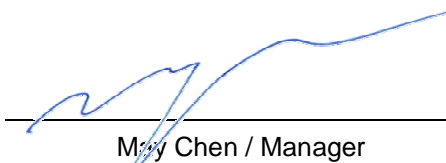
**Approved by :**  \_\_\_\_\_, **Date:** July 27, 2017  
May Chen / Manager

## 2 Summary of Test Results

Applied Standard: FCC Part 90 & Part 2			
FCC Clause	Test Item	Result	Remarks
2.1046 90.635 (b)	Radiated Power	PASS	Meet the requirement of limit.
2.1055 90.213	Frequency Stability	PASS	Meet the requirement of limit.
2.1049 90.209	Occupied Bandwidth	PASS	Meet the requirement of limit.
2.1051 90.691	Emission Mask	PASS	Meet the requirement of limit.
2.1051 90.691	Conducted Spurious Emissions	PASS	Meet the requirement of limit.
2.1053 90.691	Radiated Spurious Emissions	PASS	Meet the requirement of limit. Minimum passing margin is -35.63dB at 8190MHz.

### 2.1 Measurement Uncertainty

Where relevant, the following measurement uncertainty levels have been estimated for tests performed on the EUT as specified in CISPR 16-4-2:

Measurement	Frequency	Expanded Uncertainty (k=2) (±)
Radiated Emissions up to 1 GHz	30MHz ~ 1GHz	5.32 dB
Radiated Emissions above 1 GHz	1GHz ~ 6GHz	5.14 dB
	6GHz ~ 18GHz	5.04 dB
	18GHz ~ 40GHz	5.25 dB

## 2.2 Test Site and Instruments

### For radiated spurious emissions test:

DESCRIPTION & MANUFACTURER	MODEL NO.	SERIAL NO.	CALIBRATED DATE	CALIBRATED UNTIL
Test Receiver Agilent	N9038A	MY50010156	Aug. 18, 2016	Aug. 17, 2017
Pre-Amplifier <sup>(*)</sup> EMCI	EMC001340	980142	Jan. 20, 2016	Jan. 19, 2018
Loop Antenna <sup>(*)</sup> Electro-Metrics	EM-6879	264	Dec. 16, 2016	Dec. 15, 2018
RF Cable	NA	LOOPCAB-001 LOOPCAB-002	Jan. 17, 2017	Jan. 16, 2018
Pre-Amplifier Mini-Circuits	ZFL-1000VH2B	AMP-ZFL-05	May 06, 2017	May 05, 2018
Trilog Broadband Antenna SCHWARZBECK	VULB 9168	9168-361	Dec. 29, 2016	Dec. 28, 2017
RF Cable	8D	966-3-1 966-3-2 966-3-3	Apr. 01, 2017	Mar. 31, 2018
Fixed attenuator Mini-Circuits	UNAT-5+	PAD-3m-3-01	Oct. 05, 2016	Oct. 04, 2017
Horn_Antenna SCHWARZBECK	BBHA9120-D	9120D-406	Dec. 28, 2016	Dec. 27, 2017
Pre-Amplifier EMCI	EMC12630SE	980384	Feb. 02, 2017	Feb. 01, 2018
RF Cable	EMC104-SM-SM-1200 EMC104-SM-SM-2000 EMC104-SM-SM-5000	160922 150317 150322	Feb. 02, 2017 Mar. 29, 2017 Mar. 29, 2017	Feb. 01, 2018 Mar. 28, 2018 Mar. 28, 2018
Spectrum Analyzer Keysight	N9030A	MY54490520	July 29, 2016	July 28, 2017
Pre-Amplifier EMCI	EMC184045SE	980386	Feb. 02, 2017	Feb. 01, 2018
Horn_Antenna SCHWARZBECK	BBHA 9170	BBHA9170608	Dec. 15, 2016	Dec. 14, 2017
RF Cable	SUCOFLEX 102	36432/2 36433/2	Jan. 15, 2017	Jan. 14, 2018
Software	ADT_Radiated_V8.7.08	NA	NA	NA
Antenna Tower & Turn Table Max-Full	MF-7802	MF780208406	NA	NA
Boresight Antenna Fixture	FBA-01	FBA-SIP01	NA	NA

#### Note:

1. The calibration interval of the above test instruments is 12 months and the calibrations are traceable to NML/ROC and NIST/USA.
2. \*The calibration interval of the above test instruments is 24 months and the calibrations are traceable to NML/ROC and NIST/USA.
3. The test was performed in 966 Chamber No. 3.
4. The FCC Site Registration No. is 147459
5. The CANADA Site Registration No. is 20331-1
6. Tested Date: June 27, 2017



**For Radiated power test:**

DESCRIPTION & MANUFACTURER	MODEL NO.	SERIAL NO.	CALIBRATED DATE	CALIBRATED UNTIL
Spectrum Analyzer R&S	FSV40	100964	June 28, 2016	June 27, 2017
Spectrum Analyzer Keysight	N9030A	MY54490570	July 06, 2016	July 05, 2017
AC Power Source Extech Electronics	6502	1140503	NA	NA
Temperature & Humidity Chamber TERCHY	MHU-225AU	911033	Dec. 02, 2016	Dec. 01, 2017
DC Power Supply GOOD WILL INSTRUMENT CO., LTD.	GPC - 3030D	7700087	NA	NA
ESG Vector signal generator Agilent	E4438C	Y45094468/005 506 602 UK6 UNJ	Nov. 25, 2016	Nov. 24, 2017
Power meter Anritsu	ML2495A	1014008	May 11, 2017	May 10, 2018
Power sensor Anritsu	MA2411B	0917122	May 11, 2017	May 10, 2018
Software	ADT_RF Test Software V6.6.5.4	NA	NA	NA
Digital Multimeter FLUKE	87III	73680266	Nov. 10, 2016	Nov. 09, 2017

- NOTE:**
1. The test was performed in Oven room 1.
  2. The calibration interval of the above test instruments is 12 months and the calibrations are traceable to NML/ROC and NIST/USA.
  3. Tested Date: June 23, 2017

**For other test items:**

Description & Manufacturer	Model No.	Serial No.	Cal. Date	Cal. Due
Test Receiver ROHDE & SCHWARZ	ESIB7	100187	May 02, 2017	May 01, 2018
Spectrum Analyzer ROHDE & SCHWARZ	FSP40	100041	Nov. 16, 2016	Nov. 15, 2017
BILOG Antenna SCHWARZBECK	VULB9168	9168-171	Dec. 28, 2016	Dec. 27, 2017
HORN Antenna SCHWARZBECK	9120D	209	Dec. 27, 2016	Dec. 26, 2017
HORN Antenna SCHWARZBECK	BBHA 9170	BBHA9170241	Dec. 14, 2016	Dec. 13, 2017
Preamplifier Agilent	8447D	2944A10738	Aug. 22, 2016	Aug. 21, 2017
Preamplifier Agilent	8449B	3008A01963	Aug. 22, 2016	Aug. 21, 2017
RF signal cable HUBER+SUHNER	SUCOFLEX 104	Cable-CH3-03 (214378)	Aug. 22, 2016	Aug. 21, 2017
RF signal cable HUBER+SUHNER	SUCOFLEX 106	Cable-CH3-03 (309224+12738)	Aug. 22, 2016	Aug. 21, 2017
Software BV ADT	ADT_Radiated_ V7.6.15.9.4	NA	NA	NA
Antenna Tower inn-co GmbH	MA 4000	013303	NA	NA
Antenna Tower Controller BV ADT	AT100	AT93021702	NA	NA
Turn Table BV ADT	TT100	TT93021702	NA	NA
Turn Table Controller BV ADT	SC100	SC93021702	NA	NA
WIT Standard Temperature And Humidity Chamber	TH-4S-C	W981030	Jun. 07, 2017	Jun. 06, 2018
Mini-Circuits Power Splitter	ZN2PD-9G	NA	Aug. 11, 2016	Aug. 10, 2017
JFW 20dB attenuation	50HF-020-SMA	NA	NA	NA

- Note: 1. The calibration interval of the above test instruments is 12 months and the calibrations are traceable to NML/ROC and NIST/USA.  
2. The test was performed in HwaYa Chamber 3.  
3. The horn antenna and preamplifier (model: 8449B) are used only for the measurement of emission frequency above 1GHz if tested.  
4. The FCC Site Registration No. is 988962.  
5. The IC Site Registration No. is IC 7450F-3.  
6. Tested Date: June 12 to 15, 2017





**For other test items:**

Description & Manufacturer	Model No.	Serial No.	Cal. Date	Cal. Due
Test Receiver ROHDE & SCHWARZ	ESIB7	100187	May 02, 2017	May 01, 2018
Spectrum Analyzer ROHDE & SCHWARZ	FSP40	100041	Nov. 16, 2016	Nov. 15, 2017
BILOG Antenna SCHWARZBECK	VULB9168	9168-171	Dec. 28, 2016	Dec. 27, 2017
HORN Antenna SCHWARZBECK	9120D	209	Dec. 27, 2016	Dec. 26, 2017
HORN Antenna SCHWARZBECK	BBHA 9170	BBHA9170241	Dec. 14, 2016	Dec. 13, 2017
Preamplifier Agilent	8447D	2944A10738	Oct.18, 2015	Oct. 17, 2016
Preamplifier Agilent	8449B	3008A01963	Aug. 22, 2016	Aug. 21, 2017
RF signal cable HUBER+SUHNER	SUCOFLEX 104	Cable-CH3-03 (214378)	Aug. 22, 2016	Aug. 21, 2017
RF signal cable HUBER+SUHNER	SUCOFLEX 106	Cable-CH3-03 (309224+12738)	Aug. 22, 2016	Aug. 21, 2017
Software BV ADT	ADT_Radiated_ V7.6.15.9.4	NA	NA	NA
Antenna Tower inn-co GmbH	MA 4000	013303	NA	NA
Antenna Tower Controller BV ADT	AT100	AT93021702	NA	NA
Turn Table BV ADT	TT100	TT93021702	NA	NA
Turn Table Controller BV ADT	SC100	SC93021702	NA	NA
WIT Standard Temperature And Humidity Chamber	TH-4S-C	W981030	Jun. 07, 2017	Jun. 06, 2018
Mini-Circuits Power Splitter	ZN2PD-9G	NA	Aug. 11, 2016	Aug. 10, 2017
JFW 20dB attenuation	50HF-020-SMA	NA	NA	NA

- Note: 1. The calibration interval of the above test instruments is 12 months and the calibrations are traceable to NML/ROC and NIST/USA.  
2. The test was performed in HwaYa Chamber 3.  
3. The horn antenna and preamplifier (model: 8449B) are used only for the measurement of emission frequency above 1GHz if tested.  
4. The FCC Site Registration No. is 988962.  
5. The IC Site Registration No. is IC 7450F-3.  
6. Tested Date: June 23 to July 07, 2017

### 3 General Information

#### 3.1 General Description of EUT

Product	LTE Cat9 PCI Express M.2 Module	
Brand	FOXCONN	
Test Model	T77W676	
Status of EUT	ENGINEERING SAMPLE	
Power Supply Rating	DC 5V from host equipment	
Modulation Type	QPSK, 16QAM	
Operating Frequency	LTE Band 26	814.7MHz ~ 823.3MHz
Max. ERP Power	LTE Band 26 (Channel Bandwidth 1.4MHz)	168.66mW (22.27dBm)
	LTE Band 26 (Channel Bandwidth 3MHz)	180.30mW (22.56dBm)
	LTE Band 26 (Channel Bandwidth 5MHz)	182.39mW (22.61dBm)
	LTE Band 26 (Channel Bandwidth 10MHz)	169.82mW (22.30dBm)
Emission Designator	LTE Band 26	Channel Bandwidth 1.4MHz QPSK: 1M09G7D 16QAM: 1M09D7W
		Channel Bandwidth 3MHz QPSK: 2M70G7D 16QAM: 2M70D7W
		Channel Bandwidth 5MHz QPSK: 4M49G7D 16QAM: 4M49D7W
		Channel Bandwidth 10MHz QPSK: 8M97G7D 16QAM: 8M96D7W
Antenna Type	Refer to note as below	
Antenna Connector	Refer to note as below	
Accessory Device	NA	
Data Cable Supplied	NA	

Note:

1. The EUT is a WWAN device.
2. The antennas provided to the EUT, please refer to the following table:

Antenna NO.	Brand	Model	Gain(dBi) Including cable loss	Frequency range	Antenna Type	Connecter Type	Cable Length
1	TongDa	T-543-8201115-2	3.08 4.74	791~960MHz 1447.9~1606MHz	PIFA	I-PEX MHF IV	100mm
2	TongDa	T-543-8201115-1	4.17	698~803MHz	PIFA	I-PEX MHF IV	100mm
3	TongDa	T-543-8201115-3	5.99	1710~2700MHz	PIFA	I-PEX MHF IV	100mm
4	HongBo	260-23671	-1.33	703-748MHz	PIFA	I-PEX MHF IV	315mm
			-3.23	815-830MHz			
			-3.37	832-862MHz			
			-2.27	824-849MHz			
			-3.11	880-915MHz			
			-4.15	1448-1463MHz			
			-0.64	1710-1785MHz			
			0.18	1850-1915MHz			
	0.57	1920-1980MHz					
	HongBo	260-23672	-3.71	758-803MHz	PIFA	I-PEX MHF IV	439mm
			-0.95	860-875MHz			
			-3.07	791-821MHz			
			-0.97	869-894MHz			
			-3.5	925-960MHz			
			-5.32	1496-1511MHz			
-0.09			1805-1880MHz				
0.16	1930-1995MHz						
-0.8	2110-2170MHz						

Antenna NO.	Brand	Model	Gain(dBi) Including cable loss	Frequency range	Antenna Type	Connecter Type	Cable Length
5	SPEED	F.0G.UH-6010-003-00	-2.81	703-748MHz	PIFA	I-PEX MHF IV	315mm
			-1.53	815-830MHz			
			-1.96	832-862MHz			
			-2.59	880-915MHz			
			-4.19	1448-1463MHz			
			1.23	1710-1785MHz			
			0.26	1850-1883MHz			
			1.16	1915-1980MHz			
	SPEED	F.0G.UH-6010-004-00	-2.67	758-803MHz	PIFA	I-PEX MHF IV	439mm
			-2.42	791-821MHz			
			-2.33	860-894MHz			
			-0.58	925-960MHz			
			-0.17	1496-1511MHz			
			0.83	1805-1880MHz			
6	HongBo	260-23675	-2.68	703-748MHz	PIFA	I-PEX MHF IV	363mm
			-0.88	815-830MHz			
			-1.66	832-862MHz			
			-1.23	824-849MHz			
			1.35	880-915MHz			
			0.8	1448-1463MHz			
			2.03	1710-1785MHz			
			2.02	1850-1915MHz			
	0.57	1920-1980MHz					
	HongBo	260-23676	-2.86	758-803MHz	PIFA	I-PEX MHF IV	522mm
			0.51	860-875MHz			
			-1.19	791-821MHz			
			0.48	869-894MHz			
			-2.29	925-960MHz			
-4.52			1496-1511MHz				
-0.09	1805-1880MHz						
-0.22	1930-1995MHz						
-0.42	2110-2170MHz						

Antenna NO.	Brand	Model	Gain(dBi) Including cable loss	Frequency range	Antenna Type	Connecter Type	Cable Length
7	SPEED	F.0G.UH-6011-003-00	-3.21	703-748MHz	PIFA	I-PEX MHF IV	363mm
			-2.73	815-830MHz			
			-2.48	832-862MHz			
			-3.32	880-915MHz			
			-1.86	1448-1463MHz			
			-0.57	1710-1785MHz			
			-0.63	1850-1883MHz			
			0.44	1915-1980MHz			
	SPEED	F.0G.UH-6011-004-00	-4	758-803MHz	PIFA	I-PEX MHF IV	522mm
			-3.43	791-821MHz			
			-1.22	860-894MHz			
			-2.06	925-960MHz			
			-1.83	1496-1511MHz			
			0.48	1805-1880MHz			
-0.2	1930-1995MHz						
			-2.87	2110-2170MHz			

**Set 1~3** were chosen for final test.

3. The above EUT information is declared by manufacturer and for more detailed features description, please refer to the manufacturer's specifications or user's manual.

### 3.2 Configuration of System under Test

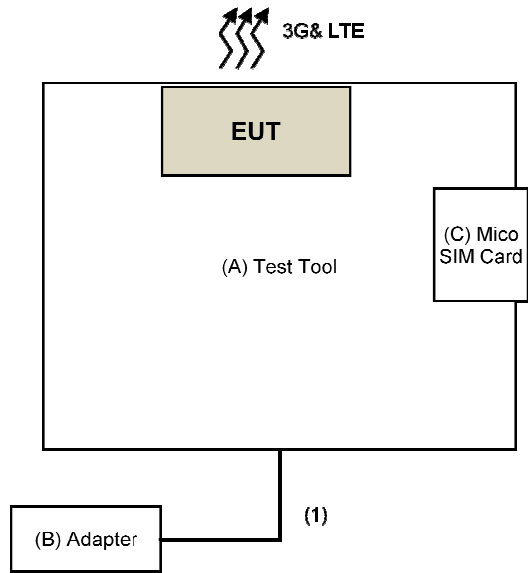

---

**Remote Site**





### 3.2.1 Description of Support Units

The EUT has been tested as an independent unit together with other necessary accessories or support units. The following support units or accessories were used to form a representative test configuration during the tests.

ID	Product	Brand	Model No.	Serial No.	FCC ID	Remarks
A.	Test Tool	Foxconn	NA	NA	NA	Supplied by client
B.	USB Adapter	ASUS	EXA1205UA	NA	NA	Provided by Lab
C.	Mico SIM Card	NA	NA	NA	NA	Provided by Lab
D.	LTE Simulator	Keysight	E7515-10910	NA	NA	Provided by Lab

Note:

1. All power cords of the above support units are non-shielded (1.8m).

ID	Descriptions	Qty.	Length (m)	Shielding (Yes/No)	Cores (Qty.)	Remarks
1.	USB Cable	1	1	Yes	0	Supplied by client

### 3.3 Test Mode Applicability and Tested Channel Detail

Pre-Scan has been conducted to determine the worst-case mode from all possible combinations between available modulations, data rates, XYZ axis and antenna ports

The worst case was found when positioned on X-plane. Following channel(s) was (were) selected for the final test as listed below:

TEST ITEM	AVAILABLE CHANNEL	TESTED CHANNEL	CHANNEL BANDWIDTH	MODULATION	MODE	
ERP	26697 to 26783	26697, 26740, 26783	1.4MHz	QPSK	1RB / 0 RB offset	
	26705 to 26775	26705, 26740, 26775	3MHz	QPSK	1RB / 0 RB offset	
	26715 to 26765	26715, 26740, 26765	5MHz	QPSK	1RB / 0 RB offset	
	26740	26740	10MHz	QPSK	1RB / 0 RB offset	
Frequency Stability	26697 to 26783	26740	1.4MHz	QPSK	-	
	26705 to 26775	26740	3MHz	QPSK	-	
	26715 to 26765	26740	5MHz	QPSK	-	
	26740	26740	10MHz	QPSK	-	
Occupied Bandwidth	26697 to 26783	26697, 26740, 26783	1.4MHz	QPSK, 16QAM	Full RB	
	26705 to 26775	26705, 26740, 26775	3MHz	QPSK, 16QAM	Full RB	
	26715 to 26765	26715, 26740, 26765	5MHz	QPSK, 16QAM	Full RB	
	26740	26740	10MHz	QPSK, 16QAM	Full RB	
Emission Mask	26697 to 26783	26697	1.4MHz	QPSK, 16QAM	1 RB / 0 RB Offset	
		26783			1 RB / 5 RB Offset	
		26697, 26783			6 RB / 0 RB Offset	
	26705 to 26775	26705	3MHz	QPSK, 16QAM	1 RB / 0 RB Offset	
		26775			1 RB / 14 RB Offset	
		26705, 26775			15 RB / 0 RB Offset	
	26715 to 26765	26715	5MHz	QPSK, 16QAM	1 RB / 0 RB Offset	
		26765			1 RB / 24 RB Offset	
		26715, 26765			25 RB / 0 RB Offset	
	26740	26740	10MHz	QPSK, 16QAM	1 RB / 0 RB Offset	
	Conducuted Emission	26697 to 26783	26740	1.4MHz	QPSK	1RB / 0 RB offset
		26705 to 26775	26740	3MHz	QPSK	1RB / 0 RB offset
26715 to 26765		26740	5MHz	QPSK	1RB / 0 RB offset	
26740		26740	10MHz	QPSK	1RB / 0 RB offset	
Radiated Emission	26697 to 26783	26740	1.4MHz	QPSK	1RB / 0 RB offset	
	26705 to 26775	26740	3MHz	QPSK	1RB / 0 RB offset	
	26715 to 26765	26740	5MHz	QPSK	1RB / 0 RB offset	
	26740	26740	10MHz	QPSK	1RB / 0 RB offset	

**NOTE:**

All supported modulation types were evaluated. The Worst case of QPSK was selected. Therefore, the Output power, Frequency Stability, Conducuted Emission and Radiated Emission were presented under QPSK mode only.





**Test Condition:**

Test Item	Environmental Conditions	Input Power	Tested By
Output Power	25deg. C, 63%RH	120Vac, 60Hz	Gary Cheng
Frequency Stability	25deg. C, 63%RH	120Vac, 60Hz	Gary Cheng
Emission Bandwidth	25deg. C, 63%RH	120Vac, 60Hz	Gary Cheng
Emission Mask	25deg. C, 63%RH	120Vac, 60Hz	Gary Cheng
Conducted Emission	25deg. C, 63%RH	120Vac, 60Hz	Gary Cheng
Radiated Emission	20deg. C, 62%RH 24deg. C, 64%RH	120Vac, 60Hz	JyunChun Lin
	20deg. C, 62%RH 24deg. C, 64%RH	120Vac, 60Hz	JyunChun Lin



### **3.4 EUT Operating Conditions**

The communication simulator station system controlled a EUT to export maximum output power under transmission mode and specific channel frequency.

### **3.5 General Description of Applied Standards**

The EUT is a RF Product. According to the specifications of the manufacturer, it must comply with the requirements of the following standards:

**FCC 47 CFR Part 2**

**FCC 47 CFR Part 90**

**KDB 971168 D01 Power Meas License Digital Systems v02r02**

**ANSI/TIA/EIA-603-D 2010**

All test items have been performed and recorded as per the above standards.

## 4 Test Types and Results

### 4.1 Output Power Measurement

#### 4.1.1 Limits of Output Power Measurement and Antenna Height

The maximum output power of the transmitter for mobile stations is 100 watts (20 dBw).

#### 4.1.2 Test Procedures

##### Conducted Power Measurement:

The EUT was set up for the maximum power with WCDMA & LTE link data modulation and link up with simulator. Set the EUT to transmit under low, middle and high channel and record the power level shown on simulator.

##### EIRP / ERP Measurement:

- a. All measurements were done at low, middle and high operational frequency range. Set the  $RBW \geq OBW$  and  $VBW \geq 3 \times RBW$ .
- b. Substitution method is used for EIRP measurement. In the semi-anechoic chamber, EUT placed on the 0.8m/1.5m height of Turn Table, rotated the table around 360 degrees to search the maximum radiation power and receiver antenna shall be rotated vertical and horizontal polarization and moved height from 1m to 4m to find the maximum polar radiated power. The "Read Value" is the spectrum reading the maximum power value.
- c. The substitution antenna is substituted for EUT at the same position and signals generator export the CW signal to the substitution antenna via a TX cable. Rotated the Turn Table and moved receiving antenna to find the maximum radiation power. Adjust output power level of S.G to get a Value of spectrum reading equal to "Read Value" of step b. Record the power level of S.G
- d.  $EIRP = \text{Output power level of S.G} - \text{TX cable loss} + \text{Antenna gain of substitution antenna}$ .
- e. ERP power can be calculated form EIRP power by subtracting the gain of dipole,  $ERP \text{ power} = EIPR \text{ power} - 2.15\text{dBi}$ .

Note: The worst case vertical or horizontal polarization have been investigated and reported in this report.

### 4.1.3 Test Setup

CONDUCTED POWER MEASUREMENT:

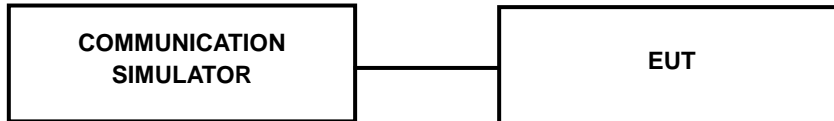

ERP/EIRP MEASUREMENT:

For ERP/EIRP below 1GHz

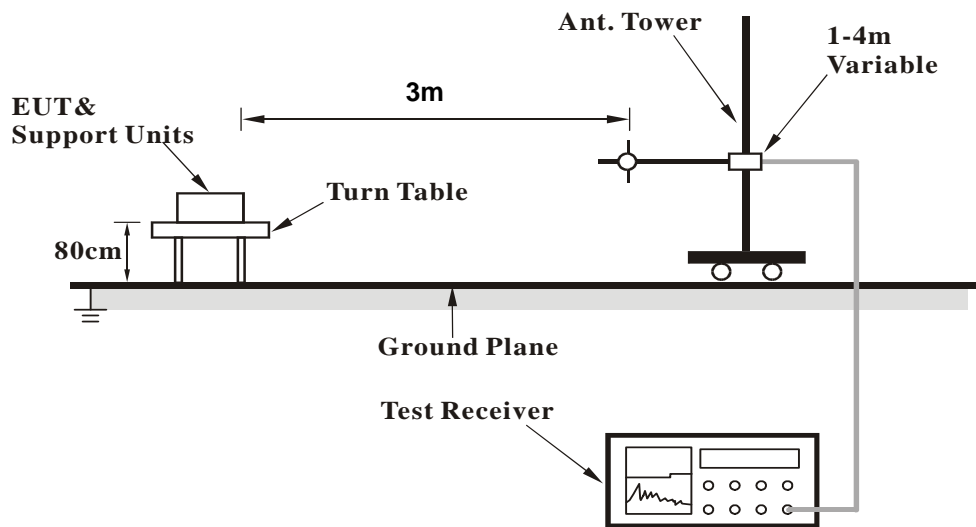

For ERP/EIRP above 1GHz

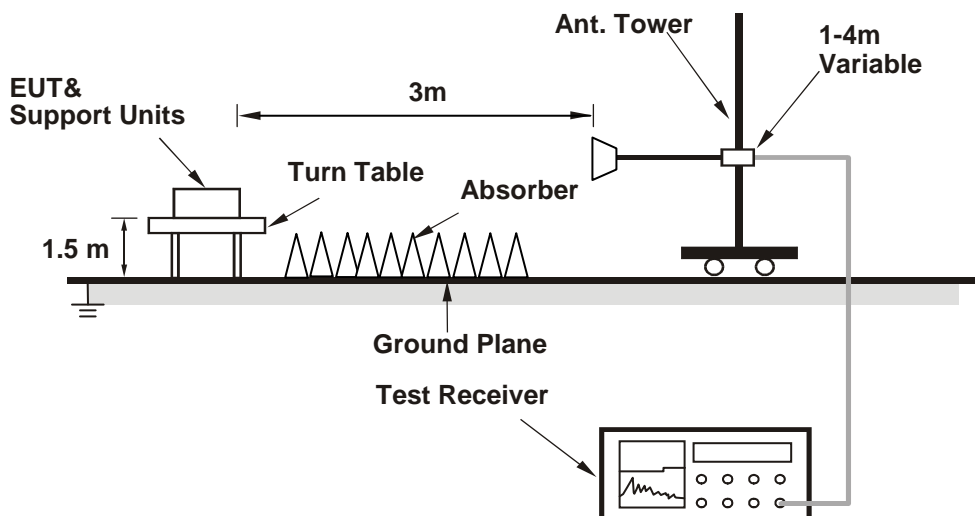

For the actual test configuration, please refer to the attached file (Test Setup Photo).

#### 4.1.4 Test Results

### CONDUCTED OUTPUT POWER

(Subcontract Item)

#### LTE Band 26

Band / BW	RB Size	RB Offset	QPSK			3GPP MPR (dB)	16QAM			3GPP MPR (dB)
			Low CH	Mid CH	High CH		Low CH	Mid CH	High CH	
			26697	26740	26783		26697	26740	26783	
			814.7 MHz	819 MHz	823.3 MHz		814.7 MHz	819 MHz	823.3 MHz	
26 / 1.4M	1	0	23.06	23.01	23.03	0	21.95	21.97	21.86	1
	1	2	23.03	22.73	22.88	0	21.84	22.81	22.78	1
	1	5	23.01	22.59	22.76	0	21.70	22.74	22.78	1
	3	0	22.74	22.67	22.71	0	21.73	22.79	22.78	1
	3	1	22.69	22.51	22.58	0	21.68	22.53	22.56	1
	3	3	22.68	22.64	22.52	0	21.60	22.76	22.53	1
	6	0	21.71	21.59	21.71	1	20.66	21.77	21.71	2

Band / BW	RB Size	RB Offset	QPSK			3GPP MPR (dB)	16QAM			3GPP MPR (dB)
			Low CH	Mid CH	High CH		Low CH	Mid CH	High CH	
			26705	26740	26775		26705	26740	26775	
			815.50 MHz	819.00 MHz	822.50 MHz		815.50 MHz	819.00 MHz	822.50 MHz	
26 / 3M	1	0	23.09	23.13	23.11	0	22.00	22.05	21.94	1
	1	7	23.03	22.94	23.02	0	21.90	22.89	22.77	1
	1	14	23.01	22.96	22.91	0	21.80	22.72	22.67	1
	8	0	21.97	21.84	22.06	1	20.98	21.79	21.97	2
	8	3	21.93	21.94	22.00	1	20.89	22.01	21.92	2
	8	7	21.91	21.94	22.15	1	20.85	21.98	21.98	2
	15	0	21.86	21.71	22.13	1	20.82	21.70	21.77	2

Band / BW	RB Size	RB Offset	QPSK			3GPP MPR (dB)	16QAM			3GPP MPR (dB)
			Low CH	Mid CH	High CH		Low CH	Mid CH	High CH	
			26715	26740	26765		26715	26740	26765	
			816.50	819.00	821.50		816.50	819.00	821.50	
			MHz	MHz	MHz		MHz	MHz	MHz	
26 / 5M	1	0	23.09	23.08	23.17	0	22.09	22.06	22.07	1
	1	12	23.07	22.96	23.04	0	22.02	23.07	22.95	1
	1	24	23.05	22.89	22.88	0	21.86	22.81	22.83	1
	12	0	22.12	21.98	22.18	1	21.10	22.14	22.06	2
	12	6	22.09	22.14	22.05	1	21.04	21.98	21.92	2
	12	13	22.06	22.14	21.88	1	21.00	22.00	21.99	2
	25	0	22.01	21.93	22.10	1	20.98	22.02	22.03	2

Band / BW	RB Size	RB Offset	QPSK		3GPP MPR (dB)	16QAM		3GPP MPR (dB)
			Low CH			Low CH		
			26740			26740		
			819			819		
			MHz			MHz		
26/ 10M	1	0	23.15		0	22.17		1
	1	24	23.10		0	22.09		1
	1	49	23.03		0	21.97		1
	25	0	22.27		1	21.26		2
	25	12	22.23		1	21.18		2
	25	25	22.19		1	21.15		2
	50	0	22.17		1	21.13		2

## ERP POWER

### LTE Band 26 / 1.4M

Channel	Frequency (MHz)	Antenna Polarization	LVL (dBm)	Correction Factor(dB)	ERP(dBm)	ERP(mW)
26697	814.7	H	20.77	1.30	22.07	161.06
26740	819	H	21.10	1.17	22.27	168.66
26783	823.3	H	21.19	1.05	22.24	167.49

Note: The worst case vertical or horizontal polarization have been investigated and find the worst is horizontal.

### LTE Band 26 / 3M

Channel	Frequency (MHz)	Antenna Polarization	LVL (dBm)	Correction Factor(dB)	ERP(dBm)	ERP(mW)
26705	815.5	H	20.84	1.29	22.13	163.31
26740	819	H	21.39	1.17	22.56	180.30
26775	822.5	H	21.29	1.06	22.35	171.79

Note: The worst case vertical or horizontal polarization have been investigated and find the worst is horizontal.

### LTE Band 26 / 5M

Channel	Frequency (MHz)	Antenna Polarization	LVL (dBm)	Correction Factor(dB)	ERP(dBm)	ERP(mW)
26715	816.5	H	20.96	1.28	22.24	167.49
26740	819	H	21.44	1.17	22.61	182.39
26765	821.5	H	21.39	1.07	22.46	176.20

Note: The worst case vertical or horizontal polarization have been investigated and find the worst is horizontal.

### LTE Band 26 / 10M

Channel	Frequency (MHz)	Antenna Polarization	LVL (dBm)	Correction Factor(dB)	ERP(dBm)	ERP(mW)
26740	819	H	21.05	1.25	22.30	169.82

Note: The worst case vertical or horizontal polarization have been investigated and find the worst is horizontal.

## 4.2 Frequency Stability Measurement

### 4.2.1 Limits of Frequency Stability Measurement

1.5 ppm is for base and fixed station. 2.5 ppm is for mobile station.

### 4.2.2 Test Procedure

- Device is placed at the oven room. The oven room could control the temperatures and humidity. Power warm up is at least 15 min and power applied should perform before recording frequency error.
- EUT is connected the external power supply to control the DC input power. The test voltage range is from minimum to maximum working voltage. Each step shall be record the frequency error rate.
- The temperature range step is 10 degrees in this test items. All temperature levels shall be hold the  $\pm 0.5$  °C during the measurement testing. The each temperature step shall be at least 0.5 hours, consider the EUT could be test under the stability condition.

### 4.2.3 Test Setup

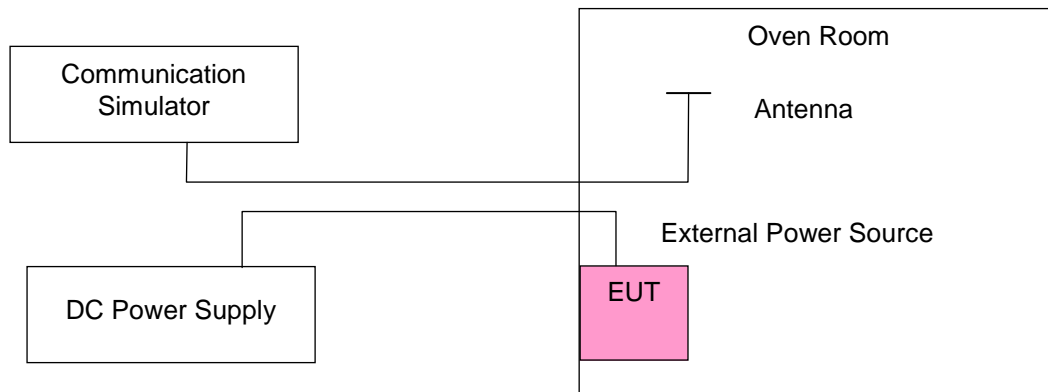



#### 4.2.4 Test Results (Subcontract Item)

##### Frequency Error vs. Voltage

Voltage (Volts)	Frequency Error (ppm)				Limit (ppm)
	LTE Band 26				
	1.4MHz	3MHz	5MHz	10MHz	
3.3	0.002	0.002	0.001	0.004	2.5
2.805	0.001	0.002	0.002	0.003	2.5
3.795	0.003	0.004	0.002	0.004	2.5

##### Frequency Error vs. Temperature

Temp. (°C)	Frequency Error (ppm)				Limit (ppm)
	LTE Band 26				
	1.4MHz	3MHz	5MHz	10MHz	
-30	0.004	0.002	0.004	0.003	2.5
-20	0.003	0.002	0.002	0.005	2.5
-10	0.005	0.004	0.003	0.005	2.5
0	0.004	0.003	0.002	0.004	2.5
10	0.002	0.004	0.005	0.004	2.5
20	-0.003	-0.002	-0.004	-0.003	2.5
30	-0.004	-0.002	-0.003	-0.002	2.5
40	-0.002	-0.004	-0.004	-0.004	2.5
50	-0.005	-0.002	-0.004	-0.001	2.5

### 4.3 Occupied Bandwidth Measurement

#### 4.3.1 Limits of Occupied Bandwidth Measurement

The width of a frequency band such that, below the lower and above the upper frequency limits, the mean powers emitted are each equal to a specified percentage 0.5 % of the total mean power of a given emission.

#### 4.3.2 Test Procedure

All measurements were done at low, middle and high operational frequency range, RB of the spectrum is 1% of occupied bandwidth and VB of the spectrum is 3 times RBW. The communication simulator station system controlled a EUT to export maximum output power under transmission mode and specific channel frequency. Use OBW measurement function of Spectrum analyzer to measure 99 % occupied bandwidth.

#### 4.3.3 Test Setup

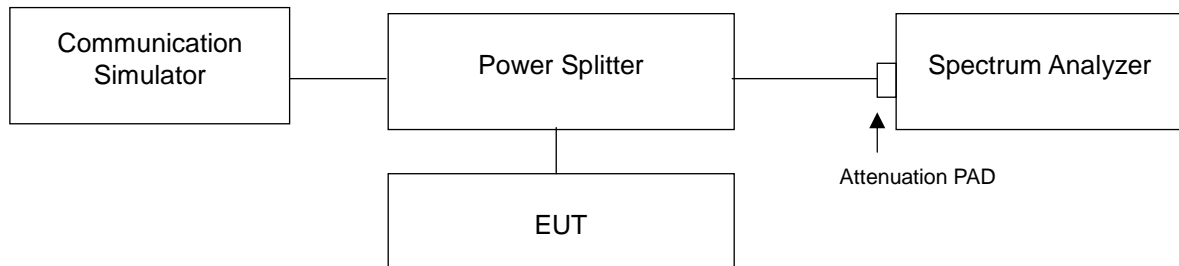

### 4.3.4 Test Result (-26dB Bandwidth, Subcontract Item)

LTE Band 26							
Channel Bandwidth 1.4MHz				Channel Bandwidth 3MHz			
Channel	Frequency (MHz)	-26dB Bandwidth (MHz)		Channel	Frequency (MHz)	-26dB Bandwidth (MHz)	
		QPSK	16QAM			QPSK	16QAM
26697	814.7	1.24	1.23	26705	815.5	2.95	2.94
26740	819	1.23	1.22	26740	819	2.95	2.95
26783	823.3	1.23	1.23	26775	822.5	2.98	2.95
Channel Bandwidth 5MHz				Channel Bandwidth 10MHz			
Channel	Frequency (MHz)	-26dB Bandwidth (MHz)		Channel	Frequency (MHz)	-26dB Bandwidth (MHz)	
		QPSK	16QAM			QPSK	16QAM
26715	816.5	4.83	4.82	26740	819	9.57	9.53
26740	819	4.85	4.81				
26765	821.5	4.84	4.48				

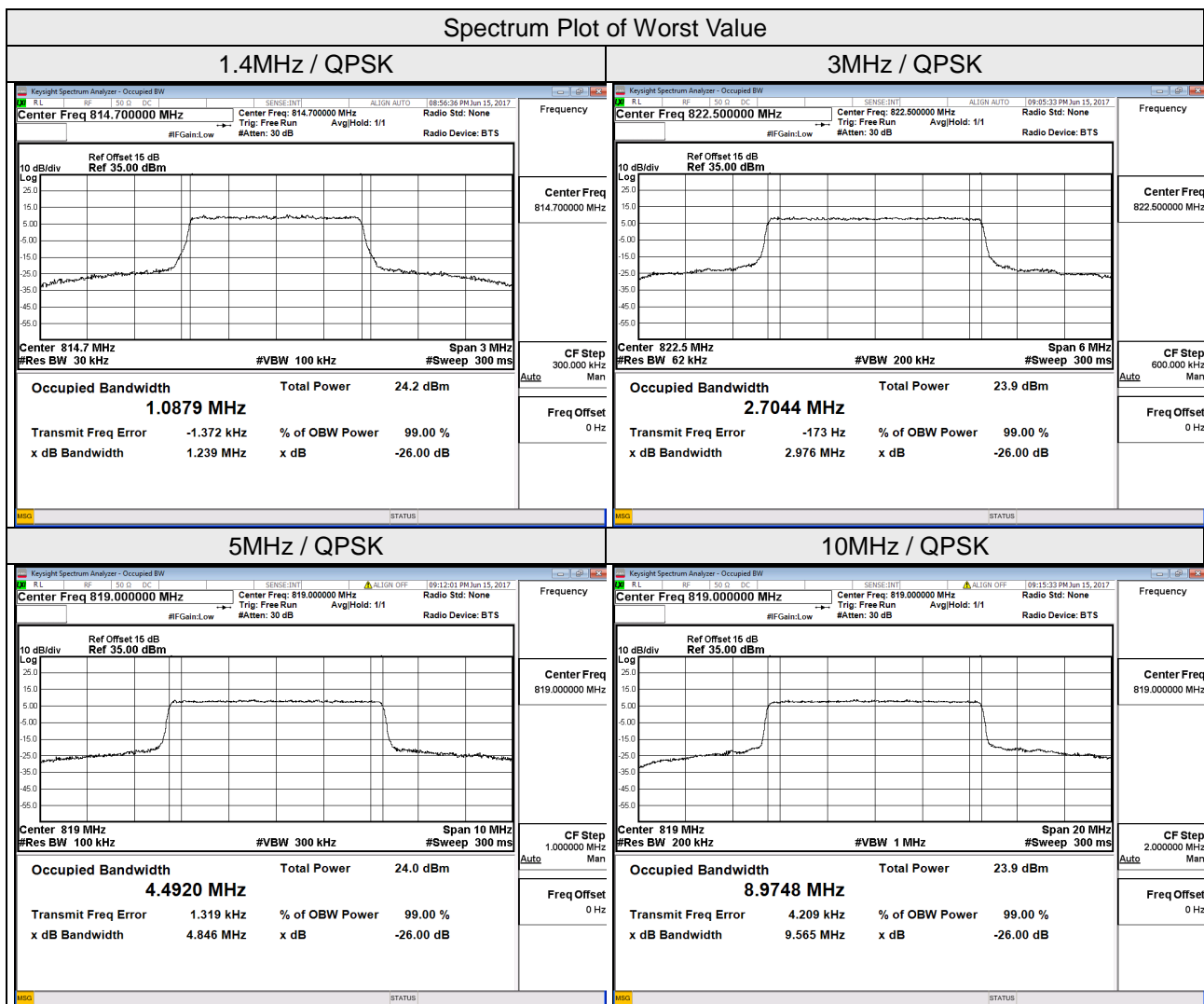

### 4.3.5 Test Result (Occupied Bandwidth, Subcontract Item)

LTE Band 26							
Channel Bandwidth 1.4MHz				Channel Bandwidth 3MHz			
Channel	Frequency (MHz)	99% Occupied Bandwidth (MHz)		Channel	Frequency (MHz)	99% Occupied Bandwidth (MHz)	
		QPSK	16QAM			QPSK	16QAM
26697	814.7	1.09	1.09	26705	815.5	2.70	2.70
26740	819	1.09	1.09	26740	819	2.70	2.70
26783	823.3	1.09	1.09	26775	822.5	2.70	2.70
Channel Bandwidth 5MHz				Channel Bandwidth 10MHz			
Channel	Frequency (MHz)	99% Occupied Bandwidth (MHz)		Channel	Frequency (MHz)	99% Occupied Bandwidth (MHz)	
		QPSK	16QAM			QPSK	16QAM
26715	816.5	4.49	4.49	26740	819	8.97	8.96
26740	819	4.49	4.49				
26765	821.5	4.49	4.49				

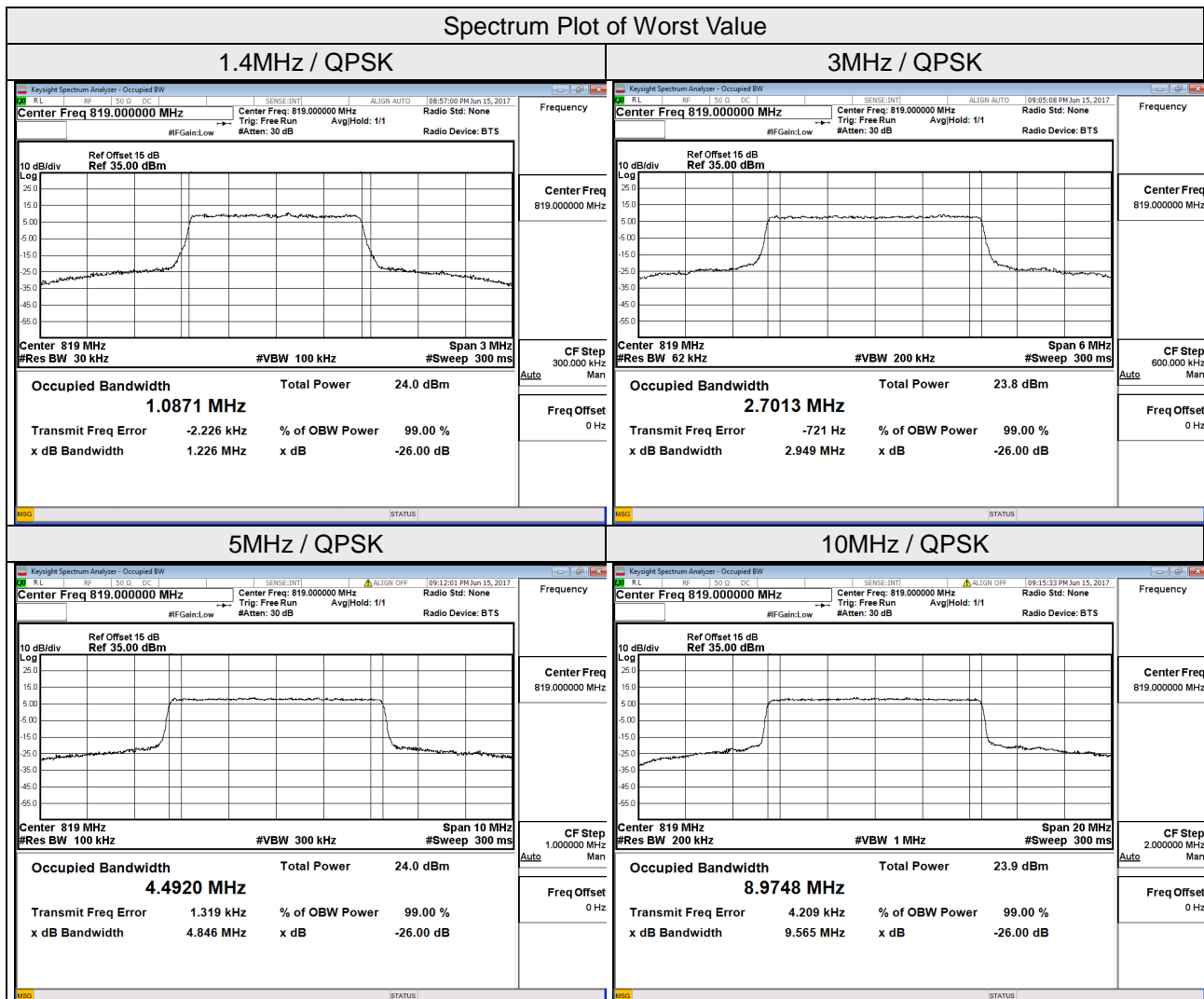

## 4.4 Emission Mask Measurement

### 4.4.1 Limits of Emission Mask Measurement

Per 90.210, equipment used in 809-824/854-869 MHz licensed band to EA or non-EA systems shall comply with the emission mask provisions of §90.691.

Per 90.691, Emission mask requirements

(a) Out-of-band emission requirement shall apply only to the “outer” channels included in an EA license and to spectrum adjacent to interior channels used by incumbent licensees. The emission limits are as follows:

(1) For any frequency removed from the EA licensee's frequency block by up to and including 37.5 kHz, the power of any emission shall be attenuated below the transmitter power (P) in watts by at least  $116 \text{ Log}_{10}(f/6.1)$  decibels or  $50 + 10 \text{ Log}_{10}(P)$  decibels or 80 decibels, whichever is the lesser attenuation, where f is the frequency removed from the center of the outer channel in the block in kilohertz and where f is greater than 12.5 kHz.

(2) For any frequency removed from the EA licensee's frequency block greater than 37.5 kHz, the power of any emission shall be attenuated below the transmitter power (P) in watts by at least  $43 + 10 \text{ Log}_{10}(P)$  decibels or 80 decibels, whichever is the lesser attenuation, where f is the frequency removed from the center of the outer channel in the block in kilohertz and where f is greater than 37.5 kHz.

(b) When an emission outside of the authorized bandwidth causes harmful interference, the Commission may, at its discretion, require greater attenuation than specified in this section.

### 4.4.2 Test Procedures

1. The power was measured with Spectrum Analyzer. All measurements were done at low and high operational frequency range..
2. The measurement used the power splitter via EUT RF power connector between signal generator and spectrum analyzer.
3. Record the test plot.

### 4.4.3 Test Setup

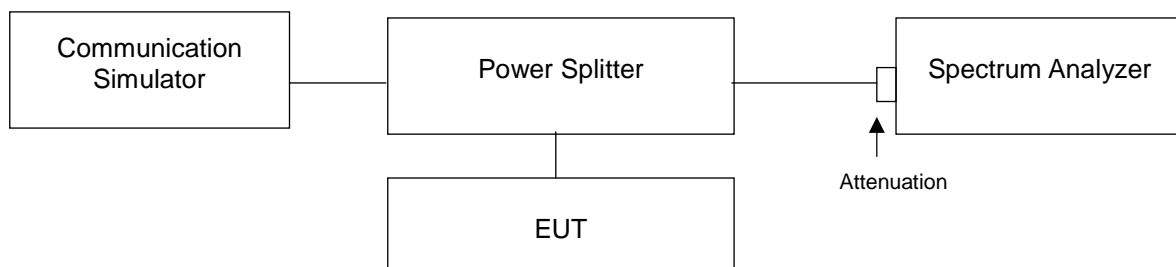



### 4.4.4 Test Results (Subcontract Item)

#### LTE Band 26

#### Channel Bandwidth 1.4MHz QPSK

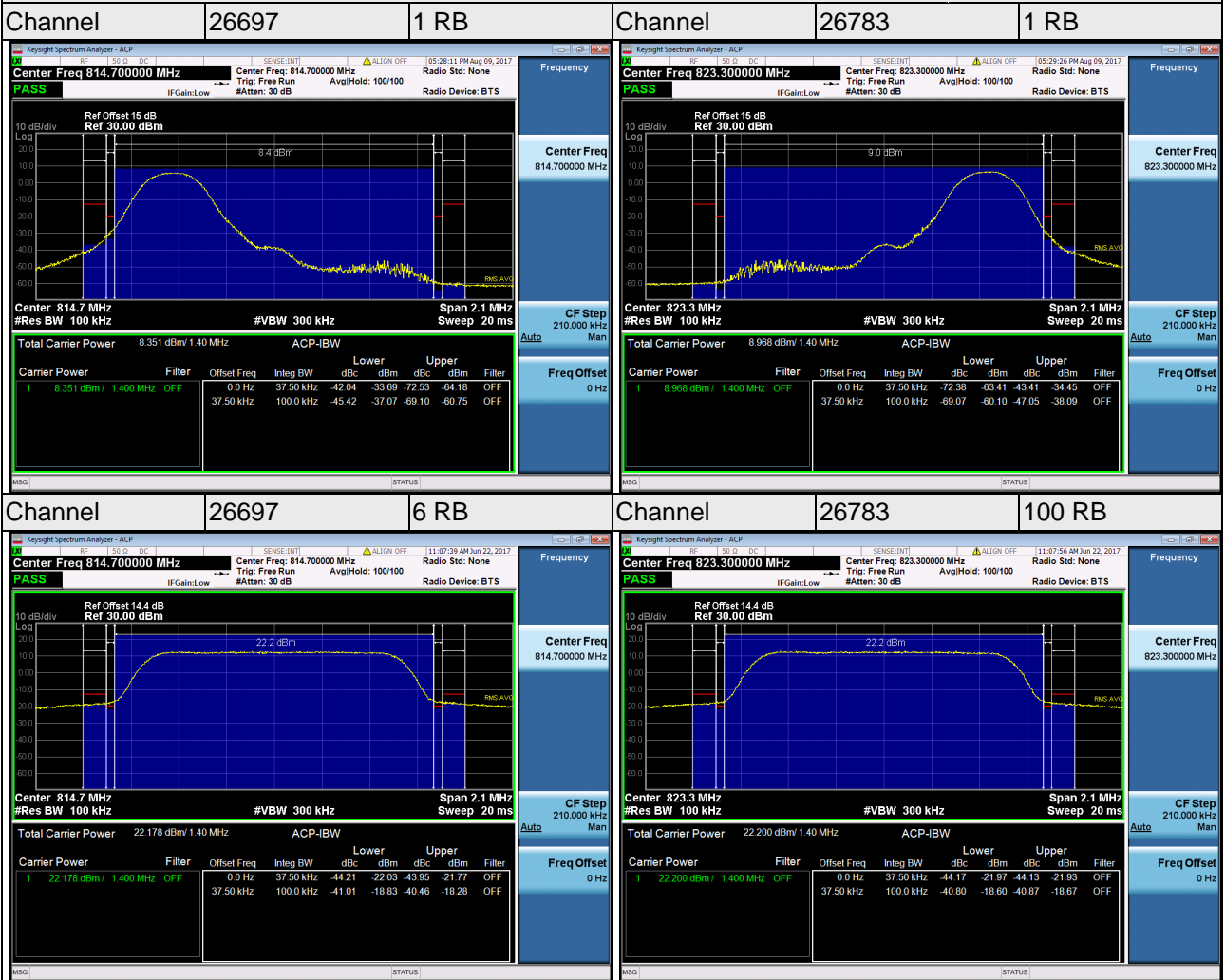



LTE Band 26

Channel Bandwidth 1.4MHz 16QAM

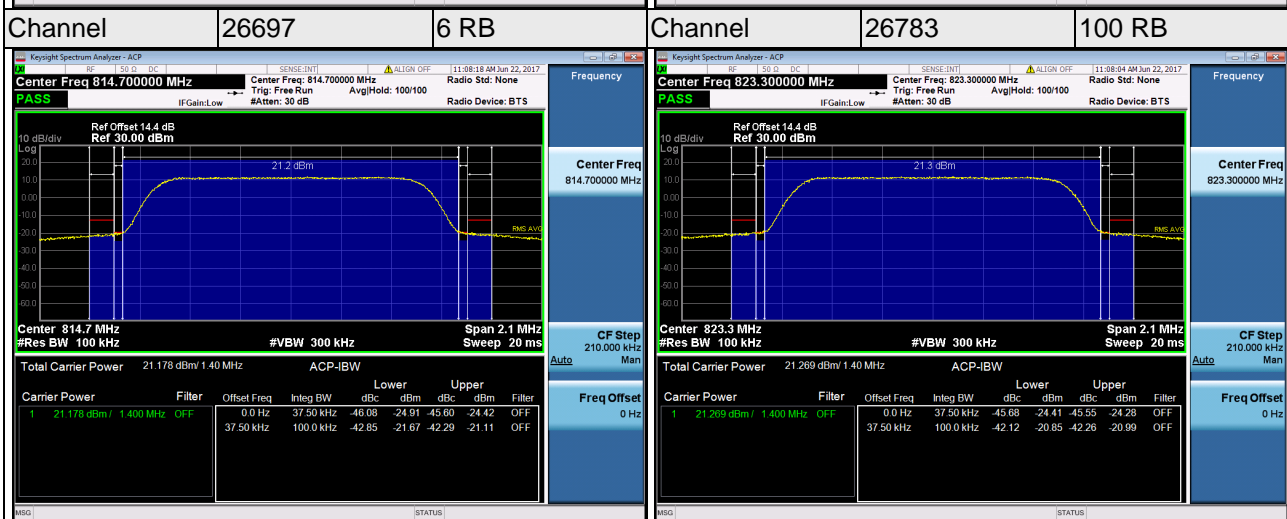
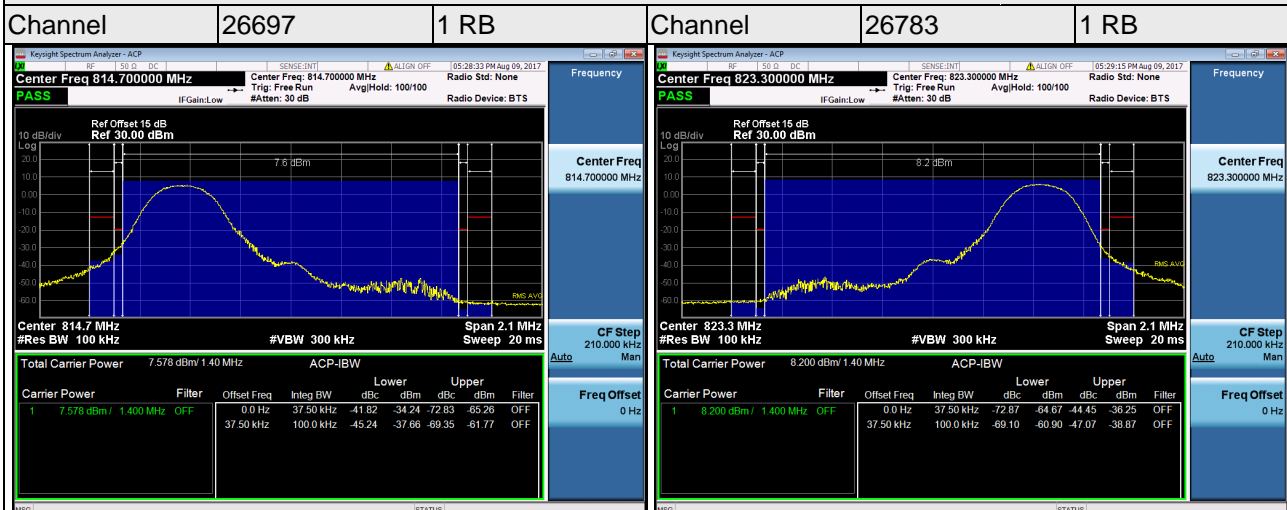



### LTE Band 26

### Channel Bandwidth 3MHz QPSK

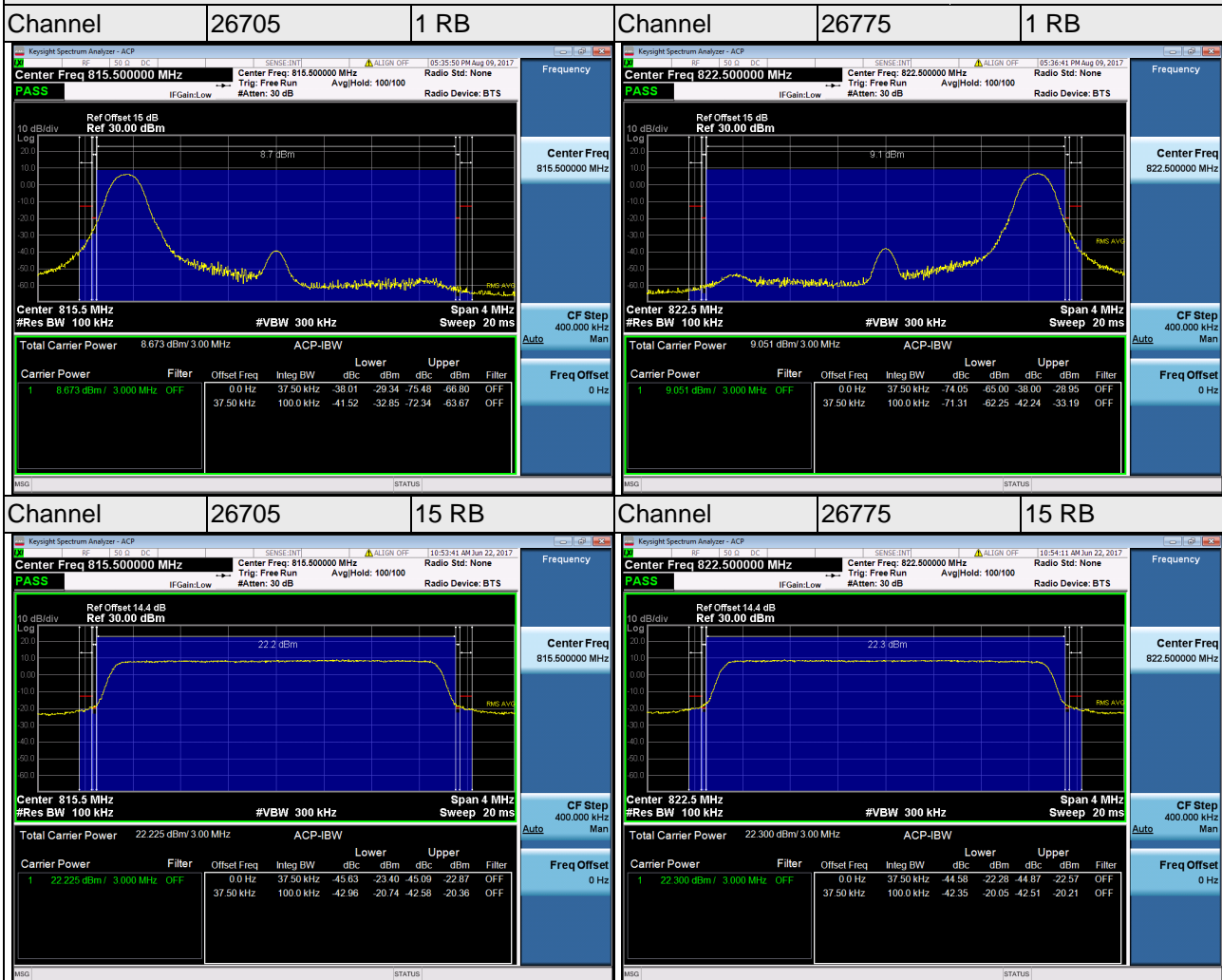





LTE Band 26

Channel Bandwidth 3MHz 16QAM

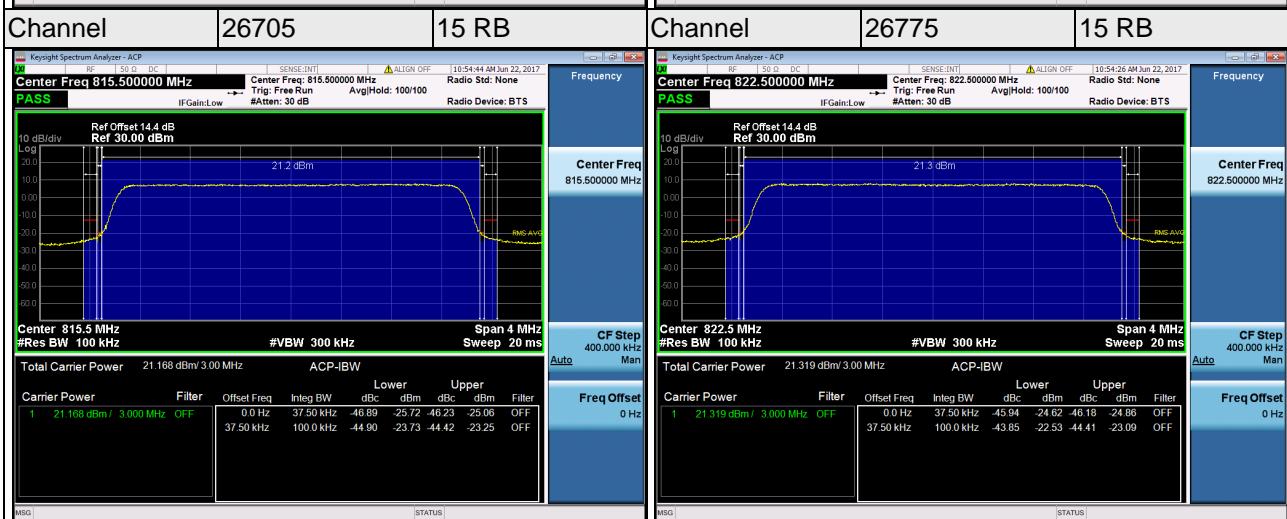
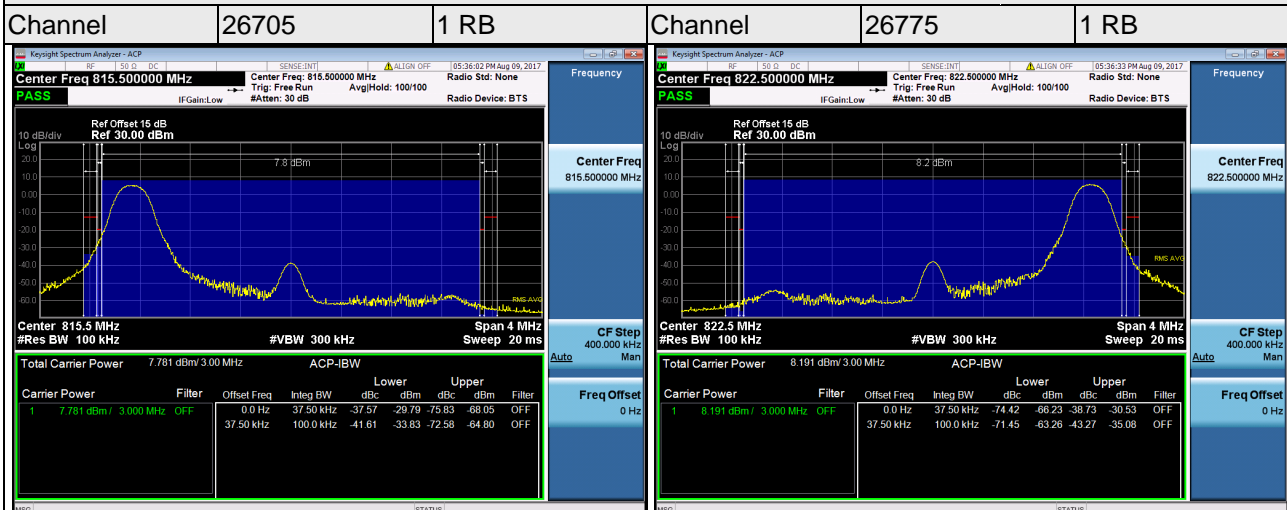



### LTE Band 26

### Channel Bandwidth 5MHz QPSK

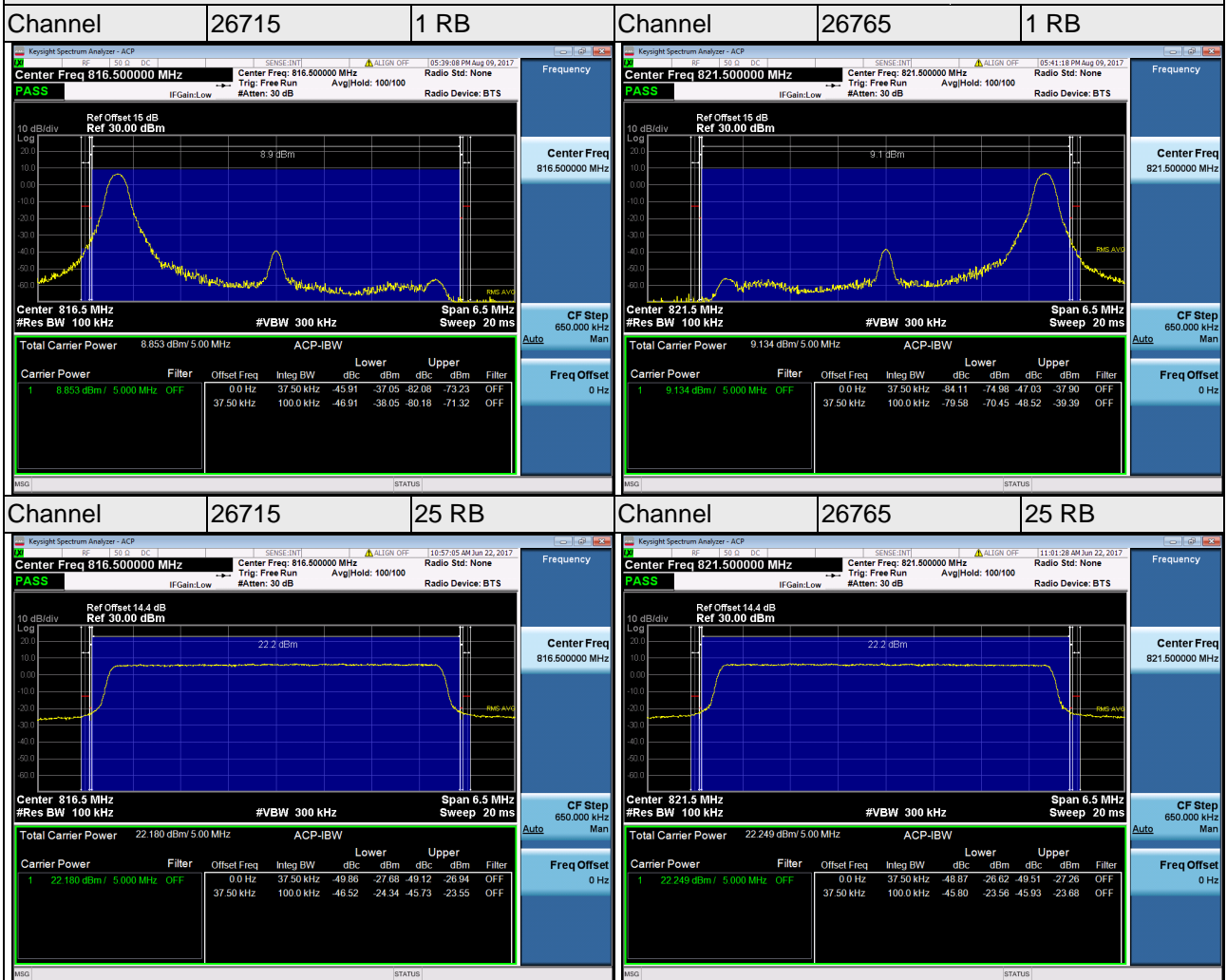



LTE Band 26

Channel Bandwidth 5MHz 16QAM

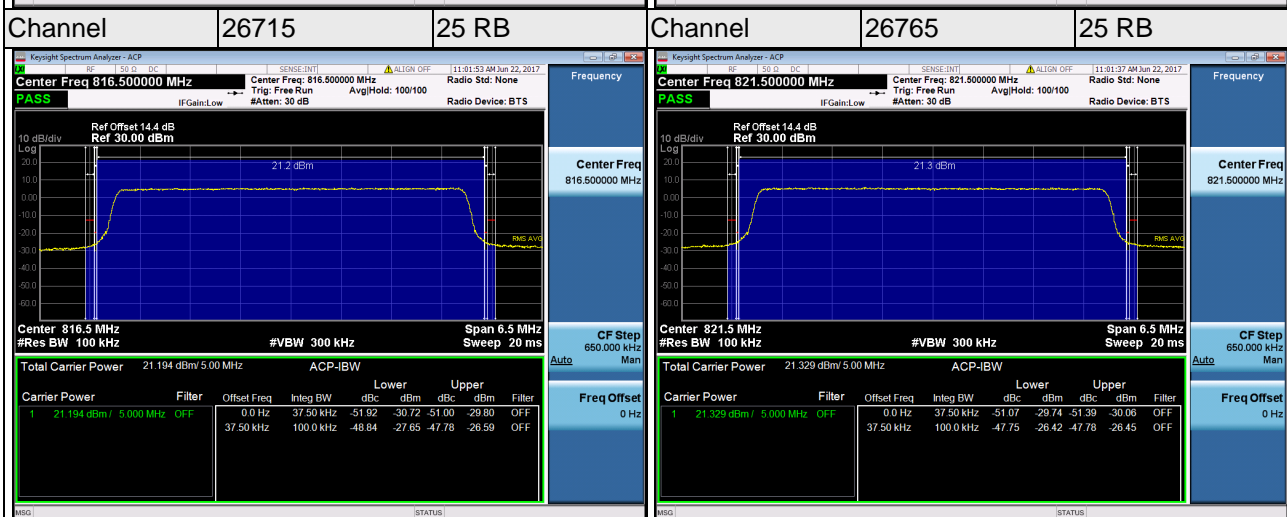
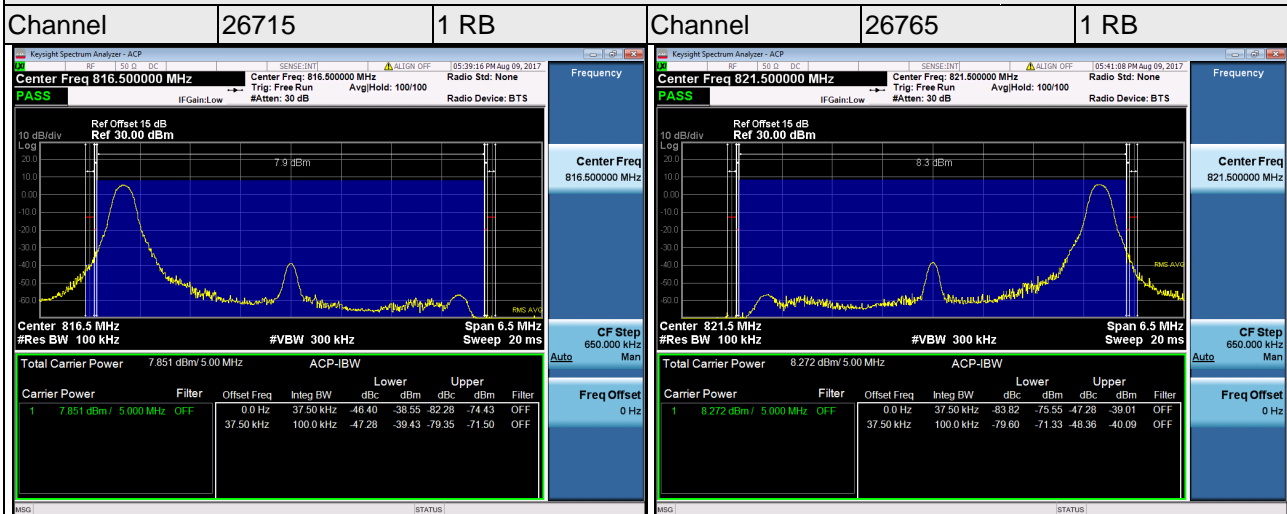



### LTE Band 26

### Channel Bandwidth 10MHz QPSK

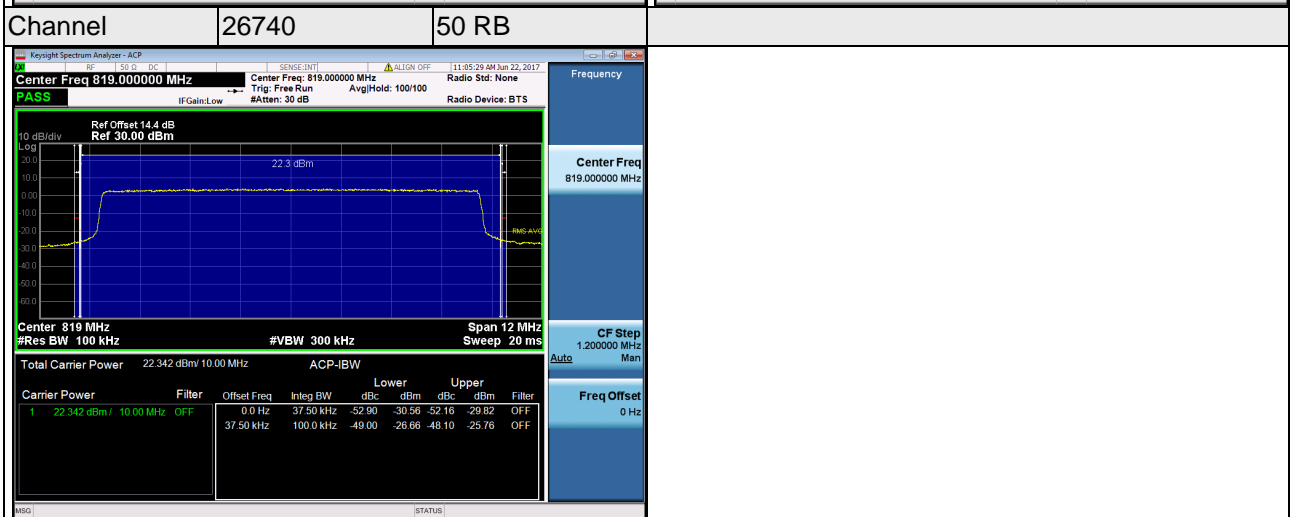
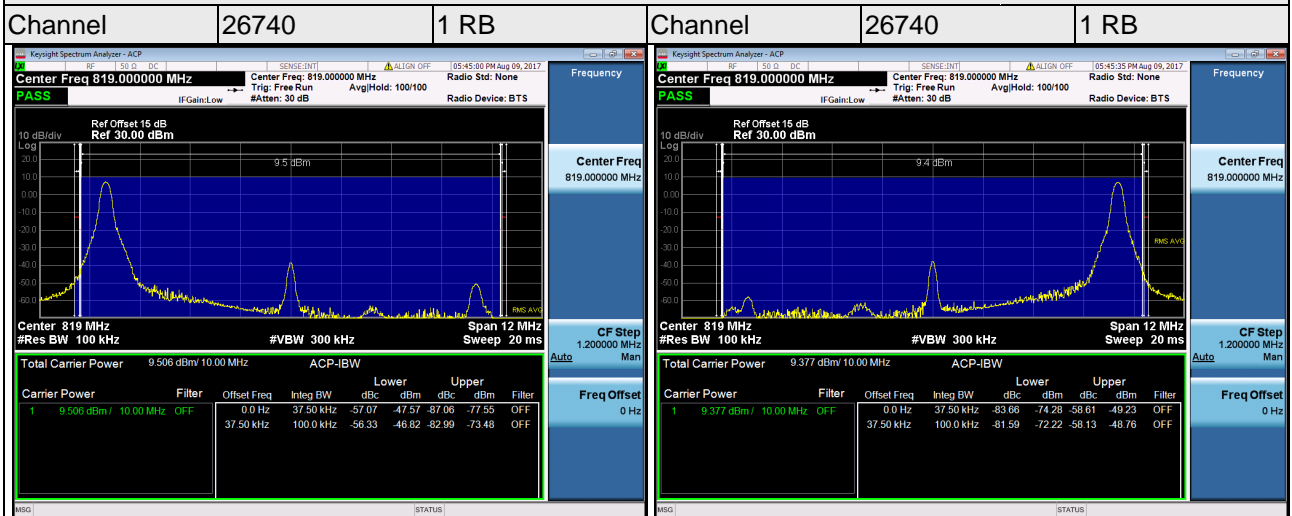



LTE Band 26

Channel Bandwidth 10MHz 16QAM

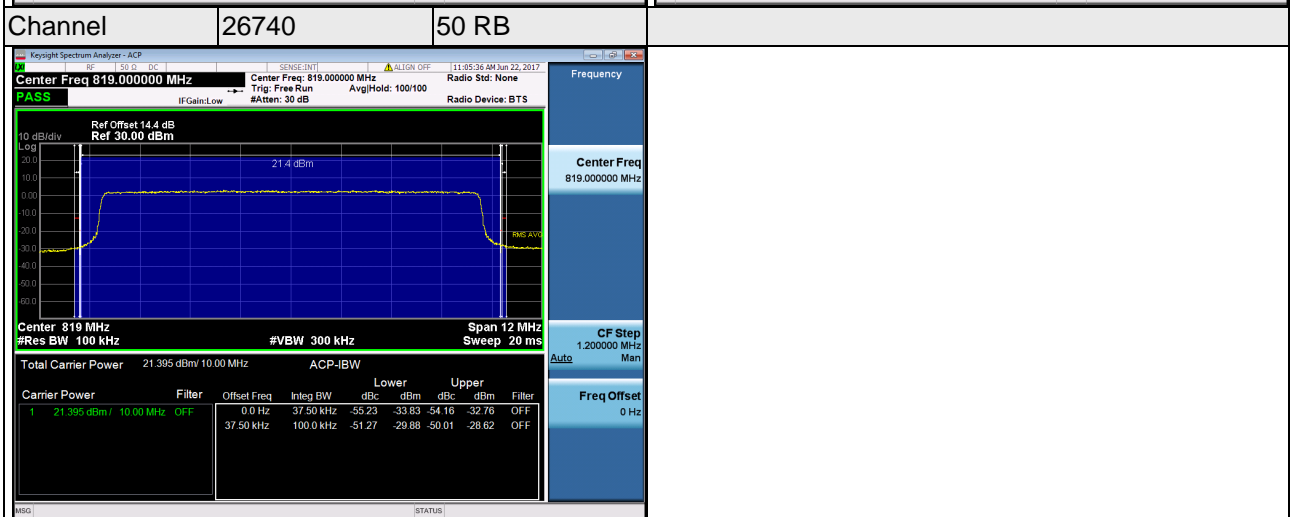
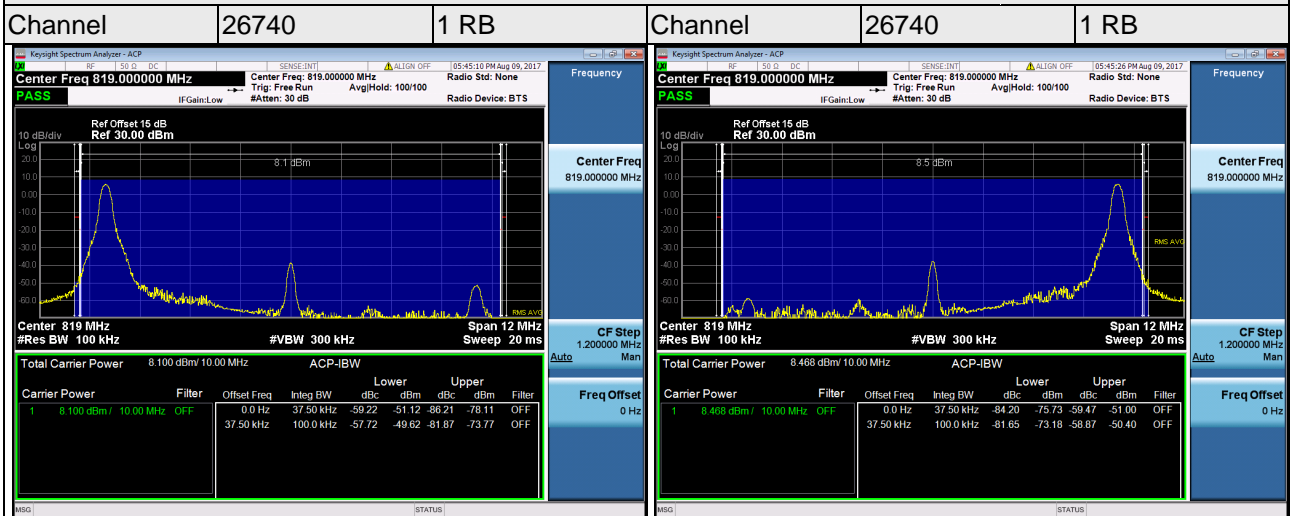

## 4.5 Conducted Spurious Emissions

### 4.5.1 Limits of Conducted Spurious Emissions Measurement

The power of any emission outside a licensee's frequency block shall be attenuated below the transmitter power (P) by at least  $43 + 10 \log_{10}(P)$  dB. The limit of emission equal to  $-13\text{dBm}$ .

### 4.5.2 Test Setup

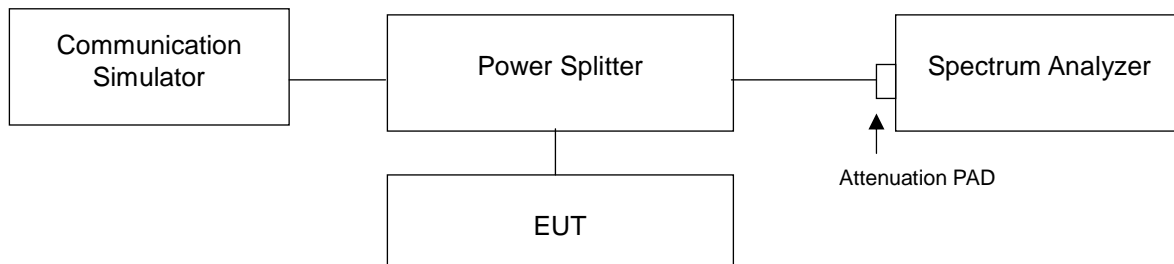

### 4.5.3 Test Procedure

- The EUT was set up for the maximum peak power with LTE link data modulation. The power was measured with Spectrum Analyzer.
- The conducted spurious emission used the power splitter via EUT RF power connector between signal generator and spectrum analyzer.
- When the spectrum scanned from 9kHz to 9GHz, it shall be connected to the band reject filter attenuated the carried frequency. The spectrum set RBW: 1 MHz and VBW=3\*RBW is used for measurement.



### 4.5.4 Test Results (Subcontract Item)

LTE Band 26 Channel Band width: 1.4MHz	LTE Band 26 Channel Band width: 3MHz
Channel 26740	Channel 26740

Frequency Range : 9kHz~9GHz	Frequency Range : 9kHz~9GHz
-----------------------------	-----------------------------

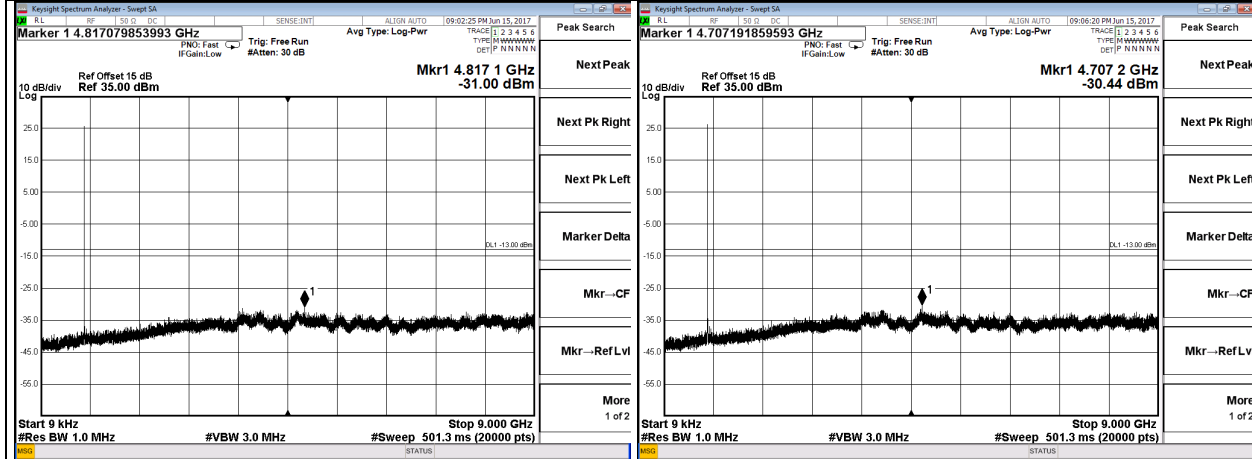

LTE Band 26 Channel Band width: 5MHz	LTE Band 26 Channel Band width: 10MHz
Channel 26740	Channel 26740

Frequency Range : 9kHz~9GHz	Frequency Range : 9kHz~9GHz
-----------------------------	-----------------------------

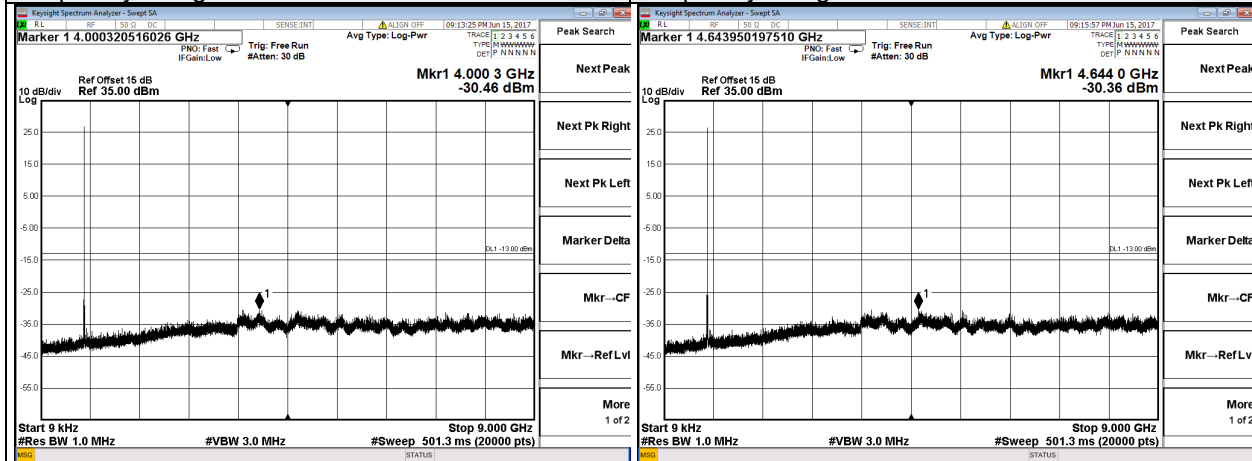

## **4.6 Radiated Emission Measurement**

### **4.6.1 Limits of Radiated Emission Measuremen**

The power of any emission outside a licensee's frequency block shall be attenuated below the transmitter power (P) by at least  $43 + 10 \log_{10}(P)$  dB. The limit of emission equal to  $-13\text{dBm}$

### **4.6.2 Test Procedure**

- a. Substitution method is used for EIRP measurement. In the semi-anechoic chamber, EUT placed on the 0.8m/1.5m height of Turn Table, rotated the table around 360 degrees to search the maximum radiation power and receiver antenna shall be rotated vertical and horizontal polarization and moved height from 1m to 4m to find the maximum polar radiated power. The "Read Value" is the spectrum reading the maximum power value.
- b. The substitution antenna is substituted for EUT at the same position and signals generator export the CW signal to the substitution antenna via a TX cable. Rotated the Turn Table and moved receiving antenna to find the maximum radiation power. Adjust output power level of S.G to get a Value of spectrum reading equal to "Read Value" of step a. Record the power level of S.G
- c.  $\text{EIRP} = \text{Output power level of S.G} - \text{TX cable loss} + \text{Antenna gain of substitution antenna}$ .
- d. ERP power can be calculated form EIRP power by subtracting the gain of dipole,  $\text{ERP power} = \text{EIRP power} - 2.15\text{dBi}$ .

**NOTE:** The resolution bandwidth and video bandwidth of test receiver/spectrum analyzer is 100kHz/300kHz.

### **4.6.3 Deviation from Test Standard**

No deviation.



#### 4.6.4 Test Setup

##### For Radiated emission below 1GHz

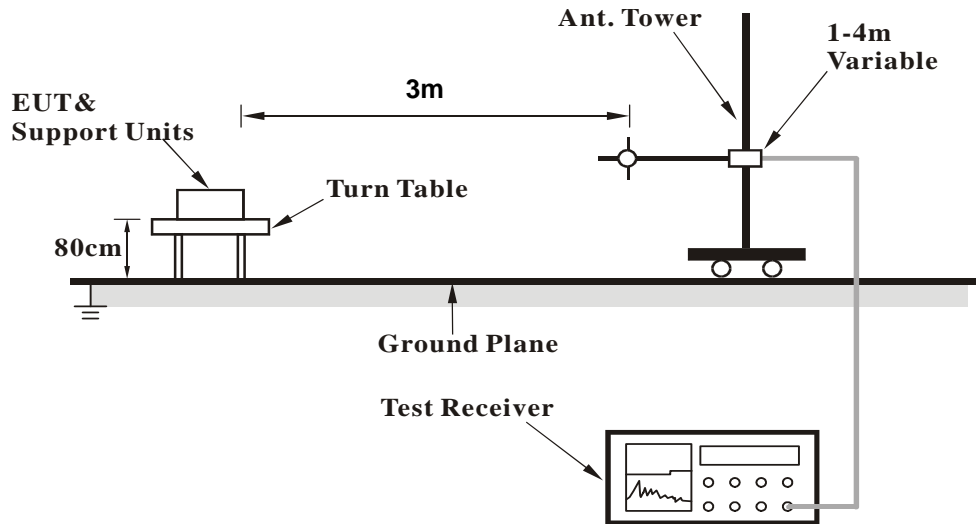

##### For Radiated emission above 1GHz

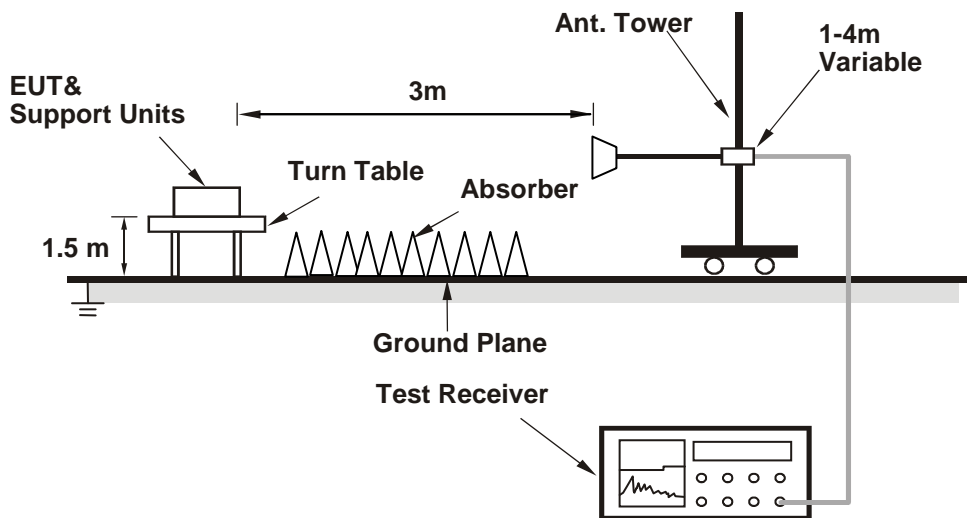

For the actual test configuration, please refer to the attached file (Test Setup Photo).

#### 4.6.5 Test Results

Below 1GHz

LTE Band 26: 1.4MHz

Mode	TX channel 26740	Frequency Range	Below 1000 MHz
------	------------------	-----------------	----------------

Antenna Polarity & Test Distance: Horizontal at 3 M							
No.	Freq. (MHz)	Reading (dBm)	S.G Power Value (dBm)	Correction Factor (dB)	Emission Value (dBm)	Limit (dBm)	Margin (dB)
1	85.2	34.75	-57.16	-1.04	-58.21	-13	-45.21
2	136.52	34.70	-60.66	3.84	-56.82	-13	-43.82
3	288.44	32.96	-62.51	3.78	-58.72	-13	-45.72
4	345.18	31.95	-65.74	3.61	-62.13	-13	-49.13
5	469.87	34.84	-62.34	2.84	-59.50	-13	-46.50
6	735.72	29.76	-66.61	1.02	-65.58	-13	-52.58
Antenna Polarity & Test Distance: Vertical at 3 M							
No.	Freq. (MHz)	Reading (dBm)	S.G Power Value (dBm)	Correction Factor (dB)	Emission Value (dBm)	Limit (dBm)	Margin (dB)
1	67.57	29.44	-58.19	-4.91	-63.10	-13	-50.10
2	92.56	32.32	-59.48	-1.00	-60.49	-13	-47.49
3	130.57	26.29	-65.06	-1.23	-66.30	-13	-53.30
4	237.87	30.17	-65.19	3.82	-61.37	-13	-48.37
5	508.41	32.62	-62.77	2.81	-59.96	-13	-46.96
6	609.87	32.51	-62.18	1.78	-60.40	-13	-47.40

Remarks:

1. Emission Value (dBm) = S.G Value (dBm) + Correction Factor (dB).
2. Correction Factor (dB) = Substitution Antenna Gain (dB) + Cable Loss (dB).

**LTE Band 26: 3MHz**

Mode	TX channel 26740	Frequency Range	Below 1000 MHz
------	------------------	-----------------	----------------

**Antenna Polarity & Test Distance: Horizontal at 3 M**

No.	Freq. (MHz)	Reading (dBm)	S.G Power Value (dBm)	Correction Factor (dB)	Emission Value (dBm)	Limit (dBm)	Margin (dB)
1	84.73	33.72	-58.19	-1.04	-59.24	-13	-46.24
2	136.25	34.04	-61.32	3.84	-57.48	-13	-44.48
3	289.35	32.75	-62.72	3.78	-58.93	-13	-45.93
4	344.37	31.01	-66.68	3.61	-63.07	-13	-50.07
5	470.81	34.43	-62.75	2.84	-59.91	-13	-46.91
6	736.7	28.84	-67.53	1.02	-66.50	-13	-53.50

**Antenna Polarity & Test Distance: Vertical at 3 M**

No.	Freq. (MHz)	Reading (dBm)	S.G Power Value (dBm)	Correction Factor (dB)	Emission Value (dBm)	Limit (dBm)	Margin (dB)
1	68.19	28.98	-58.65	-4.91	-63.56	-13	-50.56
2	92.21	31.04	-60.76	-1.00	-61.77	-13	-48.77
3	131.23	25.99	-65.36	-1.23	-66.60	-13	-53.60
4	236.96	28.91	-66.45	3.82	-62.63	-13	-49.63
5	509.02	32.40	-62.99	2.81	-60.18	-13	-47.18
6	610.22	32.16	-62.53	1.78	-60.75	-13	-47.75

**Remarks:**

1. Emission Value (dBm) = S.G Value (dBm) + Correction Factor (dB).
2. Correction Factor (dB) = Substitution Antenna Gain (dB) + Cable Loss (dB).

**LTE Band 26: 5MHz**

Mode	TX channel 26740	Frequency Range	Below 1000 MHz
------	------------------	-----------------	----------------

**Antenna Polarity & Test Distance: Horizontal at 3 M**

No.	Freq. (MHz)	Reading (dBm)	S.G Power Value (dBm)	Correction Factor (dB)	Emission Value (dBm)	Limit (dBm)	Margin (dB)
1	85.37	33.88	-58.03	-1.04	-59.08	-13	-46.08
2	135.8	34.59	-60.77	3.84	-56.93	-13	-43.93
3	287.98	31.60	-63.87	3.78	-60.08	-13	-47.08
4	345.79	31.61	-66.08	3.61	-62.47	-13	-49.47
5	469.43	34.83	-62.35	2.84	-59.51	-13	-46.51
6	734.96	29.07	-67.30	1.02	-66.27	-13	-53.27

**Antenna Polarity & Test Distance: Vertical at 3 M**

No.	Freq. (MHz)	Reading (dBm)	S.G Power Value (dBm)	Correction Factor (dB)	Emission Value (dBm)	Limit (dBm)	Margin (dB)
1	66.71	29.15	-58.48	-4.91	-63.39	-13	-50.39
2	92.68	31.98	-59.82	-1.00	-60.83	-13	-47.83
3	131.39	26.11	-65.24	-1.23	-66.48	-13	-53.48
4	237.06	29.20	-66.16	3.82	-62.34	-13	-49.34
5	508.53	31.23	-64.16	2.81	-61.35	-13	-48.35
6	610.77	31.79	-62.90	1.78	-61.12	-13	-48.12

**Remarks:**

1. Emission Value (dBm) = S.G Value (dBm) + Correction Factor (dB).
2. Correction Factor (dB) = Substitution Antenna Gain (dB) + Cable Loss (dB).

**LTE Band 26: 10MHz**

Mode	TX channel 26740	Frequency Range	Below 1000 MHz
------	------------------	-----------------	----------------

**Antenna Polarity & Test Distance: Horizontal at 3 M**

No.	Freq. (MHz)	Reading (dBm)	S.G Power Value (dBm)	Correction Factor (dB)	Emission Value (dBm)	Limit (dBm)	Margin (dB)
1	85.71	34.20	-57.71	-1.04	-58.76	-13	-45.76
2	137.35	33.25	-62.11	3.84	-58.27	-13	-45.27
3	289.33	31.46	-64.01	3.78	-60.22	-13	-47.22
4	345.9	31.09	-66.60	3.61	-62.99	-13	-49.99
5	469.02	34.67	-62.51	2.84	-59.67	-13	-46.67
6	735.1	28.30	-68.07	1.02	-67.04	-13	-54.04

**Antenna Polarity & Test Distance: Vertical at 3 M**

No.	Freq. (MHz)	Reading (dBm)	S.G Power Value (dBm)	Correction Factor (dB)	Emission Value (dBm)	Limit (dBm)	Margin (dB)
1	66.84	28.46	-59.17	-4.91	-64.08	-13	-51.08
2	92.57	31.50	-60.30	-1.00	-61.31	-13	-48.31
3	131.23	25.94	-65.41	-1.23	-66.65	-13	-53.65
4	237.41	28.77	-66.59	3.82	-62.77	-13	-49.77
5	509.05	31.85	-63.54	2.81	-60.73	-13	-47.73
6	608.99	31.62	-63.07	1.78	-61.29	-13	-48.29

**Remarks:**

1. Emission Value (dBm) = S.G Value (dBm) + Correction Factor (dB).
2. Correction Factor (dB) = Substitution Antenna Gain (dB) + Cable Loss (dB).

Above 1GHz

LTE Band 26: 1.4 MHz

Mode	TX channel 26740	Frequency Range	Above 1000MHz
------	------------------	-----------------	---------------

Antenna Polarity & Test Distance: Horizontal at 3 M

No.	Freq. (MHz)	Reading (dBm)	S.G Power Value (dBm)	Correction Factor (dB)	Emission Value (dBm)	Limit (dBm)	Margin (dB)
1	1638	46.67	-55.89	6.24	-49.65	-13	-36.65
2	2457	42.12	-56.41	6.67	-49.74	-13	-36.74
3	3276	35.47	-67.44	7.53	-59.91	-13	-46.91
4	4095	37.19	-67.69	7.48	-60.21	-13	-47.21
5	4914	40.55	-63.76	7.06	-56.70	-13	-43.70
6	5733	42.2	-62.23	6.92	-55.31	-13	-42.31
7	6552	43.47	-60.12	5.83	-54.29	-13	-41.29
8	7371	44.17	-58.58	4.66	-53.93	-13	-40.93
9	8190	48.87	-53.72	4.15	-49.57	-13	-36.57

Antenna Polarity & Test Distance: Vertical at 3 M

No.	Freq. (MHz)	Reading (dBm)	S.G Power Value (dBm)	Correction Factor (dB)	Emission Value (dBm)	Limit (dBm)	Margin (dB)
1	1638	39.72	-62.84	6.24	-56.60	-13	-43.60
2	2457	40.99	-57.54	6.67	-50.87	-13	-37.87
3	3276	37.53	-65.38	7.53	-57.85	-13	-44.85
4	4095	38.57	-66.31	7.48	-58.83	-13	-45.83
5	4914	38.63	-65.68	7.06	-58.62	-13	-45.62
6	5733	37.41	-67.02	6.92	-60.10	-13	-47.10
7	6552	41.37	-62.22	5.83	-56.39	-13	-43.39
8	7371	42.79	-59.96	4.66	-55.31	-13	-42.31
9	8190	45.14	-57.45	4.15	-53.30	-13	-40.30

Remarks:

1. Emission Value (dBm) = S.G Value (dBm) + Correction Factor (dB).
2. Correction Factor (dB) = Substitution Antenna Gain (dB) + Cable Loss (dB).

**LTE Band 26: 3 MHz**

Mode	TX channel 26740	Frequency Range	Above 1000MHz
------	------------------	-----------------	---------------

**Antenna Polarity & Test Distance: Horizontal at 3 M**

No.	Freq. (MHz)	Reading (dBm)	S.G Power Value (dBm)	Correction Factor (dB)	Emission Value (dBm)	Limit (dBm)	Margin (dB)
1	1638	47.12	-55.44	6.24	-49.20	-13	-36.20
2	2457	42.00	-56.53	6.67	-49.86	-13	-36.86
3	3276	35.35	-67.56	7.53	-60.03	-13	-47.03
4	4095	37.03	-67.85	7.48	-60.37	-13	-47.37
5	4914	39.96	-64.35	7.06	-57.29	-13	-44.29
6	5733	41.88	-62.55	6.92	-55.63	-13	-42.63
7	6552	43.38	-60.21	5.83	-54.38	-13	-41.38
8	7371	43.8	-58.95	4.66	-54.30	-13	-41.30
9	8190	49.72	-52.87	4.15	-48.72	-13	-35.72

**Antenna Polarity & Test Distance: Vertical at 3 M**

No.	Freq. (MHz)	Reading (dBm)	S.G Power Value (dBm)	Correction Factor (dB)	Emission Value (dBm)	Limit (dBm)	Margin (dB)
1	1638	39.8	-62.76	6.24	-56.52	-13	-43.52
2	2457	41.91	-56.62	6.67	-49.95	-13	-36.95
3	3276	38.15	-64.76	7.53	-57.23	-13	-44.23
4	4095	38.03	-66.85	7.48	-59.37	-13	-46.37
5	4914	38.95	-65.36	7.06	-58.30	-13	-45.30
6	5733	38.13	-66.30	6.92	-59.38	-13	-46.38
7	6552	41.34	-62.25	5.83	-56.42	-13	-43.42
8	7371	43.7	-59.05	4.66	-54.40	-13	-41.40
9	8190	45.01	-57.58	4.15	-53.43	-13	-40.43

**Remarks:**

1. Emission Value (dBm) = S.G Value (dBm) + Correction Factor (dB).
2. Correction Factor (dB) = Substitution Antenna Gain (dB) + Cable Loss (dB).

**LTE Band 26: 5 MHz**

Mode	TX channel 26740	Frequency Range	Above 1000MHz
------	------------------	-----------------	---------------

Antenna Polarity & Test Distance: Horizontal at 3 M							
No.	Freq. (MHz)	Reading (dBm)	S.G Power Value (dBm)	Correction Factor (dB)	Emission Value (dBm)	Limit (dBm)	Margin (dB)
1	1638	46.34	-56.22	6.24	-49.98	-13	-36.98
2	2457	41.88	-56.65	6.67	-49.98	-13	-36.98
3	3276	36.07	-66.84	7.53	-59.31	-13	-46.31
4	4095	37.70	-67.18	7.48	-59.70	-13	-46.70
5	4914	40.18	-64.13	7.06	-57.07	-13	-44.07
6	5733	42.92	-61.51	6.92	-54.59	-13	-41.59
7	6552	44.08	-59.51	5.83	-53.68	-13	-40.68
8	7371	45.07	-57.68	4.66	-53.03	-13	-40.03
<b>9</b>	<b>8190</b>	<b>49.81</b>	<b>-52.78</b>	<b>4.15</b>	<b>-48.63</b>	<b>-13</b>	<b>-35.63</b>
Antenna Polarity & Test Distance: Vertical at 3 M							
No.	Freq. (MHz)	Reading (dBm)	S.G Power Value (dBm)	Correction Factor (dB)	Emission Value (dBm)	Limit (dBm)	Margin (dB)
1	1638	39.98	-62.58	6.24	-56.34	-13	-43.34
2	2457	40.89	-57.64	6.67	-50.97	-13	-37.97
3	3276	36.81	-66.10	7.53	-58.57	-13	-45.57
4	4095	39.49	-65.39	7.48	-57.91	-13	-44.91
5	4914	37.76	-66.55	7.06	-59.49	-13	-46.49
6	5733	37.75	-66.68	6.92	-59.76	-13	-46.76
7	6552	41.54	-62.05	5.83	-56.22	-13	-43.22
8	7371	42.43	-60.32	4.66	-55.67	-13	-42.67
9	8190	45.57	-57.02	4.15	-52.87	-13	-39.87

Remarks:

1. Emission Value (dBm) = S.G Value (dBm) + Correction Factor (dB).
2. Correction Factor (dB) = Substitution Antenna Gain (dB) + Cable Loss (dB).



**LTE Band 26: 10 MHz**

Mode	TX channel 26740	Frequency Range	Above 1000MHz
------	------------------	-----------------	---------------

**Antenna Polarity & Test Distance: Horizontal at 3 M**

No.	Freq. (MHz)	Reading (dBm)	S.G Power Value (dBm)	Correction Factor (dB)	Emission Value (dBm)	Limit (dBm)	Margin (dB)
1	1638	47.44	-55.12	6.24	-48.88	-13	-35.88
2	2457	42.43	-56.10	6.67	-49.43	-13	-36.43
3	3276	34.68	-68.23	7.53	-60.70	-13	-47.70
4	4095	36.79	-68.09	7.48	-60.61	-13	-47.61
5	4914	40.58	-63.73	7.06	-56.67	-13	-43.67
6	5733	41.88	-62.55	6.92	-55.63	-13	-42.63
7	6552	43.31	-60.28	5.83	-54.45	-13	-41.45
8	7371	43.82	-58.93	4.66	-54.28	-13	-41.28
9	8190	48.53	-54.06	4.15	-49.91	-13	-36.91

**Antenna Polarity & Test Distance: Vertical at 3 M**

No.	Freq. (MHz)	Reading (dBm)	S.G Power Value (dBm)	Correction Factor (dB)	Emission Value (dBm)	Limit (dBm)	Margin (dB)
1	1638	40.52	-62.04	6.24	-55.80	-13	-42.80
2	2457	41.91	-56.62	6.67	-49.95	-13	-36.95
3	3276	38.09	-64.82	7.53	-57.29	-13	-44.29
4	4095	38.58	-66.30	7.48	-58.82	-13	-45.82
5	4914	38.52	-65.79	7.06	-58.73	-13	-45.73
6	5733	38.23	-66.20	6.92	-59.28	-13	-46.28
7	6552	41.16	-62.43	5.83	-56.60	-13	-43.60
8	7371	43.78	-58.97	4.66	-54.32	-13	-41.32
9	8190	44.73	-57.86	4.15	-53.71	-13	-40.71

**Remarks:**

1. Emission Value (dBm) = S.G Value (dBm) + Correction Factor (dB).
2. Correction Factor (dB) = Substitution Antenna Gain (dB) + Cable Loss (dB).

## 5 Pictures of Test Arrangements

Please refer to the attached file (Test Setup Photo).



## Appendix – Information on the Testing Laboratories

We, Bureau Veritas Consumer Products Services (H.K.) Ltd., Taoyuan Branch, were founded in 1988 to provide our best service in EMC, Radio, Telecom and Safety consultation. Our laboratories are accredited and approved according to ISO/IEC 17025.

If you have any comments, please feel free to contact us at the following:

**Linko EMC/RF Lab**

Tel: 886-2-26052180

Fax: 886-2-26051924

**Hsin Chu EMC/RF/Telecom Lab**

Tel: 886-3-6668565

Fax: 886-3-6668323

**Hwa Ya EMC/RF/Safety Lab**

Tel: 886-3-3183232

Fax: 886-3-3270892

**Email:** [service.adt@tw.bureauveritas.com](mailto:service.adt@tw.bureauveritas.com)

**Web Site:** [www.bureauveritas-adt.com](http://www.bureauveritas-adt.com)

The address and road map of all our labs can be found in our web site also.

--- END ---