

FCC Test Report (PART 22)

Report No.: RF170428E06

FCC ID: MCLT77W676

Test Model: T77W676

Received Date: Apr. 28, 2017

Test Date: June 12 to July 12, 2017

Issued Date: July 27, 2017

Applicant: HON HAI PRECISION IND. CO., LTD.

Address: 5F-1,5 Hsin-An Road Hsinchu, Science-Based Industrial Park Taiwan,
R.O.C.

Issued By: Bureau Veritas Consumer Products Services (H.K.) Ltd., Taoyuan Branch
Hsin Chu Laboratory

Lab Address: E-2, No.1, Li Hsin 1st Road, Hsinchu Science Park, Hsinchu City 300,
Taiwan R.O.C.

Test Lab (A): Bureau Veritas Consumer Products Services (H.K.) Ltd., Taoyuan Branch
Hsin Chu Laboratory

Test Location: E-2, No.1, Li Hsin 1st Road, Hsinchu Science Park, Hsinchu City 300,
Taiwan R.O.C.

Test Lab (B): Bureau Veritas Consumer Products Services (H.K.) Ltd., Taoyuan Branch
Lin Kou Laboratories

Test Location: No.19, Hwa Ya 2nd Rd., Wen Hwa Vil., Kwei Shan Dist., Taoyuan City
33383, TAIWAN (R.O.C.)



This report is for your exclusive use. Any copying or replication of this report to or for any other person or entity, or use of our name or trademark, is permitted only with our prior written permission. This report sets forth our findings solely with respect to the test samples identified herein. The results set forth in this report are not indicative or representative of the quality or characteristics of the lot from which a test sample was taken or any similar or identical product unless specifically and expressly noted. Our report includes all of the tests requested by you and the results thereof based upon the information that you provided to us. You have 60 days from date of issuance of this report to notify us of any material error or omission caused by our negligence, provided, however, that such notice shall be in writing and shall specifically address the issue you wish to raise. A failure to raise such issue within the prescribed time shall constitute your unqualified acceptance of the completeness of this report, the tests conducted and the correctness of the report contents. Unless specific mention, the uncertainty of measurement has been explicitly taken into account to declare the compliance or non-compliance to the specification. The report must not be used by the client to claim product certification, approval, or endorsement by TAF or any government agencies. This report contains all test data (Except Effective radiated power and Radiated Spurious Emissions) that was produced under subcontract by Bureau Veritas Consumer Products Services (H.K.) Ltd. Taoyuan Branch Lin Kou Laboratories

Table of Contents

Release Control Record	3
1 Certificate of Conformity	4
2 Summary of Test Results	5
2.1 Measurement Uncertainty	5
2.2 Test Site and Instruments.....	6
3 General Information	9
3.1 General Description of EUT	9
3.2 Configuration of System under Test.....	14
3.2.1 Description of Support Units.....	15
3.3 Test Mode Applicability and Tested Channel Detail	16
3.4 EUT Operating Conditions	19
3.5 General Description of Applied Standards	20
4 Test Types and Results	21
4.1 Output Power Measurement	21
4.1.1 Limits of Output Power Measurement.....	21
4.1.2 Test Procedures.....	21
4.1.3 Test Setup.....	22
4.1.4 Test Results	23
4.2 Frequency Stability Measurement.....	30
4.2.1 Limits of Frequency Stability Measurement.....	30
4.2.2 Test Procedure	30
4.2.3 Test Setup.....	30
4.2.4 Test Results (Subcontract Item)	31
4.3 Occupied Bandwidth Measurement	33
4.3.1 Test Procedure	33
4.3.2 Test Setup.....	33
4.3.3 Test Result (-26dB Bandwidth, Subcontract Item)	34
4.3.4 Test Result (Occupied Bandwidth, Subcontract Item).....	38
4.4 Band Edge Measurement	42
4.4.1 Limits of Band Edge Measurement	42
4.4.2 Test Setup.....	42
4.4.3 Test Procedures.....	42
4.4.4 Test Results (Subcontract Item)	43
4.5 Peak to Average Ratio.....	53
4.5.1 Limits of Peak to Average Ratio Measurement.....	53
4.5.2 Test Setup	53
4.5.3 Test Procedures	53
4.5.4 Test Results (Subcontract Item).....	54
4.6 Conducted Spurious Emissions	58
4.6.1 Limits of Conducted Spurious Emissions Measurement.....	58
4.6.2 Test Setup.....	58
4.6.3 Test Procedure	58
4.6.4 Test Results (Subcontract Item)	59
4.7 Radiated Emission Measurement	62
4.7.1 Limits of Radiated Emission Measurement	62
4.7.2 Test Procedure	62
4.7.3 Deviation from Test Standard	62
4.7.4 Test Setup.....	63
4.7.5 Test Results	64
5 Pictures of Test Arrangements	84
Appendix – Information on the Testing Laboratories	85

Release Control Record

Issue No.	Description	Date Issued
RF170428E06	Original release.	July 27, 2017

1 Certificate of Conformity

Product: LTE Cat9 PCI Express M.2 Module

Brand: FOXCONN

Test Model: T77W676

Sample Status: ENGINEERING SAMPLE

Applicant: HON HAI PRECISION IND. CO., LTD.

Test Date: June 12 to July 12, 2017

Standards: FCC Part 22

The above equipment has been tested by **Bureau Veritas Consumer Products Services (H.K.) Ltd., Taoyuan Branch**, and found compliance with the requirement of the above standards. The test record, data evaluation & Equipment Under Test (EUT) configurations represented herein are true and accurate accounts of the measurements of the sample's EMC characteristics under the conditions specified in this report. This report contains all test data (Except Effective radiated power and Radiated Spurious Emissions) that was produced under subcontract by Bureau Veritas Consumer Products Services (H.K.) Ltd., Taoyuan Branch Lin Kou Laboratories.

Prepared by :  _____, **Date:** July 27, 2017
Claire Kuan / Specialist

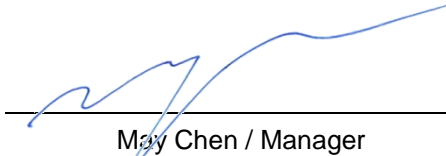
Approved by :  _____, **Date:** July 27, 2017
May Chen / Manager

2 Summary of Test Results

Applied Standard: FCC Part 22 & Part 2			
FCC Clause	Test Item	Result	Remarks
2.1046 22.913 (a)	Effective radiated power	PASS	Meet the requirement of limit.
---	Peak to Average Ratio	PASS	Meet the requirement of limit.
2.1055 22.355	Frequency Stability	PASS	Meet the requirement of limit.
2.1049	Occupied Bandwidth	PASS	Meet the requirement of limit.
22.917	Band Edge Measurements	PASS	Meet the requirement of limit.
2.1051 22.917	Conducted Spurious Emissions	PASS	Meet the requirement of limit.
2.1053 22.917	Radiated Spurious Emissions	PASS	Meet the requirement of limit. Minimum passing margin is -34.85dB at 2509.5MHz.

2.1 Measurement Uncertainty

Where relevant, the following measurement uncertainty levels have been estimated for tests performed on the EUT as specified in CISPR 16-4-2:

Measurement	Frequency	Expanded Uncertainty (k=2) (\pm)
Radiated Emissions up to 1 GHz	30MHz ~ 1GHz	5.32 dB
Radiated Emissions above 1 GHz	1GHz ~ 6GHz	5.14 dB
	6GHz ~ 18GHz	5.04 dB
	18GHz ~ 40GHz	5.25 dB

2.2 Test Site and Instruments

For radiated spurious emissions test:

DESCRIPTION & MANUFACTURER	MODEL NO.	SERIAL NO.	CALIBRATED DATE	CALIBRATED UNTIL
Test Receiver Agilent	N9038A	MY50010156	Aug. 18, 2016	Aug. 17, 2017
Pre-Amplifier ^(*) EMCI	EMC001340	980142	Jan. 20, 2016	Jan. 19, 2018
Loop Antenna ^(*) Electro-Metrics	EM-6879	264	Dec. 16, 2016	Dec. 15, 2018
RF Cable	NA	LOOPCAB-001 LOOPCAB-002	Jan. 17, 2017	Jan. 16, 2018
Pre-Amplifier Mini-Circuits	ZFL-1000VH2B	AMP-ZFL-05	May 06, 2017	May 05, 2018
Trilog Broadband Antenna SCHWARZBECK	VULB 9168	9168-361	Dec. 29, 2016	Dec. 28, 2017
RF Cable	8D	966-3-1 966-3-2 966-3-3	Apr. 01, 2017	Mar. 31, 2018
Fixed attenuator Mini-Circuits	UNAT-5+	PAD-3m-3-01	Oct. 05, 2016	Oct. 04, 2017
Horn_Antenna SCHWARZBECK	BBHA9120-D	9120D-406	Dec. 28, 2016	Dec. 27, 2017
Pre-Amplifier EMCI	EMC12630SE	980384	Feb. 02, 2017	Feb. 01, 2018
RF Cable	EMC104-SM-SM-1200 EMC104-SM-SM-2000 EMC104-SM-SM-5000	160922 150317 150322	Feb. 02, 2017 Mar. 29, 2017 Mar. 29, 2017	Feb. 01, 2018 Mar. 28, 2018 Mar. 28, 2018
Spectrum Analyzer Keysight	N9030A	MY54490520	July 29, 2016	July 28, 2017
Pre-Amplifier EMCI	EMC184045SE	980386	Feb. 02, 2017	Feb. 01, 2018
Horn_Antenna SCHWARZBECK	BBHA 9170	BBHA9170608	Dec. 15, 2016	Dec. 14, 2017
RF Cable	SUCOFLEX 102	36432/2 36433/2	Jan. 15, 2017	Jan. 14, 2018
Software	ADT_Radiated_V8.7.08	NA	NA	NA
Antenna Tower & Turn Table Max-Full	MF-7802	MF780208406	NA	NA
Boresight Antenna Fixture	FBA-01	FBA-SIP01	NA	NA

Note:

1. The calibration interval of the above test instruments is 12 months and the calibrations are traceable to NML/ROC and NIST/USA.
2. *The calibration interval of the above test instruments is 24 months and the calibrations are traceable to NML/ROC and NIST/USA.
3. The test was performed in 966 Chamber No. 3.
4. The FCC Site Registration No. is 147459
5. The CANADA Site Registration No. is 20331-1
6. Tested Date: June 21 to July 12, 2017

For Radiated power test:

DESCRIPTION & MANUFACTURER	MODEL NO.	SERIAL NO.	CALIBRATED DATE	CALIBRATED UNTIL
Spectrum Analyzer R&S	FSV40	100964	June 28, 2016	June 27, 2017
Spectrum Analyzer Keysight	N9030A	MY54490570	July 06, 2016	July 05, 2017
AC Power Source Extech Electronics	6502	1140503	NA	NA
Temperature & Humidity Chamber TERCHY	MHU-225AU	911033	Dec. 02, 2016	Dec. 01, 2017
DC Power Supply GOOD WILL INSTRUMENT CO., LTD.	GPC - 3030D	7700087	NA	NA
ESG Vector signal generator Agilent	E4438C	Y45094468/005 506 602 UK6 UNJ	Nov. 25, 2016	Nov. 24, 2017
Power meter Anritsu	ML2495A	1014008	May 11, 2017	May 10, 2018
Power sensor Anritsu	MA2411B	0917122	May 11, 2017	May 10, 2018
Software	ADT_RF Test Software V6.6.5.4	NA	NA	NA
Digital Multimeter FLUKE	87III	73680266	Nov. 10, 2016	Nov. 09, 2017

- NOTE:**
1. The test was performed in Oven room 1.
 2. The calibration interval of the above test instruments is 12 months and the calibrations are traceable to NML/ROC and NIST/USA.
 3. Tested Date: June 23, 2017

For other test items:

Description & Manufacturer	Model No.	Serial No.	Cal. Date	Cal. Due
Test Receiver ROHDE & SCHWARZ	ESIB7	100187	May 02, 2017	May 01, 2018
Spectrum Analyzer ROHDE & SCHWARZ	FSP40	100041	Nov. 16, 2016	Nov. 15, 2017
BILOG Antenna SCHWARZBECK	VULB9168	9168-171	Dec. 28, 2016	Dec. 27, 2017
HORN Antenna SCHWARZBECK	9120D	209	Dec. 27, 2016	Dec. 26, 2017
HORN Antenna SCHWARZBECK	BBHA 9170	BBHA9170241	Dec. 14, 2016	Dec. 13, 2017
Preamplifier Agilent	8447D	2944A10738	Aug. 22, 2016	Aug. 21, 2017
Preamplifier Agilent	8449B	3008A01963	Aug. 22, 2016	Aug. 21, 2017
RF signal cable HUBER+SUHNER	SUCOFLEX 104	Cable-CH3-03 (214378)	Aug. 22, 2016	Aug. 21, 2017
RF signal cable HUBER+SUHNER	SUCOFLEX 106	Cable-CH3-03 (309224+12738)	Aug. 22, 2016	Aug. 21, 2017
Software BV ADT	ADT_Radiated_ V7.6.15.9.4	NA	NA	NA
Antenna Tower inn-co GmbH	MA 4000	013303	NA	NA
Antenna Tower Controller BV ADT	AT100	AT93021702	NA	NA
Turn Table BV ADT	TT100	TT93021702	NA	NA
Turn Table Controller BV ADT	SC100	SC93021702	NA	NA
WIT Standard Temperature And Humidity Chamber	TH-4S-C	W981030	Jun. 07, 2017	Jun. 06, 2018
Mini-Circuits Power Splitter	ZN2PD-9G	NA	Aug. 11, 2016	Aug. 10, 2017
JFW 20dB attenuation	50HF-020-SMA	NA	NA	NA

- Note: 1. The calibration interval of the above test instruments is 12 months and the calibrations are traceable to NML/ROC and NIST/USA.
 2. The test was performed in HwaYa Chamber 3.
 3. The horn antenna and preamplifier (model: 8449B) are used only for the measurement of emission frequency above 1GHz if tested.
 4. The FCC Site Registration No. is 988962.
 5. The IC Site Registration No. is IC 7450F-3.
 6. Tested Date: June 12 to 15, 2017

3 General Information

3.1 General Description of EUT

Product	LTE Cat9 PCI Express M.2 Module	
Brand	FOXCONN	
Test Model	T77W676	
Status of EUT	ENGINEERING SAMPLE	
Power Supply Rating	DC 5V from host equipment	
Modulation Type	WCDMA, HSDPA, HSUPA	BPSK
	LTE Band 5	QPSK, 16QAM
	LTE Band 26	QPSK, 16QAM
Operating Frequency	WCDMA, HSDPA, HSUPA	826.4MHz ~846.6MHz
	LTE Band 5	824.7MHz ~ 848.3MHz
	LTE Band 26	824.7MHz ~ 848.3MHz
Max. ERP Power	WCDMA	179.47mW (22.54dBm)
	LTE Band 5 (Channel Bandwidth 1.4MHz)	141.25mW(21.5dBm)
	LTE Band 5 (Channel Bandwidth 3MHz)	140.93mW(21.49dBm)
	LTE Band 5 (Channel Bandwidth 5MHz)	141.58mW(21.51dBm)
	LTE Band 5 (Channel Bandwidth 10MHz)	143.88mW(21.58dBm)
	LTE Band 26 (Channel Bandwidth 1.4MHz)	109.9mW(20.41dBm)
	LTE Band 26 (Channel Bandwidth 3MHz)	111.94mW(20.49dBm)
	LTE Band 26 (Channel Bandwidth 5MHz)	112.2mW(20.5dBm)
	LTE Band 26 (Channel Bandwidth 10MHz)	116.41mW(20.66dBm)
	LTE Band 26 (Channel Bandwidth 15MHz)	90.16mW(19.55dBm)

Emission Designator	WCDMA	4M17F9W
	LTE Band 5 (Channel Bandwidth 1.4MHz)	QPSK: 1M09G7D 16QAM: 1M09D7W
	LTE Band 5 (Channel Bandwidth 3MHz)	QPSK: 2M71G7D 16QAM: 2M70D7W
	LTE Band 5 (Channel Bandwidth 5MHz)	QPSK: 4M50G7D 16QAM: 4M49D7W
	LTE Band 5 (Channel Bandwidth 10MHz)	QPSK: 8M98G7D 16QAM: 8M98D7W
	LTE Band 26 (Channel Bandwidth 1.4MHz)	QPSK: 1M09G7D 16QAM: 1M09D7W
	LTE Band 26 (Channel Bandwidth 3MHz)	QPSK: 2M71G7D 16QAM: 2M70D7W
	LTE Band 26 (Channel Bandwidth 5MHz)	QPSK: 4M50G7D 16QAM: 4M49D7W
	LTE Band 26 (Channel Bandwidth 10MHz)	QPSK: 8M98G7D 16QAM: 8M98D7W
	LTE Band 26 (Channel Bandwidth 15MHz)	QPSK: 13M5G7D 16QAM: 13M5D7W
Antenna Type	Refer to Note	
Antenna Connector	Refer to Note	
Accessory Device	NA	
Data Cable Supplied	NA	

Note:

1. The EUT is a WWAN device.
2. The antennas provided to the EUT, please refer to the following table:

Antenna NO.	Brand	Model	Gain(dBi) Including cable loss	Frequency range	Antenna Type	Connecter Type	Cable Length
1	TongDa	T-543-8201115-2	3.08 4.74	791~960MHz 1447.9~1606MHz	PIFA	I-PEX MHF IV	100mm
2	TongDa	T-543-8201115-1	4.17	698~803MHz	PIFA	I-PEX MHF IV	100mm
3	TongDa	T-543-8201115-3	5.99	1710~2700MHz	PIFA	I-PEX MHF IV	100mm
4	HongBo	260-23671	-1.33	703-748MHz	PIFA	I-PEX MHF IV	315mm
			-3.23	815-830MHz			
			-3.37	832-862MHz			
			-2.27	824-849MHz			
			-3.11	880-915MHz			
			-4.15	1448-1463MHz			
			-0.64	1710-1785MHz			
			0.18	1850-1915MHz			
			0.57	1920-1980MHz			
	HongBo	260-23672	-3.71	758-803MHz	PIFA	I-PEX MHF IV	439mm
			-0.95	860-875MHz			
			-3.07	791-821MHz			
			-0.97	869-894MHz			
			-3.5	925-960MHz			
			-5.32	1496-1511MHz			
-0.09	1805-1880MHz						
0.16	1930-1995MHz						
-0.8	2110-2170MHz						

Antenna NO.	Brand	Model	Gain(dBi) Including cable loss	Frequency range	Antenna Type	Connecter Type	Cable Length
5	SPEED	F.0G.UH-6010-003-00	-2.81	703-748MHz	PIFA	I-PEX MHF IV	315mm
			-1.53	815-830MHz			
			-1.96	832-862MHz			
			-2.59	880-915MHz			
			-4.19	1448-1463MHz			
			1.23	1710-1785MHz			
			0.26	1850-1883MHz			
			1.16	1915-1980MHz			
	SPEED	F.0G.UH-6010-004-00	-2.67	758-803MHz	PIFA	I-PEX MHF IV	439mm
			-2.42	791-821MHz			
			-2.33	860-894MHz			
			-0.58	925-960MHz			
			-0.17	1496-1511MHz			
			0.83	1805-1880MHz			
-2.72			1930-1995MHz				
-1.67			2110-2170MHz				
6	HongBo	260-23675	-2.68	703-748MHz	PIFA	I-PEX MHF IV	363mm
			-0.88	815-830MHz			
			-1.66	832-862MHz			
			-1.23	824-849MHz			
			1.35	880-915MHz			
			0.8	1448-1463MHz			
			2.03	1710-1785MHz			
			2.02	1850-1915MHz			
			0.57	1920-1980MHz			
	HongBo	260-23676	-2.86	758-803MHz	PIFA	I-PEX MHF IV	522mm
			0.51	860-875MHz			
			-1.19	791-821MHz			
			0.48	869-894MHz			
			-2.29	925-960MHz			
			-4.52	1496-1511MHz			
			-0.09	1805-1880MHz			
			-0.22	1930-1995MHz			
			-0.42	2110-2170MHz			

Antenna NO.	Brand	Model	Gain(dBi) Including cable loss	Frequency range	Antenna Type	Connector Type	Cable Length
7	SPEED	F.0G.UH-6011-003-00	-3.21	703-748MHz	PIFA	I-PEX MHF IV	363mm
			-2.73	815-830MHz			
			-2.48	832-862MHz			
			-3.32	880-915MHz			
			-1.86	1448-1463MHz			
			-0.57	1710-1785MHz			
			-0.63	1850-1883MHz			
			0.44	1915-1980MHz			
	SPEED	F.0G.UH-6011-004-00	-4	758-803MHz	PIFA	I-PEX MHF IV	522mm
			-3.43	791-821MHz			
			-1.22	860-894MHz			
			-2.06	925-960MHz			
			-1.83	1496-1511MHz			
			0.48	1805-1880MHz			
-0.2	1930-1995MHz						
			-2.87	2110-2170MHz			

Set 1~3 were chosen for final test.

3. The above EUT information is declared by manufacturer and for more detailed features description, please refer to the manufacturer's specifications or User's Manual.

3.2 Configuration of System under Test

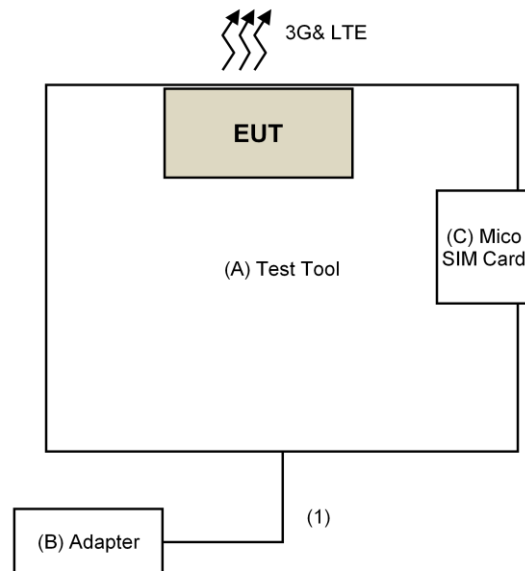

Remote Site

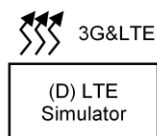

3.2.1 Description of Support Units

The EUT has been tested as an independent unit together with other necessary accessories or support units. The following support units or accessories were used to form a representative test configuration during the tests.

ID	Product	Brand	Model No.	Serial No.	FCC ID	Remarks
A.	Test Tool	Foxconn	NA	NA	NA	Supplied by client
B.	USB Adapter	ASUS	EXA1205UA	NA	NA	Provided by Lab
C.	Mico SIM Card	NA	NA	NA	NA	Provided by Lab
D.	LTE Simulator	Keysight	E7515-10910	NA	NA	Provided by Lab

Note:

1. All power cords of the above support units are non-shielded (1.8m).

ID	Descriptions	Qty.	Length (m)	Shielding (Yes/No)	Cores (Qty.)	Remarks
1.	USB Cable	1	1	Yes	0	Supplied by client

3.3 Test Mode Applicability and Tested Channel Detail

Pre-Scan has been conducted to determine the worst-case mode from all possible combinations between available modulations, data rates, XYZ axis and antenna ports
 The worst case was found when positioned on X-plane. Following channel(s) was (were) selected for the final test as listed below:

WCDMA V MODE

Test Item	Available Channel	Tested Channel	Mode
ERP	4132 to 4233	4132, 4182, 4233	WCDMA
Frequency Stability	4132 to 4233	4182	WCDMA
Occupied Bandwidth	4132 to 4233	4132, 4182, 4233	WCDMA
Peak to Average Ratio	4132 to 4233	4132, 4182, 4233	WCDMA
Band Edge	4132 to 4233	4132, 4233	WCDMA
Conducted Emission	4132 to 4233	4182	WCDMA
Radiated Emission Below 1GHz	4132 to 4233	4182	WCDMA
Radiated Emission Above 1GHz	4132 to 4233	4182	WCDMA

LTE Band 5

TEST ITEM	AVAILABLE CHANNEL	TESTED CHANNEL	CHANNEL BANDWIDTH	MODULATION	MODE
ERP	20407 to 20643	20407, 20525, 20643	1.4MHz	QPSK	1RB / 0 RB offset
	20145 to 20635	20145, 20525, 20635	3MHz	QPSK	1RB / 0 RB offset
	20425 to 20625	20425, 20525, 20625	5MHz	QPSK	1RB / 0 RB offset
	20450 to 20600	20450, 20525, 20600	10MHz	QPSK	1RB / 0 RB offset
Frequency Stability	20407 to 20643	20525	1.4MHz	QPSK	-
	20145 to 20635	20525	3MHz	QPSK	-
	20425 to 20625	20525	5MHz	QPSK	-
	20450 to 20600	20525	10MHz	QPSK	-
Emission Bandwidth	20407 to 20643	20407, 20525, 20643	1.4MHz	QPSK/16QAM	Full RB
	20145 to 20635	20145, 20525, 20635	3MHz	QPSK/16QAM	Full RB
	20425 to 20625	20425, 20525, 20625	5MHz	QPSK/16QAM	Full RB
	20450 to 20600	20450, 20525, 20600	10MHz	QPSK/16QAM	Full RB
Peak to Average Ratio	20407 to 20643	20407, 20525, 20643	1.4MHz	QPSK/16QAM	Full RB
	20145 to 20635	20145, 20525, 20635	3MHz	QPSK/16QAM	Full RB
	20425 to 20625	20425, 20525, 20625	5MHz	QPSK/16QAM	Full RB
	20450 to 20600	20450, 20525, 20600	10MHz	QPSK/16QAM	Full RB
Band Edge	20407 to 20643	20407	1.4MHz	QPSK	1 RB / 0 RB Offset
		20643			1 RB / 5 RB Offset
		20407, 20643			6 RB / 0 RB Offset
	20145 to 20635	20145	3MHz	QPSK	1 RB / 0 RB Offset
		20635			1 RB / 14 RB Offset
		20145, 20635			15 RB / 0 RB Offset
	20425 to 20625	20425	5MHz	QPSK	1 RB / 0 RB Offset
		20625			1 RB / 24 RB Offset
		20425, 20625			25 RB / 0 RB Offset
	20450 to 20600	20450	10MHz	QPSK	1 RB / 0 RB Offset
		20600			1 RB / 49 RB Offset
		20450, 20600			50 RB / 0 RB Offset
Conducuted Emission	20407 to 20643	20525	1.4MHz	QPSK	1RB / 0 RB offset
	20145 to 20635	20525	3MHz	QPSK	1RB / 0 RB offset
	20425 to 20625	20525	5MHz	QPSK	1RB / 0 RB offset
	20450 to 20600	20525	10MHz	QPSK	1RB / 0 RB offset
Radiated Emission	20407 to 20643	20525	1.4MHz	QPSK	1RB / 0 RB offset
	20145 to 20635	20525	3MHz	QPSK	1RB / 0 RB offset
	20425 to 20625	20525	5MHz	QPSK	1RB / 0 RB offset
	20450 to 20600	20525	10MHz	QPSK	1RB / 0 RB offset

LTE Band 26

TEST ITEM	AVAILABLE CHANNEL	TESTED CHANNEL	CHANNEL BANDWIDTH	MODULATION	MODE
ERP	26797 to 27033	26797, 26915, 27033	1.4MHz	QPSK	1RB / 0 RB offset
	26805 to 27025	26805, 26915, 27025	3MHz	QPSK	1RB / 0 RB offset
	26815 to 27015	26815, 26915, 27015	5MHz	QPSK	1RB / 0 RB offset
	26840 to 26990	26840, 26915, 26990	10MHz	QPSK	1RB / 0 RB offset
	26865 to 26965	26865, 26915, 26965	15MHz	QPSK	1RB / 0 RB offset
Frequency Stability	26797 to 27033	26915	1.4MHz	QPSK	-
	26805 to 27025	26915	3MHz	QPSK	-
	26815 to 27015	26915	5MHz	QPSK	-
	26840 to 26990	26915	10MHz	QPSK	-
	26865 to 26965	26915	15MHz	QPSK	-
Emission Bandwidth	26797 to 27033	26797, 26915, 27033	1.4MHz	QPSK/16QAM	Full RB
	26805 to 27025	26805, 26915, 27025	3MHz	QPSK/16QAM	Full RB
	26815 to 27015	26815, 26915, 27015	5MHz	QPSK/16QAM	Full RB
	26840 to 26990	26840, 26915, 26990	10MHz	QPSK/16QAM	Full RB
	26865 to 26965	26865, 26915, 26965	15MHz	QPSK/16QAM	Full RB
Peak to Average Ratio	26797 to 27033	26797, 26915, 27033	1.4MHz	QPSK/16QAM	Full RB
	26805 to 27025	26805, 26915, 27025	3MHz	QPSK/16QAM	Full RB
	26815 to 27015	26815, 26915, 27015	5MHz	QPSK/16QAM	Full RB
	26840 to 26990	26840, 26915, 26990	10MHz	QPSK/16QAM	Full RB
	26865 to 26965	26865, 26915, 26965	15MHz	QPSK/16QAM	Full RB
Band Edge	26797 to 27033	26797	1.4MHz	QPSK	1 RB / 0 RB Offset
		27033			1 RB / 5 RB Offset
		26797, 27033			6 RB / 0 RB Offset
	26805 to 27025	26805	3MHz	QPSK	1 RB / 0 RB Offset
		27025			1 RB / 14 RB Offset
		26805, 27025			15 RB / 0 RB Offset
	26815 to 27015	26815	5MHz	QPSK	1 RB / 0 RB Offset
		27015			1 RB / 24 RB Offset
		26815, 27015			25 RB / 0 RB Offset
	26840 to 26990	26840	10MHz	QPSK	1 RB / 0 RB Offset
		26990			1 RB / 49 RB Offset
		26840, 26990			50 RB / 0 RB Offset
	26865 to 26965	26865	15MHz	QPSK	1 RB / 0 RB Offset
		26965			1 RB / 74 RB Offset
		26865, 26965			75 RB / 0 RB Offset
Conducuted Emission	26797 to 27033	26915	1.4MHz	QPSK	1RB / 0 RB offset
	26805 to 27025	26915	3MHz	QPSK	1RB / 0 RB offset
	26815 to 27015	26915	5MHz	QPSK	1RB / 0 RB offset
	26840 to 26990	26915	10MHz	QPSK	1RB / 0 RB offset
	26865 to 26965	26915	15MHz	QPSK	1RB / 0 RB offset
Radiated Emission	26797 to 27033	26915	1.4MHz	QPSK	1RB / 0 RB offset
	26805 to 27025	26915	3MHz	QPSK	1RB / 0 RB offset
	26815 to 27015	26915	5MHz	QPSK	1RB / 0 RB offset
	26840 to 26990	26915	10MHz	QPSK	1RB / 0 RB offset
	26865 to 26965	26915	15MHz	QPSK	1RB / 0 RB offset

NOTE:

All supported modulation types were evaluated. The Worst case of QPSK was selected. Therefore, the Output power, Frequency Stability, Conducuted Emission and Radiated Emission were presented under QPSK mode only.

Test Condition:

Test Item	Environmental Conditions	Input Power (System)	Tested By
ERP	25deg. C, 63%RH	120Vac, 60Hz	Weiwei Lo
Frequency Stability	23deg. C, 68%RH	120Vac, 60Hz	Anson Lin
Occupied Bandwidth	23deg. C, 68%RH	120Vac, 60Hz	Anson Lin
Band Edge	23deg. C, 68%RH	120Vac, 60Hz	Anson Lin
Peak to Average Ratio	23deg. C, 68%RH	120Vac, 60Hz	Anson Lin
Conducuted Emission	23deg. C, 68%RH	120Vac, 60Hz	Anson Lin
Radiated Emission Below 1GHz	23deg. C, 68%RH	120Vac, 60Hz	Weiwei Lo
Radiated Emission Above 1GHz	23deg. C, 68%RH	120Vac, 60Hz	Weiwei Lo

3.4 EUT Operating Conditions

The communication simulator station system controlled a EUT to export maximum output power under transmission mode and specific channel frequency

3.5 General Description of Applied Standards

The EUT is a RF Product. According to the specifications of the manufacturer, it must comply with the requirements of the following standards:

FCC 47 CFR Part 2

FCC 47 CFR Part 22

KDB 971168 D01 Power Meas License Digital Systems v02r02

ANSI/TIA/EIA-603-D 2010

NOTE: All test items have been performed and recorded as per the above standards.

4 Test Types and Results

4.1 Output Power Measurement

4.1.1 Limits of Output Power Measurement

Mobile / Portable station are limited to 7 watts e.r.p.

4.1.2 Test Procedures

Conducted Power Measurement:

The EUT was set up for the maximum power with WCDMA & LTE link data modulation and link up with simulator. Set the EUT to transmit under low, middle and high channel and record the power level shown on simulator.

EIRP / ERP Measurement:

- a. All measurements were done at low, middle and high operational frequency range. Set the $RBW \geq OBW$ and $VBW \geq 3 \times RBW$.
- b. Substitution method is used for EIRP measurement. In the semi-anechoic chamber, EUT placed on the 0.8m/1.5m height of Turn Table, rotated the table around 360 degrees to search the maximum radiation power and receiver antenna shall be rotated vertical and horizontal polarization and moved height from 1m to 4m to find the maximum polar radiated power. The "Read Value" is the spectrum reading the maximum power value.
- c. The substitution antenna is substituted for EUT at the same position and signals generator export the CW signal to the substitution antenna via a TX cable. Rotated the Turn Table and moved receiving antenna to find the maximum radiation power. Adjust output power level of S.G to get a Value of spectrum reading equal to "Read Value" of step b. Record the power level of S.G
- d. $EIRP = \text{Output power level of S.G} - \text{TX cable loss} + \text{Antenna gain of substitution antenna}$.
- e. ERP power can be calculated form EIRP power by subtracting the gain of dipole, $ERP \text{ power} = EIPR \text{ power} - 2.15dBi$.

Note: The worst case vertical or horizontal polarization have been investigated and reported in this report.

4.1.3 Test Setup

CONDUCTED POWER MEASUREMENT:

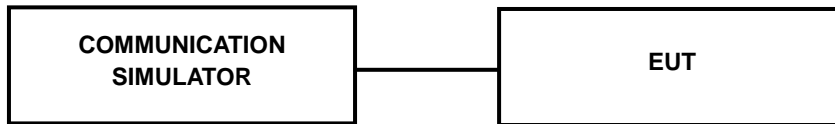

ERP/EIRP MEASUREMENT:

For ERP/EIRP below 1GHz

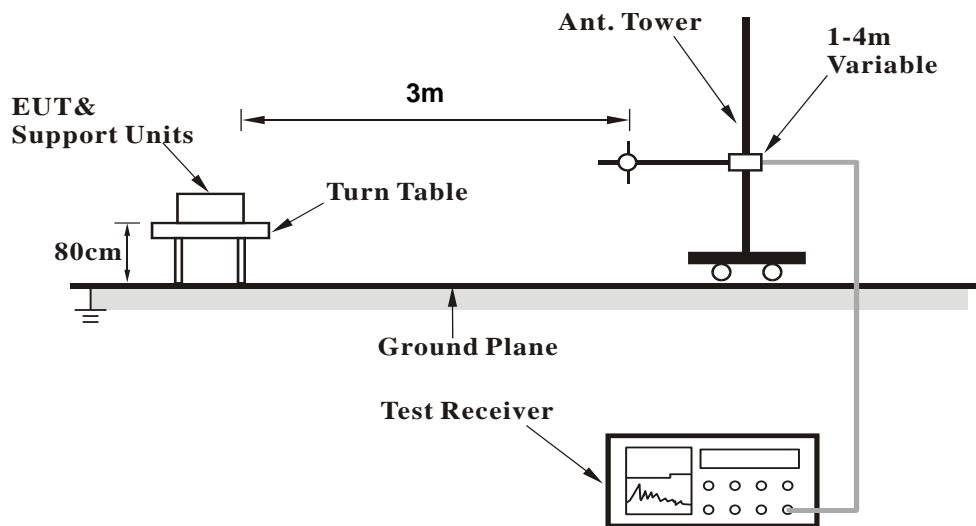

For ERP/EIRP above 1GHz

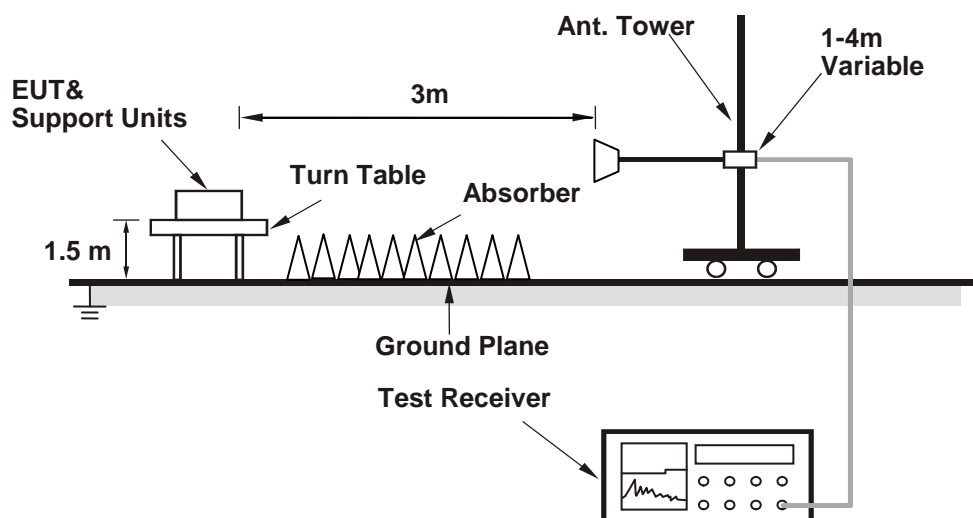

For the actual test configuration, please refer to the attached file (Test Setup Photo).

4.1.4 Test Results

CONDUCTED OUTPUT POWER (dBm)
(Subcontract Item)

Band	WCDMA V		
	4132	4182	4233
Channel	826.4	836.6	846.6
Frequency (MHz)	23.98	23.95	23.96
RMC	22.99	22.94	22.95
HSDPA Subtest-1	22.95	22.92	22.93
HSDPA Subtest-2	22.56	22.47	22.48
HSDPA Subtest-3	22.48	22.45	22.46
HSDPA Subtest-4	23.04	23.01	23.02
HSUPA Subtest-1	21.11	21.05	21.06
HSUPA Subtest-2	22.02	21.99	22.00
HSUPA Subtest-3	21.06	21.03	21.04
HSUPA Subtest-4	23.03	23.00	23.01
HSUPA Subtest-5			

LTE Band 5

Band / BW	RB Size	RB Offset	QPSK			3GPP MPR (dB)	16QAM			3GPP MPR (dB)
			Low CH	Mid CH	High CH		Low CH	Mid CH	High CH	
			20407	20525	20643		20407	20525	20643	
			824.7 MHz	836.5 MHz	848.3 MHz		824.7 MHz	836.5 MHz	848.3 MHz	
5 / 1.4M	1	0	23.05	22.99	23.16	0	22.07	21.97	22.20	1
	1	2	23.01	22.93	23.13	0	22.01	21.94	22.14	1
	1	5	22.96	22.90	23.08	0	21.91	21.87	22.05	1
	3	0	22.97	22.83	23.13	0	21.86	21.83	22.05	1
	3	1	22.80	22.76	22.99	0	21.74	21.70	21.92	1
	3	3	22.71	22.66	22.92	0	21.68	21.62	21.83	1
	6	0	21.99	21.92	22.15	1	20.95	20.87	21.09	2

Band / BW	RB Size	RB Offset	QPSK			3GPP MPR (dB)	16QAM			3GPP MPR (dB)
			Low CH	Mid CH	High CH		Low CH	Mid CH	High CH	
			20415	20525	20635		20415	20525	20635	
			825.5 MHz	836.5 MHz	847.5 MHz		825.5 MHz	836.5 MHz	847.5 MHz	
5 / 3M	1	0	23.10	23.05	23.20	0	22.13	22.09	22.26	1
	1	7	23.07	23.02	23.17	0	22.09	22.04	22.23	1
	1	14	23.02	22.97	23.12	0	22.04	21.98	22.18	1
	8	0	22.24	22.17	22.39	1	21.21	21.17	21.35	2
	8	3	22.15	22.09	22.28	1	21.13	21.06	21.28	2
	8	7	22.07	22.00	22.10	1	21.04	20.95	21.13	2
	15	0	22.13	22.07	22.23	1	21.16	21.04	21.23	2

Band / BW	RB Size	RB Offset	QPSK			3GPP MPR (dB)	16QAM			3GPP MPR (dB)
			Low CH	Mid CH	High CH		Low CH	Mid CH	High CH	
			20425	20525	20625		20425	20525	20625	
			826.5	836.5	846.5		826.5	836.5	846.5	
			MHz	MHz	MHz		MHz	MHz	MHz	
5 / 5M	1	0	23.17	23.13	23.25	0	22.23	22.16	22.31	1
	1	12	23.13	23.11	23.22	0	22.16	22.13	22.28	1
	1	24	23.12	23.07	23.17	0	22.14	22.09	22.22	1
	12	0	22.36	22.28	22.43	1	21.37	21.29	21.46	2
	12	6	22.28	22.24	22.38	1	21.27	21.23	21.39	2
	12	13	22.17	22.15	22.32	1	21.14	21.11	21.30	2
	25	0	22.24	22.21	22.35	1	21.23	21.17	21.34	2

Band / BW	RB Size	RB Offset	QPSK			3GPP MPR (dB)	16QAM			3GPP MPR (dB)
			Low CH	Mid CH	High CH		Low CH	Mid CH	High CH	
			20450	20525	20600		20450	20525	20600	
			829	836.5	844		829	836.5	844	
			MHz	MHz	MHz		MHz	MHz	MHz	
5 / 10M	1	0	23.23	23.20	23.31	0	22.27	22.22	22.36	1
	1	24	23.21	23.18	23.28	0	22.25	22.19	22.33	1
	1	49	23.18	23.15	23.23	0	22.18	22.15	22.29	1
	25	0	22.45	22.41	22.50	1	21.43	21.38	21.50	2
	25	12	22.39	22.37	22.47	1	21.38	21.33	21.48	2
	25	25	22.32	22.30	22.39	1	21.30	21.25	21.37	2
	50	0	22.37	22.35	22.46	1	21.34	21.30	21.43	2

LTE Band 26

Band / BW	RB Size	RB Offset	QPSK			3GPP MPR (dB)	16QAM			3GPP MPR (dB)
			Low CH	Mid CH	High CH		Low CH	Mid CH	High CH	
			26797	26915	27033		26797	26915	27033	
			824.7	836.5	848.3		824.7	836.5	848.3	
			MHz	MHz	MHz		MHz	MHz	MHz	
26 / 1.4M	1	0	23.16	23.16	23.19	0	22.17	22.05	22.24	1
	1	2	23.08	23.01	23.08	0	22.21	21.98	22.17	1
	1	5	22.85	22.83	23.05	0	21.99	22.06	22.08	1
	3	0	23.11	22.88	23.09	0	22.22	22.05	22.17	1
	3	1	22.79	22.95	22.99	0	21.86	21.85	21.97	1
	3	3	22.88	22.80	22.96	0	21.77	22.01	21.96	1
	6	0	21.92	22.01	21.96	1	21.01	21.00	21.02	2

Band / BW	RB Size	RB Offset	QPSK			3GPP MPR (dB)	16QAM			3GPP MPR (dB)
			Low CH	Mid CH	High CH		Low CH	Mid CH	High CH	
			26805	26915	27025		26805	26915	27025	
			825.50	836.50	847.50		825.50	836.50	847.50	
			MHz	MHz	MHz		MHz	MHz	MHz	
26 / 3M	1	0	23.21	23.21	23.24	0	22.07	22.32	22.27	1
	1	7	23.09	23.01	23.15	0	22.10	22.20	22.16	1
	1	14	22.90	22.98	23.08	0	21.96	21.98	22.11	1
	8	0	22.15	22.07	22.25	1	21.09	21.27	21.25	2
	8	3	22.13	22.00	22.21	1	21.19	21.19	21.22	2
	8	7	22.12	22.03	22.15	1	21.03	21.05	21.17	2
	15	0	22.17	22.02	22.12	1	20.98	21.18	21.13	2

Band / BW	RB Size	RB Offset	QPSK			3GPP MPR (dB)	16QAM			3GPP MPR (dB)
			Low CH	Mid CH	High CH		Low CH	Mid CH	High CH	
			26815	26915	27015		26815	26915	27015	
			826.50	836.50	846.50		826.50	836.50	846.50	
			MHz	MHz	MHz		MHz	MHz	MHz	
26 / 5M	1	0	23.17	23.25	23.29	0	22.22	22.19	22.34	1
	1	12	23.21	23.20	23.20	0	22.24	22.08	22.24	1
	1	24	22.98	23.08	23.14	0	22.21	22.11	22.17	1
	12	0	22.45	22.35	22.44	1	21.35	21.41	21.43	2
	12	6	22.21	22.27	22.32	1	21.35	21.21	21.32	2
	12	13	22.29	22.19	22.30	1	21.24	21.22	21.27	2
	25	0	22.06	22.12	22.24	1	21.09	21.10	21.22	2

Band / BW	RB Size	RB Offset	QPSK			3GPP MPR (dB)	16QAM			3GPP MPR (dB)
			Low CH	Mid CH	High CH		Low CH	Mid CH	High CH	
			26840	26915	26990		26840	26915	26990	
			829	836.5	844		829	836.5	844	
			MHz	MHz	MHz		MHz	MHz	MHz	
26 / 10M	1	0	23.01	23.23	23.33	0	22.09	22.1	22.39	1
	1	24	23.15	23.16	23.25	0	21.94	22.12	22.27	1
	1	49	22.84	22.76	23.20	0	21.79	22.01	22.24	1
	25	0	22.24	22.09	22.47	1	21.21	21.21	21.49	2
	25	12	22.05	22.08	22.40	1	21.05	21.11	21.44	2
	25	25	22.10	22.15	22.39	1	20.97	21.16	21.39	2
	50	0	22.08	22.13	22.36	1	21.16	21.19	21.37	2

Band / BW	RB Size	RB Offset	QPSK			3GPP MPR (dB)	16QAM			3GPP MPR (dB)
			Low CH	Mid CH	High CH		Low CH	Mid CH	High CH	
			26865	26915	26965		26865	26915	26965	
			831.5	836.5	841.5		831.5	836.5	841.5	
			MHz	MHz	MHz		MHz	MHz	MHz	
26 / 15M	1	0	23.37	23.20	23.39	0	22.24	22.19	22.44	1
	1	37	23.27	23.27	23.31	0	22.17	22.05	22.35	1
	1	74	23.25	23.20	23.27	0	22.10	22.13	22.30	1
	36	0	22.52	22.41	22.63	1	21.39	21.38	21.60	2
	36	19	22.49	22.45	22.51	1	21.32	21.31	21.50	2
	36	39	22.48	22.34	22.50	1	21.30	21.16	21.48	2
	75	0	22.45	22.31	22.47	1	21.27	21.25	21.45	2

ERP POWER

WCDMA

Channel	Frequency (MHz)	Antenna Polarization	LVL (dBm)	Correction Factor(dB)	ERP(dBm)	ERP(mW)
4132	826.4	H	21.06	1.28	22.34	171.40
4182	836.6	H	21.37	1.17	22.54	179.47
4233	846.6	H	21.20	1.07	22.27	168.66

Note: The worst case vertical or horizontal polarization have been investigated and find the worst is horizontal.

LTE Band 5 / 1.4M

Channel	Frequency (MHz)	Antenna Polarization	LVL (dBm)	Correction Factor(dB)	ERP(dBm)	ERP(mW)
20407	824.7	H	19.99	1.30	21.29	134.59
20525	836.5	H	20.33	1.17	21.50	141.25
20643	848.3	H	20.00	1.05	21.05	127.35

Note: The worst case vertical or horizontal polarization have been investigated and find the worst is horizontal.

LTE Band 5 / 3M

Channel	Frequency (MHz)	Antenna Polarization	LVL (dBm)	Correction Factor(dB)	ERP(dBm)	ERP(mW)
20145	825.5	H	19.65	1.29	20.94	124.17
20525	836.5	H	20.32	1.17	21.49	140.93
20635	847.5	H	20.28	1.06	21.34	136.14

Note: The worst case vertical or horizontal polarization have been investigated and find the worst is horizontal.

LTE Band 5 / 5M

Channel	Frequency (MHz)	Antenna Polarization	LVL (dBm)	Correction Factor(dB)	ERP(dBm)	ERP(mW)
20425	826.5	H	19.76	1.28	21.04	127.06
20525	836.5	H	20.34	1.17	21.51	141.58
20625	846.5	H	20.37	1.07	21.44	139.32

Note: The worst case vertical or horizontal polarization have been investigated and find the worst is horizontal.

LTE Band 5 / 10M

Channel	Frequency (MHz)	Antenna Polarization	LVL (dBm)	Correction Factor(dB)	ERP(dBm)	ERP(mW)
20450	829	H	19.80	1.25	21.05	127.35
20525	836.5	H	20.41	1.17	21.58	143.88
20600	844	H	20.28	1.09	21.37	137.09

Note: The worst case vertical or horizontal polarization have been investigated and find the worst is horizontal.

LTE Band 26 / 1.4M

Channel	Frequency (MHz)	Antenna Polarization	LVL (dBm)	Correction Factor(dB)	ERP(dBm)	ERP(mW)
26797	824.7	H	18.84	1.30	20.14	103.28
26915	836.5	H	19.24	1.17	20.41	109.90
27033	848.3	H	19.31	1.05	20.36	108.64

Note: The worst case vertical or horizontal polarization have been investigated and find the worst is horizontal.

LTE Band 26 / 3M

Channel	Frequency (MHz)	Antenna Polarization	LVL (dBm)	Correction Factor(dB)	ERP(dBm)	ERP(mW)
26805	825.5	H	18.92	1.29	20.21	104.95
26915	836.5	H	19.32	1.17	20.49	111.94
27025	847.5	H	19.39	1.06	20.45	110.92

Note: The worst case vertical or horizontal polarization have been investigated and find the worst is horizontal.

LTE Band 26 / 5M

Channel	Frequency (MHz)	Antenna Polarization	LVL (dBm)	Correction Factor(dB)	ERP(dBm)	ERP(mW)
26815	826.5	H	19.06	1.28	20.34	108.14
26915	836.5	H	19.33	1.17	20.50	112.20
27015	846.5	H	19.39	1.07	20.46	111.17

Note: The worst case vertical or horizontal polarization have been investigated and find the worst is horizontal.

LTE Band 26 / 10M

Channel	Frequency (MHz)	Antenna Polarization	LVL (dBm)	Correction Factor(dB)	ERP(dBm)	ERP(mW)
26840	829	H	19.18	1.25	20.43	110.41
26915	836.5	H	19.49	1.17	20.66	116.41
26990	844	H	19.52	1.09	20.61	115.08

Note: The worst case vertical or horizontal polarization have been investigated and find the worst is horizontal.

LTE Band 26 / 15M

Channel	Frequency (MHz)	Antenna Polarization	LVL (dBm)	Correction Factor(dB)	ERP(dBm)	ERP(mW)
26865	831.5	H	18.22	1.25	19.47	88.51
26915	836.5	H	18.38	1.17	19.55	90.16
26965	841.5	H	17.99	1.09	19.08	80.91

Note: The worst case vertical or horizontal polarization have been investigated and find the worst is horizontal.

4.2 Frequency Stability Measurement

4.2.1 Limits of Frequency Stability Measurement

1.5 ppm is for base and fixed station. 2.5 ppm is for mobile station.

4.2.2 Test Procedure

- Device is placed at the oven room. The oven room could control the temperatures and humidity. Power warm up is at least 15 min and power applied should perform before recording frequency error.
- EUT is connected the external power supply to control the DC input power. The test voltage range is from minimum to maximum working voltage. Each step shall be record the frequency error rate.
- The temperature range step is 10 degrees in this test items. All temperature levels shall be hold the ± 0.5 °C during the measurement testing. The each temperature step shall be at least 0.5 hours, consider the EUT could be test under the stability condition.

NOTE: The frequency error was recorded frequency error from the communication simulator.

4.2.3 Test Setup

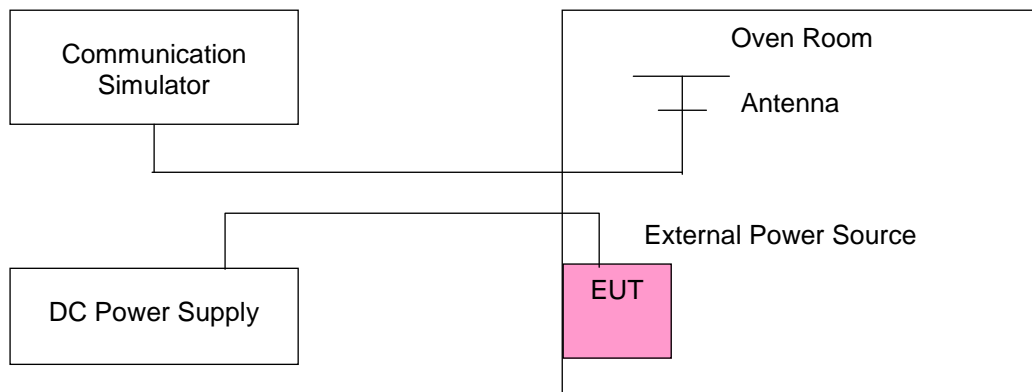

4.2.4 Test Results (Subcontract Item)

WCDMA

Frequency Error vs. Voltage

Voltage (Volts)	Frequency Error (ppm)	Limit (ppm)
	WCDMA	
3.3	0.002	2.5
2.805	0.005	2.5
3.795	0.002	2.5

Frequency Error vs. Temperature.

TEMP. (°C)	Frequency Error (ppm)	Limit (ppm)
	WCDMA	
-30	0.005	2.5
-20	0.003	2.5
-10	0.004	2.5
0	0.004	2.5
10	0.002	2.5
20	-0.003	2.5
30	-0.003	2.5
40	-0.003	2.5
50	-0.004	2.5

LTE

Frequency Error vs. Voltage

Voltage (Volts)	Frequency Error (ppm)									Limit (ppm)
	LTE Band 5				LTE Band 26					
	1.4MHz	3MHz	5MHz	10MHz	1.4MHz	3MHz	5MHz	10MHz	15MHz	
3.3	0.004	0.004	0.005	0.003	0.003	0.004	0.002	0.003	0.004	2.5
2.805	0.003	0.003	0.005	0.002	0.002	0.002	0.004	0.001	0.005	2.5
3.795	0.001	0.002	0.004	0.002	0.002	0.001	0.003	0.004	0.003	2.5

Frequency Error vs. Temperature

Temp. (°C)	Frequency Error (ppm)									Limit (ppm)
	LTE Band 5				LTE Band 26					
	1.4MHz	3MHz	5MHz	10MHz	1.4MHz	3MHz	5MHz	10MHz	15MHz	
-30	0.002	0.005	0.004	0.002	0.002	0.003	0.001	0.004	0.002	2.5
-20	0.003	0.004	0.004	0.003	0.005	0.002	0.003	0.003	0.005	2.5
-10	0.003	0.003	0.001	0.004	0.004	0.002	0.002	0.002	0.004	2.5
0	0.005	0.005	0.002	0.003	0.002	0.004	0.002	0.004	0.003	2.5
10	0.004	0.004	0.005	0.002	0.002	0.002	0.003	0.001	0.003	2.5
20	-0.003	-0.004	-0.005	-0.002	-0.004	-0.002	-0.003	-0.002	-0.001	2.5
30	-0.002	-0.001	-0.003	-0.002	-0.004	-0.002	-0.004	-0.001	-0.002	2.5
40	-0.004	-0.004	-0.003	-0.003	-0.005	-0.002	-0.004	-0.002	-0.001	2.5
50	-0.004	-0.003	-0.004	-0.002	-0.002	-0.004	-0.005	-0.004	-0.003	2.5

4.3 Occupied Bandwidth Measurement

4.3.1 Test Procedure

All measurements were done at low, middle and high operational frequency range. The communication simulator station system controlled a EUT to export maximum output power under transmission mode and specific channel frequency. Use OBW measurement function of Spectrum analyzer to measure 99 % occupied bandwidth.

4.3.2 Test Setup

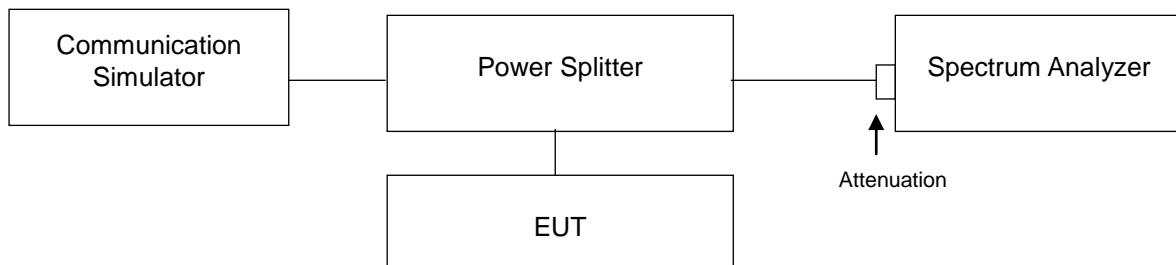

4.3.3 Test Result (-26dB Bandwidth, Subcontract Item)

Channel	FREQ. (MHz)	-26dB Bandwidth (MHz)
		WCDMA
4132	826.4	4.80
4182	836.4	4.78
4233	846.6	4.78

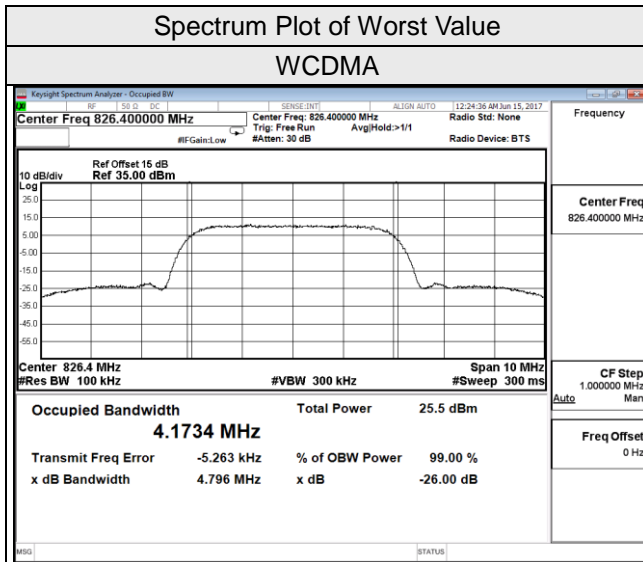

LTE Band 5							
Channel Bandwidth 1.4MHz				Channel Bandwidth 3MHz			
Channel	Frequency (MHz)	-26dB Bandwidth (MHz)		Channel	Frequency (MHz)	-26dB Bandwidth (MHz)	
		QPSK	16QAM			QPSK	16QAM
20407	824.7	1.23	1.22	20415	825.5	2.97	2.95
20525	836.5	1.23	1.22	20525	836.5	2.95	2.95
20643	848.3	1.24	1.23	20635	847.5	2.97	2.95
Channel Bandwidth 5MHz				Channel Bandwidth 10MHz			
Channel	Frequency (MHz)	-26dB Bandwidth (MHz)		Channel	Frequency (MHz)	-26dB Bandwidth (MHz)	
		QPSK	16QAM			QPSK	16QAM
20425	826.5	4.84	4.82	20450	829	9.55	9.53
20525	836.5	4.83	4.81	20525	836.5	9.54	9.54
20625	846.5	4.81	4.85	20600	844	9.55	9.53

Spectrum Plot of Worst Value

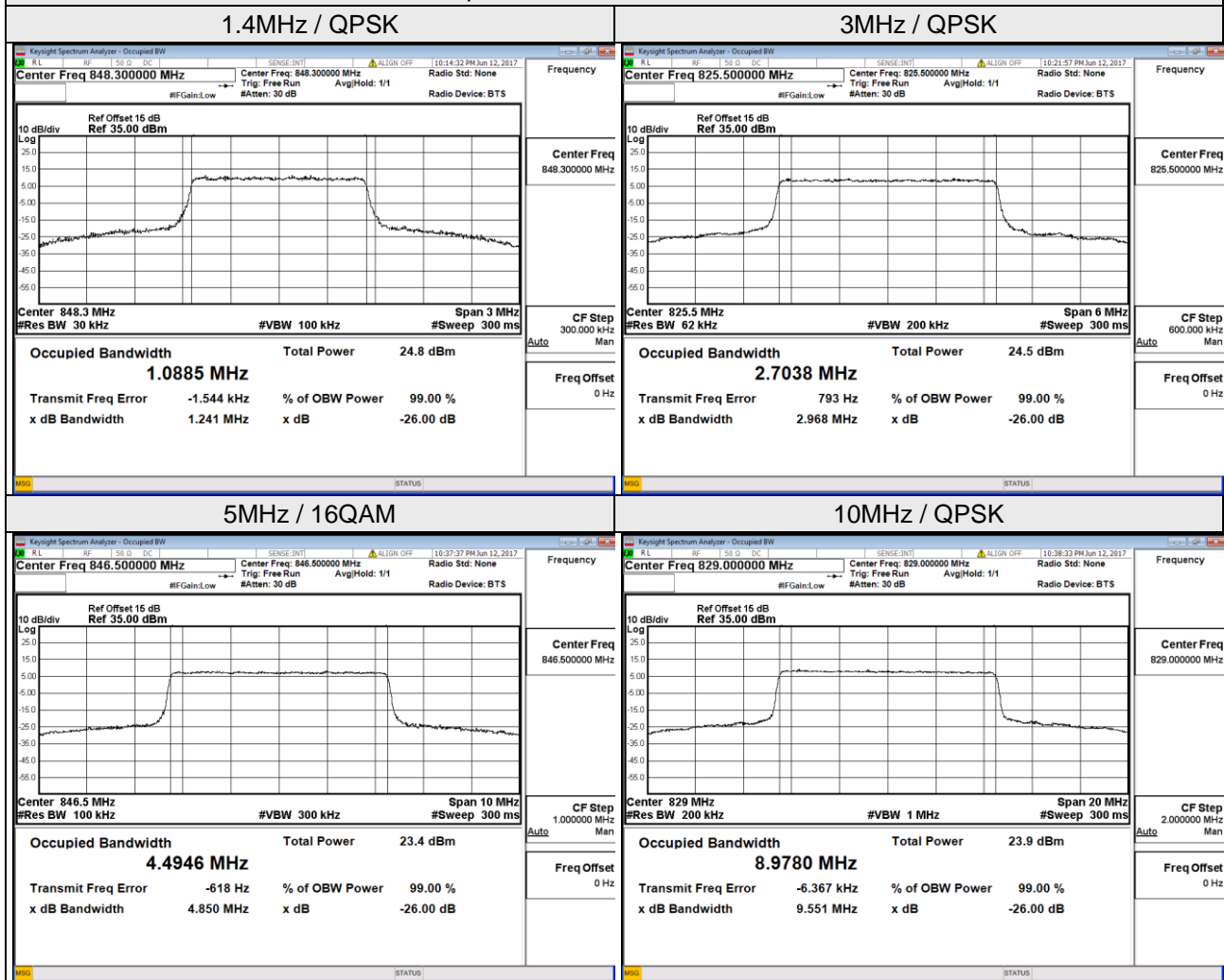

LTE Band 26							
Channel Bandwidth 1.4MHz				Channel Bandwidth 3MHz			
Channel	Frequency (MHz)	-26dB Bandwidth (MHz)		Channel	Frequency (MHz)	-26dB Bandwidth (MHz)	
		QPSK	16QAM			QPSK	16QAM
26797	824.7	1.23	1.22	26805	825.5	2.98	2.96
26915	836.5	1.24	1.22	26915	836.5	2.95	2.94
27033	848.3	1.25	1.24	27025	847.5	3.00	2.97
Channel Bandwidth 5MHz				Channel Bandwidth 10MHz			
Channel	Frequency (MHz)	-26dB Bandwidth (MHz)		Channel	Frequency (MHz)	-26dB Bandwidth (MHz)	
		QPSK	16QAM			QPSK	16QAM
26815	826.5	4.85	4.82	26840	829	9.60	9.56
26915	836.5	4.84	4.83	26915	836.5	9.56	9.55
27015	846.5	4.90	4.85	26990	844	9.60	9.54
Channel Bandwidth 15MHz							
Channel	Frequency (MHz)	-26dB Bandwidth (MHz)					
		QPSK	16QAM				
26865	831.5	14.41	14.30				
26915	836.5	14.35	14.29				
26965	841.5	14.41	14.29				

Spectrum Plot of Worst Value

1.4MHz / QPSK

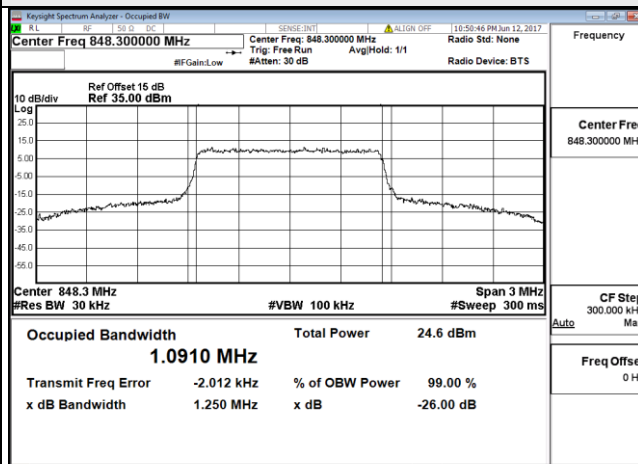

3MHz / QPSK

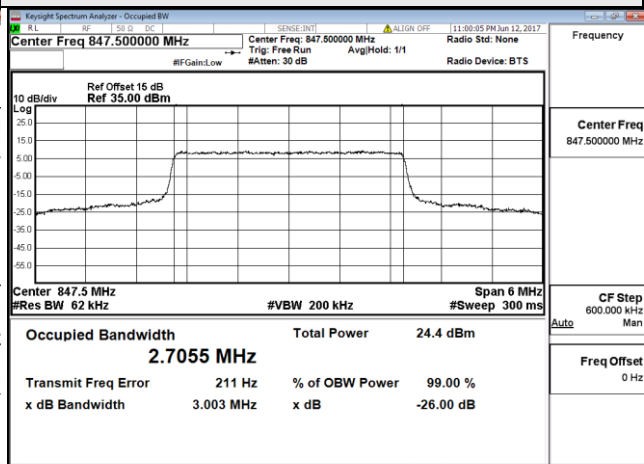

5MHz / QPSK

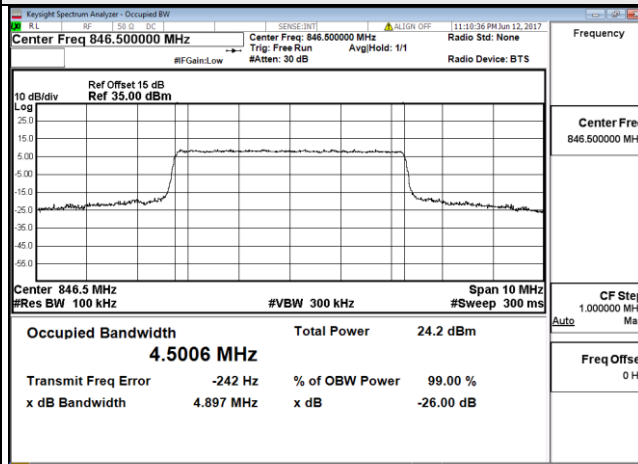

10MHz / QPSK

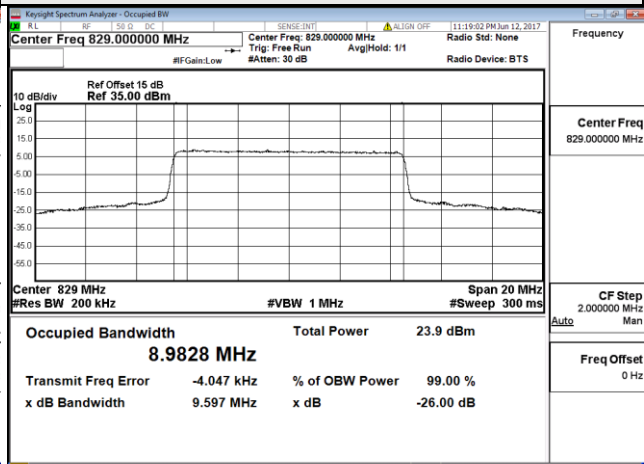

15MHz / QPSK

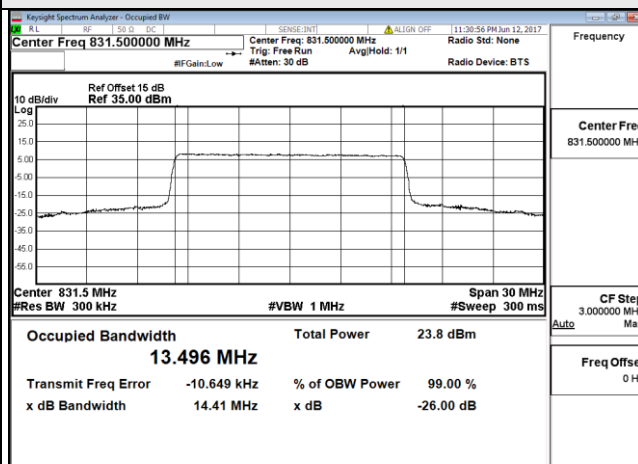

4.3.4 Test Result (Occupied Bandwidth, Subcontract Item)

Channel	FREQ. (MHz)	99% Occupied Bandwidth (MHz)
		WCDMA
4132	826.4	4.17
4182	836.6	4.17
4233	846.6	4.16

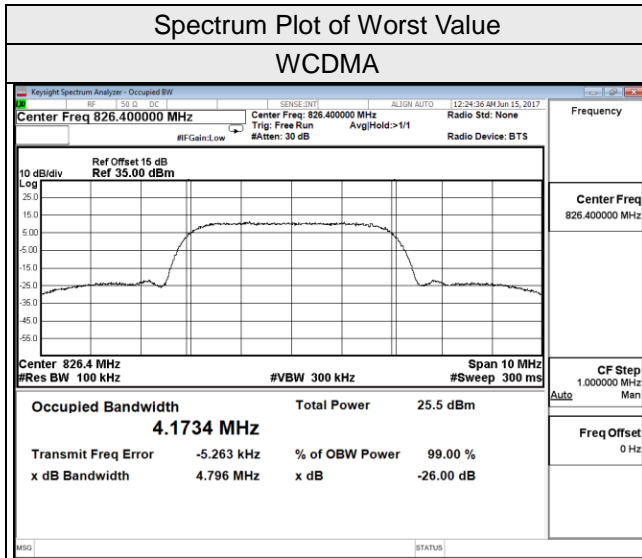

LTE Band 5							
Channel Bandwidth 1.4MHz				Channel Bandwidth 3MHz			
Channel	Frequency (MHz)	99% Occupied Bandwidth (MHz)		Channel	Frequency (MHz)	99% Occupied Bandwidth (MHz)	
		QPSK	16QAM			QPSK	16QAM
20407	824.7	1.09	1.09	20415	825.5	2.70	2.70
20525	836.5	1.09	1.09	20525	836.5	2.70	2.70
20643	848.3	1.09	1.09	20635	847.5	2.71	2.70
Channel Bandwidth 5MHz				Channel Bandwidth 10MHz			
Channel	Frequency (MHz)	99% Occupied Bandwidth (MHz)		Channel	Frequency (MHz)	99% Occupied Bandwidth (MHz)	
		QPSK	16QAM			QPSK	16QAM
20425	826.5	4.49	4.49	20450	829	8.98	8.97
20525	836.5	4.49	4.49	20525	836.5	8.97	8.97
20625	846.5	4.50	4.49	20600	844	8.98	8.98

Spectrum Plot of Worst Value

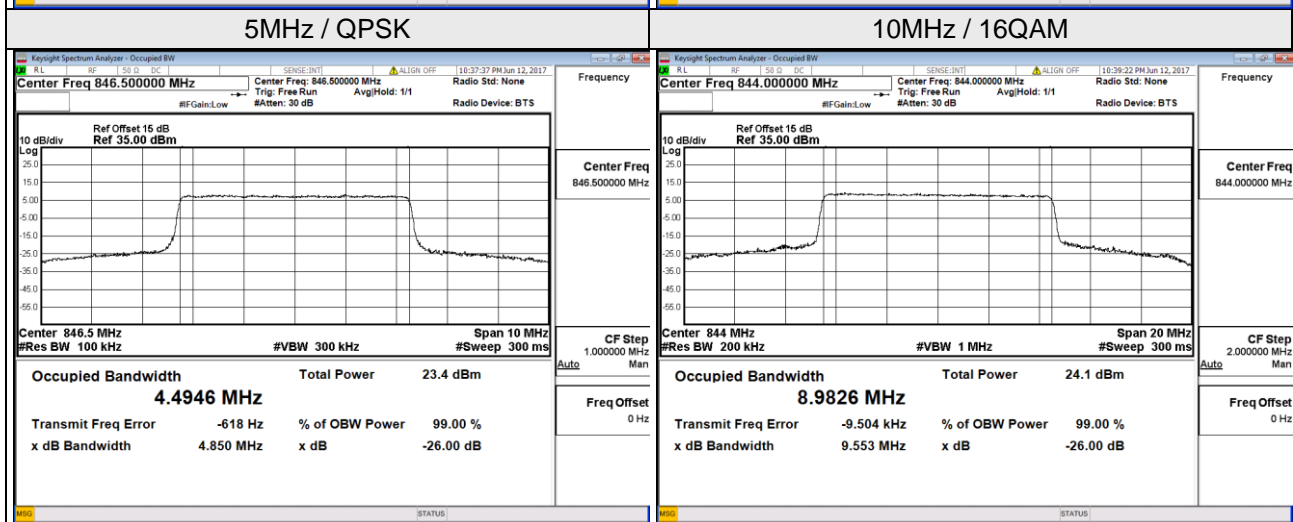
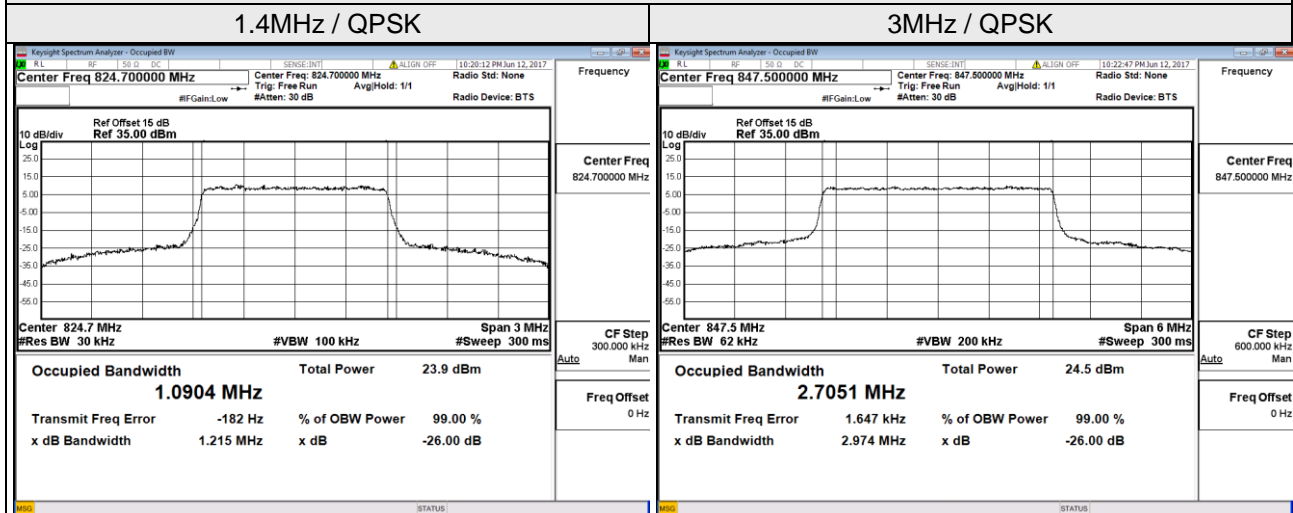

LTE Band 26							
Channel Bandwidth 1.4MHz				Channel Bandwidth 3MHz			
Channel	Frequency (MHz)	99% Occupied Bandwidth (MHz)		Channel	Frequency (MHz)	99% Occupied Bandwidth (MHz)	
		QPSK	16QAM			QPSK	16QAM
26797	824.7	1.09	1.09	26805	825.5	2.71	2.70
26915	836.5	1.09	1.09	26915	836.5	2.70	2.70
27033	848.3	1.09	1.09	27025	847.5	2.71	2.70
Channel Bandwidth 5MHz				Channel Bandwidth 10MHz			
Channel	Frequency (MHz)	99% Occupied Bandwidth (MHz)		Channel	Frequency (MHz)	99% Occupied Bandwidth (MHz)	
		QPSK	16QAM			QPSK	16QAM
26815	826.5	4.50	4.49	26840	829	8.98	8.98
26915	836.5	4.49	4.49	26915	836.5	8.98	8.97
27015	846.5	4.50	4.49	26990	844	8.98	8.98
Channel Bandwidth 15MHz							
Channel	Frequency (MHz)	99% Occupied Bandwidth (MHz)					
		QPSK	16QAM				
26865	831.5	13.50	13.48				
26915	836.5	13.48	13.45				
26965	841.5	13.48	13.46				

Spectrum Plot of Worst Value

1.4MHz / QPSK

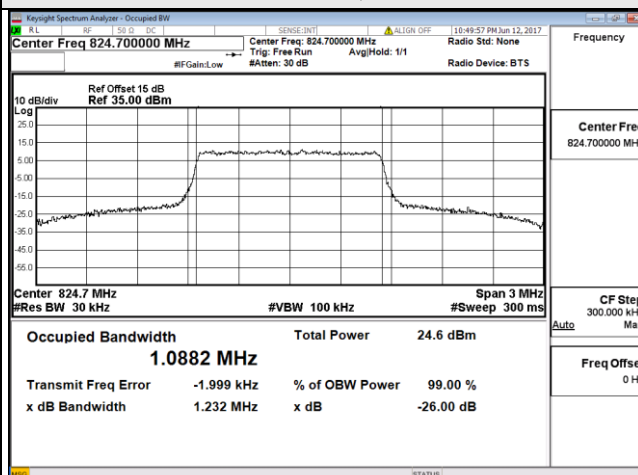

3MHz / QPSK

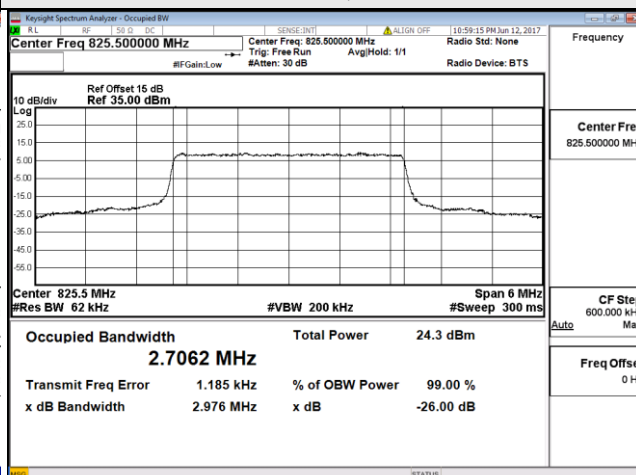

5MHz / QPSK

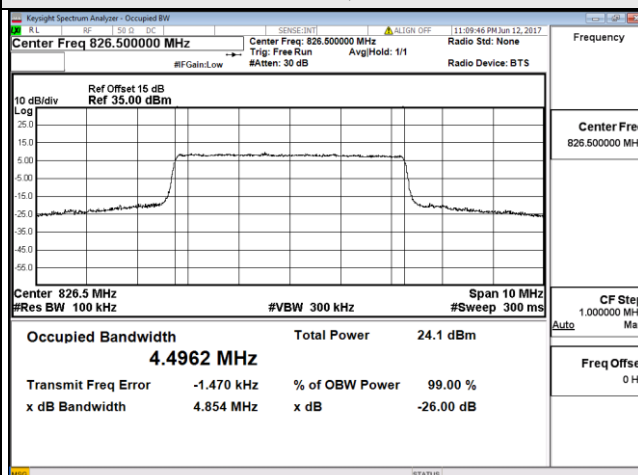

10MHz / QPSK

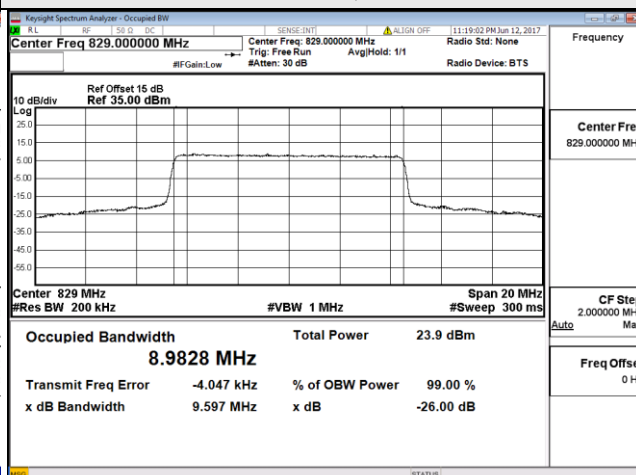

15MHz / QPSK

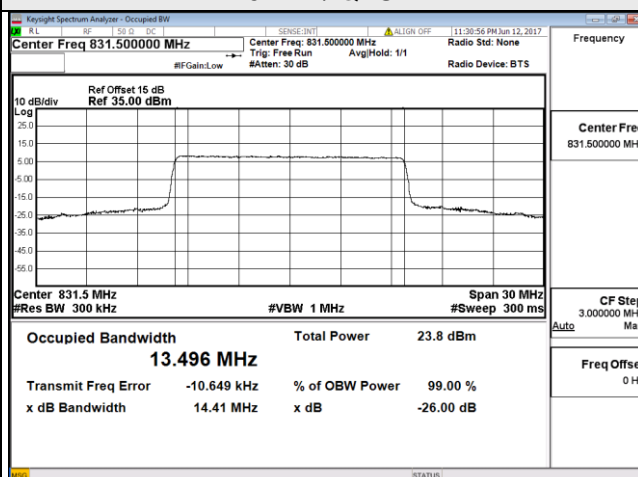

4.4 Band Edge Measurement

4.4.1 Limits of Band Edge Measurement

Power of any emission outside of the authorized operating frequency ranges must be attenuated below the transmitting power (P) by a factor of at least $43 + 10 \log(P)$ dB. In the 1 MHz bands immediately outside and adjacent to the frequency block a resolution bandwidth of at least one percent of the emission bandwidth of the fundamental emission of the transmitter may be employed.

4.4.2 Test Setup

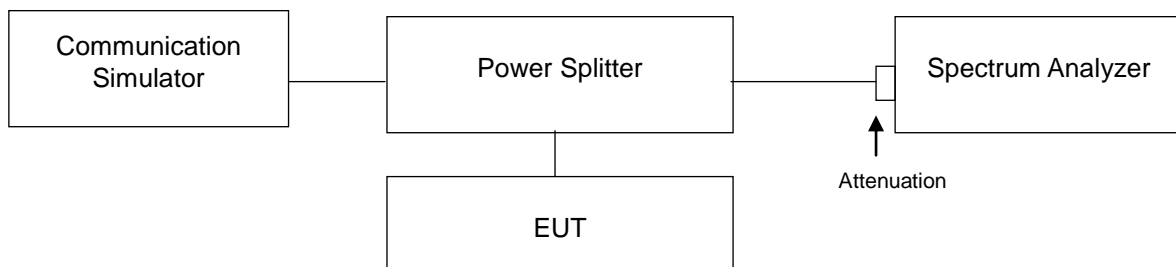

4.4.3 Test Procedures

- a. All measurements were done at low and high operational frequency range.
- b. The center frequency of spectrum is the band edge frequency and s RB of the spectrum is $>1\%$ EMISSION BANDWIDTH and VB of the spectrum is $\geq 3*RB$.
- c. Record the max trace plot into the test report.

4.4.4 Test Results (Subcontract Item)

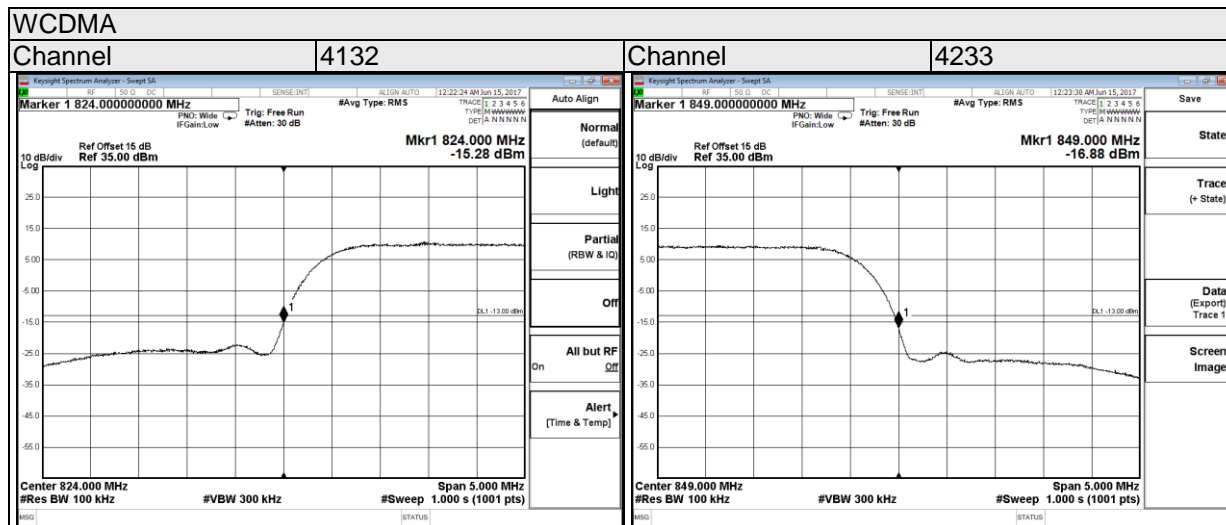

LTE Band 5

Channel Bandwidth 1.4MHz

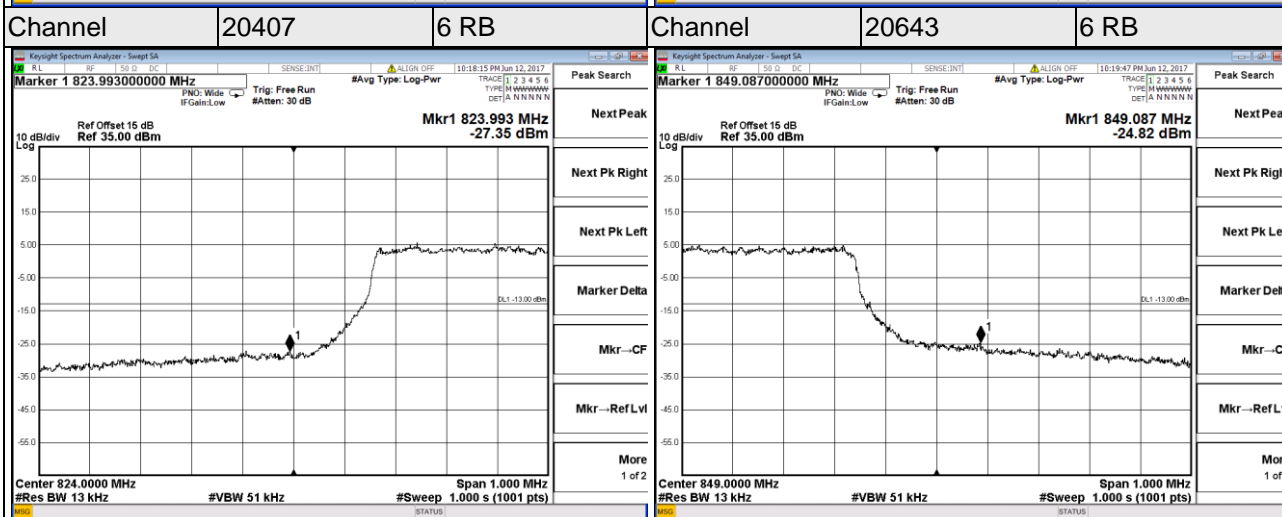
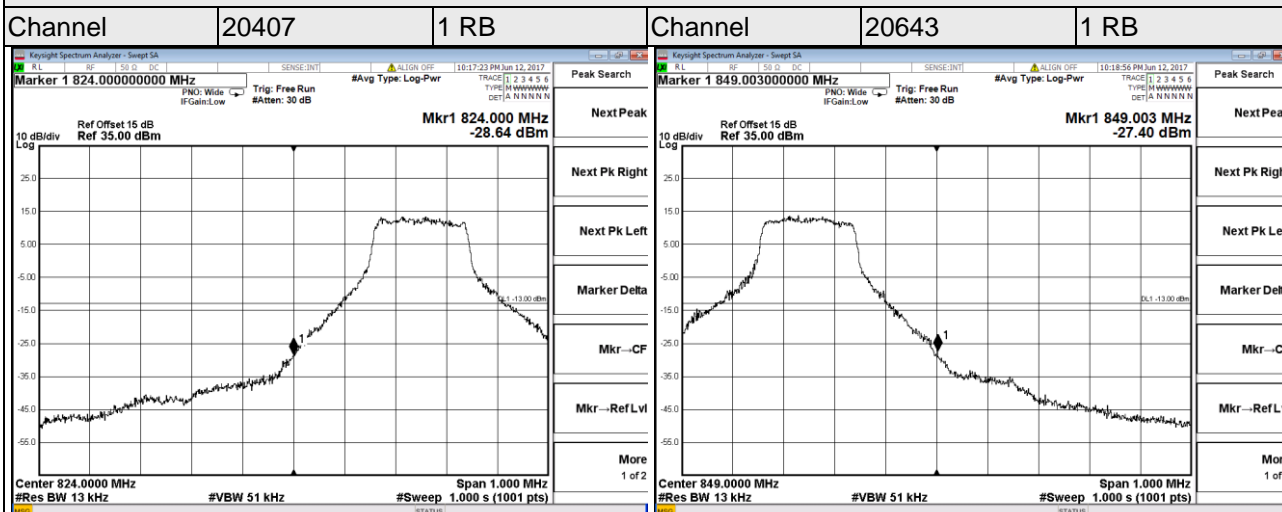

LTE Band 5

Channel Bandwidth 3MHz

Channel	20415	1 RB	Channel	20635	1 RB
---------	-------	------	---------	-------	------

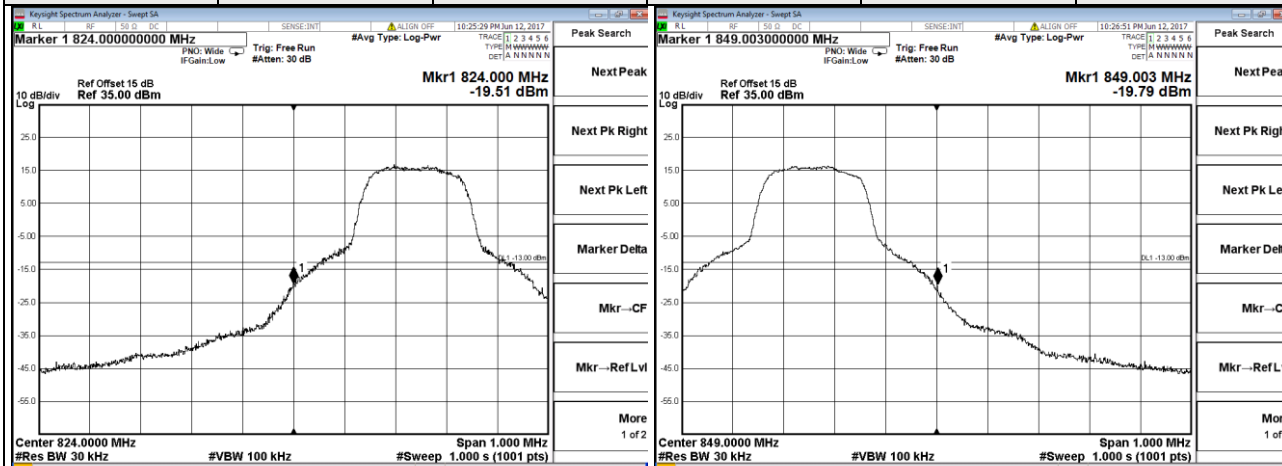

Channel	20415	15 RB	Channel	20635	15 RB
---------	-------	-------	---------	-------	-------

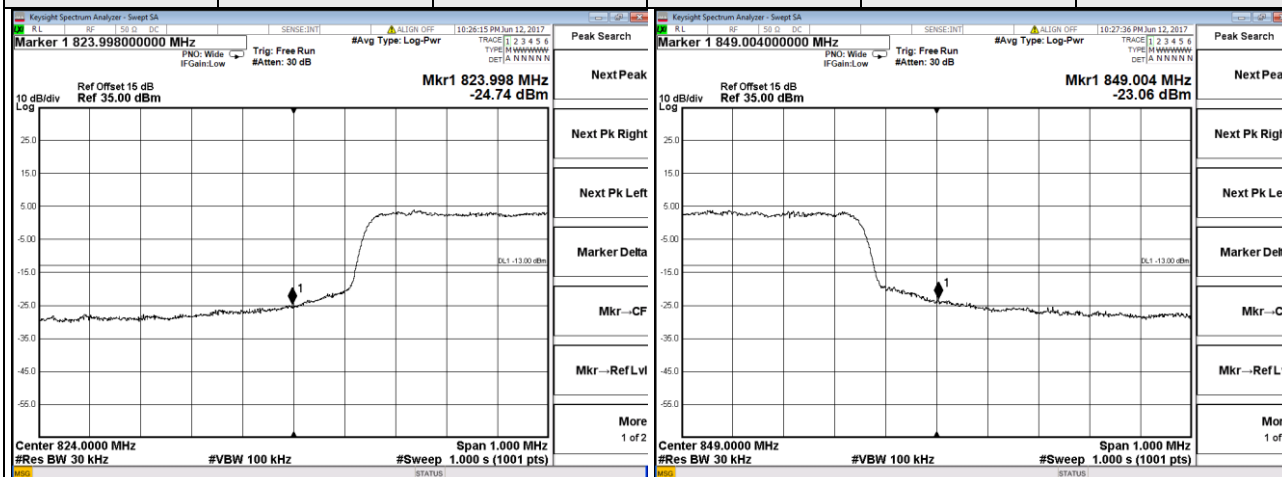

LTE Band 5

Channel Bandwidth 5MHz

Channel	20425	1 RB	Channel	20625	1 RB
---------	-------	------	---------	-------	------

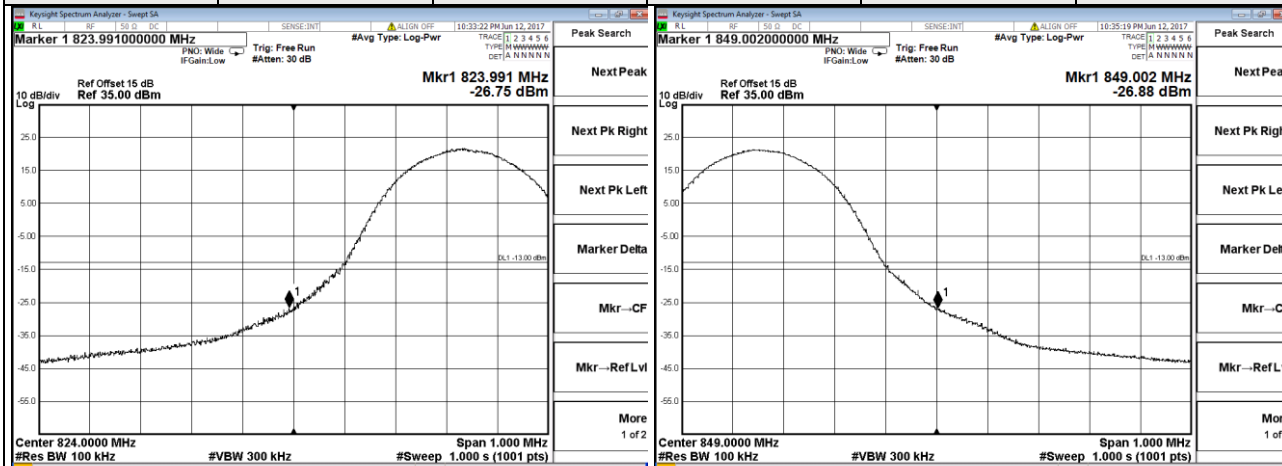

Channel	20425	25 RB	Channel	20625	25 RB
---------	-------	-------	---------	-------	-------

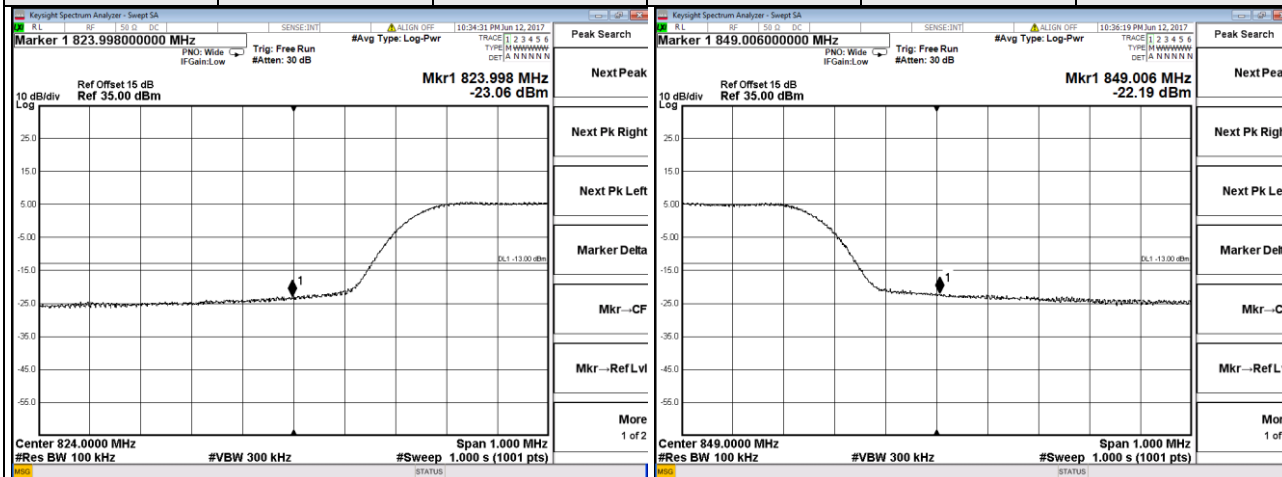

LTE Band 5

Channel Bandwidth 10MHz

Channel	20450	1 RB	Channel	20600	1 RB
---------	-------	------	---------	-------	------

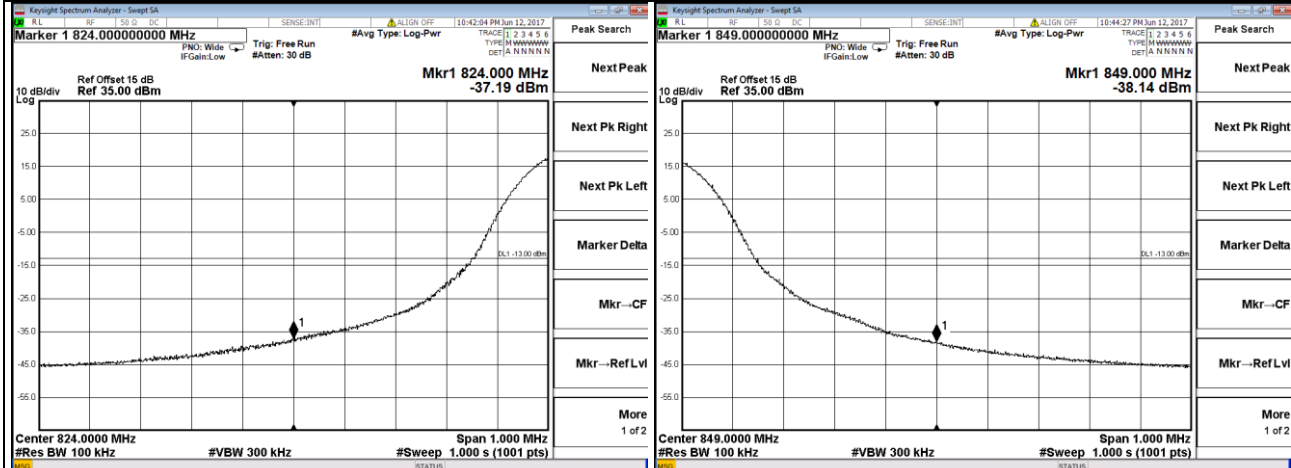

Channel	20450	50 RB	Channel	20600	50 RB
---------	-------	-------	---------	-------	-------

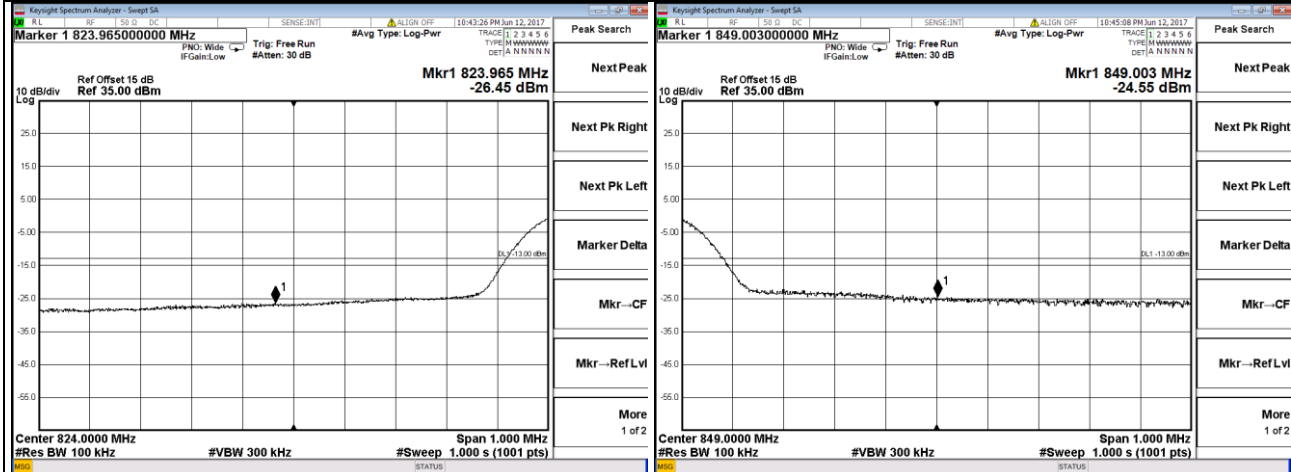

LTE Band 26

Channel Bandwidth 1.4MHz

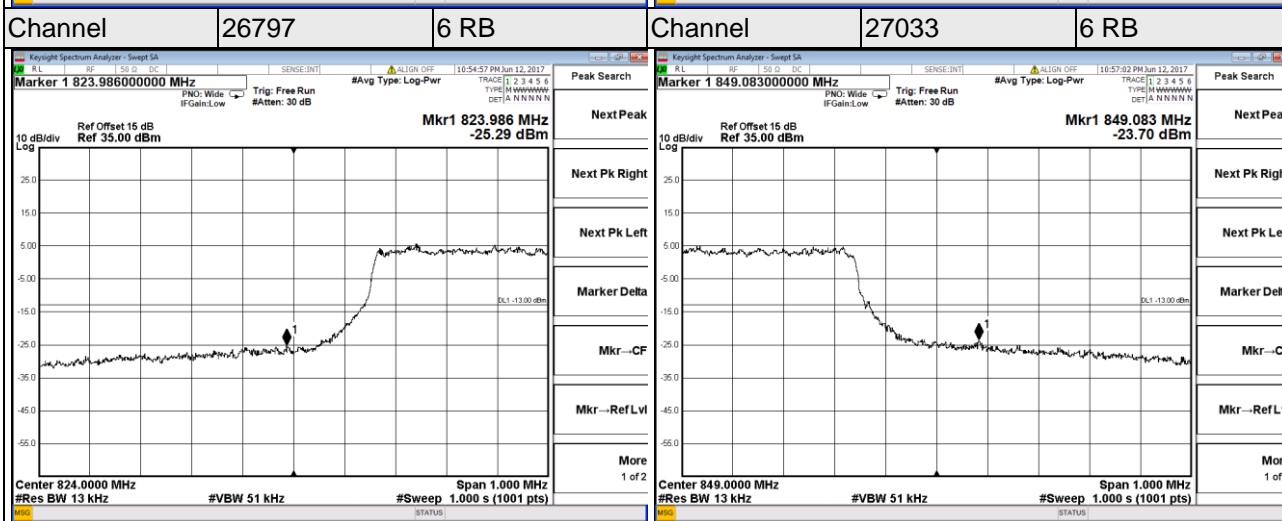
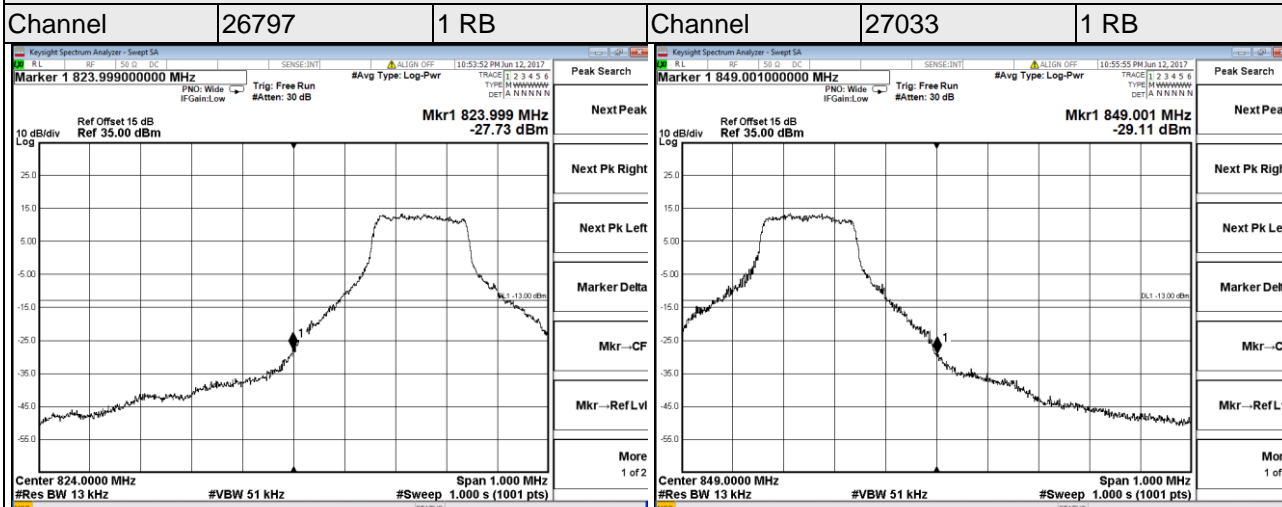

LTE Band 26

Channel Bandwidth 3MHz

Channel	26805	1 RB	Channel	27025	1 RB
---------	-------	------	---------	-------	------

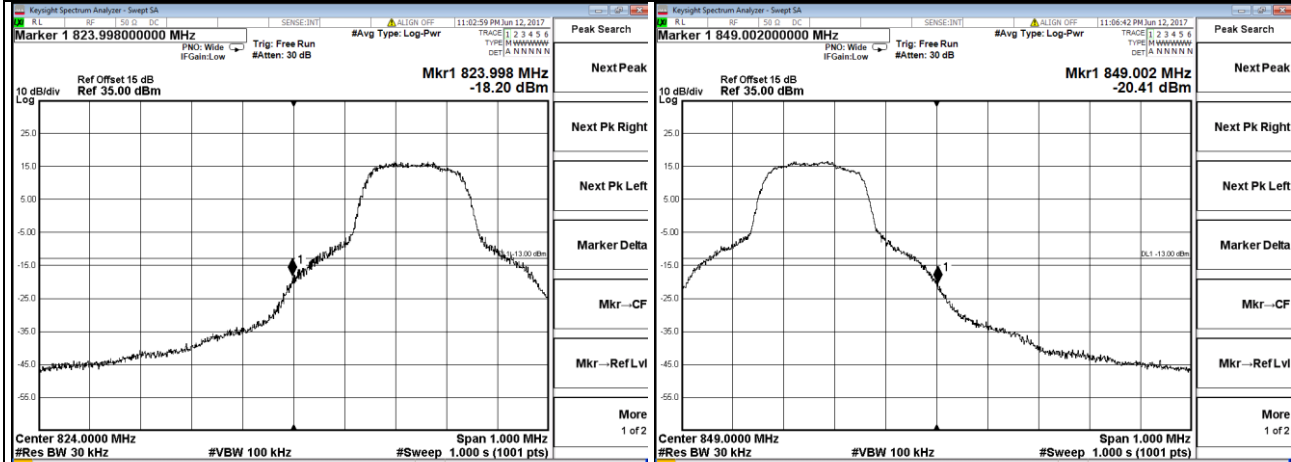

Channel	26805	15 RB	Channel	27025	15 RB
---------	-------	-------	---------	-------	-------

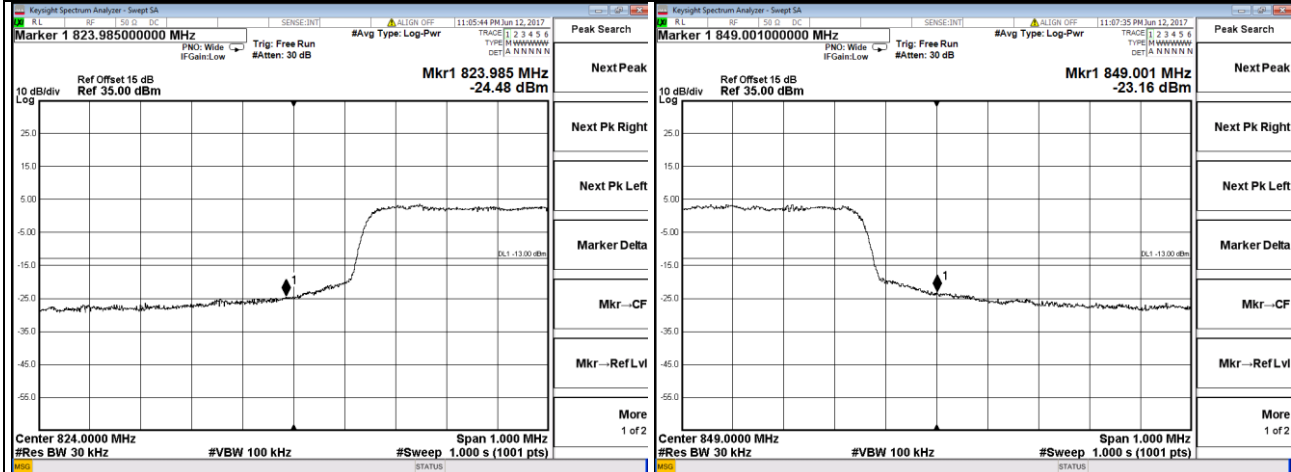

LTE Band 26

Channel Bandwidth 5MHz

Channel	26815	1 RB	Channel	27015	1 RB
---------	-------	------	---------	-------	------

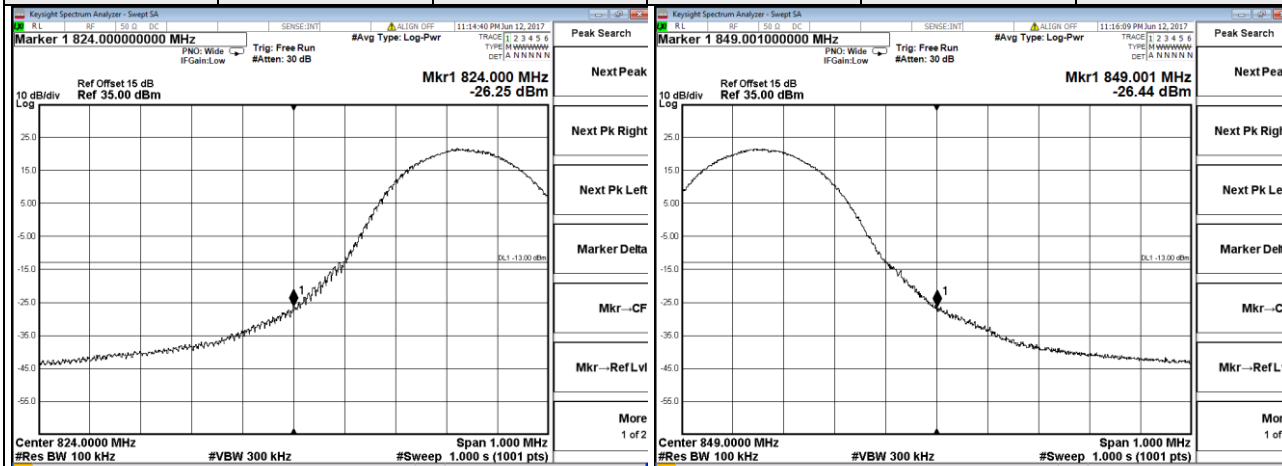

Channel	26815	25 RB	Channel	27015	25 RB
---------	-------	-------	---------	-------	-------

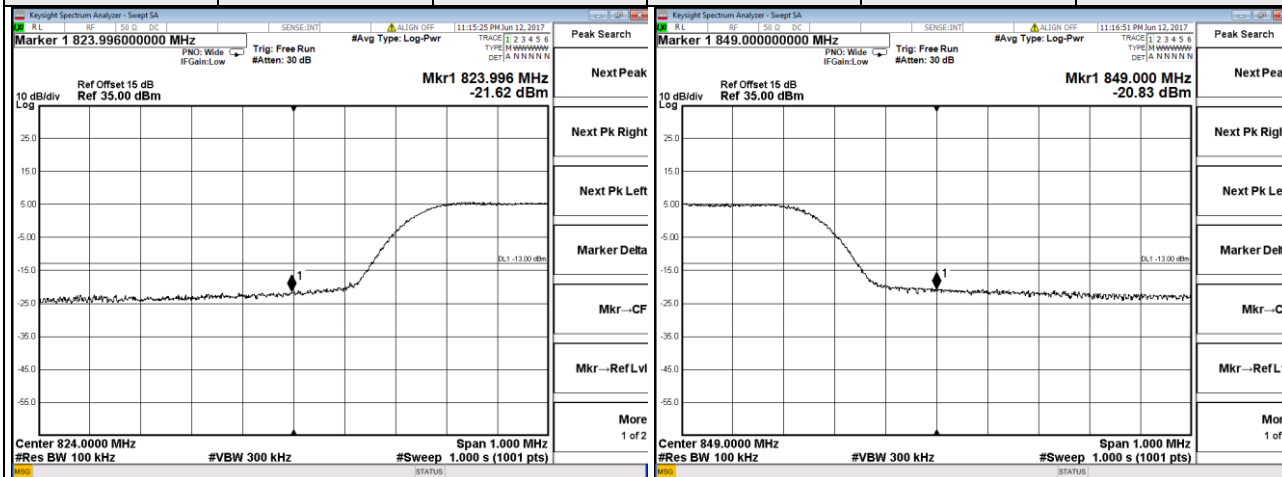

LTE Band 26

Channel Bandwidth 10MHz

Channel	26840	1 RB	Channel	26990	1 RB
---------	-------	------	---------	-------	------

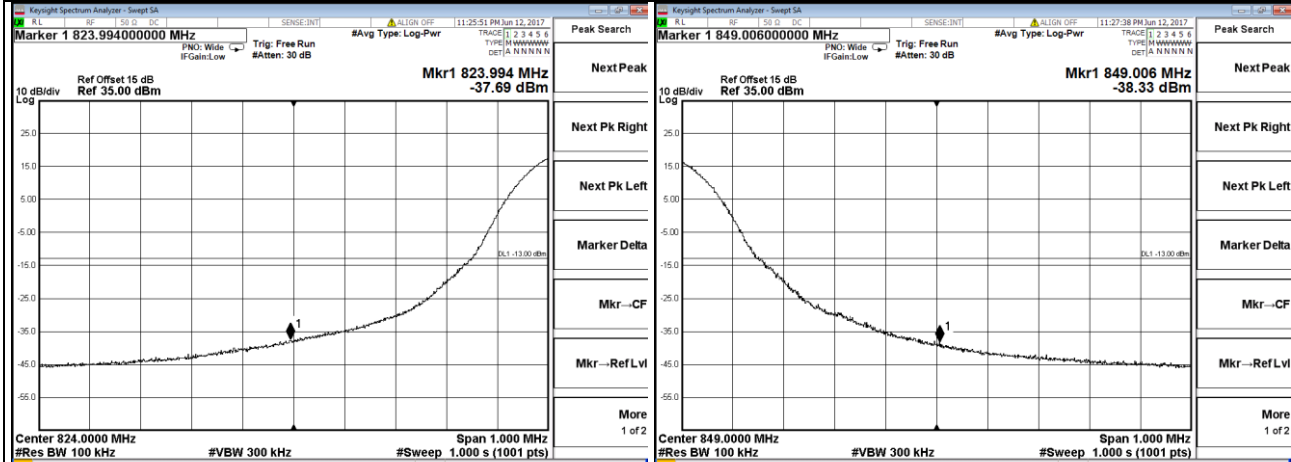

Channel	26840	50 RB	Channel	26990	50 RB
---------	-------	-------	---------	-------	-------

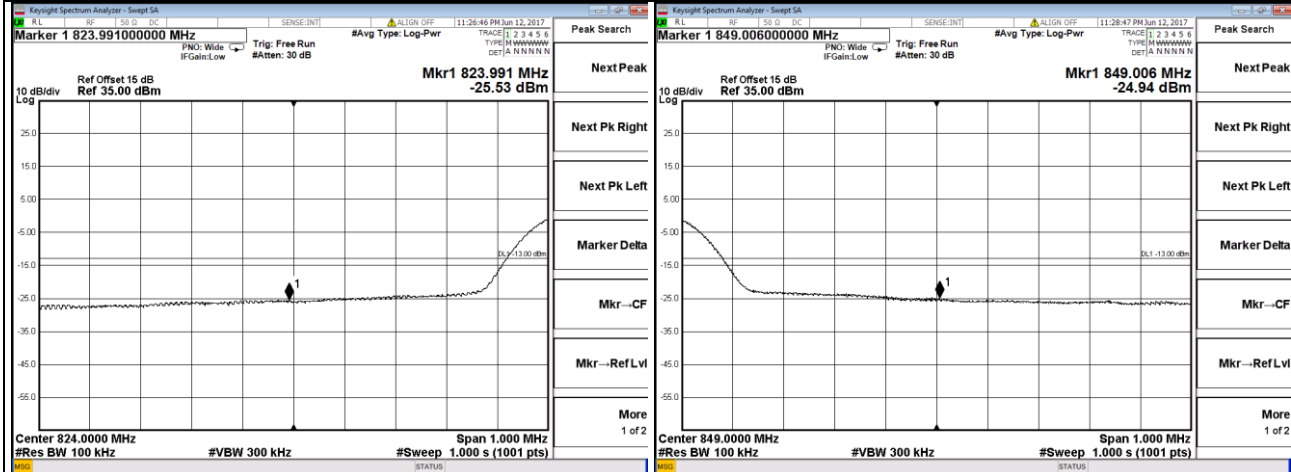

LTE Band 26

Channel Bandwidth 15MHz

Channel	26865	1 RB	Channel	26965	1 RB
---------	-------	------	---------	-------	------

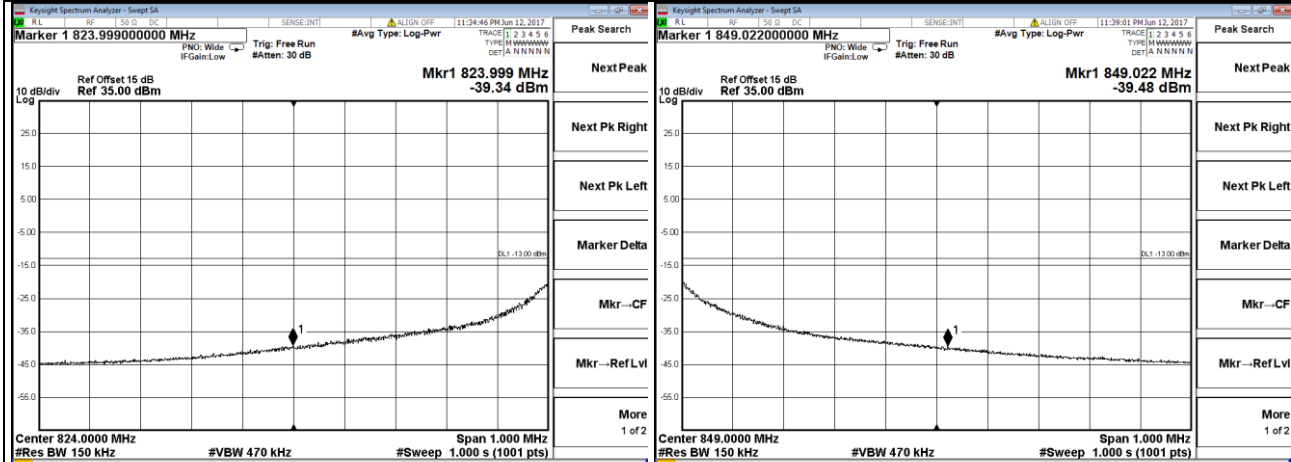

Channel	26865	75 RB	Channel	26965	75 RB
---------	-------	-------	---------	-------	-------

