



A D T

FCC TEST REPORT

REPORT NO.: RF120329E10

MODEL NO.: J20H058

FCC ID: MCLJ20H058

RECEIVED: Mar. 29, 2012

TESTED: Apr. 04 to 20, 2012

ISSUED: Apr. 26, 2012

APPLICANT: Hon Hai PRECISION IND.CO.,LTD

ADDRESS: 5F-1, Hsin-An Road, Hsinchu, Science Industrial Park, Taiwan, R.O.C.

ISSUED BY: Bureau Veritas Consumer Products Services (H.K.) Ltd.,
Taoyuan Branch Hsin Chu Laboratory

LAB ADDRESS : No. 81-1, Lu Liao Keng, 9th Ling, Wu Lung Tsuen, Chiung Lin Hsiang, Hsin Chu Hsien 307, Taiwan, R.O.C.

TEST LOCATION (1): No. 81-1, Lu Liao Keng, 9th Ling, Wu Lung Tsuen, Chiung Lin Hsiang, Hsin Chu Hsien 307, Taiwan, R.O.C.

TEST LOCATION (2): No. 49, Ln. 206, Wende Rd., Shangshan Tsuen, Chiung Lin Hsiang, Hsin Chu Hsien 307, Taiwan, R.O.C.

This test report consists of 52 pages in total. It may be duplicated completely for legal use with the approval of the applicant. It should not be reproduced except in full, without the written approval of our laboratory. The client should not use it to claim product certification, approval, or endorsement by TAF or any government agencies. The test results in the report only apply to the tested sample.





A D T

Table of Contents

RELEASE CONTROL RECORD	4
1. CERTIFICATION	5
2. SUMMARY OF TEST RESULTS	6
2.1 MEASUREMENT UNCERTAINTY	7
3. GENERAL INFORMATION	8
3.1 GENERAL DESCRIPTION OF EUT	8
3.2 DESCRIPTION OF TEST MODES	10
3.2.1 TEST MODE APPLICABILITY AND TESTED CHANNEL DETAIL	11
3.3 GENERAL DESCRIPTION OF APPLIED STANDARDS	13
3.4 DESCRIPTION OF SUPPORT UNITS.....	14
3.5 CONFIGURATION OF SYSTEM UNDER TEST	14
4. TEST TYPES AND RESULTS	15
4.1 CONDUCTED EMISSION MEASUREMENT	15
4.1.1 LIMITS OF CONDUCTED EMISSION MEASUREMENT	15
4.1.2 TEST INSTRUMENTS.....	15
4.1.3 TEST PROCEDURES	16
4.1.4 DEVIATION FROM TEST STANDARD	16
4.1.5 TEST SETUP	17
4.1.6 EUT OPERATING CONDITIONS	17
4.1.7 TEST RESULTS	18
4.2 RADIATED EMISSION AND BANDEDGE MEASUREMENT	20
4.2.1 LIMITS OF RADIATED EMISSION AND BANDEDGE MEASUREMENT	20
4.2.2 TEST INSTRUMENTS.....	21
4.2.3 TEST PROCEDURES	23
4.2.4 DEVIATION FROM TEST STANDARD	23
4.2.5 TEST SETUP	24
4.2.6 EUT OPERATING CONDITIONS	24
4.2.7 TEST RESULTS	25
4.3 6dB BANDWIDTH MEASUREMENT	38
4.3.1 LIMITS OF 6dB BANDWIDTH MEASUREMENT	38
4.3.2 TEST INSTRUMENTS.....	38
4.3.3 TEST PROCEDURE.....	38
4.3.4 DEVIATION FROM TEST STANDARD	38
4.3.5 TEST SETUP	38
4.3.6 EUT OPERATING CONDITIONS	38
4.3.7 TEST RESULTS	39
4.4 CONDUCTED OUTPUT POWER MEASUREMENT	40
4.4.1 LIMITS OF MAXIMUM PEAK OUTPUT POWER MEASUREMENT	40
4.4.2 INSTRUMENTS.....	40
4.4.3 TEST PROCEDURES	40



A D T

4.4.4	DEVIATION FROM TEST STANDARD	40
4.4.5	TEST SETUP	40
4.4.6	EUT OPERATING CONDITIONS	40
4.4.7	TEST RESULTS	41
4.5	POWER SPECTRAL DENSITY MEASUREMENT	42
4.5.1	LIMITS OF POWER SPECTRAL DENSITY MEASUREMENT	42
4.5.2	TEST INSTRUMENTS.....	42
4.5.3	TEST PROCEDURE.....	42
4.5.4	DEVIATION FROM TEST STANDARD	42
4.5.5	TEST SETUP	42
4.5.6	EUT OPERATING CONDITION.....	42
4.5.7	TEST RESULTS	43
4.6	CONDUCTED OUT-BAND EMISSION MEASUREMENT	44
4.6.1	LIMITS OF CONDUCTED OUT-BAND EMISSION MEASUREMENT.....	44
4.6.2	TEST INSTRUMENTS.....	44
4.6.3	TEST PROCEDURE.....	44
4.6.4	DEVIATION FROM TEST STANDARD	45
4.6.5	TEST SETUP	45
4.6.6	EUT OPERATING CONDITION.....	45
4.6.7	TEST RESULTS	45
5.	PHOTOGRAPHS OF THE TEST CONFIGURATION.....	50
6.	INFORMATION ON THE TESTING LABORATORIES	51
7.	APPENDIX A - MODIFICATIONS RECORDERS FOR ENGINEERING CHANGES TO THE EUT BY THE LAB.....	52



A D T

RELEASE CONTROL RECORD

ISSUE NO.	REASON FOR CHANGE	DATE ISSUED
RF120329E10	Original release	Apr. 26, 2012



A D T

1. CERTIFICATION

PRODUCT: WiFi Module
BRAND NAME: Foxconn
MODEL NO.: J20H058
TEST SAMPLE: ENGINEERING SAMPLE
APPLICANT: Hon Hai PRECISION IND.CO.,LTD
TESTED: Apr. 04 to 20, 2012
STANDARDS: **FCC Part 15, Subpart C (Section 15.247)**
ANSI C63.10-2009

The above equipment (Model: J20H058) has been tested by **Bureau Veritas Consumer Products Services (H.K.) Ltd., Taoyuan Branch**, and found compliance with the requirement of the above standards. The test record, data evaluation & Equipment Under Test (EUT) configurations represented herein are true and accurate accounts of the measurements of the sample's EMC characteristics under the conditions specified in this report.

PREPARED BY :  , **DATE:** Apr. 26, 2012
(Lori Chung, Specialist)

APPROVED BY :  , **DATE:** Apr. 26, 2012
(May Chen, Deputy Manager)

2. SUMMARY OF TEST RESULTS

The EUT has been tested according to the following specifications:

APPLIED STANDARD: FCC PART 15, SUBPART C (SECTION 15.247)			
STANDARD SECTION	TEST TYPE	RESULT	REMARK
15.207	AC Power Conducted Emission	PASS	Meet the requirement of limit. Minimum passing margin is -8.90dB at 0.20859MHz
15.247(d) 15.209	Radiated Emissions	PASS	Meet the requirement of limit. Minimum passing margin is -0.7dB at 2483.50MHz
15.247(d)	Band Edge Measurement	PASS	Meet the requirement of limit.
15.247(a)(2)	6dB bandwidth	PASS	Meet the requirement of limit.
15.247(b)	Conducted power	PASS	Meet the requirement of limit.
15.247(e)	Power Spectral Density	PASS	Meet the requirement of limit.
15.203	Antenna Requirement	PASS	No antenna connector is used.



A D T

2.1 MEASUREMENT UNCERTAINTY

Where relevant, the following measurement uncertainty levels have been estimated for tests performed on the EUT as specified in CISPR 16-4-2:

This uncertainty represents an expanded uncertainty expressed at approximately the 95% confidence level using a coverage factor of $k=2$.

Measurement	Value
Conducted emissions	2.98 dB
Radiated emissions (30MHz-1GHz)	3.81 dB
Radiated emissions (1GHz -6GHz)	5.12 dB
Radiated emissions (6GHz -18GHz)	5.32 dB
Radiated emissions (18GHz -40GHz)	5.39 dB



A D T

3. GENERAL INFORMATION

3.1 GENERAL DESCRIPTION OF EUT

PRODUCT	WiFi Module
MODEL NO.	J20H058
POWER SUPPLY	DC 5V from host equipment
MODULATION TYPE	CCK, DQPSK, DBPSK for DSSS 64QAM, 16QAM, QPSK, BPSK for OFDM
MODULATION TECHNOLOGY	DSSS, OFDM
TRANSFER RATE	802.11b: up to 11Mbps 802.11g: up to 54Mbps 802.11n (20MHz): up to 72.2Mbps 802.11n (40MHz): up to 150Mbps
OPERATING FREQUENCY	2.412 ~ 2.462GHz
NUMBER OF CHANNEL	11 for 802.11b, 802.11g, 802.11n (20MHz) 7 for 802.11n (40MHz)
MAXIMUM OUTPUT POWER	802.11b: 177.828mW 802.11g: 309.030mW 802.11n (20MHz): 295.121mW 802.11n (40MHz): 239.883mW
ANTENNA TYPE	Please see NOTE
DATA CABLE	NA
I/O PORTS	Refer to user's manual
ASSOCIATED DEVICES	NA



A D T

NOTE:

1. There are two antennas provided to this EUT, please refer to the following table:

Antenna	Antenna Type	Peak Gain (Included Cable loss) (dBi)	Connector Type	Frequency Range
Aux	PCB Print	0.6	NA	2400~2484MHz
Main	PCB Print	1.5	NA	2400~2484MHz

From the above Antenna, Main antenna was chosen for final test.

2. The EUT incorporates a SISO function.

MODULATION MODE	TX/Rx FUNCTION
802.11b	1Tx/1Rx (Diversity)
802.11g	1Tx/1Rx (Diversity)
802.11n (20MHz)	1Tx/1Rx (Diversity)
802.11n (40MHz)	1Tx/1Rx (Diversity)

3. The EUT is 1 * 1 spatial SISO (1Tx & 1Rx) without beam forming function.

4. When the EUT operating in 802.11n, the software operation, which is defined by manufacturer, MCS (Modulation and Coding Schemes) from 0 to 7.

5. The above EUT information was declared by the manufacturer and for more detailed features description, please refer to the manufacturer's specifications or User's Manual.

3.2 DESCRIPTION OF TEST MODES

Eleven channels are provided for 802.11b, 802.11g, 802.11n (20MHz):

CHANNEL	FREQUENCY	CHANNEL	FREQUENCY
1	2412MHz	7	2442MHz
2	2417MHz	8	2447MHz
3	2422MHz	9	2452MHz
4	2427MHz	10	2457MHz
5	2432MHz	11	2462MHz
6	2437MHz		

Seven channels are provided for 802.11n (40MHz):

CHANNEL	FREQUENCY	CHANNEL	FREQUENCY
3	2422MHz	7	2442MHz
4	2427MHz	8	2447MHz
5	2432MHz	9	2452MHz
6	2437MHz		

3.2.1 TEST MODE APPLICABILITY AND TESTED CHANNEL DETAIL

EUT CONFIGURE MODE	APPLICABLE TO					DESCRIPTION
	PLC	RE < 1G	RE ≥ 1G	APCM	OB	
-	√	√	√	√	√	-

Where **PLC**: Power Line Conducted Emission **RE < 1G**: Radiated Emission below 1GHz
RE ≥ 1G: Radiated Emission above 1GHz **APCM**: Antenna Port Conducted Measurement
OB: Conducted Out-Band Emission Measurement

The EUT had been pre-tested on the positioned of each 3 axis. The worst case was found when positioned on **X-plane**.

POWER LINE CONDUCTED EMISSION TEST:

- Pre-Scan has been conducted to determine the worst-case mode from all possible combinations between available modulations, data rates and antenna ports (if EUT with antenna diversity architecture).
- Following channel(s) was (were) selected for the final test as listed below.

MODE	AVAILABLE CHANNEL	TESTED CHANNEL	MODULATION TECHNOLOGY	MODULATION TYPE	DATA RATE (Mbps)
802.11g	1 to 11	6	OFDM	BPSK	6

RADIATED EMISSION TEST (BELOW 1 GHz):

- Pre-Scan has been conducted to determine the worst-case mode from all possible combinations between available modulations, data rates and antenna ports (if EUT with antenna diversity architecture).
- Following channel(s) was (were) selected for the final test as listed below.

MODE	AVAILABLE CHANNEL	TESTED CHANNEL	MODULATION TECHNOLOGY	MODULATION TYPE	DATA RATE (Mbps)
802.11g	1 to 11	6	OFDM	BPSK	6

RADIATED EMISSION TEST (ABOVE 1 GHz):

- Pre-Scan has been conducted to determine the worst-case mode from all possible combinations between available modulations, data rates and antenna ports (if EUT with antenna diversity architecture).
- Following channel(s) was (were) selected for the final test as listed below.

MODE	AVAILABLE CHANNEL	TESTED CHANNEL	MODULATION TECHNOLOGY	MODULATION TYPE	DATA RATE (Mbps)
802.11b	1 to 11	1, 6, 11	DSSS	DBPSK	1
802.11g	1 to 11	1, 6, 11	OFDM	BPSK	6
802.11n (20MHz)	1 to 11	1, 6, 11	OFDM	BPSK	6.5
802.11n (40MHz)	3 to 9	3, 6, 9	OFDM	BPSK	13.5



A D T

ANTENNA PORT CONDUCTED MEASUREMENT:

- Pre-Scan has been conducted to determine the worst-case mode from all possible combinations between available modulations, data rates and antenna ports (if EUT with antenna diversity architecture).
- Following channel(s) was (were) selected for the final test as listed below.

MODE	AVAILABLE CHANNEL	TESTED CHANNEL	MODULATION TECHNOLOGY	MODULATION TYPE	DATA RATE (Mbps)
802.11b	1 to 11	1, 6, 11	DSSS	DBPSK	1
802.11g	1 to 11	1, 6, 11	OFDM	BPSK	6
802.11n (20MHz)	1 to 11	1, 6, 11	OFDM	BPSK	6.5
802.11n (40MHz)	3 to 9	3, 6, 9	OFDM	BPSK	13.5

CONDUCTED OUT-BAND EMISSION MEASUREMENT:

- Pre-Scan has been conducted to determine the worst-case mode from all possible combinations between available modulations, data rates and antenna ports (if EUT with antenna diversity architecture).
- Following channel(s) was (were) selected for the final test as listed below.

MODE	AVAILABLE CHANNEL	TESTED CHANNEL	MODULATION TECHNOLOGY	MODULATION TYPE	DATA RATE (Mbps)
802.11b	1 to 11	1, 6, 11	DSSS	DBPSK	1
802.11g	1 to 11	1, 6, 11	OFDM	BPSK	6
802.11n (20MHz)	1 to 11	1, 6, 11	OFDM	BPSK	6.5
802.11n (40MHz)	3 to 9	3, 6, 9	OFDM	BPSK	13.5

TEST CONDITION:

APPLICABLE TO	ENVIRONMENTAL CONDITIONS	INPUT POWER (SYSTEM)	TESTED BY
PLC	24deg. C, 64%RH	120Vac, 60Hz	Anderson Chen
RE<1G	23deg. C, 71%RH	120Vac, 60Hz	Evan Huang
RE ³ 1G	27deg. C, 75%RH	120Vac, 60Hz	Robert Cheng
APCM	25deg. C, 60%RH	120Vac, 60Hz	Rex Huang
OB	25deg. C, 60%RH	120Vac, 60Hz	Rex Huang

3.3 GENERAL DESCRIPTION OF APPLIED STANDARDS

The EUT is a RF product. According to the specifications of the manufacturer, it must comply with the requirements of the following standards:

FCC Part 15, Subpart C (15.247)

ANSI C63.10-2009

All test items have been performed and recorded as per the above standards.

3.4 DESCRIPTION OF SUPPORT UNITS

The EUT has been tested as an independent unit together with other necessary accessories or support units. The following support units or accessories were used to form a representative test configuration during the tests.

No.	Product	Brand	Model No.	Serial No.	FCC ID
1	NOTEBOOK COMPUTER	DELL	PP32LA	GSLB32S	FCC DoC
2	USB test tool	Foxconn	NA	NA	NA

No.	Signal cable description
1	Data cable (0.15m)
2	NA

Note: The power cords of the above support units were unshielded (1.8m).

3.5 CONFIGURATION OF SYSTEM UNDER TEST

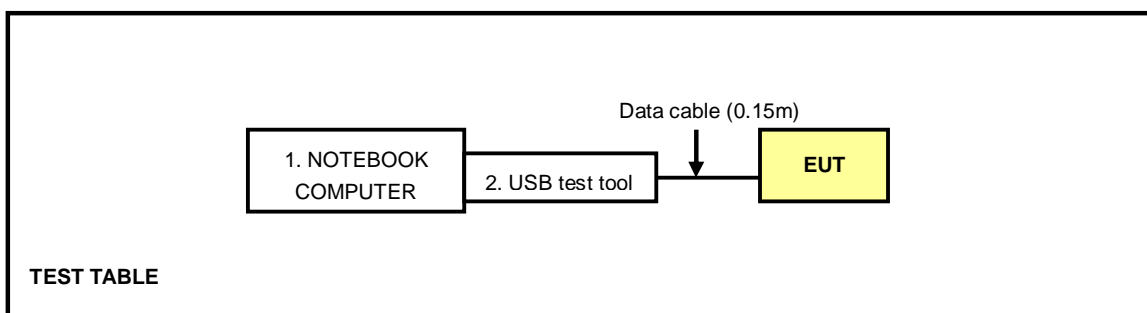

4. TEST TYPES AND RESULTS

4.1 CONDUCTED EMISSION MEASUREMENT

4.1.1 LIMITS OF CONDUCTED EMISSION MEASUREMENT

FREQUENCY OF EMISSION (MHz)	CONDUCTED LIMIT (dB μ V)	
	Quasi-peak	Average
0.15-0.5	66 to 56	56 to 46
0.5-5	56	46
5-30	60	50

- NOTE:**
1. The lower limit shall apply at the transition frequencies.
 2. The limit decreases in line with the logarithm of the frequency in the range of 0.15 to 0.50 MHz.

4.1.2 TEST INSTRUMENTS

DESCRIPTION & MANUFACTURER	MODEL NO.	SERIAL NO.	CALIBRATED DATE	CALIBRATED UNTIL
ROHDE & SCHWARZ Test Receiver	ESCS 30	100287	Feb. 29, 2012	Feb. 28, 2013
Line-Impedance Stabilization Network (for EUT)	NSLK 8127	8127-523	Sep. 20, 2011	Sep. 19, 2012
Line-Impedance Stabilization Network (for Peripheral)	ENV-216	100072	June 10, 2011	June 09, 2012
RF Cable (JYBAO)	5DFB	COACAB-002	Aug. 06, 2011	Aug. 05, 2012
50 ohms Terminator	50	3	Nov. 02, 2011	Nov. 01, 2012
Software	BV ADT_Cond_V7.3.7	NA	NA	NA

Note:

1. The calibration interval of the above test instruments is 12 months and the calibrations are traceable to NML/ROC and NIST/USA.
2. The test was performed in Shielded Room No. A.
3. The VCCI Con A Registration No. is C-817.
4. Tested Date: Apr. 20, 2012

4.1.3 TEST PROCEDURES

- a. The EUT/HOST was placed 0.4 meters from the conducting wall of the shielded room with EUT/HOST being connected to the power mains through a line impedance stabilization network (LISN). Other support units were connected to the power mains through another LISN. The two LISNs provide 50 ohm/ 50uH of coupling impedance for the measuring instrument.
- b. Both lines of the power mains connected to the EUT were checked for maximum conducted interference.
- c. The frequency range from 150kHz to 30MHz was searched. Emission levels under (Limit - 20dB) were not recorded.

4.1.4 DEVIATION FROM TEST STANDARD

No deviation

4.1.5 TEST SETUP

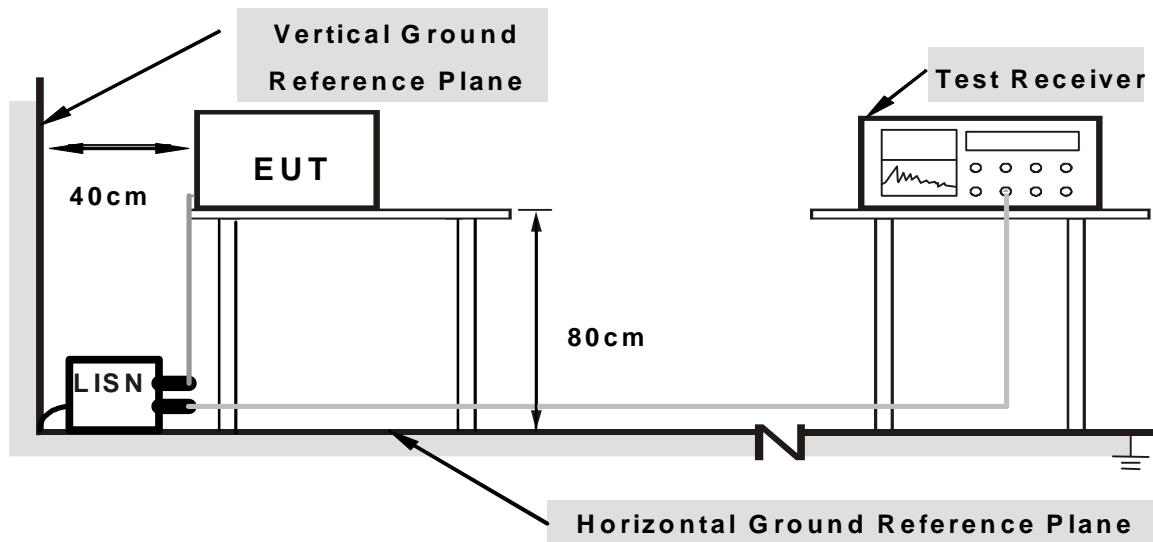

Note: 1. Support units were connected to second LISN.

2. Both of LISNs (AMN) are 80 cm from EUT and at least 80 from other units and other metal planes

For the actual test configuration, please refer to the related item – Photographs of the Test Configuration.

4.1.6 EUT OPERATING CONDITIONS

1. Placed the EUT on testing table.
2. Prepared computer system (support unit 1) to act as communication partner.
3. The communication partner ran test program “MP Kit RTL11n SingleChip 9xC USB v031 20120102” to enable EUT under transmission/receiving condition continuously.

4.1.7 TEST RESULTS

PHASE	Line (L)	6dB BANDWIDTH	9 kHz
--------------	----------	----------------------	-------

No	Freq.	Corr.	Reading Value		Emission Level		Limit		Margin	
	[MHz]	Factor	[dB (uV)]		[dB (uV)]		[dB (uV)]		(dB)	
		(dB)	Q.P.	AV.	Q.P.	AV.	Q.P.	AV.	Q.P.	AV.
1	0.16172	0.06	50.13	41.34	50.19	41.40	65.38	55.38	-15.19	-13.98
2	0.18906	0.06	53.81	41.12	53.87	41.18	64.08	54.08	-10.21	-12.90
3	0.20859	0.06	54.30	40.57	54.36	40.63	63.26	53.26	-8.90	-12.63
4	0.23984	0.06	52.47	41.07	52.53	41.13	62.10	52.10	-9.57	-10.97
5	15.05078	0.52	37.63	29.95	38.15	30.47	60.00	50.00	-21.85	-19.53
6	23.58984	0.69	37.55	32.26	38.24	32.95	60.00	50.00	-21.76	-17.05

- REMARKS:**
1. Q.P. and AV. are abbreviations of quasi-peak and average individually.
 2. The emission levels of other frequencies were very low against the limit.
 3. Margin value = Emission level - Limit value
 4. Correction factor = Insertion loss + Cable loss
 5. Emission Level = Correction Factor + Reading Value.

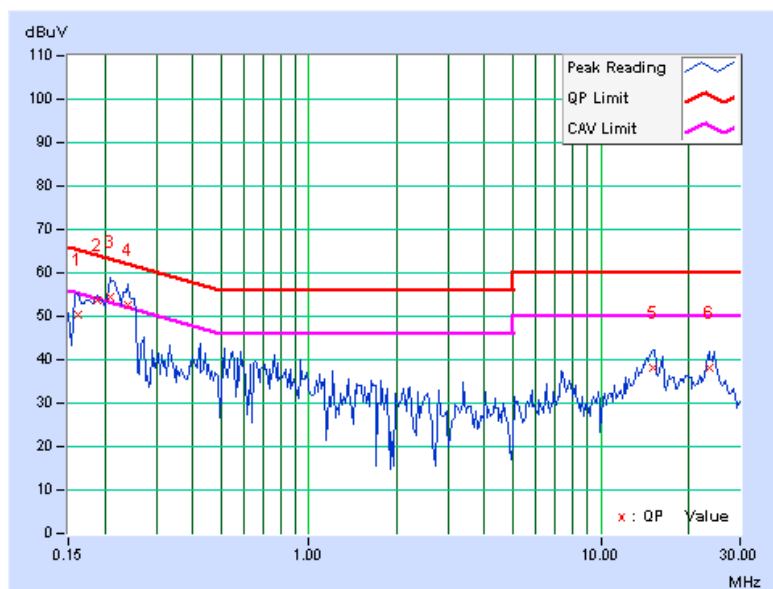

PHASE	Neutral (N)	6dB BANDWIDTH	9 kHz
--------------	-------------	----------------------	-------

No	Freq.	Corr.	Reading Value		Emission Level		Limit		Margin	
	[MHz]	Factor	[dB (uV)]		[dB (uV)]		[dB (uV)]		(dB)	
		(dB)	Q.P.	AV.	Q.P.	AV.	Q.P.	AV.	Q.P.	AV.
1	0.15781	0.07	51.06	39.51	51.13	39.58	65.58	55.58	-14.45	-16.00
2	0.19297	0.07	54.70	41.75	54.77	41.82	63.91	53.91	-9.14	-12.09
3	0.24766	0.07	51.63	41.92	51.70	41.99	61.84	51.84	-10.13	-9.84
4	0.40391	0.08	36.69	27.53	36.77	27.61	57.77	47.77	-21.00	-20.16
5	0.70859	0.10	32.46	20.98	32.56	21.08	56.00	46.00	-23.44	-24.92
6	14.76563	0.49	36.72	29.18	37.21	29.67	60.00	50.00	-22.79	-20.33

- REMARKS:**
1. Q.P. and AV. are abbreviations of quasi-peak and average individually.
 2. The emission levels of other frequencies were very low against the limit.
 3. Margin value = Emission level - Limit value
 4. Correction factor = Insertion loss + Cable loss
 5. Emission Level = Correction Factor + Reading Value.

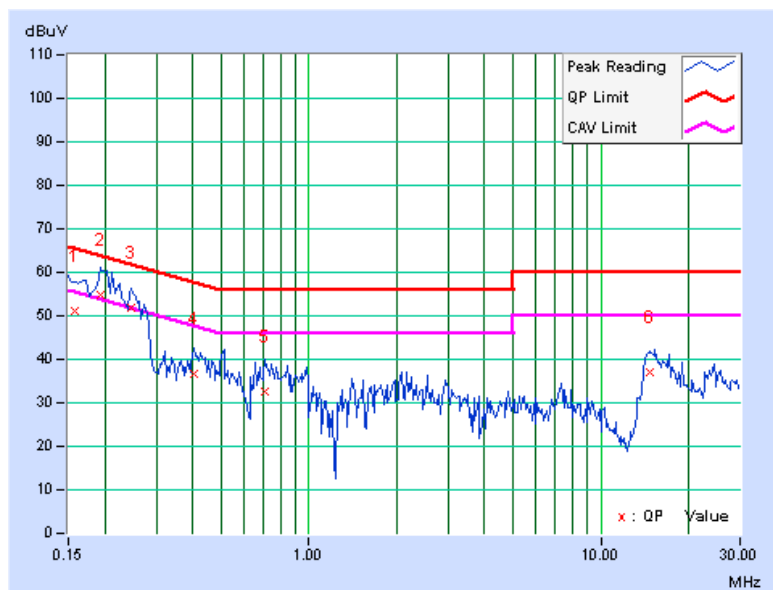

4.2 RADIATED EMISSION AND BANDEDGE MEASUREMENT

4.2.1 LIMITS OF RADIATED EMISSION AND BANDEDGE MEASUREMENT

Radiated emissions which fall in the restricted bands must comply with the radiated emission limits specified as below table. Other emissions shall be at least 20dB below the highest level of the desired power:

Frequencies (MHz)	Field strength (microvolts/meter)	Measurement distance (meters)
0.009-0.490	2400/F(kHz)	300
0.490-1.705	24000/F(kHz)	30
1.705-30.0	30	30
30-88	100	3
88-216	150	3
216-960	200	3
Above 960	500	3

NOTE:

1. The lower limit shall apply at the transition frequencies.
2. Emission level (dBuV/m) = 20 log Emission level (uV/m).
3. For frequencies above 1000MHz, the field strength limits are based on average detector, however, the peak field strength of any emission shall not exceed the maximum permitted average limits, specified above by more than 20dB under any condition of modulation.



A D T

4.2.2 TEST INSTRUMENTS

For below 1GHz

DESCRIPTION & MANUFACTURER	MODEL NO.	SERIAL NO.	CALIBRATED DATE	CALIBRATED UNTIL
Agilent Spectrum Analyzer	E4446A	MY48250254	July 12, 2011	July 11, 2012
Agilent Pre-Selector	N9039A	MY46520311	July 12, 2011	July 11, 2012
Agilent Signal Generator	N5181A	MY49060517	July 12, 2011	July 11, 2012
Mini-Circuits Pre-Amplifier	ZFL-1000VH2B	AMP-ZFL-03	Nov. 15, 2011	Nov. 14, 2012
Agilent Pre-Amplifier	8449B	3008A02578	July 04, 2011	July 03, 2012
SPACEK LABS	SLKKa-48-6	9K16	Nov. 15, 2011	Nov. 14, 2012
SCHWARZBECK Trilog Broadband Antenna	VULB 9168	9168-360	Apr. 14, 2011	Apr. 13, 2012
AISI Horn_Antenna	AIH.8018	0000320091110	Nov. 14, 2011	Nov. 13, 2012
SCHWARZBECK Horn_Antenna	BBHA 9170	9170-424	Oct. 07, 2011	Oct. 06, 2012
RF CABLE	NA	RF104-201 RF104-203 RF104-204	Dec. 26, 2011	Dec. 25, 2012
RF Cable	NA	CHGCAB_001	Oct. 07, 2011	Oct. 06, 2012
Software	ADT_Radiated_V8.7.05	NA	NA	NA
CT Antenna Tower & Turn Table	NA	NA	NA	NA

Note: 1. The calibration interval of the above test instruments is 12 months and the calibrations are traceable to NML/ROC and NIST/USA.

2. The horn antenna, preamplifier (model: 8449B) are used only for the measurement of emission frequency above 1GHz if tested.

3. The test was performed in 966 Chamber No. G.

4. The FCC Site Registration No. is 966073.

5. The VCCI Site Registration No. is G-137.

6. The CANADA Site Registration No. is IC 7450H-2.

7. Tested Date: Apr. 04, 2012



A D T

For above 1GHz:

DESCRIPTION & MANUFACTURER	MODEL NO.	SERIAL NO.	CALIBRATED DATE	CALIBRATED UNTIL
Agilent Spectrum Analyzer	E4446A	MY48250253	Aug. 29, 2011	Aug. 28, 2012
Agilent Pre-Selector	N9039A	MY46520310	Aug. 29, 2011	Aug. 28, 2012
Agilent Signal Generator	N5181A	MY49060347	July 25, 2011	July 24, 2012
Mini-Circuits Pre-Amplifier	ZFL-1000VH2B	AMP-ZFL-04	Nov. 15, 2011	Nov. 14, 2012
Agilent Pre-Amplifier	8449B	3008A02465	Feb. 27, 2012	Feb. 26, 2013
SPACEK LABS	SLKKa-48-6	9K16	Nov. 15, 2011	Nov. 14, 2012
SCHWARZBECK Trilog Broadband Antenna	VULB 9168	9168-361	Apr. 06, 2012	Apr. 05, 2013
AISI Horn_Antenna	AIH.8018	0000220091110	Nov. 23, 2011	Nov. 22, 2012
SCHWARZBECK Horn_Antenna	BBHA 9170	9170-424	Oct. 07, 2011	Oct. 06, 2012
RF CABLE	NA	RF104-205 RF104-207 RF104-202	Dec. 27, 2011	Dec. 26, 2012
RF Cable	NA	CHHCAB_001	Oct. 08, 2011	Oct. 07, 2012
Software	ADT_Radiated_V8.7.05	NA	NA	NA
CT Antenna Tower & Turn Table	NA	NA	NA	NA

Note:

1. The calibration interval of the above test instruments is 12 months and the calibrations are traceable to NML/ROC and NIST/USA.
2. The horn antenna, preamplifier (model: 8449B) are used only for the measurement of emission frequency above 1GHz if tested.
3. The test was performed in 966 Chamber No. H.
4. The FCC Site Registration No. is 797305.
5. The CANADA Site Registration No. is IC 7450H-3.
6. Tested Date: Apr. 16, 2012

4.2.3 TEST PROCEDURES

- a. The EUT was placed on the top of a rotating table 0.8 meters above the ground at 3 meter chamber room. The table was rotated 360 degrees to determine the position of the highest radiation.
- b. The EUT was set 3 meters away from the interference-receiving antenna, which was mounted on the top of a variable-height antenna tower.
- c. The height of antenna is varied from one meter to four meters above the ground to determine the maximum value of the field strength. Both horizontal and vertical polarizations of the antenna are set to make the measurement.
- d. For each suspected emission, the EUT was arranged to its worst case and then the antenna was tuned to heights from 1 meter to 4 meters and the rotatable table was turned from 0 degrees to 360 degrees to find the maximum reading.
- e. The test-receiver system was set to quasi-peak detect function and specified bandwidth with maximum hold mode when the test frequency is below 1 GHz.
- f. The test-receiver system was set to peak and average detect function and specified bandwidth with maximum hold mode when the test frequency is above 1 GHz. If the peak reading value also meets average limit, measurement with the average detector is unnecessary.

NOTE:

1. The resolution bandwidth and video bandwidth of test receiver/spectrum analyzer is 120kHz for Quasi-peak detection (QP) at frequency below 1GHz.
2. The resolution bandwidth of test receiver/spectrum analyzer is 1 MHz and the video bandwidth is 3 MHz for Peak detection (PK) at frequency above 1GHz.
3. The resolution bandwidth of test receiver/spectrum analyzer is 1 MHz and the video bandwidth is 10 Hz for Average detection (AV) at frequency above 1GHz.
4. All modes of operation were investigated and the worst-case emissions are reported.

4.2.4 DEVIATION FROM TEST STANDARD

No deviation

4.2.5 TEST SETUP

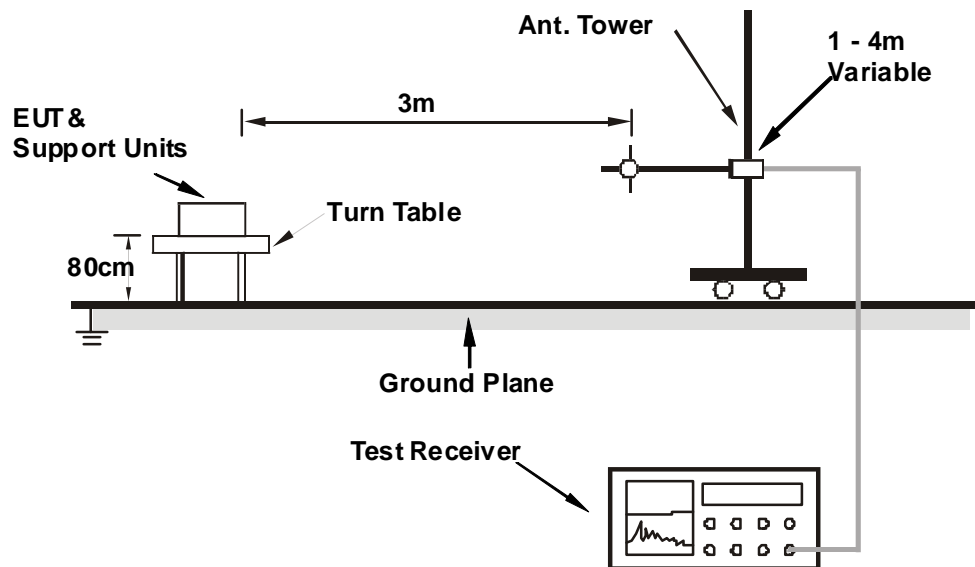

For the actual test configuration, please refer to the related item – Photographs of the Test Configuration.

4.2.6 EUT OPERATING CONDITIONS

Same as 4.1.6

4.2.7 TEST RESULTS

BELOW 1GHz WORST-CASE DATA

802.11g

CHANNEL	TX Channel 6	DETECTOR FUNCTION	Quasi-Peak (QP)
FREQUENCY RANGE	Below 1GHz		

ANTENNA POLARITY & TEST DISTANCE: HORIZONTAL AT 3 M

NO.	FREQ. (MHz)	EMISSION LEVEL (dBuV/m)	LIMIT (dBuV/m)	MARGIN (dB)	ANTENNA HEIGHT (m)	TABLE ANGLE (Degree)	RAW VALUE (dBuV)	CORRECTION FACTOR (dB/m)
1	310.19	41.1 QP	46.0	-4.9	1.00 H	140	25.55	15.59
2	480.01	37.8 QP	46.0	-8.2	1.75 H	142	17.99	19.84
3	697.43	32.7 QP	46.0	-13.3	1.25 H	30	9.67	23.04
4	750.01	29.4 QP	46.0	-16.6	1.00 H	152	4.99	24.42
5	850.55	33.1 QP	46.0	-12.9	1.00 H	250	6.47	26.66
6	959.97	34.7 QP	46.0	-11.3	1.75 H	317	6.87	27.86

ANTENNA POLARITY & TEST DISTANCE: VERTICAL AT 3 M

NO.	FREQ. (MHz)	EMISSION LEVEL (dBuV/m)	LIMIT (dBuV/m)	MARGIN (dB)	ANTENNA HEIGHT (m)	TABLE ANGLE (Degree)	RAW VALUE (dBuV)	CORRECTION FACTOR (dB/m)
1	48.24	35.5 QP	40.0	-4.5	1.00 V	260	21.21	14.31
2	71.21	32.7 QP	40.0	-7.3	1.00 V	360	20.46	12.21
3	161.57	33.7 QP	43.5	-9.8	1.00 V	217	19.14	14.52
4	177.44	35.4 QP	43.5	-8.1	1.25 V	151	22.07	13.33
5	480.01	35.5 QP	46.0	-10.5	1.25 V	286	15.63	19.84
6	959.97	37.2 QP	46.0	-8.8	1.00 V	303	9.30	27.86

REMARKS:

1. Emission level (dBuV/m) = Raw Value (dBuV) + Correction Factor (dB/m).
2. Correction Factor (dB/m) = Antenna Factor (dB/m) + Cable Factor (dB).
3. The other emission levels were very low against the limit.
4. Margin value = Emission level – Limit value.



A D T

ABOVE 1GHz DATA

802.11b

CHANNEL	TX Channel 1	DETECTOR FUNCTION	Peak (PK)
FREQUENCY RANGE	1GHz ~ 25GHz		Average (AV)

ANTENNA POLARITY & TEST DISTANCE: HORIZONTAL AT 3 M								
NO.	FREQ. (MHz)	EMISSION LEVEL (dBuV/m)	LIMIT (dBuV/m)	MARGIN (dB)	ANTENNA HEIGHT (m)	TABLE ANGLE (Degree)	RAW VALUE (dBuV)	CORRECTION FACTOR (dB/m)
1	2390.00	59.6 PK	74.0	-14.4	1.43 H	247	27.41	32.19
2	2390.00	52.7 AV	54.0	-1.3	1.43 H	247	20.51	32.19
3	*2412.00	109.6 PK			1.43 H	250	77.35	32.25
4	*2412.00	107.5 AV			1.43 H	250	75.25	32.25
5	4824.00	51.0 PK	74.0	-23.0	1.24 H	244	9.43	41.57
6	4824.00	45.8 AV	54.0	-8.2	1.24 H	244	4.23	41.57

ANTENNA POLARITY & TEST DISTANCE: VERTICAL AT 3 M								
NO.	FREQ. (MHz)	EMISSION LEVEL (dBuV/m)	LIMIT (dBuV/m)	MARGIN (dB)	ANTENNA HEIGHT (m)	TABLE ANGLE (Degree)	RAW VALUE (dBuV)	CORRECTION FACTOR (dB/m)
1	2390.00	56.7 PK	74.0	-17.3	1.10 V	322	24.51	32.19
2	2390.00	46.2 AV	54.0	-7.8	1.10 V	322	14.01	32.19
3	*2412.00	102.2 PK			1.10 V	322	69.95	32.25
4	*2412.00	99.8 AV			1.10 V	322	67.55	32.25
5	4824.00	45.6 PK	74.0	-28.4	1.01 V	200	4.03	41.57
6	4824.00	40.3 AV	54.0	-13.7	1.01 V	200	-1.27	41.57

REMARKS:

1. Emission level (dBuV/m) = Raw Value (dBuV) + Correction Factor (dB/m).
2. Correction Factor (dB/m) = Antenna Factor (dB/m) + Cable Factor (dB).
3. The other emission levels were very low against the limit.
4. Margin value = Emission level – Limit value.
5. " * ": Fundamental frequency.



A D T

CHANNEL	TX Channel 6	DETECTOR FUNCTION	Peak (PK)
FREQUENCY RANGE	1GHz ~ 25GHz		Average (AV)

ANTENNA POLARITY & TEST DISTANCE: HORIZONTAL AT 3 M

NO.	FREQ. (MHz)	EMISSION LEVEL (dBuV/m)	LIMIT (dBuV/m)	MARGIN (dB)	ANTENNA HEIGHT (m)	TABLE ANGLE (Degree)	RAW VALUE (dBuV)	CORRECTION FACTOR (dB/m)
1	*2437.00	110.9 PK			1.39 H	254	78.59	32.31
2	*2437.00	108.8 AV			1.39 H	254	76.49	32.31
3	4874.00	55.6 PK	74.0	-18.4	1.13 H	105	13.94	41.66
4	4874.00	53.0 AV	54.0	-1.0	1.13 H	105	11.34	41.66
5	7311.00	58.1 PK	74.0	-15.9	1.57 H	139	11.94	46.14
6	7311.00	50.1 AV	54.0	-3.9	1.57 H	139	3.96	46.14

ANTENNA POLARITY & TEST DISTANCE: VERTICAL AT 3 M

NO.	FREQ. (MHz)	EMISSION LEVEL (dBuV/m)	LIMIT (dBuV/m)	MARGIN (dB)	ANTENNA HEIGHT (m)	TABLE ANGLE (Degree)	RAW VALUE (dBuV)	CORRECTION FACTOR (dB/m)
1	*2437.00	104.0 PK			1.08 V	323	71.69	32.31
2	*2437.00	101.6 AV			1.08 V	323	69.29	32.31
3	4874.00	54.0 PK	74.0	-20.0	1.00 V	193	12.34	41.66
4	4874.00	50.7 AV	54.0	-3.3	1.00 V	193	9.04	41.66
5	7311.00	56.6 PK	74.0	-17.4	1.00 V	230	10.46	46.14
6	7311.00	45.3 AV	54.0	-8.7	1.00 V	230	-0.84	46.14

REMARKS:

1. Emission level (dBuV/m) = Raw Value (dBuV) + Correction Factor (dB/m).
2. Correction Factor (dB/m) = Antenna Factor (dB/m) + Cable Factor (dB).
3. The other emission levels were very low against the limit.
4. Margin value = Emission level – Limit value.
5. " * " : Fundamental frequency.



A D T

CHANNEL	TX Channel 11	DETECTOR FUNCTION	Peak (PK)
FREQUENCY RANGE	1GHz ~ 25GHz		Average (AV)

ANTENNA POLARITY & TEST DISTANCE: HORIZONTAL AT 3 M

NO.	FREQ. (MHz)	EMISSION LEVEL (dBuV/m)	LIMIT (dBuV/m)	MARGIN (dB)	ANTENNA HEIGHT (m)	TABLE ANGLE (Degree)	RAW VALUE (dBuV)	CORRECTION FACTOR (dB/m)
1	*2462.00	108.1 PK			1.40 H	265	75.73	32.37
2	*2462.00	106.0 AV			1.40 H	265	73.63	32.37
3	4924.00	48.5 PK	74.0	-25.5	1.21 H	243	6.80	41.70
4	4924.00	42.3 AV	54.0	-11.7	1.21 H	243	0.60	41.70
5	7386.00	55.8 PK	74.0	-18.2	1.57 H	138	9.47	46.33
6	7386.00	46.2 AV	54.0	-7.8	1.57 H	138	-0.13	46.33

ANTENNA POLARITY & TEST DISTANCE: VERTICAL AT 3 M

NO.	FREQ. (MHz)	EMISSION LEVEL (dBuV/m)	LIMIT (dBuV/m)	MARGIN (dB)	ANTENNA HEIGHT (m)	TABLE ANGLE (Degree)	RAW VALUE (dBuV)	CORRECTION FACTOR (dB/m)
1	*2462.00	100.9 PK			1.04 V	320	68.53	32.37
2	*2462.00	98.7 AV			1.04 V	320	66.33	32.37
3	2483.50	56.9 PK	74.0	-17.1	1.06 V	316	24.47	32.43
4	2483.50	46.2 AV	54.0	-7.8	1.06 V	316	13.77	32.43
5	4924.00	44.1 PK	74.0	-29.9	1.00 V	189	2.40	41.70
6	4924.00	39.8 AV	54.0	-14.2	1.00 V	189	-1.90	41.70
7	7386.00	55.9 PK	74.0	-18.1	1.00 V	229	9.57	46.33
8	7386.00	46.5 AV	54.0	-7.5	1.00 V	229	0.17	46.33

REMARKS:

1. Emission level (dBuV/m) = Raw Value (dBuV) + Correction Factor (dB/m).
2. Correction Factor (dB/m) = Antenna Factor (dB/m) + Cable Factor (dB).
3. The other emission levels were very low against the limit.
4. Margin value = Emission level – Limit value.
5. " * ": Fundamental frequency.



A D T

802.11g

CHANNEL	TX Channel 1	DETECTOR FUNCTION	Peak (PK)
FREQUENCY RANGE	1GHz ~ 25GHz		Average (AV)

ANTENNA POLARITY & TEST DISTANCE: HORIZONTAL AT 3 M								
NO.	FREQ. (MHz)	EMISSION LEVEL (dBuV/m)	LIMIT (dBuV/m)	MARGIN (dB)	ANTENNA HEIGHT (m)	TABLE ANGLE (Degree)	RAW VALUE (dBuV)	CORRECTION FACTOR (dB/m)
1	2390.00	69.1 PK	74.0	-4.9	1.43 H	248	36.91	32.19
2	2390.00	53.1 AV	54.0	-0.9	1.43 H	248	20.91	32.19
3	*2412.00	109.6 PK			1.43 H	248	77.35	32.25
4	*2412.00	100.7 AV			1.43 H	248	68.45	32.25
5	4824.00	45.2 PK	74.0	-28.8	1.00 H	201	3.63	41.57
6	4824.00	36.0 AV	54.0	-18.0	1.00 H	201	-5.57	41.57
ANTENNA POLARITY & TEST DISTANCE: VERTICAL AT 3 M								
NO.	FREQ. (MHz)	EMISSION LEVEL (dBuV/m)	LIMIT (dBuV/m)	MARGIN (dB)	ANTENNA HEIGHT (m)	TABLE ANGLE (Degree)	RAW VALUE (dBuV)	CORRECTION FACTOR (dB/m)
1	2390.00	59.6 PK	74.0	-14.4	1.12 V	323	27.41	32.19
2	2390.00	47.0 AV	54.0	-7.0	1.12 V	323	14.81	32.19
3	*2412.00	102.1 PK			1.12 V	323	69.85	32.25
4	*2412.00	93.3 AV			1.12 V	323	61.05	32.25
5	4824.00	45.1 PK	74.0	-28.9	1.02 V	200	3.53	41.57
6	4824.00	35.9 AV	54.0	-18.1	1.02 V	200	-5.67	41.57

REMARKS:

1. Emission level (dBuV/m) = Raw Value (dBuV) + Correction Factor (dB/m).
2. Correction Factor (dB/m) = Antenna Factor (dB/m) + Cable Factor (dB).
3. The other emission levels were very low against the limit.
4. Margin value = Emission level – Limit value.
5. " * ": Fundamental frequency.



A D T

CHANNEL	TX Channel 6	DETECTOR FUNCTION	Peak (PK)
FREQUENCY RANGE	1GHz ~ 25GHz		Average (AV)

ANTENNA POLARITY & TEST DISTANCE: HORIZONTAL AT 3 M

NO.	FREQ. (MHz)	EMISSION LEVEL (dBuV/m)	LIMIT (dBuV/m)	MARGIN (dB)	ANTENNA HEIGHT (m)	TABLE ANGLE (Degree)	RAW VALUE (dBuV)	CORRECTION FACTOR (dB/m)
1	*2437.00	111.9 PK			1.41 H	251	79.59	32.31
2	*2437.00	103.1 AV			1.41 H	251	70.79	32.31
3	4874.00	46.6 PK	74.0	-27.4	1.24 H	244	4.94	41.66
4	4874.00	36.6 AV	54.0	-17.4	1.24 H	244	-5.06	41.66
5	7311.00	57.4 PK	74.0	-16.6	1.54 H	144	11.26	46.14
6	7311.00	45.8 AV	54.0	-8.2	1.54 H	144	-0.34	46.14

ANTENNA POLARITY & TEST DISTANCE: VERTICAL AT 3 M

NO.	FREQ. (MHz)	EMISSION LEVEL (dBuV/m)	LIMIT (dBuV/m)	MARGIN (dB)	ANTENNA HEIGHT (m)	TABLE ANGLE (Degree)	RAW VALUE (dBuV)	CORRECTION FACTOR (dB/m)
1	*2437.00	103.6 PK			1.13 V	321	71.29	32.31
2	*2437.00	94.5 AV			1.13 V	321	62.19	32.31
3	4874.00	45.8 PK	74.0	-28.2	1.00 V	207	4.14	41.66
4	4874.00	37.5 AV	54.0	-16.5	1.00 V	207	-4.20	41.66
5	7311.00	55.4 PK	74.0	-18.6	1.00 V	217	9.26	46.14
6	7311.00	45.1 AV	54.0	-8.9	1.00 V	217	-1.04	46.14

REMARKS:

1. Emission level (dBuV/m) = Raw Value (dBuV) + Correction Factor (dB/m).
2. Correction Factor (dB/m) = Antenna Factor (dB/m) + Cable Factor (dB).
3. The other emission levels were very low against the limit.
4. Margin value = Emission level – Limit value.
5. " * ": Fundamental frequency.



A D T

CHANNEL	TX Channel 11	DETECTOR FUNCTION	Peak (PK)
FREQUENCY RANGE	1GHz ~ 25GHz		Average (AV)

ANTENNA POLARITY & TEST DISTANCE: HORIZONTAL AT 3 M

NO.	FREQ. (MHz)	EMISSION LEVEL (dBuV/m)	LIMIT (dBuV/m)	MARGIN (dB)	ANTENNA HEIGHT (m)	TABLE ANGLE (Degree)	RAW VALUE (dBuV)	CORRECTION FACTOR (dB/m)
1	*2462.00	108.3 PK			1.37 H	250	75.93	32.37
2	*2462.00	99.4 AV			1.37 H	250	67.03	32.37
3	2483.50	65.0 PK	74.0	-9.0	1.37 H	245	32.57	32.43
4	2483.50	52.1 AV	54.0	-1.9	1.37 H	245	19.67	32.43
5	4924.00	48.5 PK	74.0	-25.5	1.28 H	233	6.80	41.70
6	4924.00	36.3 AV	54.0	-17.7	1.28 H	233	-5.40	41.70
7	7386.00	57.6 PK	74.0	-16.4	1.50 H	142	11.27	46.33
8	7386.00	44.9 AV	54.0	-9.1	1.50 H	142	-1.43	46.33

ANTENNA POLARITY & TEST DISTANCE: VERTICAL AT 3 M

NO.	FREQ. (MHz)	EMISSION LEVEL (dBuV/m)	LIMIT (dBuV/m)	MARGIN (dB)	ANTENNA HEIGHT (m)	TABLE ANGLE (Degree)	RAW VALUE (dBuV)	CORRECTION FACTOR (dB/m)
1	*2462.00	100.5 PK			1.04 V	321	68.13	32.37
2	*2462.00	91.6 AV			1.04 V	321	59.23	32.37
3	2483.50	59.9 PK	74.0	-14.1	1.04 V	321	27.47	32.43
4	2483.50	47.4 AV	54.0	-6.6	1.04 V	321	14.97	32.43
5	4924.00	46.1 PK	74.0	-27.9	1.00 V	195	4.40	41.70
6	4924.00	36.5 AV	54.0	-17.5	1.00 V	195	-5.20	41.70
7	7386.00	55.2 PK	74.0	-18.8	1.00 V	216	8.87	46.33
8	7386.00	44.1 AV	54.0	-9.9	1.00 V	216	-2.23	46.33

REMARKS:

1. Emission level (dBuV/m) = Raw Value (dBuV) + Correction Factor (dB/m).
2. Correction Factor (dB/m) = Antenna Factor (dB/m) + Cable Factor (dB).
3. The other emission levels were very low against the limit.
4. Margin value = Emission level – Limit value.
5. " * " : Fundamental frequency.



A D T

802.11n (20MHz)

CHANNEL	TX Channel 1	DETECTOR FUNCTION	Peak (PK)
FREQUENCY RANGE	1GHz ~ 25GHz		Average (AV)

ANTENNA POLARITY & TEST DISTANCE: HORIZONTAL AT 3 M								
NO.	FREQ. (MHz)	EMISSION LEVEL (dBuV/m)	LIMIT (dBuV/m)	MARGIN (dB)	ANTENNA HEIGHT (m)	TABLE ANGLE (Degree)	RAW VALUE (dBuV)	CORRECTION FACTOR (dB/m)
1	2390.00	72.9 PK	74.0	-1.1	1.41 H	250	40.71	32.19
2	2390.00	52.8 AV	54.0	-1.2	1.41 H	250	20.61	32.19
3	*2412.00	109.9 PK			1.41 H	250	77.65	32.25
4	*2412.00	100.5 AV			1.41 H	250	68.25	32.25
5	4824.00	47.9 PK	74.0	-26.1	1.27 H	226	6.33	41.57
6	4824.00	36.7 AV	54.0	-17.3	1.27 H	226	-4.87	41.57
ANTENNA POLARITY & TEST DISTANCE: VERTICAL AT 3 M								
NO.	FREQ. (MHz)	EMISSION LEVEL (dBuV/m)	LIMIT (dBuV/m)	MARGIN (dB)	ANTENNA HEIGHT (m)	TABLE ANGLE (Degree)	RAW VALUE (dBuV)	CORRECTION FACTOR (dB/m)
1	2390.00	60.5 PK	74.0	-13.5	1.10 V	329	28.31	32.19
2	2390.00	47.8 AV	54.0	-6.2	1.10 V	329	15.61	32.19
3	*2412.00	101.7 PK			1.10 V	329	69.45	32.25
4	*2412.00	93.1 AV			1.10 V	329	60.85	32.25
5	4824.00	46.5 PK	74.0	-27.5	1.00 V	199	4.93	41.57
6	4824.00	36.9 AV	54.0	-17.1	1.00 V	199	-4.67	41.57

REMARKS:

1. Emission level (dBuV/m) = Raw Value (dBuV) + Correction Factor (dB/m).
2. Correction Factor (dB/m) = Antenna Factor (dB/m) + Cable Factor (dB).
3. The other emission levels were very low against the limit.
4. Margin value = Emission level – Limit value.
5. " * ": Fundamental frequency.



A D T

CHANNEL	TX Channel 6	DETECTOR FUNCTION	Peak (PK)
FREQUENCY RANGE	1GHz ~ 25GHz		Average (AV)

ANTENNA POLARITY & TEST DISTANCE: HORIZONTAL AT 3 M

NO.	FREQ. (MHz)	EMISSION LEVEL (dBuV/m)	LIMIT (dBuV/m)	MARGIN (dB)	ANTENNA HEIGHT (m)	TABLE ANGLE (Degree)	RAW VALUE (dBuV)	CORRECTION FACTOR (dB/m)
1	*2437.00	111.4 PK			1.39 H	244	79.09	32.31
2	*2437.00	102.3 AV			1.39 H	244	69.99	32.31
3	4874.00	49.9 PK	74.0	-24.1	1.31 H	232	8.24	41.66
4	4874.00	37.5 AV	54.0	-16.5	1.31 H	232	-4.16	41.66
5	7311.00	57.8 PK	74.0	-16.2	1.55 H	153	11.66	46.14
6	7311.00	44.8 AV	54.0	-9.2	1.55 H	153	-1.34	46.14

ANTENNA POLARITY & TEST DISTANCE: VERTICAL AT 3 M

NO.	FREQ. (MHz)	EMISSION LEVEL (dBuV/m)	LIMIT (dBuV/m)	MARGIN (dB)	ANTENNA HEIGHT (m)	TABLE ANGLE (Degree)	RAW VALUE (dBuV)	CORRECTION FACTOR (dB/m)
1	*2437.00	102.8 PK			1.17 V	334	70.49	32.31
2	*2437.00	94.1 AV			1.17 V	334	61.79	32.31
3	4874.00	47.1 PK	74.0	-26.9	1.00 V	184	5.44	41.66
4	4874.00	38.4 AV	54.0	-15.6	1.00 V	184	-3.26	41.66
5	7311.00	55.5 PK	74.0	-18.5	1.02 V	211	9.36	46.14
6	7311.00	46.2 AV	54.0	-7.8	1.02 V	211	0.06	46.14

REMARKS:

1. Emission level (dBuV/m) = Raw Value (dBuV) + Correction Factor (dB/m).
2. Correction Factor (dB/m) = Antenna Factor (dB/m) + Cable Factor (dB).
3. The other emission levels were very low against the limit.
4. Margin value = Emission level – Limit value.
5. " * ": Fundamental frequency.



A D T

CHANNEL	TX Channel 11	DETECTOR FUNCTION	Peak (PK)
FREQUENCY RANGE	1GHz ~ 25GHz		Average (AV)

ANTENNA POLARITY & TEST DISTANCE: HORIZONTAL AT 3 M

NO.	FREQ. (MHz)	EMISSION LEVEL (dBuV/m)	LIMIT (dBuV/m)	MARGIN (dB)	ANTENNA HEIGHT (m)	TABLE ANGLE (Degree)	RAW VALUE (dBuV)	CORRECTION FACTOR (dB/m)
1	*2462.00	108.3 PK			1.37 H	268	75.93	32.37
2	*2462.00	98.8 AV			1.37 H	268	66.43	32.37
3	2483.50	70.3 PK	74.0	-3.7	1.37 H	268	37.87	32.43
4	2483.50	52.8 AV	54.0	-1.2	1.37 H	268	20.37	32.43
5	4924.00	48.4 PK	74.0	-25.6	1.32 H	242	6.70	41.70
6	4924.00	38.4 AV	54.0	-15.6	1.32 H	242	-3.30	41.70
7	7386.00	56.8 PK	74.0	-17.2	1.56 H	159	10.47	46.33
8	7386.00	44.6 AV	54.0	-9.4	1.56 H	159	-1.73	46.33

ANTENNA POLARITY & TEST DISTANCE: VERTICAL AT 3 M

NO.	FREQ. (MHz)	EMISSION LEVEL (dBuV/m)	LIMIT (dBuV/m)	MARGIN (dB)	ANTENNA HEIGHT (m)	TABLE ANGLE (Degree)	RAW VALUE (dBuV)	CORRECTION FACTOR (dB/m)
1	*2462.00	100.2 PK			1.04 V	331	67.83	32.37
2	*2462.00	91.5 AV			1.04 V	331	59.13	32.37
3	2483.50	60.0 PK	74.0	-14.0	1.04 V	331	27.57	32.43
4	2483.50	47.3 AV	54.0	-6.7	1.04 V	331	14.87	32.43
5	4924.00	46.9 PK	74.0	-27.1	1.03 V	195	5.20	41.70
6	4924.00	38.3 AV	54.0	-15.7	1.03 V	195	-3.40	41.70
7	7386.00	55.4 PK	74.0	-18.6	1.03 V	196	9.07	46.33
8	7386.00	44.2 AV	54.0	-9.8	1.03 V	196	-2.13	46.33

REMARKS:

1. Emission level (dBuV/m) = Raw Value (dBuV) + Correction Factor (dB/m).
2. Correction Factor (dB/m) = Antenna Factor (dB/m) + Cable Factor (dB).
3. The other emission levels were very low against the limit.
4. Margin value = Emission level – Limit value.
5. " * " : Fundamental frequency.

802.11n (40MHz)

CHANNEL	TX Channel 3	DETECTOR FUNCTION	Peak (PK)
FREQUENCY RANGE	1GHz ~ 25GHz		Average (AV)

ANTENNA POLARITY & TEST DISTANCE: HORIZONTAL AT 3 M								
NO.	FREQ. (MHz)	EMISSION LEVEL (dBuV/m)	LIMIT (dBuV/m)	MARGIN (dB)	ANTENNA HEIGHT (m)	TABLE ANGLE (Degree)	RAW VALUE (dBuV)	CORRECTION FACTOR (dB/m)
1	2390.00	69.2 PK	74.0	-4.8	1.42 H	253	37.01	32.19
2	2390.00	53.0 AV	54.0	-1.0	1.42 H	253	20.81	32.19
3	*2422.00	104.4 PK			1.42 H	253	72.13	32.27
4	*2422.00	95.1 AV			1.42 H	253	62.83	32.27
5	4844.00	47.8 PK	74.0	-26.2	1.34 H	248	6.19	41.61
6	4844.00	38.3 AV	54.0	-15.7	1.34 H	248	-3.31	41.61
7	7266.00	57.6 PK	74.0	-16.4	1.59 H	158	11.58	46.02
8	7266.00	44.8 AV	54.0	-9.2	1.59 H	158	-1.22	46.02

ANTENNA POLARITY & TEST DISTANCE: VERTICAL AT 3 M								
NO.	FREQ. (MHz)	EMISSION LEVEL (dBuV/m)	LIMIT (dBuV/m)	MARGIN (dB)	ANTENNA HEIGHT (m)	TABLE ANGLE (Degree)	RAW VALUE (dBuV)	CORRECTION FACTOR (dB/m)
1	2390.00	59.3 PK	74.0	-14.7	1.10 V	320	27.11	32.19
2	2390.00	46.2 AV	54.0	-7.8	1.10 V	320	14.01	32.19
3	*2422.00	96.2 PK			1.11 V	310	63.93	32.27
4	*2422.00	88.8 AV			1.11 V	310	56.53	32.27
5	4844.00	46.6 PK	74.0	-27.4	1.00 V	194	4.99	41.61
6	4844.00	37.9 AV	54.0	-16.1	1.00 V	194	-3.71	41.61
7	7266.00	55.9 PK	74.0	-18.1	1.00 V	188	9.88	46.02
8	7266.00	44.7 AV	54.0	-9.3	1.00 V	188	-1.32	46.02

REMARKS:

1. Emission level (dBuV/m) = Raw Value (dBuV) + Correction Factor (dB/m).
2. Correction Factor (dB/m) = Antenna Factor (dB/m) + Cable Factor (dB).
3. The other emission levels were very low against the limit.
4. Margin value = Emission level – Limit value.
5. " * ": Fundamental frequency.



A D T

CHANNEL	TX Channel 6	DETECTOR FUNCTION	Peak (PK)
FREQUENCY RANGE	1GHz ~ 25GHz		Average (AV)

ANTENNA POLARITY & TEST DISTANCE: HORIZONTAL AT 3 M

NO.	FREQ. (MHz)	EMISSION LEVEL (dBuV/m)	LIMIT (dBuV/m)	MARGIN (dB)	ANTENNA HEIGHT (m)	TABLE ANGLE (Degree)	RAW VALUE (dBuV)	CORRECTION FACTOR (dB/m)
1	2390.00	69.5 PK	74.0	-4.5	1.46 H	249	37.31	32.19
2	2390.00	52.9 AV	54.0	-1.1	1.46 H	249	20.71	32.19
3	*2437.00	106.0 PK			1.46 H	249	73.69	32.31
4	*2437.00	96.7 AV			1.46 H	249	64.39	32.31
5	4874.00	47.5 PK	74.0	-26.5	1.30 H	256	5.84	41.66
6	4874.00	37.9 AV	54.0	-16.1	1.30 H	256	-3.76	41.66
7	7311.00	57.5 PK	74.0	-16.5	1.59 H	144	11.36	46.14
8	7311.00	44.6 AV	54.0	-9.4	1.59 H	144	-1.54	46.14

ANTENNA POLARITY & TEST DISTANCE: VERTICAL AT 3 M

NO.	FREQ. (MHz)	EMISSION LEVEL (dBuV/m)	LIMIT (dBuV/m)	MARGIN (dB)	ANTENNA HEIGHT (m)	TABLE ANGLE (Degree)	RAW VALUE (dBuV)	CORRECTION FACTOR (dB/m)
1	*2437.00	97.9 PK			1.11 V	334	65.59	32.31
2	*2437.00	90.1 AV			1.11 V	334	57.79	32.31
3	4874.00	46.5 PK	74.0	-27.5	1.00 V	203	4.84	41.66
4	4874.00	37.9 AV	54.0	-16.1	1.00 V	203	-3.76	41.66
5	7311.00	55.9 PK	74.0	-18.1	1.00 V	204	9.76	46.14
6	7311.00	44.8 AV	54.0	-9.2	1.00 V	204	-1.34	46.14

REMARKS:

1. Emission level (dBuV/m) = Raw Value (dBuV) + Correction Factor (dB/m).
2. Correction Factor (dB/m) = Antenna Factor (dB/m) + Cable Factor (dB).
3. The other emission levels were very low against the limit.
4. Margin value = Emission level – Limit value.
5. " * ": Fundamental frequency.



A D T

CHANNEL	TX Channel 9	DETECTOR FUNCTION	Peak (PK)
FREQUENCY RANGE	1GHz ~ 25GHz		Average (AV)

ANTENNA POLARITY & TEST DISTANCE: HORIZONTAL AT 3 M

NO.	FREQ. (MHz)	EMISSION LEVEL (dBuV/m)	LIMIT (dBuV/m)	MARGIN (dB)	ANTENNA HEIGHT (m)	TABLE ANGLE (Degree)	RAW VALUE (dBuV)	CORRECTION FACTOR (dB/m)
1	*2452.00	104.1 PK			1.46 H	253	71.75	32.35
2	*2452.00	94.9 AV			1.46 H	253	62.55	32.35
3	2483.50	69.7 PK	74.0	-4.3	1.46 H	253	37.27	32.43
4	2483.50	53.3 AV	54.0	-0.7	1.46 H	253	20.87	32.43
5	4904.00	47.5 PK	74.0	-26.5	1.25 H	242	5.79	41.71
6	4904.00	38.4 AV	54.0	-15.6	1.25 H	242	-3.31	41.71
7	7356.00	57.1 PK	74.0	-16.9	1.57 H	136	10.84	46.26
8	7356.00	44.4 AV	54.0	-9.6	1.57 H	136	-1.86	46.26

ANTENNA POLARITY & TEST DISTANCE: VERTICAL AT 3 M

NO.	FREQ. (MHz)	EMISSION LEVEL (dBuV/m)	LIMIT (dBuV/m)	MARGIN (dB)	ANTENNA HEIGHT (m)	TABLE ANGLE (Degree)	RAW VALUE (dBuV)	CORRECTION FACTOR (dB/m)
1	*2452.00	95.4 PK			1.12 V	324	63.05	32.35
2	*2452.00	87.8 AV			1.12 V	324	55.45	32.35
3	2483.50	60.1 PK	74.0	-13.9	1.12 V	321	27.67	32.43
4	2483.50	47.3 AV	54.0	-6.7	1.12 V	321	14.87	32.43
5	4904.00	46.7 PK	74.0	-27.3	1.00 V	194	4.99	41.71
6	4904.00	37.8 AV	54.0	-16.2	1.00 V	194	-3.91	41.71
7	7356.00	55.7 PK	74.0	-18.3	1.00 V	205	9.44	46.26
8	7356.00	44.6 AV	54.0	-9.4	1.00 V	205	-1.66	46.26

REMARKS:

1. Emission level (dBuV/m) = Raw Value (dBuV) + Correction Factor (dB/m).
2. Correction Factor (dB/m) = Antenna Factor (dB/m) + Cable Factor (dB).
3. The other emission levels were very low against the limit.
4. Margin value = Emission level – Limit value.
5. " * " : Fundamental frequency.



A D T

4.3 6dB BANDWIDTH MEASUREMENT

4.3.1 LIMITS OF 6dB BANDWIDTH MEASUREMENT

The minimum of 6dB Bandwidth Measurement is 0.5 MHz.

4.3.2 TEST INSTRUMENTS

DESCRIPTION & MANUFACTURER	MODEL NO.	SERIAL NO.	CALIBRATED DATE	CALIBRATED UNTIL
R&S Spectrum Analyzer	FSP 40	100060	May 11, 2011	May 10, 2012

Note:

1. The calibration interval of the above test instruments is 12 months and the calibrations are traceable to NML/ROC and NIST/USA.
2. Tested date : Apr. 17, 2012

4.3.3 TEST PROCEDURE

1. Set resolution bandwidth (RBW) = approximately 1% of the emission bandwidth
2. Set the video bandwidth (VBW) $\geq 3 \times$ RBW, Detector = Peak.
3. Trace mode = max hold.
4. Sweep = auto couple.
5. Measure the maximum width of the emission that is constrained by the frequencies associated with the two amplitude points (upper and lower) that are attenuated by 6 dB relative to the maximum level measured in the fundamental emission

4.3.4 DEVIATION FROM TEST STANDARD

No deviation

4.3.5 TEST SETUP

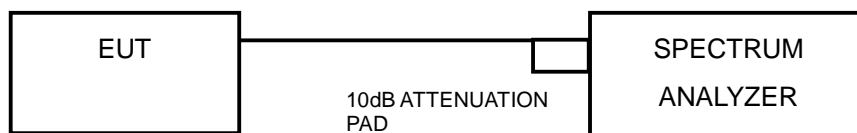

4.3.6 EUT OPERATING CONDITIONS

The software provided by client to enable the EUT under transmission condition continuously at lowest, middle and highest channel frequencies individually.



4.3.7 TEST RESULTS

802.11b

CHANNEL	FREQUENCY (MHz)	6dB BANDWIDTH (MHz)	MINIMUM LIMIT (MHz)	PASS / FAIL
1	2412	10.87	0.5	PASS
6	2437	10.58	0.5	PASS
11	2462	10.37	0.5	PASS

802.11g

CHANNEL	FREQUENCY (MHz)	6dB BANDWIDTH (MHz)	MINIMUM LIMIT (MHz)	PASS / FAIL
1	2412	16.48	0.5	PASS
6	2437	16.59	0.5	PASS
11	2462	16.45	0.5	PASS

802.11n (20MHz)

CHANNEL	FREQUENCY (MHz)	6dB BANDWIDTH (MHz)	MINIMUM LIMIT (MHz)	PASS / FAIL
1	2412	17.62	0.5	PASS
6	2437	17.68	0.5	PASS
11	2462	17.74	0.5	PASS

802.11n (40MHz)

CHANNEL	FREQUENCY (MHz)	6dB BANDWIDTH (MHz)	MINIMUM LIMIT (MHz)	PASS / FAIL
3	2422	36.67	0.5	PASS
6	2437	36.09	0.5	PASS
9	2452	36.37	0.5	PASS

4.4 CONDUCTED OUTPUT POWER MEASUREMENT

4.4.1 LIMITS OF MAXIMUM PEAK OUTPUT POWER MEASUREMENT

For systems using digital modulation in the 2400–2483.5 MHz band: 1 Watt (30dBm)

4.4.2 INSTRUMENTS

DESCRIPTION & MANUFACTURER	MODEL NO.	SERIAL NO.	CALIBRATED DATE	CALIBRATED UNTIL
Peak Power Meter	ML2495A	0824006	May 04, 2011	May 03, 2012
Power Sensor	MA2411B	0738172	May 03, 2011	May 02, 2012

Note:

1. The calibration interval of the above test instruments is 12 months and the calibrations are traceable to NML/ROC and NIST/USA.
2. Tested date : Apr. 17, 2012

4.4.3 TEST PROCEDURES

A peak power sensor was used on the output port of the EUT. A power meter was used to read the response of the peak power sensor. Record the peak power level.

4.4.4 DEVIATION FROM TEST STANDARD

No deviation

4.4.5 TEST SETUP

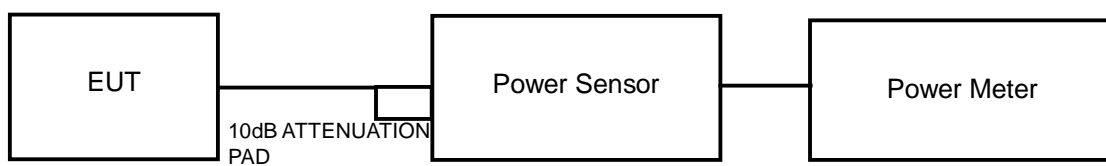

4.4.6 EUT OPERATING CONDITIONS

Same as Item 4.3.6



A D T

4.4.7 TEST RESULTS

802.11b

CHANNEL	FREQUENCY (MHz)	PEAK POWER (mW)	PEAK POWER (dBm)	PEAK POWER LIMIT (dBm)	PASS/FAIL
1	2412	128.825	21.10	30	PASS
6	2437	177.828	22.50	30	PASS
11	2462	87.096	19.40	30	PASS

802.11g

CHANNEL	FREQUENCY (MHz)	PEAK POWER (mW)	PEAK POWER (dBm)	PEAK POWER LIMIT (dBm)	PASS/FAIL
1	2412	288.403	24.60	30	PASS
6	2437	309.030	24.90	30	PASS
11	2462	186.209	22.70	30	PASS

802.11n (20MHz)

CHANNEL	FREQUENCY (MHz)	PEAK POWER (mW)	PEAK POWER (dBm)	PEAK POWER LIMIT (dBm)	PASS/FAIL
1	2412	281.838	24.50	30	PASS
6	2437	295.121	24.70	30	PASS
11	2462	173.780	22.40	30	PASS

802.11n (40MHz)

CHANNEL	FREQUENCY (MHz)	PEAK POWER (mW)	PEAK POWER (dBm)	PEAK POWER LIMIT (dBm)	PASS/FAIL
3	2422	165.959	22.20	30	PASS
6	2437	239.883	23.80	30	PASS
9	2452	151.356	21.80	30	PASS

4.5 POWER SPECTRAL DENSITY MEASUREMENT

4.5.1 LIMITS OF POWER SPECTRAL DENSITY MEASUREMENT

The Maximum of Power Spectral Density Measurement is 8dBm.

4.5.2 TEST INSTRUMENTS

DESCRIPTION & MANUFACTURER	MODEL NO.	SERIAL NO.	CALIBRATED DATE	CALIBRATED UNTIL
R&S Spectrum Analyzer	FSP 40	100060	May 11, 2011	May 10, 2012

Note:

1. The calibration interval of the above test instruments is 12 months and the calibrations are traceable to NML/ROC and NIST/USA.
2. Tested date : Apr. 17, 2012

4.5.3 TEST PROCEDURE

1. Set the RBW = 100 kHz, VBW =300 kHz, Detector = peak.
2. Sweep time = auto couple, Trace mode = max hold, allow trace to fully stabilize.
3. Use the peak marker function to determine the maximum power level in any 100 kHz band segment within the fundamental EBW.
4. Scale the observed power level to an equivalent value in 3 kHz by adjusting (reducing) the measured power by a bandwidth correction factor (BWCF) where $BWCF = 10\log(3 \text{ kHz}/100\text{kHz})$

4.5.4 DEVIATION FROM TEST STANDARD

No deviation

4.5.5 TEST SETUP

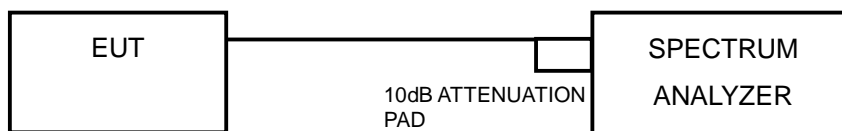

4.5.6 EUT OPERATING CONDITION

Same as Item 4.3.6

4.5.7 TEST RESULTS

802.11b

Channel	FREQ. (MHz)	PSD (dBm/100kHz)	PSD (dBm/3kHz)	Limit (dBm/3kHz)	PASS /FAIL
1	2412	10.42	-4.81	8	PASS
6	2437	11.95	-3.28	8	PASS
11	2462	9.08	-6.15	8	PASS

802.11g

Channel	FREQ. (MHz)	PSD (dBm/100kHz)	PSD (dBm/3kHz)	Limit (dBm/3kHz)	PASS /FAIL
1	2412	6.07	-9.16	8	PASS
6	2437	7.33	-7.90	8	PASS
11	2462	3.33	-11.90	8	PASS

802.11n (20MHz)

Channel	FREQ. (MHz)	PSD (dBm/100kHz)	PSD (dBm/3kHz)	Limit (dBm/3kHz)	PASS /FAIL
1	2412	6.15	-9.08	8	PASS
6	2437	7.36	-7.87	8	PASS
11	2462	4.00	-11.23	8	PASS

802.11n (40MHz)

Channel	FREQ. (MHz)	PSD (dBm/100kHz)	PSD (dBm/3kHz)	Limit (dBm/3kHz)	PASS /FAIL
3	2422	1.43	-13.80	8	PASS
6	2437	3.24	-11.99	8	PASS
9	2452	0.85	-14.38	8	PASS



A D T

4.6 CONDUCTED OUT-BAND EMISSION MEASUREMENT

4.6.1 LIMITS OF CONDUCTED OUT-BAND EMISSION MEASUREMENT

Below -20dB of the highest emission level of operating band (in 100kHz Resolution Bandwidth).

4.6.2 TEST INSTRUMENTS

DESCRIPTION & MANUFACTURER	MODEL NO.	SERIAL NO.	CALIBRATED DATE	CALIBRATED UNTIL
R&S Spectrum Analyzer	FSP 40	100060	May 11, 2011	May 10, 2012

Note:

1. The calibration interval of the above test instruments is 12 months and the calibrations are traceable to NML/ROC and NIST/USA.
2. Tested date : Apr. 17, 2012

4.6.3 TEST PROCEDURE

MEASUREMENT PROCEDURE REF

1. Set the RBW = 100 kHz.
2. Set the VBW \geq 300 kHz.
3. Detector = peak.
4. Sweep time = auto couple.
5. Trace mode = max hold.
6. Allow trace to fully stabilize.
7. Use the peak marker function to determine the maximum power level in any 100 kHz band segment within the fundamental EBW.

MEASUREMENT PROCEDURE OOB

1. Set RBW = 100 kHz.
2. Set VBW \geq 300 kHz.
3. Set span to encompass the spectrum to be examined
4. Detector = peak.
5. Trace Mode = max hold.
6. Sweep = auto couple.

4.6.4 DEVIATION FROM TEST STANDARD

No deviation

4.6.5 TEST SETUP

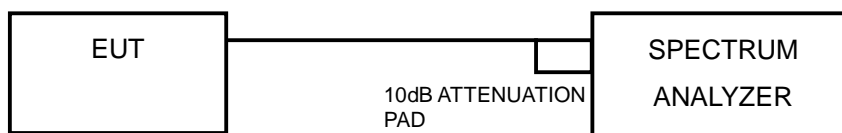

4.6.6 EUT OPERATING CONDITION

Same as Item 4.3.6

4.6.7 TEST RESULTS

The spectrum plots are attached on the following pages. D1 line indicates the highest level, and D2 line indicates the 20dB offset below D1. It shows compliance with the requirement.



A D T

802.11b

CH 1

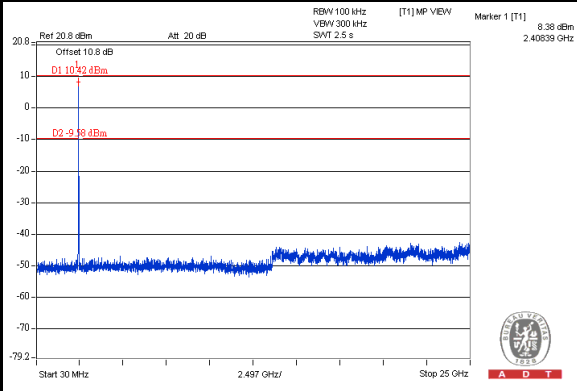
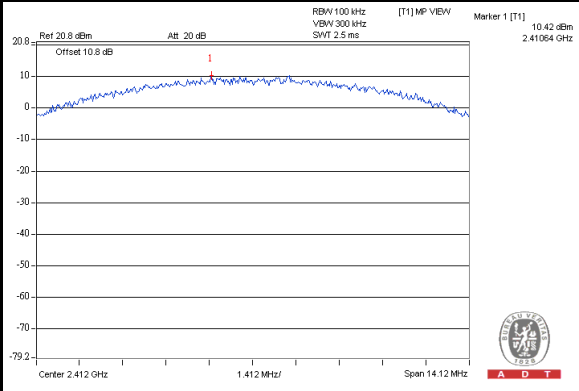

CH 6

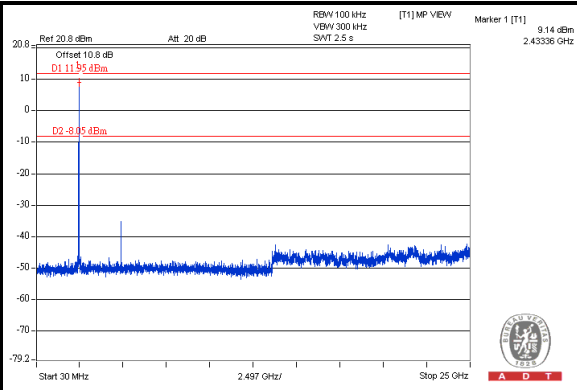
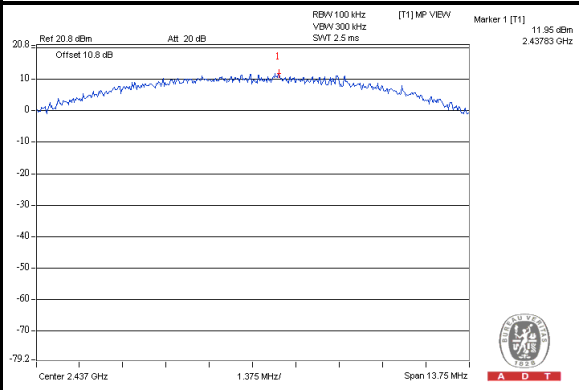

CH 11

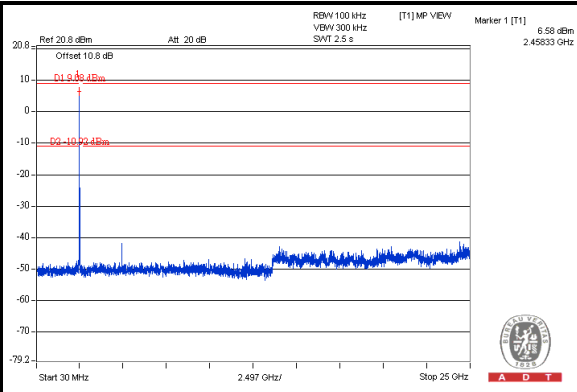
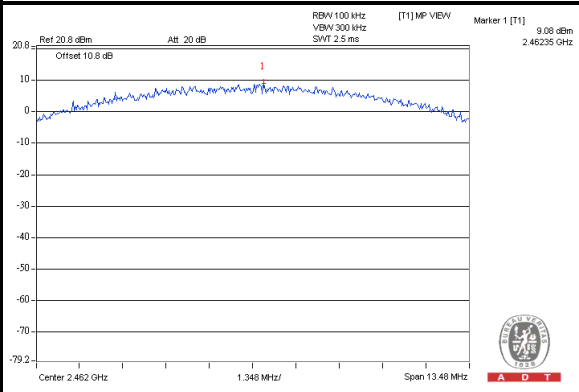



A D T

802.11g

CH 1

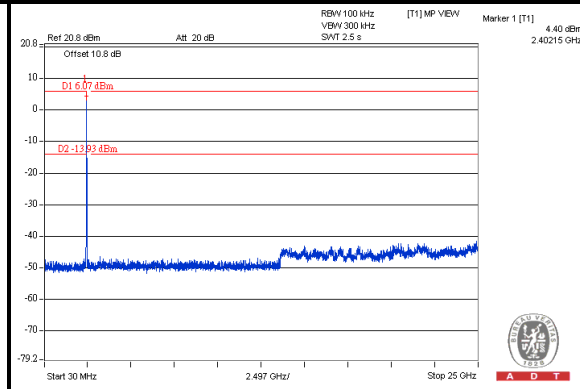
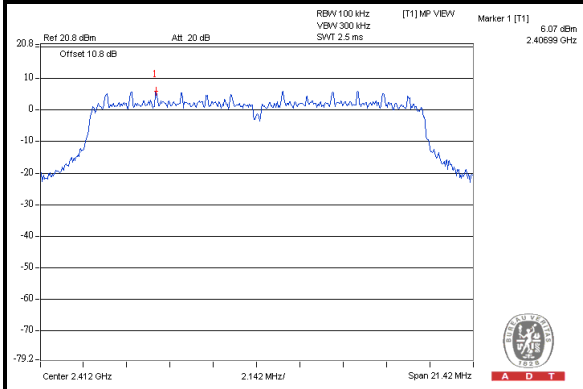

CH 6

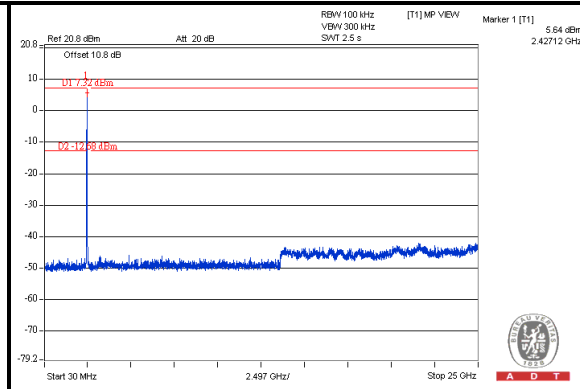
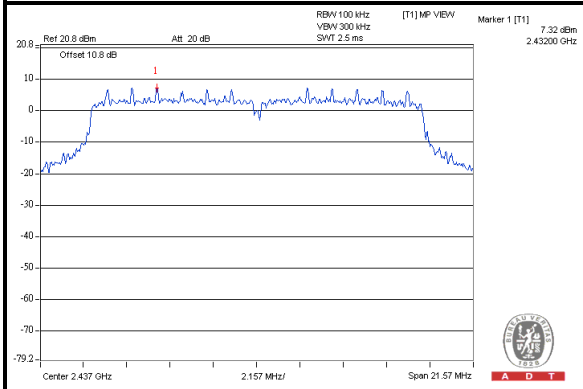

CH 11

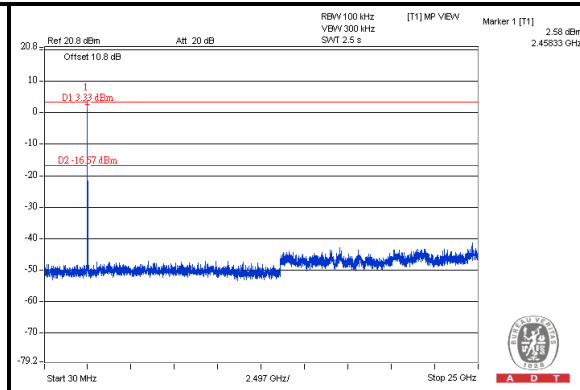
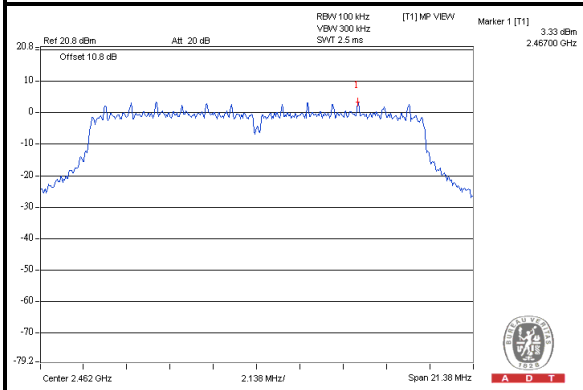



A D T

802.11n (20MHz)

CH 1

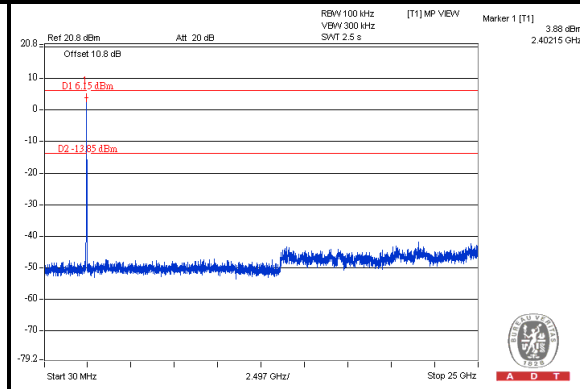
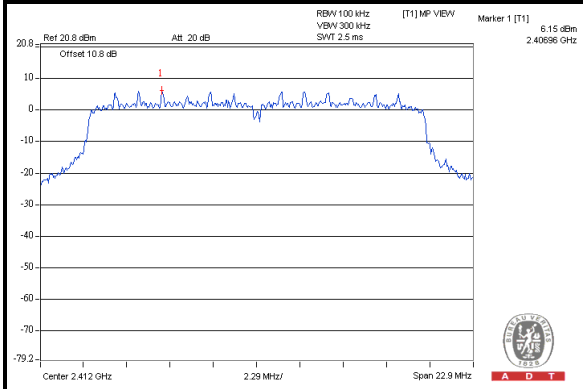

CH 6

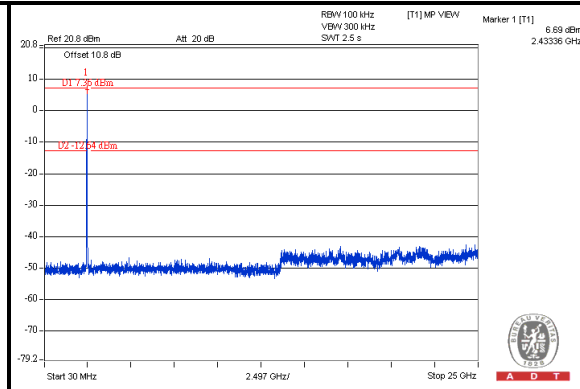
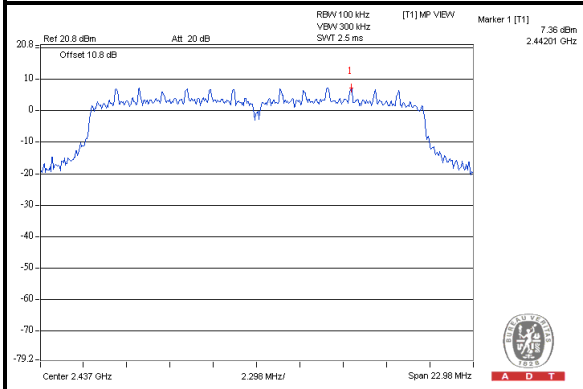

CH 11

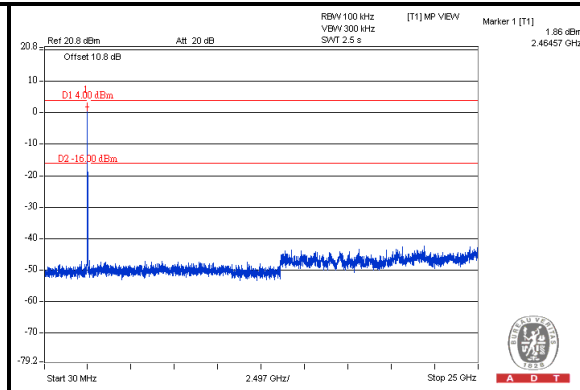
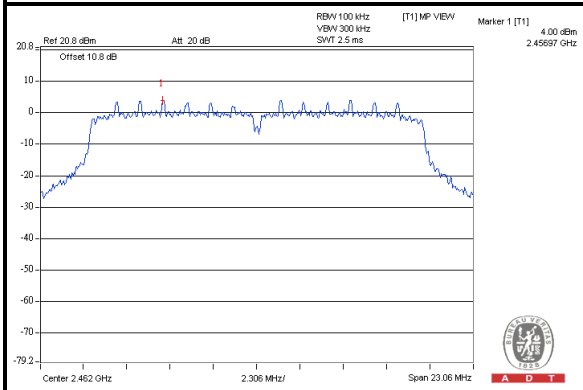



A D T

802.11n (40MHz)

CH 3

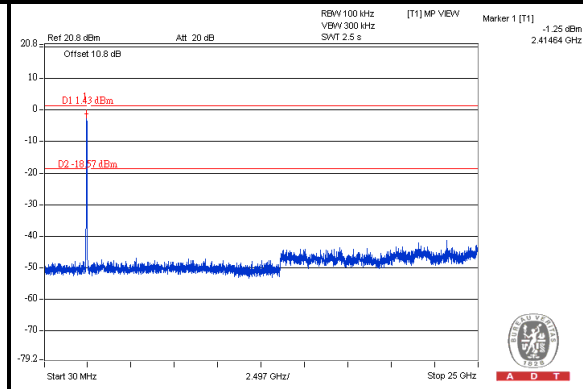
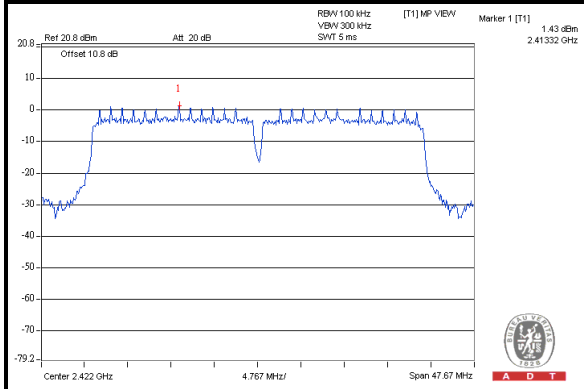

CH 6

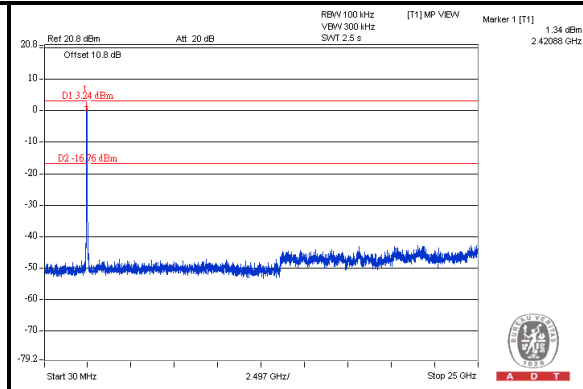
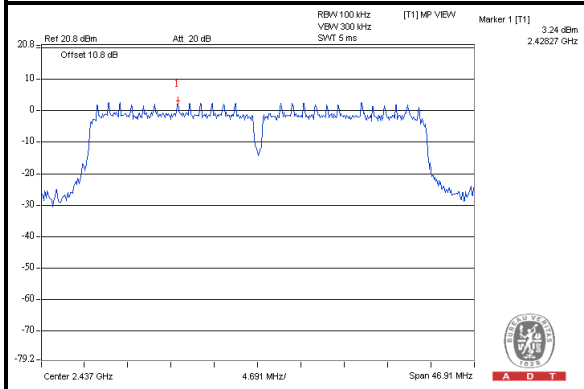

CH 9

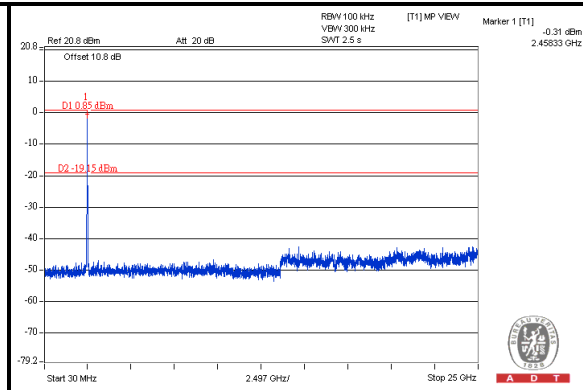
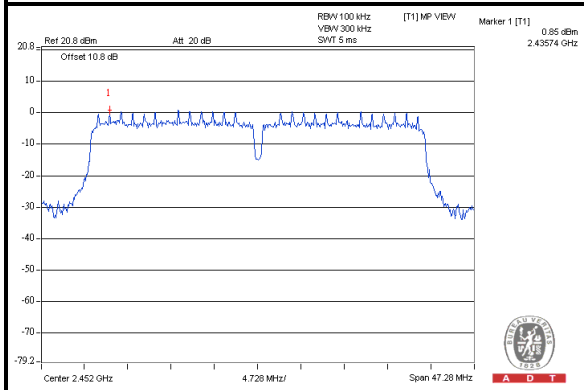



A D T

5. PHOTOGRAPHS OF THE TEST CONFIGURATION

Please refer to the attached file (Test Setup Photo).

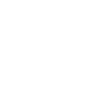



6. INFORMATION ON THE TESTING LABORATORIES

We, Bureau Veritas Consumer Products Services (H.K.) Ltd., Taoyuan Branch, were founded in 1988 to provide our best service in EMC, Radio, Telecom and Safety consultation. Our laboratories are accredited and approved according to ISO/IEC 17025.

Copies of accreditation and authorization certificates of our laboratories obtained from approval agencies can be downloaded from our web site:

www.adt.com.tw/index.5.phtml.

If you have any comments, please feel free to contact us at the following:

Linko EMC/RF Lab:

Tel: 886-2-26052180

Fax: 886-2-26052943

Hsin Chu EMC/RF Lab:

Tel: 886-3-5935343

Fax: 886-3-5935342

Hwa Ya EMC/RF/Safety/Telecom Lab:

Tel: 886-3-3183232

Fax: 886-3-3270892

Email: service.adt@tw.bureauveritas.com

Web Site: www.adt.com.tw

The address and road map of all our labs can be found in our web site also.



A D T

7. APPENDIX A - MODIFICATIONS RECORDERS FOR ENGINEERING CHANGES TO THE EUT BY THE LAB

No modifications were made to the EUT by the lab during the test.

--- END ---