



FCC TEST REPORT (15.407)

REPORT NO.: RF950116H01
MODEL NO.: J20H027
RECEIVED: Jan. 17, 2006
TESTED: Jan. 20 to 23, 2006
ISSUED: Jan. 24, 2006

APPLICANT: HON HAI PRECISION IND. CO., LTD.
HSINCHU SCIENCE PARK BRANCH OFFICE

ADDRESS: 5F-1,5 Hsin-An Road Hsinchu, Science-Based
Industrial Park Taiwan, R.O.C.

ISSUED BY: Advance Data Technology Corporation

TEST LOCATION: No. 81-1, Lu Liao Keng, 9 Ling, Wu Lung
Tsuen, Chiung Lin Hsiang, Hsin Chu Hsien,
Taiwan, R.O.C.

This test report consists of 59 pages in total. It may be duplicated completely for legal use with the approval of the applicant. It should not be reproduced except in full, without the written approval of our laboratory. The client should not use it to claim product endorsement by CNLA, A2LA or any government agencies. The test results in the report only apply to the tested sample. The test results in this report are traceable to the national or international standards.



No. 2177-01



Table of Contents

1.	CERTIFICATION.....	4
2.	SUMMARY OF TEST RESULTS.....	5
3.	GENERAL INFORMATION	6
3.1	GENERAL DESCRIPTION OF EUT.....	6
3.2	DESCRIPTION OF TEST MODES.....	7
3.2.1	TEST MODE APPLICABILITY AND TESTED CHANNEL DETAIL:.....	8
3.3	GENERAL DESCRIPTION OF APPLIED STANDARDS	10
3.4	DESCRIPTION OF SUPPORT UNITS	11
3.5	CONFIGURATION OF SYSTEM UNDER TEST	11
4.	TEST TYPES AND RESULTS.....	12
4.1	CONDUCTED EMISSION MEASUREMENT	12
4.1.1	LIMITS OF CONDUCTED EMISSION MEASUREMENT	12
4.1.2	TEST INSTRUMENTS	12
4.1.3	TEST PROCEDURES	13
4.1.4	DEVIATION FROM TEST STANDARD	13
4.1.5	TEST SETUP.....	14
4.1.6	EUT OPERATING CONDITIONS.....	14
4.1.7	TEST RESULTS	15
4.2	RADIATED EMISSION MEASUREMENT	17
4.2.1	LIMITS OF RADIATED EMISSION MEASUREMENT	17
4.2.2	LIMITS OF UNWANTED EMISSION OUT OF THE RESTRICTED BANDS.....	18
4.2.3	TEST INSTRUMENTS	19
4.2.4	TEST PROCEDURES	20
4.2.5	DEVIATION FROM TEST STANDARD	20
4.2.6	TEST SETUP.....	21
4.2.7	EUT OPERATING CONDITION.....	21
4.2.8	TEST RESULTS	22
4.3	PEAK TRANSMIT POWER MEASUREMENT	27
4.3.1	LIMITS OF PEAK TRANSMIT POWER MEASUREMENT	27
4.3.2	TEST INSTRUMENTS.....	27
4.3.3	TEST PROCEDURE.....	28
4.3.4	DEVIATION FROM TEST STANDARD	28
4.3.5	TEST SETUP.....	28
4.3.6	EUT OPERATING CONDITIONS.....	28
4.3.7	TEST RESULTS	29
4.4	PEAK POWER EXCURSION MEASUREMENT	34



4.4.1	LIMITS OF PEAK POWER EXCURSION MEASUREMENT	34
4.4.2	TEST INSTRUMENTS	34
4.4.3	TEST PROCEDURE	35
4.4.4	DEVIATION FROM TEST STANDARD	35
4.4.5	TEST SETUP	35
4.4.6	EUT OPERATING CONDITIONS	35
4.4.7	TEST RESULTS	36
4.5	PEAK POWER SPECTRAL DENSITY MEASUREMENT	39
4.5.1	LIMITS OF PEAK POWER SPECTRAL DENSITY MEASUREMENT	39
4.5.2	TEST INSTRUMENTS	39
4.5.3	TEST PROCEDURES	40
4.5.4	DEVIATION FROM TEST STANDARD	40
4.5.5	TEST SETUP	40
4.5.6	EUT OPERATING CONDITIONS	40
4.5.7	TEST RESULTS	41
4.6	FREQUENCY STABILITY	44
4.6.1	LIMITS OF FREQUENCY STABILITY MEASUREMENT	44
4.6.2	TEST INSTRUMENTS	44
4.6.3	TEST PROCEDURE	44
4.6.4	DEVIATION FROM TEST STANDARD	45
4.6.5	TEST SETUP	45
4.6.6	EUT OPERATING CONDITION	45
4.6.7	TEST RESULTS	46
4.7	BAND EDGES MEASUREMENT	47
4.7.1	TEST INSTRUMENTS	47
4.7.2	TEST PROCEDURE	47
4.7.3	EUT OPERATING CONDITION	47
4.7.4	TEST RESULTS	48
4.8	ANTENNA REQUIREMENT	53
4.8.1	STANDARD APPLICABLE	53
4.8.2	ANTENNA CONNECTED CONSTRUCTION	53
5.	PHOTOGRAPHS OF THE TEST CONFIGURATION	54
6.	INFORMATION ON THE TESTING LABORATORIES	58
	APPENDIX-A	A-1



1. CERTIFICATION

PRODUCT: Wireless Access Point Module
BRAND NAME: FOXCONN
MODEL NO.: J20H027
TEST SAMPLE: ENGINEERING SAMPLE
TESTED: Jan. 20 to 23, 2006
APPLICANT: HON HAI PRECISION IND. CO., LTD. HSINCHU
SCIENCE PARK BRANCH OFFICE
STANDARDS: FCC Part 15, Subpart E (Section 15.407)
ANSI C63.4-2003

The above equipment (Model: J20H027) has been tested by **Advance Data Technology Corporation**, and found compliance with the requirement of the above standards. The test record, data evaluation & Equipment Under Test (EUT) configurations represented herein are true and accurate accounts of the measurements of the sample's EMC characteristics under the conditions specified in this report.

PREPARED BY : Midoli Peng , **DATE:** Jan. 24, 2006
(Midoli Peng)

TECHNICAL ACCEPTANCE : Hank Chung , **DATE:** Jan. 24, 2006
Responsible for RF (Hank Chung)

APPROVED BY : May Chen , **DATE:** Jan. 24, 2006
(May Chen, Deputy Manager)

2. SUMMARY OF TEST RESULTS

The EUT has been tested according to the following specifications:

APPLIED STANDARD: FCC Part 15, Subpart E (Section 15.407)			
Standard Section	Test Type	Result	Remark
15.407(b)(5)	AC Power Conducted Emission	PASS	Meet the requirement of limit. Minimum passing margin is -14.19dB at 0.486MHz
15.407(b/1/2/3) (b)(5)	Electric Field Strength Spurious Emissions, 30MHz ~ 40000MHz	PASS	Meet the requirement of limit. Minimum passing margin is -0.50dB at 166.24MHz
15.407(a/1/2/3)	Peak Transmit Power	PASS	Meet the requirement of limit.
15.407(a)(6)	Peak Power Excursion	PASS	Meet the requirement of limit.
15.407(a/1/2/3)	Peak Power Spectral Density	PASS	Meet the requirement of limit.
15.407(g)	Frequency Stability	PASS	Meet the requirement of limit.

NOTE:

1. The EUT was operating in 2.412 ~ 2.462GHz and 5.150 ~ 5.350GHz frequencies band. This report was recorded the RF parameters including 5.150 ~ 5.350GHz. For the 2.412 ~ 2.462GHz RF parameters was recorded in another test report.



3. GENERAL INFORMATION

3.1 GENERAL DESCRIPTION OF EUT

EUT	Wireless Access Point Module
MODEL NO.	J20H027
FCC ID	MCLJ20H027
POWER SUPPLY	DC 3.3V from host equipment
MODULATION TYPE	CCK, DQPSK, DBPSK for DSSS 64QAM, 16QAM, QPSK, BPSK for OFDM
MODULATION TECHNOLOGY	DSSS, OFDM
TRANSFER RATE	802.11b: 11/5.5/2/1Mbps 802.11g: 54/48/36/24/18/12/9/6Mbps 802.11a: 54/48/36/24/18/12/9/6Mbps
FREQUENCY RANGE	802.11b & 802.11g: 2412 ~ 2462MHz 802.11a: 5150 ~ 5350 MHz
NUMBER OF CHANNEL	802.11b & 802.11g: 11 802.11a: 8
CHANNEL SPACING	802.11b & 802.11g: 5MHz 802.11a: 20MHz for Normal mode
OUTPUT POWER	802.11b: 138.038mW 802.11g: 288.403mW 802.11a: 241.546mW
DATA CABLE	NA
ANTENNA TYPE	PCB antenna with 2.02dBi antenna gain(For 2.4GHz) and 2.05dBi(For 5GHz)
I/O PORTS	NA
ASSOCIATED DEVICES	NA

NOTE:

1. The EUT operates in both the 5GHz and 2.4GHz Bands and compatibility with 802.11a and 802.11b, 802.11g technology.
2. The above EUT information was declared by the manufacturer and for more detailed features description, please refer to the manufacturer's specifications or User's Manual.

3.2 DESCRIPTION OF TEST MODES

Operated in 5150MHz ~ 5350MHz bands:

Eight channels are provided to this EUT for normal mode.

Channel	Frequency
1	5180 MHz
2	5200 MHz
3	5220 MHz
4	5240 MHz
5	5260 MHz
6	5280 MHz
7	5300 MHz
8	5320 MHz

3.2.1 TEST MODE APPLICABILITY AND TESTED CHANNEL DETAIL:

EUT configure mode	Applicable to				Description
	PLC	RE<1G	RE≥1G	APCM	
-	X	X	X	X	NA

Where PLC: Power Line Conducted Emission RE<1G RE: Radiated Emission below 1GHz
 RE≥1G: Radiated Emission above 1GHz APCM: Antenna Port Conducted Measurement

Power Line Conducted Emission Test:

- Pre-Scan has been conducted to determine the worst-case mode from all possible combinations between available modulations, data rates and antenna ports (if EUT with antenna diversity architecture).
- Following channel(s) was (were) selected for the final test as listed below.

Mode	Available Channel	Tested Channel	Modulation Technology	Modulation Type	Data Rate (Mbps)
802.11a	1 to 8	8	OFDM	BPSK	6

Radiated Emission Test (Below 1 GHz):

- Pre-Scan has been conducted to determine the worst-case mode from all possible combinations between available modulations, data rates and antenna ports (if EUT with antenna diversity architecture).
- Following channel(s) was (were) selected for the final test as listed below.

Mode	Available Channel	Tested Channel	Modulation Technology	Modulation Type	Data Rate (Mbps)
802.11a	1 to 8	8	OFDM	BPSK	6

Radiated Emission Test (Above 1 GHz):

- Pre-Scan has been conducted to determine the worst-case mode from all possible combinations between available modulations, data rates and antenna ports (if EUT with antenna diversity architecture).
- Following channel(s) was (were) selected for the final test as listed below.

Mode	Available Channel	Tested Channel	Modulation Technology	Modulation Type	Data Rate (Mbps)
802.11a	1 to 8	1, 4, 5, 8	OFDM	BPSK	6



Bandedge Measurement:

- Pre-Scan has been conducted to determine the worst-case mode from all possible combinations between available modulations, data rates and antenna ports (if EUT with antenna diversity architecture).
- Following channel(s) was (were) selected for the final test as listed below.

Mode	Available Channel	Tested Channel	Modulation Technology	Modulation Type	Data Rate (Mbps)
802.11a	1 to 8	1, 8	OFDM	BPSK	6

Antenna Port Conducted Measurement:

- Pre-Scan has been conducted to determine the worst-case mode from all possible combinations between available modulations, data rates and antenna ports (if EUT with antenna diversity architecture).
- Following channel(s) was (were) selected for the final test as listed below.

Mode	Available Channel	Tested Channel	Modulation Technology	Modulation Type	Data Rate (Mbps)
802.11a	1 to 8	1, 4, 5, 8	OFDM	BPSK	6



3.3 GENERAL DESCRIPTION OF APPLIED STANDARDS

The EUT is a Wireless Access Point Module. According to the specifications of the manufacturer, it must comply with the requirements of the following standards:

FCC Part 15, Subpart E (15.407)

ANSI C63.4-2003

All test items have been performed and recorded as per the above standards.

NOTE: The EUT is also considered as a kind of computer peripheral, because the connection to computer is necessary for typical use. It has been verified to comply with the requirements of FCC Part 15, Subpart B, Class B (DoC). The test report has been issued separately.

3.4 DESCRIPTION OF SUPPORT UNITS

The EUT has been tested as an independent unit together with other necessary accessories or support units. The following support units or accessories were used to form a representative test configuration during the tests.

No.	Product	Brand	Model No.	Serial No.	FCC ID
1	NOTEBOOK COMPUTER	ASUS	A2400H	49NG038481	NA
2	PRINTER	EPSON	LQ-300+	DCGY046777	B94C2642X
3	Cardbus	ADT	ADT-RF-001	NA	NA

No.	Signal cable description
1	NA
2	1.8m braid shielded wire, terminated with DB25 and Centronics connector via metallic frame, w/o core
3	NA

Note: 1. All power cords of the above support units are unshielded (1.8m).

3.5 CONFIGURATION OF SYSTEM UNDER TEST

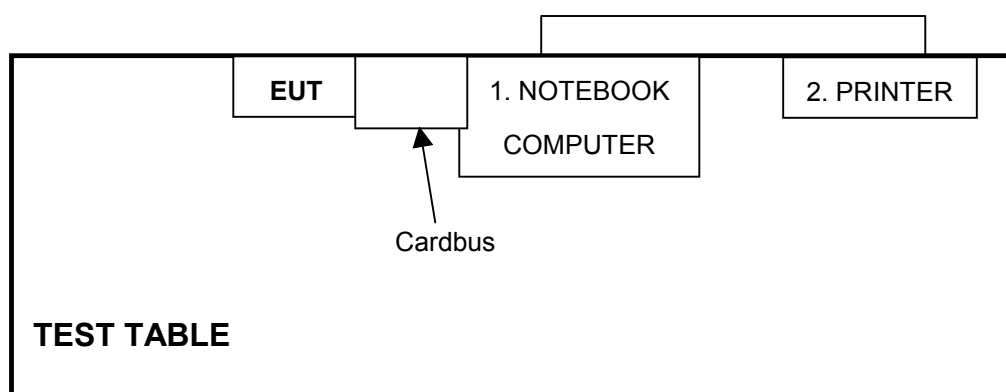

NOTE: 1. Please refer to the photos of test configuration in Item 5 also.



4. TEST TYPES AND RESULTS

4.1 CONDUCTED EMISSION MEASUREMENT

4.1.1 LIMITS OF CONDUCTED EMISSION MEASUREMENT

FREQUENCY OF EMISSION (MHz)	CONDUCTED LIMIT (dB μ V)	
	Quasi-peak	Average
0.15-0.5	66 to 56	56 to 46
0.5-5	56	46
5-30	60	50

- NOTE:**
1. The lower limit shall apply at the transition frequencies.
 2. The limit decreases in line with the logarithm of the frequency in the range of 0.15 to 0.50 MHz.
 3. All emanations from a class A/B digital device or system, including any network of conductors and apparatus connected thereto, shall not exceed the level of field strengths specified above.

4.1.2 TEST INSTRUMENTS

DESCRIPTION & MANUFACTURER	MODEL NO.	SERIAL NO.	CALIBRATED UNTIL
Test Receiver	ESCS 30	100375	Sep. 19, 2006
Line-Impedance Stabilization Network(for EUT)	ENV-216	100071	Nov. 10, 2006
ROHDE & SCHWARZ LISN	ESH3-Z5	848773/004	Oct. 24, 2006
RF Signal Cable	RG233	COBCAB9K-30MHz	Dec. 10, 2006
Impedance-stabilization-network	ENY 41	838119/024	Jan. 09, 2006
Impedance-stabilization-network	ENY 22	837497/019	Jan. 09, 2006
Current Probe	SMZ11	18001	Jul. 13, 2006
Current Probe	SMZ11	18013	Jul. 13, 2006

- NOTE:**
1. The calibration interval of the above test instruments is 12 months and the calibrations are traceable to NML/ROC and NIST/USA.
 2. The test was performed in ADT Shielded Room No. B.
 3. The VCCI Con B Registration No. is C-2193.

4.1.3 TEST PROCEDURES

- a. The EUT was placed 0.4 meters from the conducting wall of the shielded room with EUT being connected to the power mains through a line impedance stabilization network (LISN). Other support units were connected to the power mains through another LISN. The two LISNs provide 50 ohm/ 50uH of coupling impedance for the measuring instrument.
- b. Both lines of the power mains connected to the EUT were checked for maximum conducted interference.
- c. The frequency range from 150kHz to 30MHz was searched. Emission level under (Limit - 20dB) was not recorded.

4.1.4 DEVIATION FROM TEST STANDARD

No deviation

4.1.5 TEST SETUP

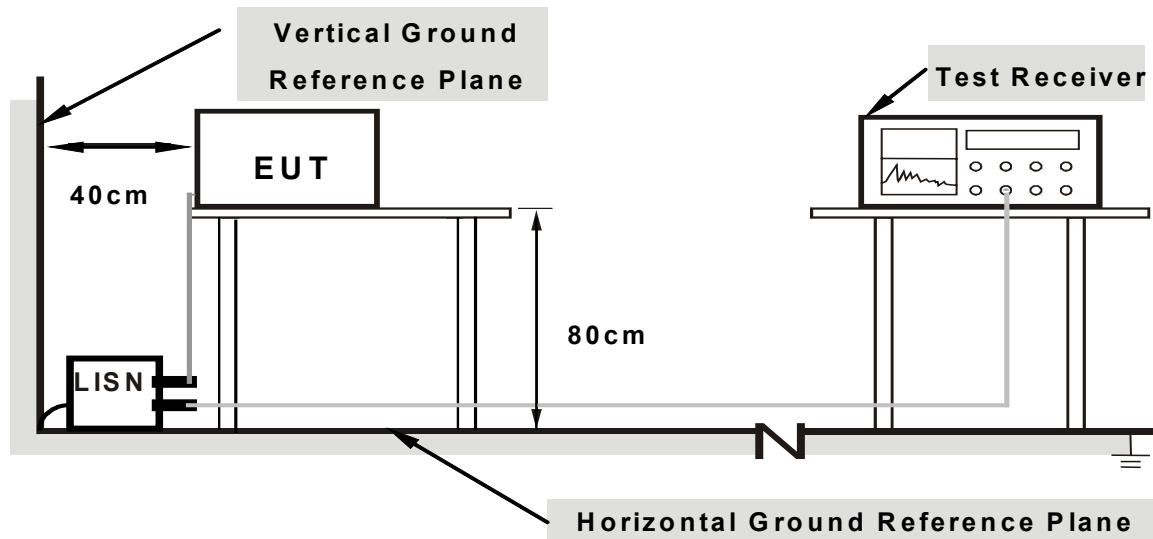

Note: 1. Support units were connected to second LISN.

2. Both of LISNs (AMN) are 80 cm from EUT and at least 80 from other units and other metal planes

For the actual test configuration, please refer to the related item – Photographs of the Test Configuration.

4.1.6 EUT OPERATING CONDITIONS

- a. Plug the EUT into test board and placed on the testing table.
- b. The support unit 1 (Notebook computer) ran a test program “ART53 build12” to enable EUT under transmission condition continuously at specific channel frequency.
- c. Notebook computer sends "H" messages to printer, and the printer prints them on paper.

4.1.7 TEST RESULTS

Conducted Worst-Case Data

MODE	Channel 8	6dB BANDWIDTH	9 kHz
MODULATION TYPE	BPSK	TRANSFER RATE	6Mbps
INPUT POWER (SYSTEM)	120Vac, 60 Hz	PHASE	Line (L)
ENVIRONMENTAL CONDITIONS	20deg. C, 60%RH, 976hPa	TESTED BY	Eric Lee

No	Freq. [MHz]	Corr. Factor (dB)	Reading Value		Emission Level		Limit		Margin	
			[dB (uV)]		[dB (uV)]		[dB (uV)]		(dB)	
			Q.P.	AV.	Q.P.	AV.	Q.P.	AV.	Q.P.	AV.
1	0.193	9.25	34.12	-	43.37	-	63.91	53.91	-20.54	-
2	0.259	9.21	34.65	-	43.86	-	61.45	51.45	-17.60	-
3	0.345	9.20	31.25	-	40.45	-	59.07	49.07	-18.62	-
4	0.376	9.20	33.81	-	43.01	-	58.37	48.37	-15.36	-
5	0.486	9.19	32.86	-	42.05	-	56.24	46.24	-14.19	-
6	0.588	9.19	29.32	-	38.51	-	56.00	46.00	-17.49	-
7	0.795	9.22	26.67	-	35.89	-	56.00	46.00	-20.11	-

- REMARKS:**
1. Q.P. and AV. are abbreviations of quasi-peak and average individually.
 2. "-": The Quasi-peak reading value also meets average limit and measurement with the average detector is unnecessary.
 3. The emission levels of other frequencies were very low against the limit.
 4. Margin value = Emission level - Limit value
 5. Correction factor = Insertion loss + Cable loss
 6. Emission Level = Correction Factor + Reading Value.

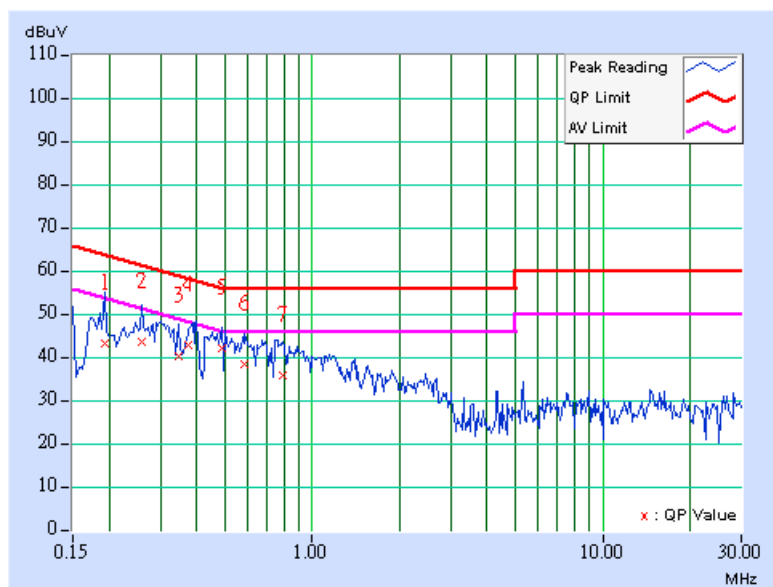

MODE	Channel 8	6dB BANDWIDTH	9 kHz
MODULATION TYPE	BPSK	TRANSFER RATE	6Mbps
INPUT POWER (SYSTEM)	120Vac, 60 Hz	PHASE	Neutral (N)
ENVIRONMENTAL CONDITIONS	20deg. C, 60%RH, 976hPa	TESTED BY	Eric Lee

No	Freq. [MHz]	Corr. Factor (dB)	Reading Value [dB (uV)]		Emission Level [dB (uV)]		Limit [dB (uV)]		Margin (dB)	
			Q.P.	AV.	Q.P.	AV.	Q.P.	AV.	Q.P.	AV.
			1	0.150	9.19	40.32	-	48.46	-	66.00
2	0.213	9.19	36.49	-	45.62	-	63.11	53.11	-17.48	-
3	0.248	9.20	31.71	-	40.91	-	61.84	51.84	-20.93	-
4	0.380	9.23	26.89	-	36.12	-	58.27	48.27	-22.15	-
5	0.500	9.25	27.65	-	36.90	-	56.00	46.00	-19.10	-
6	0.685	9.20	29.39	-	38.50	-	56.00	46.00	-17.50	-
7	2.388	9.33	22.36	-	31.26	-	56.00	46.00	-24.74	-

- REMARKS:**
1. Q.P. and AV. are abbreviations of quasi-peak and average individually.
 2. "-": The Quasi-peak reading value also meets average limit and measurement with the average detector is unnecessary.
 3. The emission levels of other frequencies were very low against the limit.
 4. Margin value = Emission level - Limit value
 5. Correction factor = Insertion loss + Cable loss
 6. Emission Level = Correction Factor + Reading Value.

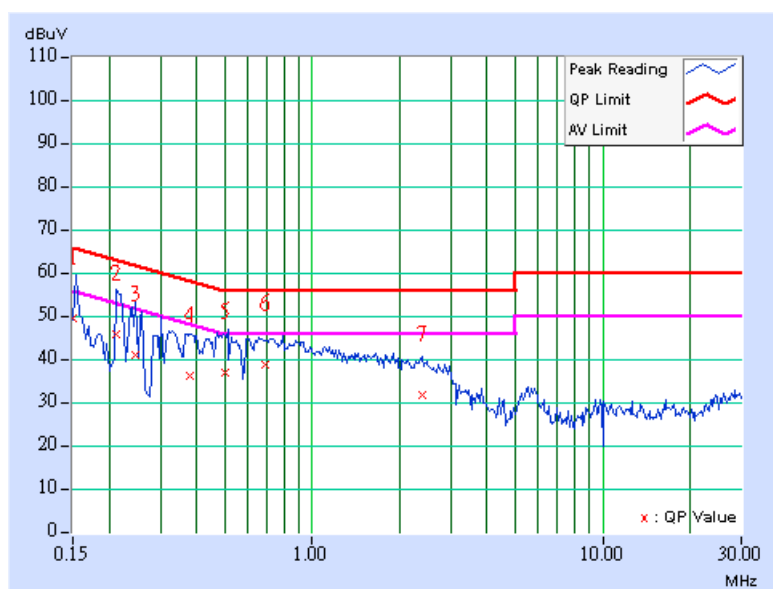

4.2 RADIATED EMISSION MEASUREMENT

4.2.1 LIMITS OF RADIATED EMISSION MEASUREMENT

Emissions radiated outside of the specified bands, shall be according to the general radiated limits in 15.209 as following:

Frequencies (MHz)	Field strength (microvolts/meter)	Measurement distance (meters)
0.009-0.490	2400/F(kHz)	300
0.490-1.705	24000/F(kHz)	30
1.705-30.0	30	30
30-88	100	3
88-216	150	3
216-960	200	3
Above 960	500	3

NOTE:

1. The lower limit shall apply at the transition frequencies.
2. Emission level (dBuV/m) = 20 log Emission level (uV/m).
3. As shown in 15.35(b), for frequencies above 1000MHz, the field strength limits are based on average detector, however, the peak field strength of any emission shall not exceed the maximum permitted average limits, specified above by more than 20dB under any condition of modulation.

4.2.2 LIMITS OF UNWANTED EMISSION OUT OF THE RESTRICTED BANDS

Frequencies (MHz)	EIRP Limit (dBm)	Equivalent Field Strength at 3m (dB μ V/m) *note 3
5150~5250	-27	68.3
5250~5350	-27	68.3
5725~5825	-27 *note 1	68.3
	-17 *note 2	78.3

NOTE:

1. For frequencies 10MHz or greater above or below the band edge.
2. All emissions within the frequency range from the band edge to 10MHz above or below the band edge.
3. The following formula is used to convert the equipment isotropic radiated power (eirp) to field strength

$$E = \frac{1000000\sqrt{30P}}{3} \quad \mu\text{V/m, where P is the eirp (Watts)}$$



4.2.3 TEST INSTRUMENTS

DESCRIPTION & MANUFACTURER	MODEL NO.	SERIAL NO.	CALIBRATED UNTIL
ADVANTEST Spectrum Analyzer	R3271A	85060311	July 07, 2006
HP Pre_Amplifier	8449B	3008A01922	Oct. 02, 2006
ROHDE & SCHWARZ Test Receiver	ESCS30	100287	Dec. 08, 2006
CHASE Broadband Antenna	VULB9168	138	Dec. 21, 2006
Schwarzbeck Horn_Antenna	BBHA9120	D124	Dec. 11, 2006
Schwarzbeck Horn_Antenna	BBHA 9170	BBHA9170153	Jan. 30, 2006
SCHWARZBECK Biconical Antenna	VHBA9123	459	Jun. 26, 2006
SCHWARZBECK Periodic Antenna	UPA6108	1148	Jun. 26, 2006
RF Switches (ARNITSU)	CS-201	1565157	NA
RF CABLE (Chaintek) 1GHz-20GHz	SF102	22054-2	Nov. 16. 2006
RF Cable(RICHTEC)	9913-30M	STCCAB-30M- 1GHz-021	Jul. 16, 2006
Software	ADT_Radiated_V 5.14	NA	NA
CHANCE MOST Antenna Tower	AT-100	0203	NA
CHANCE MOST Turn Table	TT-100	0203	NA

Note: 1. The calibration interval of the above test instruments is 12 months (36 months for Periodic Antenna) and the calibrations are traceable to NML/ROC and NIST/USA.

2. The horn antenna and HP preamplifier (model: 8449B) are used only for the measurement of emission frequency above 1GHz if tested.
3. The test was performed in ADT Open Site No. C.
4. The FCC Site Registration No. is 656396.
5. The VCCI Site Registration No. is R-1626.
6. The CANADA Site Registration No. is IC 4824-3.
7. The following table is for the measurement uncertainty, which is calculated as per the document CISPR 16-4. This uncertainty represents an expanded uncertainty expressed at approximately the 95% confidence level using a coverage factor of k=2.

Measurement	Value
Radiated emissions (30MHz-1GHz)	2.98 dB
Radiated emissions (1GHz ~18GHz)	2.21 dB
Radiated emissions (18GHz ~20GHz)	1.88 dB

4.2.4 TEST PROCEDURES

- a. The EUT was placed on the top of a rotating table 0.8 meters above the ground at a 3 meter semi-anechoic chamber. The table was rotated 360 degrees to determine the position of the highest radiation.
- b. The EUT was set 3 meters away from the interference-receiving antenna, which was mounted on the top of a variable-height antenna tower.
- c. The antenna is a broadband antenna, and its height is varied from one meter to four meters above the ground to determine the maximum value of the field strength. Both horizontal and vertical polarizations of the antenna are set to make the measurement.
- d. For each suspected emission, the EUT was arranged to its worst case and then the antenna was tuned to heights from 1 meter to 4 meters and the rotatable table was turned from 0 degrees to 360 degrees to find the maximum reading.
- e. The test-receiver system was set to Peak Detect Function and Specified Bandwidth with Maximum Hold Mode.
- f. If the emission level of the EUT in peak mode was 10dB lower than the limit specified, then testing could be stopped and the peak values of the EUT would be reported. Otherwise the emissions that did not have 10dB margin would be re-tested one by one using peak, quasi-peak or average method as specified and then reported in a data sheet.

NOTE:

1. The resolution bandwidth and video bandwidth of test receiver/spectrum analyzer is 120kHz for Peak detection (PK) and Quasi-peak detection (QP) at frequency below 1GHz.
2. The resolution bandwidth and video bandwidth of test receiver/spectrum analyzer is 1 MHz for Peak detection at frequency above 1GHz.
3. The resolution bandwidth of test receiver/spectrum analyzer is 1 MHz and the video bandwidth is 10 Hz for Average detection (AV) at frequency above 1GHz.

4.2.5 DEVIATION FROM TEST STANDARD

No deviation

4.2.6 TEST SETUP

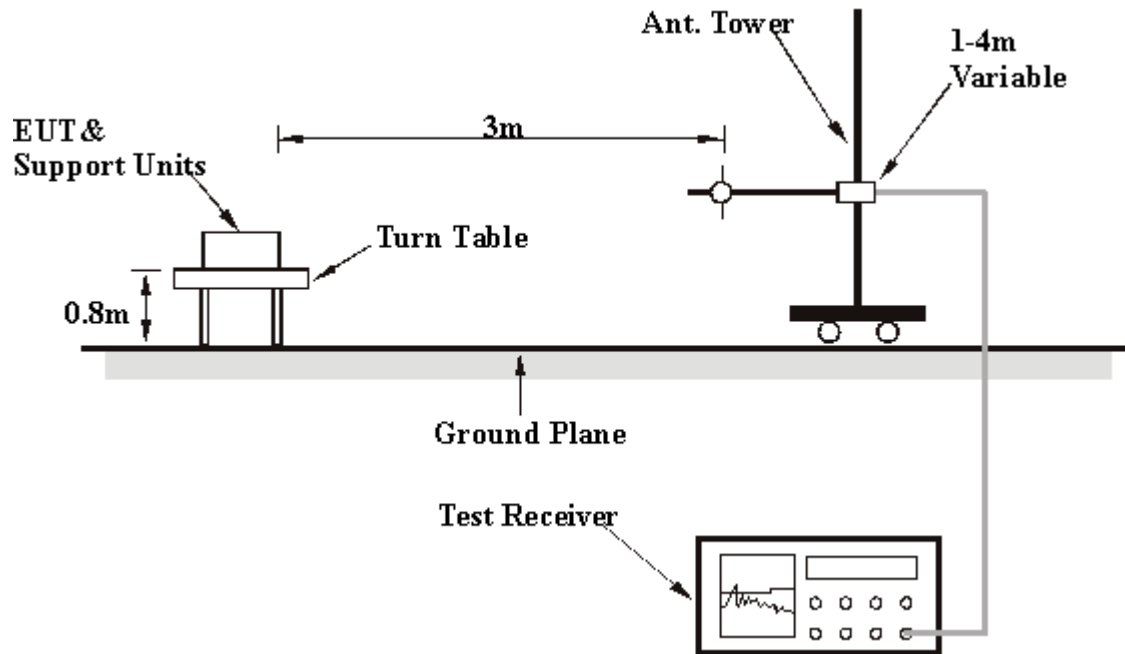

For the actual test configuration, please refer to the related item – Photographs of the Test Configuration.

4.2.7 EUT OPERATING CONDITION

Same as 4.1.6



4.2.8 TEST RESULTS

Below 1GHz Worst-Case Data

MODE	Channel 8	FREQUENCY RANGE	Below 1000MHz
MODULATION TYPE	BPSK	TRANSFER RATE	6Mbps
INPUT POWER (SYSTEM)	120Vac, 60 Hz	DETECTOR FUNCTION	Quasi-Peak
ENVIRONMENTAL CONDITIONS	21deg. C, 63%RH, 976hPa	TESTED BY	Tony Chen

ANTENNA POLARITY & TEST DISTANCE: HORIZONTAL AT 3 M								
No.	Freq. (MHz)	Emission Level (dBuV/m)	Limit (dBuV/m)	Margin (dB)	Antenna Height (m)	Table Angle (Degree)	Raw Value (dBuV)	Correction Factor (dB/m)
1	66.34	25.30 QP	40.00	-14.70	1.20 H	221	12.60	12.70
2	133.27	36.10 QP	43.50	-7.40	1.11 H	120	23.60	12.50
3	166.24	43.00 QP	43.50	-0.50	1.34 H	16	29.60	13.40
4	199.82	36.40 QP	43.50	-7.10	1.00 H	239	25.20	11.20
5	232.88	37.80 QP	46.00	-8.20	1.03 H	360	25.20	12.60
6	393.21	41.70 QP	46.00	-4.30	1.14 H	10	23.50	18.20
7	400.00	39.70 QP	46.00	-6.30	1.13 H	222	21.30	18.40
8	688.12	39.60 QP	46.00	-6.40	1.20 H	17	14.90	24.70
9	786.42	38.50 QP	46.00	-7.50	1.29 H	168	11.90	26.60
10	860.15	31.60 QP	46.00	-14.40	1.25 H	157	4.10	27.50

ANTENNA POLARITY & TEST DISTANCE: VERTICAL AT 3 M								
No.	Freq. (MHz)	Emission Level (dBuV/m)	Limit (dBuV/m)	Margin (dB)	Antenna Height (m)	Table Angle (Degree)	Raw Value (dBuV)	Correction Factor (dB/m)
1	66.39	28.70 QP	40.00	-11.30	1.92 V	19	16.00	12.70
2	166.37	34.30 QP	43.50	-9.20	2.20 V	319	20.90	13.40
3	393.21	35.40 QP	46.00	-10.60	2.07 V	21	17.20	18.20
4	688.12	36.30 QP	46.00	-9.70	1.48 V	294	11.60	24.70
5	786.42	34.10 QP	46.00	-11.90	1.82 V	304	7.60	26.60
6	860.15	28.90 QP	46.00	-17.10	1.83 V	13	1.40	27.50

- REMARKS:**
1. Emission level(dBuV/m)=Raw Value(dBuV) + Correction Factor(dB/m)
 2. Correction Factor(dB/m) = Antenna Factor (dB/m) + Cable Factor (dB)
 3. The other emission levels were very low against the limit.
 4. Margin value = Emission level – Limit value

802.11a OFDM modulation

MODE	Channel 1	FREQUENCY RANGE	1 ~ 40 GHz
MODULATION TYPE	BPSK	TRANSFER RATE	6Mbps
INPUT POWER (SYSTEM)	120Vac, 60 Hz	DETECTOR FUNCTION	Peak(PK) Average (AV)
ENVIRONMENTAL CONDITIONS	20deg. C, 60%RH, 976hPa	TESTED BY	Moris Lin

ANTENNA POLARITY & TEST DISTANCE: HORIZONTAL AT 3 M

No.	Freq. (MHz)	Emission Level (dBuV/m)	Limit (dBuV/m)	Margin (dB)	Antenna Height (m)	Table Angle (Degree)	Raw Value (dBuV)	Correction Factor (dB/m)
1	#5150.00	53.50 PK	74.00	-20.50	1.25 H	326	17.70	35.80
1	#5150.00	43.20 AV	54.00	-10.80	1.25 H	326	7.40	35.80
2	*5180.00	106.50 PK			1.42 H	209	70.70	35.80
2	*5180.00	98.20 AV			1.42 H	209	62.40	35.80
3	10360.00	60.60 PK	68.30	-7.70	1.48 H	300	16.40	44.10

ANTENNA POLARITY & TEST DISTANCE: VERTICAL AT 3 M

No.	Freq. (MHz)	Emission Level (dBuV/m)	Limit (dBuV/m)	Margin (dB)	Antenna Height (m)	Table Angle (Degree)	Raw Value (dBuV)	Correction Factor (dB/m)
1	#5150.00	50.20 PK	74.00	-23.80	1.54 V	24	14.40	35.80
1	#5150.00	40.20 AV	54.00	-13.80	1.54 V	24	4.40	35.80
2	*5180.00	103.20 PK			1.40 V	154	67.40	35.80
2	*5180.00	95.20 AV			1.40 V	154	59.40	35.80
3	10360.00	59.90 PK	68.30	-8.40	1.40 V	50	15.80	44.10

- NOTE:**
1. Emission level(dBuV/m)=Raw Value(dBuV) + Correction Factor(dB/m)
 2. Correction Factor(dB/m) = Antenna Factor (dB/m) + Cable Factor (dB)
 3. The other emission levels were very low against the limit.
 4. Margin value = Emission level – Limit value
 5. "*" : Fundamental frequency
 6. "#"The radiated frequency falling in the restricted band.



MODE	Channel 4	FREQUENCY RANGE	1 ~ 40 GHz
MODULATION TYPE	BPSK	TRANSFER RATE	6Mbps
INPUT POWER (SYSTEM)	120Vac, 60 Hz	DETECTOR FUNCTION	Peak(PK) Average (AV)
ENVIRONMENTAL CONDITIONS	20deg. C, 60%RH, 976hPa	TESTED BY	Moris Lin

ANTENNA POLARITY & TEST DISTANCE: HORIZONTAL AT 3 M								
No.	Freq. (MHz)	Emission Level (dBuV/m)	Limit (dBuV/m)	Margin (dB)	Antenna Height (m)	Table Angle (Degree)	Raw Value (dBuV)	Correction Factor (dB/m)
1	*5240.00	107.90 PK			1.40 H	199	72.20	35.80
1	*5240.00	99.60 AV			1.40 H	199	63.80	35.80
2	#10480.00	50.60 PK	68.30	-17.70	4.00 H	199	6.20	44.40
2	#10480.00	37.60 AV	54.00	-16.40	4.00 H	199	-6.80	44.40

ANTENNA POLARITY & TEST DISTANCE: VERTICAL AT 3 M								
No.	Freq. (MHz)	Emission Level (dBuV/m)	Limit (dBuV/m)	Margin (dB)	Antenna Height (m)	Table Angle (Degree)	Raw Value (dBuV)	Correction Factor (dB/m)
1	*5240.00	101.30 PK			1.36 V	253	65.50	35.80
1	*5240.00	93.30 AV			1.36 V	253	57.50	35.80
2	#10480.00	60.20 PK	68.30	-8.10	4.00 V	184	15.70	44.40
2	#10480.00	48.60 AV	54.00	-5.40	4.00 V	184	4.10	44.40

- NOTE:**
1. Emission level(dBuV/m)=Raw Value(dBuV) + Correction Factor(dB/m)
 2. Correction Factor(dB/m) = Antenna Factor (dB/m) + Cable Factor (dB)
 3. The other emission levels were very low against the limit.
 4. Margin value = Emission level – Limit value
 5. "*" : Fundamental frequency
 6. "#" The radiated frequency falling in the restricted band.



MODE	Channel 5	FREQUENCY RANGE	1 ~ 40 GHz
MODULATION TYPE	BPSK	TRANSFER RATE	6Mbps
INPUT POWER (SYSTEM)	120Vac, 60 Hz	DETECTOR FUNCTION	Peak(PK) Average (AV)
ENVIRONMENTAL CONDITIONS	20deg. C, 60%RH, 976hPa	TESTED BY	Moris Lin

ANTENNA POLARITY & TEST DISTANCE: HORIZONTAL AT 3 M

No.	Freq. (MHz)	Emission Level (dBuV/m)	Limit (dBuV/m)	Margin (dB)	Antenna Height (m)	Table Angle (Degree)	Raw Value (dBuV)	Correction Factor (dB/m)
1	*5260.00	113.90 PK			1.39 H	241	78.10	35.80
1	*5260.00	105.50 AV			1.39 H	241	69.70	35.80
2	10520.00	60.30 PK	68.30	-8.00	1.36 H	286	15.60	44.70

ANTENNA POLARITY & TEST DISTANCE: VERTICAL AT 3 M

No.	Freq. (MHz)	Emission Level (dBuV/m)	Limit (dBuV/m)	Margin (dB)	Antenna Height (m)	Table Angle (Degree)	Raw Value (dBuV)	Correction Factor (dB/m)
1	*5260.00	107.00 PK			1.24 V	254	71.20	35.80
1	*5260.00	99.00 AV			1.24 V	254	63.20	35.80
2	10520.00	63.70 PK	68.30	-4.60	1.58 V	208	19.00	44.70

- NOTE:**
1. Emission level(dBuV/m)=Raw Value(dBuV) + Correction Factor(dB/m)
 2. Correction Factor(dB/m) = Antenna Factor (dB/m) + Cable Factor (dB)
 3. The other emission levels were very low against the limit.
 4. Margin value = Emission level – Limit value
 5. "*" : Fundamental frequency
 6. "#"The radiated frequency falling in the restricted band.



MODE	Channel 8	FREQUENCY RANGE	1 ~ 40 GHz
MODULATION TYPE	BPSK	TRANSFER RATE	6Mbps
INPUT POWER (SYSTEM)	120Vac, 60 Hz	DETECTOR FUNCTION	Peak(PK) Average (AV)
ENVIRONMENTAL CONDITIONS	20deg. C, 60%RH, 976hPa	TESTED BY	Moris Lin

ANTENNA POLARITY & TEST DISTANCE: HORIZONTAL AT 3 M

No.	Freq. (MHz)	Emission Level (dBuV/m)	Limit (dBuV/m)	Margin (dB)	Antenna Height (m)	Table Angle (Degree)	Raw Value (dBuV)	Correction Factor (dB/m)
1	*5320.00	110.90 PK			1.24 H	287	75.10	35.80
1	*5320.00	101.90 AV			1.24 H	287	66.10	35.80
2	#5350.00	71.60 PK	74.00	-2.40	1.25 H	24	35.80	35.80
2	#5350.00	53.10 AV	54.00	-0.90	1.25 H	24	17.30	35.80
3	#10640.00	61.60 PK	74.00	-12.40	1.25 H	24	15.80	45.90
3	#10640.00	50.60 AV	54.00	-3.40	1.25 H	24	4.80	45.90

ANTENNA POLARITY & TEST DISTANCE: VERTICAL AT 3 M

No.	Freq. (MHz)	Emission Level (dBuV/m)	Limit (dBuV/m)	Margin (dB)	Antenna Height (m)	Table Angle (Degree)	Raw Value (dBuV)	Correction Factor (dB/m)
1	*5320.00	105.10 PK			1.34 V	253	69.40	35.80
1	*5320.00	96.50 AV			1.34 V	253	60.70	35.80
2	#5350.00	66.00 PK	74.00	-8.00	1.54 V	24	30.20	35.80
2	#5350.00	47.70 AV	54.00	-6.30	1.54 V	24	11.90	35.80
3	#10640.00	58.60 PK	74.00	-15.40	1.56 V	32	12.70	45.90
3	#10640.00	46.70 AV	54.00	-7.30	1.56 V	32	0.80	45.90

- NOTE:**
1. Emission level(dBuV/m)=Raw Value(dBuV) + Correction Factor(dB/m)
 2. Correction Factor(dB/m) = Antenna Factor (dB/m) + Cable Factor (dB)
 3. The other emission levels were very low against the limit.
 4. Margin value = Emission level – Limit value
 5. "*" : Fundamental frequency
 6. "#"The radiated frequency falling in the restricted band.



4.3 PEAK TRANSMIT POWER MEASUREMENT

4.3.1 LIMITS OF PEAK TRANSMIT POWER MEASUREMENT

Frequency Band	Limit
5.15 – 5.25GHz	The lesser of 50mW (17dBm) or 4dBm + 10logB
5.25 – 5.35GHz	The lesser of 250mW (24dBm) or 11dBm + 10logB
5.725 – 5.825GHz	The lesser of 1W (30dBm) or 17dBm + 10logB

NOTE: Where B is the 26dB emission bandwidth in MHz.

4.3.2 TEST INSTRUMENTS

Description & Manufacturer	Model No.	Serial No.	Calibrated Until
R&S SPECTRUM ANALYZER	FSP40	100036	Nov. 23, 2006

NOTE:

- 1.The measurement uncertainty is less than +/- 2.6dB, which is calculated as per the NAMAS document NIS81. This uncertainty represents an expanded uncertainty expressed at approximately the 95% confidence level using a coverage factor of k=2.
- 2.The calibration interval of the above test instruments is 12 months and the calibrations are traceable to NML/ROC and NIST/USA.

4.3.3 TEST PROCEDURE

1. The transmitter output was connected to the spectrum analyzer.
2. Set span to encompass the entire emission bandwidth of the signal.
3. Set RBW to 1MHz, VBW to 300kHz.
4. Using the spectrum analyzer's channel power measurement function to measure the output power.

NOTE:

The test is performed in accordance with FCC Public Notice: APPENDIX A Guidelines for Assessing Unlicensed National Information Infrastructure (U-NII) Devices – Part 15, Subpart E, August 2002.

The transmitter output operates continuously therefore Method # 1 is used.

4.3.4 DEVIATION FROM TEST STANDARD

No deviation

4.3.5 TEST SETUP

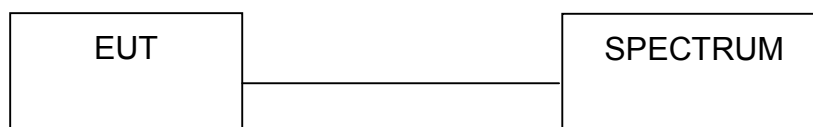

4.3.6 EUT OPERATING CONDITIONS

The software provided by client to enable the EUT under transmission condition continuously at specific channel frequencies individually.



4.3.7 TEST RESULTS

802.11a OFDM modulation

MODULATION TYPE	BPSK	TRANSFER RATE	6Mbps
INPUT POWER (SYSTEM)	120Vac, 60 Hz	ENVIRONMENTAL CONDITIONS	20deg.C, 50%RH, 976hPa
TESTED BY	Tony Chen		

CHANNEL	CHANNEL FREQUENCY (MHz)	PEAK POWER OUTPUT (dBm)	PEAK POWER LIMIT (dBm)	26dBc Occupied Bandwidth (MHz)	PASS/FAIL
1	5180	16.91	17	28.2	PASS
4	5240	16.87	17	25.9	PASS
5	5260	23.83	24	39.7	PASS
5	5320	22.51	24	38.4	PASS

NOTE: The 26dBc Occupied Bandwidth plot, please refer to the following pages.

Peak Power Output:
CH1

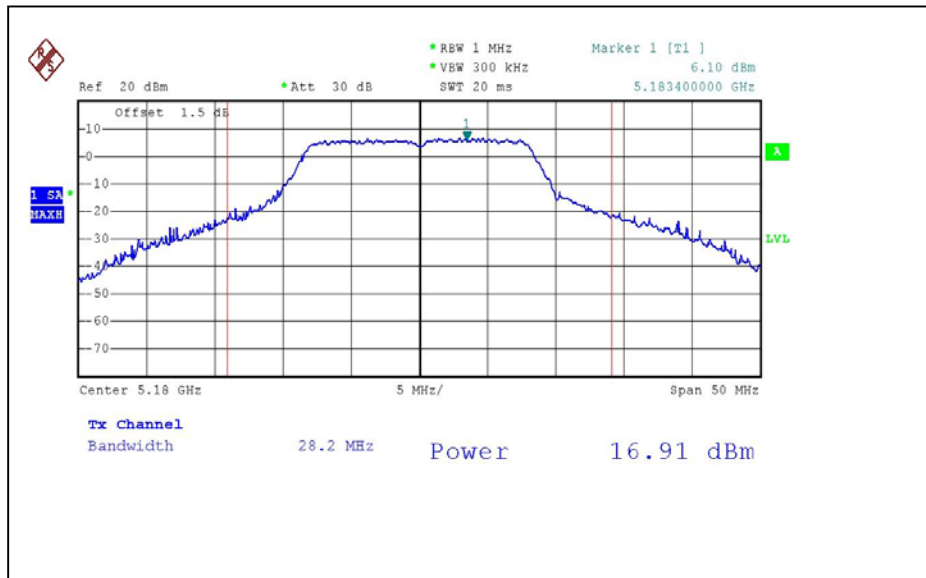

CH4

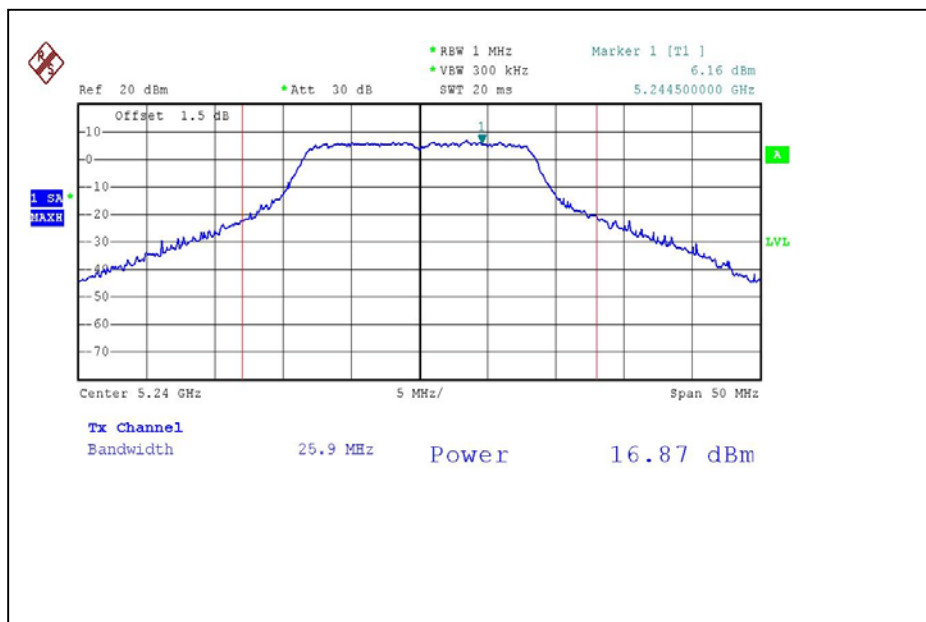

CH5

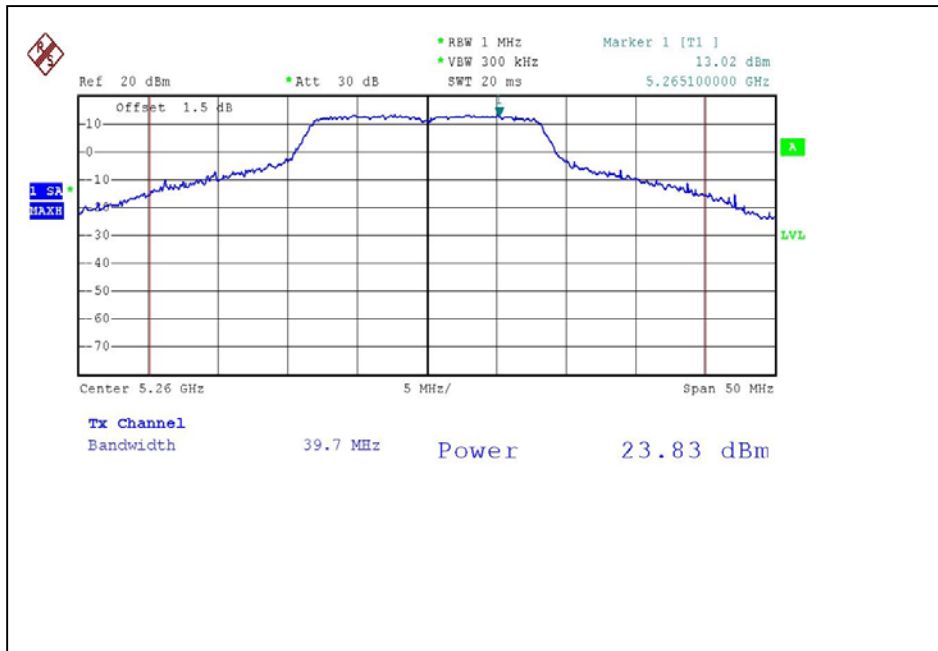

CH8

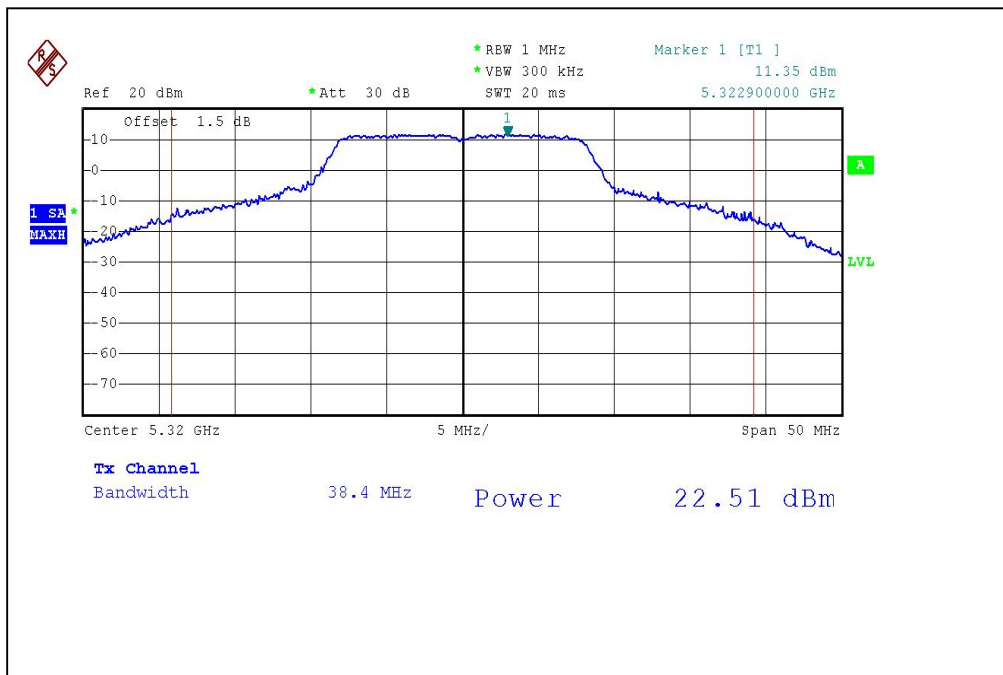

26dB Occupied Bandwidth:
CH1

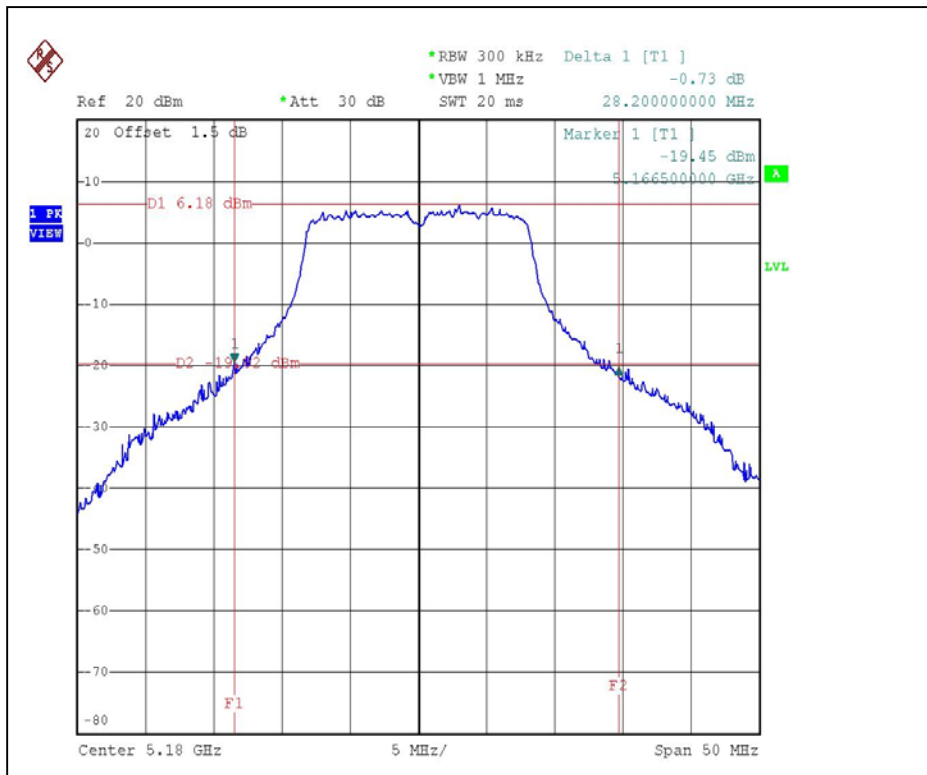

CH4

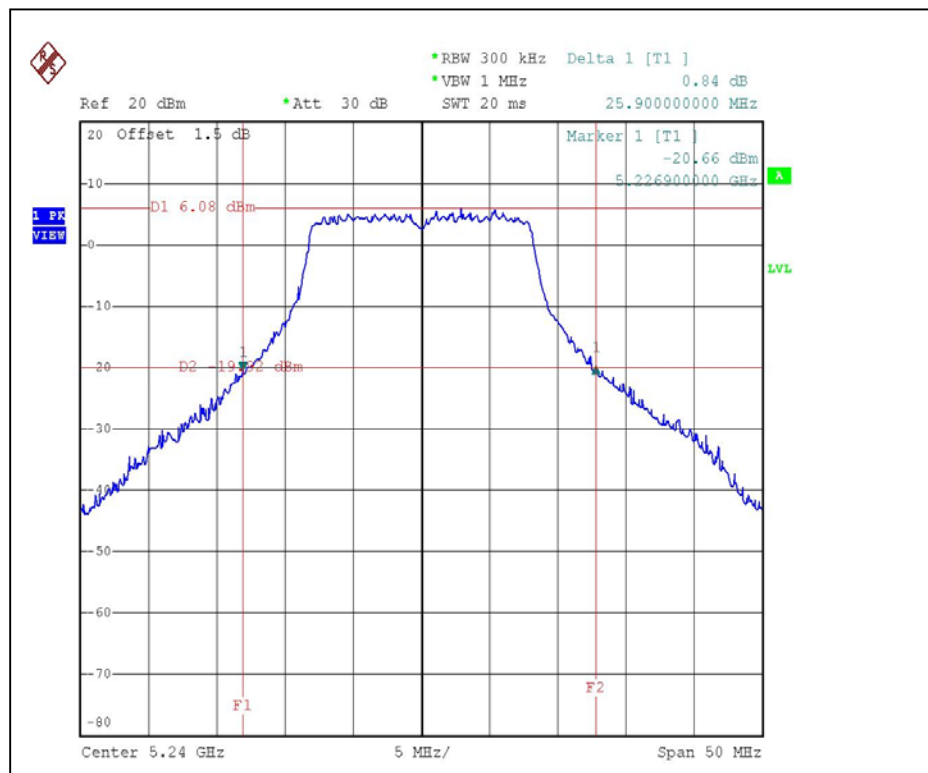

CH5

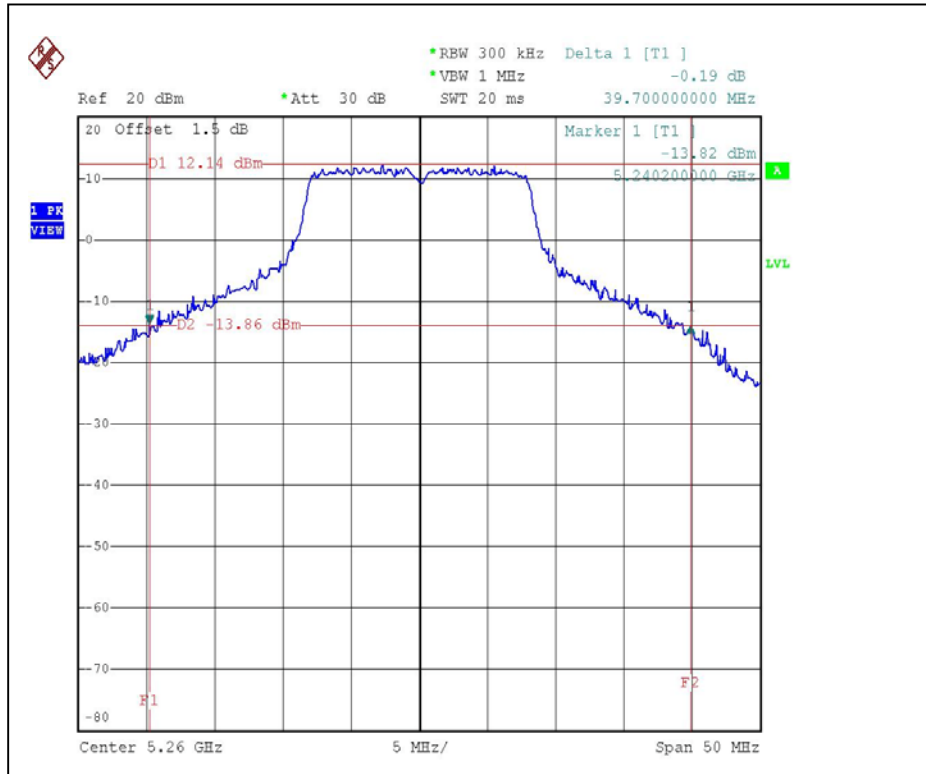

CH8

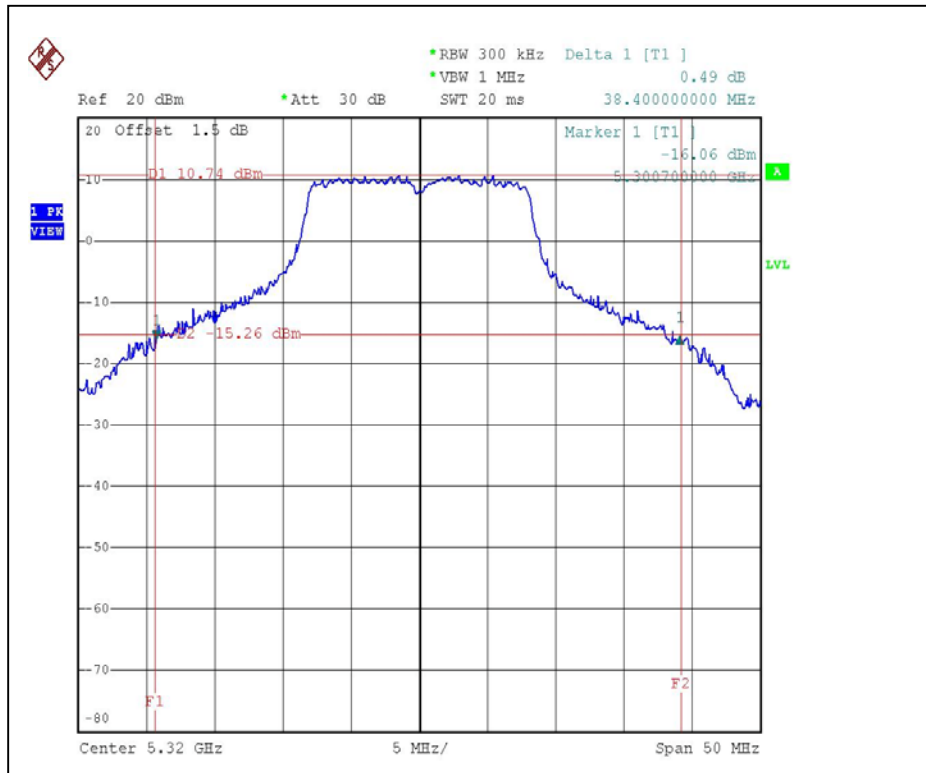



4.4 PEAK POWER EXCURSION MEASUREMENT

4.4.1 LIMITS OF PEAK POWER EXCURSION MEASUREMENT

Frequency Band	Limit
5.15 – 5.25 GHz	13dB
5.25 – 5.35 GHz	13dB
5.725 – 5.825 GHz	13dB

4.4.2 TEST INSTRUMENTS

Description & Manufacturer	Model No.	Serial No.	Calibrated Until
R&S SPECTRUM ANALYZER	FSP40	100036	Nov. 23, 2006

NOTE:

- 1.The measurement uncertainty is less than +/- 2.6dB, which is calculated as per the NAMAS document NIS81. This uncertainty represents an expanded uncertainty expressed at approximately the 95% confidence level using a coverage factor of k=2.
- 2.The calibration interval of the above test instruments is 12 months and the calibrations are traceable to NML/ROC and NIST/USA.

4.4.3 TEST PROCEDURE

1. The transmitter output was connected to the spectrum analyzer.
2. Set the spectrum bandwidth span to view the entire spectrum.
3. Using peak detector and Max-hold function for Trace 1 (RB=1MHz, VB=3MHz) and 2 (RB=1MHz, VB=300KHz).
4. The largest difference between Trace 1 and Trace 2 in any 1MHz band on any frequency was recorded.

4.4.4 DEVIATION FROM TEST STANDARD

No deviation

4.4.5 TEST SETUP

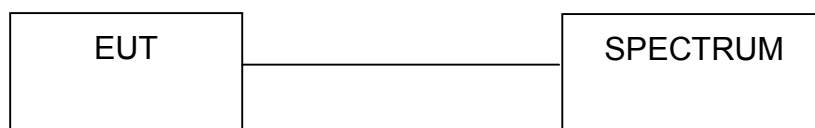

4.4.6 EUT OPERATING CONDITIONS

The software provided by client to enable the EUT under transmission condition continuously at specific channel frequencies individually.



4.4.7 TEST RESULTS

802.11a OFDM modulation

MODULATION TYPE	BPSK	TRANSFER RATE	6Mbps
INPUT POWER (SYSTEM)	120Vac, 60 Hz	ENVIRONMENTAL CONDITIONS	19deg.C, 65%RH, 976hPa
TESTED BY	Tony Chen		

CHANNEL	CHANNEL FREQUENCY (MHz)	PEAK POWER EXCURSION (dB)	PEAK to AVERAGE EXCURSION LIMIT (dB)	PASS/FAIL
1	5180	7.32	13	PASS
4	5240	8.21	13	PASS
5	5260	7.45	13	PASS
8	5320	7.24	13	PASS

CH1

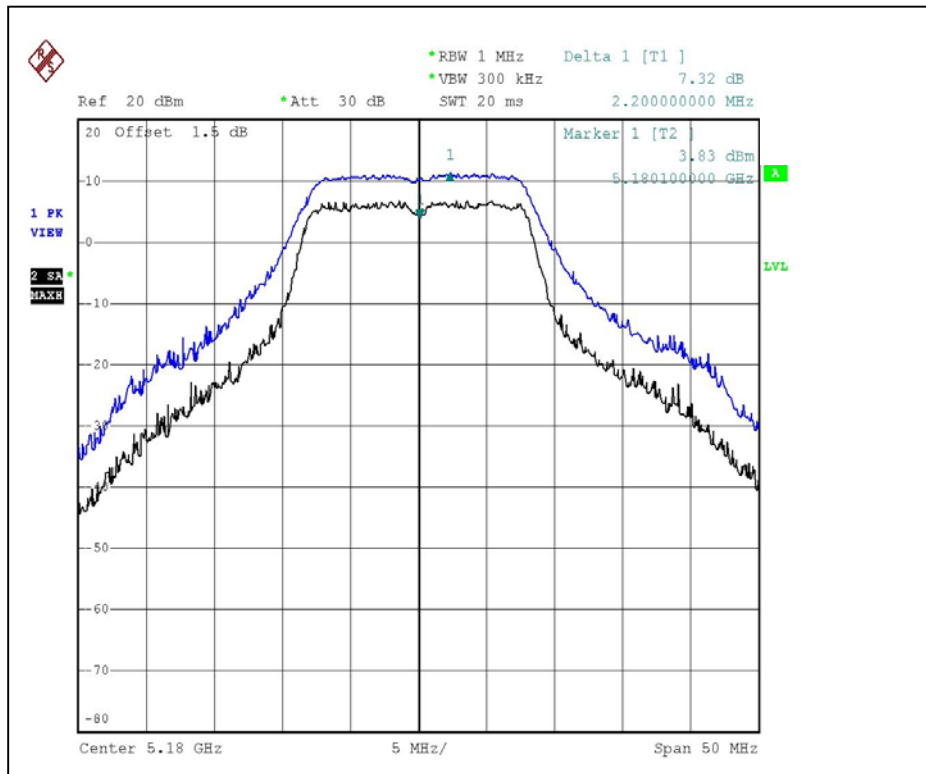

CH4

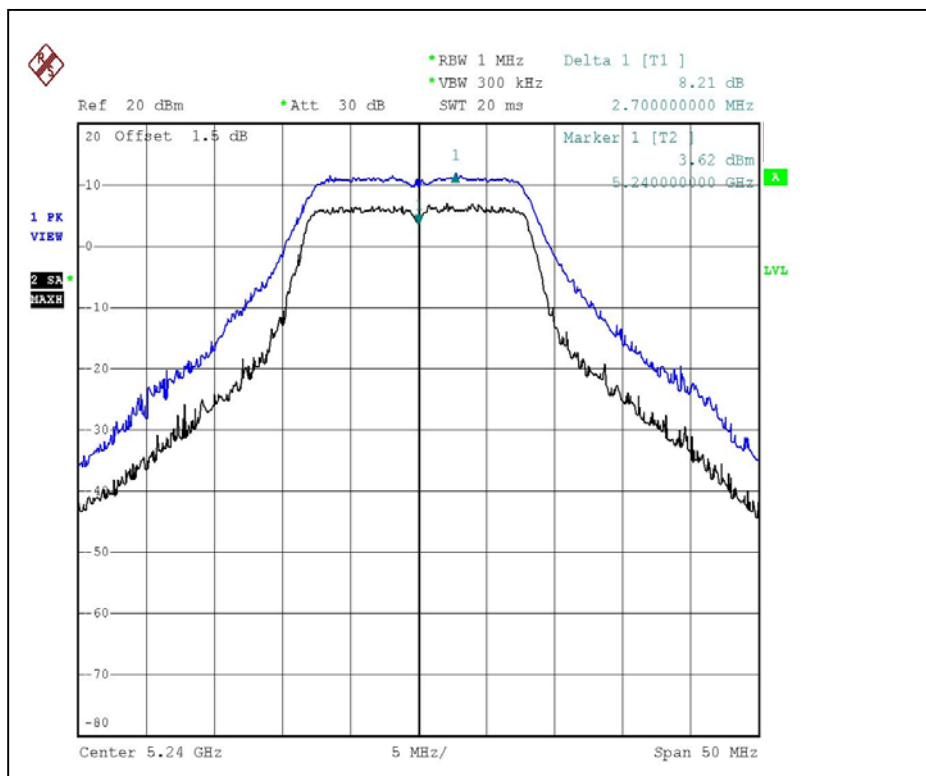

CH5

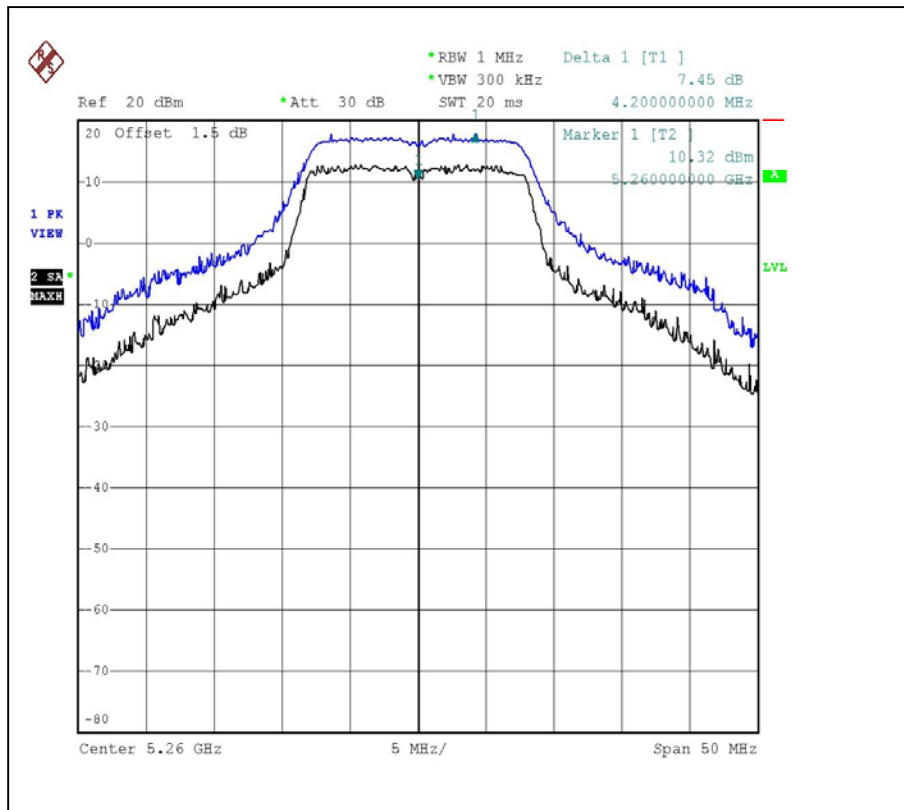

CH8

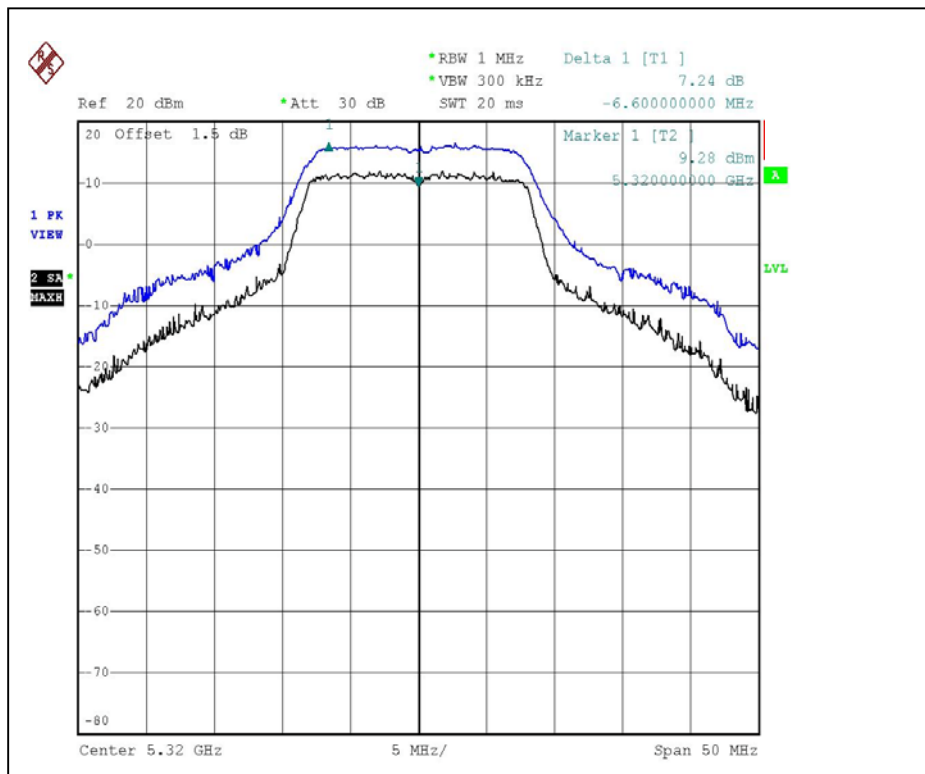



4.5 PEAK POWER SPECTRAL DENSITY MEASUREMENT

4.5.1 LIMITS OF PEAK POWER SPECTRAL DENSITY MEASUREMENT

Frequency Band	Limit
5.15 ~ 5.25GHz	4dBm
5.25 ~ 5.35GHz	11dBm
5.725 ~ 5.825GHz	17dBm

4.5.2 TEST INSTRUMENTS

Description & Manufacturer	Model No.	Serial No.	Calibrated Until
R&S SPECTRUM ANALYZER	FSP40	100036	Nov. 23, 2006

NOTE:

- 1.The measurement uncertainty is less than +/- 2.6dB, which is calculated as per the NAMAS document NIS81. This uncertainty represents an expanded uncertainty expressed at approximately the 95% confidence level using a coverage factor of k=2.
- 2.The calibration interval of the above test instruments is 12 months and the calibrations are traceable to NML/ROC and NIST/USA.

4.5.3 TEST PROCEDURES

1. The transmitter output was connected to the spectrum analyzer.
2. Set RBW=1MHz, VBW=3MHz. The PPSD is the highest level found across the emission in any 1MHz band.

4.5.4 DEVIATION FROM TEST STANDARD

No deviation

4.5.5 TEST SETUP

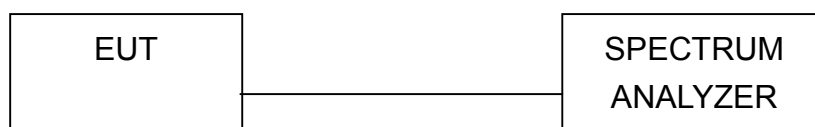

4.5.6 EUT OPERATING CONDITIONS

Same as 4.3.6



4.5.7 TEST RESULTS

802.11a OFDM modulation

MODULATION TYPE	BPSK	TRANSFER RATE	6Mbps
INPUT POWER (SYSTEM)	120Vac, 60 Hz	ENVIRONMENTAL CONDITIONS	19deg.C, 65%RH, 976hPa
TESTED BY	Tony Chen		

CHANNEL	CHANNEL FREQUENCY (MHz)	RF POWER LEVEL IN 1MHz BW (dBm)	MAXIMUM LIMIT (dBm)	PASS/FAIL
1	5180	1.16	4	PASS
4	5240	0.75	4	PASS
5	5260	7.27	11	PASS
8	5320	5.91	11	PASS

CH5

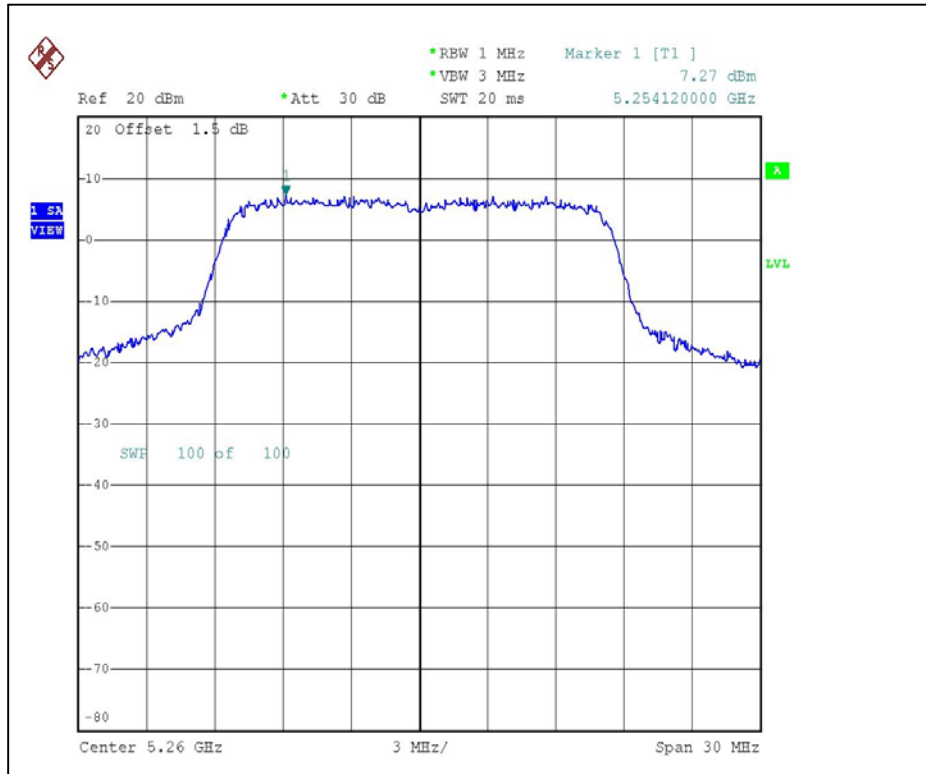

CH8

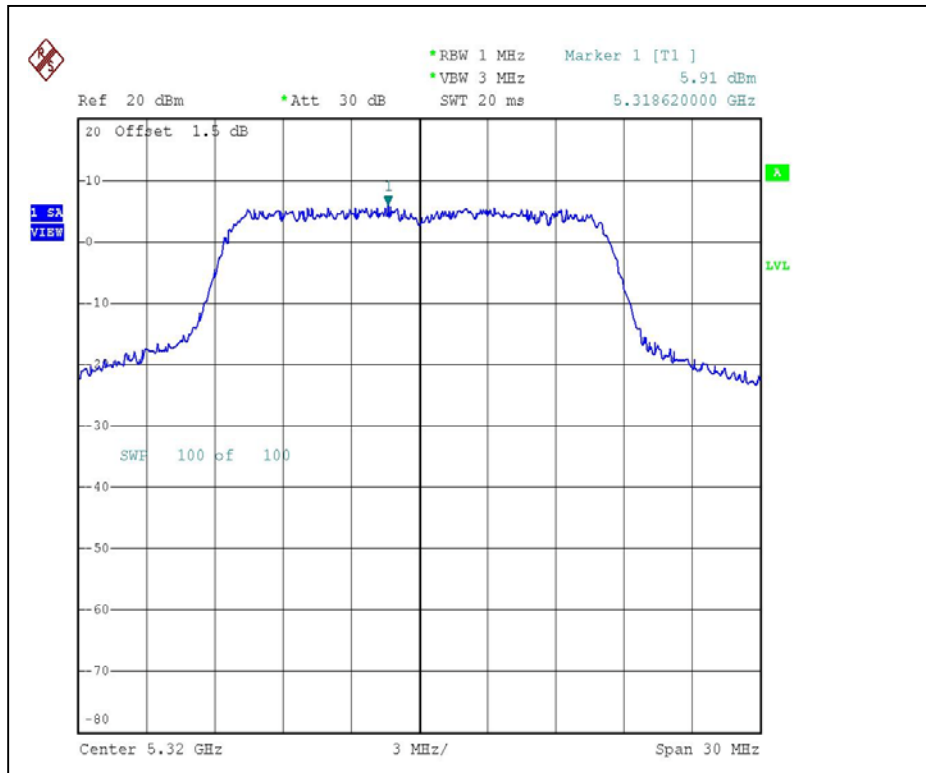



4.6 FREQUENCY STABILITY

4.6.1 LIMITS OF FREQUENCY STABILITY MEASUREMENT

The frequency tolerance of the carrier signal shall be maintained within +/- 0.02% of the operating frequency over a temperature variation of -30 degrees to 50 degrees C at normal supply voltage, and for a variation in the primary supply voltage from 85% to 115% of the rated supply voltage at a temperature of 20 degrees C.

4.6.2 TEST INSTRUMENTS

Description & Manufacturer	Model No.	Serial No.	Calibrated Until
R&S SPECTRUM ANALYZER	FSP40	100036	Nov. 23, 2006

NOTE:

- 1.The measurement uncertainty is less than +/- 2.6dB, which is calculated as per the NAMAS document NIS81. This uncertainty represents an expanded uncertainty expressed at approximately the 95% confidence level using a coverage factor of k=2.
- 2.The calibration interval of the above test instruments is 12 months and the calibrations are traceable to NML/ROC and NIST/USA.

4.6.3 TEST PROCEDURE

1. The EUT was placed inside the environmental test chamber and powered by nominal DC voltage.
2. Turn the EUT on and couple its output to a spectrum analyzer.
3. Turn the EUT off and set the chamber to the highest temperature specified.
4. Allow sufficient time (approximately 30 min) for the temperature of the chamber to stabilize, turn the EUT on and measure the operating frequency after 2, 5, and 10 minutes.
5. Repeat step 2 and 3 with the temperature chamber set to the lowest temperature.
6. The test chamber was allowed to stabilize at +20 degree C for a minimum of 30 minutes. The supply voltage was then adjusted on the EUT from 85% to 115% and the frequency record.

4.6.4 DEVIATION FROM TEST STANDARD

No deviation

4.6.5 TEST SETUP

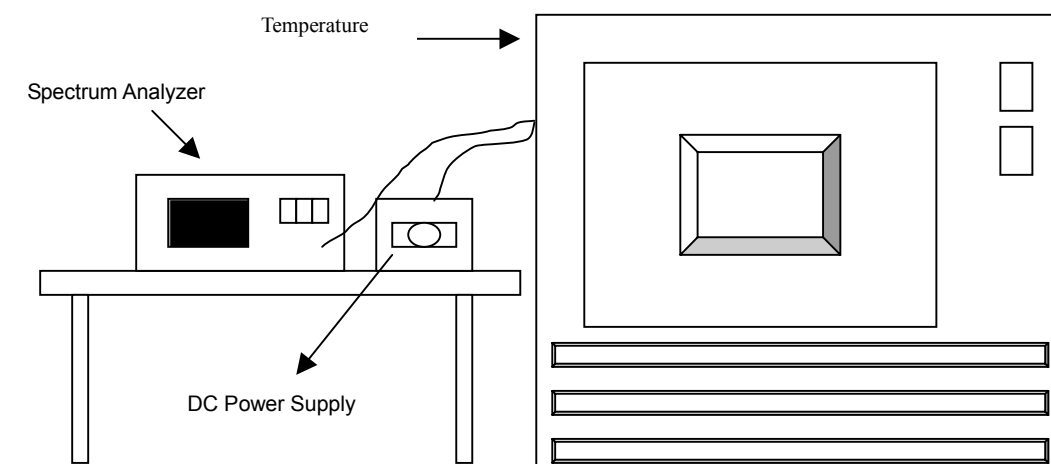

4.6.6 EUT OPERATING CONDITION

The software provided by client to enable the EUT under transmission condition continuously at specific channel frequencies individually.



4.6.7 TEST RESULTS

Operating frequency: 5320MHz				Limit : ± 0.02%			
Temp. (°C)	Power supply (VAC)	2 minute		5 minute		10 minute	
		(MHz)	(%)	(MHz)	(%)	(MHz)	(%)
50	126.5	5320.0364	0.000684	5320.0367	0.000690	5320.0368	0.000692
	110	5320.0364	0.000684	5320.0366	0.000688	5320.0368	0.000692
	93.5	5320.0366	0.000688	5320.0364	0.000684	5320.0368	0.000692
40	126.5	5319.9881	0.000224	5319.9976	0.000045	5319.9973	0.000051
	110	5319.9882	0.000222	5319.9976	0.000045	5319.9975	0.000047
	93.5	5319.9981	0.000036	5319.9979	0.000039	5319.9972	0.000053
30	126.5	5319.9922	0.000147	5319.9919	0.000152	5319.9917	0.000156
	110	5319.9922	0.000147	5319.9921	0.000148	5319.9918	0.000154
	93.5	5319.9922	0.000147	5319.9919	0.000152	5319.9916	0.000158
20	126.5	5320.0071	0.000133	5320.0068	0.000128	5320.0065	0.000122
	110	5320.0072	0.000135	5320.0072	0.000135	5320.0069	0.000130
	93.5	5320.0071	0.000133	5320.0068	0.000128	5320.0065	0.000122
10	126.5	5320.0124	0.000233	5320.0122	0.000229	5320.0119	0.000224
	110	5320.0124	0.000233	5320.0122	0.000229	5320.0121	0.000227
	93.5	5320.0124	0.000233	5320.0121	0.000227	5320.0118	0.000222
0	126.5	5320.023	0.000432	5320.0180	0.000338	5320.0180	0.000338
	110	5320.023	0.000432	5320.0210	0.000395	5320.0190	0.000357
	93.5	5320.021	0.000395	5320.0180	0.000338	5320.0180	0.000338
-10	126.5	5320.0306	0.000575	5320.0290	0.000545	5320.0270	0.000508
	110	5320.0304	0.000571	5320.0310	0.000583	5320.0290	0.000545
	93.5	5320.0304	0.000571	5320.0280	0.000526	5320.0270	0.000508
-20	126.5	5320.0300	0.000564	5320.0250	0.000470	5320.0210	0.000395
	110	5320.0300	0.000564	5320.0280	0.000526	5320.0240	0.000451
	93.5	5320.0300	0.000564	5320.0240	0.000451	5320.0220	0.000414
-30	126.5	5320.0116	0.000218	5320.0111	0.000209	5320.0108	0.000203
	110	5320.0116	0.000218	5320.0113	0.000212	5320.0111	0.000209
	93.5	5320.0116	0.000218	5320.0111	0.000209	5320.0108	0.000203

4.7 BAND EDGES MEASUREMENT

4.7.1 TEST INSTRUMENTS

Description & Manufacturer	Model No.	Serial No.	Calibrated Until
R&S SPECTRUM ANALYZER	FSP40	100036	Nov. 23, 2006

NOTE:

- 1.The measurement uncertainty is less than +/- 2.6dB, which is calculated as per the NAMAS document NIS81. This uncertainty represents an expanded uncertainty expressed at approximately the 95% confidence level using a coverage factor of k=2.
- 2.The calibration interval of the above test instruments is 12 months and the calibrations are traceable to NML/ROC and NIST/USA.

4.7.2 TEST PROCEDURE

The transmitter output was connected to the spectrum analyzer via a low lose cable. Set both RBW and VBW of spectrum analyzer to 1MHz with suitable frequency span including 100 MHz bandwidth from band edge. The band edges was measured and recorded.

4.7.3 EUT OPERATING CONDITION

The software provided by client to enable the EUT under transmission condition continuously at specific channel frequencies individually.

4.7.4 TEST RESULTS

For signals in the restricted bands above and below the 5.15 to 5.35GHz allocated band a measurement was made of the amplitude of the spurious emissions with respect to the intentional signals. The relative amplitude, in dBc, was applied to the average and peak field strength of the intentional signal made on the OATS to calculate the field strength of the unintentional signals.

The spectrum plots (Peak RBW=VBW=1MHz; Average RBW=1MHz, VBW=10Hz) are attached on the following pages.

802.11a OFDM modulation

NOTE (Peak):

The band edge emission plot on the following first page shows 53.01dBc between carrier maximum power and local maximum emission in restrict band. The emission of carrier strength list in the test result of channel 1 is 106.5dBuV/m (Peak), so the maximum field strength in restrict band is $106.5-53.01=53.49$ dBuV/m which is under 74dBuV/m limit.

The band edge emission plot on the following first page shows 39.31dBc between carrier maximum power and local maximum emission in restrict band. The emission of carrier strength list in the test result of channel 8 is 110.9dBuV/m (Peak), so the maximum field strength in restrict band is $110.9-39.31=71.59$ dBuV/m which is under 74dBuV/m limit.

NOTE (Average):

The band edge emission plot on the following second page shows 55.02dBc between carrier maximum power and local maximum emission in restrict band. The emission of carrier strength list in the test result of channel 1 is 98.2dBuV/m (Average), so the maximum field strength in restrict band is $98.2-55.02=43.18$ dBuV/m which is under 54dBuV/m limit.

The band edge emission plot on the following second page shows 48.77dBc between carrier maximum power and local maximum emission in restrict band. The emission of carrier strength list in the test result of channel 8 is 101.9dBuV/m (Average), so the maximum field strength in restrict band is $101.9-48.77=53.13$ dBuV/m which is under 54dBuV/m limit.

802.11a OFDM modulation

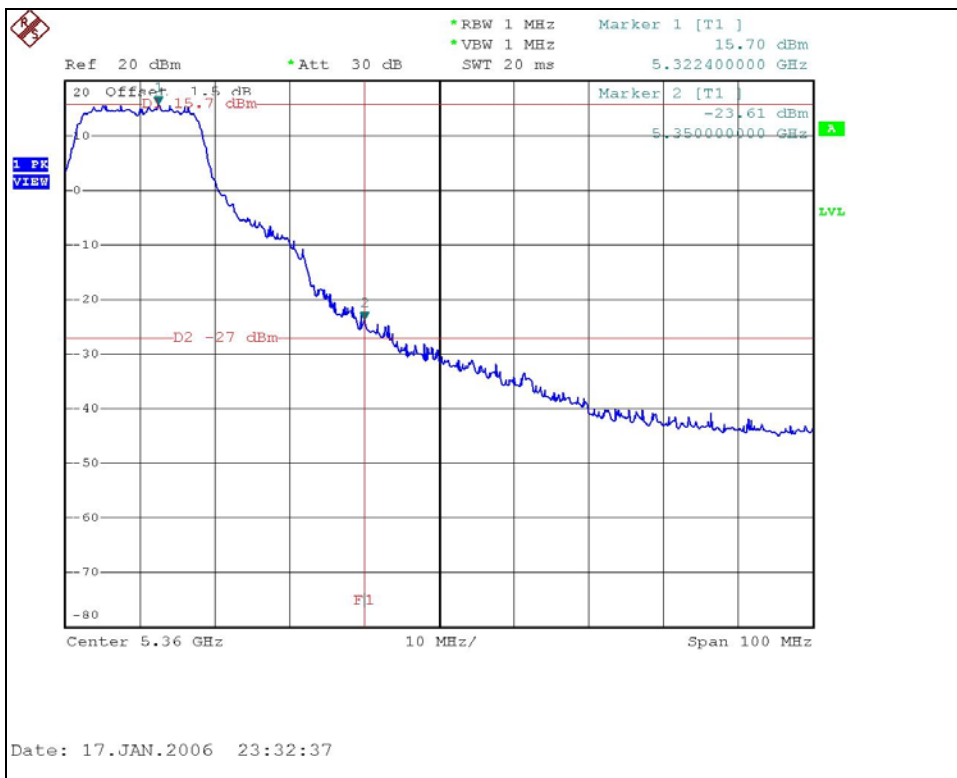
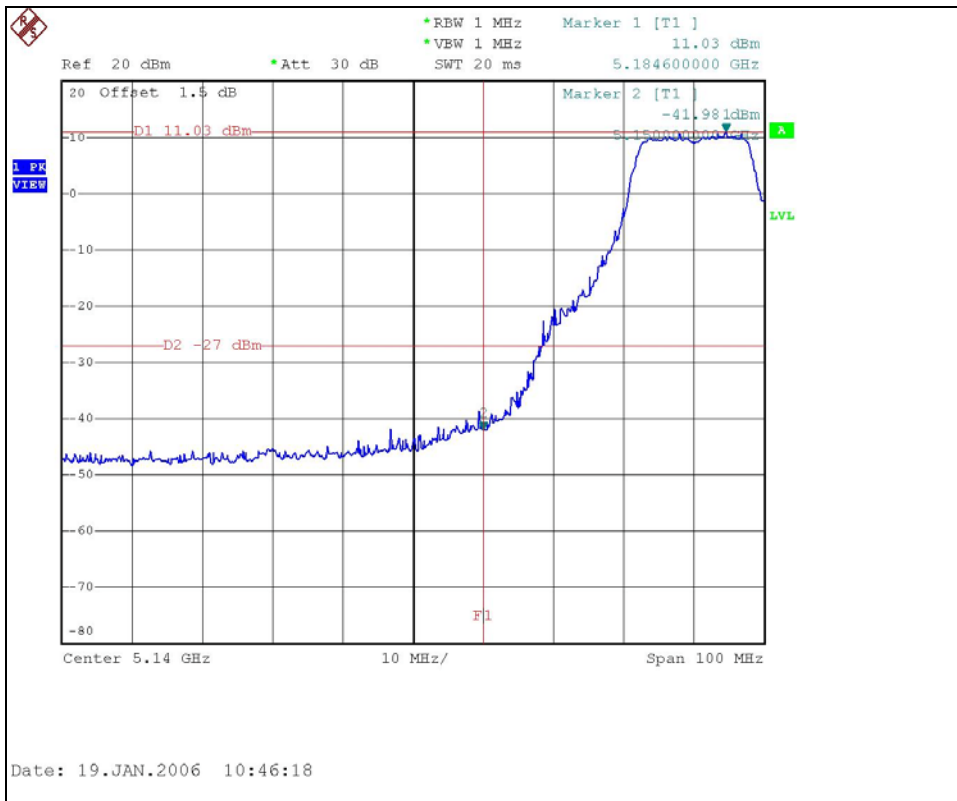

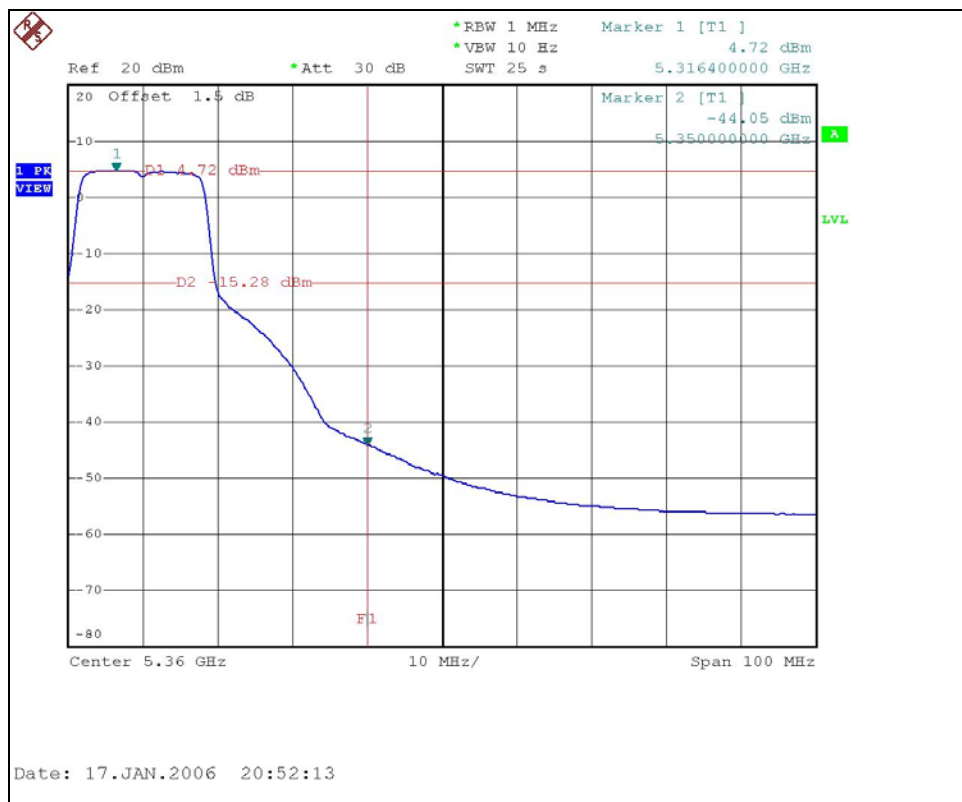
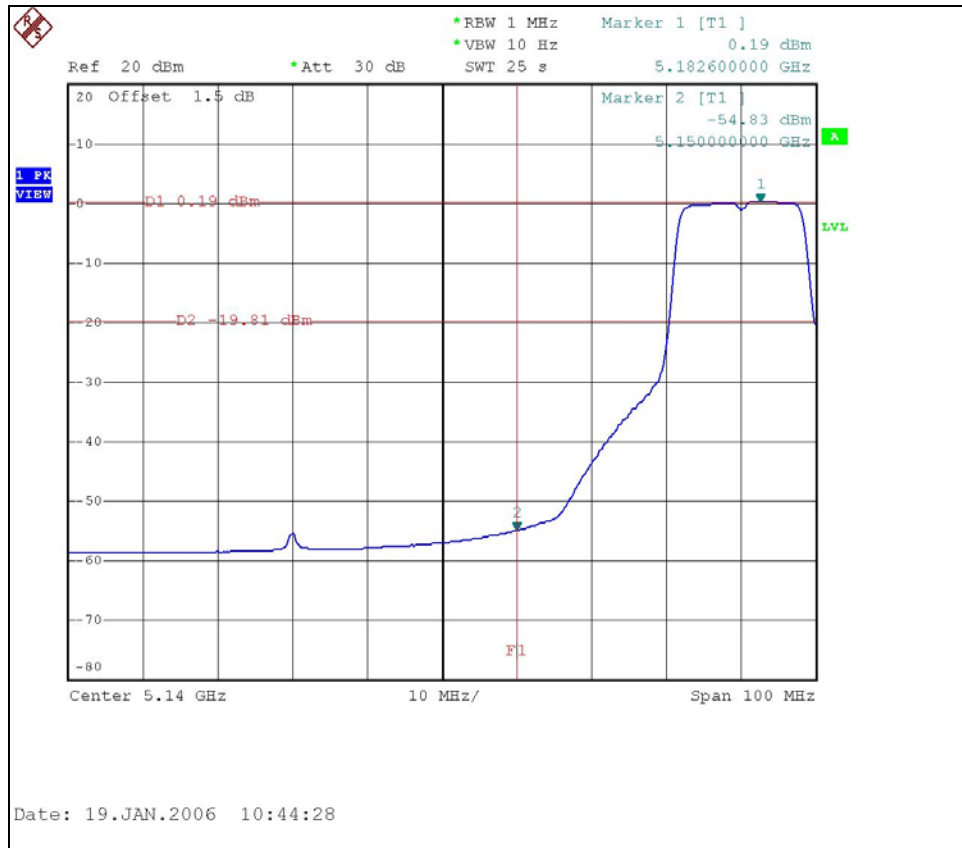

CH 1

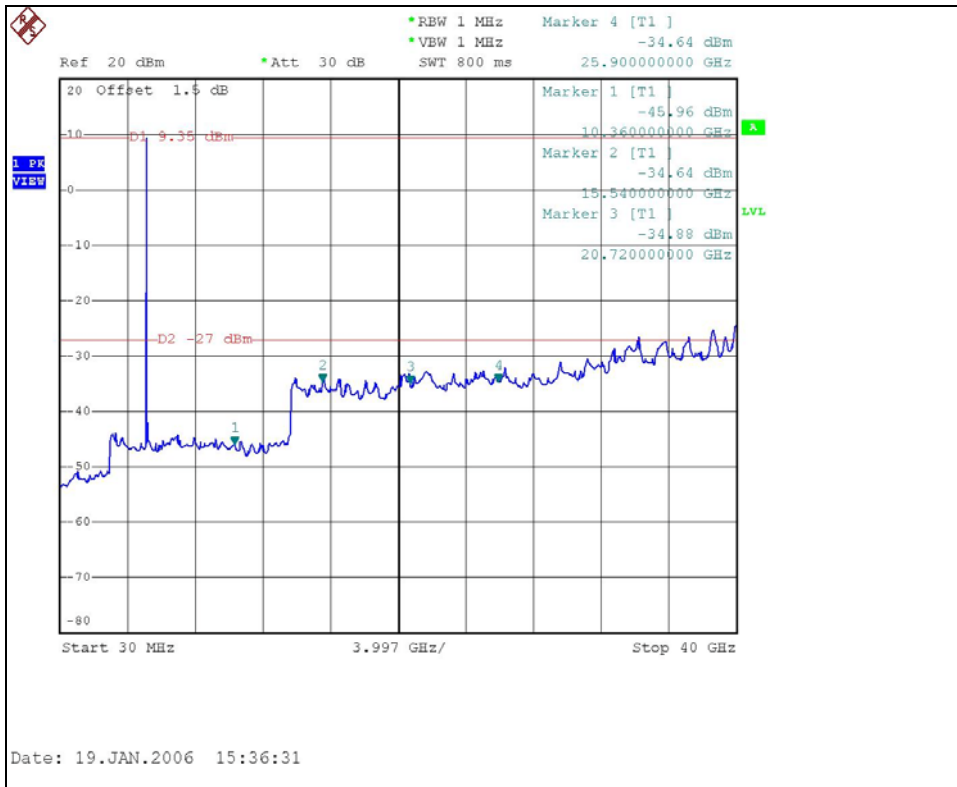

CH 8

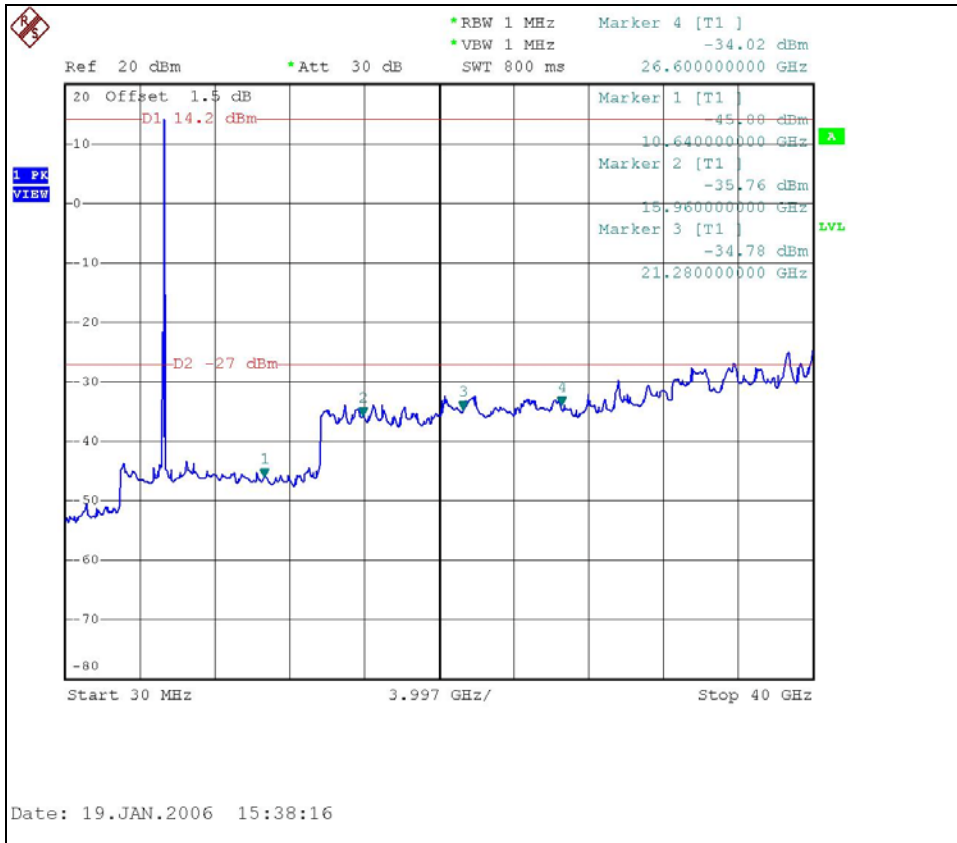



4.8 ANTENNA REQUIREMENT

4.8.1 STANDARD APPLICABLE

For intentional device, according to FCC 47 CFR Section 15.203, an intentional radiator shall be designed to ensure that no antenna other than that furnished by the responsible party shall be used with the device.

And according to FCC 47 CFR Section 15.407(a), if transmitting antennas of directional gain greater than 6dBi are used, the power shall be reduced by the amount in dB that the directional gain of the antenna exceeds 6dBi.

4.8.2 ANTENNA CONNECTED CONSTRUCTION

The antenna used in this product is PCB antenna with HRS connector. The maximum Gain of the antenna is 2.05dBi.

5. PHOTOGRAPHS OF THE TEST CONFIGURATION

CONDUCTED EMISSION TEST





RADIATED EMISSION TEST







6. INFORMATION ON THE TESTING LABORATORIES

We, ADT Corp., were founded in 1988 to provide our best service in EMC, Radio, Telecom and Safety consultation. Our laboratories are accredited and approved by the following approval agencies according to ISO/IEC 17025:

USA	FCC, UL, A2LA
Germany	TUV Rheinland
Japan	VCCI
Norway	NEMKO
Canada	INDUSTRY CANADA , CSA
R.O.C.	CNLA, BSMI, DGT
Netherlands	Telefication
Singapore	PSB , GOST-ASIA(MOU)
Russia	CERTIS(MOU)

Copies of accreditation certificates of our laboratories obtained from approval agencies can be downloaded from our web site:

www.adt.com.tw/index.5/phtml. If you have any comments, please feel free to contact us at the following:

Linko EMC/RF Lab:

Tel: 886-2-26052180

Fax: 886-2-26052943

Hsin Chu EMC/RF Lab:

Tel: 886-3-5935343

Fax: 886-3-5935342

Hwa Ya EMC/RF/Safety Telecom Lab:

Tel: 886-3-3183232

Fax: 886-3-3185050

Web Site: www.adt.com.tw

The address and road map of all our labs can be found in our web site also



APPENDIX-A

MODIFICATIONS RECORDERS FOR ENGINEERING CHANGES TO THE EUT BY THE LAB

No any modifications are made to the EUT by the lab during the test.