



**FCC CFR47 PART 15 SUBPART C
CERTIFICATION
TEST REPORT**

FOR

802.11 b/g MINI PCI CARD

MODEL NUMBER: J07H069.02

FCC ID: MCLJ07H06904

REPORT NUMBER: 03U1761-1

ISSUE DATE: FEBRUARY 21, 2003

Prepared for
**AMBIT MICROSYSTEMS, INC.
5F-1, 5 HSIN-AN ROAD, HSINCHU
SCIENCE-BASED INDUSTRIAL PARK, TAIWAN, R.O.C.**

Prepared by
**COMPLIANCE CERTIFICATION SERVICES
561F MONTEREY ROAD,
MORGAN HILL, CA 95037, USA
TEL: (408) 463-0885
FAX: (408) 463-0888**

TABLE OF CONTENTS

1. TEST RESULT CERTIFICATION.....	3
2. EUT DESCRIPTION.....	4
3. TEST METHODOLOGY.....	5
4. FACILITIES AND ACCREDITATION.....	5
4.1. <i>FACILITIES AND EQUIPMENT.....</i>	<i>5</i>
4.2. <i>TABLE OF ACCREDITATIONS AND LISTINGS.....</i>	<i>6</i>
5. CALIBRATION AND UNCERTAINTY.....	7
5.1. <i>MEASURING INSTRUMENT CALIBRATION.....</i>	<i>7</i>
5.2. <i>MEASUREMENT UNCERTAINTY.....</i>	<i>7</i>
5.3. <i>TEST AND MEASUREMENT EQUIPMENT.....</i>	<i>8</i>
6. SETUP OF EQUIPMENT UNDER TEST.....	9
7. APPLICABLE RULES.....	13
8. TEST SETUP, PROCEDURE AND RESULT.....	16
8.1. <i>6 dB BANDWIDTH.....</i>	<i>16</i>
8.2. <i>PEAK POWER.....</i>	<i>24</i>
8.3. <i>AVERAGE POWER.....</i>	<i>25</i>
8.4. <i>PEAK POWER SPECTRAL DENSITY.....</i>	<i>26</i>
8.5. <i>MAXIMUM PERMISSIBLE EXPOSURE.....</i>	<i>34</i>
8.6. <i>SPURIOUS EMISSIONS.....</i>	<i>36</i>
8.7. <i>RADIATED EMISSIONS.....</i>	<i>58</i>
8.8. <i>POWERLINE CONDUCTED EMISSIONS.....</i>	<i>83</i>
8.9. <i>SETUP PHOTOS.....</i>	<i>86</i>

1. TEST RESULT CERTIFICATION

COMPANY NAME: AMBIT MICROSYSTEMS
5F-1, 5 HSIN-AN ROAD, HSINCU
SCIENCE BASED INDUSTRIAL PARK, TAIWAN, R.O.C

EUT DESCRIPTION: 802.11 B/G MINI PCI CARD

MODEL NAME: J07H069.02

DATE TESTED: DECEMBER 20, 2002 – FEBRUARY 21, 2003

APPLICABLE STANDARDS	
STANDARD	TEST RESULTS
FCC PART 15 SUBPART C	NO NON-COMPLIANCE NOTED

Compliance Certification Services, Inc. tested the above equipment in accordance with the requirements set forth in the above standards. The test results show that the equipment tested is capable of demonstrating compliance with the requirements as documented in this report.

Note: This document reports conditions under which testing was conducted and results of tests performed. This document may not be altered or revised in any way unless done so by Compliance Certification Services and all revisions are duly noted in the revisions section. Any alteration of this document not carried out by Compliance Certification Services will constitute fraud and shall nullify the document.

Approved & Released For CCS By:

Tested By:



MIKE HECKROTTE
CHIEF ENGINEER
COMPLIANCE CERTIFICATION SERVICES

NEELESH RAJ
EMC ENGINEER
COMPLIANCE CERTIFICATION SERVICES

2. EUT DESCRIPTION

The J07H069.04 card is an 802.11b/g Mini-PCI module. The module is compatible with the IEEE 802.11g draft standard, and meets the mechanical specifications of the Type IIIA Mini-PCI form factor. The operational frequency range is:

2412 to 2462 MHz

It is based upon an Atheros Communications AR5001 three-chipset reference design. The three chips include the AR5111 integrated 5GHz CMOS radio transceiver, the AR2111 5GHz/2.4GHz integrated up/down-converter, and the AR5212 MAC/baseband processor.

The rated conducted output power of the transmitter when operating in 802.11b CCK mode is 20.64dbm. The rated conducted output power of the transmitter when operating in 802.11g OFDM mode is 21.92dbm. The J07H069.04 Mini-PCI card was tested for modular approval with stamped metal, PIFA antennas.

Peak antenna gain is 4.96 dBi.

3. TEST METHODOLOGY

The tests documented in this report were performed in accordance with ANSI C63.4 and FCC CFR 47 2.1046, 2.1047, 2.1049, 2.1051, 2.1053, 2.1055, 2.1057, and 15.407.







4. FACILITIES AND ACCREDITATION

4.1. FACILITIES AND EQUIPMENT

The open area test sites and conducted measurement facilities used to collect the radiated data are located at 561F Monterey Road, Morgan Hill, California, USA. The sites are constructed in conformance with the requirements of ANSI C63.7, ANSI C63.4 and CISPR Publication 22.

All receiving equipment conforms to CISPR Publication 16-1, "Radio Interference Measuring Apparatus and Measurement Methods."

4.2. TABLE OF ACCREDITATIONS AND LISTINGS

Country	Agency	Scope of Accreditation	Logo
USA	FCC	3/10 meter Open Area Test Sites to perform FCC Part 15/18 measurements	 1300
Japan	VCCI	CISPR 22 Two OATS and one conducted Site	 R-1014, R-619, C-640
Norway	NEMKO	EN50081-1, EN50081-2, EN50082-1, EN50082-2, IEC61000-6-1, IEC61000-6-2, EN50083-2, EN50091-2, EN50130-4, EN55011, EN55013, EN55014-1, EN55104, EN55015, EN61547, EN55022, EN55024, EN61000-3-2, EN61000-3-3, EN60945, EN61326-1	 ELA 117
Norway	NEMKO	EN60601-1-2 and IEC 60601-1-2, the Collateral Standards for Electro-Medical Products. MDD, 93/42/EEC, AIMD 90/385/EEC	 ELA-171
Taiwan	BSMI	CNS 13438	 SL2-IN-E-1012
Canada	Industry Canada	RSS210 Low Power Transmitter and Receiver	 IC2324 A,B,C, and F

5. CALIBRATION AND UNCERTAINTY

5.1. MEASURING INSTRUMENT CALIBRATION

The measurement instruments utilized to perform the tests documented in this report have been calibrated in accordance with the manufacturer's recommendations, and are traceable to national standards.

5.2. MEASUREMENT UNCERTAINTY

Where relevant, the following measurement uncertainty levels have been estimated for tests performed on the apparatus:

Radiated Emission	
30MHz – 200 MHz	+/- 3.3dB
200MHz – 1000MHz	+4.5/-2.9dB
1000MHz – 2000MHz	+4.6/-2.2dB
Power Line Conducted Emission	
150kHz – 30MHz	+/-2.9

Any results falling within the above values are deemed to be marginal.

5.3. TEST AND MEASUREMENT EQUIPMENT

The following test and measurement equipment was utilized for the tests documented in this report:

TEST AND MEASUREMENT EQUIPMENT LIST				
Name of Equipment	Manufacturer	Model	Serial Number	Calibration Due Date
Spectrum Analyzer	HP	8566B	3014A06685	6/1/03
Spectrum Display	HP	85662A	2152A03066	6/1/03
Quasi-Peak Detector	HP	85650A	3145A01654	6/1/03
Preamplifier	HP	8447D	2944A06833	8/22/03
Log Periodic Antenna	EMCO	3146	9107-3163	3/30/03
Biconical Antenna	Eaton	94455-1	1197	3/30/03
Spectrum Analyzer	HP	8564E	3943A01643	7/22/03
Spectrum Analyzer	HP	8593EM	3710A00205	6/11/03
Preamplifier (1 - 26.5GHz)	HP	8449B	3008A00369	6/30/03
Preamplifier (1 - 26.5GHz)	Miteq	NSP10023988	646456	4/26/03
Horn Antenna (1 - 18GHz)	EMCO	3115	6717	2/4/04
Horn Antenna (1 - 18GHz)	EMCO	3115	6739	2/4/04
Horn Antenna (18 - 26.5GHz)	ARA	MWH 1826/B	1013	11/7/03
High Pass Filter (4.57GHz)	FSY Microwave	FM-4570-9SS	003	N.C.R.
High Pass Filter (7.600GHz)	FSY Microwave	FM-7600	N/A	N.C.R.
Harmonic Mixer	HP	11970A	3008A04190	10/14/05
Spectrum Analyzer	HP	E4404B	ID 963805	3/25/03
PSA Series Spectrum Analyzer	Aglient	E4446A	US42070220	1/13/04
PSA Series Spectrum Analyzer	Aglient	E4440A	US42221737	9/24/03

6. SETUP OF EQUIPMENT UNDER TEST

SETUP INFORMATION FOR TRANSMITTER TESTS

SUPPORT EQUIPMENT

PERIPHERAL SUPPORT EQUIPMENT LIST				
Device Type	Manufacturer	Model	Serial Number	FCC ID
Laptop	TOSHIBA	51212942PU	N/A	N/A
AC Adapter	TOSHIBA	PA3048U-1ACA	002A04650556	N/A

I/O CABLES

Cable No.	Port	# of Identical Ports	Connector Type	Cable Type	Cable Length	Remarks
1	PWR	1	¼ DC PWR	Unshielded	1.86 m	

TEST SETUP

The EUT was operated from the PCMCIA slot of the laptop via a PCMCIA extender. The antennas are external.

SETUP DIAGRAM FOR TRANSMITTER TESTS

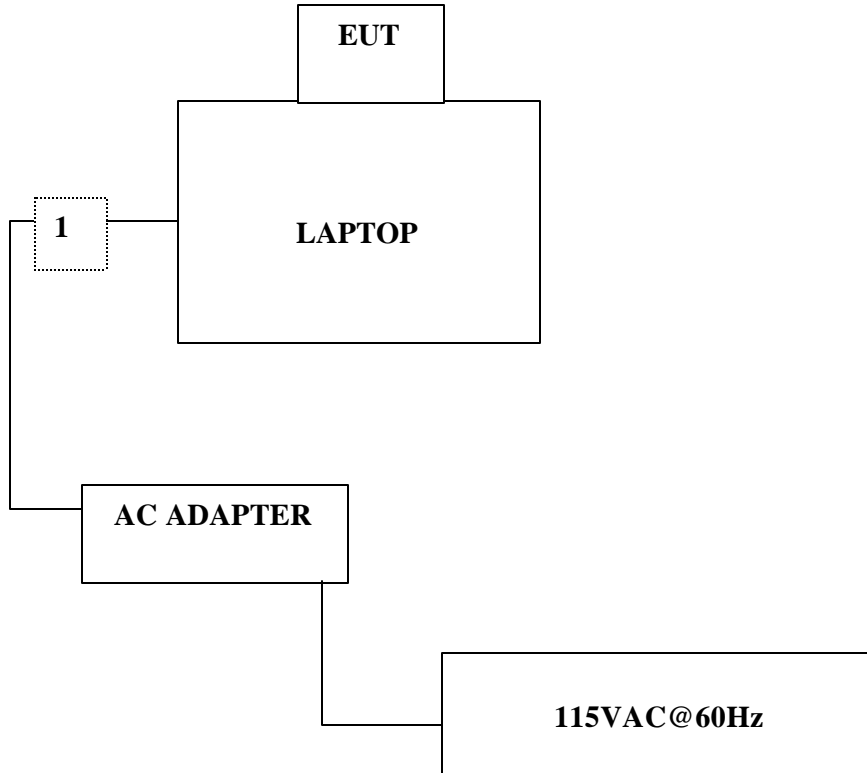

SETUP INFORMATION FOR DIGITAL DEVICE TESTS

SUPPORT EQUIPMENT

PERIPHERAL SUPPORT EQUIPMENT LIST				
Device Type	Manufacturer	Model	Serial Number	FCC ID
LAPTOP	GENERIC H2	MS2111	8141T01S0315100014	N/A
AC ADAPTER	LITE ON ELEC.	PA-1900-05	230001790E	N/A
MODEM	ACEEX	1414	9013538	IFAXDM1414
PRINTER	HP	2225C	2541S41679	BS46XU2225C

I/O CABLES

Cable No.	Port	# of Identical Ports	Connector Type	Cable Type	Cable Length	Remarks
1	PARALLEL	1	DB-25	SHIELDED	1.86M	N/A
2	SERIAL	1	DB-9	SHIELDED	1.86M	N/A
3	PWR	1	¼" DC PWR	UNSHIELDED	1.86M	N/A
4	PWR	1	AC PWR	UNSHIELDED	1.86M	N/A
5	PWR	1	AC PWR	UNSHIELDED	1.86M	N/A
6	PWR	1	AC PWR	UNSHIELDED	1.86M	N/A

TEST SETUP

The EUT was operated from the PCMCIA slot of the laptop via a PCMCIA extender. The antennas are external.

SETUP DIAGRAM FOR DIGITAL DEVICE TESTS

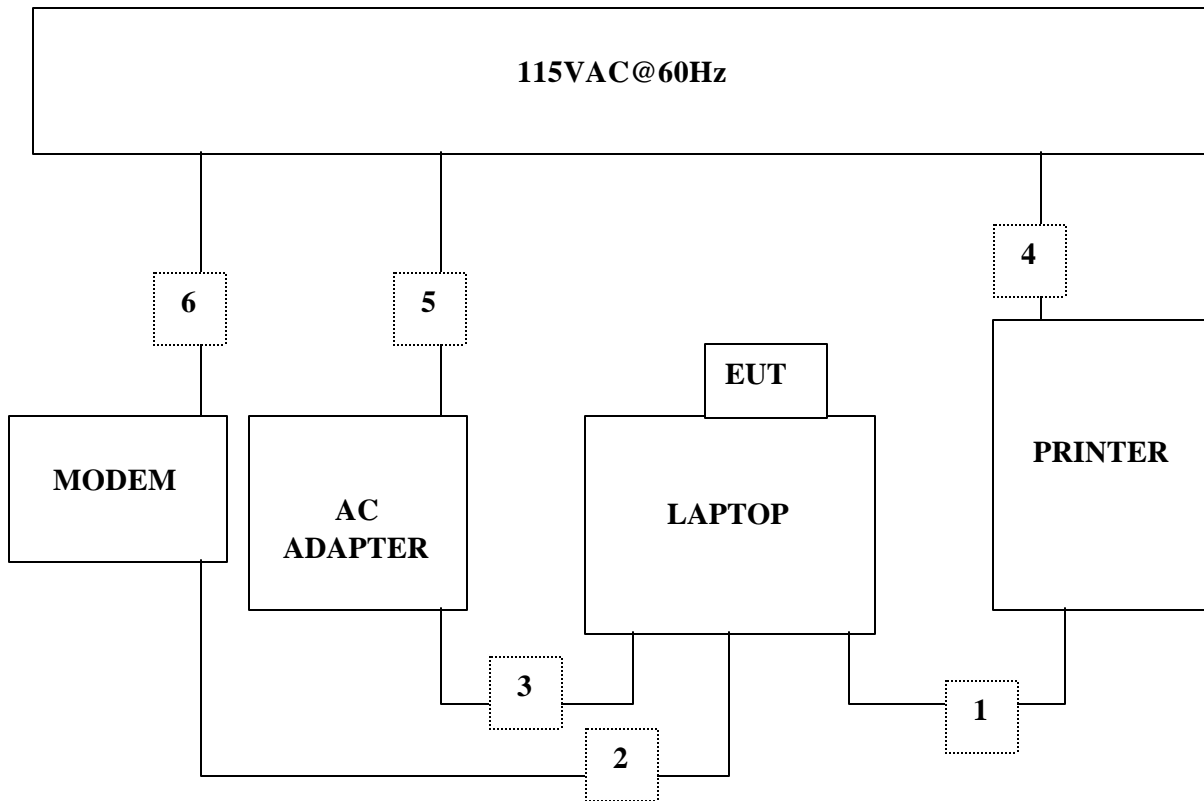

7. APPLICABLE RULES

§15.247 (a)- BANDWIDTH

(2) For direct sequence systems, the minimum 6 dB bandwidth shall be at least 500 kHz.

§15.247 (b)- POWER OUTPUT

The maximum peak output power of the intentional radiator shall not exceed the following:

(3) For systems using digital modulation in the 902-928 MHz, 2400-2483.5 MHz , and 5725-5850 MHz bands: 1 watt.

(4) Except as shown in paragraphs (b)(3) (i), (ii) and (iii) of this section, if transmitting antennas of directional gain greater than 6 dBi are used the peak output power from the intentional radiator shall be reduced below the stated values in paragraphs (b)(1) or (b)(2) of this section, as appropriate, by the amount in dB that the directional gain of the antenna exceeds 6 dBi.

§15.247 (b)- RADIO FREQUENCY EXPOSURE

(5) Systems operating under the provisions of this section shall be operated in a manner that ensures that the public is not exposed to radio frequency energy levels in excess of the Commission's guidelines. See §1.1307(b)(1) of this chapter.

§15.247 (c)- SPURIOUS EMISSIONS

In any 100 kHz bandwidth outside the frequency band in which the spread spectrum intentional radiator is operating, the radio frequency power that is produced by the intentional radiator shall be at least 20 dB below that in the 100 kHz bandwidth within the band that contains the highest level of the desired power, based on either an RF conducted or a radiated measurement. Attenuation below the general limits specified in §15.209(a) is not required. In addition, radiated emissions which fall in the restricted bands, as defined in §15.205(a), must also comply with the radiated emission limits specified in §15.209(a) (see §15.205(c)).

§15.247 (d)- PEAK POWER SPECTRAL DENSITY

(d) For direct sequence systems, the peak power spectral density conducted from the intentional radiator to the antenna shall not be greater than 8 dBm in any 3 kHz band during any time interval of continuous transmission.

(f) The direct sequence operating of the hybrid system, with the frequency hopping operation turned off, shall comply with the power density requirements of paragraph (d) of this section.

§15.205- RESTRICTED BANDS OF OPERATIONS

(a) Except as shown in paragraph (d) of this section, only spurious emissions are permitted in any of the frequency bands listed below:

MHz	MHz	MHz	GHz
0.090 - 0.110	16.42 - 16.423	399.9 - 410	4.5 - 5.15
¹ 0.495 - 0.505	16.69475 - 16.69525	608 - 614	5.35 - 5.46
2.1735 - 2.1905	16.80425 - 16.80475	960 - 1240	7.25 - 7.75
4.125 - 4.128	25.5 - 25.67	1300 - 1427	8.025 - 8.5
4.17725 - 4.17775	37.5 - 38.25	1435 - 1626.5	9.0 - 9.2
4.20725 - 4.20775	73 - 74.6	1645.5 - 1646.5	9.3 - 9.5
6.215 - 6.218	74.8 - 75.2	1660 - 1710	10.6 - 12.7
6.26775 - 6.26825	108 - 121.94	1718.8 - 1722.2	13.25 - 13.4
6.31175 - 6.31225	123 - 138	2200 - 2300	14.47 - 14.5
8.291 - 8.294	149.9 - 150.05	2310 - 2390	15.35 - 16.2
8.362 - 8.366	156.52475 - 156.52525	2483.5 - 2500	17.7 - 21.4
8.37625 - 8.38675	156.7 - 156.9	2655 - 2900	22.01 - 23.12
8.41425 - 8.41475	162.0125 - 167.17	3260 - 3267	23.6 - 24.0
12.29 - 12.293	167.72 - 173.2	3332 - 3339	31.2 - 31.8
12.51975 - 12.52025	240 - 285	3345.8 - 3358	36.43 - 36.5
12.57675 - 12.57725	322 - 335.4	3600 - 4400	(²)
13.36 - 13.41			

¹ Until February 1, 1999, this restricted band shall be 0.490-0.510 MHz.

² Above 38.6

(b) Except as provided in paragraphs (d) and (e), the field strength of emissions appearing within these frequency bands shall not exceed the limits shown in Section 15.209. At frequencies equal to or less than 1000 MHz, compliance with the limits in Section 15.209 shall be demonstrated using measurement instrumentation employing a CISPR quasi-peak detector. Above 1000 MHz, compliance with the emission limits in Section 15.209 shall be demonstrated based on the average value of the measured emissions. The provisions in Section 15.35 apply to these measurements.

§15.207- CONDUCTED LIMITS

(a) Except as shown in paragraphs (b) and (c) of this section, for an intentional radiator that is designed to be connected to the public utility (AC) power line, the radio frequency voltage that is conducted back onto the AC power line on any frequency or frequencies within the band 150 kHz to 30 MHz shall not exceed the limits in the following table, as measured using a 50 μH/50 ohms line impedance stabilization network (LISN). Compliance with the provisions of this paragraph shall be based on the measurement of the radio frequency voltage between each power line and ground at the power terminal.

The lower limit applies at the boundary between the frequency ranges.

Frequency of Emission (MHz)	Conducted Limit (dBuV)	
	Quasi-peak	Average
0.15-0.5	66 to 56*	56 to 46*
0.5-5	56	46
5-30	60	50

* Decreases with the logarithm of the frequency.

§15.209- RADIATED EMISSION LIMITS

(a) Except as provided elsewhere in this Subpart, the emissions from an intentional radiator shall not exceed the field strength levels specified in the following table:

Frequency (MHz)	Field Strength (microvolts/meter)	Measurement Distance (meters)
30 - 88	100 **	3
88 - 216	150 **	3
216 - 960	200 **	3
Above 960	500	3

** Except as provided in paragraph (g), fundamental emissions from intentional radiators operating under this Section shall not be located in the frequency bands 54-72 MHz, 76-88 MHz, 174-216 MHz or 470-806 MHz. However, operation within these frequency bands is permitted under other sections of this Part, e.g., Sections 15.231 and 15.241.

(b) In the emission table above, the tighter limit applies at the band edges.

8. TEST SETUP, PROCEDURE AND RESULT

8.1. 6 dB BANDWIDTH

TEST SETUP

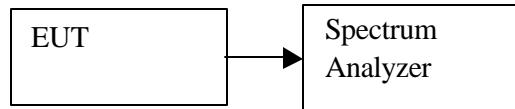

TEST PROCEDURE

The transmitter output is connected to the spectrum analyzer. The RBW is set to 100 kHz and the VBW is set to 100 kHz. The sweep time is coupled.

RESULTS

No non-compliance noted:

2.4 GHz Band (b)

Channel	Frequency (MHz)	B (kHz)	Limit (kHz)	Margin (kHz)
Low	2412	12000	500	11500
Middle	2437	12050	500	11550
High	2462	12050	500	11550

2.4 GHz Normal Band (g)

Channel	Frequency (MHz)	B (kHz)	Limit (kHz)	Margin (kHz)
Low	2412	16600	500	16100
Middle	2437	16400	500	15900
High	2462	16600	500	16100

2.4 GHz Turbo Band (g)

Channel	Frequency (MHz)	B (kHz)	Limit (kHz)	Margin (kHz)
Middle	2437	36250	500	35750

6 DB BANDWIDTH (2.4 GHZ b BAND)

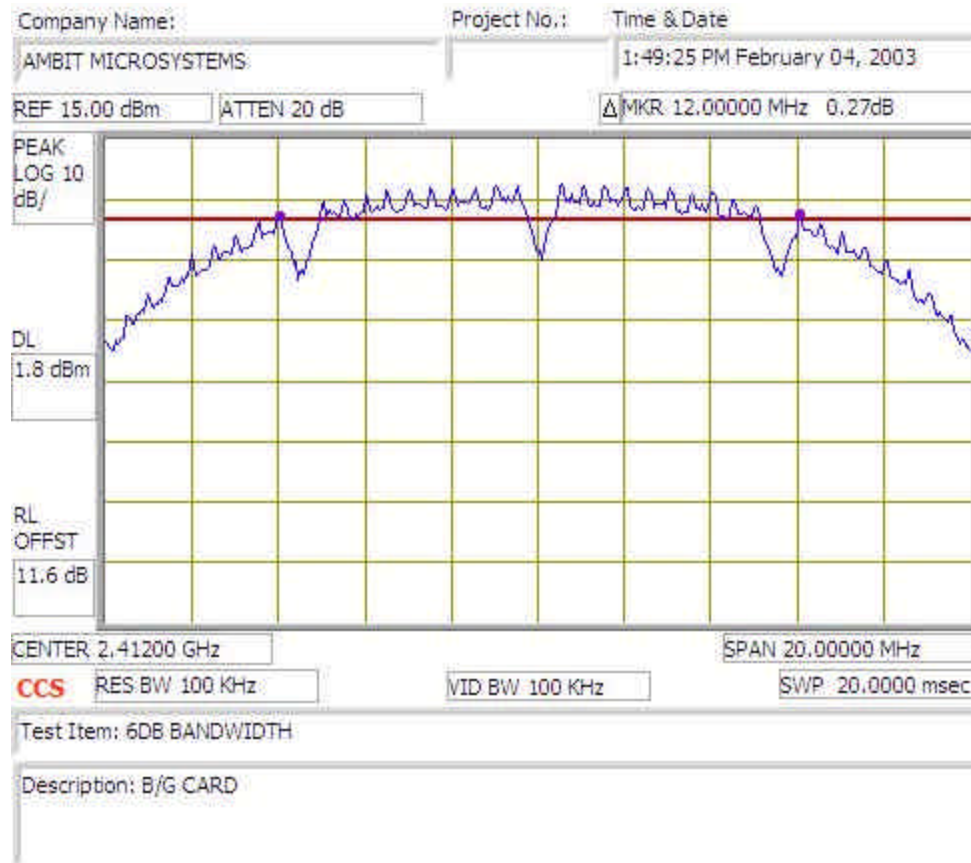

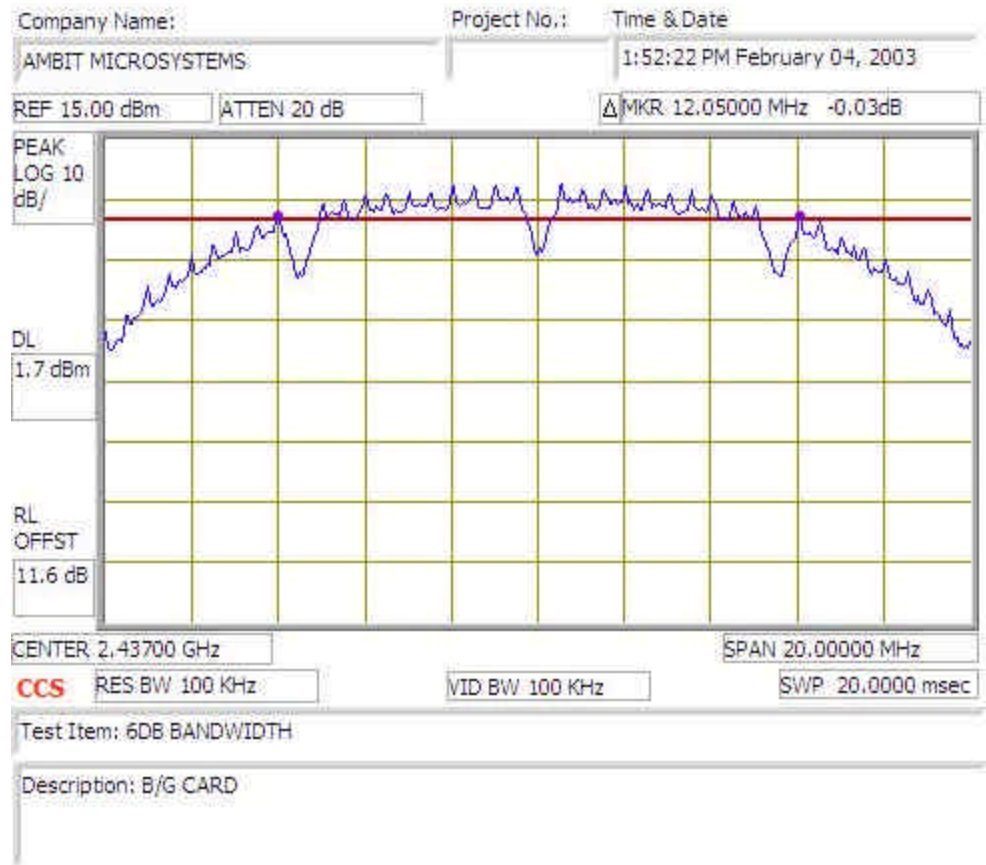

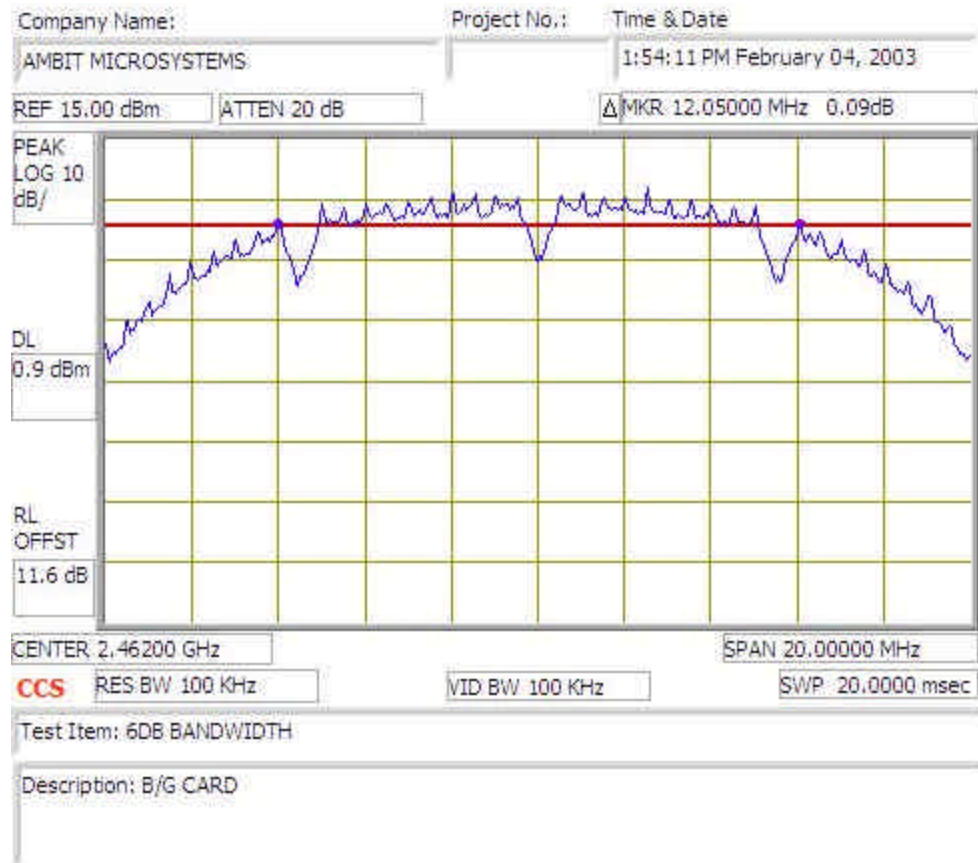

6 DB BANDWIDTH (2.4 GHZ g BAND, NORMAL MODE)

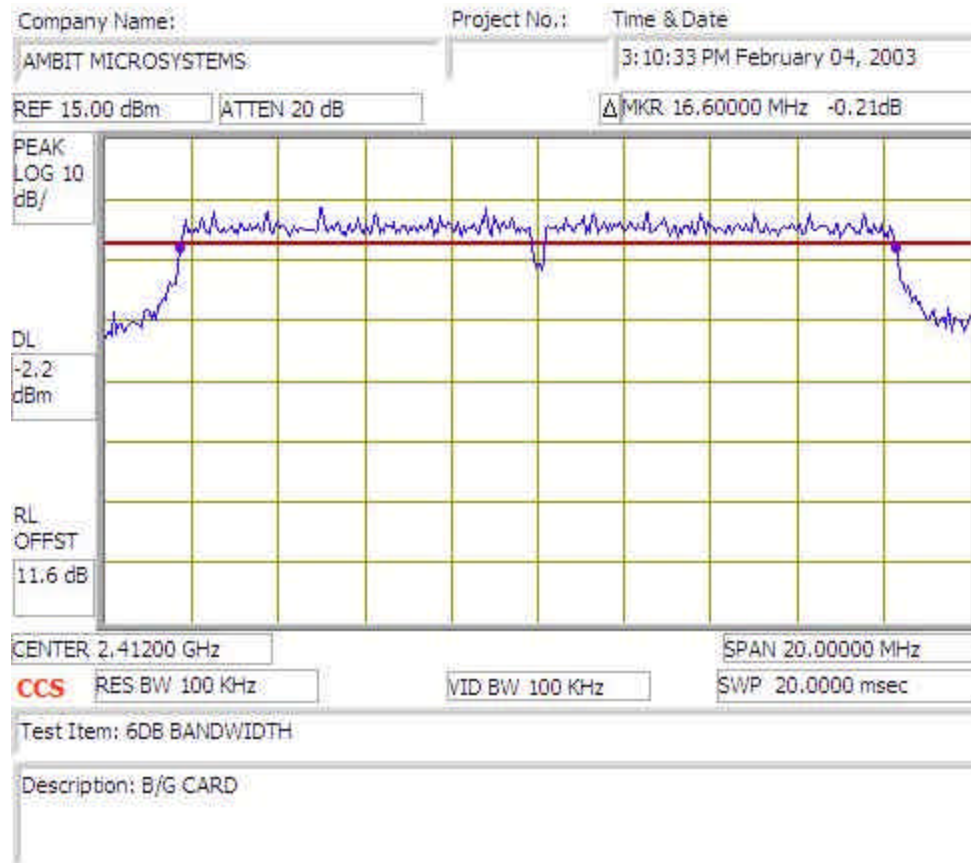

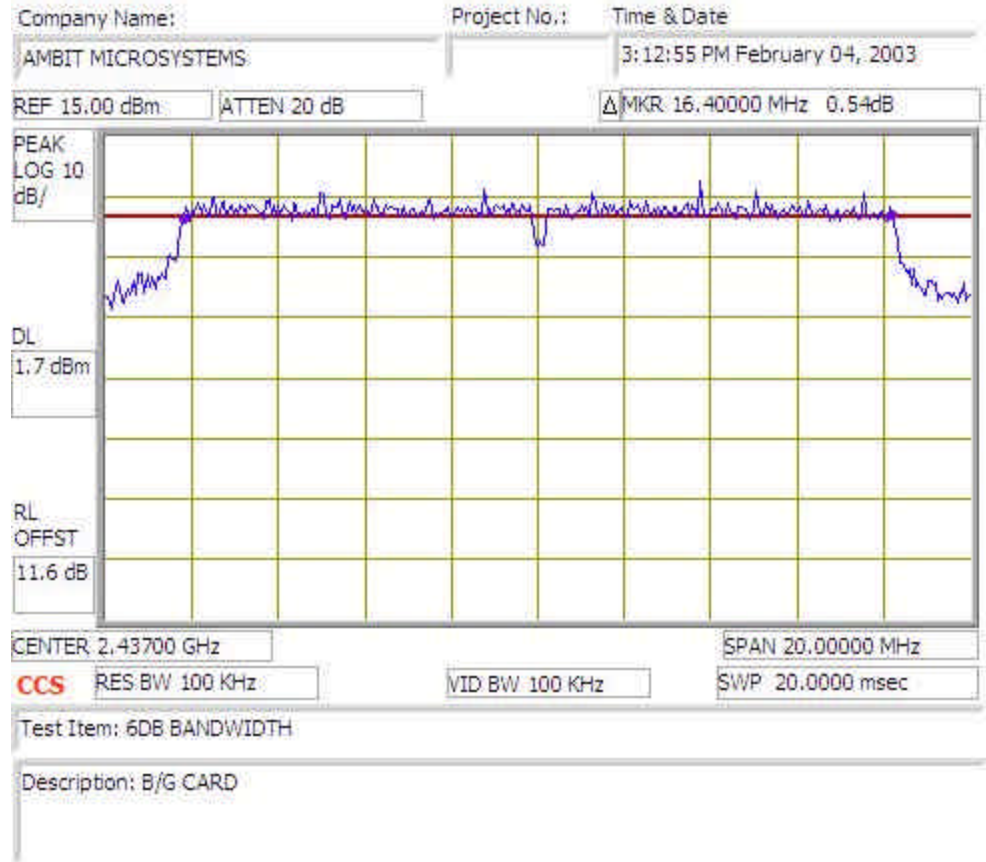

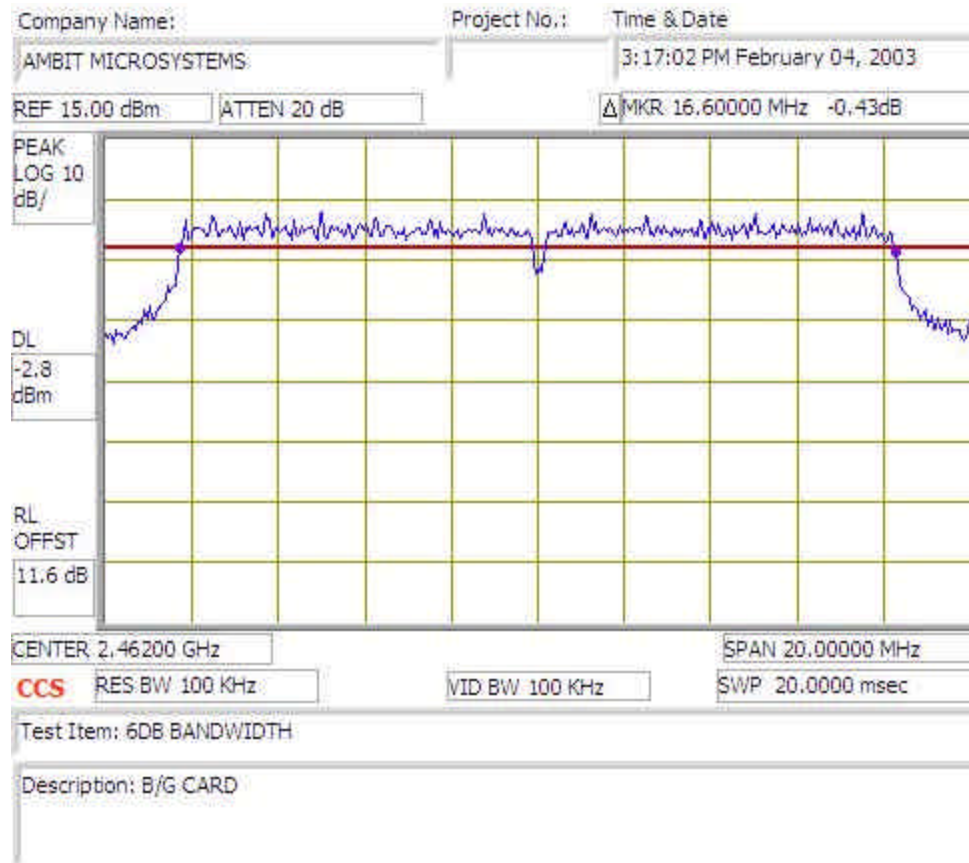

6 DB BANDWIDTH (2.4 GHZ g BAND, TURBO MODE)

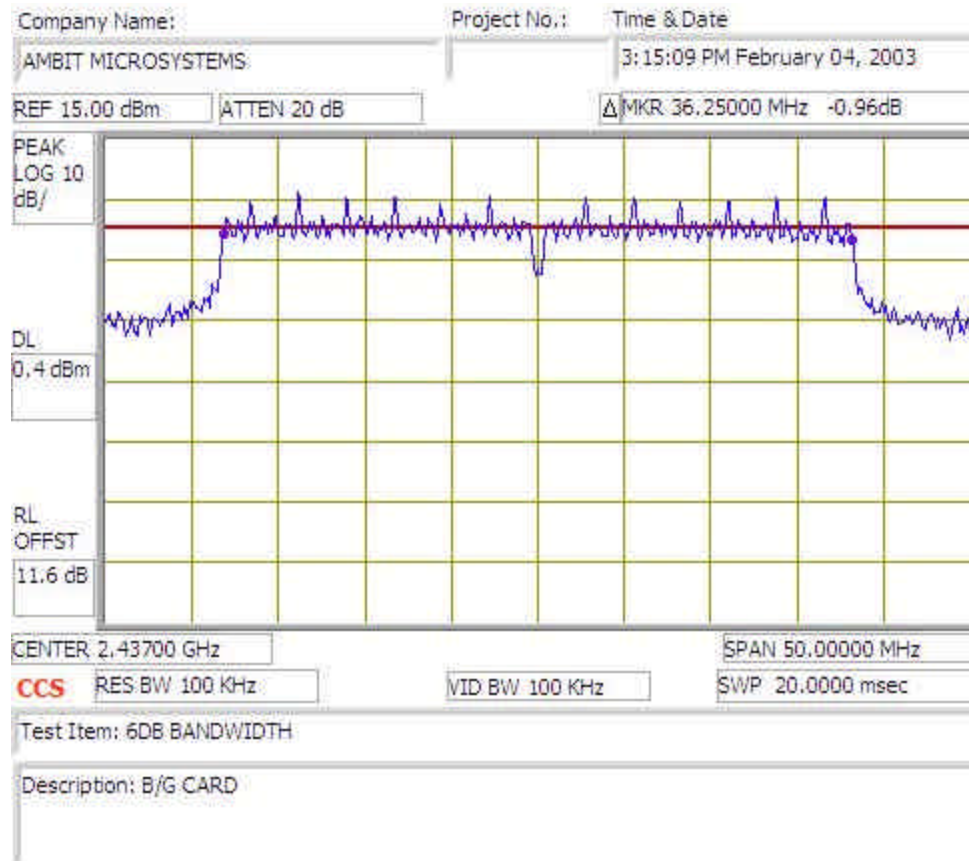

8.2. PEAK POWER

TEST SETUP

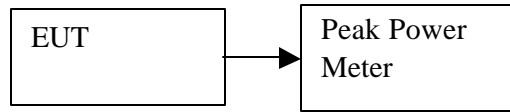

TEST PROCEDURE

The transmitter output is connected to the power meter. The power meter is set to read peak power.

LIMIT

The maximum antenna gain = 4.96 dBi, therefore the limit is 30 dBm.

RESULTS

No non-compliance noted:

The cable assembly insertion loss of 11.6 dB (including 10 dB pad and 1.6 dB cable) was entered as an offset in the power meter to allow for direct reading of power.

2.4 GHz b Band

Channel	Frequency (MHz)	Peak Power (dBm)	Limit (dBm)	Margin (dB)
Low	2412	20.64	30	-9.36
Middle	2437	20.35	30	-9.65
High	2462	19.46	30	-10.54

2.4 GHz g Band Normal Mode

Channel	Frequency (MHz)	Peak Power (dBm)	Limit (dBm)	Margin (dB)
Low	2412	21.36	30	-8.64
Middle	2437	21.92	30	-8.08
High	2462	21.25	30	-8.75

2.4 GHz g Band Turbo Mode

Channel	Frequency (MHz)	Peak Power (dBm)	Limit (dBm)	Margin (dB)
Middle	2437	21.64	30	-8.36

8.3. AVERAGE POWER

TEST SETUP

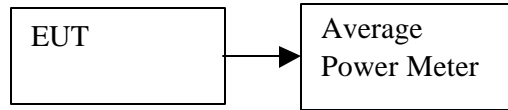

TEST PROCEDURE

The transmitter output is connected to the power meter. The power meter is set to read average power.

LIMIT

None, reporting only.

RESULTS

No non-compliance noted:

The cable assembly insertion loss of 11.6 dB (including 10 dB pad and 1.6 dB cable) was entered as an offset in the power meter to allow for direct reading of power.

2.4 GHz b Band

Channel	Frequency (MHz)	Average Power (dBm)
Low	2412	18.00
Middle	2437	17.84
High	2462	17.23

2.4 GHz g Band Normal Mode

Channel	Frequency (MHz)	Average Power (dBm)
Low	2412	15.28
Middle	2437	17.84
High	2462	14.32

2.4 GHz g Band Turbo Mode

Channel	Frequency (MHz)	Average Power (dBm)
Middle	2437	18

8.4. PEAK POWER SPECTRAL DENSITY

TEST SETUP

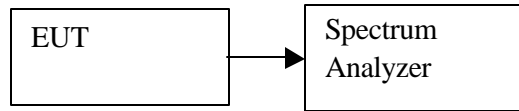

TEST PROCEDURE

The transmitter output is connected to the spectrum analyzer, the maximum level in a 3 kHz bandwidth is measured with the spectrum analyzer using RBW = 3 kHz and VBW >= 3KHz, sweep time = span / 3 kHz, and video averaging is turned off. The PPSD is the highest level found across the emission in any 3 kHz band.

RESULTS

No non-compliance noted:

2.4 GHz b Band

Channel	Frequency (MHz)	PPSD (dBm)	Limit (dBm)	Margin (dB)
Low	2412	-4.05	8	-12.05
Middle	2437	-4.25	8	-12.25
High	2462	-4.60	8	-12.60

2.4 GHz g Band Normal Mode

Channel	Frequency (MHz)	PPSD (dBm)	Limit (dBm)	Margin (dB)
Low	2412	-9.14	8	-17.14
Middle	2437	-5.80	8	-13.8
High	2462	-9.12	8	-17.12

2.4 GHz g Band Turbo Mode

Channel	Frequency (MHz)	PPSD (dBm)	Limit (dBm)	Margin (dB)
Middle	2437	-10.85	8	-18.85

PPSD (2.4 GHZ b BAND)

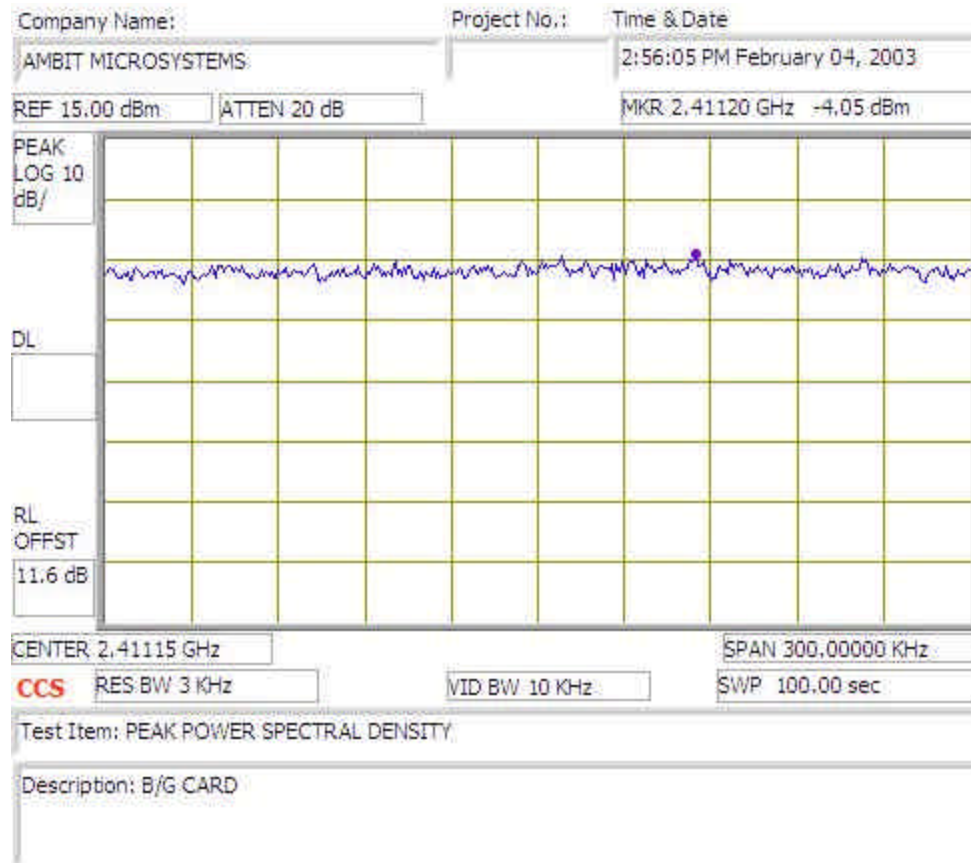

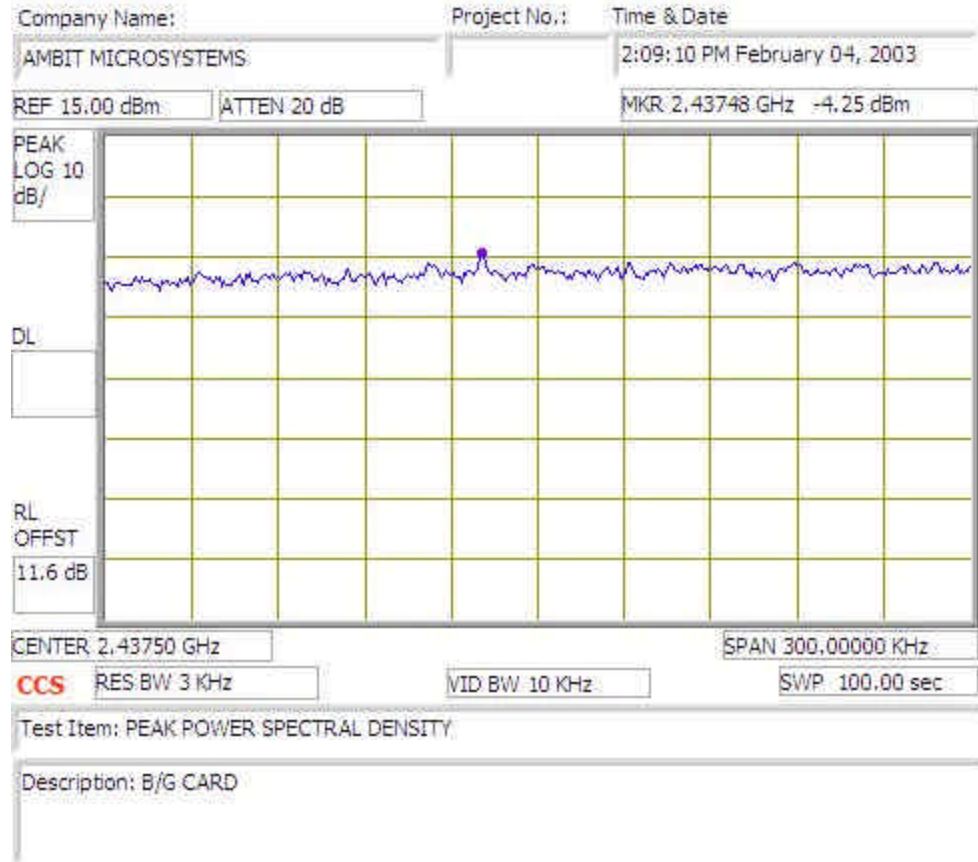

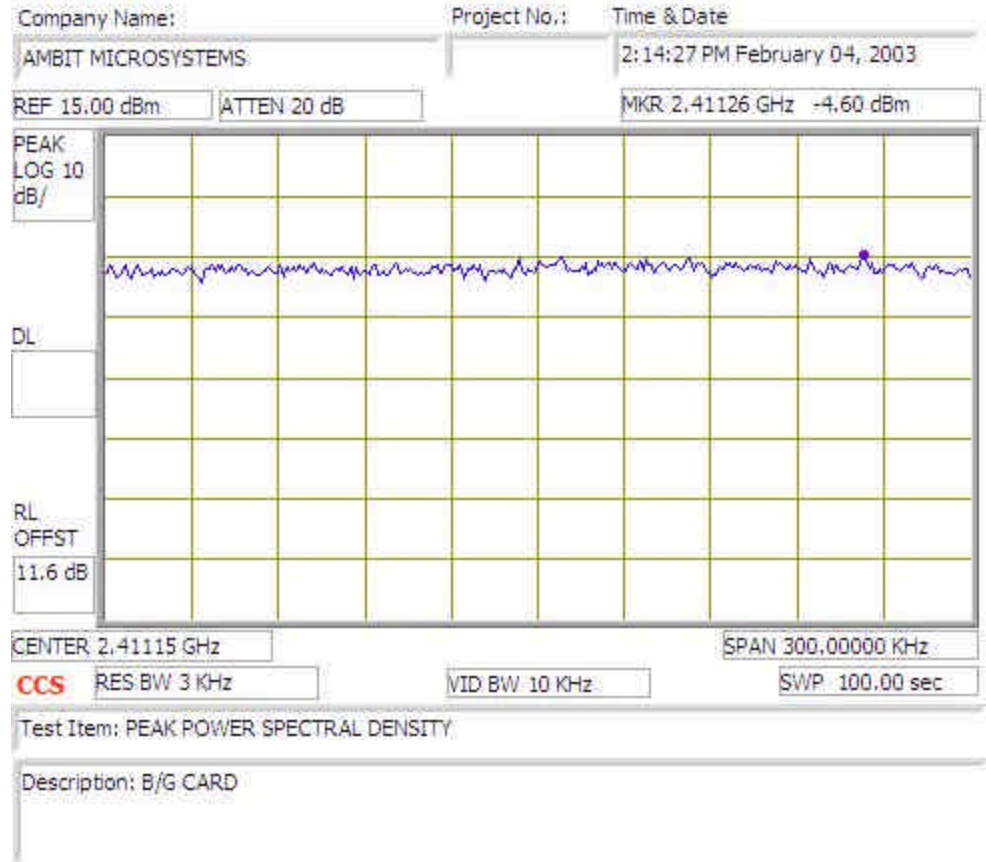

PPSD (2.4 GHZ g BAND, NORMAL MODE)

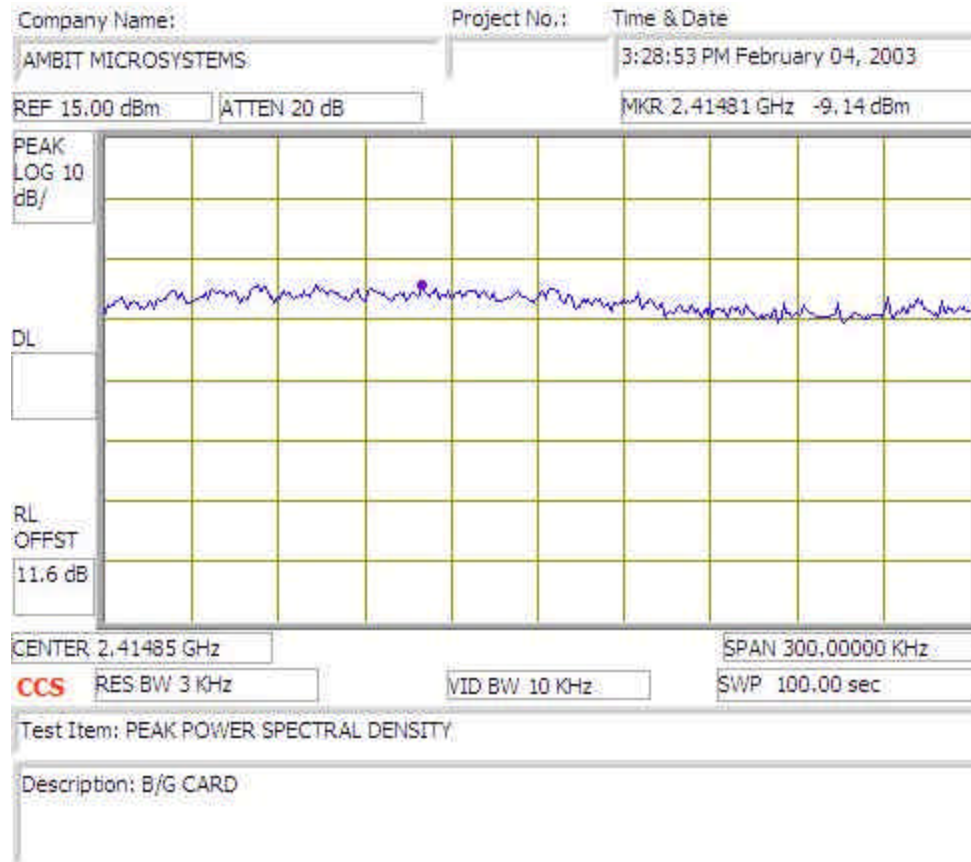

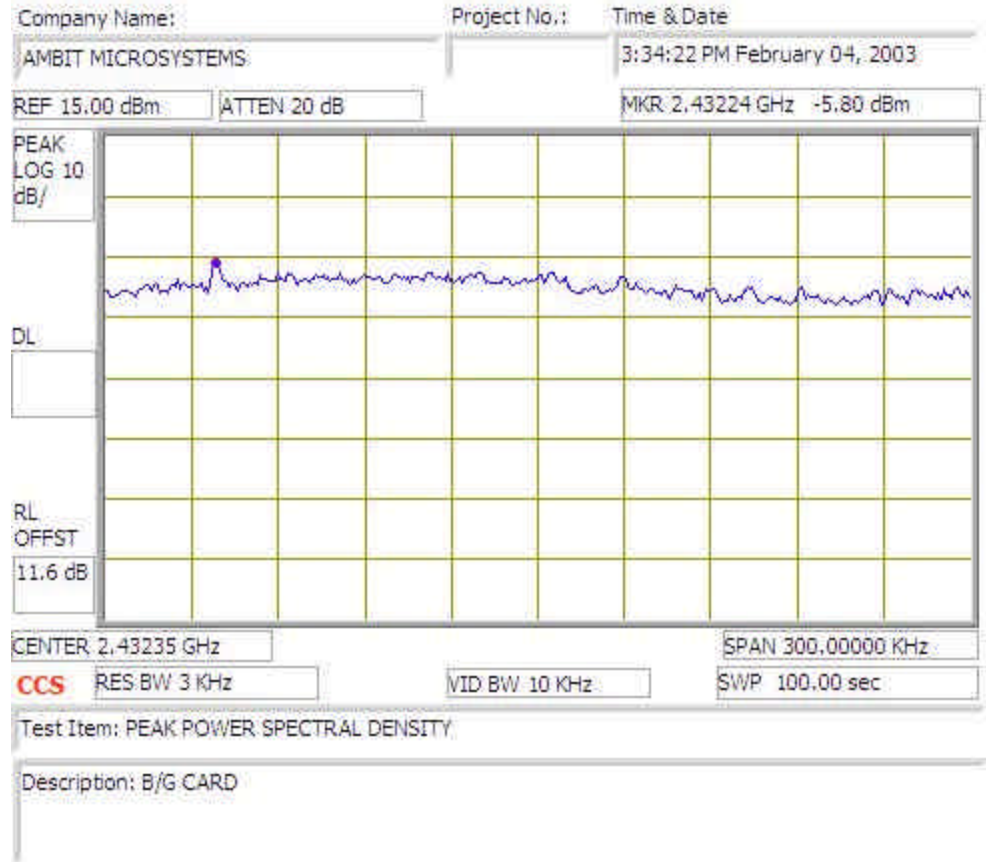

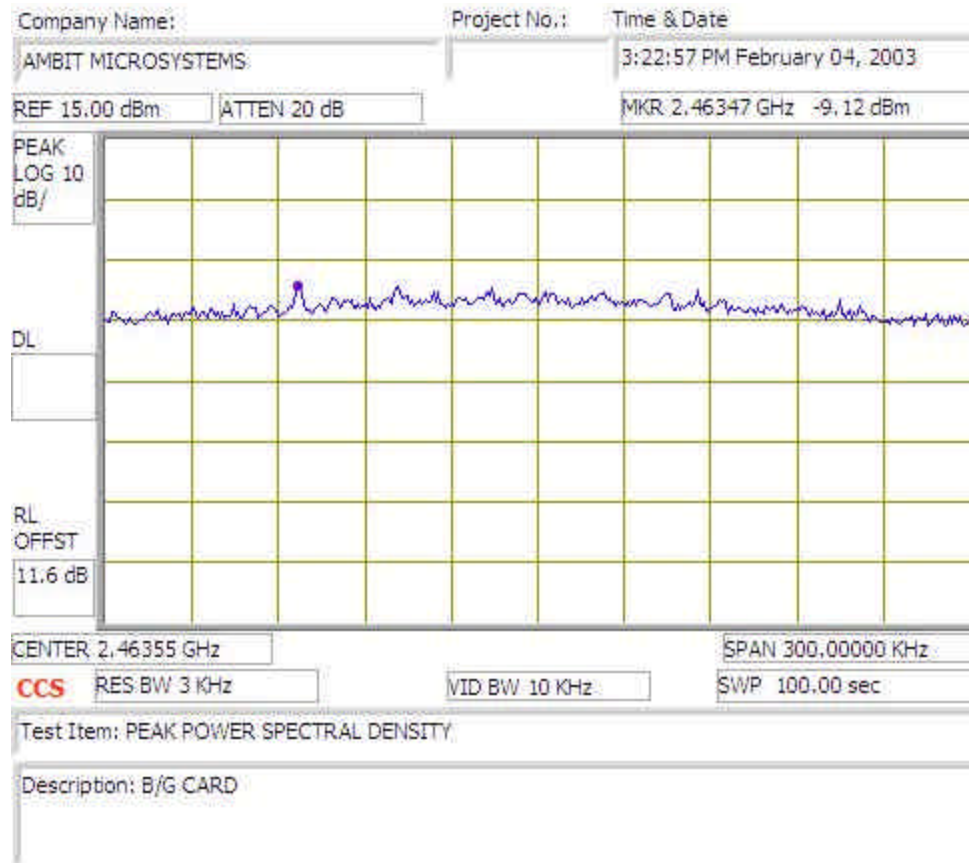

PPSD (2.4 GHZ g BAND, TURBO MODE)

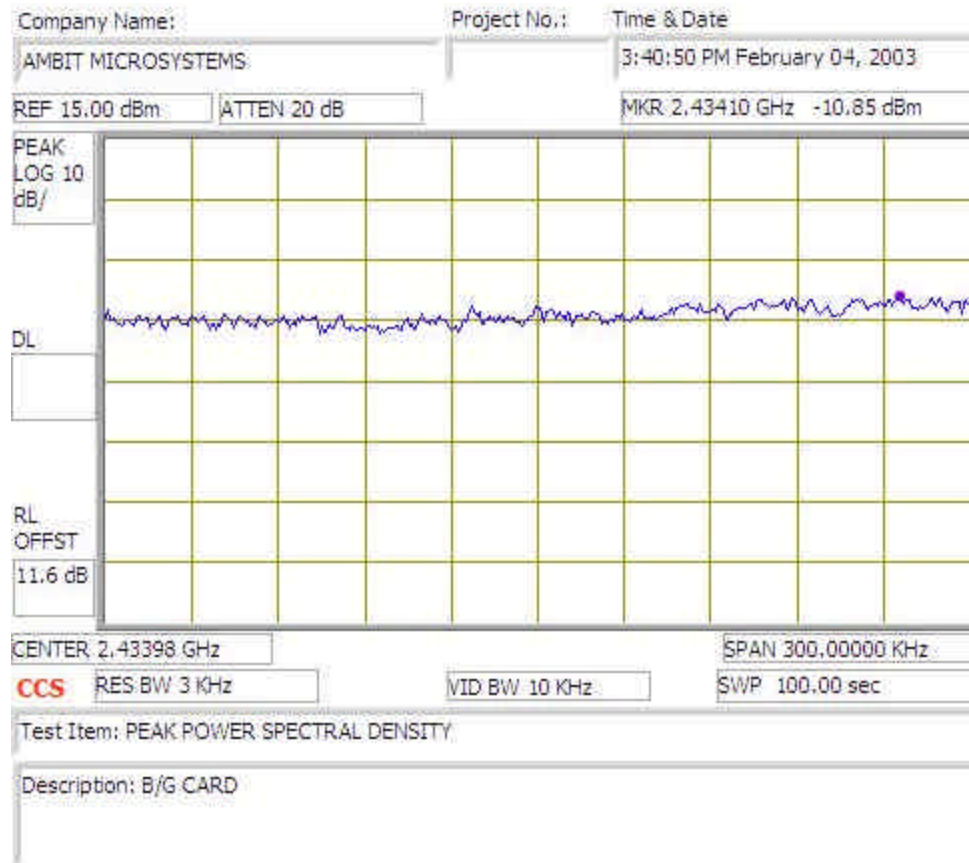

8.5. MAXIMUM PERMISSIBLE EXPOSURE

CALCULATIONS

Given

$$E = \sqrt{(30 * P * G) / d}$$

and

$$S = E^2 / 3770$$

where

E = Field Strength in Volts / meter

P = Power in Watts

G = Numeric antenna gain

d = distance in meters

S = Power Density in milliwatts / square centimeter

Combining equations and rearranging the terms to express the distance as a function of the remaining variables yields:

$$d = \sqrt{((30 * P * G) / (3770 * S))}$$

Changing to units of mW and cm, using:

$$P \text{ (mW)} = P \text{ (W)} / 1000 \text{ and}$$

$$d \text{ (cm)} = 100 * d \text{ (m)}$$

yields

$$d = 100 * \sqrt{((30 * (P / 1000) * G) / (3770 * S))}$$

$$d = 0.282 * \sqrt{(P * G / S)}$$

where

d = distance in cm

P = Power in mW

G = Numeric antenna gain

S = Power Density in mW / cm²

$$P \text{ (mW)} = 10^{(P \text{ (dBm)} / 10)} \text{ and}$$

$$G \text{ (numeric)} = 10^{(G \text{ (dBi)} / 10)}$$

yields

$$d = 0.282 * 10^{((P + G) / 20)} / \sqrt{S} \quad \text{Equation (1)}$$

where

d = MPE safe distance in cm
P = Power in dBm
G = Antenna Gain in dBi
S = Power Density Limit in mW / cm²

RESULTS

No non-compliance noted:

MAXIMUM PERMISSIBLE EXPOSURE (2.4 GHZ b BAND)

EUT output power = 20.64 dBm
Antenna Gain = 4.96 dBi
S = 1.0 mW / cm² from 1.1310 Table 1

Substituting these parameters into Equation (1) above:

MPE Safe Distance = 5.37 cm

MAXIMUM PERMISSIBLE EXPOSURE (2.4 GHZ g BAND)

EUT output power = 21.92 dBm
Antenna Gain = 4.96 dBi
S = 1.0 mW / cm² from 1.1310 Table 1

Substituting these parameters into Equation (1) above:

MPE Safe Distance = 6.23 cm

8.6. SPURIOUS EMISSIONS

Conducted RF measurements of the transmitter output were made to confirm that the EUT antenna port conducted emissions meet the specified limit and to identify any spurious signals that require further investigation or measurements on the radiated emissions site.

TEST SETUP

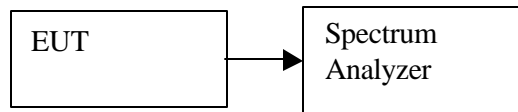

TEST PROCEDURE

The transmitter output is connected to the spectrum analyzer. The resolution bandwidth is set to 100 kHz. The video bandwidth is set to 100 kHz.

Measurements are made over the 30 MHz to 26.5 GHz range with the transmitter set to the lowest, middle, and highest channels within the 2.4 GHz band.

RESULTS

No non-compliance noted:

CONDUCTED SPURIOUS EMISSIONS (2.4 GHZ b BAND)

2.412GHz

