



FCC TEST REPORT (15.247)

REPORT NO.: RF140116E08

COMPLIANCE ID: ADBB-GX13004A

PRODUCT NAME* : DB 6520

**For any other product variant refer to above Compliance ID*

FCC ID: MCLDB6520

RECEIVED: Jan. 16, 2014

TESTED: Jan. 27 to Feb. 27, 2014

ISSUED: May 14, 2014

APPLICANT: Hon Hai PRECISION IND.CO.,LTD

ADDRESS: 5F-1,5 Hsin-An Road Hsinchu, Science-Based
Industrial Park Taiwan, R.O.C.

ISSUED BY: Bureau Veritas Consumer Products Services (H.K.)
Ltd., Taoyuan Branch Hsin Chu Laboratory

LAB ADDRESS : No. 81-1, Lu Liao Keng, 9th Ling, Wu Lung Tsuen,
Chiung Lin Hsiang, Hsin Chu Hsien 307, Taiwan,
R.O.C.

TEST LOCATION (1): No. 81-1, Lu Liao Keng, 9th Ling, Wu Lung Tsuen,
Chiung Lin Hsiang, Hsin Chu Hsien 307, Taiwan,
R.O.C.

TEST LOCATION (2): No. 49, Ln. 206, Wende Rd., Shangshan Tsuen,
Chiung Lin Hsiang, Hsin Chu Hsien 307, Taiwan,
R.O.C.

This report should not be used by the client to claim product certification, approval, or endorsement by TAF or any government agencies.



This report is for your exclusive use. Any copying or replication of this report to or for any other person or entity, or use of our name or trademark, is permitted only with our prior written permission. This report sets forth our findings solely with respect to the test samples identified herein. The results set forth in this report are not indicative or representative of the quality or characteristics of the lot from which a test sample was taken or any similar or identical product unless specifically and expressly noted. Our report includes all of the tests requested by you and the results thereof based upon the information that you provided to us. You have 60 days from date of issuance of this report to notify us of any material error or omission caused by our negligence, provided, however, that such notice shall be in writing and shall specifically address the issue you wish to raise. A failure to raise such issue within the prescribed time shall constitute your unqualified acceptance of the completeness of this report, the tests conducted and the correctness of the report contents. Unless specific mention, the uncertainty of measurement has been explicitly taken into account to declare the compliance or non-compliance to the specification



A D T

Table of Contents

RELEASE CONTROL RECORD	5
1. CERTIFICATION	6
2. SUMMARY OF TEST RESULTS	7
2.1 MEASUREMENT UNCERTAINTY	8
3. GENERAL INFORMATION	9
3.1 GENERAL DESCRIPTION OF EUT	9
3.2 DESCRIPTION OF TEST MODES	13
3.2.1 TEST MODE APPLICABILITY AND TESTED CHANNEL DETAIL	14
3.3 GENERAL DESCRIPTION OF APPLIED STANDARDS	18
3.4 DUTY CYCLE OF TEST SIGNAL	19
3.5 DESCRIPTION OF SUPPORT UNITS	24
3.6 CONFIGURATION OF SYSTEM UNDER TEST	25
4. TEST TYPES AND RESULTS (FOR 2.4GHz, 2.400 ~ 2.4835GHz Band)	27
4.1 CONDUCTED EMISSION MEASUREMENT	27
4.1.1 LIMITS OF CONDUCTED EMISSION MEASUREMENT	27
4.1.2 TEST INSTRUMENTS	27
4.1.3 TEST PROCEDURES	28
4.1.4 DEVIATION FROM TEST STANDARD	28
4.1.5 TEST SETUP	28
4.1.6 EUT OPERATING CONDITIONS	29
4.1.7 TEST RESULTS	30
4.2 RADIATED EMISSION AND BANDEDGE MEASUREMENT	32
4.2.1 LIMITS OF RADIATED EMISSION AND BANDEDGE MEASUREMENT	32
4.2.2 TEST INSTRUMENTS	33
4.2.3 TEST PROCEDURES	34
4.2.4 DEVIATION FROM TEST STANDARD	34
4.2.5 TEST SETUP	35
4.2.6 EUT OPERATING CONDITIONS	35
4.2.7 TEST RESULTS	36
4.3 6dB BANDWIDTH MEASUREMENT	58
4.3.1 LIMITS OF 6dB BANDWIDTH MEASUREMENT	58
4.3.2 TEST INSTRUMENTS	58
4.3.3 TEST PROCEDURE	58
4.3.4 DEVIATION FROM TEST STANDARD	58
4.3.5 TEST SETUP	58
4.3.6 EUT OPERATING CONDITIONS	58
4.3.7 TEST RESULTS	59
4.4 CONDUCTED OUTPUT POWER MEASUREMENT	63
4.4.1 LIMITS OF MAXIMUM OUTPUT POWER MEASUREMENT	63
4.4.2 INSTRUMENTS	63
4.4.3 TEST PROCEDURES	63
4.4.4 DEVIATION FROM TEST STANDARD	63
4.4.5 TEST SETUP	64
4.4.6 EUT OPERATING CONDITIONS	64
4.4.7 TEST RESULTS	65
4.5 POWER SPECTRAL DENSITY MEASUREMENT	67
4.5.1 LIMITS OF POWER SPECTRAL DENSITY MEASUREMENT	67
4.5.2 TEST INSTRUMENTS	67
4.5.3 TEST PROCEDURE	67
4.5.4 DEVIATION FROM TEST STANDARD	67
4.5.5 TEST SETUP	67
4.5.6 EUT OPERATING CONDITION	67
4.5.7 TEST RESULTS	68
4.6 CONDUCTED OUT-BAND EMISSION MEASUREMENT	72



4.6.1	LIMITS OF CONDUCTED OUT-BAND EMISSION MEASUREMENT.....	72
4.6.2	TEST INSTRUMENTS.....	72
4.6.3	TEST PROCEDURE.....	72
4.6.4	DEVIATION FROM TEST STANDARD.....	73
4.6.5	TEST SETUP.....	73
4.6.6	EUT OPERATING CONDITION.....	73
4.6.7	TEST RESULTS.....	73
5.	TEST TYPES AND RESULTS (FOR 5GHz, 5.725~5.850GHz Band).....	84
5.1	CONDUCTED EMISSION MEASUREMENT.....	84
5.1.1	LIMITS OF CONDUCTED EMISSION MEASUREMENT.....	84
5.1.2	TEST INSTRUMENTS.....	84
5.1.3	TEST PROCEDURES.....	85
5.1.4	DEVIATION FROM TEST STANDARD.....	85
5.1.5	TEST SETUP.....	85
5.1.6	EUT OPERATING CONDITIONS.....	86
5.1.7	TEST RESULTS.....	87
5.2	RADIATED AND BANDEDGE EMISSION MEASUREMENT.....	89
5.2.1	LIMITS OF RADIATED AND BANDEDGE EMISSION MEASUREMENT.....	89
5.2.2	TEST INSTRUMENTS.....	90
5.2.3	TEST PROCEDURES.....	92
5.2.4	DEVIATION FROM TEST STANDARD.....	92
5.2.5	TEST SETUP.....	93
5.2.6	EUT OPERATING CONDITIONS.....	93
5.2.7	TEST RESULTS.....	94
5.3	6dB BANDWIDTH MEASUREMENT.....	116
5.3.1	LIMITS OF 6dB BANDWIDTH MEASUREMENT.....	116
5.3.2	TEST INSTRUMENTS.....	116
5.3.3	TEST PROCEDURE.....	116
5.3.4	DEVIATION FROM TEST STANDARD.....	116
5.3.5	TEST SETUP.....	116
5.3.6	EUT OPERATING CONDITIONS.....	117
5.3.7	TEST RESULTS.....	118
5.4	CONDUCTED OUTPUT POWER MEASUREMENT.....	123
5.4.1	LIMITS OF CONDUCTED OUTPUT POWER MEASUREMENT.....	123
5.4.2	INSTRUMENTS.....	123
5.4.3	TEST PROCEDURES.....	123
5.4.4	DEVIATION FROM TEST STANDARD.....	123
5.4.5	TEST SETUP.....	124
5.4.6	EUT OPERATING CONDITIONS.....	124
5.4.7	TEST RESULTS.....	125
5.5	POWER SPECTRAL DENSITY MEASUREMENT.....	128
5.5.1	LIMITS OF POWER SPECTRAL DENSITY MEASUREMENT.....	128
5.5.2	TEST INSTRUMENTS.....	128
5.5.3	TEST PROCEDURE.....	128
5.5.4	DEVIATION FROM TEST STANDARD.....	128
5.5.5	TEST SETUP.....	128
5.5.6	EUT OPERATING CONDITION.....	128
5.5.7	TEST RESULTS.....	129
5.6	CONDUCTED OUT-BAND EMISSION MEASUREMENT.....	134
5.6.1	LIMITS OF CONDUCTED OUT-BAND EMISSION MEASUREMENT.....	134
5.6.2	TEST INSTRUMENTS.....	134
5.6.3	TEST PROCEDURE.....	134
5.6.4	DEVIATION FROM TEST STANDARD.....	135
5.6.5	TEST SETUP.....	135
5.6.6	EUT OPERATING CONDITION.....	135
5.6.7	TEST RESULTS.....	135



A D T

6.	PHOTOGRAPHS OF THE TEST CONFIGURATION.....	153
7.	INFORMATION ON THE TESTING LABORATORIES	154
8.	APPENDIX A - MODIFICATIONS RECORDERS FOR ENGINEERING CHANGES TO THE EUT BY THE LAB.....	155





A D T

RELEASE CONTROL RECORD

ISSUE NO.	REASON FOR CHANGE	DATE ISSUED
RF140116E08	Original release	May 14, 2014



1. CERTIFICATION

COMPLIANCE ID: ADBB-GX13004A

PRODUCT NAME*: DB 6520

PRODUCT DESCRIPTION: VDSL/GbE WiFi Data Router

**For any other product variant refer to above Compliance ID*

BRAND NAME: ADB

TEST SAMPLE: ENGINEERING SAMPLE

APPLICANT: Hon Hai PRECISION IND.CO.,LTD

TESTED: Jan. 27 to Feb. 27, 2014

STANDARDS: FCC Part 15, Subpart C (Section 15.247)
ANSI C63.10-2009

The above equipment (Model: DB 6520) has been tested by **Bureau Veritas Consumer Products Services (H.K.) Ltd., Taoyuan Branch**, and found compliance with the requirement of the above standards. The test record, data evaluation & Equipment Under Test (EUT) configurations represented herein are true and accurate accounts of the measurements of the sample's EMC characteristics under the conditions specified in this report.

PREPARED BY : Midoli Peng , **DATE:** May 14, 2014
(Midoli Peng, Specialist)

APPROVED BY : May Chen , **DATE:** May 14, 2014
(May Chen, Manager)



A D T

2. SUMMARY OF TEST RESULTS

The EUT has been tested according to the following specifications:

For 2.4GHz, 2400~2483.5MHz Band

APPLIED STANDARD: FCC PART 15, SUBPART C (SECTION 15.247)			
STANDARD SECTION	TEST TYPE	RESULT	REMARK
15.207	AC Power Conducted Emission	PASS	Meet the requirement of limit. Minimum passing margin is -17.54dB at 0.15781MHz
15.247(d) 15.209	Radiated Emissions	PASS	Meet the requirement of limit. Minimum passing margin is -0.6dB at 2390.00MHz & 2483.50MHz
15.247(d)	Band Edge Measurement	PASS	Meet the requirement of limit.
15.247(a)(2)	6dB bandwidth	PASS	Meet the requirement of limit.
15.247(b)	Conducted Output power	PASS	Meet the requirement of limit.
15.247(e)	Power Spectral Density	PASS	Meet the requirement of limit.
15.203	Antenna Requirement	PASS	Antenna connector is I-PEX not a standard connector.

For 5GHz, 5725~5850MHz Band

APPLIED STANDARD: FCC PART 15, SUBPART C (SECTION 15.247)			
STANDARD SECTION	TEST TYPE	RESULT	REMARK
15.207	AC Power Conducted Emission	PASS	Meet the requirement of limit. Minimum passing margin is -17.30dB at 0.15391MHz
15.247(d) 15.209	Radiated Emissions	PASS	Meet the requirement of limit. Minimum passing margin is -0.6dB at 5350.00MHz.
15.247(d)	Band Edge Measurement	PASS	Meet the requirement of limit.
15.247(a)(2)	6dB bandwidth	PASS	Meet the requirement of limit.
15.247(b)	Conducted Output power	PASS	Meet the requirement of limit.
15.247(e)	Power Spectral Density	PASS	Meet the requirement of limit.
15.203	Antenna Requirement	PASS	Antenna connector is I-PEX not a standard connector.

NOTE:

The EUT was operating in 2.400 ~ 2.4835GHz, 5.15~5.25GHz and 5.725~5.850GHz frequencies band. This report was recorded the RF parameters including 2.400 ~ 2.4835GHz and 5.725~5.850GHz. For the 5.15~5.25GHz RF parameters was recorded in another test report.



A D T

2.1 MEASUREMENT UNCERTAINTY

Where relevant, the following measurement uncertainty levels have been estimated for tests performed on the EUT as specified in CISPR 16-4-2:

This uncertainty represents an expanded uncertainty expressed at approximately the 95% confidence level using a coverage factor of $k=2$.

Measurement	Value
Conducted emissions	2.98 dB
Radiated emissions (30MHz-1GHz)	5.43 dB
Radiated emissions (1GHz -6GHz) – Chamber H	3.72 dB
Radiated emissions (6GHz -18GHz) – Chamber H	4.00 dB
Radiated emissions (18GHz -40GHz) – Chamber H	4.11 dB
Radiated emissions (1GHz -6GHz) – Chamber G	3.65 dB
Radiated emissions (6GHz -18GHz) – Chamber G	3.88 dB
Radiated emissions (18GHz -40GHz) – Chamber G	4.11 dB



A D T

3. GENERAL INFORMATION

3.1 GENERAL DESCRIPTION OF EUT

COMPLIANCE ID:	ADBB-GX13004A
PRODUCT NAME*:	DB 6520
PRODUCT DESCRIPTION:	VDSL/GbE WiFi Data Router
<i>*For any other product variant refer to above Compliance ID</i>	
POWER SUPPLY	DC 12V from power adapter
MODULATION TYPE	CCK, DQPSK, DBPSK for DSSS 64QAM, 16QAM, QPSK, BPSK for OFDM
MODULATION TECHNOLOGY	DSSS,OFDM
TRANSFER RATE	802.11b: up to 11Mbps 802.11a/g: up to 54Mbps 802.11n(2.4GHz, HT20): up to 144.44Mbps 802.11n(2.4GHz, HT40): up to 300Mbps 802.11n(5GHz, HT20): up to 216.7Mbps 802.11n(5GHz, HT40): up to 450Mbps
OPERATING FREQUENCY	For 15.407 5GHz: 5.18 ~ 5.24GHz
	For 15.247 2.4GHz: 2.412 ~ 2.462GHz 5GHz: 5.745 ~ 5.825GHz
NUMBER OF CHANNEL	For 15.407 4 for 802.11a, 802.11n (HT20) 2 for 802.11n (HT40)
	For 15.247 (2.4GHz) 11 for 802.11b, 802.11g, 802.11n (HT20) 7 for 802.11n (HT40)
	For 15.247 (5GHz) 5 for 802.11a, 802.11n (HT20) 2 for 802.11n (HT40)



A D T

MAXIMUM OUTPUT POWER	For 15.407
	1Tx
	802.11a: 44.771mW
	802.11n (HT20): 45.814mW
	802.11n (HT40): 49.091mW
	2Tx
	802.11n (HT20): 40.235mW
	802.11n (HT40): 45.613mW
	3Tx
	802.11a: 42.316mW
	802.11n (HT20): 40.879mW
	802.11n (HT40): 48.168mW
	For 15.247(2.4GHz)
	1Tx
	802.11b: 211.836mW
802.11g: 171.396mW	
802.11n (HT20): 166.725mW	
802.11n (HT40): 118.577mW	
2Tx	
802.11g: 335.393mW	
802.11n (HT20): 328.496mW	
802.11n (HT40): 200.063mW	
For 15.247(5GHz)	
1Tx	
802.11a: 174.582mW	
802.11n (HT20): 176.604mW	
802.11n (HT40): 146.893mW	
2Tx	
802.11n (HT20): 274.861mW	
802.11n (HT40): 280.831mW	
3Tx	
802.11a: 378.121mW	
802.11n (HT20): 344.956mW	
802.11n (HT40): 221.806mW	
ANTENNA TYPE	Please see NOTE
DATA CABLE	NA
I/O PORTS	Refer to user's manual
ASSOCIATED DEVICES	Adapter x1



A D T

NOTE:

1. 2.4GHz and 5GHz technology can transmit at same time.
2. The EUT must be supplied with a power adapter as following table:

Brand	Model No.	Spec.
Ampower Tek	AU36AA-00	Input: 100-240V, 1.2A, 50-60Hz Output: 12V, 3A DC output cable(1.85m, unshielded with one core)

3. The antennas provided to the EUT, please refer to the following table:

Transmitter Circuit (Ant. No.)	Brand	Model	Antenna Type	Gain (dBi) (including cable loss)	Diversity Function	Frequency range (GHz to GHz)	Connecter Type	Cable Length (mm)
Chain (0) A2	Airgain	M2450DL	PIFA	3.0	Yes	5.15 to 5.35	I-PEX	100
		CM-T1-G 100U		5.1		5.47 to 5.85		
Chain (1) A3	Airgain	M2450DL	PIFA	2.6	Yes	2.4 to 2.49	I-PEX	85
		CM-T-G8		2.5		5.15 to 5.35		
		5CC20R2		3.8		5.47 to 5.85		
Chain (2) A1	Airgain	M2450DL	PIFA	1.8	Yes	2.4 to 2.49	I-PEX	190
		CM-T1-G		2.1		5.15 to 5.35		
		190UR2		3.1		5.47 to 5.85		

- Note. :**
1. For 2.4GHz<1Tx mode>: Chain (1) was chosen for final test.
 2. For 5GHz<1Tx mode>: Chain (0) was chosen for final test.
 3. For 5GHz<2Tx mode>: Chain (0) & Chain (1) were chosen for final test.



A D T

4. The EUT incorporates a MIMO function without beam forming.

MODULATION MODE	DATA RATE (MCS)	TX & RX CONFIGURATION	
802.11b	1 ~ 11Mbps	1Tx diversity	1Rx diversity
802.11g	6 ~ 54Mbps	1Tx diversity & 2Tx CDD	1Rx diversity & 2Rx
802.11n (HT20) (2.4GHz)	MCS 0~7	1Tx diversity & 2Tx CDD	1Rx diversity & 2Rx
	MCS 8~15	2Tx SDM	2Rx
802.11n (HT40) (2.4GHz)	MCS 0~7	1Tx diversity & 2Tx CDD	1Rx diversity & 2Rx
	MCS 8~15	2Tx SDM	2Rx
802.11a	6 ~ 54Mbps	1Tx diversity & 3Tx CDD	3Rx
802.11n (HT20) (5GHz)	MCS 0~7	1Tx diversity & 3Tx CDD	1Rx diversity & 3Rx
	MCS 8~15	2Tx diversity & 3Tx CDD	2Rx diversity & 3Rx
	MCS 16~23	3Tx SDM	3Rx
802.11n (HT40) (5GHz)	MCS 0~7	1Tx diversity & 3Tx CDD	1Rx diversity & 3Rx
	MCS 8~15	2Tx diversity & 3Tx CDD	2Rx diversity & 3Rx
	MCS 16~23	3Tx SDM	3Rx

5. For 2.4 GHz: When the EUT operating in 802.11n, the software operation, which is defined by manufacturer, MCS (Modulation and Coding Schemes) from 0 to 15.
6. For 5 GHz: When the EUT operating in 802.11n, the software operation, which is defined by manufacturer, MCS (Modulation and Coding Schemes) from 0 to 23.
7. The above EUT information was declared by the manufacturer and for more detailed features description, please refer to the manufacturer's specifications or User's Manual.

3.2 DESCRIPTION OF TEST MODES

Operated in 2400 ~ 2483.5MHz band:

11 channels are provided for 802.11b, 802.11g, 802.11n (HT20):

CHANNEL	FREQUENCY	CHANNEL	FREQUENCY
1	2412MHz	7	2442MHz
2	2417MHz	8	2447MHz
3	2422MHz	9	2452MHz
4	2427MHz	10	2457MHz
5	2432MHz	11	2462MHz
6	2437MHz		

7 channels are provided for 802.11n (HT40):

CHANNEL	FREQUENCY	CHANNEL	FREQUENCY
3	2422MHz	7	2442MHz
4	2427MHz	8	2447MHz
5	2432MHz	9	2452MHz
6	2437MHz		

Operated in 5725 ~ 5850MHz band:

5 channels are provided for 802.11a, 802.11n (HT20):

CHANNEL	FREQUENCY	CHANNEL	FREQUENCY
149	5745 MHz	161	5805 MHz
153	5765 MHz	165	5825 MHz
157	5785 MHz		

2 channels are provided for 802.11n (HT40):

CHANNEL	FREQUENCY
151	5755 MHz
159	5795 MHz

3.2.1 TEST MODE APPLICABILITY AND TESTED CHANNEL DETAIL

EUT CONFIGURE MODE	APPLICABLE TO					DESCRIPTION
	PLC	RE < 1G	RE [≥] 1G	APCM	OB	
-	√	√	√	√	√	-

Where **PLC**: Power Line Conducted Emission **RE < 1G**: Radiated Emission below 1GHz
RE [≥] 1G: Radiated Emission above 1GHz **APCM**: Antenna Port Conducted Measurement
OB: Conducted Out-Band Emission Measurement

NOTE: 1.For 2.4GHz : The EUT had been pre-tested on the positioned of each 2 axis. The worst case was found when positioned on **X-plane**.
2.For 5GHz : The EUT antenna had been pre-tested on the positioned of each 2 axis. The worst case was found when positioned on **X-plane** (for below 1GHz) and **Y-plane** (for above 1GHz).

POWER LINE CONDUCTED EMISSION TEST:

- Pre-Scan has been conducted to determine the worst-case mode from all possible combinations between available modulations, data rates and antenna ports (if EUT with antenna diversity architecture).
- Following channel(s) was (were) selected for the final test as listed below.

MODE	AVAILABLE CHANNEL	TESTED CHANNEL	MODULATION TECHNOLOGY	MODULATION TYPE	DATA RATE (Mbps)
802.11g / 2Tx	1 to 11	6	OFDM	BPSK	6
802.11a / 3Tx	149 to 165	149	OFDM	BPSK	6

RADIATED EMISSION TEST (BELOW 1 GHz):

- Pre-Scan has been conducted to determine the worst-case mode from all possible combinations between available modulations, data rates and antenna ports (if EUT with antenna diversity architecture).
- Following channel(s) was (were) selected for the final test as listed below.

MODE	AVAILABLE CHANNEL	TESTED CHANNEL	MODULATION TECHNOLOGY	MODULATION TYPE	DATA RATE (Mbps)
802.11g / 2Tx	1 to 11	6	OFDM	BPSK	6
802.11a / 3Tx	149 to 165	149	OFDM	BPSK	6



A D T

RADIATED EMISSION TEST (ABOVE 1 GHz):

- Pre-Scan has been conducted to determine the worst-case mode from all possible combinations between available modulations, data rates and antenna ports (if EUT with antenna diversity architecture).
- Following channel(s) was (were) selected for the final test as listed below.

MODE	AVAILABLE CHANNEL	TESTED CHANNEL	MODULATION TECHNOLOGY	MODULATION TYPE	DATA RATE (Mbps)
802.11b / 1Tx	1 to 11	1, 6, 11	DSSS	DBPSK	1
802.11g / 1Tx	1 to 11	1, 6, 11	OFDM	BPSK	6
For 2.4 GHz 802.11n (HT20) / 1Tx	1 to 11	1, 6, 11	OFDM	BPSK	6.5
For 2.4 GHz 802.11n (HT40) / 1Tx	3 to 9	3, 6, 9	OFDM	BPSK	13.5
802.11g / 2Tx	1 to 11	1, 6, 11	OFDM	BPSK	6
For 2.4 GHz 802.11n (HT20) / 2Tx	1 to 11	1, 6, 11	OFDM	BPSK	6.5
For 2.4 GHz 802.11n (HT40) / 2Tx	3 to 9	3, 6, 9	OFDM	BPSK	13.5
802.11a / 1Tx	149 to 165	149, 157, 165	OFDM	BPSK	6
For 5 GHz 802.11n (HT20) / 1Tx	149 to 165	149, 157, 165	OFDM	BPSK	6.5
For 5 GHz 802.11n (HT40) / 1Tx	151 to 159	151, 159	OFDM	BPSK	13.5
For 5 GHz 802.11n (HT20) / 2Tx	149 to 165	149, 157, 165	OFDM	BPSK	13
For 5 GHz 802.11n (HT40) / 2Tx	151 to 159	151, 159	OFDM	BPSK	27
802.11a / 3Tx	149 to 165	149, 157, 165	OFDM	BPSK	6
For 5 GHz 802.11n (HT20) / 3Tx	149 to 165	149, 157, 165	OFDM	BPSK	6.5
For 5 GHz 802.11n (HT40) / 3Tx	151 to 159	151, 159	OFDM	BPSK	13.5

ANTENNA PORT CONDUCTED MEASUREMENT:

- Pre-Scan has been conducted to determine the worst-case mode from all possible combinations between available modulations, data rates and antenna ports (if EUT with antenna diversity architecture).
- Following channel(s) was (were) selected for the final test as listed below.

MODE	AVAILABLE CHANNEL	TESTED CHANNEL	MODULATION TECHNOLOGY	MODULATION TYPE	DATA RATE (Mbps)
802.11b / 1Tx	1 to 11	1, 6, 11	DSSS	DBPSK	1
802.11g / 1Tx	1 to 11	1, 6, 11	OFDM	BPSK	6
For 2.4 GHz 802.11n (HT20) / 1Tx	1 to 11	1, 6, 11	OFDM	BPSK	6.5
For 2.4 GHz 802.11n (HT40) / 1Tx	3 to 9	3, 6, 9	OFDM	BPSK	13.5
802.11g / 2Tx	1 to 11	1, 6, 11	OFDM	BPSK	6
For 2.4 GHz 802.11n (HT20) / 2Tx	1 to 11	1, 6, 11	OFDM	BPSK	6.5
For 2.4 GHz 802.11n (HT40) / 2Tx	3 to 9	3, 6, 9	OFDM	BPSK	13.5
802.11a / 1Tx	149 to 165	149, 157, 165	OFDM	BPSK	6
For 5 GHz 802.11n (HT20) / 1Tx	149 to 165	149, 157, 165	OFDM	BPSK	6.5
For 5 GHz 802.11n (HT40) / 1Tx	151 to 159	151, 159	OFDM	BPSK	13.5
For 5 GHz 802.11n (HT20) / 2Tx	149 to 165	149, 157, 165	OFDM	BPSK	13
For 5 GHz 802.11n (HT40) / 2Tx	151 to 159	151, 159	OFDM	BPSK	27
802.11a / 3Tx	149 to 165	149, 157, 165	OFDM	BPSK	6
For 5 GHz 802.11n (HT20) / 3Tx	149 to 165	149, 157, 165	OFDM	BPSK	6.5
For 5 GHz 802.11n (HT40) / 3Tx	151 to 159	151, 159	OFDM	BPSK	13.5



CONDUCTED OUT-BAND EMISSION MEASUREMENT:

- Pre-Scan has been conducted to determine the worst-case mode from all possible combinations between available modulations, data rates and antenna ports (if EUT with antenna diversity architecture).
- Following channel(s) was (were) selected for the final test as listed below.

MODE	AVAILABLE CHANNEL	TESTED CHANNEL	MODULATION TECHNOLOGY	MODULATION TYPE	DATA RATE (Mbps)
802.11b / 1Tx	1 to 11	1, 6, 11	DSSS	DBPSK	1
802.11g / 1Tx	1 to 11	1, 6, 11	OFDM	BPSK	6
For 2.4 GHz 802.11n (HT20) / 1Tx	1 to 11	1, 6, 11	OFDM	BPSK	6.5
For 2.4 GHz 802.11n (HT40) / 1Tx	3 to 9	3, 6, 9	OFDM	BPSK	13.5
802.11g / 2Tx	1 to 11	1, 6, 11	OFDM	BPSK	6
For 2.4 GHz 802.11n (HT20) / 2Tx	1 to 11	1, 6, 11	OFDM	BPSK	6.5
For 2.4 GHz 802.11n (HT40) / 2Tx	3 to 9	3, 6, 9	OFDM	BPSK	13.5
802.11a / 1Tx	149 to 165	149, 157, 165	OFDM	BPSK	6
For 5 GHz 802.11n (HT20) / 1Tx	149 to 165	149, 157, 165	OFDM	BPSK	6.5
For 5 GHz 802.11n (HT40) / 1Tx	151 to 159	151, 159	OFDM	BPSK	13.5
For 5 GHz 802.11n (HT20) / 2Tx	149 to 165	149, 157, 165	OFDM	BPSK	13
For 5 GHz 802.11n (HT40) / 2Tx	151 to 159	151, 159	OFDM	BPSK	27
802.11a / 3Tx	149 to 165	149, 157, 165	OFDM	BPSK	6
For 5 GHz 802.11n (HT20) / 3Tx	149 to 165	149, 157, 165	OFDM	BPSK	6.5
For 5 GHz 802.11n (HT40) / 3Tx	151 to 159	151, 159	OFDM	BPSK	13.5

TEST CONDITION:

APPLICABLE TO	ENVIRONMENTAL CONDITIONS	INPUT POWER	TESTED BY
PLC	19deg. C, 62%RH	120Vac, 60Hz	Sean Huang
RE<1G	22deg. C, 67%RH	120Vac, 60Hz	Andy Ho
RE ³ 1G	23deg. C, 68%RH	120Vac, 60Hz	Andy Ho
	21deg. C, 68%RH	120Vac, 60Hz	Andy Ho
APCM	25deg. C, 60%RH	120Vac, 60Hz	Chilin Lee
OB	25deg. C, 60%RH	120Vac, 60Hz	Chilin Lee

3.3 GENERAL DESCRIPTION OF APPLIED STANDARDS

The EUT is a RF product. According to the specifications of the manufacturer, it must comply with the requirements of the following standards:

FCC Part 15, Subpart C(15.247)

558074 D01 DTS Meas Guidance v03r01

662911 D01 Multiple Transmitter Output v02r01

ANSI C63.10-2009

All test items have been performed and recorded as per the above standards.

Note: The EUT has been verified to comply with the requirements of FCC Part 15, Subpart B, Class B (DoC). The test report has been issued separately.



A D T

3.4 DUTY CYCLE OF TEST SIGNAL

Duty cycle of test signal is $\geq 98\%$, duty factor is not required.

For 1Tx

802.11b: Duty cycle = $12.395 \text{ ms} / 12.435 \text{ ms} = 0.997$

802.11g: Duty cycle = $2.064 \text{ ms} / 2.083 \text{ ms} = 0.991$

802.11n (HT20): Duty cycle = $1.906 \text{ ms} / 1.926 \text{ ms} = 0.99$

802.11n (HT40): Duty cycle = $0.931 \text{ ms} / 0.95 \text{ ms} = 0.98$

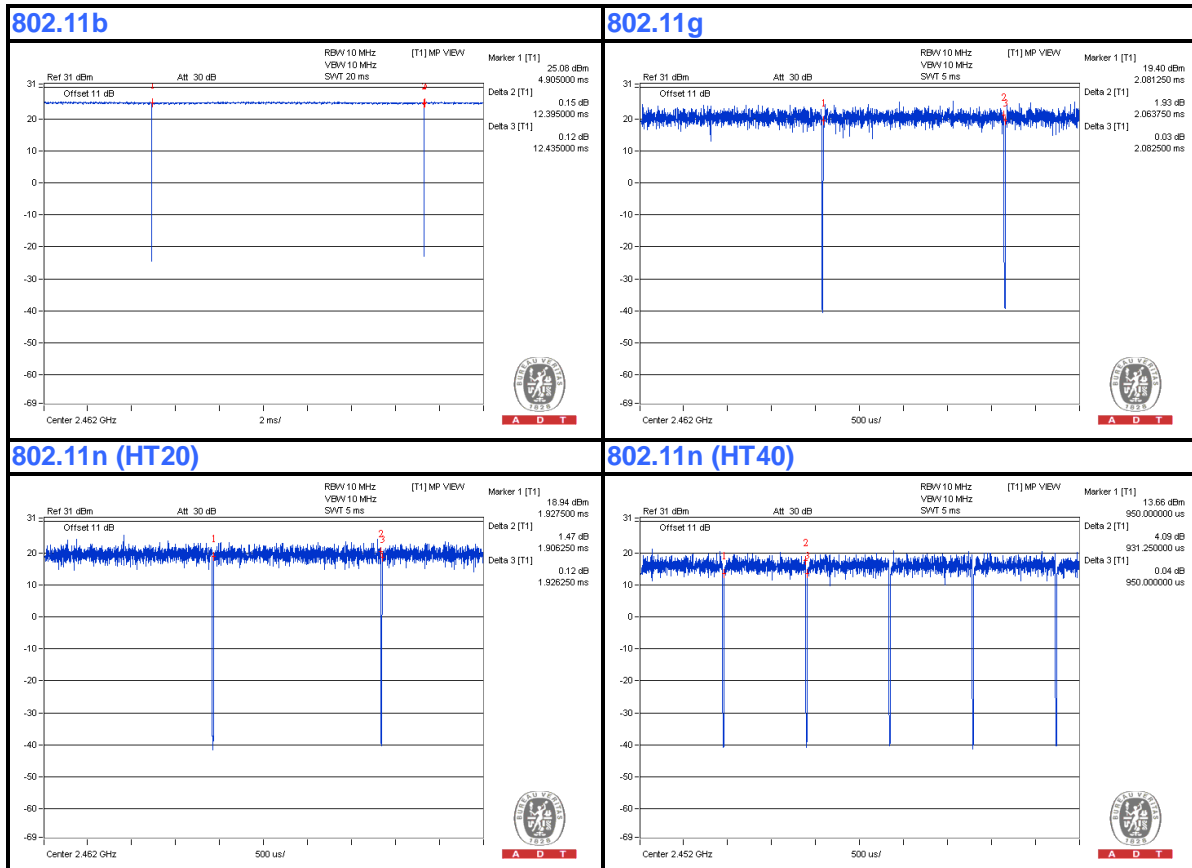



A D T

Duty cycle of test signal is $\geq 98\%$, duty factor is not required.

For 2Tx

802.11g: Duty cycle = 2.06 ms/2.081 ms = 0.99

802.11n (HT20): Duty cycle = 1.907 ms/1.929 ms = 0.989

802.11n (HT40): Duty cycle = 0.93 ms/0.949 ms = 0.98





A D T

Duty cycle of test signal is $\geq 98\%$, duty factor is not required.

For 1Tx

802.11a: Duty cycle = $2.06 \text{ ms} / 2.079 \text{ ms} = 0.991$

802.11n (HT20): Duty cycle = $1.917 \text{ ms} / 1.939 \text{ ms} = 0.989$

802.11n (HT40): Duty cycle = $0.942 \text{ ms} / 0.961 \text{ ms} = 0.98$





A D T

Duty cycle of test signal is $\geq 98\%$, duty factor is not required.

For 2Tx

802.11n (HT20): Duty cycle = $0.979 \text{ ms} / 0.999 \text{ ms} = 0.98$

802.11n (HT40): Duty cycle = $0.502 \text{ ms} / 0.512 \text{ ms} = 0.98$

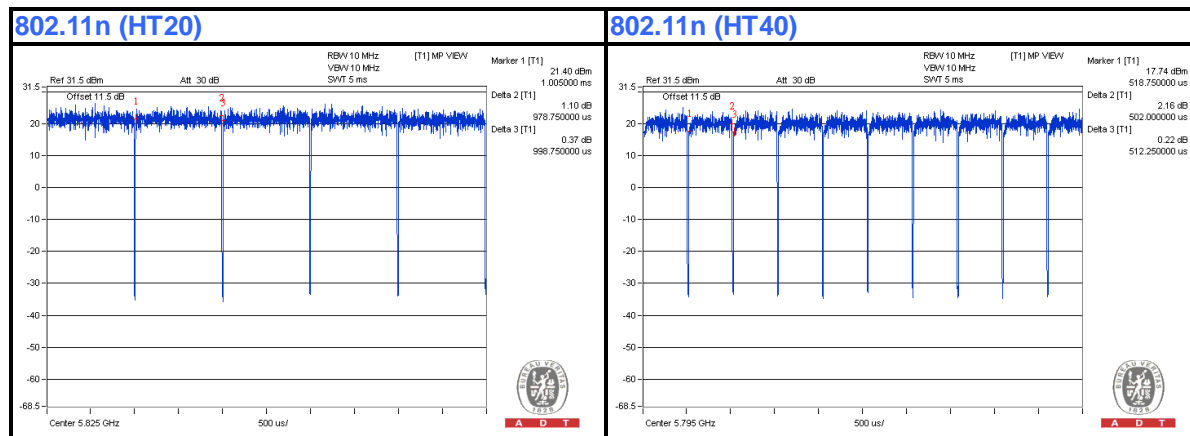



A D T

Duty cycle of test signal is $\geq 98\%$, duty factor is not required.

For 3Tx

802.11a: Duty cycle = 2.057 ms/2.08 ms = 0.989

802.11n (HT20): Duty cycle = 1.919 ms/1.942 ms = 0.988

802.11n (HT40): Duty cycle = 0.951 ms/0.969 ms = 0.981

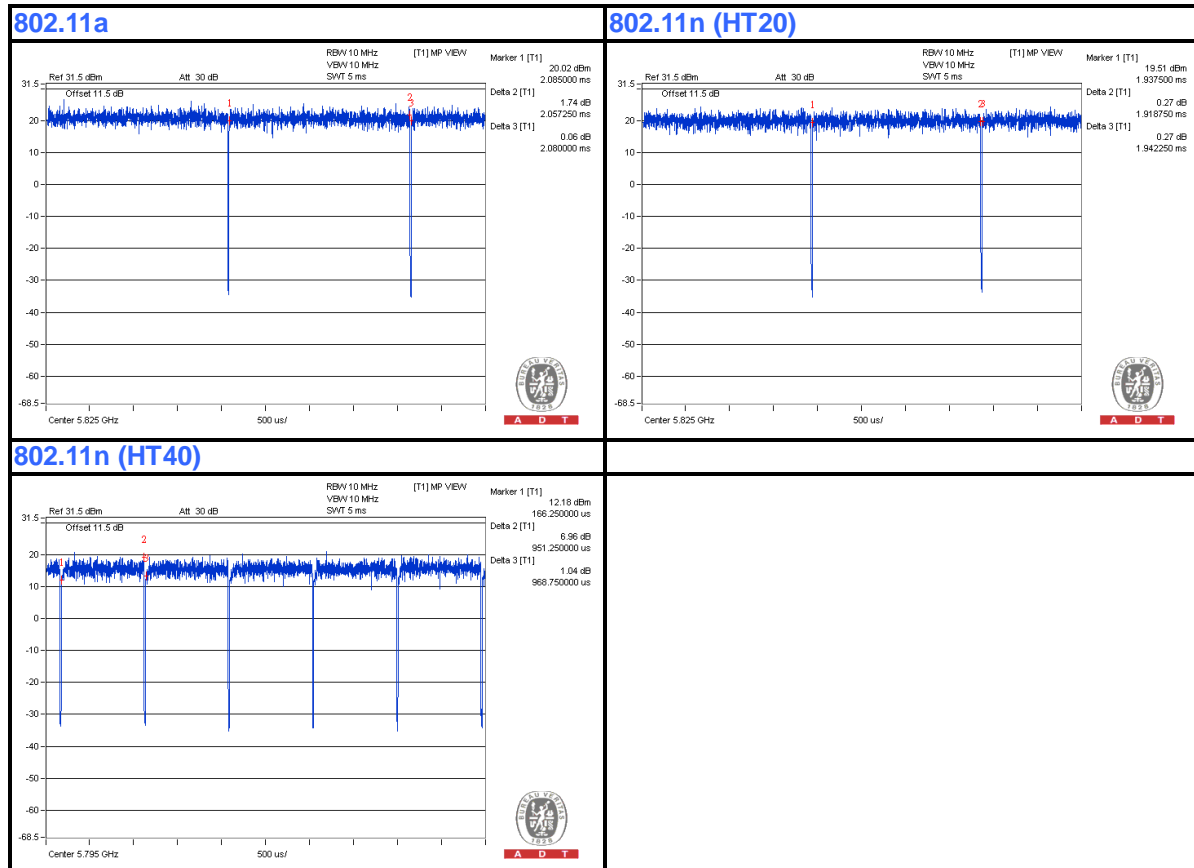



A D T

3.5 DESCRIPTION OF SUPPORT UNITS

The EUT has been tested as an independent unit together with other necessary accessories or support units. The following support units or accessories were used to form a representative test configuration during the tests.

NO.	PRODUCT	BRAND	MODEL NO.	SERIAL NO.	FCC ID
1	NOTEBOOK COMPUTER	DELL	PP32LA	FSLB32S	FCC DoC
2	iPod shuffle	Apple	MC749TA/A	CC4DMFJUDFDM	NA
3	iPod shuffle	Apple	MC749TA/A	CC4DN25WDFDM	NA
4	TELEPHONE	WONDER	WD-303	7C17KA 04011	NA
5	TELEPHONE	WONDER	WD-303	7C17KA 04440	NA
6	HUB	ZyXEL	ES-116P	S060H02000215	FCC DoC

NO.	SIGNAL CABLE DESCRIPTION OF THE ABOVE SUPPORT UNITS
1	UTP Cable, 10m
2	USB Cable, 0.1m
3	USB Cable, 0.1m
4	RJ-11 Cable, 1m
5	RJ-11 Cable, 1m
6	UTP Cable, 10m

NOTE: All power cords of the above support units are non shielded (1.8m).

3.6 CONFIGURATION OF SYSTEM UNDER TEST

For conducted emission test:

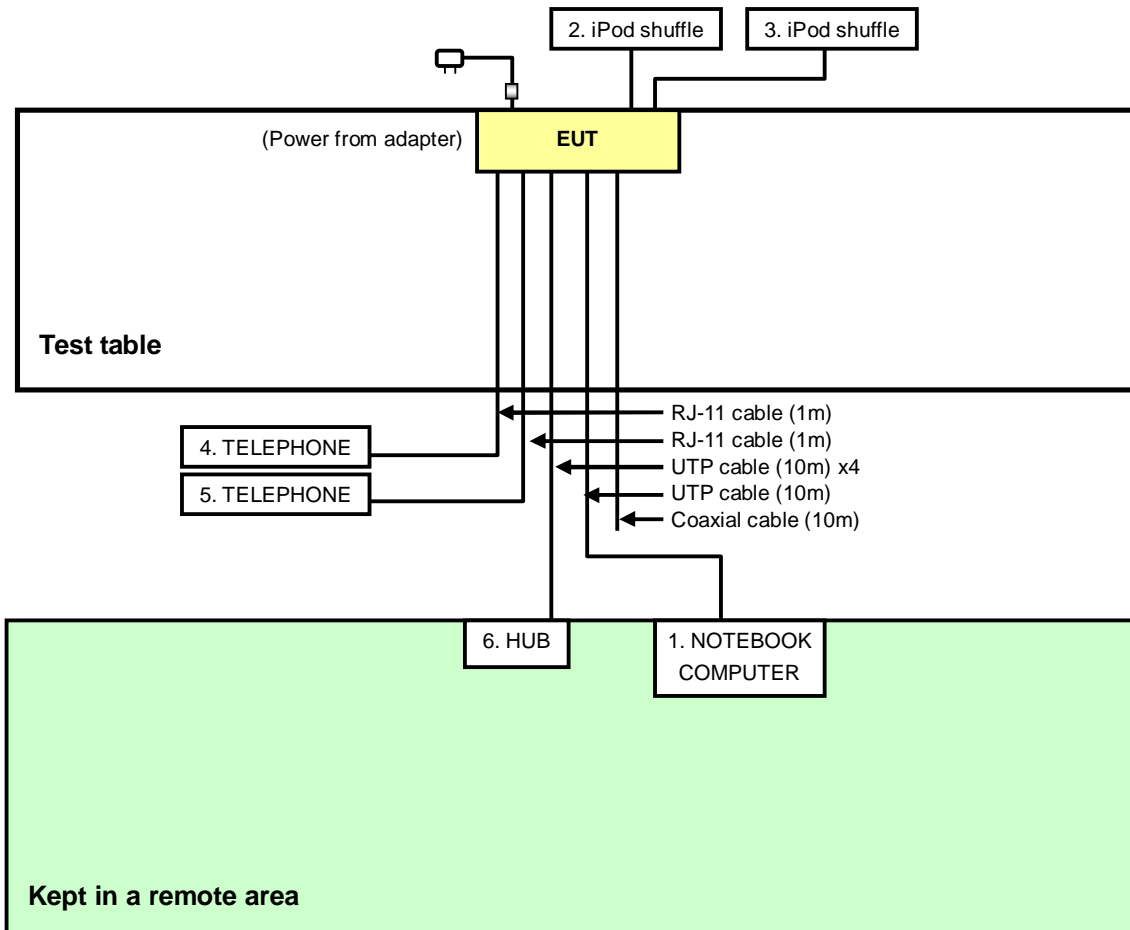

For other test items:

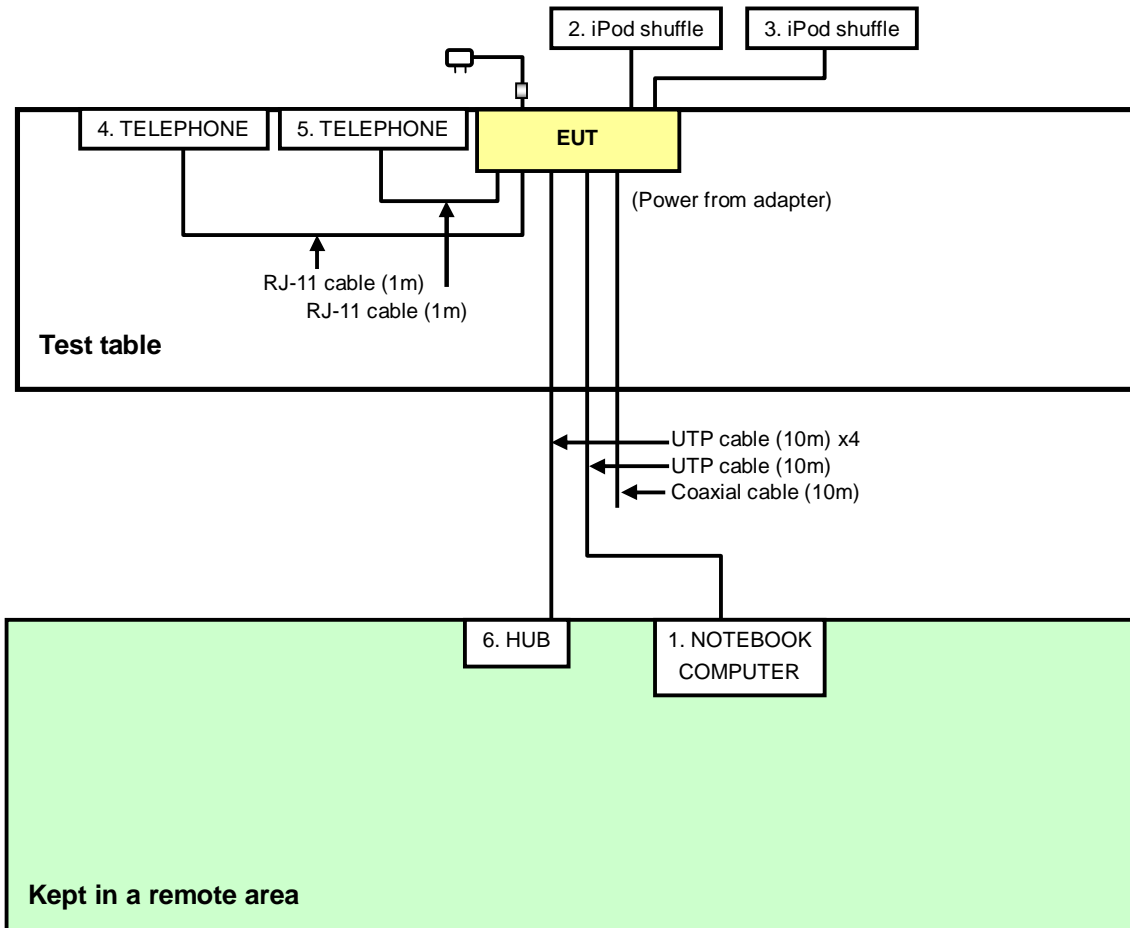

4. TEST TYPES AND RESULTS (FOR 2.4GHz, 2.400 ~ 2.4835GHz Band)

4.1 CONDUCTED EMISSION MEASUREMENT

4.1.1 LIMITS OF CONDUCTED EMISSION MEASUREMENT

FREQUENCY OF EMISSION (MHz)	CONDUCTED LIMIT (dBµV)	
	Quasi-peak	Average
0.15-0.5	66 to 56	56 to 46
0.5-5	56	46
5-30	60	50

- NOTE:**
1. The lower limit shall apply at the transition frequencies.
 2. The limit decreases in line with the logarithm of the frequency in the range of 0.15 to 0.50 MHz.

4.1.2 TEST INSTRUMENTS

DESCRIPTION & MANUFACTURER	MODEL NO.	SERIAL NO.	CALIBRATED DATE	CALIBRATED UNTIL
Test Receiver ROHDE & SCHWARZ	ESCS 30	100375	Mar. 08, 2013	Mar. 07, 2014
Line-Impedance Stabilization Network (for EUT) SCHWARZBECK	NSLK8127	8127-522	Sep. 05, 2013	Sep. 04, 2014
Line-Impedance Stabilization Network (for Peripheral)	ENV216	100072	June 06, 2013	June 05, 2014
RF Cable (JYEBAO)	5DFB	COCCAB-001	Mar. 11, 2013	Mar. 10, 2014
50 ohms Terminator	50	EMC-03	Sep. 24, 2013	Sep. 23, 2014
Software ADT	BV ADT_Cond_V7.3.7. 3	NA	NA	NA

Note:

1. The calibration interval of the above test instruments is 12 months and the calibrations are traceable to NML/ROC and NIST/USA.
2. The test was performed in Shielded Room No. C.
3. The VCCI Con C Registration No. is C-3611.
4. Tested Date: Jan. 27, 2014

4.1.3 TEST PROCEDURES

- a. The EUT was placed 0.4 meters from the conducting wall of the shielded room with EUT being connected to the power mains through a line impedance stabilization network (LISN). Other support units were connected to the power mains through another LISN.
- b. The two LISNs provide 50 ohm/ 50uH of coupling impedance for the measuring instrument.
- c. Both lines of the power mains connected to the EUT were checked for maximum conducted interference.
- d. The frequency range from 150kHz to 30MHz was searched. Emission levels under (Limit - 20dB) were not recorded.

NOTE:

1. The resolution bandwidth of test receiver is 9kHz for Quasi-peak detection (QP) & Average detection (AV).

4.1.4 DEVIATION FROM TEST STANDARD

No deviation

4.1.5 TEST SETUP

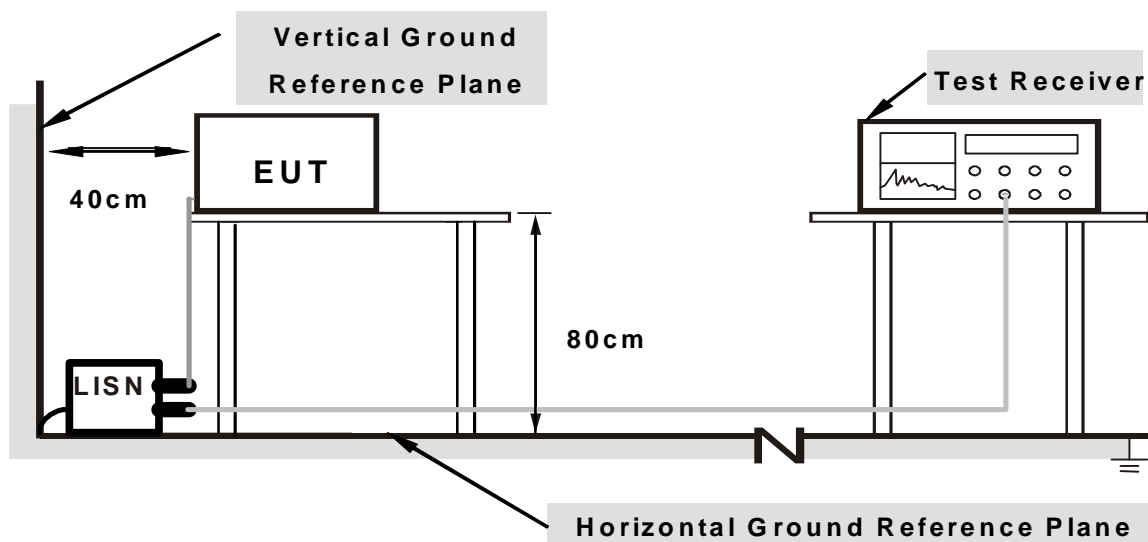

Note: 1.Support units were connected to second LISN.

For the actual test configuration, please refer to the related item – Photographs of the Test Configuration.



A D T

4.1.6 EUT OPERATING CONDITIONS

1. Place the EUT on testing table.
2. Prepare computer system (support unit 1) to act as communication partner.
3. The communication partner runs test program "Mtool 2.0.1.0" to enable EUT under transmission/receiving condition continuously at specific channel frequency.

4.1.7 TEST RESULTS

PHASE	Line (L)	DETECTOR FUNCTION	Quasi-Peak (QP) / Average (AV)
--------------	----------	--------------------------	--------------------------------

No	Freq. [MHz]	Corr. Factor (dB)	Reading Value [dB (uV)]		Emission Level [dB (uV)]		Limit [dB (uV)]		Margin (dB)	
			Q.P.	AV.	Q.P.	AV.	Q.P.	AV.	Q.P.	AV.
			1	0.16172	0.08	47.08	26.49	47.16	26.57	65.38
2	0.19297	0.10	42.69	29.84	42.79	29.94	63.91	53.91	-21.12	-23.97
3	0.24375	0.11	37.48	22.66	37.59	22.77	61.97	51.97	-24.38	-29.20
4	0.28672	0.12	33.81	21.71	33.93	21.83	60.62	50.62	-26.69	-28.79
5	7.76953	0.40	26.98	22.88	27.38	23.28	60.00	50.00	-32.62	-26.72
6	8.67578	0.43	26.97	22.12	27.40	22.55	60.00	50.00	-32.60	-27.45

REMARKS:

1. Q.P. and AV. are abbreviations of quasi-peak and average individually.
2. The emission levels of other frequencies were very low against the limit.
3. Margin value = Emission Level – Limit value
4. Correction Factor = Insertion loss + Cable loss
5. Emission Level = Correction Factor + Reading Value

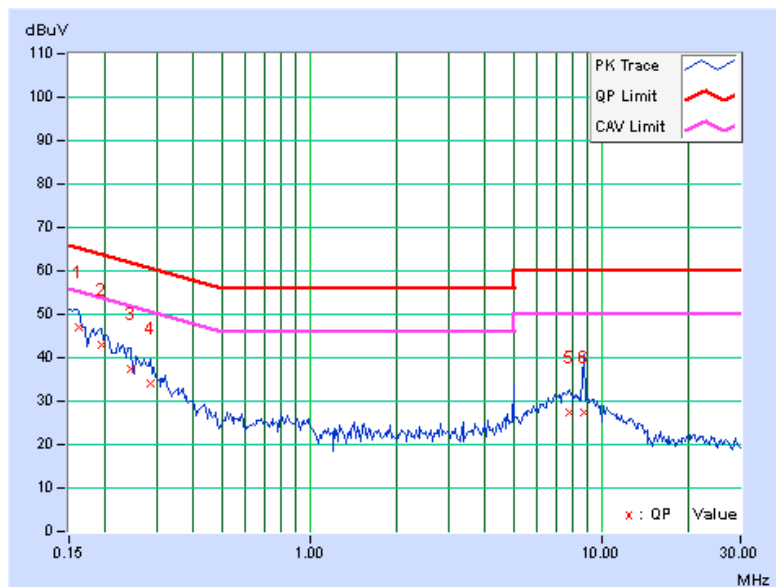



A D T

PHASE	Neutral (N)	DETECTOR FUNCTION	Quasi-Peak (QP) / Average (AV)
--------------	-------------	--------------------------	--------------------------------

No	Freq. [MHz]	Corr. Factor (dB)	Reading Value [dB (uV)]		Emission Level [dB (uV)]		Limit [dB (uV)]		Margin (dB)	
			Q.P.	AV.	Q.P.	AV.	Q.P.	AV.	Q.P.	AV.
1	0.15781	0.09	47.95	35.86	48.04	35.95	65.58	55.58	-17.54	-19.63
2	0.18516	0.10	42.77	31.23	42.87	31.33	64.25	54.25	-21.38	-22.92
3	0.22031	0.10	39.33	24.30	39.43	24.40	62.81	52.81	-23.37	-28.40
4	0.24375	0.11	39.00	25.54	39.11	25.65	61.97	51.97	-22.86	-26.32
5	0.78672	0.16	19.89	14.96	20.05	15.12	56.00	46.00	-35.95	-30.88
6	8.79688	0.43	26.99	22.68	27.42	23.11	60.00	50.00	-32.58	-26.89

REMARKS:

1. Q.P. and AV. are abbreviations of quasi-peak and average individually.
2. The emission levels of other frequencies were very low against the limit.
3. Margin value = Emission Level – Limit value
4. Correction Factor = Insertion loss + Cable loss
5. Emission Level = Correction Factor + Reading Value

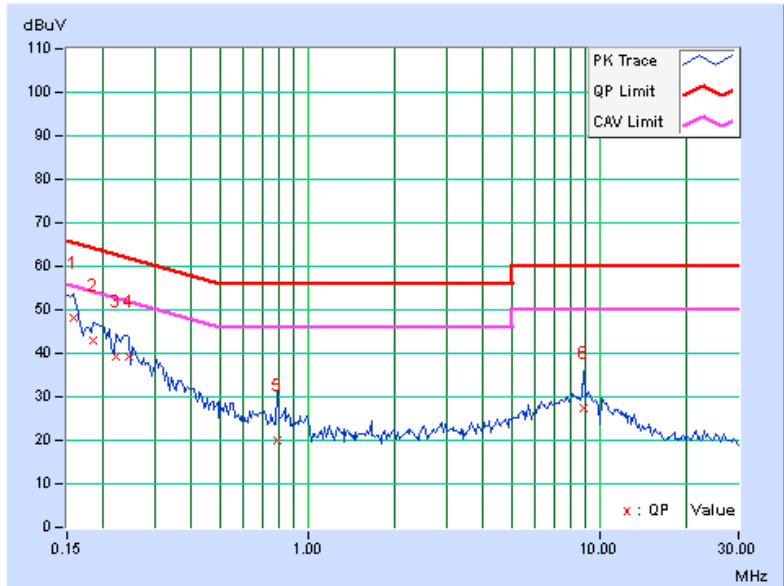

4.2 RADIATED EMISSION AND BANDEGE MEASUREMENT

4.2.1 LIMITS OF RADIATED EMISSION AND BANDEGE MEASUREMENT

Radiated emissions which fall in the restricted bands must comply with the radiated emission limits specified as below table. Other emissions shall be at least 30dB below the highest level of the desired power:

Frequencies (MHz)	Field strength (microvolts/meter)	Measurement distance (meters)
0.009-0.490	2400/F(kHz)	300
0.490-1.705	24000/F(kHz)	30
1.705-30.0	30	30
30-88	100	3
88-216	150	3
216-960	200	3
Above 960	500	3

NOTE:

1. The lower limit shall apply at the transition frequencies.
2. Emission level (dBuV/m) = 20 log Emission level (uV/m).
3. For frequencies above 1000MHz, the field strength limits are based on average detector, however, the peak field strength of any emission shall not exceed the maximum permitted average limits, specified above by more than 20dB under any condition of modulation.



A D T

4.2.2 TEST INSTRUMENTS

DESCRIPTION & MANUFACTURER	MODEL NO.	SERIAL NO.	CALIBRATED DATE	CALIBRATED UNTIL
MXE EMI Receiver Agilent	N9038A	MY50010156	Jan. 15, 2014	Jan. 14, 2015
Pre-Amplifier Mini-Circuits	ZFL-1000VH2 B	AMP-ZFL-04	Nov. 13, 2013	Nov. 12, 2014
Trilog Broadband Antenna SCHWARZBECK	VULB 9168	9168-361	Mar. 25, 2013	Mar. 24, 2014
RF Cable	NA	CHHCAB_001	Oct. 06, 2013	Oct. 05, 2014
Spectrum Analyzer R&S	FSV40	100964	July 15, 2013	July 14, 2014
Horn_Antenna AISI	AIH.8018	0000220091110	Dec. 06, 2013	Dec. 05, 2014
Pre-Amplifier Agilent	8449B	3008A01923	Oct. 29, 2013	Oct. 28, 2014
RF Cable	NA	RF104-205 RF104-207 RF104-202	Dec. 12, 2013	Dec. 11, 2014
Spectrum Analyzer Agilent	E4446A	MY48250253	Aug. 28, 2013	Aug. 27, 2014
Pre-Amplifier SPACEK LABS	SLKka-48-6	9K16	Nov. 13, 2013	Nov. 12, 2014
Horn_Antenna SCHWARZBECK	BBHA 9170	9170-424	Oct. 08, 2013	Oct. 07, 2014
Software	ADT_Radiated _V8.7.07	NA	NA	NA
Antenna Tower & Turn Table CT	NA	NA	NA	NA

Note:

1. The calibration interval of the above test instruments is 12 months and the calibrations are traceable to NML/ROC and NIST/USA.
2. The horn antenna, preamplifier (model: 8449B) are used only for the measurement of emission frequency above 1GHz if tested.
- 3 The test was performed in 966 Chamber No. H.
4. The FCC Site Registration No. is 797305.
- 5 The CANADA Site Registration No. is IC 7450H-3.
- 6 Tested Date: Feb. 24 to 26, 2014

4.2.3 TEST PROCEDURES

- a. The EUT was placed on the top of a rotating table 0.8 meters above the ground at 3 meter chamber room for test. The table was rotated 360 degrees to determine the position of the highest radiation.
- b. The EUT was set 3 meters away from the interference-receiving antenna, which was mounted on the top of a variable-height antenna tower.
- c. The height of antenna is varied from one meter to four meters above the ground to determine the maximum value of the field strength. Both horizontal and vertical polarizations of the antenna are set to make the measurement.
- d. For each suspected emission, the EUT was arranged to its worst case and then the antenna was tuned to heights from 1 meter to 4 meters and the rotatable table was turned from 0 degrees to 360 degrees to find the maximum reading.
- e. The test-receiver system was set to quasi-peak detect function and specified bandwidth with maximum hold mode when the test frequency is below 1 GHz.
- f. The test-receiver system was set to peak and average detect function and specified bandwidth with maximum hold mode when the test frequency is above 1 GHz. If the peak reading value also meets average limit, measurement with the average detector is unnecessary.

NOTE:

1. The resolution bandwidth and video bandwidth of test receiver/spectrum analyzer is 120kHz for Quasi-peak detection (QP) at frequency below 1GHz.
2. The resolution bandwidth of test receiver/spectrum analyzer is 1 MHz and the video bandwidth is 3 MHz for Peak detection (PK) at frequency above 1GHz.
3. The resolution bandwidth of test receiver/spectrum analyzer is 1MHz and the video bandwidth is 3MHz for RMS Average (Duty cycle < 98%) for Average detection (AV) at frequency above 1GHz, then the measurement results was added to a correction factor ($10 \log(1/\text{duty cycle})$).
4. The resolution bandwidth of test receiver/spectrum analyzer is 1MHz and the video bandwidth is 10Hz (Duty cycle $\geq 98\%$) for Average detection (AV) at frequency above 1GHz.
5. All modes of operation were investigated and the worst-case emissions are reported.

4.2.4 DEVIATION FROM TEST STANDARD

No deviation

4.2.5 TEST SETUP

<Frequency Range below 1GHz>

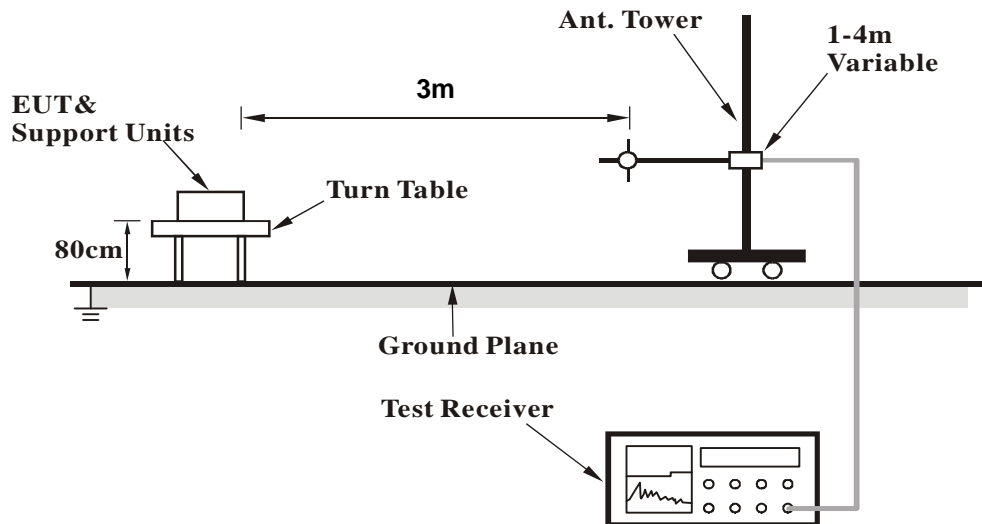

<Frequency Range above 1GHz>

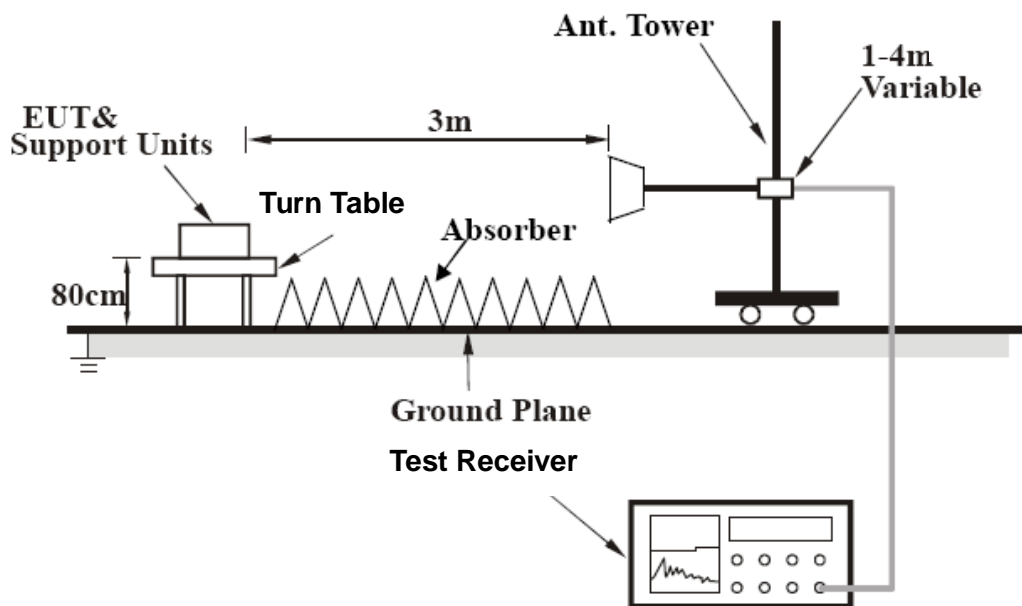

For the actual test configuration, please refer to the related item – Photographs of the Test Configuration.

4.2.6 EUT OPERATING CONDITIONS

Same as 4.1.6

4.2.7 TEST RESULTS

BELOW 1GHz WORST-CASE DATA

802.11g, 2Tx

CHANNEL	TX Channel 6	DETECTOR FUNCTION	Quasi-Peak (QP)
FREQUENCY RANGE	Below 1GHz		

ANTENNA POLARITY & TEST DISTANCE: HORIZONTAL AT 3 M								
NO.	FREQ. (MHz)	EMISSION LEVEL (dBuV/m)	LIMIT (dBuV/m)	MARGIN (dB)	ANTENNA HEIGHT (m)	TABLE ANGLE (Degree)	RAW VALUE (dBuV)	CORRECTION FACTOR (dB/m)
1	250.00	42.9 QP	46.0	-3.2	1.30 H	136	56.52	-13.67
2	400.01	42.3 QP	46.0	-3.7	1.00 H	354	51.62	-9.36
3	440.02	40.4 QP	46.0	-5.7	2.00 H	170	48.16	-7.81
4	460.00	40.7 QP	46.0	-5.3	2.00 H	240	48.26	-7.60
5	500.01	41.0 QP	46.0	-5.0	2.00 H	0	47.94	-6.91
6	750.03	40.7 QP	46.0	-5.3	2.00 H	86	42.42	-1.68
ANTENNA POLARITY & TEST DISTANCE: VERTICAL AT 3 M								
NO.	FREQ. (MHz)	EMISSION LEVEL (dBuV/m)	LIMIT (dBuV/m)	MARGIN (dB)	ANTENNA HEIGHT (m)	TABLE ANGLE (Degree)	RAW VALUE (dBuV)	CORRECTION FACTOR (dB/m)
1	250.00	40.7 QP	46.0	-5.3	2.00 V	360	54.35	-13.67
2	319.98	37.7 QP	46.0	-8.3	1.00 V	57	48.55	-10.86
3	400.01	37.5 QP	46.0	-8.5	2.00 V	86	46.86	-9.36
4	599.97	38.2 QP	46.0	-7.8	1.50 V	88	42.80	-4.63
5	750.03	38.9 QP	46.0	-7.1	1.50 V	29	40.57	-1.68
6	799.99	37.2 QP	46.0	-8.8	1.00 V	360	38.13	-0.97

REMARKS:

1. Emission Level(dBuV/m) = Raw Value(dBuV) + Correction Factor(dB/m)
2. Correction Factor(dB/m) = Antenna Factor(dB/m) + Cable Factor(dB) – Pre-Amplifier Factor(dB)
3. The other emission levels were very low against the limit.
4. Margin value = Emission Level – Limit value

ABOVE 1GHz WORST-CASE DATA

802.11b, 1Tx

CHANNEL	TX Channel 1	DETECTOR FUNCTION	Peak (PK)
FREQUENCY RANGE	1GHz ~ 25GHz		Average (AV)

ANTENNA POLARITY & TEST DISTANCE: HORIZONTAL AT 3 M								
NO.	FREQ. (MHz)	EMISSION LEVEL (dBuV/m)	LIMIT (dBuV/m)	MARGIN (dB)	ANTENNA HEIGHT (m)	TABLE ANGLE (Degree)	RAW VALUE (dBuV)	CORRECTION FACTOR (dB/m)
1	2390.00	55.7 PK	74.0	-18.3	1.26 H	114	22.17	33.53
2	2390.00	44.8 AV	54.0	-9.2	1.26 H	114	11.27	33.53
3	*2412.00	109.2 PK			1.26 H	114	75.61	33.59
4	*2412.00	106.2 AV			1.26 H	114	72.61	33.59
5	4824.00	50.9 PK	74.0	-23.1	1.63 H	75	7.72	43.18
6	4824.00	38.2 AV	54.0	-15.8	1.63 H	75	-4.98	43.18
ANTENNA POLARITY & TEST DISTANCE: VERTICAL AT 3 M								
NO.	FREQ. (MHz)	EMISSION LEVEL (dBuV/m)	LIMIT (dBuV/m)	MARGIN (dB)	ANTENNA HEIGHT (m)	TABLE ANGLE (Degree)	RAW VALUE (dBuV)	CORRECTION FACTOR (dB/m)
1	2390.00	54.2 PK	74.0	-19.8	1.00 V	334	20.67	33.53
2	2390.00	43.5 AV	54.0	-10.5	1.00 V	334	9.97	33.53
3	*2412.00	107.6 PK			1.00 V	334	74.01	33.59
4	*2412.00	104.4 AV			1.00 V	334	70.81	33.59
5	4824.00	51.0 PK	74.0	-23.0	1.58 V	85	7.82	43.18
6	4824.00	39.0 AV	54.0	-15.0	1.58 V	85	-4.18	43.18

REMARKS:

1. Emission Level(dBuV/m) = Raw Value(dBuV) + Correction Factor(dB/m)
2. Correction Factor(dB/m) = Antenna Factor(dB/m) + Cable Factor(dB) – Pre-Amplifier Factor(dB)
3. The other emission levels were very low against the limit.
4. Margin value = Emission Level – Limit value
5. " * ": Fundamental frequency.



A D T

CHANNEL	TX Channel 6	DETECTOR FUNCTION	Peak (PK)
FREQUENCY RANGE	1GHz ~ 25GHz		Average (AV)

ANTENNA POLARITY & TEST DISTANCE: HORIZONTAL AT 3 M

NO.	FREQ. (MHz)	EMISSION LEVEL (dBuV/m)	LIMIT (dBuV/m)	MARGIN (dB)	ANTENNA HEIGHT (m)	TABLE ANGLE (Degree)	RAW VALUE (dBuV)	CORRECTION FACTOR (dB/m)
1	*2437.00	110.7 PK			1.24 H	97	77.03	33.67
2	*2437.00	107.7 AV			1.24 H	97	74.03	33.67
3	4874.00	52.8 PK	74.0	-21.2	1.00 H	183	9.56	43.24
4	4874.00	43.2 AV	54.0	-10.8	1.00 H	183	-0.04	43.24
5	7311.00	55.0 PK	74.0	-19.0	1.02 H	144	6.93	48.07
6	7311.00	42.0 AV	54.0	-12.0	1.02 H	144	-6.07	48.07

ANTENNA POLARITY & TEST DISTANCE: VERTICAL AT 3 M

NO.	FREQ. (MHz)	EMISSION LEVEL (dBuV/m)	LIMIT (dBuV/m)	MARGIN (dB)	ANTENNA HEIGHT (m)	TABLE ANGLE (Degree)	RAW VALUE (dBuV)	CORRECTION FACTOR (dB/m)
1	*2437.00	108.5 PK			1.22 V	314	74.83	33.67
2	*2437.00	105.6 AV			1.22 V	314	71.93	33.67
3	4874.00	52.6 PK	74.0	-21.4	1.90 V	221	9.36	43.24
4	4874.00	43.2 AV	54.0	-10.8	1.90 V	221	-0.04	43.24
5	7311.00	56.1 PK	74.0	-17.9	1.00 V	205	8.03	48.07
6	7311.00	43.1 AV	54.0	-10.9	1.00 V	205	-4.97	48.07

REMARKS:

1. Emission Level(dBuV/m) = Raw Value(dBuV) + Correction Factor(dB/m)
2. Correction Factor(dB/m) = Antenna Factor(dB/m) + Cable Factor(dB) – Pre-Amplifier Factor(dB)
3. The other emission levels were very low against the limit.
4. Margin value = Emission Level – Limit value
5. " * ": Fundamental frequency.



A D T

CHANNEL	TX Channel 11	DETECTOR FUNCTION	Peak (PK)
FREQUENCY RANGE	1GHz ~ 25GHz		Average (AV)

ANTENNA POLARITY & TEST DISTANCE: HORIZONTAL AT 3 M

NO.	FREQ. (MHz)	EMISSION LEVEL (dBuV/m)	LIMIT (dBuV/m)	MARGIN (dB)	ANTENNA HEIGHT (m)	TABLE ANGLE (Degree)	RAW VALUE (dBuV)	CORRECTION FACTOR (dB/m)
1	*2462.00	111.5 PK			1.26 H	98	77.76	33.74
2	*2462.00	108.7 AV			1.26 H	98	74.96	33.74
3	2500.00	61.5 PK	74.0	-12.5	1.26 H	98	27.64	33.86
4	2500.00	49.5 AV	54.0	-4.5	1.26 H	98	15.64	33.86
5	4924.00	53.3 PK	74.0	-20.7	1.00 H	184	10.03	43.27
6	4924.00	46.5 AV	54.0	-7.5	1.00 H	184	3.23	43.27
7	7386.00	56.8 PK	74.0	-17.2	1.00 H	155	8.40	48.40
8	7386.00	43.9 AV	54.0	-10.1	1.00 H	155	-4.50	48.40

ANTENNA POLARITY & TEST DISTANCE: VERTICAL AT 3 M

NO.	FREQ. (MHz)	EMISSION LEVEL (dBuV/m)	LIMIT (dBuV/m)	MARGIN (dB)	ANTENNA HEIGHT (m)	TABLE ANGLE (Degree)	RAW VALUE (dBuV)	CORRECTION FACTOR (dB/m)
1	*2462.00	110.0 PK			1.22 V	319	76.26	33.74
2	*2462.00	106.9 AV			1.22 V	319	73.16	33.74
3	2500.00	60.0 PK	74.0	-14.0	1.22 V	319	26.14	33.86
4	2500.00	48.0 AV	54.0	-6.0	1.22 V	319	14.14	33.86
5	4924.00	54.6 PK	74.0	-19.4	1.00 V	119	11.33	43.27
6	4924.00	49.3 AV	54.0	-4.7	1.00 V	119	6.03	43.27
7	7386.00	56.9 PK	74.0	-17.1	1.00 V	201	8.50	48.40
8	7386.00	44.0 AV	54.0	-10.0	1.00 V	201	-4.40	48.40

REMARKS:

1. Emission Level(dBuV/m) = Raw Value(dBuV) + Correction Factor(dB/m)
2. Correction Factor(dB/m) = Antenna Factor(dB/m) + Cable Factor(dB) – Pre-Amplifier Factor(dB)
3. The other emission levels were very low against the limit.
4. Margin value = Emission Level – Limit value
5. " * ": Fundamental frequency.



A D T

802.11g, 1Tx

CHANNEL	TX Channel 1	DETECTOR FUNCTION	Peak (PK)
FREQUENCY RANGE	1GHz ~ 25GHz		Average (AV)

ANTENNA POLARITY & TEST DISTANCE: HORIZONTAL AT 3 M

NO.	FREQ. (MHz)	EMISSION LEVEL (dBuV/m)	LIMIT (dBuV/m)	MARGIN (dB)	ANTENNA HEIGHT (m)	TABLE ANGLE (Degree)	RAW VALUE (dBuV)	CORRECTION FACTOR (dB/m)
1	2390.00	73.3 PK	74.0	-0.7	1.23 H	95	39.77	33.53
2	2390.00	53.3 AV	54.0	-0.7	1.23 H	95	19.77	33.53
3	*2412.00	109.0 PK			1.23 H	95	75.41	33.59
4	*2412.00	99.1 AV			1.23 H	95	65.51	33.59
5	4824.00	50.9 PK	74.0	-23.1	1.54 H	75	7.72	43.18
6	4824.00	38.1 AV	54.0	-15.9	1.54 H	75	-5.08	43.18

ANTENNA POLARITY & TEST DISTANCE: VERTICAL AT 3 M

NO.	FREQ. (MHz)	EMISSION LEVEL (dBuV/m)	LIMIT (dBuV/m)	MARGIN (dB)	ANTENNA HEIGHT (m)	TABLE ANGLE (Degree)	RAW VALUE (dBuV)	CORRECTION FACTOR (dB/m)
1	2390.00	71.4 PK	74.0	-2.6	1.26 V	308	37.87	33.53
2	2390.00	51.4 AV	54.0	-2.6	1.26 V	308	17.87	33.53
3	*2412.00	106.4 PK			1.26 V	308	72.81	33.59
4	*2412.00	96.7 AV			1.26 V	308	63.11	33.59
5	4824.00	52.4 PK	74.0	-21.6	1.10 V	99	9.22	43.18
6	4824.00	38.7 AV	54.0	-15.3	1.10 V	99	-4.48	43.18

REMARKS:

1. Emission Level(dBuV/m) = Raw Value(dBuV) + Correction Factor(dB/m)
2. Correction Factor(dB/m) = Antenna Factor(dB/m) + Cable Factor(dB) – Pre-Amplifier Factor(dB)
3. The other emission levels were very low against the limit.
4. Margin value = Emission Level – Limit value
5. " * ": Fundamental frequency.



A D T

CHANNEL	TX Channel 6	DETECTOR FUNCTION	Peak (PK)
FREQUENCY RANGE	1GHz ~ 25GHz		Average (AV)

ANTENNA POLARITY & TEST DISTANCE: HORIZONTAL AT 3 M

NO.	FREQ. (MHz)	EMISSION LEVEL (dBuV/m)	LIMIT (dBuV/m)	MARGIN (dB)	ANTENNA HEIGHT (m)	TABLE ANGLE (Degree)	RAW VALUE (dBuV)	CORRECTION FACTOR (dB/m)
1	*2437.00	111.8 PK			1.27 H	94	78.13	33.67
2	*2437.00	101.2 AV			1.27 H	94	67.53	33.67
3	4874.00	52.0 PK	74.0	-22.0	1.21 H	180	8.76	43.24
4	4874.00	38.3 AV	54.0	-15.7	1.21 H	180	-4.94	43.24
5	7311.00	56.1 PK	74.0	-17.9	1.11 H	146	8.03	48.07
6	7311.00	43.1 AV	54.0	-10.9	1.11 H	146	-4.97	48.07

ANTENNA POLARITY & TEST DISTANCE: VERTICAL AT 3 M

NO.	FREQ. (MHz)	EMISSION LEVEL (dBuV/m)	LIMIT (dBuV/m)	MARGIN (dB)	ANTENNA HEIGHT (m)	TABLE ANGLE (Degree)	RAW VALUE (dBuV)	CORRECTION FACTOR (dB/m)
1	*2437.00	110.0 PK			1.17 V	311	76.33	33.67
2	*2437.00	99.7 AV			1.17 V	311	66.03	33.67
3	4874.00	52.3 PK	74.0	-21.7	1.11 V	122	9.06	43.24
4	4874.00	38.5 AV	54.0	-15.5	1.11 V	122	-4.74	43.24
5	7311.00	56.3 PK	74.0	-17.7	1.21 V	211	8.23	48.07
6	7311.00	43.2 AV	54.0	-10.8	1.21 V	211	-4.87	48.07

REMARKS:

1. Emission Level(dBuV/m) = Raw Value(dBuV) + Correction Factor(dB/m)
2. Correction Factor(dB/m) = Antenna Factor(dB/m) + Cable Factor(dB) – Pre-Amplifier Factor(dB)
3. The other emission levels were very low against the limit.
4. Margin value = Emission Level – Limit value
5. " * ": Fundamental frequency.



A D T

CHANNEL	TX Channel 11	DETECTOR FUNCTION	Peak (PK)
FREQUENCY RANGE	1GHz ~ 25GHz		Average (AV)

ANTENNA POLARITY & TEST DISTANCE: HORIZONTAL AT 3 M

NO.	FREQ. (MHz)	EMISSION LEVEL (dBuV/m)	LIMIT (dBuV/m)	MARGIN (dB)	ANTENNA HEIGHT (m)	TABLE ANGLE (Degree)	RAW VALUE (dBuV)	CORRECTION FACTOR (dB/m)
1	*2462.00	110.5 PK			1.26 H	87	76.76	33.74
2	*2462.00	99.6 AV			1.26 H	87	65.86	33.74
3	2483.50	72.4 PK	74.0	-1.6	1.26 H	87	38.59	33.81
4	2483.50	51.3 AV	54.0	-2.7	1.26 H	87	17.49	33.81
5	4924.00	52.1 PK	74.0	-21.9	1.24 H	136	8.83	43.27
6	4924.00	38.7 AV	54.0	-15.3	1.24 H	136	-4.57	43.27
7	7386.00	55.9 PK	74.0	-18.1	1.15 H	108	7.50	48.40
8	7386.00	43.0 AV	54.0	-11.0	1.15 H	108	-5.40	48.40

ANTENNA POLARITY & TEST DISTANCE: VERTICAL AT 3 M

NO.	FREQ. (MHz)	EMISSION LEVEL (dBuV/m)	LIMIT (dBuV/m)	MARGIN (dB)	ANTENNA HEIGHT (m)	TABLE ANGLE (Degree)	RAW VALUE (dBuV)	CORRECTION FACTOR (dB/m)
1	*2462.00	108.2 PK			1.25 V	298	74.46	33.74
2	*2462.00	97.1 AV			1.25 V	298	63.36	33.74
3	2483.50	70.4 PK	74.0	-3.6	1.25 V	298	36.59	33.81
4	2483.50	49.4 AV	54.0	-4.6	1.25 V	298	15.59	33.81
5	4924.00	51.9 PK	74.0	-22.1	1.09 V	116	8.63	43.27
6	4924.00	38.2 AV	54.0	-15.8	1.09 V	116	-5.07	43.27
7	7386.00	55.8 PK	74.0	-18.2	1.22 V	201	7.40	48.40
8	7386.00	42.6 AV	54.0	-11.4	1.22 V	201	-5.80	48.40

REMARKS:

1. Emission Level(dBuV/m) = Raw Value(dBuV) + Correction Factor(dB/m)
2. Correction Factor(dB/m) = Antenna Factor(dB/m) + Cable Factor(dB) – Pre-Amplifier Factor(dB)
3. The other emission levels were very low against the limit.
4. Margin value = Emission Level – Limit value
5. " * ": Fundamental frequency.



A D T

802.11n (HT20), 1Tx

CHANNEL	TX Channel 1	DETECTOR FUNCTION	Peak (PK)
FREQUENCY RANGE	1GHz ~ 25GHz		Average (AV)

ANTENNA POLARITY & TEST DISTANCE: HORIZONTAL AT 3 M

NO.	FREQ. (MHz)	EMISSION LEVEL (dBuV/m)	LIMIT (dBuV/m)	MARGIN (dB)	ANTENNA HEIGHT (m)	TABLE ANGLE (Degree)	RAW VALUE (dBuV)	CORRECTION FACTOR (dB/m)
1	2390.00	73.2 PK	74.0	-0.8	1.28 H	90	39.67	33.53
2	2390.00	51.4 AV	54.0	-2.6	1.28 H	90	17.87	33.53
3	*2412.00	108.9 PK			1.28 H	90	75.31	33.59
4	*2412.00	98.3 AV			1.28 H	90	64.71	33.59
5	4824.00	52.2 PK	74.0	-21.8	1.08 H	153	9.02	43.18
6	4824.00	38.4 AV	54.0	-15.6	1.08 H	153	-4.78	43.18

ANTENNA POLARITY & TEST DISTANCE: VERTICAL AT 3 M

NO.	FREQ. (MHz)	EMISSION LEVEL (dBuV/m)	LIMIT (dBuV/m)	MARGIN (dB)	ANTENNA HEIGHT (m)	TABLE ANGLE (Degree)	RAW VALUE (dBuV)	CORRECTION FACTOR (dB/m)
1	2390.00	71.3 PK	74.0	-2.7	1.18 V	300	37.77	33.53
2	2390.00	49.7 AV	54.0	-4.3	1.18 V	300	16.17	33.53
3	*2412.00	106.7 PK			1.18 V	300	73.11	33.59
4	*2412.00	96.2 AV			1.18 V	300	62.61	33.59
5	4824.00	51.7 PK	74.0	-22.3	1.11 V	136	8.52	43.18
6	4824.00	38.2 AV	54.0	-15.8	1.11 V	136	-4.98	43.18

REMARKS:

1. Emission Level(dBuV/m) = Raw Value(dBuV) + Correction Factor(dB/m)
2. Correction Factor(dB/m) = Antenna Factor(dB/m) + Cable Factor(dB) – Pre-Amplifier Factor(dB)
3. The other emission levels were very low against the limit.
4. Margin value = Emission Level – Limit value
5. " * ": Fundamental frequency.



A D T

CHANNEL	TX Channel 6	DETECTOR FUNCTION	Peak (PK)
FREQUENCY RANGE	1GHz ~ 25GHz		Average (AV)

ANTENNA POLARITY & TEST DISTANCE: HORIZONTAL AT 3 M

NO.	FREQ. (MHz)	EMISSION LEVEL (dBuV/m)	LIMIT (dBuV/m)	MARGIN (dB)	ANTENNA HEIGHT (m)	TABLE ANGLE (Degree)	RAW VALUE (dBuV)	CORRECTION FACTOR (dB/m)
1	2390.00	55.0 PK	74.0	-19.0	1.26 H	96	21.47	33.53
2	2390.00	43.0 AV	54.0	-11.0	1.26 H	96	9.47	33.53
3	*2437.00	111.5 PK			1.26 H	96	77.83	33.67
4	*2437.00	101.1 AV			1.26 H	96	67.43	33.67
5	2500.00	57.3 PK	74.0	-16.7	1.26 H	238	23.44	33.86
6	2500.00	49.9 AV	54.0	-4.1	1.26 H	238	16.04	33.86
7	4874.00	51.1 PK	74.0	-22.9	1.14 H	193	7.86	43.24
8	4874.00	37.6 AV	54.0	-16.4	1.14 H	193	-5.64	43.24
9	7311.00	55.8 PK	74.0	-18.2	1.08 H	161	7.73	48.07
10	7311.00	42.7 AV	54.0	-11.3	1.08 H	161	-5.37	48.07

ANTENNA POLARITY & TEST DISTANCE: VERTICAL AT 3 M

NO.	FREQ. (MHz)	EMISSION LEVEL (dBuV/m)	LIMIT (dBuV/m)	MARGIN (dB)	ANTENNA HEIGHT (m)	TABLE ANGLE (Degree)	RAW VALUE (dBuV)	CORRECTION FACTOR (dB/m)
1	2390.00	55.1 PK	74.0	-18.9	1.19 V	221	21.57	33.53
2	2390.00	43.4 AV	54.0	-10.6	1.19 V	221	9.87	33.53
3	*2437.00	109.1 PK			1.12 V	326	75.43	33.67
4	*2437.00	98.9 AV			1.12 V	326	65.23	33.67
5	2500.00	57.2 PK	74.0	-16.8	1.19 V	221	23.34	33.86
6	2500.00	49.6 AV	54.0	-4.4	1.19 V	221	15.74	33.86
7	4874.00	51.9 PK	74.0	-22.1	1.08 V	130	8.66	43.24
8	4874.00	38.3 AV	54.0	-15.7	1.08 V	130	-4.94	43.24
9	7311.00	55.9 PK	74.0	-18.1	1.13 V	192	7.83	48.07
10	7311.00	42.9 AV	54.0	-11.1	1.13 V	192	-5.17	48.07

REMARKS:

1. Emission Level(dBuV/m) = Raw Value(dBuV) + Correction Factor(dB/m)
2. Correction Factor(dB/m) = Antenna Factor(dB/m) + Cable Factor(dB) – Pre-Amplifier Factor(dB)
3. The other emission levels were very low against the limit.
4. Margin value = Emission Level – Limit value
5. " * ": Fundamental frequency.



A D T

CHANNEL	TX Channel 11	DETECTOR FUNCTION	Peak (PK)
FREQUENCY RANGE	1GHz ~ 25GHz		Average (AV)

ANTENNA POLARITY & TEST DISTANCE: HORIZONTAL AT 3 M

NO.	FREQ. (MHz)	EMISSION LEVEL (dBuV/m)	LIMIT (dBuV/m)	MARGIN (dB)	ANTENNA HEIGHT (m)	TABLE ANGLE (Degree)	RAW VALUE (dBuV)	CORRECTION FACTOR (dB/m)
1	*2462.00	109.3 PK			1.27 H	88	75.56	33.74
2	*2462.00	99.2 AV			1.27 H	88	65.46	33.74
3	2483.50	73.1 PK	74.0	-0.9	1.27 H	88	39.29	33.81
4	2483.50	49.9 AV	54.0	-4.1	1.27 H	88	16.09	33.81
5	2500.00	61.0 PK	74.0	-13.0	1.05 H	233	27.14	33.86
6	2500.00	50.3 AV	54.0	-3.7	1.05 H	233	16.44	33.86
7	4924.00	51.4 PK	74.0	-22.6	1.12 H	185	8.13	43.27
8	4924.00	37.8 AV	54.0	-16.2	1.12 H	185	-5.47	43.27
9	7386.00	55.5 PK	74.0	-18.5	1.02 H	134	7.10	48.40
10	7386.00	42.6 AV	54.0	-11.4	1.02 H	134	-5.80	48.40

ANTENNA POLARITY & TEST DISTANCE: VERTICAL AT 3 M

NO.	FREQ. (MHz)	EMISSION LEVEL (dBuV/m)	LIMIT (dBuV/m)	MARGIN (dB)	ANTENNA HEIGHT (m)	TABLE ANGLE (Degree)	RAW VALUE (dBuV)	CORRECTION FACTOR (dB/m)
1	*2462.00	107.4 PK			1.12 V	298	73.66	33.74
2	*2462.00	97.6 AV			1.12 V	298	63.86	33.74
3	2483.50	70.7 PK	74.0	-3.3	1.12 V	298	36.89	33.81
4	2483.50	48.0 AV	54.0	-6.0	1.12 V	298	14.19	33.81
5	2500.00	59.0 PK	74.0	-15.0	1.12 V	298	25.14	33.86
6	2500.00	48.6 AV	54.0	-5.4	1.12 V	298	14.74	33.86
7	4924.00	52.5 PK	74.0	-21.5	1.11 V	127	9.23	43.27
8	4924.00	38.9 AV	54.0	-15.1	1.11 V	127	-4.37	43.27
9	7386.00	56.6 PK	74.0	-17.4	1.19 V	193	8.20	48.40
10	7386.00	43.4 AV	54.0	-10.6	1.19 V	193	-5.00	48.40

REMARKS:

1. Emission Level(dBuV/m) = Raw Value(dBuV) + Correction Factor(dB/m)
2. Correction Factor(dB/m) = Antenna Factor(dB/m) + Cable Factor(dB) – Pre-Amplifier Factor(dB)
3. The other emission levels were very low against the limit.
4. Margin value = Emission Level – Limit value
5. " * ": Fundamental frequency.

802.11n (HT40), 1Tx

CHANNEL	TX Channel 3	DETECTOR FUNCTION	Peak (PK)
FREQUENCY RANGE	1GHz ~ 25GHz		Average (AV)

ANTENNA POLARITY & TEST DISTANCE: HORIZONTAL AT 3 M

NO.	FREQ. (MHz)	EMISSION LEVEL (dBuV/m)	LIMIT (dBuV/m)	MARGIN (dB)	ANTENNA HEIGHT (m)	TABLE ANGLE (Degree)	RAW VALUE (dBuV)	CORRECTION FACTOR (dB/m)
1	2390.00	69.2 PK	74.0	-4.8	1.93 H	84	35.67	33.53
2	2390.00	53.4 AV	54.0	-0.6	1.93 H	84	19.87	33.53
3	*2422.00	106.4 PK			1.93 H	84	72.78	33.62
4	*2422.00	95.1 AV			1.93 H	84	61.48	33.62
5	2500.00	56.7 PK	74.0	-17.3	1.98 H	322	22.84	33.86
6	2500.00	51.0 AV	54.0	-3.0	1.98 H	322	17.14	33.86
7	4844.00	51.7 PK	74.0	-22.3	1.18 H	185	8.50	43.20
8	4844.00	38.1 AV	54.0	-15.9	1.18 H	185	-5.10	43.20
9	7266.00	56.4 PK	74.0	-17.6	1.10 H	158	8.49	47.91
10	7266.00	43.3 AV	54.0	-10.7	1.10 H	158	-4.61	47.91

ANTENNA POLARITY & TEST DISTANCE: VERTICAL AT 3 M

NO.	FREQ. (MHz)	EMISSION LEVEL (dBuV/m)	LIMIT (dBuV/m)	MARGIN (dB)	ANTENNA HEIGHT (m)	TABLE ANGLE (Degree)	RAW VALUE (dBuV)	CORRECTION FACTOR (dB/m)
1	2390.00	67.6 PK	74.0	-6.4	1.26 V	315	34.07	33.53
2	2390.00	51.6 AV	54.0	-2.4	1.26 V	315	18.07	33.53
3	*2422.00	103.9 PK			1.26 V	315	70.28	33.62
4	*2422.00	93.0 AV			1.26 V	315	59.38	33.62
5	2500.00	54.4 PK	74.0	-19.6	1.26 V	315	20.54	33.86
6	2500.00	49.1 AV	54.0	-4.9	1.26 V	315	15.24	33.86
7	4844.00	52.2 PK	74.0	-21.8	1.07 V	112	9.00	43.20
8	4844.00	38.7 AV	54.0	-15.3	1.07 V	112	-4.50	43.20
9	7266.00	56.6 PK	74.0	-17.4	1.23 V	209	8.69	47.91
10	7266.00	43.3 AV	54.0	-10.7	1.23 V	209	-4.61	47.91

REMARKS:

1. Emission Level(dBuV/m) = Raw Value(dBuV) + Correction Factor(dB/m)
2. Correction Factor(dB/m) = Antenna Factor(dB/m) + Cable Factor(dB) – Pre-Amplifier Factor(dB)
3. The other emission levels were very low against the limit.
4. Margin value = Emission Level – Limit value
5. " * ": Fundamental frequency.



A D T

CHANNEL	TX Channel 6	DETECTOR FUNCTION	Peak (PK)
FREQUENCY RANGE	1GHz ~ 25GHz		Average (AV)

ANTENNA POLARITY & TEST DISTANCE: HORIZONTAL AT 3 M

NO.	FREQ. (MHz)	EMISSION LEVEL (dBuV/m)	LIMIT (dBuV/m)	MARGIN (dB)	ANTENNA HEIGHT (m)	TABLE ANGLE (Degree)	RAW VALUE (dBuV)	CORRECTION FACTOR (dB/m)
1	2390.00	66.0 PK	74.0	-8.0	1.92 H	99	32.47	33.53
2	2390.00	51.2 AV	54.0	-2.8	1.92 H	99	17.67	33.53
3	*2437.00	108.1 PK			1.92 H	99	74.43	33.67
4	*2437.00	97.7 AV			1.92 H	99	64.03	33.67
5	2483.50	73.4 PK	74.0	-0.6	1.92 H	99	39.59	33.81
6	2483.50	53.2 AV	54.0	-0.8	1.92 H	99	19.39	33.81
7	4874.00	51.2 PK	74.0	-22.8	1.26 H	185	7.96	43.24
8	4874.00	37.3 AV	54.0	-16.7	1.26 H	185	-5.94	43.24
9	7311.00	55.1 PK	74.0	-18.9	1.06 H	154	7.03	48.07
10	7311.00	42.2 AV	54.0	-11.8	1.06 H	154	-5.87	48.07

ANTENNA POLARITY & TEST DISTANCE: VERTICAL AT 3 M

NO.	FREQ. (MHz)	EMISSION LEVEL (dBuV/m)	LIMIT (dBuV/m)	MARGIN (dB)	ANTENNA HEIGHT (m)	TABLE ANGLE (Degree)	RAW VALUE (dBuV)	CORRECTION FACTOR (dB/m)
1	2390.00	63.8 PK	74.0	-10.2	1.22 V	329	30.27	33.53
2	2390.00	49.3 AV	54.0	-4.7	1.22 V	329	15.77	33.53
3	*2437.00	105.6 PK			1.22 V	329	71.93	33.67
4	*2437.00	95.1 AV			1.22 V	329	61.43	33.67
5	2483.50	70.6 PK	74.0	-3.4	1.22 V	329	36.79	33.81
6	2483.50	50.3 AV	54.0	-3.7	1.22 V	329	16.49	33.81
7	4874.00	52.3 PK	74.0	-21.7	1.12 V	123	9.06	43.24
8	4874.00	38.8 AV	54.0	-15.2	1.12 V	123	-4.44	43.24
9	7311.00	56.0 PK	74.0	-18.0	1.12 V	197	7.93	48.07
10	7311.00	42.8 AV	54.0	-11.2	1.12 V	197	-5.27	48.07

REMARKS:

1. Emission Level(dBuV/m) = Raw Value(dBuV) + Correction Factor(dB/m)
2. Correction Factor(dB/m) = Antenna Factor(dB/m) + Cable Factor(dB) – Pre-Amplifier Factor(dB)
3. The other emission levels were very low against the limit.
4. Margin value = Emission Level – Limit value
5. " * ": Fundamental frequency.



A D T

CHANNEL	TX Channel 9	DETECTOR FUNCTION	Peak (PK)
FREQUENCY RANGE	1GHz ~ 25GHz		Average (AV)

ANTENNA POLARITY & TEST DISTANCE: HORIZONTAL AT 3 M

NO.	FREQ. (MHz)	EMISSION LEVEL (dBuV/m)	LIMIT (dBuV/m)	MARGIN (dB)	ANTENNA HEIGHT (m)	TABLE ANGLE (Degree)	RAW VALUE (dBuV)	CORRECTION FACTOR (dB/m)
1	*2452.00	107.3 PK			1.92 H	89	73.59	33.71
2	*2452.00	96.1 AV			1.92 H	89	62.39	33.71
3	2483.50	73.3 PK	74.0	-0.7	1.92 H	89	39.49	33.81
4	2483.50	50.9 AV	54.0	-3.1	1.92 H	89	17.09	33.81
5	2500.00	63.6 PK	74.0	-10.4	2.00 H	239	29.74	33.86
6	2500.00	51.2 AV	54.0	-2.8	2.00 H	239	17.34	33.86
7	4904.00	51.6 PK	74.0	-22.4	1.15 H	188	8.33	43.27
8	4904.00	38.0 AV	54.0	-16.0	1.15 H	188	-5.27	43.27
9	7356.00	56.1 PK	74.0	-17.9	1.05 H	153	7.83	48.27
10	7356.00	43.1 AV	54.0	-10.9	1.05 H	153	-5.17	48.27

ANTENNA POLARITY & TEST DISTANCE: VERTICAL AT 3 M

NO.	FREQ. (MHz)	EMISSION LEVEL (dBuV/m)	LIMIT (dBuV/m)	MARGIN (dB)	ANTENNA HEIGHT (m)	TABLE ANGLE (Degree)	RAW VALUE (dBuV)	CORRECTION FACTOR (dB/m)
1	*2452.00	105.5 PK			1.19 V	322	71.79	33.71
2	*2452.00	94.3 AV			1.19 V	322	60.59	33.71
3	2483.50	70.3 PK	74.0	-3.7	1.19 V	322	36.49	33.81
4	2483.50	48.1 AV	54.0	-5.9	1.19 V	322	14.29	33.81
5	2500.00	61.6 PK	74.0	-12.4	1.19 V	322	27.74	33.86
6	2500.00	49.4 AV	54.0	-4.6	1.19 V	322	15.54	33.86
7	4904.00	51.6 PK	74.0	-22.4	1.04 V	127	8.33	43.27
8	4904.00	38.1 AV	54.0	-15.9	1.04 V	127	-5.17	43.27
9	7356.00	56.4 PK	74.0	-17.6	1.21 V	227	8.13	48.27
10	7356.00	43.6 AV	54.0	-10.4	1.21 V	227	-4.67	48.27

REMARKS:

1. Emission Level(dBuV/m) = Raw Value(dBuV) + Correction Factor(dB/m)
2. Correction Factor(dB/m) = Antenna Factor(dB/m) + Cable Factor(dB) – Pre-Amplifier Factor(dB)
3. The other emission levels were very low against the limit.
4. Margin value = Emission Level – Limit value
5. " * ": Fundamental frequency.



A D T

802.11g, 2Tx

CHANNEL	TX Channel 1	DETECTOR FUNCTION	Peak (PK)
FREQUENCY RANGE	1GHz ~ 25GHz		Average (AV)

ANTENNA POLARITY & TEST DISTANCE: HORIZONTAL AT 3 M

NO.	FREQ. (MHz)	EMISSION LEVEL (dBuV/m)	LIMIT (dBuV/m)	MARGIN (dB)	ANTENNA HEIGHT (m)	TABLE ANGLE (Degree)	RAW VALUE (dBuV)	CORRECTION FACTOR (dB/m)
1	2390.00	71.2 PK	74.0	-2.8	1.29 H	109	37.67	33.53
2	2390.00	53.4 AV	54.0	-0.6	1.29 H	109	19.87	33.53
3	*2412.00	112.9 PK			1.29 H	109	79.31	33.59
4	*2412.00	103.8 AV			1.29 H	109	70.21	33.59
5	4824.00	52.4 PK	74.0	-21.6	1.20 H	163	9.22	43.18
6	4824.00	38.6 AV	54.0	-15.4	1.20 H	163	-4.58	43.18

ANTENNA POLARITY & TEST DISTANCE: VERTICAL AT 3 M

NO.	FREQ. (MHz)	EMISSION LEVEL (dBuV/m)	LIMIT (dBuV/m)	MARGIN (dB)	ANTENNA HEIGHT (m)	TABLE ANGLE (Degree)	RAW VALUE (dBuV)	CORRECTION FACTOR (dB/m)
1	2390.00	70.1 PK	74.0	-3.9	1.01 V	334	36.57	33.53
2	2390.00	51.3 AV	54.0	-2.7	1.01 V	334	17.77	33.53
3	*2412.00	112.8 PK			1.01 V	334	79.21	33.59
4	*2412.00	102.2 AV			1.01 V	334	68.61	33.59
5	4824.00	51.2 PK	74.0	-22.8	1.00 V	74	8.02	43.18
6	4824.00	37.8 AV	54.0	-16.2	1.00 V	74	-5.38	43.18

REMARKS:

1. Emission Level(dBuV/m) = Raw Value(dBuV) + Correction Factor(dB/m)
2. Correction Factor(dB/m) = Antenna Factor(dB/m) + Cable Factor(dB) – Pre-Amplifier Factor(dB)
3. The other emission levels were very low against the limit.
4. Margin value = Emission Level – Limit value
5. " * ": Fundamental frequency.



A D T

CHANNEL	TX Channel 6	DETECTOR FUNCTION	Peak (PK)
FREQUENCY RANGE	1GHz ~ 25GHz		Average (AV)

ANTENNA POLARITY & TEST DISTANCE: HORIZONTAL AT 3 M

NO.	FREQ. (MHz)	EMISSION LEVEL (dBuV/m)	LIMIT (dBuV/m)	MARGIN (dB)	ANTENNA HEIGHT (m)	TABLE ANGLE (Degree)	RAW VALUE (dBuV)	CORRECTION FACTOR (dB/m)
1	*2437.00	115.9 PK			1.25 H	112	82.23	33.67
2	*2437.00	105.7 AV			1.25 H	112	72.03	33.67
3	2500.00	60.9 PK	74.0	-13.1	1.25 H	112	27.04	33.86
4	2500.00	50.6 AV	54.0	-3.4	1.25 H	112	16.74	33.86
5	4874.00	52.1 PK	74.0	-21.9	1.24 H	159	8.86	43.24
6	4874.00	38.3 AV	54.0	-15.7	1.24 H	159	-4.94	43.24
7	7311.00	55.6 PK	74.0	-18.4	1.14 H	136	7.53	48.07
8	7311.00	43.0 AV	54.0	-11.0	1.14 H	136	-5.07	48.07

ANTENNA POLARITY & TEST DISTANCE: VERTICAL AT 3 M

NO.	FREQ. (MHz)	EMISSION LEVEL (dBuV/m)	LIMIT (dBuV/m)	MARGIN (dB)	ANTENNA HEIGHT (m)	TABLE ANGLE (Degree)	RAW VALUE (dBuV)	CORRECTION FACTOR (dB/m)
1	*2437.00	113.5 PK			1.05 V	334	79.83	33.67
2	*2437.00	103.3 AV			1.05 V	334	69.63	33.67
3	2500.00	59.3 PK	74.0	-14.7	1.05 V	334	25.44	33.86
4	2500.00	49.0 AV	54.0	-5.0	1.05 V	334	15.14	33.86
5	4874.00	52.1 PK	74.0	-21.9	1.04 V	79	8.86	43.24
6	4874.00	38.3 AV	54.0	-15.7	1.04 V	79	-4.94	43.24
7	7311.00	56.0 PK	74.0	-18.0	1.18 V	197	7.93	48.07
8	7311.00	42.6 AV	54.0	-11.4	1.18 V	197	-5.47	48.07

REMARKS:

1. Emission Level(dBuV/m) = Raw Value(dBuV) + Correction Factor(dB/m)
2. Correction Factor(dB/m) = Antenna Factor(dB/m) + Cable Factor(dB) – Pre-Amplifier Factor(dB)
3. The other emission levels were very low against the limit.
4. Margin value = Emission Level – Limit value
5. " * ": Fundamental frequency.



A D T

CHANNEL	TX Channel 11	DETECTOR FUNCTION	Peak (PK)
FREQUENCY RANGE	1GHz ~ 25GHz		Average (AV)

ANTENNA POLARITY & TEST DISTANCE: HORIZONTAL AT 3 M

NO.	FREQ. (MHz)	EMISSION LEVEL (dBuV/m)	LIMIT (dBuV/m)	MARGIN (dB)	ANTENNA HEIGHT (m)	TABLE ANGLE (Degree)	RAW VALUE (dBuV)	CORRECTION FACTOR (dB/m)
1	*2462.00	114.0 PK			1.26 H	111	80.26	33.74
2	*2462.00	103.6 AV			1.26 H	111	69.86	33.74
3	2483.50	73.3 PK	74.0	-0.7	1.26 H	111	39.49	33.81
4	2483.50	47.8 AV	54.0	-6.2	1.26 H	111	13.99	33.81
5	2500.00	65.2 PK	74.0	-8.8	1.20 H	113	31.34	33.86
6	2500.00	51.0 AV	54.0	-3.0	1.20 H	113	17.14	33.86
7	4924.00	51.8 PK	74.0	-22.2	1.19 H	159	8.53	43.27
8	4924.00	38.0 AV	54.0	-16.0	1.19 H	159	-5.27	43.27
9	7386.00	54.9 PK	74.0	-19.1	1.07 H	117	6.50	48.40
10	7386.00	42.8 AV	54.0	-11.2	1.07 H	117	-5.60	48.40

ANTENNA POLARITY & TEST DISTANCE: VERTICAL AT 3 M

NO.	FREQ. (MHz)	EMISSION LEVEL (dBuV/m)	LIMIT (dBuV/m)	MARGIN (dB)	ANTENNA HEIGHT (m)	TABLE ANGLE (Degree)	RAW VALUE (dBuV)	CORRECTION FACTOR (dB/m)
1	*2462.00	111.6 PK			1.01 V	310	77.86	33.74
2	*2462.00	101.0 AV			1.01 V	310	67.26	33.74
3	2483.50	71.1 PK	74.0	-2.9	1.01 V	310	37.29	33.81
4	2483.50	45.4 AV	54.0	-8.6	1.01 V	310	11.59	33.81
5	2500.00	62.8 PK	74.0	-11.2	1.01 V	310	28.94	33.86
6	2500.00	48.6 AV	54.0	-5.4	1.01 V	310	14.74	33.86
7	4924.00	52.2 PK	74.0	-21.8	1.06 V	75	8.93	43.27
8	4924.00	38.2 AV	54.0	-15.8	1.06 V	75	-5.07	43.27
9	7386.00	55.3 PK	74.0	-18.7	1.07 V	193	6.90	48.40
10	7386.00	42.1 AV	54.0	-11.9	1.07 V	193	-6.30	48.40

REMARKS:

1. Emission Level(dBuV/m) = Raw Value(dBuV) + Correction Factor(dB/m)
2. Correction Factor(dB/m) = Antenna Factor(dB/m) + Cable Factor(dB) – Pre-Amplifier Factor(dB)
3. The other emission levels were very low against the limit.
4. Margin value = Emission Level – Limit value
5. " * ": Fundamental frequency.



A D T

802.11n (HT20), 2Tx

CHANNEL	TX Channel 1	DETECTOR FUNCTION	Peak (PK)
FREQUENCY RANGE	1GHz ~ 25GHz		Average (AV)

ANTENNA POLARITY & TEST DISTANCE: HORIZONTAL AT 3 M

NO.	FREQ. (MHz)	EMISSION LEVEL (dBuV/m)	LIMIT (dBuV/m)	MARGIN (dB)	ANTENNA HEIGHT (m)	TABLE ANGLE (Degree)	RAW VALUE (dBuV)	CORRECTION FACTOR (dB/m)
1	2390.00	73.1 PK	74.0	-0.9	1.28 H	113	39.57	33.53
2	2390.00	51.5 AV	54.0	-2.5	1.28 H	113	17.97	33.53
3	*2412.00	111.3 PK			1.28 H	113	77.71	33.59
4	*2412.00	101.9 AV			1.28 H	113	68.31	33.59
5	2500.00	55.9 PK	74.0	-18.1	1.27 H	240	22.04	33.86
6	2500.00	49.5 AV	54.0	-4.5	1.27 H	240	15.64	33.86
7	4824.00	52.5 PK	74.0	-21.5	1.28 H	144	9.32	43.18
8	4824.00	38.5 AV	54.0	-15.5	1.28 H	144	-4.68	43.18

ANTENNA POLARITY & TEST DISTANCE: VERTICAL AT 3 M

NO.	FREQ. (MHz)	EMISSION LEVEL (dBuV/m)	LIMIT (dBuV/m)	MARGIN (dB)	ANTENNA HEIGHT (m)	TABLE ANGLE (Degree)	RAW VALUE (dBuV)	CORRECTION FACTOR (dB/m)
1	2390.00	71.2 PK	74.0	-2.8	1.06 V	329	37.67	33.53
2	2390.00	49.6 AV	54.0	-4.4	1.06 V	329	16.07	33.53
3	*2412.00	109.1 PK			1.06 V	329	75.51	33.59
4	*2412.00	99.9 AV			1.06 V	329	66.31	33.59
5	2500.00	53.0 PK	74.0	-21.0	1.06 V	329	19.14	33.86
6	2500.00	47.1 AV	54.0	-6.9	1.06 V	329	13.24	33.86
7	4824.00	51.7 PK	74.0	-22.3	1.11 V	90	8.52	43.18
8	4824.00	38.3 AV	54.0	-15.7	1.11 V	90	-4.88	43.18

REMARKS:

1. Emission Level(dBuV/m) = Raw Value(dBuV) + Correction Factor(dB/m)
2. Correction Factor(dB/m) = Antenna Factor(dB/m) + Cable Factor(dB) – Pre-Amplifier Factor(dB)
3. The other emission levels were very low against the limit.
4. Margin value = Emission Level – Limit value
5. " * ": Fundamental frequency.



A D T

CHANNEL	TX Channel 6	DETECTOR FUNCTION	Peak (PK)
FREQUENCY RANGE	1GHz ~ 25GHz		Average (AV)

ANTENNA POLARITY & TEST DISTANCE: HORIZONTAL AT 3 M

NO.	FREQ. (MHz)	EMISSION LEVEL (dBuV/m)	LIMIT (dBuV/m)	MARGIN (dB)	ANTENNA HEIGHT (m)	TABLE ANGLE (Degree)	RAW VALUE (dBuV)	CORRECTION FACTOR (dB/m)
1	*2437.00	114.6 PK			1.26 H	110	80.93	33.67
2	*2437.00	105.1 AV			1.26 H	110	71.43	33.67
3	2500.00	61.2 PK	74.0	-12.8	1.21 H	112	27.34	33.86
4	2500.00	51.4 AV	54.0	-2.6	1.21 H	112	17.54	33.86
5	4874.00	52.1 PK	74.0	-21.9	1.20 H	146	8.86	43.24
6	4874.00	38.2 AV	54.0	-15.8	1.20 H	146	-5.04	43.24
7	7311.00	54.5 PK	74.0	-19.5	1.18 H	144	6.43	48.07
8	7311.00	42.0 AV	54.0	-12.0	1.18 H	144	-6.07	48.07

ANTENNA POLARITY & TEST DISTANCE: VERTICAL AT 3 M

NO.	FREQ. (MHz)	EMISSION LEVEL (dBuV/m)	LIMIT (dBuV/m)	MARGIN (dB)	ANTENNA HEIGHT (m)	TABLE ANGLE (Degree)	RAW VALUE (dBuV)	CORRECTION FACTOR (dB/m)
1	*2437.00	112.9 PK			1.03 V	319	79.23	33.67
2	*2437.00	103.3 AV			1.03 V	319	69.63	33.67
3	2500.00	59.1 PK	74.0	-14.9	1.03 V	319	25.24	33.86
4	2500.00	49.5 AV	54.0	-4.5	1.03 V	319	15.64	33.86
5	4874.00	51.9 PK	74.0	-22.1	1.07 V	33	8.66	43.24
6	4874.00	37.7 AV	54.0	-16.3	1.07 V	33	-5.54	43.24
7	7311.00	54.3 PK	74.0	-19.7	1.07 V	192	6.23	48.07
8	7311.00	41.7 AV	54.0	-12.3	1.07 V	192	-6.37	48.07

REMARKS:

1. Emission Level(dBuV/m) = Raw Value(dBuV) + Correction Factor(dB/m)
2. Correction Factor(dB/m) = Antenna Factor(dB/m) + Cable Factor(dB) – Pre-Amplifier Factor(dB)
3. The other emission levels were very low against the limit.
4. Margin value = Emission Level – Limit value
5. " * ": Fundamental frequency.



A D T

CHANNEL	TX Channel 11	DETECTOR FUNCTION	Peak (PK)
FREQUENCY RANGE	1GHz ~ 25GHz		Average (AV)

ANTENNA POLARITY & TEST DISTANCE: HORIZONTAL AT 3 M

NO.	FREQ. (MHz)	EMISSION LEVEL (dBuV/m)	LIMIT (dBuV/m)	MARGIN (dB)	ANTENNA HEIGHT (m)	TABLE ANGLE (Degree)	RAW VALUE (dBuV)	CORRECTION FACTOR (dB/m)
1	*2462.00	112.0 PK			1.29 H	112	78.26	33.74
2	*2462.00	101.6 AV			1.29 H	112	67.86	33.74
3	2483.50	73.2 PK	74.0	-0.8	1.29 H	112	39.39	33.81
4	2483.50	48.5 AV	54.0	-5.5	1.29 H	112	14.69	33.81
5	2500.00	56.0 PK	74.0	-18.0	1.24 H	237	22.14	33.86
6	2500.00	50.1 AV	54.0	-3.9	1.24 H	237	16.24	33.86
7	4924.00	51.8 PK	74.0	-22.2	1.20 H	173	8.53	43.27
8	4924.00	38.0 AV	54.0	-16.0	1.20 H	173	-5.27	43.27
9	7386.00	55.3 PK	74.0	-18.7	1.04 H	132	6.90	48.40
10	7386.00	42.6 AV	54.0	-11.4	1.04 H	132	-5.80	48.40

ANTENNA POLARITY & TEST DISTANCE: VERTICAL AT 3 M

NO.	FREQ. (MHz)	EMISSION LEVEL (dBuV/m)	LIMIT (dBuV/m)	MARGIN (dB)	ANTENNA HEIGHT (m)	TABLE ANGLE (Degree)	RAW VALUE (dBuV)	CORRECTION FACTOR (dB/m)
1	*2462.00	109.4 PK			1.01 V	325	75.66	33.74
2	*2462.00	99.2 AV			1.01 V	325	65.46	33.74
3	2483.50	71.5 PK	74.0	-2.5	1.01 V	325	37.69	33.81
4	2483.50	46.7 AV	54.0	-7.3	1.01 V	325	12.89	33.81
5	2500.00	54.1 PK	74.0	-19.9	1.01 V	325	20.24	33.86
6	2500.00	48.0 AV	54.0	-6.0	1.01 V	325	14.14	33.86
7	4924.00	52.3 PK	74.0	-21.7	1.08 V	67	9.03	43.27
8	4924.00	38.3 AV	54.0	-15.7	1.08 V	67	-4.97	43.27
9	7386.00	55.2 PK	74.0	-18.8	1.00 V	186	6.80	48.40
10	7386.00	41.7 AV	54.0	-12.3	1.00 V	186	-6.70	48.40

REMARKS:

1. Emission Level(dBuV/m) = Raw Value(dBuV) + Correction Factor(dB/m)
2. Correction Factor(dB/m) = Antenna Factor(dB/m) + Cable Factor(dB) – Pre-Amplifier Factor(dB)
3. The other emission levels were very low against the limit.
4. Margin value = Emission Level – Limit value
5. " * ": Fundamental frequency.



802.11n (HT40), 2Tx

CHANNEL	TX Channel 3	DETECTOR FUNCTION	Peak (PK)
FREQUENCY RANGE	1GHz ~ 25GHz		Average (AV)

ANTENNA POLARITY & TEST DISTANCE: HORIZONTAL AT 3 M

NO.	FREQ. (MHz)	EMISSION LEVEL (dBuV/m)	LIMIT (dBuV/m)	MARGIN (dB)	ANTENNA HEIGHT (m)	TABLE ANGLE (Degree)	RAW VALUE (dBuV)	CORRECTION FACTOR (dB/m)
1	2390.00	68.4 PK	74.0	-5.6	1.30 H	112	34.87	33.53
2	2390.00	53.4 AV	54.0	-0.6	1.30 H	112	19.87	33.53
3	*2422.00	107.0 PK			1.30 H	112	73.38	33.62
4	*2422.00	97.0 AV			1.30 H	112	63.38	33.62
5	2500.00	57.6 PK	74.0	-16.4	1.16 H	106	23.74	33.86
6	2500.00	49.5 AV	54.0	-4.5	1.16 H	106	15.64	33.86
7	4844.00	52.3 PK	74.0	-21.7	1.18 H	145	9.10	43.20
8	4844.00	38.8 AV	54.0	-15.2	1.18 H	145	-4.40	43.20
9	7266.00	54.5 PK	74.0	-19.5	1.01 H	110	6.59	47.91
10	7266.00	42.1 AV	54.0	-11.9	1.01 H	110	-5.81	47.91

ANTENNA POLARITY & TEST DISTANCE: VERTICAL AT 3 M

NO.	FREQ. (MHz)	EMISSION LEVEL (dBuV/m)	LIMIT (dBuV/m)	MARGIN (dB)	ANTENNA HEIGHT (m)	TABLE ANGLE (Degree)	RAW VALUE (dBuV)	CORRECTION FACTOR (dB/m)
1	2390.00	66.7 PK	74.0	-7.3	1.07 V	326	33.17	33.53
2	2390.00	51.5 AV	54.0	-2.5	1.07 V	326	17.97	33.53
3	*2422.00	104.3 PK			1.07 V	326	70.68	33.62
4	*2422.00	94.2 AV			1.07 V	326	60.58	33.62
5	2500.00	55.7 PK	74.0	-18.3	1.07 V	326	21.84	33.86
6	2500.00	47.5 AV	54.0	-6.5	1.07 V	326	13.64	33.86
7	4844.00	52.2 PK	74.0	-21.8	1.00 V	56	9.00	43.20
8	4844.00	38.5 AV	54.0	-15.5	1.00 V	56	-4.70	43.20
9	7266.00	54.9 PK	74.0	-19.1	1.07 V	165	6.99	47.91
10	7266.00	41.6 AV	54.0	-12.4	1.07 V	165	-6.31	47.91

REMARKS:

1. Emission Level(dBuV/m) = Raw Value(dBuV) + Correction Factor(dB/m)
2. Correction Factor(dB/m) = Antenna Factor(dB/m) + Cable Factor(dB) – Pre-Amplifier Factor(dB)
3. The other emission levels were very low against the limit.
4. Margin value = Emission Level – Limit value
5. " * ": Fundamental frequency.



A D T

CHANNEL	TX Channel 6	DETECTOR FUNCTION	Peak (PK)
FREQUENCY RANGE	1GHz ~ 25GHz		Average (AV)

ANTENNA POLARITY & TEST DISTANCE: HORIZONTAL AT 3 M

NO.	FREQ. (MHz)	EMISSION LEVEL (dBuV/m)	LIMIT (dBuV/m)	MARGIN (dB)	ANTENNA HEIGHT (m)	TABLE ANGLE (Degree)	RAW VALUE (dBuV)	CORRECTION FACTOR (dB/m)
1	2390.00	67.3 PK	74.0	-6.7	1.26 H	117	33.77	33.53
2	2390.00	51.3 AV	54.0	-2.7	1.26 H	117	17.77	33.53
3	*2437.00	110.6 PK			1.26 H	117	76.93	33.67
4	*2437.00	100.6 AV			1.26 H	117	66.93	33.67
5	2483.50	73.4 PK	74.0	-0.6	1.26 H	117	39.59	33.81
6	2483.50	52.6 AV	54.0	-1.4	1.26 H	117	18.79	33.81
7	4874.00	51.7 PK	74.0	-22.3	1.08 H	169	8.46	43.24
8	4874.00	38.4 AV	54.0	-15.6	1.08 H	169	-4.84	43.24
9	7311.00	54.9 PK	74.0	-19.1	1.18 H	128	6.83	48.07
10	7311.00	42.3 AV	54.0	-11.7	1.18 H	128	-5.77	48.07

ANTENNA POLARITY & TEST DISTANCE: VERTICAL AT 3 M

NO.	FREQ. (MHz)	EMISSION LEVEL (dBuV/m)	LIMIT (dBuV/m)	MARGIN (dB)	ANTENNA HEIGHT (m)	TABLE ANGLE (Degree)	RAW VALUE (dBuV)	CORRECTION FACTOR (dB/m)
1	2390.00	65.1 PK	74.0	-8.9	1.08 V	332	31.57	33.53
2	2390.00	49.3 AV	54.0	-4.7	1.08 V	332	15.77	33.53
3	*2437.00	108.1 PK			1.08 V	332	74.43	33.67
4	*2437.00	98.1 AV			1.08 V	332	64.43	33.67
5	2483.50	71.1 PK	74.0	-2.9	1.08 V	332	37.29	33.81
6	2483.50	50.2 AV	54.0	-3.8	1.08 V	332	16.39	33.81
7	4874.00	52.6 PK	74.0	-21.4	1.10 V	75	9.36	43.24
8	4874.00	38.5 AV	54.0	-15.5	1.10 V	75	-4.74	43.24
9	7311.00	54.8 PK	74.0	-19.2	1.11 V	183	6.73	48.07
10	7311.00	41.7 AV	54.0	-12.3	1.11 V	183	-6.37	48.07

REMARKS:

1. Emission Level(dBuV/m) = Raw Value(dBuV) + Correction Factor(dB/m)
2. Correction Factor(dB/m) = Antenna Factor(dB/m) + Cable Factor(dB) – Pre-Amplifier Factor(dB)
3. The other emission levels were very low against the limit.
4. Margin value = Emission Level – Limit value
5. " * ": Fundamental frequency.
6. " # ": The radiated frequency is out of the restricted band.



A D T

CHANNEL	TX Channel 9	DETECTOR FUNCTION	Peak (PK)
FREQUENCY RANGE	1GHz ~ 25GHz		Average (AV)

ANTENNA POLARITY & TEST DISTANCE: HORIZONTAL AT 3 M

NO.	FREQ. (MHz)	EMISSION LEVEL (dBuV/m)	LIMIT (dBuV/m)	MARGIN (dB)	ANTENNA HEIGHT (m)	TABLE ANGLE (Degree)	RAW VALUE (dBuV)	CORRECTION FACTOR (dB/m)
1	*2452.00	108.0 PK			1.28 H	117	74.29	33.71
2	*2452.00	98.6 AV			1.28 H	117	64.89	33.71
3	2483.50	73.4 PK	74.0	-0.6	1.28 H	117	39.59	33.81
4	2483.50	51.2 AV	54.0	-2.8	1.28 H	117	17.39	33.81
5	4904.00	50.8 PK	74.0	-23.2	1.11 H	175	7.53	43.27
6	4904.00	37.0 AV	54.0	-17.0	1.11 H	175	-6.27	43.27
7	7356.00	55.2 PK	74.0	-18.8	1.20 H	149	6.93	48.27
8	7356.00	42.6 AV	54.0	-11.4	1.20 H	149	-5.67	48.27

ANTENNA POLARITY & TEST DISTANCE: VERTICAL AT 3 M

NO.	FREQ. (MHz)	EMISSION LEVEL (dBuV/m)	LIMIT (dBuV/m)	MARGIN (dB)	ANTENNA HEIGHT (m)	TABLE ANGLE (Degree)	RAW VALUE (dBuV)	CORRECTION FACTOR (dB/m)
1	*2452.00	105.3 PK			1.04 V	330	71.59	33.71
2	*2452.00	96.3 AV			1.04 V	330	62.59	33.71
3	2483.50	71.6 PK	74.0	-2.4	1.04 V	330	37.79	33.81
4	2483.50	49.4 AV	54.0	-4.6	1.04 V	330	15.59	33.81
5	4904.00	52.1 PK	74.0	-21.9	1.01 V	89	8.83	43.27
6	4904.00	38.1 AV	54.0	-15.9	1.01 V	89	-5.17	43.27
7	7356.00	55.6 PK	74.0	-18.4	1.11 V	203	7.33	48.27
8	7356.00	42.3 AV	54.0	-11.7	1.11 V	203	-5.97	48.27

REMARKS:

1. Emission Level(dBuV/m) = Raw Value(dBuV) + Correction Factor(dB/m)
2. Correction Factor(dB/m) = Antenna Factor(dB/m) + Cable Factor(dB) – Pre-Amplifier Factor(dB)
3. The other emission levels were very low against the limit.
4. Margin value = Emission Level – Limit value
5. " * ": Fundamental frequency.

4.3 6dB BANDWIDTH MEASUREMENT

4.3.1 LIMITS OF 6dB BANDWIDTH MEASUREMENT

The minimum of 6dB Bandwidth Measurement is 0.5 MHz.

4.3.2 TEST INSTRUMENTS

DESCRIPTION & MANUFACTURER	MODEL NO.	SERIAL NO.	CALIBRATED DATE	CALIBRATED UNTIL
Spectrum Analyzer R&S	FSP40	100036	Jan. 21, 2014	Jan. 20, 2015

Note:

1. The calibration interval of the above test instruments is 12 months and the calibrations are traceable to NML/ROC and NIST/USA.
2. Tested date : Feb. 26, 2014

4.3.3 TEST PROCEDURE

1. Set resolution bandwidth (RBW) = 100kHz
2. Set the video bandwidth (VBW) $\geq 3 \times$ RBW, Detector = Peak.
3. Trace mode = max hold.
4. Sweep = auto couple.
5. Measure the maximum width of the emission that is constrained by the frequencies associated with the two amplitude points (upper and lower) that are attenuated by 6 dB relative to the maximum level measured in the fundamental emission

4.3.4 DEVIATION FROM TEST STANDARD

No deviation

4.3.5 TEST SETUP

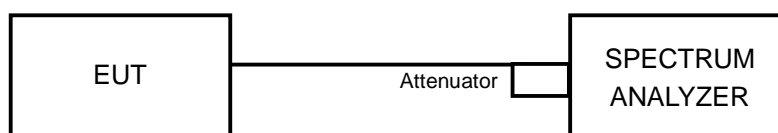

4.3.6 EUT OPERATING CONDITIONS

The software provided by client to enable the EUT under transmission condition continuously at lowest, middle and highest channel frequencies individually.



A D T

4.3.7 TEST RESULTS

802.11b, 1Tx

CHANNEL	CHANNEL FREQUENCY (MHz)	6dB BANDWIDTH (MHz)	MINIMUM LIMIT (MHz)	PASS / FAIL
1	2412	7.69	0.5	PASS
6	2437	8.09	0.5	PASS
11	2462	8.08	0.5	PASS

802.11g, 1Tx

CHANNEL	CHANNEL FREQUENCY (MHz)	6dB BANDWIDTH (MHz)	MINIMUM LIMIT (MHz)	PASS / FAIL
1	2412	16.50	0.5	PASS
6	2437	16.52	0.5	PASS
11	2462	16.55	0.5	PASS

802.11n (HT20), 1Tx

CHANNEL	CHANNEL FREQUENCY (MHz)	6dB BANDWIDTH (MHz)	MINIMUM LIMIT (MHz)	PASS / FAIL
1	2412	17.68	0.5	PASS
6	2437	17.68	0.5	PASS
11	2462	17.72	0.5	PASS

802.11n (HT40), 1Tx

CHANNEL	CHANNEL FREQUENCY (MHz)	6dB BANDWIDTH (MHz)	MINIMUM LIMIT (MHz)	PASS / FAIL
3	2422	35.80	0.5	PASS
6	2437	35.80	0.5	PASS
9	2452	35.58	0.5	PASS



A D T

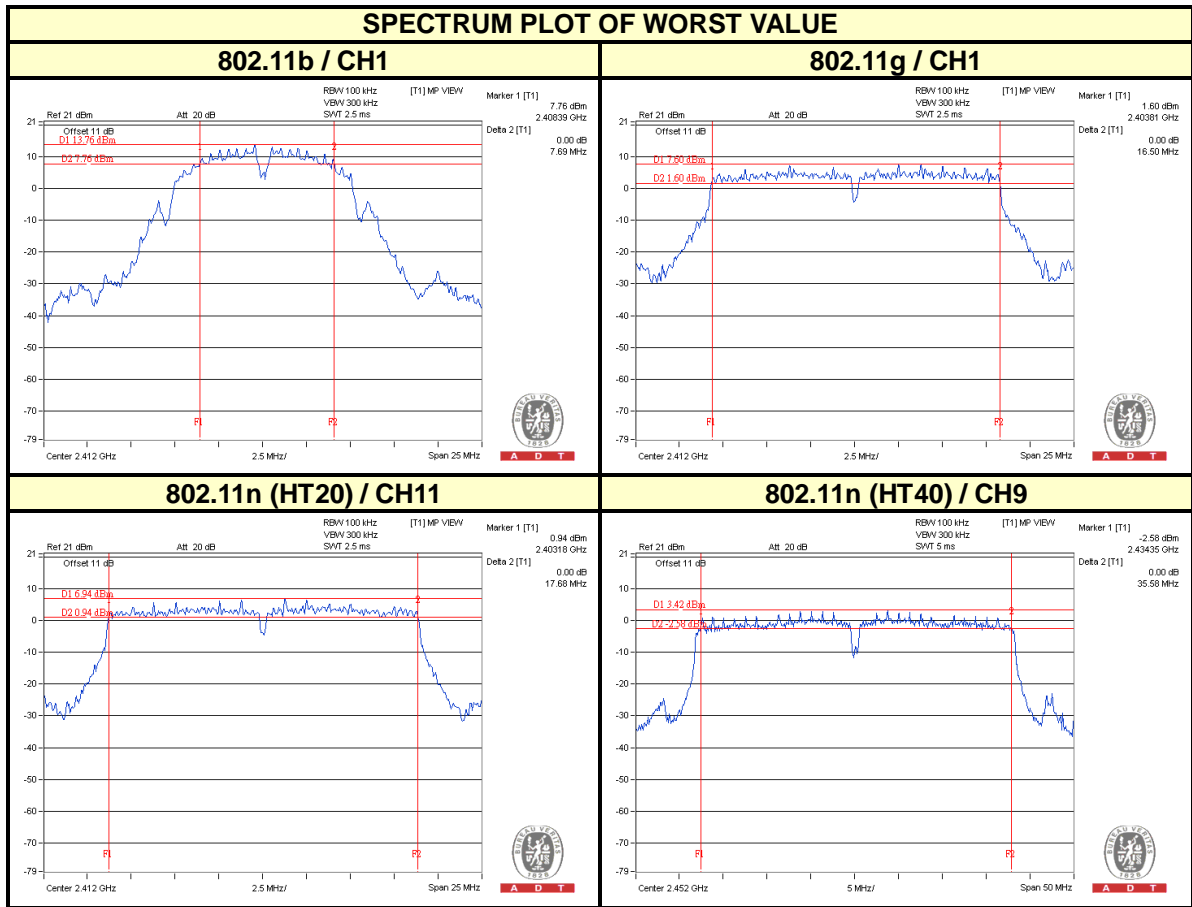



A D T

802.11g, 2Tx

CHANNEL	CHANNEL FREQUENCY (MHz)	6dB BANDWIDTH (MHz)		MINIMUM LIMIT (MHz)	PASS / FAIL
		CHAIN 2	CHAIN 1		
1	2412	16.51	16.53	0.5	PASS
6	2437	16.50	16.51	0.5	PASS
11	2462	16.52	16.53	0.5	PASS

802.11n (HT20), 2Tx

CHANNEL	CHANNEL FREQUENCY (MHz)	6dB BANDWIDTH (MHz)		MINIMUM LIMIT (MHz)	PASS / FAIL
		CHAIN 2	CHAIN 1		
1	2412	17.74	17.71	0.5	PASS
6	2437	17.72	17.70	0.5	PASS
11	2462	17.69	17.71	0.5	PASS

802.11n (HT40), 2Tx

CHANNEL	CHANNEL FREQUENCY (MHz)	6dB BANDWIDTH (MHz)		MINIMUM LIMIT (MHz)	PASS / FAIL
		CHAIN 2	CHAIN 1		
3	2422	36.13	36.04	0.5	PASS
6	2437	35.63	35.90	0.5	PASS
9	2452	35.69	36.41	0.5	PASS



A D T

SPECTRUM PLOT OF WORST VALUE

802.11g_Chain 2 / CH6

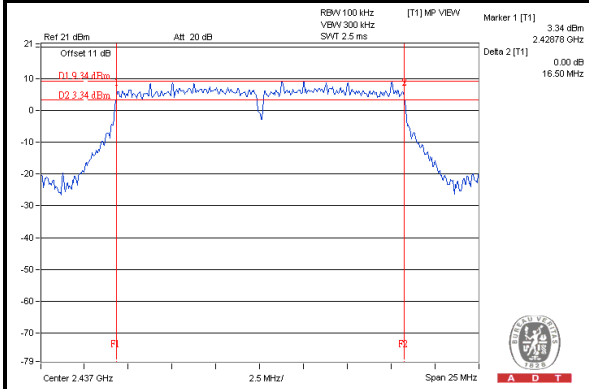

802.11n (HT20)_Chain 2 / CH11

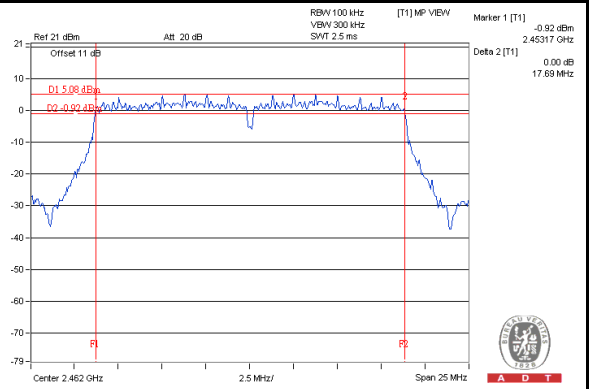

802.11n (HT40)_Chain 2 / CH6

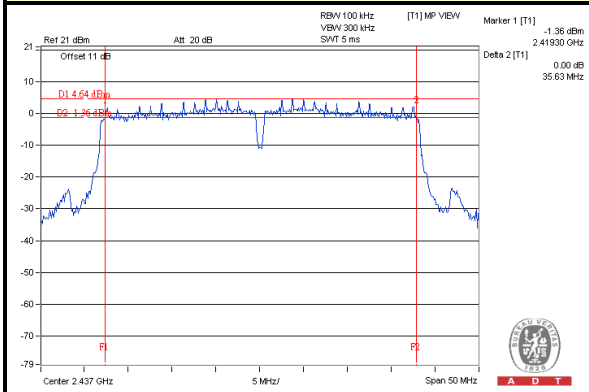



A D T

4.4 CONDUCTED OUTPUT POWER MEASUREMENT

4.4.1 LIMITS OF MAXIMUM OUTPUT POWER MEASUREMENT

For systems using digital modulation in the 2400–2483.5 MHz bands: 1 Watt (30dBm)

Per KDB 662911 D01 Multiple Transmitter Output Method of conducted output power measurement on IEEE 802.11 devices,

Array Gain = 0 dB (i.e., no array gain) for $NANT \leq 4$;

Array Gain = 0 dB (i.e., no array gain) for channel widths ≥ 40 MHz for any NANT;

Array Gain = $5 \log(NANT/NSS)$ dB or 3 dB, whichever is less for 20-MHz channel widths with $NANT \geq 5$.

For power measurements on all other devices: Array Gain = $10 \log(NANT/NSS)$ dB.

4.4.2 INSTRUMENTS

DESCRIPTION & MANUFACTURER	MODEL NO.	SERIAL NO.	CALIBRATED DATE	CALIBRATED UNTIL
Power meter Anritsu	ML2495A	0824006	May 20, 2013	May 19, 2014
Power sensor Anritsu	MA2411B	0738172	May 20, 2013	May 19, 2014

Note:

1. The calibration interval of the above test instruments is 12 months and the calibrations are traceable to NML/ROC and NIST/USA.
2. Tested date : Feb. 26, 2014

4.4.3 TEST PROCEDURES

Method PM is used to perform output power measurement, trigger and gating function of wide band power meter is enabled to measure max output power of TX on burst. Duty factor is not added to measured value.

4.4.4 DEVIATION FROM TEST STANDARD

No deviation.



A D T

4.4.5 TEST SETUP

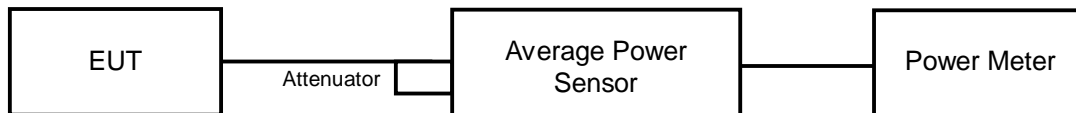

4.4.6 EUT OPERATING CONDITIONS

Same as Item 4.3.6



A D T

4.4.7 TEST RESULTS

802.11b, 1Tx

CHANNEL	FREQUENCY (MHz)	AVERAGE POWER (mW)	AVERAGE POWER (dBm)	LIMIT (dBm)	PASS/FAIL
1	2412	195.434	22.91	30	PASS
6	2437	208.449	23.19	30	PASS
11	2462	211.836	23.26	30	PASS

802.11g, 1Tx

CHANNEL	FREQUENCY (MHz)	AVERAGE POWER (mW)	AVERAGE POWER (dBm)	LIMIT (dBm)	PASS/FAIL
1	2412	119.674	20.78	30	PASS
6	2437	171.396	22.34	30	PASS
11	2462	89.125	19.50	30	PASS

802.11n (HT20), 1Tx

CHANNEL	FREQUENCY (MHz)	AVERAGE POWER (mW)	AVERAGE POWER (dBm)	LIMIT (dBm)	PASS/FAIL
1	2412	93.972	19.73	30	PASS
6	2437	166.725	22.22	30	PASS
11	2462	82.224	19.15	30	PASS

802.11n (HT40), 1Tx

CHANNEL	FREQUENCY (MHz)	AVERAGE POWER (mW)	AVERAGE POWER (dBm)	LIMIT (dBm)	PASS/FAIL
3	2422	65.615	18.17	30	PASS
6	2437	118.577	20.74	30	PASS
9	2452	70.958	18.51	30	PASS



A D T

802.11g, 2Tx

CHANNEL	FREQUENCY (MHz)	AVERAGE POWER (dBm)		TOTAL POWER (mW)	TOTAL POWER (dBm)	LIMIT (dBm)	PASS / FAIL
		CHAIN 2	CHAIN 1				
1	2412	20.61	19.97	214.392	23.31	30	PASS
6	2437	22.29	22.20	335.393	25.26	30	PASS
11	2462	18.04	18.20	129.749	21.13	30	PASS

802.11n (HT20), 2Tx

CHANNEL	FREQUENCY (MHz)	AVERAGE POWER (dBm)		TOTAL POWER (mW)	TOTAL POWER (dBm)	LIMIT (dBm)	PASS / FAIL
		CHAIN 2	CHAIN 1				
1	2412	19.39	18.74	161.713	22.09	30	PASS
6	2437	22.16	22.15	328.496	25.17	30	PASS
11	2462	18.10	18.15	129.878	21.14	30	PASS

802.11n (HT40), 2Tx

CHANNEL	FREQUENCY (MHz)	AVERAGE POWER (dBm)		TOTAL POWER (mW)	TOTAL POWER (dBm)	LIMIT (dBm)	PASS / FAIL
		CHAIN 2	CHAIN 1				
3	2422	16.55	17.49	101.291	20.06	30	PASS
6	2437	19.76	20.23	200.063	23.01	30	PASS
9	2452	17.62	18.18	123.576	20.92	30	PASS



A D T

4.5 POWER SPECTRAL DENSITY MEASUREMENT

4.5.1 LIMITS OF POWER SPECTRAL DENSITY MEASUREMENT

The Maximum of Power Spectral Density Measurement is 8dBm.

4.5.2 TEST INSTRUMENTS

DESCRIPTION & MANUFACTURER	MODEL NO.	SERIAL NO.	CALIBRATED DATE	CALIBRATED UNTIL
Spectrum Analyzer R&S	FSP 40	100036	Jan. 21, 2014	Jan. 20, 2015

Note:

1. The calibration interval of the above test instruments is 12 months and the calibrations are traceable to NML/ROC and NIST/USA.
2. Tested date : Feb. 26, 2014

4.5.3 TEST PROCEDURE

1. Set the RBW = 30 kHz, VBW =100 kHz, Detector = power averaging (RMS).
2. Ensure that the number of measurement points in the sweep $\geq 2 \times$ span/RBW
3. Sweep time = auto couple,
4. Employ trace averaging (RMS) mode over a minimum of 100 traces.
5. Use the peak marker function to determine the maximum amplitude level.

4.5.4 DEVIATION FROM TEST STANDARD

No deviation

4.5.5 TEST SETUP

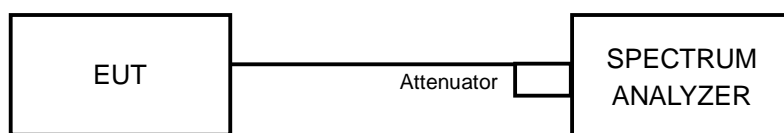

4.5.6 EUT OPERATING CONDITION

Same as Item 4.3.6



A D T

4.5.7 TEST RESULTS

802.11b, 1Tx

CHANNEL	FREQUENCY (MHz)	PSD (dBm)	LIMIT (dBm)	PASS /FAIL
1	2412	-6.27	8	PASS
6	2437	-6.14	8	PASS
11	2462	-6.12	8	PASS

802.11g, 1Tx

CHANNEL	FREQUENCY (MHz)	PSD (dBm)	LIMIT (dBm)	PASS /FAIL
1	2412	-11.08	8	PASS
6	2437	-10.00	8	PASS
11	2462	-12.70	8	PASS

802.11n(HT20), 1Tx

CHANNEL	FREQUENCY (MHz)	PSD (dBm)	LIMIT (dBm)	PASS /FAIL
1	2412	-12.62	8	PASS
6	2437	-9.93	8	PASS
11	2462	-13.36	8	PASS

802.11n(HT40), 1Tx

CHANNEL	FREQUENCY (MHz)	PSD (dBm)	LIMIT (dBm)	PASS /FAIL
3	2422	-17.83	8	PASS
6	2437	-14.90	8	PASS
9	2452	-17.30	8	PASS



A D T

SPECTRUM PLOT OF WORST VALUE

802.11b / CH11

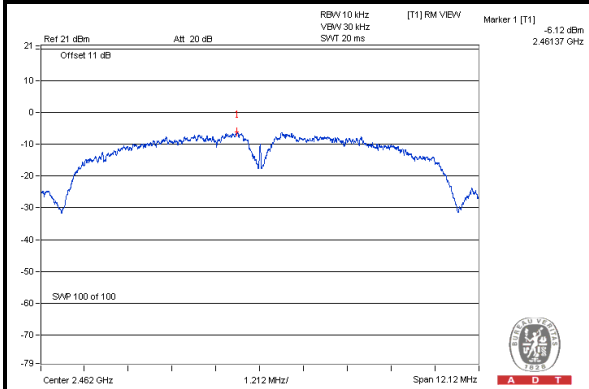

802.11g / CH6

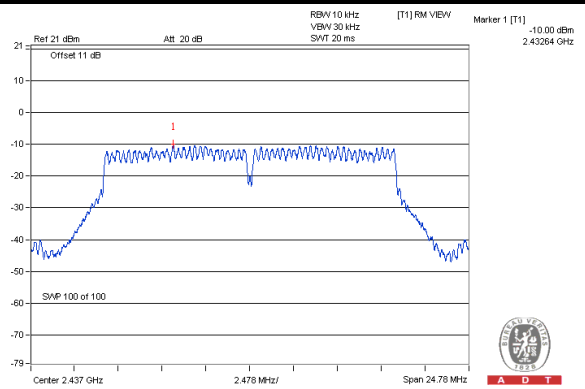

802.11n (HT20) / CH6

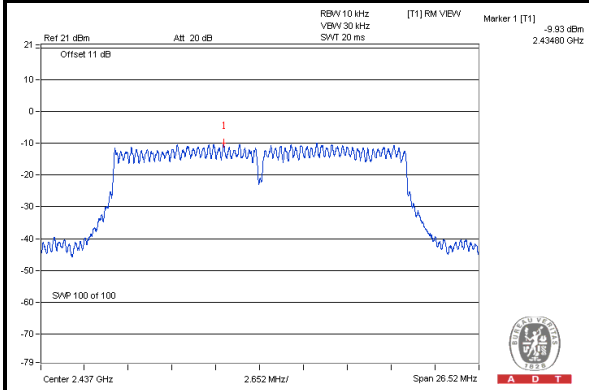

802.11n (HT40) / CH6

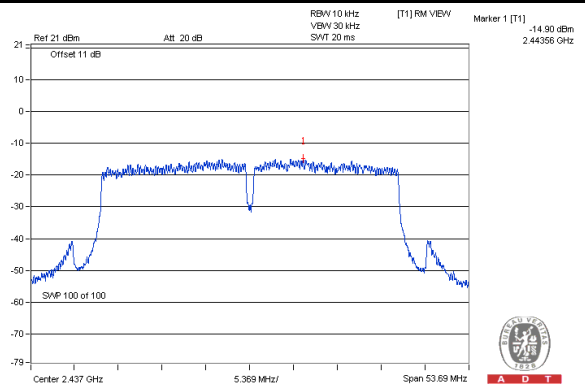



A D T

802.11g, 2Tx

TX CHAIN	CHANNEL	FREQUENCY (MHz)	PSD (dBm)	10 log (N=2) dB	TOTAL PSD (dBm)	LIMIT (dBm)	PASS /FAIL
2	1	2412	-11.93	3.01	-8.92	8	PASS
	6	2437	-9.93	3.01	-6.92	8	PASS
	11	2462	-14.00	3.01	-10.99	8	PASS
1	1	2412	-12.25	3.01	-9.24	8	PASS
	6	2437	-10.07	3.01	-7.06	8	PASS
	11	2462	-13.85	3.01	-10.84	8	PASS

NOTE: 1. Directional gain = $10 \log[(10^{G1/20} + 10^{G2/20})^2 / 2] = 5.22\text{dBi} < 6\text{dBi}$, so the power density limit shall not be reduced.

802.11n(HT20), 2Tx

TX CHAIN	CHANNEL	FREQUENCY (MHz)	PSD (dBm)	10 log (N=2) dB	TOTAL PSD (dBm)	LIMIT (dBm)	PASS /FAIL
2	1	2412	-13.05	3.01	-10.04	8	PASS
	6	2437	-10.10	3.01	-7.09	8	PASS
	11	2462	-14.33	3.01	-11.32	8	PASS
1	1	2412	-13.62	3.01	-10.61	8	PASS
	6	2437	-10.40	3.01	-7.39	8	PASS
	11	2462	-14.27	3.01	-11.26	8	PASS

NOTE: 1. Directional gain = $10 \log[(10^{G1/20} + 10^{G2/20})^2 / 2] = 5.22\text{dBi} < 6\text{dBi}$, so the power density limit shall not be reduced.

802.11n(HT40), 2Tx

TX CHAIN	CHANNEL	FREQUENCY (MHz)	PSD (dBm)	10 log (N=2) dB	TOTAL PSD (dBm)	LIMIT (dBm)	PASS /FAIL
2	3	2422	-19.22	3.01	-16.21	8	PASS
	6	2437	-16.02	3.01	-13.01	8	PASS
	9	2452	-17.48	3.01	-14.47	8	PASS
1	3	2422	-18.19	3.01	-15.18	8	PASS
	6	2437	-14.81	3.01	-11.80	8	PASS
	9	2452	-17.67	3.01	-14.66	8	PASS

NOTE: 1. Directional gain = $10 \log[(10^{G1/20} + 10^{G2/20})^2 / 2] = 5.22\text{dBi} < 6\text{dBi}$, so the power density limit shall not be reduced.



A D T

SPECTRUM PLOT OF WORST VALUE

802.11g_Chain 2 / CH6

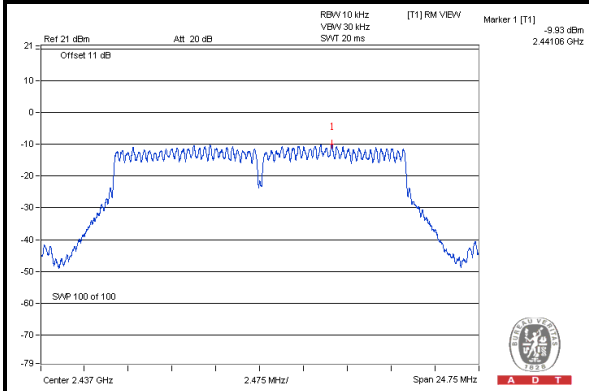

802.11n (HT20)_Chain 2 / CH6

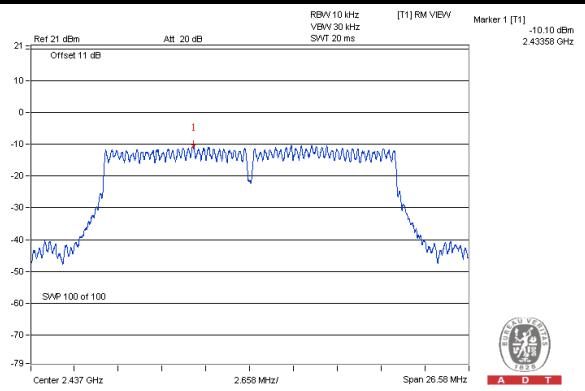

802.11n (HT40)_Chain 1 / CH6

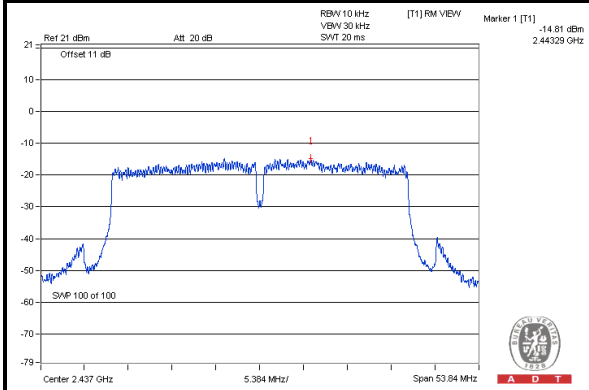



A D T

4.6 CONDUCTED OUT-BAND EMISSION MEASUREMENT

4.6.1 LIMITS OF CONDUCTED OUT-BAND EMISSION MEASUREMENT

Below 30dB of the highest emission level of operating band (in 100kHz Resolution Bandwidth).

4.6.2 TEST INSTRUMENTS

DESCRIPTION & MANUFACTURER	MODEL NO.	SERIAL NO.	CALIBRATED DATE	CALIBRATED UNTIL
Spectrum Analyzer R&S	FSP 40	100036	Jan. 21, 2014	Jan. 20, 2015

Note:

1. The calibration interval of the above test instruments is 12 months and the calibrations are traceable to NML/ROC and NIST/USA.
2. Tested date : Feb. 26, 2014

4.6.3 TEST PROCEDURE

Measurement Procedure - Reference Level

1. Set the RBW = 100 kHz.
2. Set the VBW \geq 300 kHz.
3. Detector = peak.
4. Sweep time = auto couple.
5. Trace mode = max hold.
6. Allow trace to fully stabilize.
7. Use the peak marker function to determine the maximum power level in any 100 kHz band segment within the fundamental EBW.

Measurement Procedure –Unwanted Emission Level

1. Set RBW = 100 kHz.
2. Set VBW \geq 300 kHz.
3. Set span to encompass the spectrum to be examined
4. Detector = peak.
5. Trace Mode = max hold.
6. Sweep = auto couple.

4.6.4 DEVIATION FROM TEST STANDARD

No deviation

4.6.5 TEST SETUP

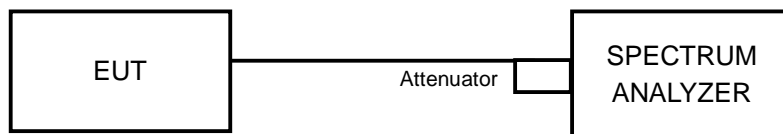

4.6.6 EUT OPERATING CONDITION

Same as Item 4.3.6

4.6.7 TEST RESULTS

The spectrum plots are attached on the following pages. D1 line indicates the highest level, and D2 line indicates the 30dB offset below D1. It shows compliance with the requirement.



A D T

802.11b, 1Tx:

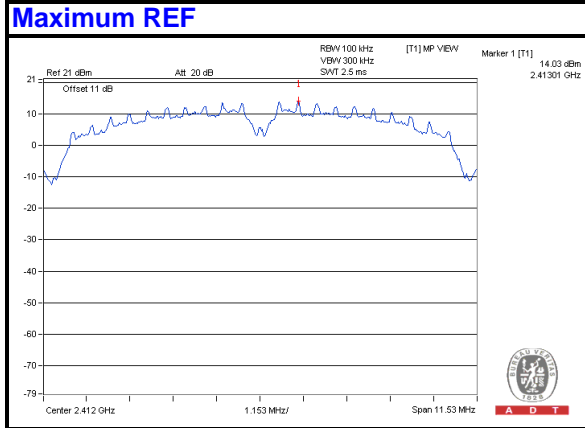

CH 1

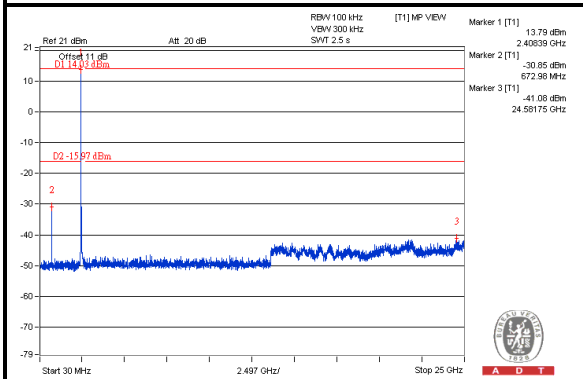

CH 6

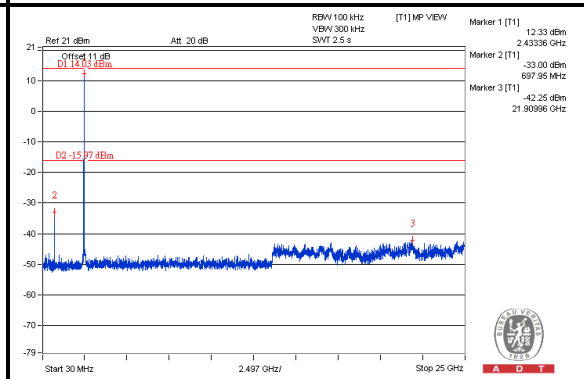

CH 11

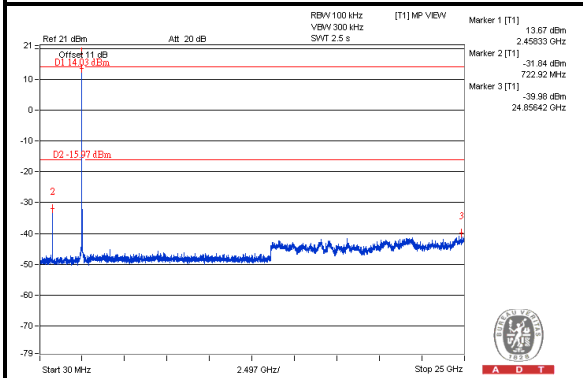

CH 1 Band edge

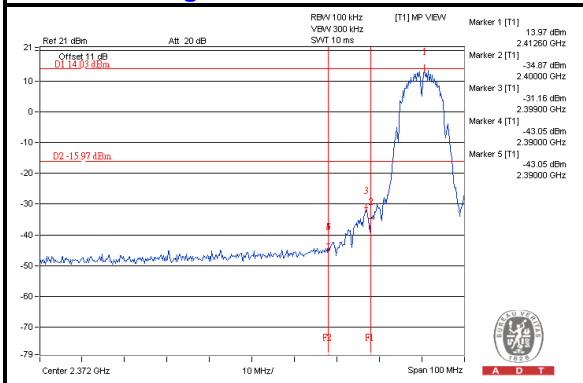

CH 11 Band edge

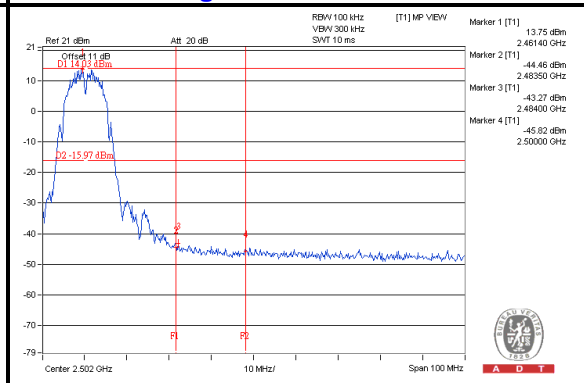



A D T

802.11g, 1Tx:

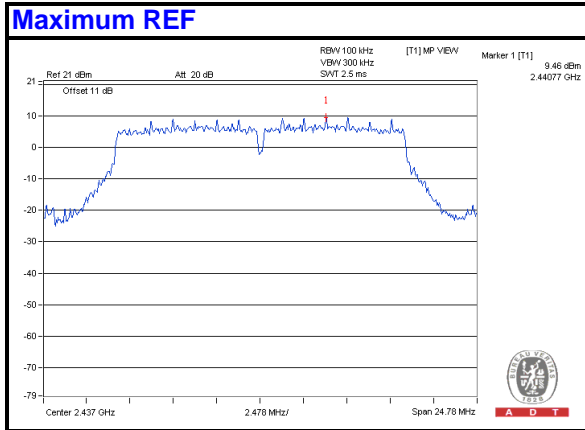

CH 1

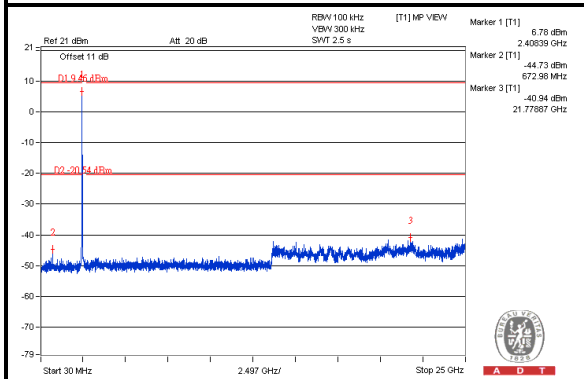

CH 6

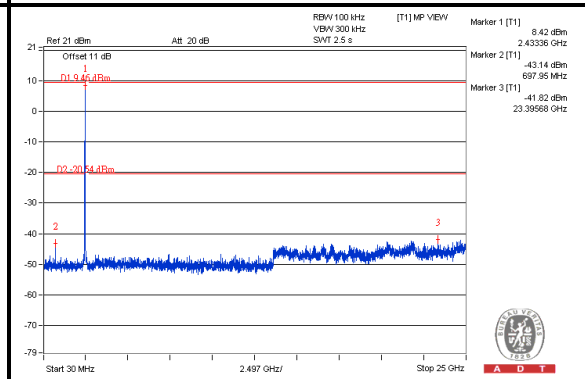

CH 11

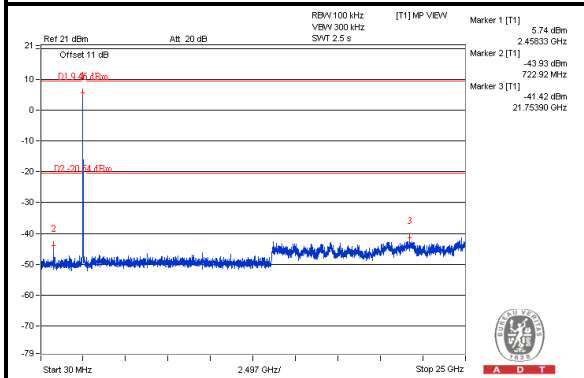

CH 1 Band edge

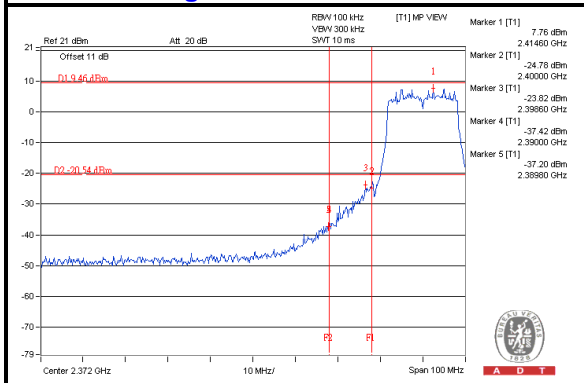

CH 11 Band edge

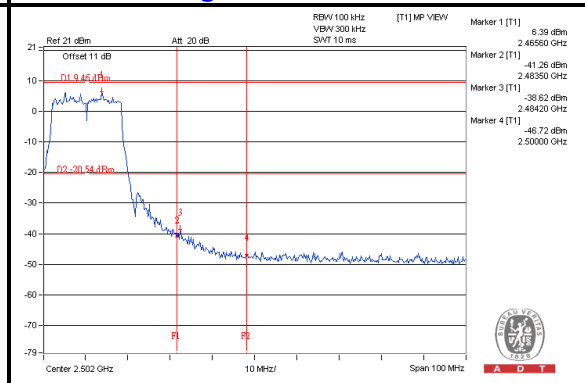



A D T

802.11n(HT20), 1Tx:

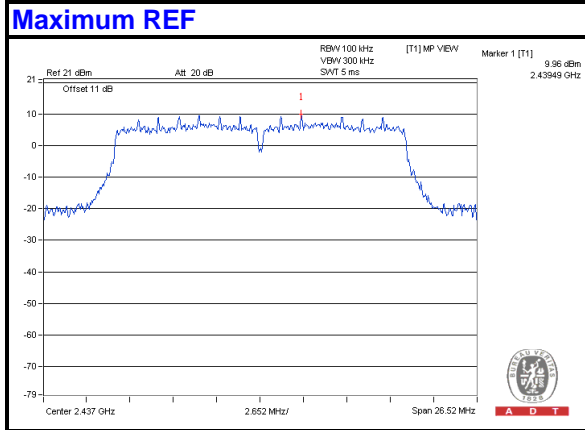

CH 1

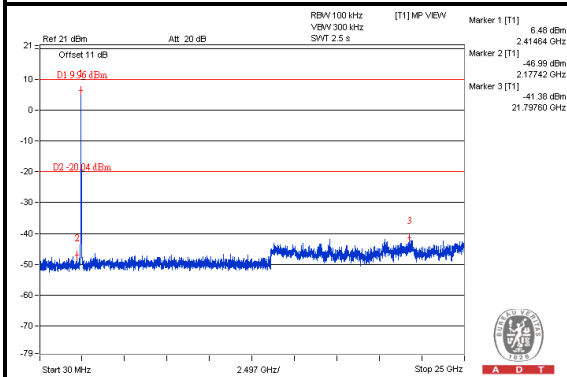

CH 6

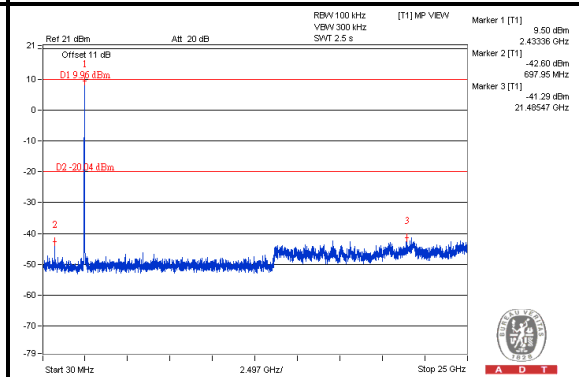

CH 11

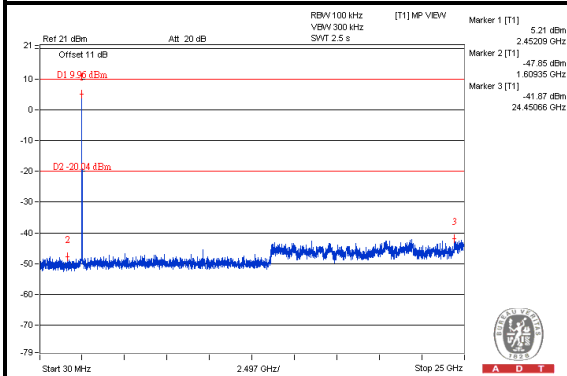

CH 1 Band edge

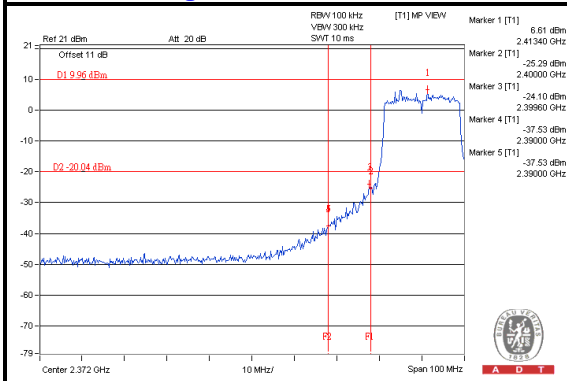

CH 11 Band edge

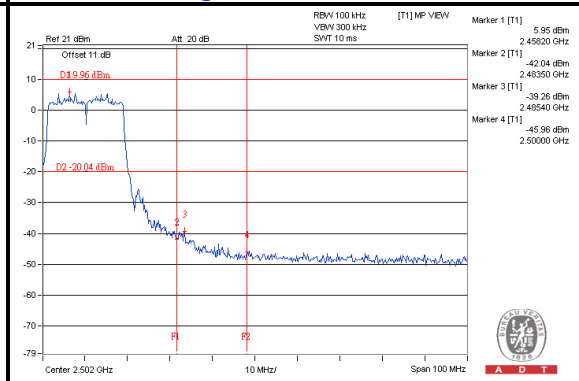



A D T

802.11n(HT40), 1Tx:

Maximum REF

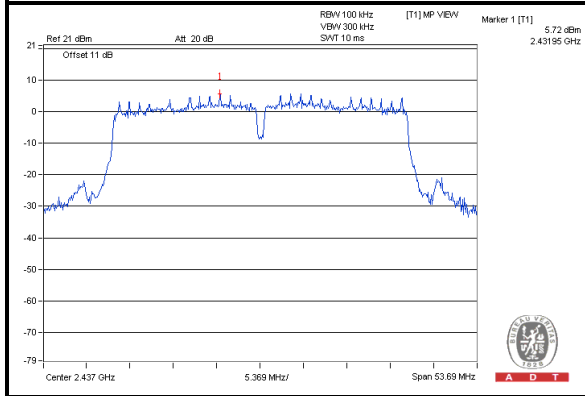

CH 3

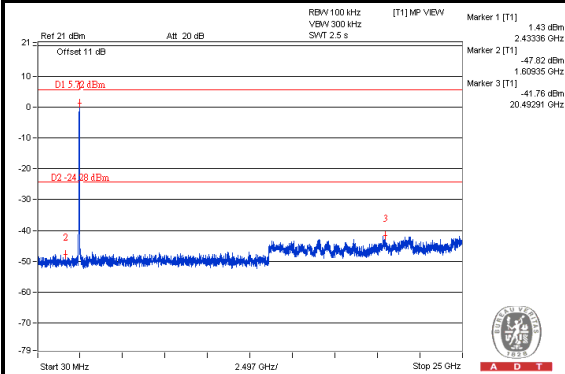

CH 6

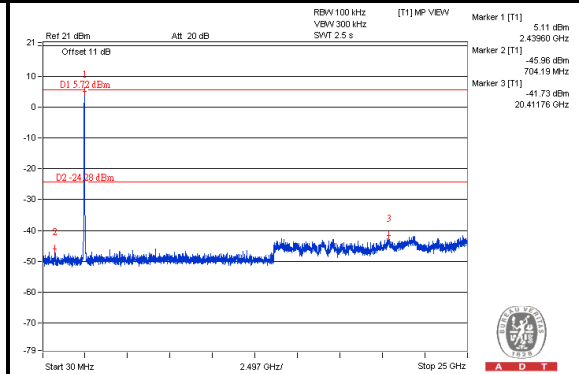

CH 9

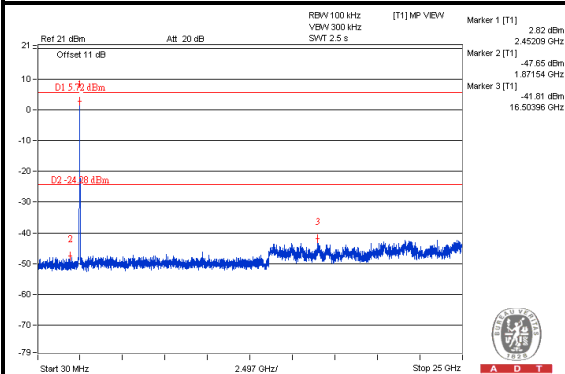

CH 3 Band edge

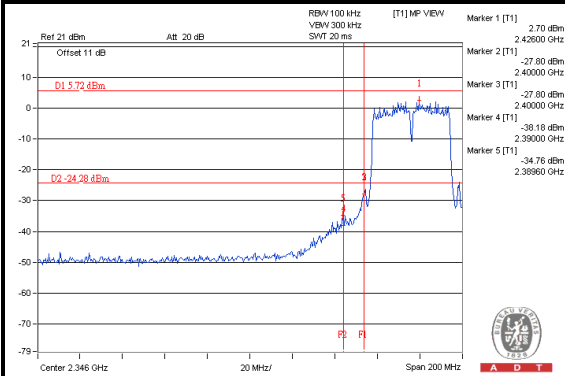

CH 9 Band edge

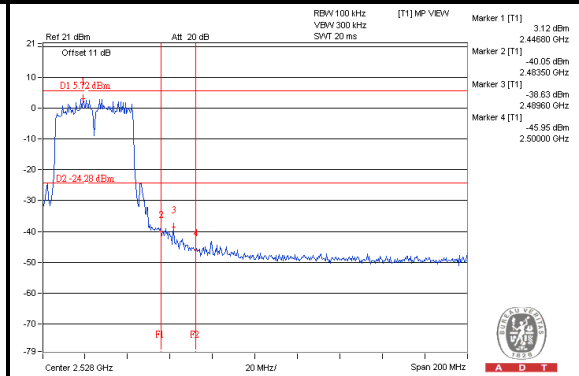



A D T

802.11g, 2Tx:

Maximum REF

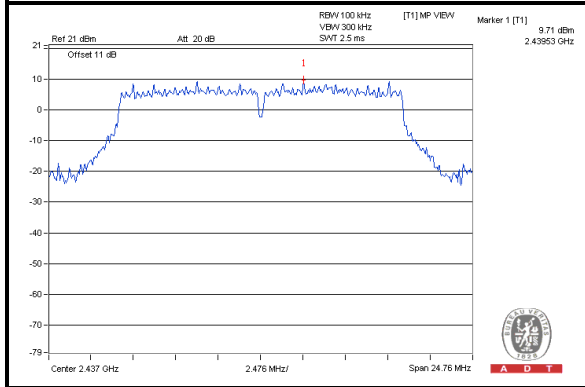

Chain 2

CH 1

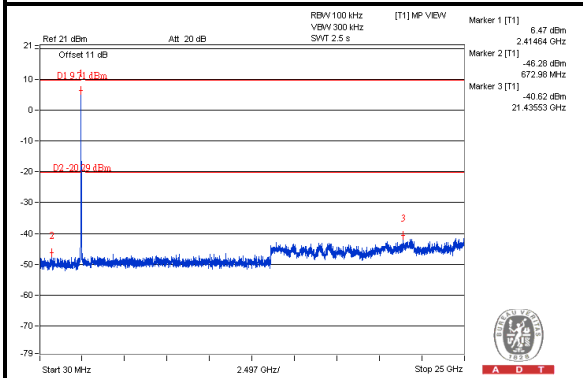

CH 6

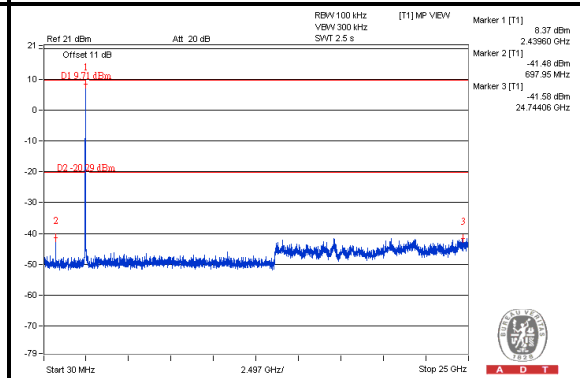

CH 11

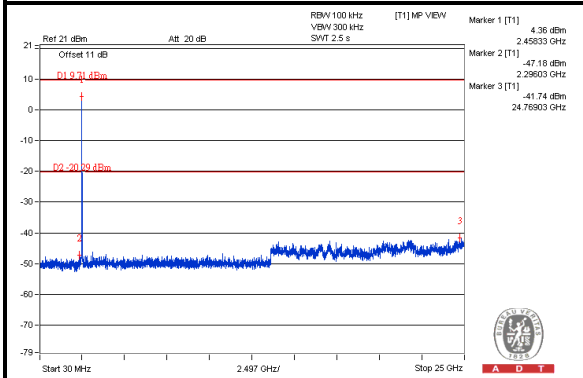

CH 1 Band edge

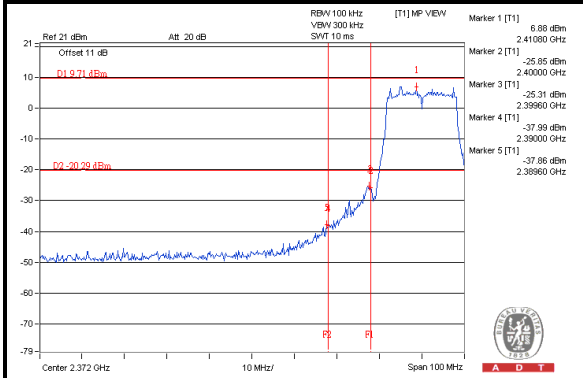

CH 11 Band edge

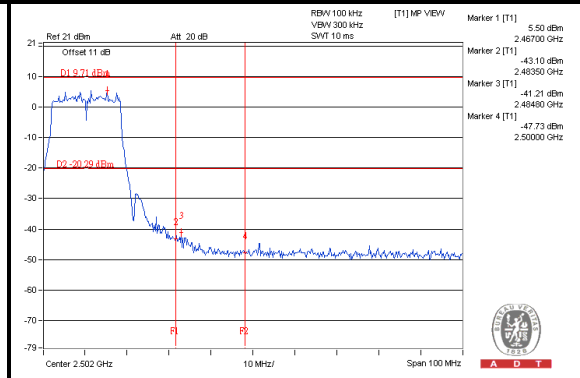



A D T

Chain 1 CH 1

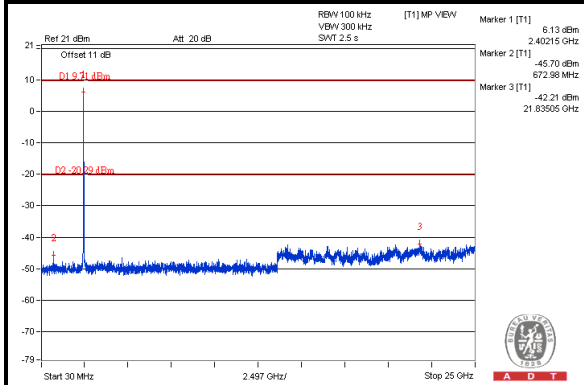

CH 6

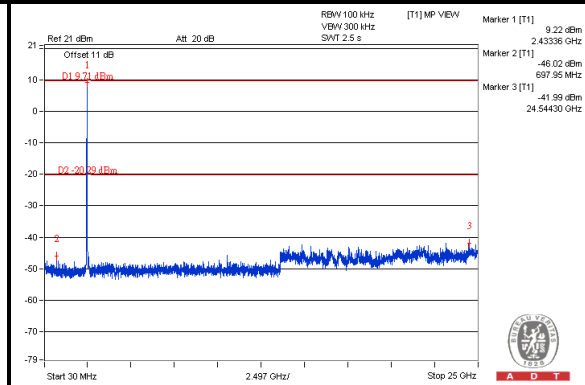

CH 11

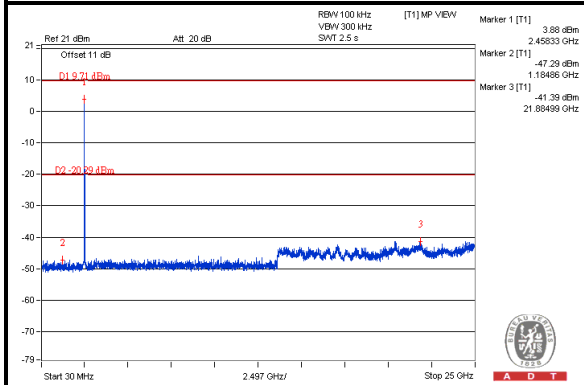

CH 1 Band edge

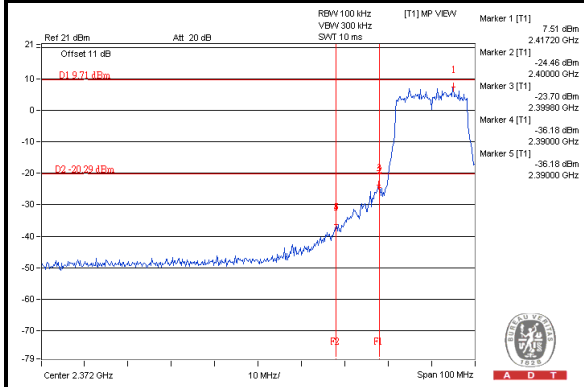

CH 11 Band edge

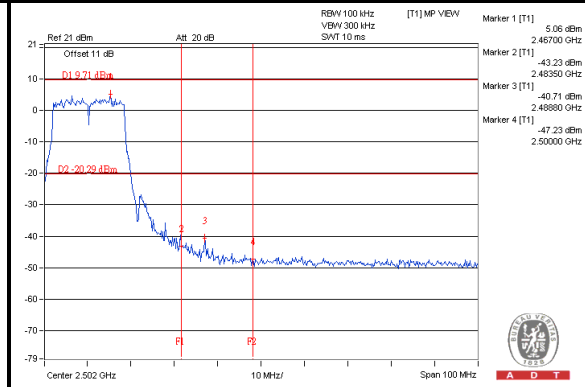



A D T

802.11n(HT20), 2Tx:

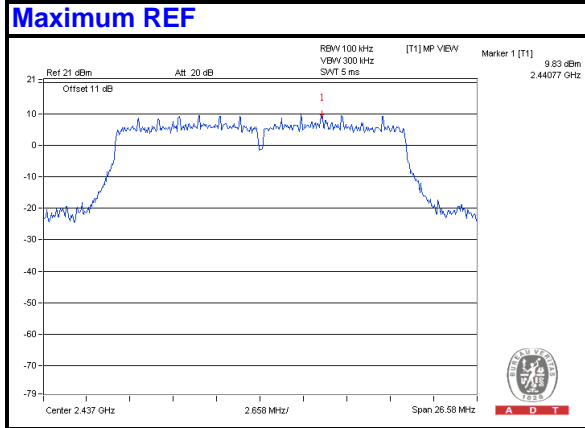

Chain 2

CH 1

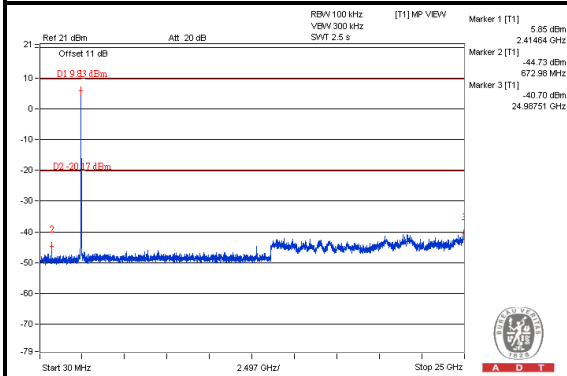

CH 6

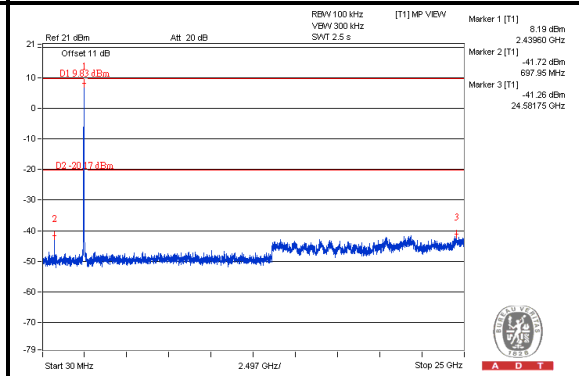

CH 11

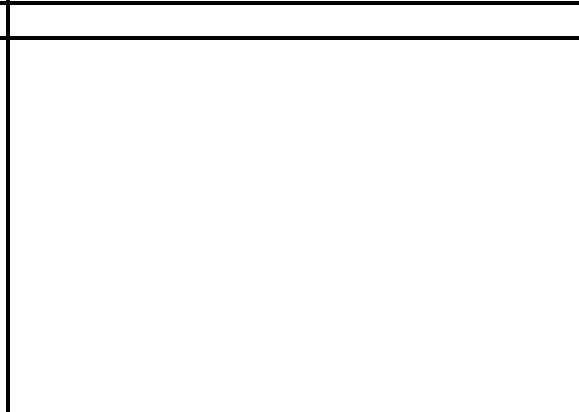
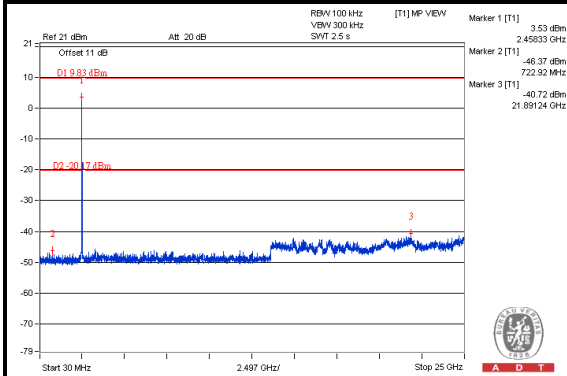

CH 1 Band edge

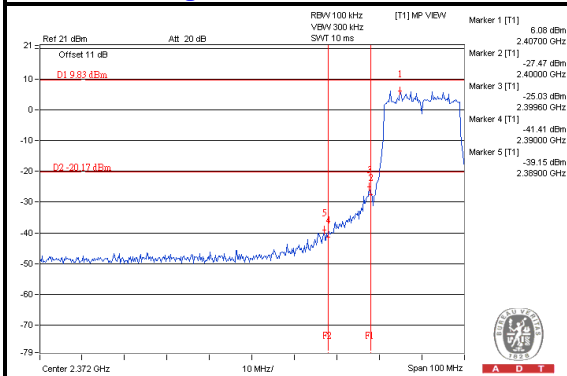

CH 11 Band edge

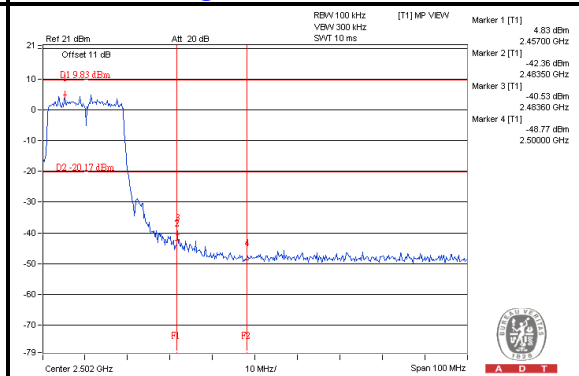



A D T

Chain 1 CH 1

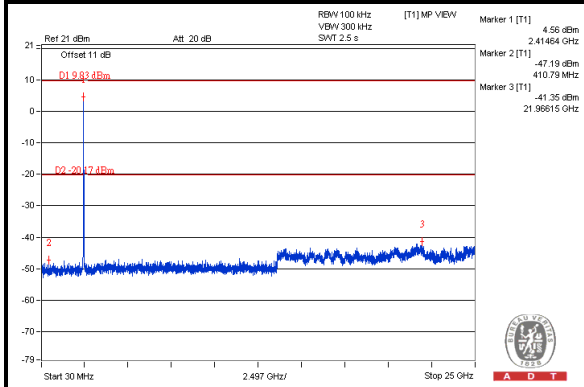

CH 6

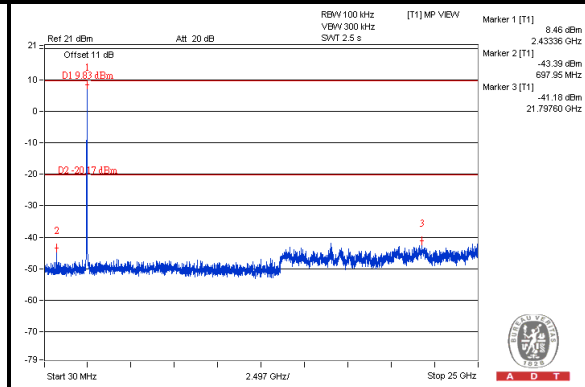

CH 11

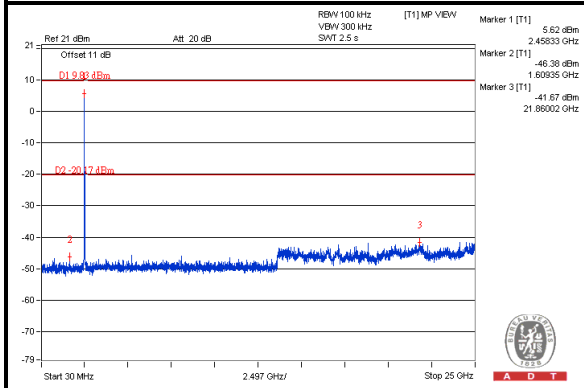

CH 1 Band edge

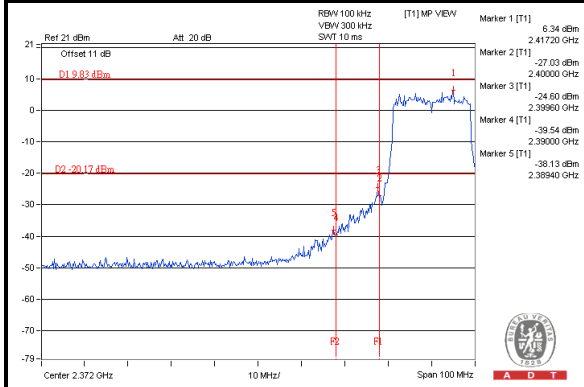

CH 11 Band edge

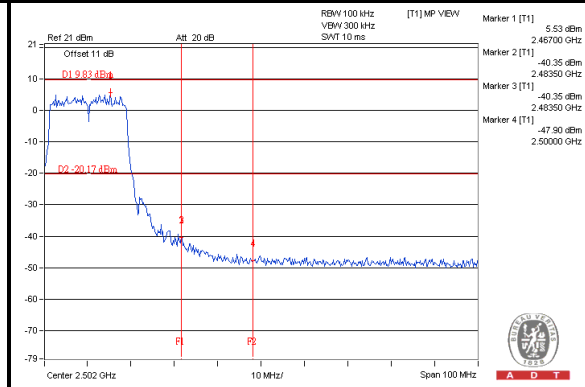



A D T

802.11n(HT40), 2Tx:

Maximum REF

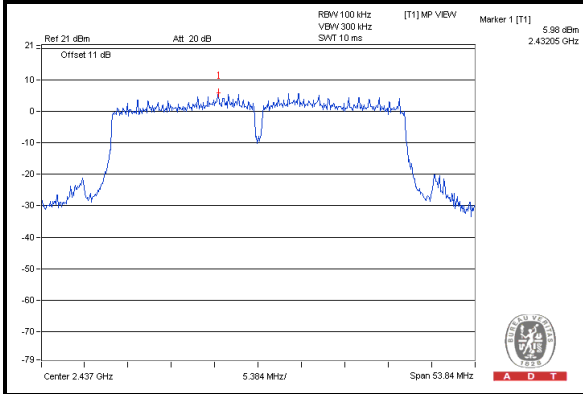

Chain 2

CH 3

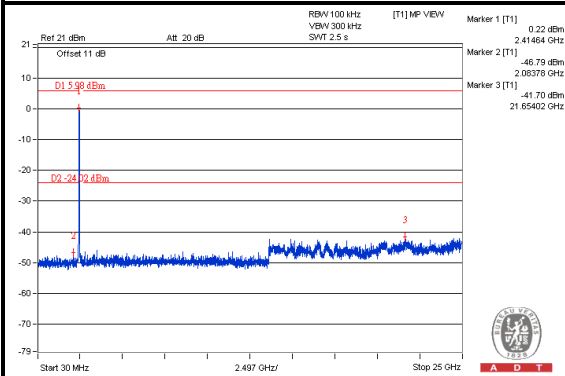

CH 6

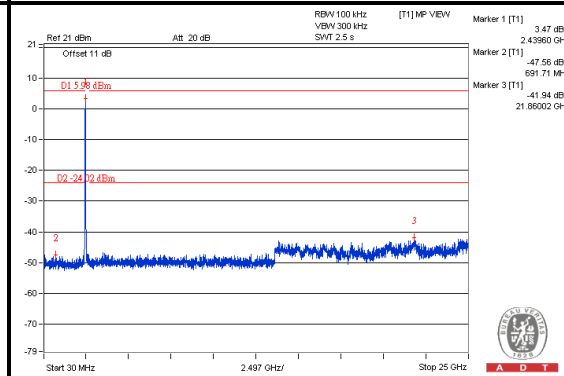

CH 9

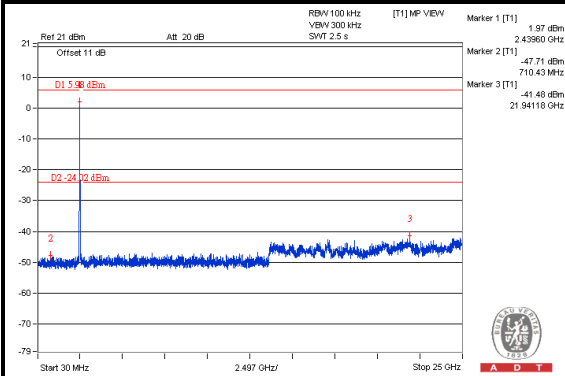

CH 3 Band edge

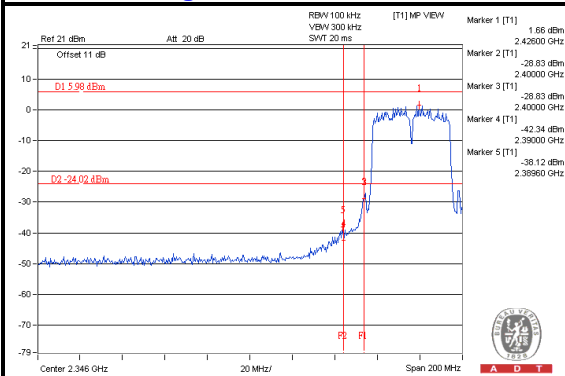

CH 9 Band edge

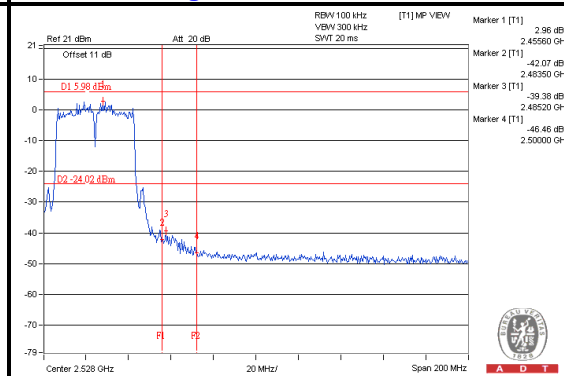



A D T

Chain 1 CH 3

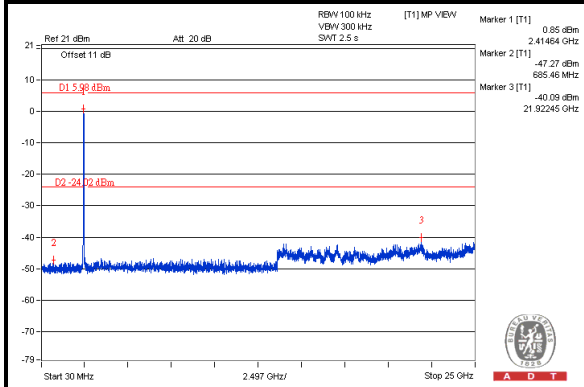

CH 6

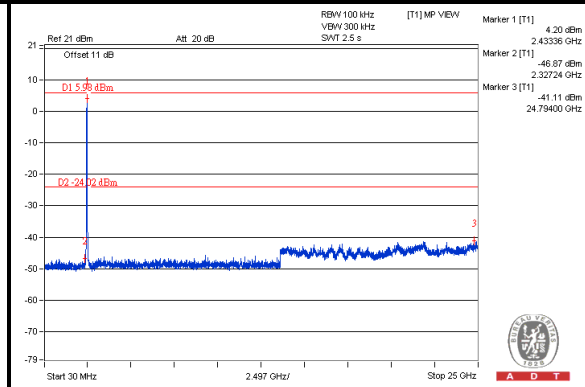

CH 9

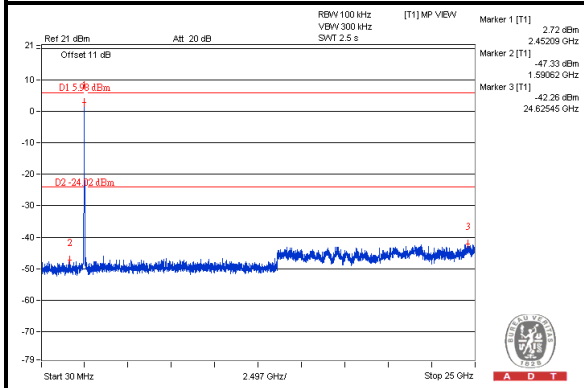

CH 3 Band edge

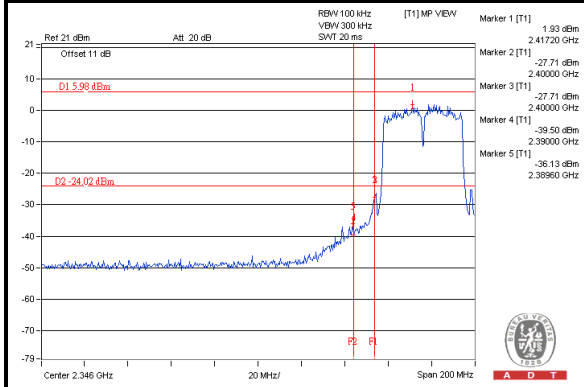

CH 9 Band edge

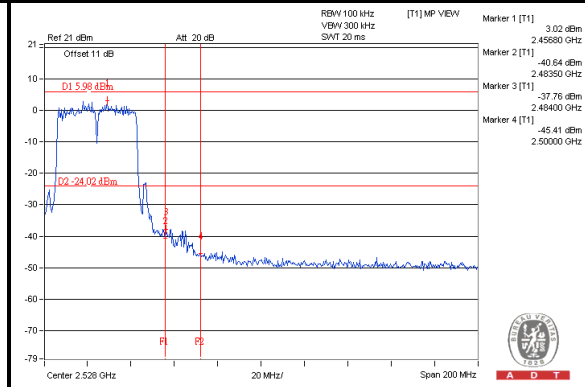

5. TEST TYPES AND RESULTS (FOR 5GHZ, 5.725~5.850GHz Band)

5.1 CONDUCTED EMISSION MEASUREMENT

5.1.1 LIMITS OF CONDUCTED EMISSION MEASUREMENT

FREQUENCY OF EMISSION (MHz)	CONDUCTED LIMIT (dB μ V)	
	Quasi-peak	Average
0.15-0.5	66 to 56	56 to 46
0.5-5	56	46
5-30	60	50

- NOTE:**
1. The lower limit shall apply at the transition frequencies.
 2. The limit decreases in line with the logarithm of the frequency in the range of 0.15 to 0.50 MHz.

5.1.2 TEST INSTRUMENTS

DESCRIPTION & MANUFACTURER	MODEL NO.	SERIAL NO.	CALIBRATED DATE	CALIBRATED UNTIL
Test Receiver ROHDE & SCHWARZ	ESCS 30	100375	Mar. 08, 2013	Mar. 07, 2014
Line-Impedance Stabilization Network (for EUT) SCHWARZBECK	NSLK8127	8127-522	Sep. 05, 2013	Sep. 04, 2014
Line-Impedance Stabilization Network (for Peripheral)	ENV216	100072	June 06, 2013	June 05, 2014
RF Cable (JYEBAO)	5DFB	COCCAB-001	Mar. 11, 2013	Mar. 10, 2014
50 ohms Terminator	50	EMC-03	Sep. 24, 2013	Sep. 23, 2014
Software ADT	BV ADT_Cond_V7.3.7. 3	NA	NA	NA

Note:

1. The calibration interval of the above test instruments is 12 months and the calibrations are traceable to NML/ROC and NIST/USA.
2. The test was performed in Shielded Room No. C.
3. The VCCI Con C Registration No. is C-3611.
4. Tested Date: Jan. 27, 2014

5.1.3 TEST PROCEDURES

- a. The EUT was placed 0.4 meters from the conducting wall of the shielded room with EUT being connected to the power mains through a line impedance stabilization network (LISN). Other support units were connected to the power mains through another LISN.
- b. The two LISNs provide 50 ohm/ 50uH of coupling impedance for the measuring instrument.
- c. Both lines of the power mains connected to the EUT were checked for maximum conducted interference.
- d. The frequency range from 150kHz to 30MHz was searched. Emission levels under (Limit – 20dB) were not recorded.

NOTE:

1. The resolution bandwidth of test receiver is 9kHz for Quasi-peak detection (QP) & Average detection (AV).

5.1.4 DEVIATION FROM TEST STANDARD

No deviation

5.1.5 TEST SETUP

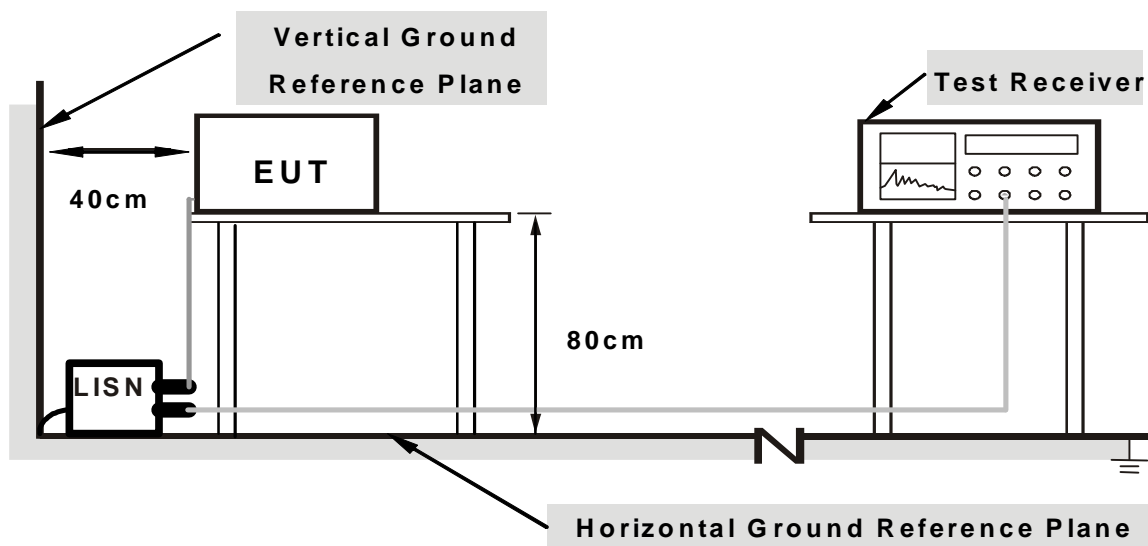

Note: 1.Support units were connected to second LISN.

For the actual test configuration, please refer to the related item – Photographs of the Test Configuration.

5.1.6 EUT OPERATING CONDITIONS

Same as the 4.1.6

5.1.7 TEST RESULTS

PHASE	Line (L)	DETECTOR FUNCTION	Quasi-Peak (QP) / Average (AV)
--------------	----------	--------------------------	--------------------------------

No	Freq. [MHz]	Corr. Factor (dB)	Reading Value		Emission Level		Limit		Margin	
			[dB (uV)]		[dB (uV)]		[dB (uV)]		(dB)	
			Q.P.	AV.	Q.P.	AV.	Q.P.	AV.	Q.P.	AV.
1	0.15391	0.08	48.40	37.13	48.48	37.21	65.79	55.79	-17.30	-18.57
2	0.16562	0.09	45.69	29.17	45.78	29.26	65.18	55.18	-19.40	-25.92
3	0.18906	0.10	41.77	30.91	41.87	31.01	64.08	54.08	-22.21	-23.07
4	0.23984	0.11	37.24	22.66	37.35	22.77	62.10	52.10	-24.75	-29.33
5	6.73828	0.37	26.32	21.56	26.69	21.93	60.00	50.00	-33.31	-28.07
6	7.42969	0.39	26.11	22.58	26.50	22.97	60.00	50.00	-33.50	-27.03

REMARKS:

1. Q.P. and AV. are abbreviations of quasi-peak and average individually.
2. The emission levels of other frequencies were very low against the limit.
3. Margin value = Emission Level – Limit value
4. Correction Factor = Insertion loss + Cable loss
5. Emission Level = Correction Factor + Reading Value

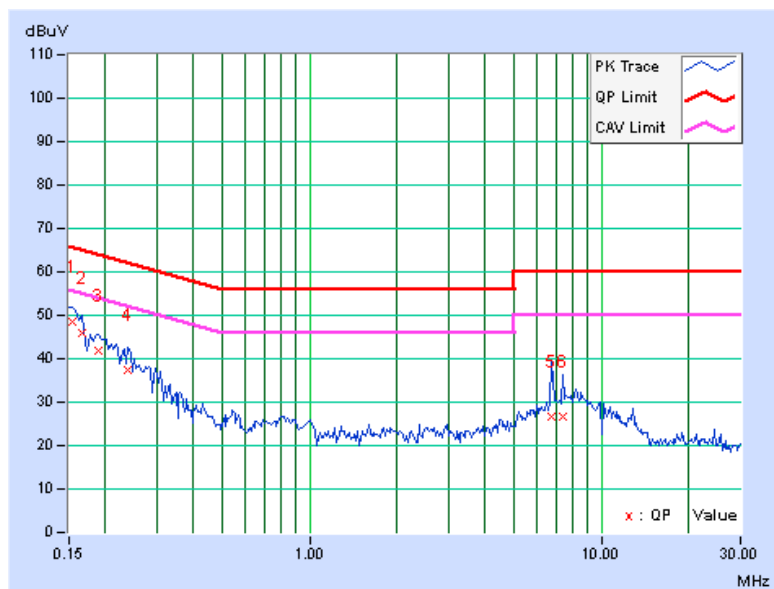

PHASE	Neutral (N)	DETECTOR FUNCTION	Quasi-Peak (QP) / Average (AV)
--------------	-------------	--------------------------	--------------------------------

No	Freq. [MHz]	Corr. Factor (dB)	Reading Value [dB (uV)]		Emission Level [dB (uV)]		Limit [dB (uV)]		Margin (dB)	
			Q.P.	AV.	Q.P.	AV.	Q.P.	AV.	Q.P.	AV.
1	0.15000	0.09	48.60	37.33	48.69	37.42	66.00	56.00	-17.31	-18.58
2	0.15781	0.09	46.90	35.39	46.99	35.48	65.58	55.58	-18.59	-20.10
3	0.18906	0.10	42.26	29.32	42.36	29.42	64.08	54.08	-21.72	-24.66
4	0.22422	0.10	38.57	24.38	38.67	24.48	62.66	52.66	-23.99	-28.18
5	0.23984	0.11	37.80	26.15	37.91	26.26	62.10	52.10	-24.19	-25.84
6	7.42578	0.39	27.01	22.38	27.40	22.77	60.00	50.00	-32.60	-27.23

REMARKS:

1. Q.P. and AV. are abbreviations of quasi-peak and average individually.
2. The emission levels of other frequencies were very low against the limit.
3. Margin value = Emission Level – Limit value
4. Correction Factor = Insertion loss + Cable loss
5. Emission Level = Correction Factor + Reading Value

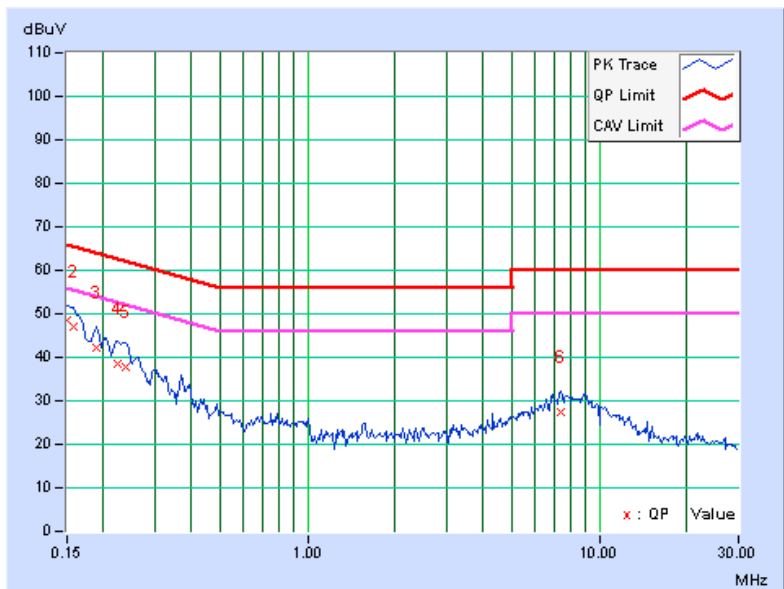



A D T

5.2 RADIATED AND BANDEGE EMISSION MEASUREMENT

5.2.1 LIMITS OF RADIATED AND BANDEGE EMISSION MEASUREMENT

Radiated emissions which fall in the restricted bands must comply with the radiated emission limits specified as below table. Other emissions shall be at least 30dB below the highest level of the desired power:

Frequencies (MHz)	Field strength (microvolts/meter)	Measurement distance (meters)
0.009-0.490	2400/F(kHz)	300
0.490-1.705	24000/F(kHz)	30
1.705-30.0	30	30
30-88	100	3
88-216	150	3
216-960	200	3
Above 960	500	3

NOTE:

1. The lower limit shall apply at the transition frequencies.
2. Emission level (dBuV/m) = 20 log Emission level (uV/m).
3. For frequencies above 1000MHz, the field strength limits are based on average detector, however, the peak field strength of any emission shall not exceed the maximum permitted average limits, specified above by more than 20dB under any condition of modulation.



A D T

5.2.2 TEST INSTRUMENTS

For below 1GHz test

DESCRIPTION & MANUFACTURER	MODEL NO.	SERIAL NO.	CALIBRATED DATE	CALIBRATED UNTIL
MXE EMI Receiver Agilent	N9038A	MY50010156	Jan. 15, 2014	Jan. 14, 2015
Pre-Amplifier Mini-Circuits	ZFL-1000VH2 B	AMP-ZFL-04	Nov. 13, 2013	Nov. 12, 2014
Trilog Broadband Antenna SCHWARZBECK	VULB 9168	9168-361	Mar. 25, 2013	Mar. 24, 2014
RF Cable	NA	CHHCAB_001	Oct. 06, 2013	Oct. 05, 2014
Spectrum Analyzer R&S	FSV40	100964	July 15, 2013	July 14, 2014
Horn_Antenna AISI	AIH.8018	0000220091110	Dec. 06, 2013	Dec. 05, 2014
Pre-Amplifier Agilent	8449B	3008A01923	Oct. 29, 2013	Oct. 28, 2014
RF Cable	NA	RF104-205 RF104-207 RF104-202	Dec. 12, 2013	Dec. 11, 2014
Spectrum Analyzer Agilent	E4446A	MY48250253	Aug. 28, 2013	Aug. 27, 2014
Pre-Amplifier SPACEK LABS	SLKKa-48-6	9K16	Nov. 13, 2013	Nov. 12, 2014
Horn_Antenna SCHWARZBECK	BBHA 9170	9170-424	Oct. 08, 2013	Oct. 07, 2014
Software	ADT_Radiated _V8.7.07	NA	NA	NA
Antenna Tower & Turn Table CT	NA	NA	NA	NA

Note:

1. The calibration interval of the above test instruments is 12 months and the calibrations are traceable to NML/ROC and NIST/USA.
2. The horn antenna, preamplifier (model: 8449B) are used only for the measurement of emission frequency above 1GHz if tested.
3. The test was performed in 966 Chamber No. H.
4. The FCC Site Registration No. is 797305.
5. The CANADA Site Registration No. is IC 7450H-3.
6. Tested Date: Feb. 24, 2014



A D T

For above 1GHz test

DESCRIPTION & MANUFACTURER	MODEL NO.	SERIAL NO.	CALIBRATED DATE	CALIBRATED UNTIL
MXE EMI Receiver Agilent	N9038A	MY51210105	Jan. 21, 2014	Jan. 20, 2015
Pre-Amplifier Mini-Circuits	ZFL-1000VH2 B	AMP-ZFL-03	Nov. 13, 2013	Nov. 12, 2014
Trilog Broadband Antenna SCHWARZBECK	VULB 9168	9168-360	Mar. 19, 2013	Mar. 18, 2014
RF Cable	NA	CHGCAB_001	Oct. 05, 2013	Oct. 04, 2014
Spectrum Analyzer R&S	FSV40	100964	July 15, 2013	July 14, 2014
Horn_Antenna AISI	AIH.8018	0000320091110	Nov. 18, 2013	Nov. 17, 2014
Pre-Amplifier Agilent	8449B	3008A02578	June 25, 2013	June 24, 2014
RF Cable	NA	RF104-201 RF104-203 RF104-204	Dec. 12, 2013	Dec. 11, 2014
Spectrum Analyzer Agilent	E4446A	MY48250253	Aug. 28, 2013	Aug. 27, 2014
Pre-Amplifier SPACEK LABS	SLKKa-48-6	9K16	Nov. 13, 2013	Nov. 12, 2014
Horn_Antenna SCHWARZBECK	BBHA 9170	9170-424	Oct. 08, 2013	Oct. 07, 2014
Software	ADT_Radiated _V8.7.07	NA	NA	NA
Antenna Tower & Turn Table CT	NA	NA	NA	NA

Note:

1. The calibration interval of the above test instruments is 12 months and the calibrations are traceable to NML/ROC and NIST/USA.
2. The horn antenna, preamplifier (model: 8449B) are used only for the measurement of emission frequency above 1GHz if tested.
- 3 The test was performed in 966 Chamber No. G.
4. The FCC Site Registration No. is 966073.
- 5 The VCCI Site Registration No. is G-137.
- 6 The CANADA Site Registration No. is IC 7450H-2.
- 7 Tested Date: Feb. 27, 2014

5.2.3 TEST PROCEDURES

- a. The EUT was placed on the top of a rotating table 0.8 meters above the ground at 3 meter chamber room for test. The table was rotated 360 degrees to determine the position of the highest radiation.
- b. The EUT was set 3 meters away from the interference-receiving antenna, which was mounted on the top of a variable-height antenna tower.
- c. The height of antenna is varied from one meter to four meters above the ground to determine the maximum value of the field strength. Both horizontal and vertical polarizations of the antenna are set to make the measurement.
- d. For each suspected emission, the EUT was arranged to its worst case and then the antenna was tuned to heights from 1 meter to 4 meters and the rotatable table was turned from 0 degrees to 360 degrees to find the maximum reading.
- e. The test-receiver system was set to quasi-peak detect function and specified bandwidth with maximum hold mode when the test frequency is below 1 GHz.
- f. The test-receiver system was set to peak and average detect function and specified bandwidth with maximum hold mode when the test frequency is above 1 GHz. If the peak reading value also meets average limit, measurement with the average detector is unnecessary.

Note:

1. The resolution bandwidth and video bandwidth of test receiver/spectrum analyzer is 120kHz for Quasi-peak detection (QP) at frequency below 1GHz.
2. The resolution bandwidth of test receiver/spectrum analyzer is 1 MHz and the video bandwidth is 3 MHz for Peak detection (PK) at frequency above 1GHz.
3. The resolution bandwidth of test receiver/spectrum analyzer is 1MHz and the video bandwidth is 3MHz for RMS Average (Duty cycle < 98%) for Average detection (AV) at frequency above 1GHz, then the measurement results was added to a correction factor ($10 \log(1/\text{duty cycle})$).
4. The resolution bandwidth of test receiver/spectrum analyzer is 1MHz and the video bandwidth is 10Hz (Duty cycle $\geq 98\%$) for Average detection (AV) at frequency above 1GHz.
5. All modes of operation were investigated and the worst-case emissions are reported.

5.2.4 DEVIATION FROM TEST STANDARD

No deviation

5.2.5 TEST SETUP

<Frequency Range below 1GHz>

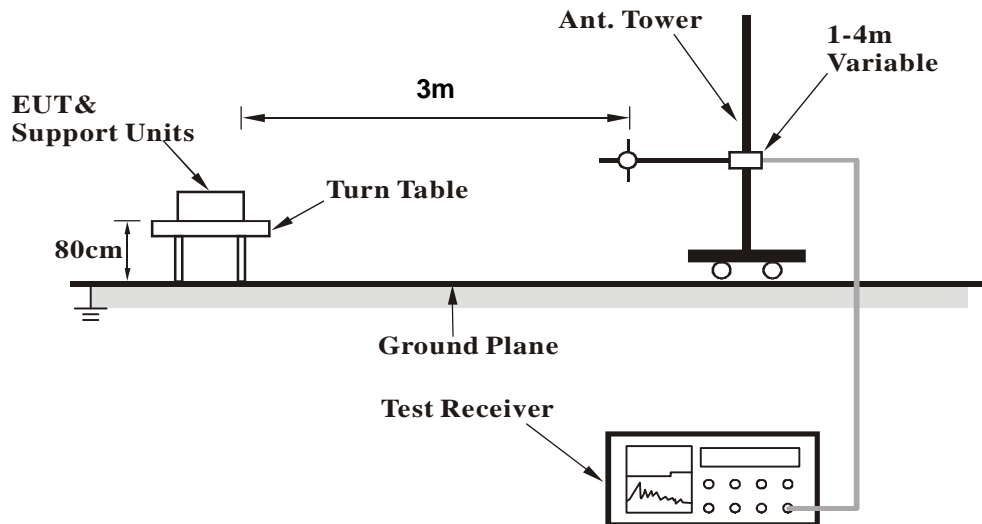

<Frequency Range above 1GHz>

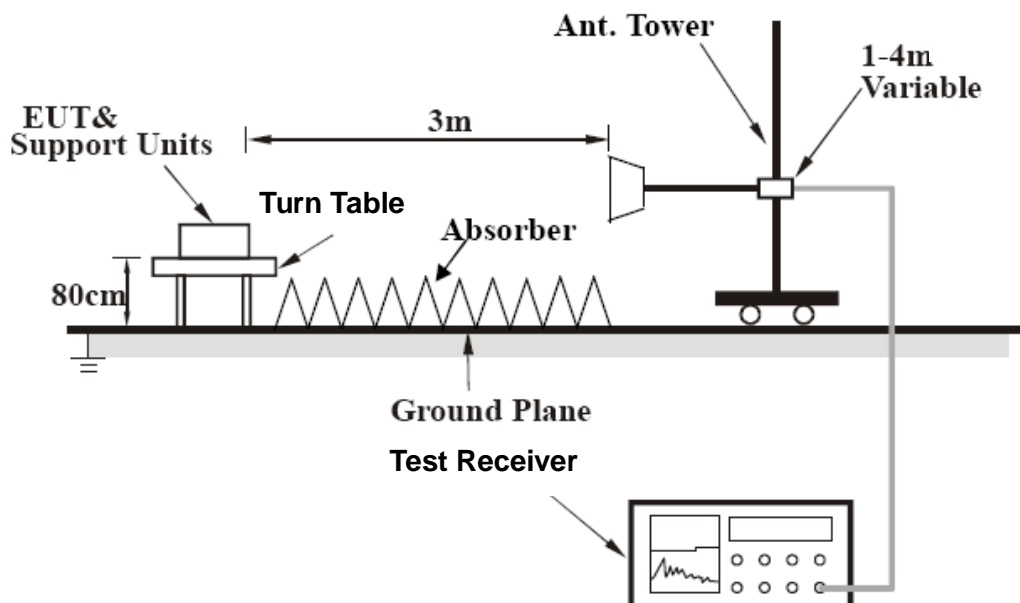

For the actual test configuration, please refer to the related item – Photographs of the Test Configuration.

5.2.6 EUT OPERATING CONDITIONS

Same as the 4.1.6

5.2.7 TEST RESULTS

BELOW 1GHz WORST-CASE DATA

802.11a, 3Tx

CHANNEL	TX Channel 149	DETECTOR FUNCTION	Quasi-Peak (QP)
FREQUENCY RANGE	Below 1GHz		

ANTENNA POLARITY & TEST DISTANCE: HORIZONTAL AT 3 M								
NO.	FREQ. (MHz)	EMISSION LEVEL (dBuV/m)	LIMIT (dBuV/m)	MARGIN (dB)	ANTENNA HEIGHT (m)	TABLE ANGLE (Degree)	RAW VALUE (dBuV)	CORRECTION FACTOR (dB/m)
1	250.00	42.8 QP	46.0	-3.2	1.26 H	305	56.48	-13.67
2	400.01	42.3 QP	46.0	-3.7	1.00 H	226	51.69	-9.36
3	440.02	40.4 QP	46.0	-5.6	1.49 H	243	48.19	-7.81
4	460.00	40.8 QP	46.0	-5.2	1.55 H	213	48.36	-7.60
5	500.01	41.0 QP	46.0	-5.0	1.33 H	247	47.91	-6.91
6	750.03	41.7 QP	46.0	-4.3	1.44 H	254	43.35	-1.68
ANTENNA POLARITY & TEST DISTANCE: VERTICAL AT 3 M								
NO.	FREQ. (MHz)	EMISSION LEVEL (dBuV/m)	LIMIT (dBuV/m)	MARGIN (dB)	ANTENNA HEIGHT (m)	TABLE ANGLE (Degree)	RAW VALUE (dBuV)	CORRECTION FACTOR (dB/m)
1	250.00	40.8 QP	46.0	-5.3	1.43 V	233	54.42	-13.67
2	319.98	37.7 QP	46.0	-8.3	1.00 V	228	48.59	-10.86
3	400.01	37.5 QP	46.0	-8.5	1.43 V	287	46.82	-9.36
4	599.97	38.2 QP	46.0	-7.8	1.44 V	233	42.87	-4.63
5	750.03	38.6 QP	46.0	-7.4	1.00 V	33	40.32	-1.68
6	799.99	37.0 QP	46.0	-9.0	1.00 V	153	38.00	-0.97

REMARKS:

1. Emission Level(dBuV/m) = Raw Value(dBuV) + Correction Factor(dB/m)
2. Correction Factor(dB/m) = Antenna Factor(dB/m) + Cable Factor(dB) – Pre-Amplifier Factor(dB)
3. The other emission levels were very low against the limit.
4. Margin value = Emission Level – Limit value



A D T

ABOVE 1GHz WORST-CASE DATA

802.11a, 1Tx

CHANNEL	TX Channel 149	DETECTOR FUNCTION	Peak (PK)
FREQUENCY RANGE	1GHz ~ 40GHz		Average (AV)

ANTENNA POLARITY & TEST DISTANCE: HORIZONTAL AT 3 M

NO.	FREQ. (MHz)	EMISSION LEVEL (dBuV/m)	LIMIT (dBuV/m)	MARGIN (dB)	ANTENNA HEIGHT (m)	TABLE ANGLE (Degree)	RAW VALUE (dBuV)	CORRECTION FACTOR (dB/m)
1	5150.00	56.2 PK	74.0	-17.8	1.00 H	192	47.97	8.23
2	5150.00	44.6 AV	54.0	-9.4	1.00 H	192	36.37	8.23
3	5350.00	57.8 PK	74.0	-16.2	1.00 H	192	49.00	8.80
4	5350.00	46.1 AV	54.0	-7.9	1.00 H	192	37.30	8.80
5	*5745.00	113.7 PK			1.00 H	192	103.76	9.94
6	*5745.00	103.8 AV			1.00 H	192	93.86	9.94
7	11490.00	53.6 PK	74.0	-20.4	1.00 H	213	37.02	16.58
8	11490.00	41.1 AV	54.0	-12.9	1.00 H	213	24.52	16.58

ANTENNA POLARITY & TEST DISTANCE: VERTICAL AT 3 M

NO.	FREQ. (MHz)	EMISSION LEVEL (dBuV/m)	LIMIT (dBuV/m)	MARGIN (dB)	ANTENNA HEIGHT (m)	TABLE ANGLE (Degree)	RAW VALUE (dBuV)	CORRECTION FACTOR (dB/m)
1	5150.00	57.4 PK	74.0	-16.6	1.00 V	264	49.17	8.23
2	5150.00	47.1 AV	54.0	-6.9	1.00 V	264	38.87	8.23
3	5350.00	60.5 PK	74.0	-13.5	1.00 V	264	51.70	8.80
4	5350.00	49.1 AV	54.0	-4.9	1.00 V	264	40.30	8.80
5	*5745.00	116.2 PK			1.00 V	264	106.26	9.94
6	*5745.00	105.5 AV			1.00 V	264	95.56	9.94
7	11490.00	53.8 PK	74.0	-20.2	1.00 V	210	37.22	16.58
8	11490.00	40.6 AV	54.0	-13.4	1.00 V	210	24.02	16.58

REMARKS:

1. Emission Level(dBuV/m) = Raw Value(dBuV) + Correction Factor(dB/m)
2. Correction Factor(dB/m) = Antenna Factor(dB/m) + Cable Factor(dB) – Pre-Amplifier Factor(dB)
3. The other emission levels were very low against the limit.
4. Margin value = Emission Level – Limit value
5. " * ": Fundamental frequency.
6. The limit value is defined as per 15.247.



A D T

CHANNEL	TX Channel 157	DETECTOR FUNCTION	Peak (PK)
FREQUENCY RANGE	1GHz ~ 40GHz		Average (AV)

ANTENNA POLARITY & TEST DISTANCE: HORIZONTAL AT 3 M

NO.	FREQ. (MHz)	EMISSION LEVEL (dBuV/m)	LIMIT (dBuV/m)	MARGIN (dB)	ANTENNA HEIGHT (m)	TABLE ANGLE (Degree)	RAW VALUE (dBuV)	CORRECTION FACTOR (dB/m)
1	*5785.00	110.5 PK			1.02 H	184	100.49	10.01
2	*5785.00	100.5 AV			1.02 H	184	90.49	10.01
3	11570.00	54.2 PK	74.0	-19.8	1.00 H	210	37.56	16.64
4	11570.00	42.2 AV	54.0	-11.8	1.00 H	210	25.56	16.64

ANTENNA POLARITY & TEST DISTANCE: VERTICAL AT 3 M

NO.	FREQ. (MHz)	EMISSION LEVEL (dBuV/m)	LIMIT (dBuV/m)	MARGIN (dB)	ANTENNA HEIGHT (m)	TABLE ANGLE (Degree)	RAW VALUE (dBuV)	CORRECTION FACTOR (dB/m)
1	*5785.00	113.1 PK			1.00 V	159	103.09	10.01
2	*5785.00	103.3 AV			1.00 V	159	93.29	10.01
3	11570.00	53.1 PK	74.0	-20.9	1.10 V	210	36.46	16.64
4	11570.00	40.8 AV	54.0	-13.2	1.10 V	210	24.16	16.64

REMARKS:

1. Emission Level(dBuV/m) = Raw Value(dBuV) + Correction Factor(dB/m)
2. Correction Factor(dB/m) = Antenna Factor(dB/m) + Cable Factor(dB) – Pre-Amplifier Factor(dB)
3. The other emission levels were very low against the limit.
4. Margin value = Emission Level – Limit value
5. " * ": Fundamental frequency.
6. The limit value is defined as per 15.247.



A D T

CHANNEL	TX Channel 165	DETECTOR FUNCTION	Peak (PK)
FREQUENCY RANGE	1GHz ~ 40GHz		Average (AV)

ANTENNA POLARITY & TEST DISTANCE: HORIZONTAL AT 3 M

NO.	FREQ. (MHz)	EMISSION LEVEL (dBuV/m)	LIMIT (dBuV/m)	MARGIN (dB)	ANTENNA HEIGHT (m)	TABLE ANGLE (Degree)	RAW VALUE (dBuV)	CORRECTION FACTOR (dB/m)
1	*5825.00	108.8 PK			1.05 H	185	98.70	10.10
2	*5825.00	99.1 AV			1.05 H	185	89.00	10.10
3	11650.00	54.2 PK	74.0	-19.8	1.03 H	215	37.35	16.85
4	11650.00	41.6 AV	54.0	-12.4	1.03 H	215	24.75	16.85

ANTENNA POLARITY & TEST DISTANCE: VERTICAL AT 3 M

NO.	FREQ. (MHz)	EMISSION LEVEL (dBuV/m)	LIMIT (dBuV/m)	MARGIN (dB)	ANTENNA HEIGHT (m)	TABLE ANGLE (Degree)	RAW VALUE (dBuV)	CORRECTION FACTOR (dB/m)
1	*5825.00	112.2 PK			1.00 V	153	102.10	10.10
2	*5825.00	102.4 AV			1.00 V	153	92.30	10.10
3	11650.00	52.8 PK	74.0	-21.2	1.15 V	224	35.95	16.85
4	11650.00	40.6 AV	54.0	-13.4	1.15 V	224	23.75	16.85

REMARKS:

1. Emission Level(dBuV/m) = Raw Value(dBuV) + Correction Factor(dB/m)
2. Correction Factor(dB/m) = Antenna Factor(dB/m) + Cable Factor(dB) – Pre-Amplifier Factor(dB)
3. The other emission levels were very low against the limit.
4. Margin value = Emission Level – Limit value
5. " * ": Fundamental frequency.
6. The limit value is defined as per 15.247.



A D T

802.11n (HT20), 1Tx

CHANNEL	TX Channel 149	DETECTOR FUNCTION	Peak (PK)
FREQUENCY RANGE	1GHz ~ 40GHz		Average (AV)

ANTENNA POLARITY & TEST DISTANCE: HORIZONTAL AT 3 M

NO.	FREQ. (MHz)	EMISSION LEVEL (dBuV/m)	LIMIT (dBuV/m)	MARGIN (dB)	ANTENNA HEIGHT (m)	TABLE ANGLE (Degree)	RAW VALUE (dBuV)	CORRECTION FACTOR (dB/m)
1	5350.00	56.0 PK	74.0	-18.0	1.02 H	179	47.20	8.80
2	5350.00	43.6 AV	54.0	-10.4	1.02 H	179	34.80	8.80
3	*5745.00	112.3 PK			1.02 H	179	102.36	9.94
4	*5745.00	102.1 AV			1.02 H	179	92.16	9.94
5	11490.00	53.3 PK	74.0	-20.7	1.01 H	206	36.72	16.58
6	11490.00	41.1 AV	54.0	-12.9	1.01 H	206	24.52	16.58

ANTENNA POLARITY & TEST DISTANCE: VERTICAL AT 3 M

NO.	FREQ. (MHz)	EMISSION LEVEL (dBuV/m)	LIMIT (dBuV/m)	MARGIN (dB)	ANTENNA HEIGHT (m)	TABLE ANGLE (Degree)	RAW VALUE (dBuV)	CORRECTION FACTOR (dB/m)
1	5350.00	59.4 PK	74.0	-14.6	1.00 V	266	50.60	8.80
2	5350.00	47.1 AV	54.0	-6.9	1.00 V	266	38.30	8.80
3	*5745.00	115.6 PK			1.00 V	266	105.66	9.94
4	*5745.00	105.4 AV			1.00 V	266	95.46	9.94
5	11490.00	54.1 PK	74.0	-19.9	1.00 V	211	37.52	16.58
6	11490.00	40.3 AV	54.0	-13.7	1.00 V	211	23.72	16.58

REMARKS:

1. Emission Level(dBuV/m) = Raw Value(dBuV) + Correction Factor(dB/m)
2. Correction Factor(dB/m) = Antenna Factor(dB/m) + Cable Factor(dB) – Pre-Amplifier Factor(dB)
3. The other emission levels were very low against the limit.
4. Margin value = Emission Level – Limit value
5. " * ": Fundamental frequency.
6. The limit value is defined as per 15.247.



A D T

CHANNEL	TX Channel 157	DETECTOR FUNCTION	Peak (PK)
FREQUENCY RANGE	1GHz ~ 40GHz		Average (AV)

ANTENNA POLARITY & TEST DISTANCE: HORIZONTAL AT 3 M

NO.	FREQ. (MHz)	EMISSION LEVEL (dBuV/m)	LIMIT (dBuV/m)	MARGIN (dB)	ANTENNA HEIGHT (m)	TABLE ANGLE (Degree)	RAW VALUE (dBuV)	CORRECTION FACTOR (dB/m)
1	*5785.00	110.7 PK			1.00 H	190	100.69	10.01
2	*5785.00	100.6 AV			1.00 H	190	90.59	10.01
3	11570.00	53.7 PK	74.0	-20.3	1.03 H	225	37.06	16.64
4	11570.00	41.1 AV	54.0	-12.9	1.03 H	225	24.46	16.64

ANTENNA POLARITY & TEST DISTANCE: VERTICAL AT 3 M

NO.	FREQ. (MHz)	EMISSION LEVEL (dBuV/m)	LIMIT (dBuV/m)	MARGIN (dB)	ANTENNA HEIGHT (m)	TABLE ANGLE (Degree)	RAW VALUE (dBuV)	CORRECTION FACTOR (dB/m)
1	*5785.00	113.5 PK			1.00 V	153	103.49	10.01
2	*5785.00	103.5 AV			1.00 V	153	93.49	10.01
3	11570.00	52.7 PK	74.0	-21.3	1.06 V	200	36.06	16.64
4	11570.00	40.4 AV	54.0	-13.6	1.06 V	200	23.76	16.64

REMARKS:

1. Emission Level(dBuV/m) = Raw Value(dBuV) + Correction Factor(dB/m)
2. Correction Factor(dB/m) = Antenna Factor(dB/m) + Cable Factor(dB) – Pre-Amplifier Factor(dB)
3. The other emission levels were very low against the limit.
4. Margin value = Emission Level – Limit value
5. " * ": Fundamental frequency.
6. The limit value is defined as per 15.247.



A D T

CHANNEL	TX Channel 165	DETECTOR FUNCTION	Peak (PK)
FREQUENCY RANGE	1GHz ~ 40GHz		Average (AV)

ANTENNA POLARITY & TEST DISTANCE: HORIZONTAL AT 3 M

NO.	FREQ. (MHz)	EMISSION LEVEL (dBuV/m)	LIMIT (dBuV/m)	MARGIN (dB)	ANTENNA HEIGHT (m)	TABLE ANGLE (Degree)	RAW VALUE (dBuV)	CORRECTION FACTOR (dB/m)
1	*5825.00	108.6 PK			1.03 H	198	98.50	10.10
2	*5825.00	98.8 AV			1.03 H	198	88.70	10.10
3	11650.00	53.9 PK	74.0	-20.1	1.00 H	214	37.05	16.85
4	11650.00	41.3 AV	54.0	-12.7	1.00 H	214	24.45	16.85

ANTENNA POLARITY & TEST DISTANCE: VERTICAL AT 3 M

NO.	FREQ. (MHz)	EMISSION LEVEL (dBuV/m)	LIMIT (dBuV/m)	MARGIN (dB)	ANTENNA HEIGHT (m)	TABLE ANGLE (Degree)	RAW VALUE (dBuV)	CORRECTION FACTOR (dB/m)
1	*5825.00	111.8 PK			1.00 V	153	101.70	10.10
2	*5825.00	102.1 AV			1.00 V	153	92.00	10.10
3	11650.00	52.7 PK	74.0	-21.3	1.13 V	219	35.85	16.85
4	11650.00	40.5 AV	54.0	-13.5	1.13 V	219	23.65	16.85

REMARKS:

1. Emission Level(dBuV/m) = Raw Value(dBuV) + Correction Factor(dB/m)
2. Correction Factor(dB/m) = Antenna Factor(dB/m) + Cable Factor(dB) – Pre-Amplifier Factor(dB)
3. The other emission levels were very low against the limit.
4. Margin value = Emission Level – Limit value
5. " * ": Fundamental frequency.
6. The limit value is defined as per 15.247.



A D T

802.11n (HT40), 1Tx

CHANNEL	TX Channel 151	DETECTOR FUNCTION	Peak (PK)
FREQUENCY RANGE	1GHz ~ 40GHz		Average (AV)

ANTENNA POLARITY & TEST DISTANCE: HORIZONTAL AT 3 M

NO.	FREQ. (MHz)	EMISSION LEVEL (dBuV/m)	LIMIT (dBuV/m)	MARGIN (dB)	ANTENNA HEIGHT (m)	TABLE ANGLE (Degree)	RAW VALUE (dBuV)	CORRECTION FACTOR (dB/m)
1	*5755.00	108.8 PK			1.05 H	184	98.84	9.96
2	*5755.00	98.4 AV			1.05 H	184	88.44	9.96
3	11510.00	53.4 PK	74.0	-20.6	1.04 H	197	36.84	16.56
4	11510.00	40.7 AV	54.0	-13.3	1.04 H	197	24.14	16.56

ANTENNA POLARITY & TEST DISTANCE: VERTICAL AT 3 M

NO.	FREQ. (MHz)	EMISSION LEVEL (dBuV/m)	LIMIT (dBuV/m)	MARGIN (dB)	ANTENNA HEIGHT (m)	TABLE ANGLE (Degree)	RAW VALUE (dBuV)	CORRECTION FACTOR (dB/m)
1	*5755.00	111.2 PK			1.00 V	259	101.24	9.96
2	*5755.00	100.9 AV			1.00 V	259	90.94	9.96
3	11510.00	53.5 PK	74.0	-20.5	1.08 V	208	36.94	16.56
4	11510.00	41.0 AV	54.0	-13.0	1.08 V	208	24.44	16.56

REMARKS:

1. Emission Level(dBuV/m) = Raw Value(dBuV) + Correction Factor(dB/m)
2. Correction Factor(dB/m) = Antenna Factor(dB/m) + Cable Factor(dB) – Pre-Amplifier Factor(dB)
3. The other emission levels were very low against the limit.
4. Margin value = Emission Level – Limit value
5. " * ": Fundamental frequency.
6. The limit value is defined as per 15.247.



A D T

CHANNEL	TX Channel 159	DETECTOR FUNCTION	Peak (PK)
FREQUENCY RANGE	1GHz ~ 40GHz		Average (AV)

ANTENNA POLARITY & TEST DISTANCE: HORIZONTAL AT 3 M

NO.	FREQ. (MHz)	EMISSION LEVEL (dBuV/m)	LIMIT (dBuV/m)	MARGIN (dB)	ANTENNA HEIGHT (m)	TABLE ANGLE (Degree)	RAW VALUE (dBuV)	CORRECTION FACTOR (dB/m)
1	*5795.00	107.2 PK			1.05 H	197	97.19	10.01
2	*5795.00	96.8 AV			1.05 H	197	86.79	10.01
3	11590.00	54.0 PK	74.0	-20.0	1.00 H	215	37.33	16.67
4	11590.00	41.3 AV	54.0	-12.7	1.00 H	215	24.63	16.67

ANTENNA POLARITY & TEST DISTANCE: VERTICAL AT 3 M

NO.	FREQ. (MHz)	EMISSION LEVEL (dBuV/m)	LIMIT (dBuV/m)	MARGIN (dB)	ANTENNA HEIGHT (m)	TABLE ANGLE (Degree)	RAW VALUE (dBuV)	CORRECTION FACTOR (dB/m)
1	*5795.00	110.2 PK			1.00 V	147	100.19	10.01
2	*5795.00	99.5 AV			1.00 V	147	89.49	10.01
3	11590.00	53.2 PK	74.0	-20.8	1.07 V	210	36.53	16.67
4	11590.00	41.0 AV	54.0	-13.0	1.07 V	210	24.33	16.67

REMARKS:

1. Emission Level(dBuV/m) = Raw Value(dBuV) + Correction Factor(dB/m)
2. Correction Factor(dB/m) = Antenna Factor(dB/m) + Cable Factor(dB) – Pre-Amplifier Factor(dB)
3. The other emission levels were very low against the limit.
4. Margin value = Emission Level – Limit value
5. " * ": Fundamental frequency.
6. The limit value is defined as per 15.247.



A D T

802.11n (HT20), 2Tx

CHANNEL	TX Channel 149	DETECTOR FUNCTION	Peak (PK)
FREQUENCY RANGE	1GHz ~ 40GHz		Average (AV)

ANTENNA POLARITY & TEST DISTANCE: HORIZONTAL AT 3 M

NO.	FREQ. (MHz)	EMISSION LEVEL (dBuV/m)	LIMIT (dBuV/m)	MARGIN (dB)	ANTENNA HEIGHT (m)	TABLE ANGLE (Degree)	RAW VALUE (dBuV)	CORRECTION FACTOR (dB/m)
1	5440.00	63.9 PK	74.0	-10.1	1.00 H	183	54.79	9.11
2	5440.00	51.1 AV	54.0	-2.9	1.00 H	183	41.99	9.11
3	*5745.00	111.8 PK			1.00 H	183	101.86	9.94
4	*5745.00	101.1 AV			1.00 H	183	91.16	9.94
5	11490.00	66.3 PK	74.0	-7.7	1.00 H	206	49.72	16.58
6	11490.00	52.5 AV	54.0	-1.5	1.00 H	206	35.92	16.58

ANTENNA POLARITY & TEST DISTANCE: VERTICAL AT 3 M

NO.	FREQ. (MHz)	EMISSION LEVEL (dBuV/m)	LIMIT (dBuV/m)	MARGIN (dB)	ANTENNA HEIGHT (m)	TABLE ANGLE (Degree)	RAW VALUE (dBuV)	CORRECTION FACTOR (dB/m)
1	5353.00	62.3 PK	74.0	-11.7	1.00 V	260	53.49	8.81
2	5353.00	50.1 AV	54.0	-3.9	1.00 V	260	41.29	8.81
3	*5745.00	112.8 PK			1.00 V	260	102.86	9.94
4	*5745.00	102.0 AV			1.00 V	260	92.06	9.94
5	11490.00	67.7 PK	74.0	-6.3	1.00 V	210	51.12	16.58
6	11490.00	53.3 AV	54.0	-0.7	1.00 V	210	36.72	16.58

REMARKS:

1. Emission Level(dBuV/m) = Raw Value(dBuV) + Correction Factor(dB/m)
2. Correction Factor(dB/m) = Antenna Factor(dB/m) + Cable Factor(dB) – Pre-Amplifier Factor(dB)
3. The other emission levels were very low against the limit.
4. Margin value = Emission Level – Limit value
5. " * ": Fundamental frequency.
6. The limit value is defined as per 15.247.



A D T

CHANNEL	TX Channel 157	DETECTOR FUNCTION	Peak (PK)
FREQUENCY RANGE	1GHz ~ 40GHz		Average (AV)

ANTENNA POLARITY & TEST DISTANCE: HORIZONTAL AT 3 M

NO.	FREQ. (MHz)	EMISSION LEVEL (dBuV/m)	LIMIT (dBuV/m)	MARGIN (dB)	ANTENNA HEIGHT (m)	TABLE ANGLE (Degree)	RAW VALUE (dBuV)	CORRECTION FACTOR (dB/m)
1	5350.00	65.9 PK	74.0	-8.1	1.00 H	195	57.10	8.80
2	5350.00	53.1 AV	54.0	-0.9	1.00 H	195	44.30	8.80
3	*5785.00	112.7 PK			1.00 H	194	102.69	10.01
4	*5785.00	101.4 AV			1.00 H	194	91.39	10.01
5	11570.00	67.7 PK	74.0	-6.3	1.06 H	215	51.06	16.64
6	11570.00	53.1 AV	54.0	-0.9	1.06 H	215	36.46	16.64

ANTENNA POLARITY & TEST DISTANCE: VERTICAL AT 3 M

NO.	FREQ. (MHz)	EMISSION LEVEL (dBuV/m)	LIMIT (dBuV/m)	MARGIN (dB)	ANTENNA HEIGHT (m)	TABLE ANGLE (Degree)	RAW VALUE (dBuV)	CORRECTION FACTOR (dB/m)
1	5350.00	61.8 PK	74.0	-12.2	1.00 V	150	53.00	8.80
2	5350.00	50.1 AV	54.0	-3.9	1.00 V	150	41.30	8.80
3	*5785.00	113.7 PK			1.00 V	150	103.69	10.01
4	*5785.00	103.3 AV			1.00 V	150	93.29	10.01
5	11570.00	68.0 PK	74.0	-6.0	1.00 V	209	51.36	16.64
6	11570.00	53.3 AV	54.0	-0.7	1.00 V	209	36.66	16.64

REMARKS:

1. Emission Level(dBuV/m) = Raw Value(dBuV) + Correction Factor(dB/m)
2. Correction Factor(dB/m) = Antenna Factor(dB/m) + Cable Factor(dB) – Pre-Amplifier Factor(dB)
3. The other emission levels were very low against the limit.
4. Margin value = Emission Level – Limit value
5. " * ": Fundamental frequency.
6. The limit value is defined as per 15.247.



A D T

CHANNEL	TX Channel 165	DETECTOR FUNCTION	Peak (PK)
FREQUENCY RANGE	1GHz ~ 40GHz		Average (AV)

ANTENNA POLARITY & TEST DISTANCE: HORIZONTAL AT 3 M

NO.	FREQ. (MHz)	EMISSION LEVEL (dBuV/m)	LIMIT (dBuV/m)	MARGIN (dB)	ANTENNA HEIGHT (m)	TABLE ANGLE (Degree)	RAW VALUE (dBuV)	CORRECTION FACTOR (dB/m)
1	5077.00	59.0 PK	74.0	-15.0	1.07 H	181	50.91	8.09
2	5077.00	50.3 AV	54.0	-3.7	1.07 H	181	42.21	8.09
3	5422.00	65.1 PK	74.0	-8.9	1.07 H	181	56.05	9.05
4	5422.00	53.2 AV	54.0	-0.8	1.07 H	181	44.15	9.05
5	*5825.00	110.8 PK			1.07 H	181	100.70	10.10
6	*5825.00	100.6 AV			1.07 H	181	90.50	10.10
7	11650.00	57.4 PK	74.0	-16.6	1.03 H	215	40.55	16.85
8	11650.00	44.6 AV	54.0	-9.4	1.03 H	215	27.75	16.85

ANTENNA POLARITY & TEST DISTANCE: VERTICAL AT 3 M

NO.	FREQ. (MHz)	EMISSION LEVEL (dBuV/m)	LIMIT (dBuV/m)	MARGIN (dB)	ANTENNA HEIGHT (m)	TABLE ANGLE (Degree)	RAW VALUE (dBuV)	CORRECTION FACTOR (dB/m)
1	5077.00	53.8 PK	74.0	-20.2	1.00 V	151	45.71	8.09
2	5077.00	44.0 AV	54.0	-10.0	1.00 V	151	35.91	8.09
3	5422.00	59.0 PK	74.0	-15.0	1.00 V	151	49.95	9.05
4	5422.00	47.9 AV	54.0	-6.1	1.00 V	151	38.85	9.05
5	*5825.00	111.9 PK			1.00 V	151	101.80	10.10
6	*5825.00	101.7 AV			1.00 V	151	91.60	10.10
7	11650.00	58.0 PK	74.0	-16.0	1.04 V	213	41.15	16.85
8	11650.00	44.7 AV	54.0	-9.3	1.04 V	213	27.85	16.85

REMARKS:

1. Emission Level(dBuV/m) = Raw Value(dBuV) + Correction Factor(dB/m)
2. Correction Factor(dB/m) = Antenna Factor(dB/m) + Cable Factor(dB) – Pre-Amplifier Factor(dB)
3. The other emission levels were very low against the limit.
4. Margin value = Emission Level – Limit value
5. " * ": Fundamental frequency.
6. The limit value is defined as per 15.247.



A D T

802.11n (HT40), 2Tx

CHANNEL	TX Channel 151	DETECTOR FUNCTION	Peak (PK)
FREQUENCY RANGE	1GHz ~ 40GHz		Average (AV)

ANTENNA POLARITY & TEST DISTANCE: HORIZONTAL AT 3 M

NO.	FREQ. (MHz)	EMISSION LEVEL (dBuV/m)	LIMIT (dBuV/m)	MARGIN (dB)	ANTENNA HEIGHT (m)	TABLE ANGLE (Degree)	RAW VALUE (dBuV)	CORRECTION FACTOR (dB/m)
1	5350.00	66.2 PK	74.0	-7.8	1.00 H	180	57.40	8.80
2	5350.00	53.4 AV	54.0	-0.6	1.00 H	180	44.60	8.80
3	*5755.00	110.6 PK			1.00 H	180	100.64	9.96
4	*5755.00	100.0 AV			1.00 H	180	90.04	9.96
5	11510.00	64.8 PK	74.0	-9.2	1.00 H	211	48.24	16.56
6	11510.00	51.2 AV	54.0	-2.8	1.00 H	211	34.64	16.56

ANTENNA POLARITY & TEST DISTANCE: VERTICAL AT 3 M

NO.	FREQ. (MHz)	EMISSION LEVEL (dBuV/m)	LIMIT (dBuV/m)	MARGIN (dB)	ANTENNA HEIGHT (m)	TABLE ANGLE (Degree)	RAW VALUE (dBuV)	CORRECTION FACTOR (dB/m)
1	5450.00	64.3 PK	74.0	-9.7	1.00 V	246	55.15	9.15
2	5450.00	51.7 AV	54.0	-2.3	1.00 V	246	42.55	9.15
3	*5755.00	113.1 PK			1.00 V	246	103.14	9.96
4	*5755.00	102.8 AV			1.00 V	246	92.84	9.96
5	11510.00	65.8 PK	74.0	-8.2	1.00 V	211	49.24	16.56
6	11510.00	51.8 AV	54.0	-2.2	1.00 V	211	35.24	16.56

REMARKS:

1. Emission Level(dBuV/m) = Raw Value(dBuV) + Correction Factor(dB/m)
2. Correction Factor(dB/m) = Antenna Factor(dB/m) + Cable Factor(dB) – Pre-Amplifier Factor(dB)
3. The other emission levels were very low against the limit.
4. Margin value = Emission Level – Limit value
5. " * ": Fundamental frequency.
6. The limit value is defined as per 15.247.



A D T

CHANNEL	TX Channel 159	DETECTOR FUNCTION	Peak (PK)
FREQUENCY RANGE	1GHz ~ 40GHz		Average (AV)

ANTENNA POLARITY & TEST DISTANCE: HORIZONTAL AT 3 M

NO.	FREQ. (MHz)	EMISSION LEVEL (dBuV/m)	LIMIT (dBuV/m)	MARGIN (dB)	ANTENNA HEIGHT (m)	TABLE ANGLE (Degree)	RAW VALUE (dBuV)	CORRECTION FACTOR (dB/m)
1	5352.00	66.0 PK	74.0	-8.0	1.00 H	189	57.20	8.80
2	5352.00	53.3 AV	54.0	-0.7	1.00 H	189	44.50	8.80
3	*5795.00	110.4 PK			1.00 H	189	100.39	10.01
4	*5795.00	99.3 AV			1.00 H	189	89.29	10.01
5	11590.00	63.8 PK	74.0	-10.2	1.00 H	212	47.13	16.67
6	11590.00	50.7 AV	54.0	-3.3	1.00 H	212	34.03	16.67

ANTENNA POLARITY & TEST DISTANCE: VERTICAL AT 3 M

NO.	FREQ. (MHz)	EMISSION LEVEL (dBuV/m)	LIMIT (dBuV/m)	MARGIN (dB)	ANTENNA HEIGHT (m)	TABLE ANGLE (Degree)	RAW VALUE (dBuV)	CORRECTION FACTOR (dB/m)
1	5352.00	63.6 PK	74.0	-10.4	1.00 V	169	54.80	8.80
2	5352.00	51.0 AV	54.0	-3.0	1.00 V	169	42.20	8.80
3	*5795.00	111.0 PK			1.00 V	169	100.99	10.01
4	*5795.00	99.9 AV			1.00 V	169	89.89	10.01
5	11590.00	65.1 PK	74.0	-8.9	1.00 V	211	48.43	16.67
6	11590.00	51.4 AV	54.0	-2.6	1.00 V	211	34.73	16.67

REMARKS:

1. Emission Level(dBuV/m) = Raw Value(dBuV) + Correction Factor(dB/m)
2. Correction Factor(dB/m) = Antenna Factor(dB/m) + Cable Factor(dB) – Pre-Amplifier Factor(dB)
3. The other emission levels were very low against the limit.
4. Margin value = Emission Level – Limit value
5. " * ": Fundamental frequency.
6. The limit value is defined as per 15.247.



A D T

802.11a, 3Tx

CHANNEL	TX Channel 149	DETECTOR FUNCTION	Peak (PK)
FREQUENCY RANGE	1GHz ~ 40GHz		Average (AV)

ANTENNA POLARITY & TEST DISTANCE: HORIZONTAL AT 3 M

NO.	FREQ. (MHz)	EMISSION LEVEL (dBuV/m)	LIMIT (dBuV/m)	MARGIN (dB)	ANTENNA HEIGHT (m)	TABLE ANGLE (Degree)	RAW VALUE (dBuV)	CORRECTION FACTOR (dB/m)
1	5150.00	64.1 PK	74.0	-9.9	1.45 H	95	55.87	8.23
2	5150.00	52.8 AV	54.0	-1.2	1.45 H	95	44.57	8.23
3	5439.00	65.5 PK	74.0	-8.5	1.45 H	95	56.40	9.10
4	5439.00	53.2 AV	54.0	-0.8	1.45 H	95	44.10	9.10
5	*5745.00	114.9 PK			1.45 H	95	104.96	9.94
6	*5745.00	105.8 AV			1.45 H	95	95.86	9.94
7	11490.00	62.5 PK	74.0	-11.5	1.06 H	215	45.92	16.58
8	11490.00	49.0 AV	54.0	-5.0	1.06 H	215	32.42	16.58

ANTENNA POLARITY & TEST DISTANCE: VERTICAL AT 3 M

NO.	FREQ. (MHz)	EMISSION LEVEL (dBuV/m)	LIMIT (dBuV/m)	MARGIN (dB)	ANTENNA HEIGHT (m)	TABLE ANGLE (Degree)	RAW VALUE (dBuV)	CORRECTION FACTOR (dB/m)
1	5150.00	61.6 PK	74.0	-12.4	1.00 V	252	53.37	8.23
2	5150.00	51.0 AV	54.0	-3.0	1.00 V	252	42.77	8.23
3	5356.00	64.9 PK	74.0	-9.1	1.00 V	252	56.08	8.82
4	5356.00	53.2 AV	54.0	-0.8	1.00 V	252	44.38	8.82
5	*5745.00	116.0 PK			1.00 V	252	106.06	9.94
6	*5745.00	105.0 AV			1.00 V	252	95.06	9.94
7	11490.00	60.3 PK	74.0	-13.7	1.00 V	210	43.72	16.58
8	11490.00	48.6 AV	54.0	-5.4	1.00 V	210	32.02	16.58

REMARKS:

1. Emission Level(dBuV/m) = Raw Value(dBuV) + Correction Factor(dB/m)
2. Correction Factor(dB/m) = Antenna Factor(dB/m) + Cable Factor(dB) – Pre-Amplifier Factor(dB)
3. The other emission levels were very low against the limit.
4. Margin value = Emission Level – Limit value
5. " * ": Fundamental frequency.
6. The limit value is defined as per 15.247.



A D T

CHANNEL	TX Channel 157	DETECTOR FUNCTION	Peak (PK)
FREQUENCY RANGE	1GHz ~ 40GHz		Average (AV)

ANTENNA POLARITY & TEST DISTANCE: HORIZONTAL AT 3 M

NO.	FREQ. (MHz)	EMISSION LEVEL (dBuV/m)	LIMIT (dBuV/m)	MARGIN (dB)	ANTENNA HEIGHT (m)	TABLE ANGLE (Degree)	RAW VALUE (dBuV)	CORRECTION FACTOR (dB/m)
1	5147.00	61.3 PK	74.0	-12.7	1.00 H	312	53.08	8.22
2	5147.00	48.8 AV	54.0	-5.2	1.00 H	312	40.58	8.22
3	5453.00	62.2 PK	74.0	-11.8	1.00 H	312	53.03	9.17
4	5453.00	50.9 AV	54.0	-3.1	1.00 H	312	41.73	9.17
5	*5785.00	112.0 PK			1.00 H	312	101.99	10.01
6	*5785.00	102.6 AV			1.00 H	312	92.59	10.01
7	11570.00	67.9 PK	74.0	-6.1	1.00 H	205	51.26	16.64
8	11570.00	53.0 AV	54.0	-1.0	1.00 H	205	36.36	16.64

ANTENNA POLARITY & TEST DISTANCE: VERTICAL AT 3 M

NO.	FREQ. (MHz)	EMISSION LEVEL (dBuV/m)	LIMIT (dBuV/m)	MARGIN (dB)	ANTENNA HEIGHT (m)	TABLE ANGLE (Degree)	RAW VALUE (dBuV)	CORRECTION FACTOR (dB/m)
1	5147.00	60.3 PK	74.0	-13.7	1.00 V	254	52.08	8.22
2	5147.00	49.3 AV	54.0	-4.7	1.00 V	254	41.08	8.22
3	5359.00	66.0 PK	74.0	-8.0	1.00 V	254	57.17	8.83
4	5359.00	53.2 AV	54.0	-0.8	1.00 V	254	44.37	8.83
5	*5785.00	111.7 PK			1.00 V	254	101.69	10.01
6	*5785.00	102.7 AV			1.00 V	254	92.69	10.01
7	11570.00	67.1 PK	74.0	-6.9	1.00 V	215	50.46	16.64
8	11570.00	52.8 AV	54.0	-1.2	1.00 V	215	36.16	16.64

REMARKS:

1. Emission Level(dBuV/m) = Raw Value(dBuV) + Correction Factor(dB/m)
2. Correction Factor(dB/m) = Antenna Factor(dB/m) + Cable Factor(dB) – Pre-Amplifier Factor(dB)
3. The other emission levels were very low against the limit.
4. Margin value = Emission Level – Limit value
5. " * ": Fundamental frequency.
6. The limit value is defined as per 15.247.



A D T

CHANNEL	TX Channel 165	DETECTOR FUNCTION	Peak (PK)
FREQUENCY RANGE	1GHz ~ 40GHz		Average (AV)

ANTENNA POLARITY & TEST DISTANCE: HORIZONTAL AT 3 M

NO.	FREQ. (MHz)	EMISSION LEVEL (dBuV/m)	LIMIT (dBuV/m)	MARGIN (dB)	ANTENNA HEIGHT (m)	TABLE ANGLE (Degree)	RAW VALUE (dBuV)	CORRECTION FACTOR (dB/m)
1	5124.00	56.3 PK	74.0	-17.7	1.18 H	350	48.07	8.23
2	5124.00	44.1 AV	54.0	-9.9	1.18 H	350	35.87	8.23
3	5439.00	61.4 PK	74.0	-12.6	1.18 H	350	52.30	9.10
4	5439.00	48.0 AV	54.0	-6.0	1.18 H	350	38.90	9.10
5	*5825.00	112.8 PK			1.18 H	350	102.70	10.10
6	*5825.00	103.3 AV			1.18 H	350	93.20	10.10
7	11650.00	69.7 PK	74.0	-4.3	1.19 H	222	52.85	16.85
8	11650.00	51.4 AV	54.0	-2.6	1.19 H	222	34.55	16.85

ANTENNA POLARITY & TEST DISTANCE: VERTICAL AT 3 M

NO.	FREQ. (MHz)	EMISSION LEVEL (dBuV/m)	LIMIT (dBuV/m)	MARGIN (dB)	ANTENNA HEIGHT (m)	TABLE ANGLE (Degree)	RAW VALUE (dBuV)	CORRECTION FACTOR (dB/m)
1	5124.00	62.1 PK	74.0	-11.9	1.77 V	112	53.87	8.23
2	5124.00	50.3 AV	54.0	-3.7	1.77 V	112	42.07	8.23
3	5439.00	64.4 PK	74.0	-9.6	1.77 V	112	55.30	9.10
4	5439.00	52.5 AV	54.0	-1.5	1.77 V	112	43.40	9.10
5	*5825.00	113.6 PK			1.77 V	112	103.50	10.10
6	*5825.00	104.5 AV			1.77 V	112	94.40	10.10
7	11650.00	66.9 PK	74.0	-7.1	1.00 V	245	50.05	16.85
8	11650.00	50.8 AV	54.0	-3.2	1.00 V	245	33.95	16.85

REMARKS:

1. Emission Level(dBuV/m) = Raw Value(dBuV) + Correction Factor(dB/m)
2. Correction Factor(dB/m) = Antenna Factor(dB/m) + Cable Factor(dB) – Pre-Amplifier Factor(dB)
3. The other emission levels were very low against the limit.
4. Margin value = Emission Level – Limit value
5. " * ": Fundamental frequency.
6. The limit value is defined as per 15.247.



A D T

802.11n (HT20), 3Tx

CHANNEL	TX Channel 149	DETECTOR FUNCTION	Peak (PK)
FREQUENCY RANGE	1GHz ~ 40GHz		Average (AV)

ANTENNA POLARITY & TEST DISTANCE: HORIZONTAL AT 3 M

NO.	FREQ. (MHz)	EMISSION LEVEL (dBuV/m)	LIMIT (dBuV/m)	MARGIN (dB)	ANTENNA HEIGHT (m)	TABLE ANGLE (Degree)	RAW VALUE (dBuV)	CORRECTION FACTOR (dB/m)
1	5149.00	59.4 PK	74.0	-14.6	1.00 H	191	51.17	8.23
2	5149.00	47.8 AV	54.0	-6.2	1.00 H	191	39.57	8.23
3	5356.00	65.3 PK	74.0	-8.7	1.00 H	191	56.48	8.82
4	5356.00	53.1 AV	54.0	-0.9	1.00 H	191	44.28	8.82
5	*5745.00	113.7 PK			1.00 H	191	103.76	9.94
6	*5745.00	104.3 AV			1.00 H	191	94.36	9.94
7	11490.00	69.4 PK	74.0	-4.6	1.19 H	220	52.82	16.58
8	11490.00	52.8 AV	54.0	-1.2	1.19 H	220	36.22	16.58

ANTENNA POLARITY & TEST DISTANCE: VERTICAL AT 3 M

NO.	FREQ. (MHz)	EMISSION LEVEL (dBuV/m)	LIMIT (dBuV/m)	MARGIN (dB)	ANTENNA HEIGHT (m)	TABLE ANGLE (Degree)	RAW VALUE (dBuV)	CORRECTION FACTOR (dB/m)
1	5149.00	62.6 PK	74.0	-11.4	1.00 V	252	54.37	8.23
2	5149.00	50.6 AV	54.0	-3.4	1.00 V	252	42.37	8.23
3	5356.00	64.6 PK	74.0	-9.4	1.00 V	252	55.78	8.82
4	5356.00	53.2 AV	54.0	-0.8	1.00 V	252	44.38	8.82
5	*5745.00	115.8 PK			1.00 V	252	105.86	9.94
6	*5745.00	106.8 AV			1.00 V	252	96.86	9.94
7	11490.00	65.4 PK	74.0	-8.6	1.00 V	215	48.82	16.58
8	11490.00	53.1 AV	54.0	-0.9	1.00 V	215	36.52	16.58

REMARKS:

1. Emission Level(dBuV/m) = Raw Value(dBuV) + Correction Factor(dB/m)
2. Correction Factor(dB/m) = Antenna Factor(dB/m) + Cable Factor(dB) – Pre-Amplifier Factor(dB)
3. The other emission levels were very low against the limit.
4. Margin value = Emission Level – Limit value
5. " * ": Fundamental frequency.
6. The limit value is defined as per 15.247.



A D T

CHANNEL	TX Channel 157	DETECTOR FUNCTION	Peak (PK)
FREQUENCY RANGE	1GHz ~ 40GHz		Average (AV)

ANTENNA POLARITY & TEST DISTANCE: HORIZONTAL AT 3 M

NO.	FREQ. (MHz)	EMISSION LEVEL (dBuV/m)	LIMIT (dBuV/m)	MARGIN (dB)	ANTENNA HEIGHT (m)	TABLE ANGLE (Degree)	RAW VALUE (dBuV)	CORRECTION FACTOR (dB/m)
1	5357.00	63.7 PK	74.0	-10.3	1.00 H	181	54.87	8.83
2	5357.00	50.8 AV	54.0	-3.2	1.00 H	181	41.97	8.83
3	*5785.00	111.0 PK			1.00 H	180	100.99	10.01
4	*5785.00	101.7 AV			1.00 H	180	91.69	10.01
5	11570.00	67.0 PK	74.0	-7.0	1.03 H	217	50.36	16.64
6	11570.00	52.9 AV	54.0	-1.1	1.03 H	217	36.26	16.64

ANTENNA POLARITY & TEST DISTANCE: VERTICAL AT 3 M

NO.	FREQ. (MHz)	EMISSION LEVEL (dBuV/m)	LIMIT (dBuV/m)	MARGIN (dB)	ANTENNA HEIGHT (m)	TABLE ANGLE (Degree)	RAW VALUE (dBuV)	CORRECTION FACTOR (dB/m)
1	5357.00	65.4 PK	74.0	-8.6	1.00 V	117	56.57	8.83
2	5357.00	53.1 AV	54.0	-0.9	1.00 V	117	44.27	8.83
3	*5785.00	113.0 PK			1.00 V	117	102.99	10.01
4	*5785.00	102.8 AV			1.00 V	117	92.79	10.01
5	11570.00	65.8 PK	74.0	-8.2	1.00 V	217	49.16	16.64
6	11570.00	52.6 AV	54.0	-1.4	1.00 V	217	35.96	16.64

REMARKS:

1. Emission Level(dBuV/m) = Raw Value(dBuV) + Correction Factor(dB/m)
2. Correction Factor(dB/m) = Antenna Factor(dB/m) + Cable Factor(dB) – Pre-Amplifier Factor(dB)
3. The other emission levels were very low against the limit.
4. Margin value = Emission Level – Limit value
5. " * ": Fundamental frequency.
6. The limit value is defined as per 15.247.



A D T

CHANNEL	TX Channel 165	DETECTOR FUNCTION	Peak (PK)
FREQUENCY RANGE	1GHz ~ 40GHz		Average (AV)

ANTENNA POLARITY & TEST DISTANCE: HORIZONTAL AT 3 M

NO.	FREQ. (MHz)	EMISSION LEVEL (dBuV/m)	LIMIT (dBuV/m)	MARGIN (dB)	ANTENNA HEIGHT (m)	TABLE ANGLE (Degree)	RAW VALUE (dBuV)	CORRECTION FACTOR (dB/m)
1	5371.00	62.9 PK	74.0	-11.1	1.00 H	189	54.03	8.87
2	5371.00	51.2 AV	54.0	-2.8	1.00 H	189	42.33	8.87
3	*5825.00	112.3 PK			1.00 H	189	102.20	10.10
4	*5825.00	102.3 AV			1.00 H	189	92.20	10.10
5	11650.00	66.6 PK	74.0	-7.4	1.04 H	218	49.75	16.85
6	11650.00	53.1 AV	54.0	-0.9	1.04 H	218	36.25	16.85

ANTENNA POLARITY & TEST DISTANCE: VERTICAL AT 3 M

NO.	FREQ. (MHz)	EMISSION LEVEL (dBuV/m)	LIMIT (dBuV/m)	MARGIN (dB)	ANTENNA HEIGHT (m)	TABLE ANGLE (Degree)	RAW VALUE (dBuV)	CORRECTION FACTOR (dB/m)
1	5371.00	65.0 PK	74.0	-9.0	1.00 V	131	56.13	8.87
2	5371.00	53.2 AV	54.0	-0.8	1.00 V	131	44.33	8.87
3	*5825.00	112.1 PK			1.00 V	131	102.00	10.10
4	*5825.00	102.8 AV			1.00 V	131	92.70	10.10
5	11650.00	60.6 PK	74.0	-13.4	1.09 V	310	43.75	16.85
6	11650.00	50.3 AV	54.0	-3.7	1.09 V	310	33.45	16.85

REMARKS:

1. Emission Level(dBuV/m) = Raw Value(dBuV) + Correction Factor(dB/m)
2. Correction Factor(dB/m) = Antenna Factor(dB/m) + Cable Factor(dB) – Pre-Amplifier Factor(dB)
3. The other emission levels were very low against the limit.
4. Margin value = Emission Level – Limit value
5. " * ": Fundamental frequency.
6. The limit value is defined as per 15.247.



A D T

802.11n (HT40), 3Tx

CHANNEL	TX Channel 151	DETECTOR FUNCTION	Peak (PK)
FREQUENCY RANGE	1GHz ~ 40GHz		Average (AV)

ANTENNA POLARITY & TEST DISTANCE: HORIZONTAL AT 3 M

NO.	FREQ. (MHz)	EMISSION LEVEL (dBuV/m)	LIMIT (dBuV/m)	MARGIN (dB)	ANTENNA HEIGHT (m)	TABLE ANGLE (Degree)	RAW VALUE (dBuV)	CORRECTION FACTOR (dB/m)
1	5358.00	63.1 PK	74.0	-10.9	1.00 H	182	54.27	8.83
2	5358.00	51.2 AV	54.0	-2.8	1.00 H	182	42.37	8.83
3	*5755.00	110.7 PK			1.00 H	182	100.74	9.96
4	*5755.00	100.4 AV			1.00 H	182	90.44	9.96
5	11510.00	62.4 PK	74.0	-11.6	1.00 H	222	45.84	16.56
6	11510.00	50.3 AV	54.0	-3.7	1.00 H	222	33.74	16.56

ANTENNA POLARITY & TEST DISTANCE: VERTICAL AT 3 M

NO.	FREQ. (MHz)	EMISSION LEVEL (dBuV/m)	LIMIT (dBuV/m)	MARGIN (dB)	ANTENNA HEIGHT (m)	TABLE ANGLE (Degree)	RAW VALUE (dBuV)	CORRECTION FACTOR (dB/m)
1	5358.00	65.4 PK	74.0	-8.6	1.00 V	259	56.57	8.83
2	5358.00	52.9 AV	54.0	-1.1	1.00 V	259	44.07	8.83
3	*5755.00	112.5 PK			1.00 V	259	102.54	9.96
4	*5755.00	102.6 AV			1.00 V	259	92.64	9.96
5	11510.00	61.1 PK	74.0	-12.9	1.00 V	217	44.54	16.56
6	11510.00	49.2 AV	54.0	-4.8	1.00 V	217	32.64	16.56

REMARKS:

1. Emission Level(dBuV/m) = Raw Value(dBuV) + Correction Factor(dB/m)
2. Correction Factor(dB/m) = Antenna Factor(dB/m) + Cable Factor(dB) – Pre-Amplifier Factor(dB)
3. The other emission levels were very low against the limit.
4. Margin value = Emission Level – Limit value
5. " * ": Fundamental frequency.
6. The limit value is defined as per 15.247.



A D T

CHANNEL	TX Channel 159	DETECTOR FUNCTION	Peak (PK)
FREQUENCY RANGE	1GHz ~ 40GHz		Average (AV)

ANTENNA POLARITY & TEST DISTANCE: HORIZONTAL AT 3 M

NO.	FREQ. (MHz)	EMISSION LEVEL (dBuV/m)	LIMIT (dBuV/m)	MARGIN (dB)	ANTENNA HEIGHT (m)	TABLE ANGLE (Degree)	RAW VALUE (dBuV)	CORRECTION FACTOR (dB/m)
1	5359.00	64.4 PK	74.0	-9.6	1.00 H	180	55.57	8.83
2	5359.00	50.8 AV	54.0	-3.2	1.00 H	180	41.97	8.83
3	*5795.00	108.2 PK			1.00 H	180	98.19	10.01
4	*5795.00	98.7 AV			1.00 H	180	88.69	10.01
5	11590.00	60.0 PK	74.0	-14.0	1.19 H	225	43.33	16.67
6	11590.00	47.9 AV	54.0	-6.1	1.19 H	225	31.23	16.67

ANTENNA POLARITY & TEST DISTANCE: VERTICAL AT 3 M

NO.	FREQ. (MHz)	EMISSION LEVEL (dBuV/m)	LIMIT (dBuV/m)	MARGIN (dB)	ANTENNA HEIGHT (m)	TABLE ANGLE (Degree)	RAW VALUE (dBuV)	CORRECTION FACTOR (dB/m)
1	5359.00	65.0 PK	74.0	-9.0	1.00 V	118	56.17	8.83
2	5359.00	53.3 AV	54.0	-0.7	1.00 V	118	44.47	8.83
3	*5795.00	110.0 PK			1.00 V	360	99.99	10.01
4	*5795.00	100.0 AV			1.00 V	360	89.99	10.01
5	11590.00	59.0 PK	74.0	-15.0	1.00 V	312	42.33	16.67
6	11590.00	47.0 AV	54.0	-7.0	1.00 V	312	30.33	16.67

REMARKS:

1. Emission Level(dBuV/m) = Raw Value(dBuV) + Correction Factor(dB/m)
2. Correction Factor(dB/m) = Antenna Factor(dB/m) + Cable Factor(dB) – Pre-Amplifier Factor(dB)
3. The other emission levels were very low against the limit.
4. Margin value = Emission Level – Limit value
5. " * ": Fundamental frequency.
6. The limit value is defined as per 15.247.

5.3 6dB BANDWIDTH MEASUREMENT

5.3.1 LIMITS OF 6dB BANDWIDTH MEASUREMENT

The minimum of 6dB Bandwidth Measurement is 0.5 MHz.

5.3.2 TEST INSTRUMENTS

DESCRIPTION & MANUFACTURER	MODEL NO.	SERIAL NO.	CALIBRATED DATE	CALIBRATED UNTIL
Spectrum Analyzer R&S	FSP40	100036	Jan. 21, 2014	Jan. 20, 2015

Note:

1. The calibration interval of the above test instruments is 12 months and the calibrations are traceable to NML/ROC and NIST/USA.
2. Tested date : Feb. 26, 2014

5.3.3 TEST PROCEDURE

1. Set resolution bandwidth (RBW) = 100kHz
2. Set the video bandwidth (VBW) $\geq 3 \times$ RBW, Detector = Peak.
3. Trace mode = max hold.
4. Sweep = auto couple.
5. Measure the maximum width of the emission that is constrained by the frequencies associated with the two amplitude points (upper and lower) that are attenuated by 6 dB relative to the maximum level measured in the fundamental emission

5.3.4 DEVIATION FROM TEST STANDARD

No deviation

5.3.5 TEST SETUP

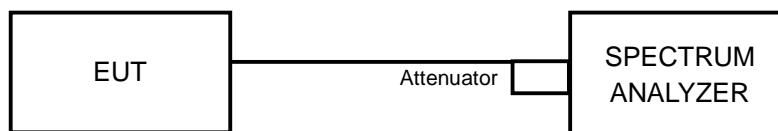

5.3.6 EUT OPERATING CONDITIONS

The software provided by client to enable the EUT under transmission condition continuously at lowest, middle and highest channel frequencies individually.



A D T

5.3.7 TEST RESULTS

802.11a, 1Tx

CHANNEL	CHANNEL FREQUENCY (MHz)	6dB BANDWIDTH (MHz)	MINIMUM LIMIT (MHz)	PASS / FAIL
149	5745	16.45	0.5	PASS
157	5785	16.43	0.5	PASS
165	5825	16.45	0.5	PASS

802.11n(HT20), 1Tx

CHANNEL	CHANNEL FREQUENCY (MHz)	6dB BANDWIDTH (MHz)	MINIMUM LIMIT (MHz)	PASS / FAIL
149	5745	17.68	0.5	PASS
157	5785	17.66	0.5	PASS
165	5825	17.66	0.5	PASS

802.11n(HT40), 1Tx

CHANNEL	CHANNEL FREQUENCY (MHz)	6dB BANDWIDTH (MHz)	MINIMUM LIMIT (MHz)	PASS / FAIL
151	5755	36.50	0.5	PASS
159	5795	36.47	0.5	PASS



A D T

SPECTRUM PLOT OF WORST VALUE

802.11a / CH157

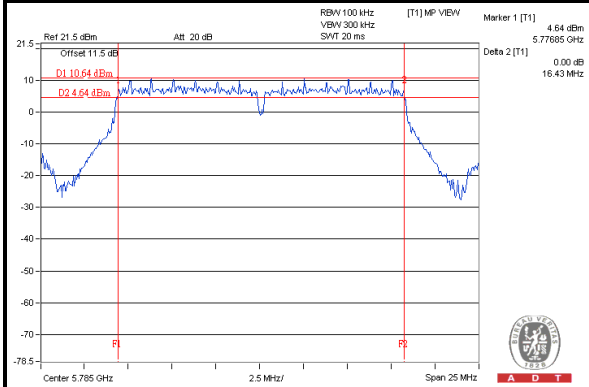

802.11n (HT20) / CH157

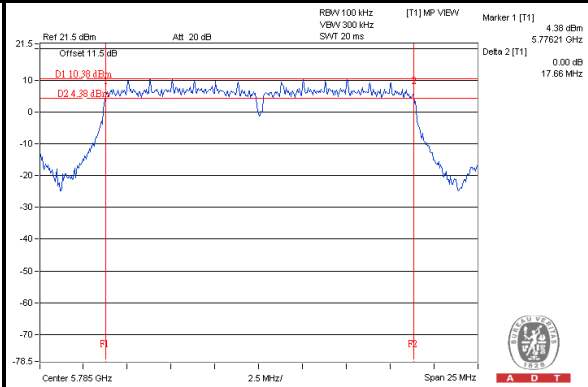

802.11n (HT40) / CH159

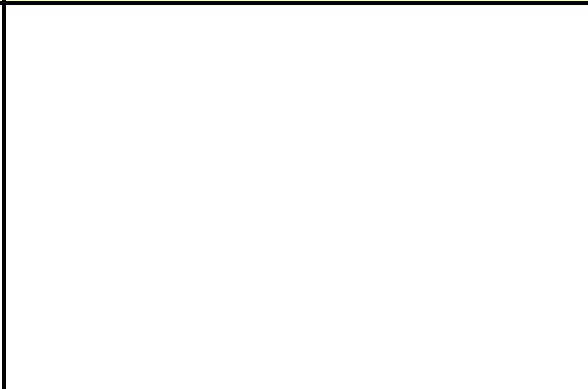
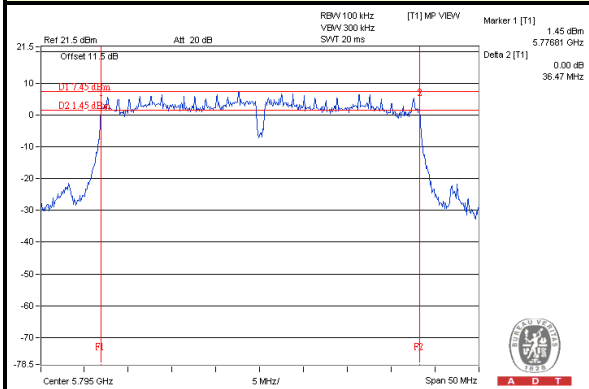



A D T

802.11n (HT20), 2Tx

CHANNEL	CHANNEL FREQUENCY (MHz)	6dB BANDWIDTH (MHz)		MINIMUM LIMIT (MHz)	PASS / FAIL
		CHAIN 0	CHAIN 1		
149	5745	17.66	17.69	0.5	PASS
157	5785	17.63	17.62	0.5	PASS
165	5825	17.64	17.64	0.5	PASS

802.11n (HT40), 2Tx

CHANNEL	CHANNEL FREQUENCY (MHz)	6dB BANDWIDTH (MHz)		MINIMUM LIMIT (MHz)	PASS / FAIL
		CHAIN 0	CHAIN 1		
151	5755	36.35	36.48	0.5	PASS
159	5795	36.16	36.53	0.5	PASS

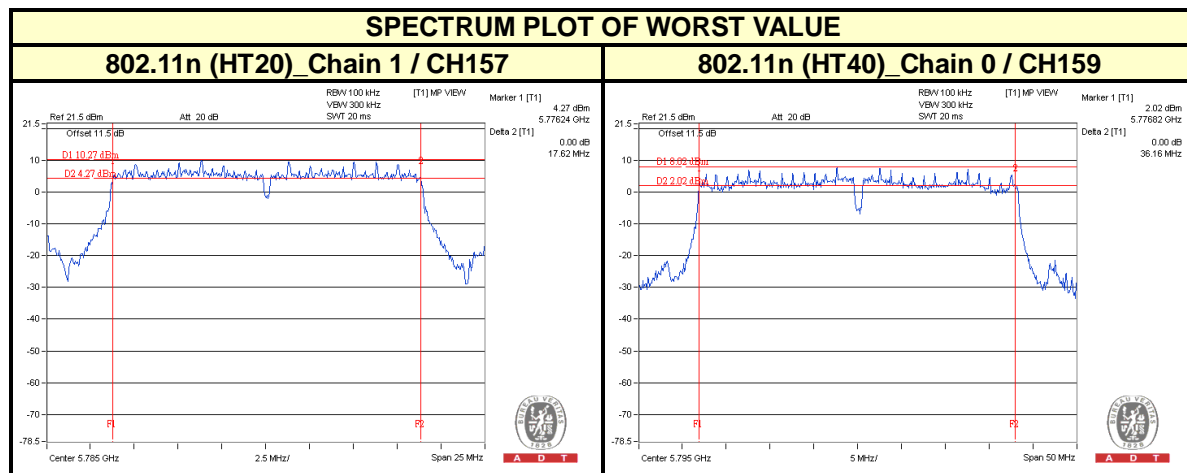



A D T

802.11a, 3Tx

CHANNEL	CHANNEL FREQUENCY (MHz)	6dB BANDWIDTH (MHz)			MINIMUM LIMIT (MHz)	PASS / FAIL
		CHAIN 0	CHAIN 1	CHAIN 2		
149	5745	16.36	16.09	16.44	0.5	PASS
157	5785	16.40	15.80	16.47	0.5	PASS
165	5825	16.44	16.42	16.38	0.5	PASS

802.11n (HT20), 3Tx

CHANNEL	CHANNEL FREQUENCY (MHz)	6dB BANDWIDTH (MHz)			MINIMUM LIMIT (MHz)	PASS / FAIL
		CHAIN 0	CHAIN 1	CHAIN 2		
149	5745	17.64	17.67	17.69	0.5	PASS
157	5785	17.64	17.66	17.63	0.5	PASS
165	5825	17.65	17.62	17.62	0.5	PASS

802.11n (HT40), 3Tx

CHANNEL	CHANNEL FREQUENCY (MHz)	6dB BANDWIDTH (MHz)			MINIMUM LIMIT (MHz)	PASS / FAIL
		CHAIN 0	CHAIN 1	CHAIN 2		
151	5755	36.19	36.45	36.42	0.5	PASS
159	5795	36.08	36.42	36.40	0.5	PASS



A D T

SPECTRUM PLOT OF WORST VALUE

802.11a_Chain 1 / CH157

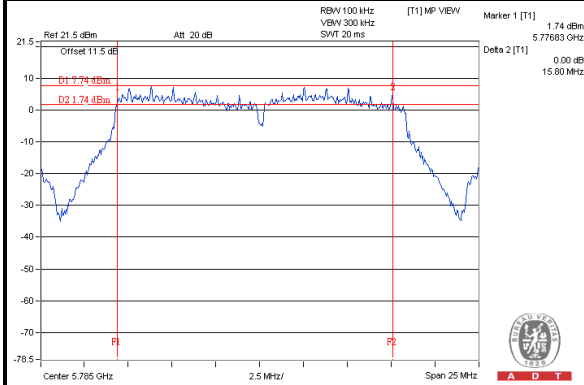

802.11n (HT20)_Chain 1 / CH165

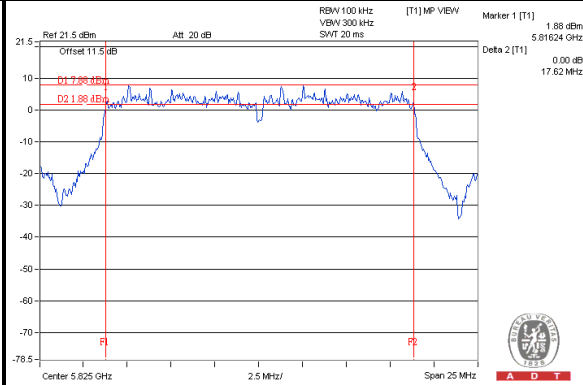

802.11n (HT40)_Chain 0 / CH159

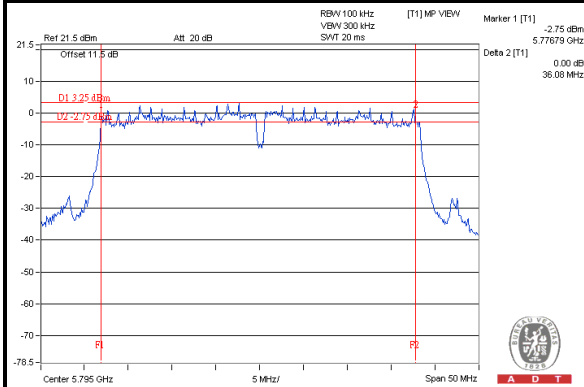

5.4 CONDUCTED OUTPUT POWER MEASUREMENT

5.4.1 LIMITS OF CONDUCTED OUTPUT POWER MEASUREMENT

For systems using digital modulation in the 5725 –5850 MHz band: 1 Watt (30dBm)

Per KDB 662911 D01 Multiple Transmitter Output Method of conducted output power measurement on IEEE 802.11 devices,

Array Gain = 0 dB (i.e., no array gain) for NANT \leq 4;

Array Gain = 0 dB (i.e., no array gain) for channel widths \geq 40 MHz for any NANT;

Array Gain = 5 log(NANT/NSS) dB or 3 dB, whichever is less for 20-MHz channel widths with NANT \geq 5.

For power measurements on all other devices: Array Gain = 10 log(NANT/NSS) dB.

5.4.2 INSTRUMENTS

DESCRIPTION & MANUFACTURER	MODEL NO.	SERIAL NO.	CALIBRATED DATE	CALIBRATED UNTIL
Power meter Anritsu	ML2495A	0824006	May 20, 2013	May 19, 2014
Power sensor Anritsu	MA2411B	0738172	May 20, 2013	May 19, 2014

Note:

1. The calibration interval of the above test instruments is 12 months and the calibrations are traceable to NML/ROC and NIST/USA.
2. Tested date : Feb. 26, 2014

5.4.3 TEST PROCEDURES

Method PM is used to perform output power measurement, trigger and gating function of wide band power meter is enabled to measure max output power of TX on burst. Duty factor is not added to measured value.

5.4.4 DEVIATION FROM TEST STANDARD

No deviation.

5.4.5 TEST SETUP

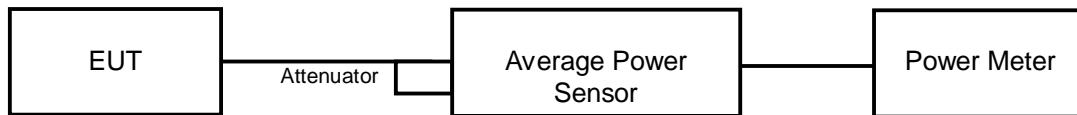

5.4.6 EUT OPERATING CONDITIONS

Same as Item 5.3.6



A D T

5.4.7 TEST RESULTS

802.11a, 1Tx

CHANNEL	FREQUENCY (MHz)	AVERAGE POWER (mW)	AVERAGE POWER (dBm)	LIMIT (dBm)	PASS/FAIL
149	5745	171.396	22.34	30	PASS
157	5785	170.216	22.31	30	PASS
165	5825	174.582	22.42	30	PASS

802.11n (HT20), 1Tx

CHANNEL	FREQUENCY (MHz)	AVERAGE POWER (mW)	AVERAGE POWER (dBm)	LIMIT (dBm)	PASS/FAIL
149	5745	173.380	22.39	30	PASS
157	5785	172.187	22.36	30	PASS
165	5825	176.604	22.47	30	PASS

802.11n (HT40), 1Tx

CHANNEL	FREQUENCY (MHz)	AVERAGE POWER (mW)	AVERAGE POWER (dBm)	LIMIT (dBm)	PASS/FAIL
151	5755	146.218	21.65	30	PASS
159	5795	146.893	21.67	30	PASS



A D T

802.11n (HT20), 2Tx

CHANNEL	FREQUENCY (MHz)	AVERAGE POWER (dBm)		TOTAL POWER (mW)	TOTAL POWER (dBm)	LIMIT (dBm)	PASS / FAIL
		CHAIN 0	CHAIN 1				
149	5745	20.28	19.93	205.061	23.12	30	PASS
157	5785	21.60	21.15	274.861	24.39	30	PASS
165	5825	20.31	20.21	212.353	23.27	30	PASS

802.11n (HT40), 2Tx

CHANNEL	FREQUENCY (MHz)	AVERAGE POWER (dBm)		TOTAL POWER (mW)	TOTAL POWER (dBm)	LIMIT (dBm)	PASS / FAIL
		CHAIN 0	CHAIN 1				
151	5755	21.54	21.35	279.019	24.46	30	PASS
159	5795	21.66	21.28	280.831	24.48	30	PASS



A D T

802.11a, 3Tx

CHANNEL	FREQUENCY (MHz)	AVERAGE POWER (dBm)			TOTAL POWER (mW)	TOTAL POWER (dBm)	LIMIT (dBm)	PASS / FAIL
		CHAIN 0	CHAIN 1	CHAIN 2				
149	5745	21.14	21.03	20.84	378.121	25.78	30	PASS
157	5785	19.25	18.71	18.74	233.259	23.68	30	PASS
165	5825	19.67	19.57	19.42	270.754	24.33	30	PASS

802.11n (HT20), 3Tx

CHANNEL	FREQUENCY (MHz)	AVERAGE POWER (dBm)			TOTAL POWER (mW)	TOTAL POWER (dBm)	LIMIT (dBm)	PASS / FAIL
		CHAIN 0	CHAIN 1	CHAIN 2				
149	5745	20.82	20.27	20.71	344.956	25.38	30	PASS
157	5785	18.11	17.78	17.77	184.534	22.66	30	PASS
165	5825	19.18	18.67	18.66	229.866	23.61	30	PASS

802.11n (HT40), 3Tx

CHANNEL	FREQUENCY (MHz)	AVERAGE POWER (dBm)			TOTAL POWER (mW)	TOTAL POWER (dBm)	LIMIT (dBm)	PASS / FAIL
		CHAIN 0	CHAIN 1	CHAIN 2				
151	5755	19.11	18.57	18.35	221.806	23.46	30	PASS
159	5795	17.34	16.54	16.86	147.811	21.70	30	PASS

5.5 POWER SPECTRAL DENSITY MEASUREMENT

5.5.1 LIMITS OF POWER SPECTRAL DENSITY MEASUREMENT

The Maximum of Power Spectral Density Measurement is 8dBm.

5.5.2 TEST INSTRUMENTS

DESCRIPTION & MANUFACTURER	MODEL NO.	SERIAL NO.	CALIBRATED DATE	CALIBRATED UNTIL
Spectrum Analyzer R&S	FSP 40	100036	Jan. 21, 2014	Jan. 20, 2015

Note:

1. The calibration interval of the above test instruments is 12 months and the calibrations are traceable to NML/ROC and NIST/USA.
2. Tested date : Feb. 26, 2014

5.5.3 TEST PROCEDURE

1. Set the RBW = 30 kHz, VBW =100 kHz, Detector = power averaging (RMS).
2. Ensure that the number of measurement points in the sweep $\geq 2 \times$ span/RBW
3. Sweep time = auto couple,
4. Employ trace averaging (RMS) mode over a minimum of 100 traces.
5. Use the peak marker function to determine the maximum amplitude level.

5.5.4 DEVIATION FROM TEST STANDARD

No deviation

5.5.5 TEST SETUP

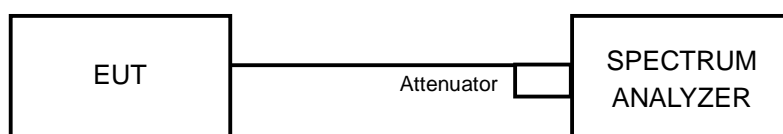

5.5.6 EUT OPERATING CONDITION

Same as Item 4.3.6



A D T

5.5.7 TEST RESULTS

802.11a, 1Tx

CHANNEL	FREQUENCY (MHz)	PSD (dBm)	LIMIT (dBm)	PASS /FAIL
149	5745	-9.53	8	PASS
157	5785	-9.21	8	PASS
165	5825	-9.51	8	PASS

802.11n(HT20), 1Tx

CHANNEL	FREQUENCY (MHz)	PSD (dBm)	LIMIT (dBm)	PASS /FAIL
149	5745	-9.94	8	PASS
157	5785	-9.46	8	PASS
165	5825	-9.82	8	PASS

802.11n(HT40), 1Tx

CHANNEL	FREQUENCY (MHz)	PSD (dBm)	LIMIT (dBm)	PASS /FAIL
151	5755	-13.50	8	PASS
159	5795	-13.14	8	PASS



A D T

SPECTRUM PLOT OF WORST VALUE

802.11a / CH157

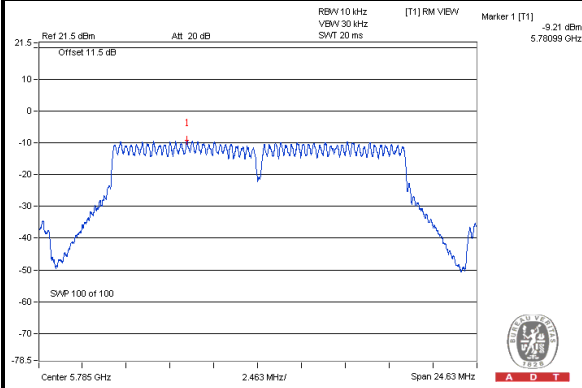

802.11n (HT20) / CH157

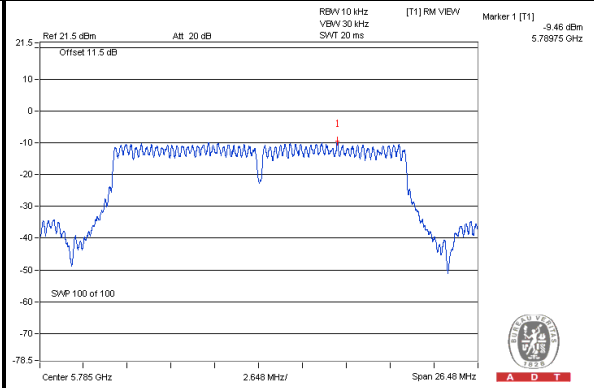

802.11n (HT40) / CH159

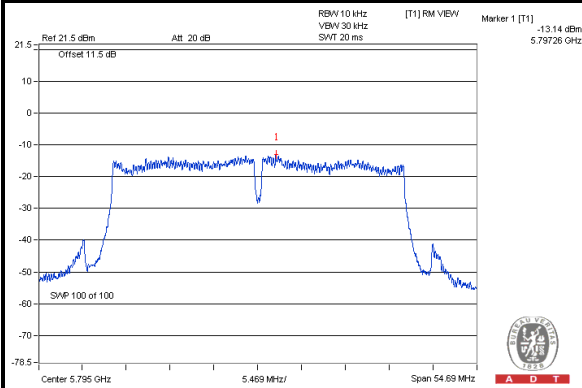



A D T

802.11n(HT20), 2Tx

TX CHAIN	CHANNEL	FREQUENCY (MHz)	PSD (dBm)	10 log (N=2) dB	TOTAL PSD (dBm)	LIMIT (dBm)	PASS /FAIL
0	149	5745	-12.10	3.01	-9.09	8	PASS
	157	5785	-11.07	3.01	-8.06	8	PASS
	165	5825	-12.19	3.01	-9.18	8	PASS
1	149	5745	-12.35	3.01	-9.34	8	PASS
	157	5785	-10.41	3.01	-7.40	8	PASS
	165	5825	-12.11	3.01	-9.10	8	PASS

802.11n(HT40), 2Tx

TX CHAIN	CHANNEL	FREQUENCY (MHz)	PSD (dBm)	10 log (N=2) dB	TOTAL PSD (dBm)	LIMIT (dBm)	PASS /FAIL
0	151	5755	-13.83	3.01	-10.82	8	PASS
	159	5795	-13.09	3.01	-10.08	8	PASS
1	151	5755	-13.25	3.01	-10.24	8	PASS
	159	5795	-13.44	3.01	-10.43	8	PASS

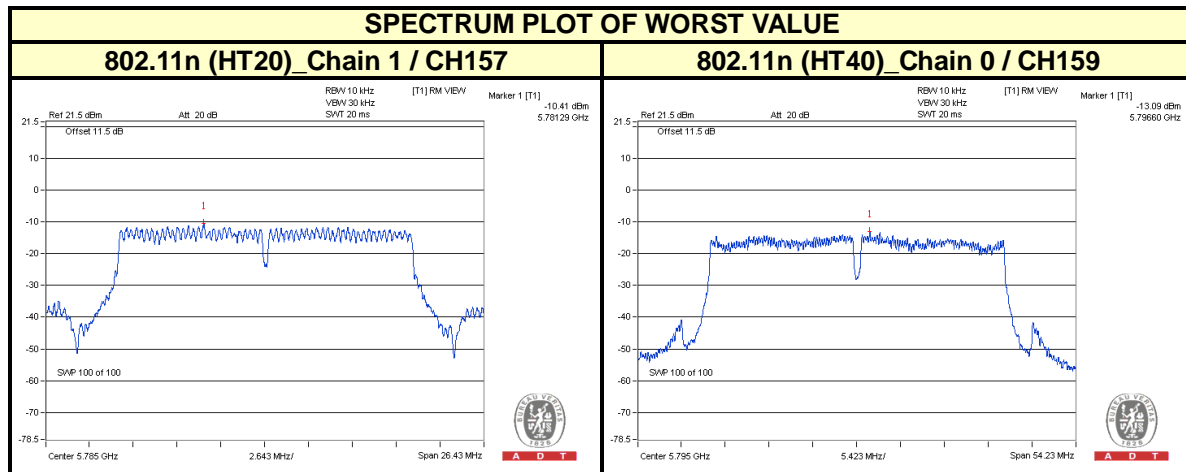



A D T

802.11a, 3Tx

TX CHAIN	CHANNEL	FREQUENCY (MHz)	PSD (dBm)	10 log (N=3) dB	TOTAL PSD (dBm)	LIMIT (dBm)	PASS /FAIL
0	149	5745	-9.90	4.77	-5.13	5.19	PASS
	157	5785	-11.70	4.77	-6.93	5.19	PASS
	165	5825	-11.51	4.77	-6.74	5.19	PASS
1	149	5745	-10.17	4.77	-5.40	5.19	PASS
	157	5785	-12.16	4.77	-7.39	5.19	PASS
	165	5825	-11.53	4.77	-6.76	5.19	PASS
2	149	5745	-10.08	4.77	-5.31	5.19	PASS
	157	5785	-12.28	4.77	-7.51	5.19	PASS
	165	5825	-11.61	4.77	-6.84	5.19	PASS

NOTE: 1. Directional gain = $10 \log[(10^{G1/20} + 10^{G2/20} + 10^{G3/20})^2 / 3] = 8.81 \text{dBi} > 6 \text{dBi}$, so the power density limit shall be reduced to $8-(8.81-6) = 5.19 \text{dBm}$.

802.11n(HT20), 3Tx

TX CHAIN	CHANNEL	FREQUENCY (MHz)	PSD (dBm)	10 log (N=3) dB	TOTAL PSD (dBm)	LIMIT (dBm)	PASS /FAIL
0	149	5745	-10.77	4.77	-6.00	5.19	PASS
	157	5785	-13.68	4.77	-8.91	5.19	PASS
	165	5825	-12.56	4.77	-7.79	5.19	PASS
1	149	5745	-11.34	4.77	-6.57	5.19	PASS
	157	5785	-13.64	4.77	-8.87	5.19	PASS
	165	5825	-12.86	4.77	-8.09	5.19	PASS
2	149	5745	-11.88	4.77	-7.11	5.19	PASS
	157	5785	-14.19	4.77	-9.42	5.19	PASS
	165	5825	-12.65	4.77	-7.88	5.19	PASS

NOTE: 1. Directional gain = $10 \log[(10^{G1/20} + 10^{G2/20} + 10^{G3/20})^2 / 3] = 8.81 \text{dBi} > 6 \text{dBi}$, so the power density limit shall be reduced to $8-(8.81-6) = 5.19 \text{dBm}$.



A D T

802.11n(HT40), 3Tx

TX CHAIN	CHANNEL	FREQUENCY (MHz)	PSD (dBm)	10 log (N=3) dB	TOTAL PSD (dBm)	LIMIT (dBm)	PASS /FAIL
0	151	5755	-15.31	4.77	-10.54	5.19	PASS
	159	5795	-17.66	4.77	-12.89	5.19	PASS
1	151	5755	-15.05	4.77	-10.28	5.19	PASS
	159	5795	-18.11	4.77	-13.34	5.19	PASS
2	151	5755	-15.90	4.77	-11.13	5.19	PASS
	159	5795	-17.19	4.77	-12.42	5.19	PASS

NOTE: 1. Directional gain = $10 \log[(10^{G1/20} + 10^{G2/20} + 10^{G3/20})^2 / 3] = 8.81 \text{dBi} > 6 \text{dBi}$, so the power density limit shall be reduced to $8-(8.81-6) = 5.19 \text{dBm}$.

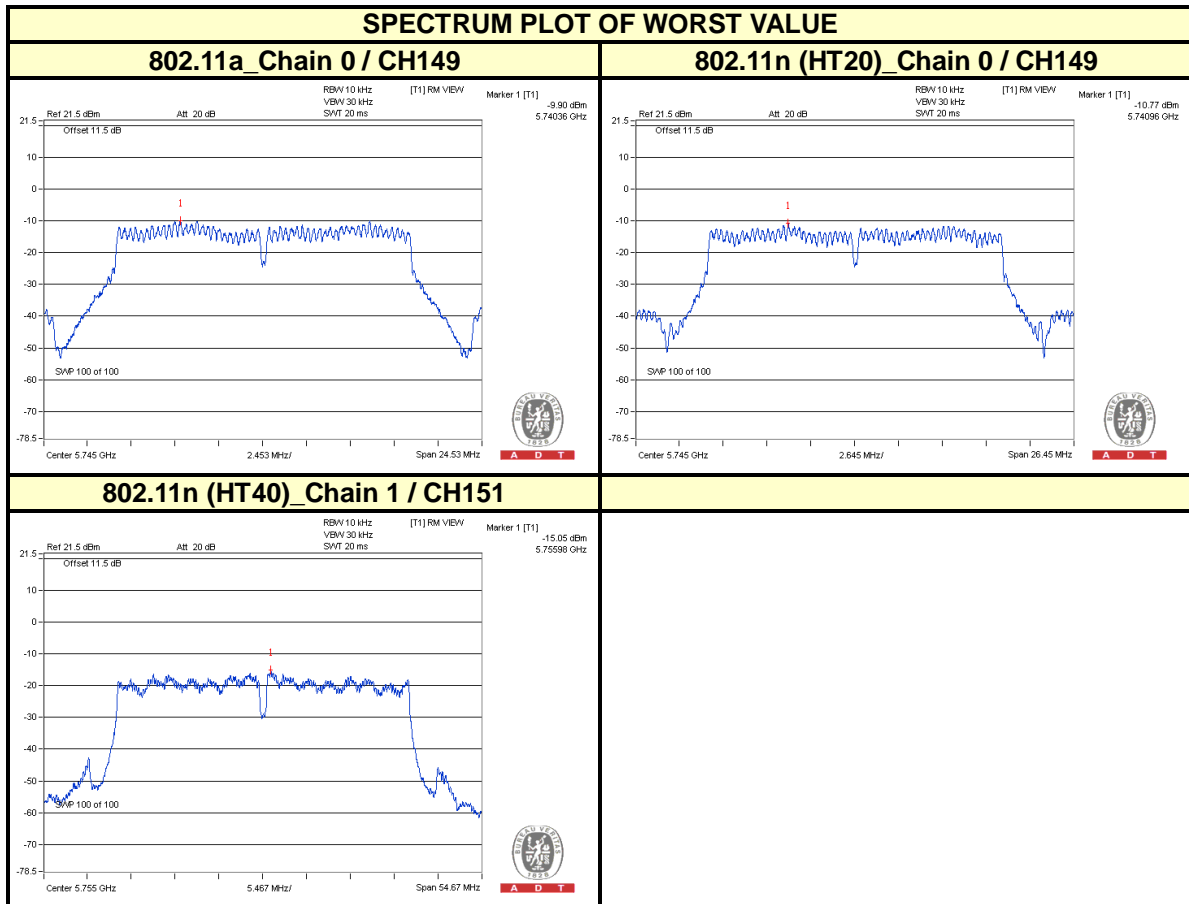

5.6 CONDUCTED OUT-BAND EMISSION MEASUREMENT

5.6.1 LIMITS OF CONDUCTED OUT-BAND EMISSION MEASUREMENT

Below 30dB of the highest emission level of operating band (in 100kHz Resolution Bandwidth).

5.6.2 TEST INSTRUMENTS

DESCRIPTION & MANUFACTURER	MODEL NO.	SERIAL NO.	CALIBRATED DATE	CALIBRATED UNTIL
Spectrum Analyzer R&S	FSP 40	100036	Jan. 21, 2014	Jan. 20, 2015

Note:

1. The calibration interval of the above test instruments is 12 months and the calibrations are traceable to NML/ROC and NIST/USA.
2. Tested date : Feb. 26, 2014

5.6.3 TEST PROCEDURE

Measurement Procedure - Reference Level

1. Set the RBW = 100 kHz.
2. Set the VBW \geq 300 kHz.
3. Detector = peak.
4. Sweep time = auto couple.
5. Trace mode = max hold.
6. Allow trace to fully stabilize.
7. Use the peak marker function to determine the maximum power level in any 100 kHz band segment within the fundamental EBW.

Measurement Procedure –Unwanted Emission Level

1. Set RBW = 100 kHz.
2. Set VBW \geq 300 kHz.
3. Set span to encompass the spectrum to be examined
4. Detector = peak.
5. Trace Mode = max hold.
6. Sweep = auto couple.

5.6.4 DEVIATION FROM TEST STANDARD

No deviation

5.6.5 TEST SETUP

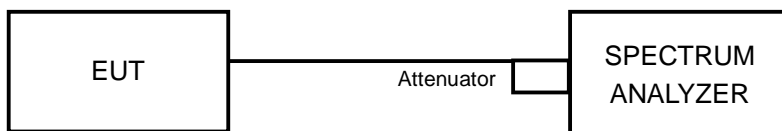

5.6.6 EUT OPERATING CONDITION

Same as Item 4.3.6

5.6.7 TEST RESULTS

The spectrum plots are attached on the following pages. D1 line indicates the highest level, and D2 line indicates the 30dB offset below D1. It shows compliance with the requirement.



A D T

802.11a, 1Tx:

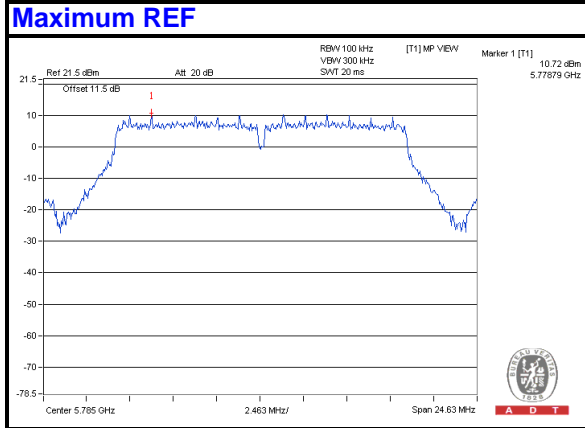

CH 149

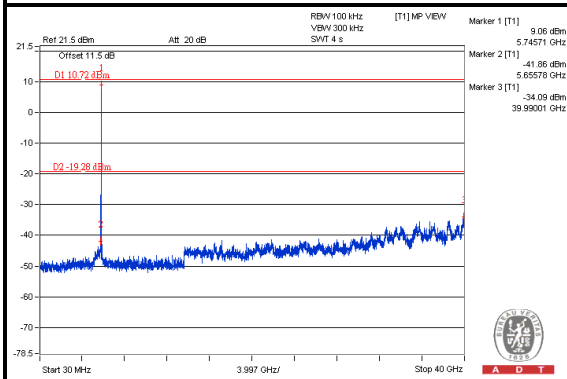

CH 157

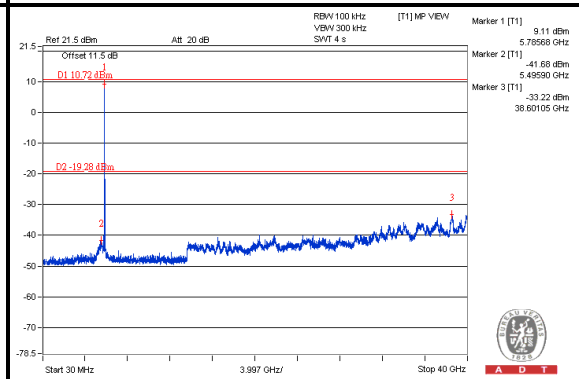

CH 165

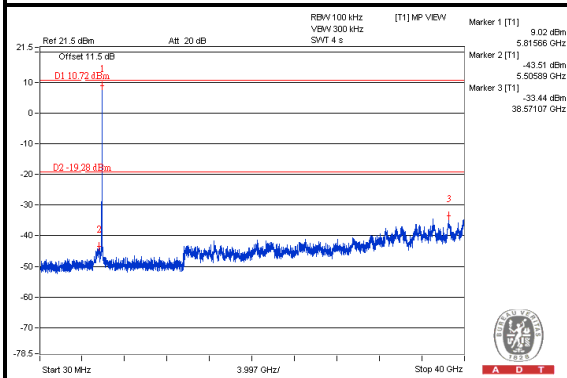

CH 149 Band edge

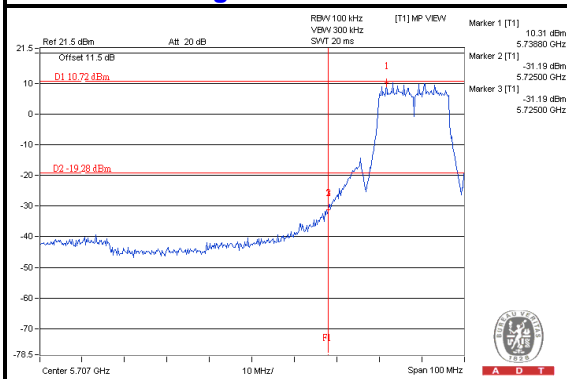

CH 165 Band edge

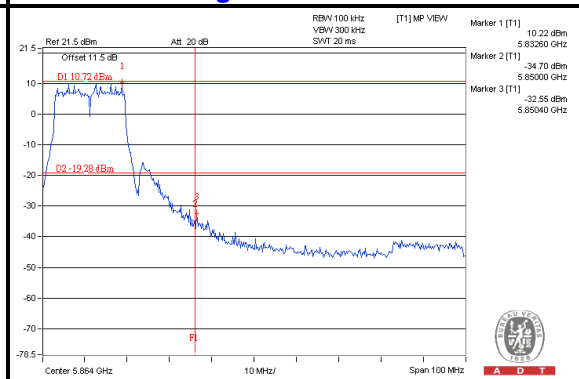



A D T

802.11n(HT20), 1Tx:

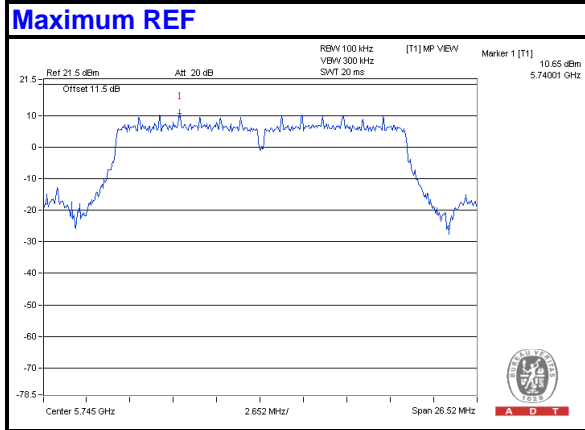

CH 149

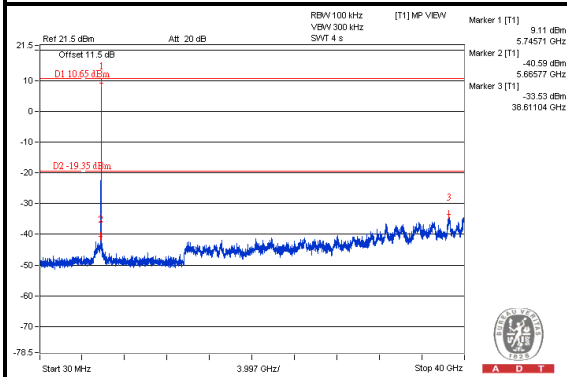

CH 157

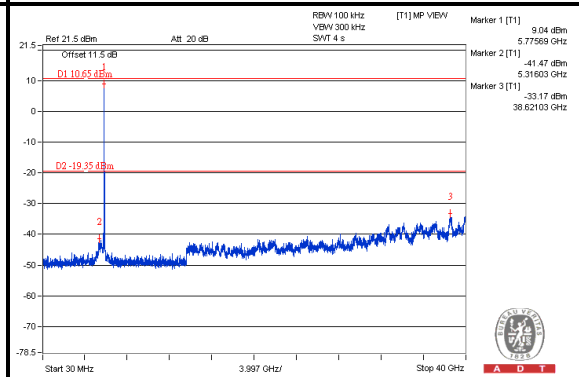

CH 165

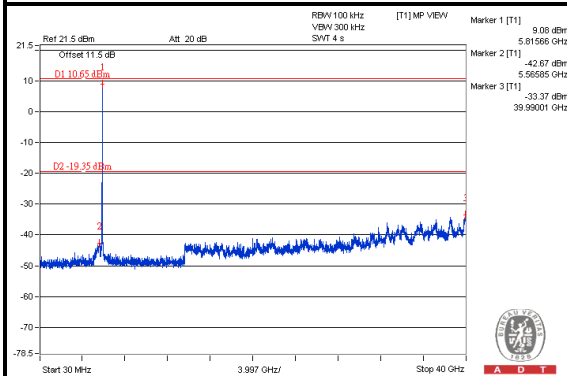

CH 149 Band edge

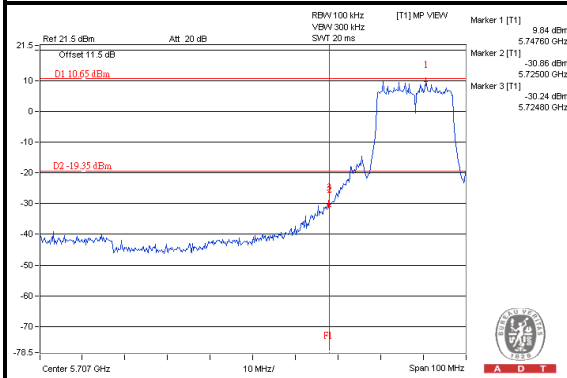

CH 165 Band edge

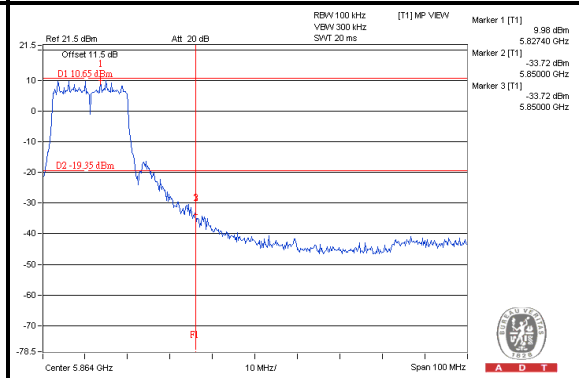



A D T

802.11n(HT40), 1Tx:

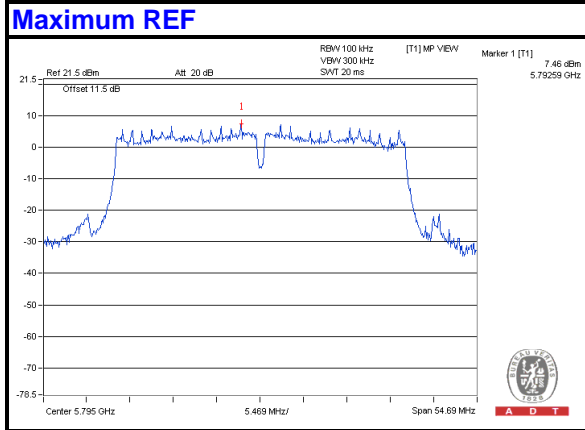

CH 151

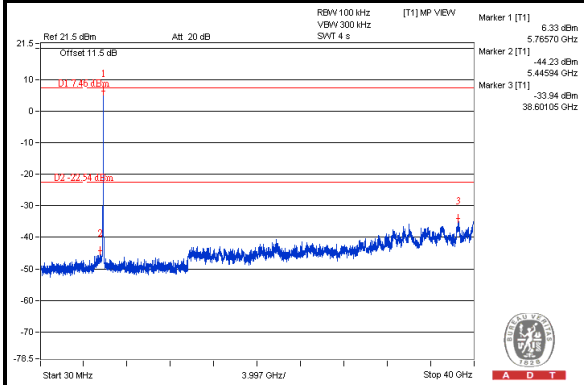

CH 159

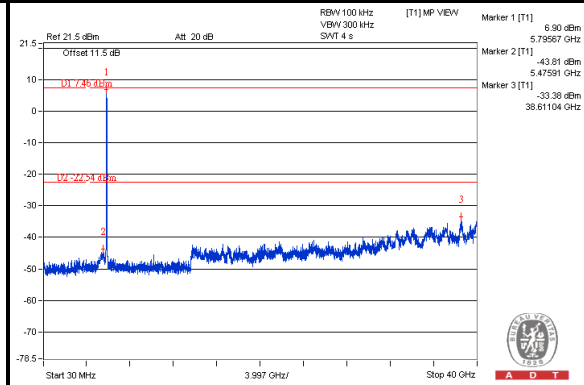

CH 151 Band edge

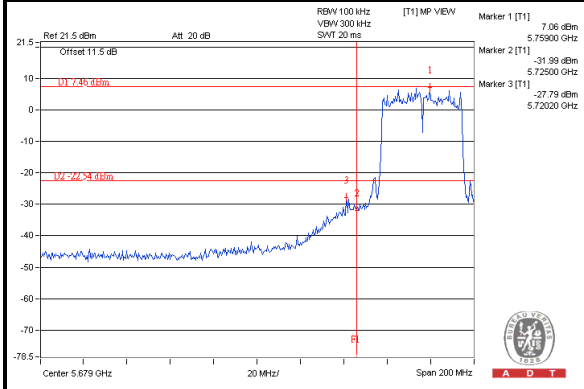

CH 159 Band edge

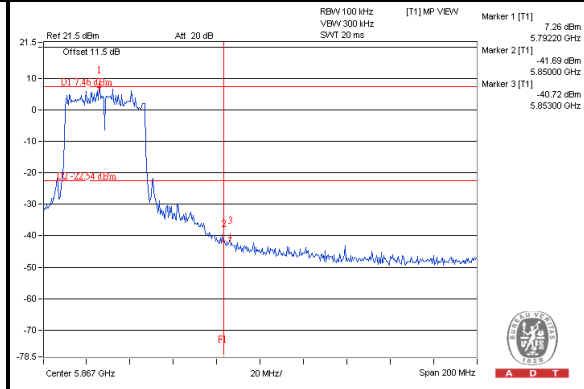



A D T

802.11n(HT20), 2Tx:

Maximum REF

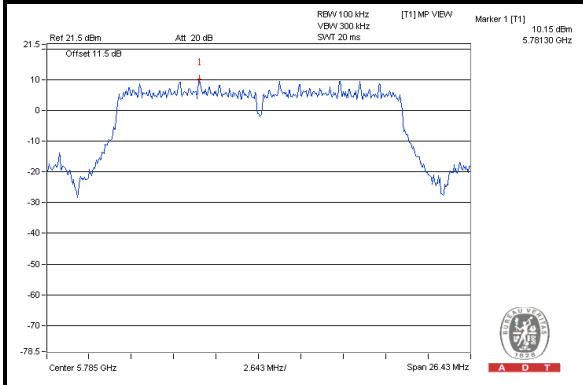

Chain 0

CH 149

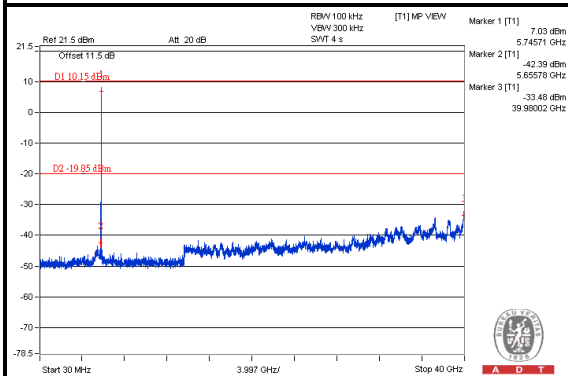

CH 157

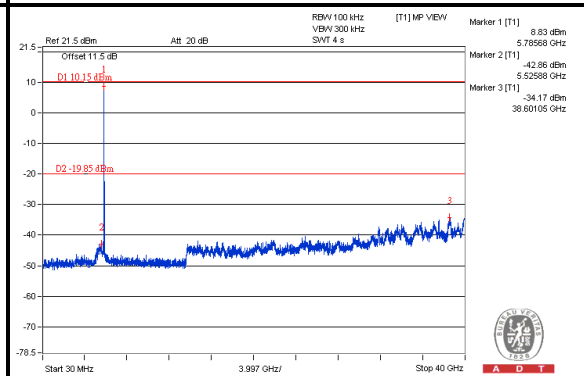

CH 165

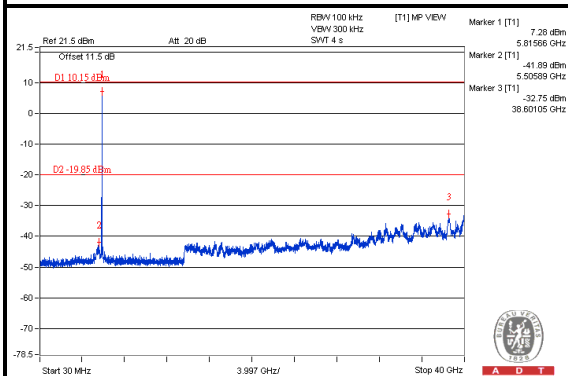

CH 149 Band edge

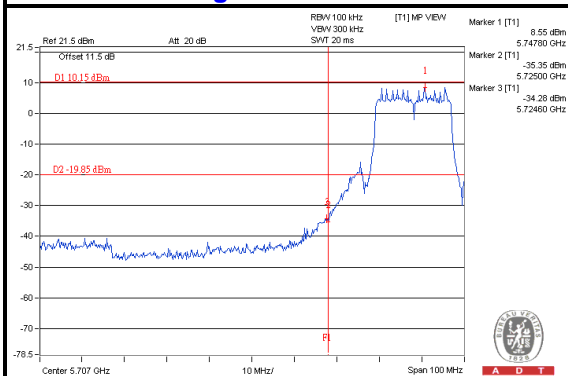

CH 165 Band edge

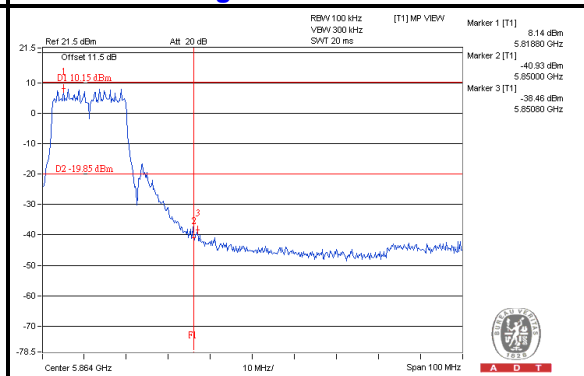



A D T

Chain 1 CH 149

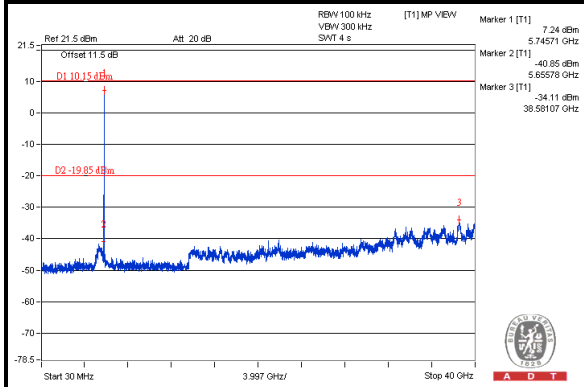

CH 157

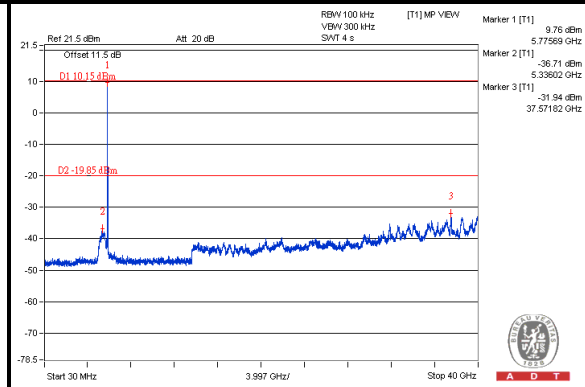

CH 165

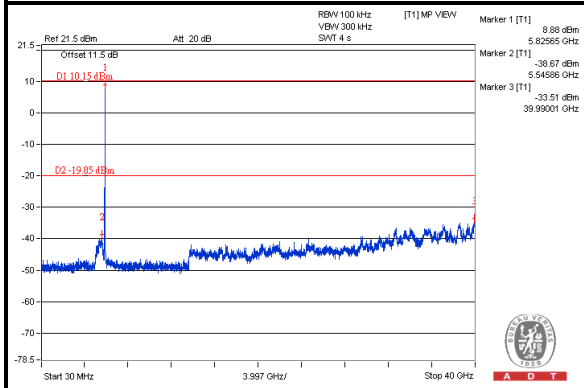

CH 149 Band edge

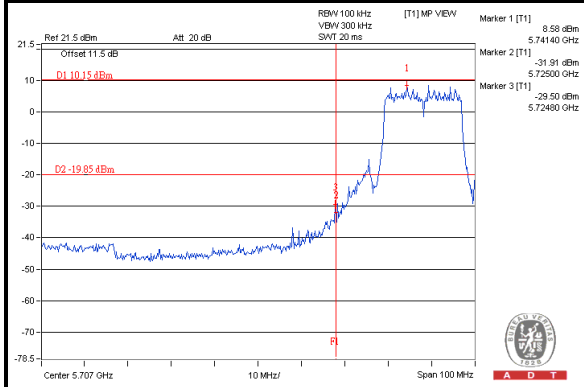

CH 165 Band edge

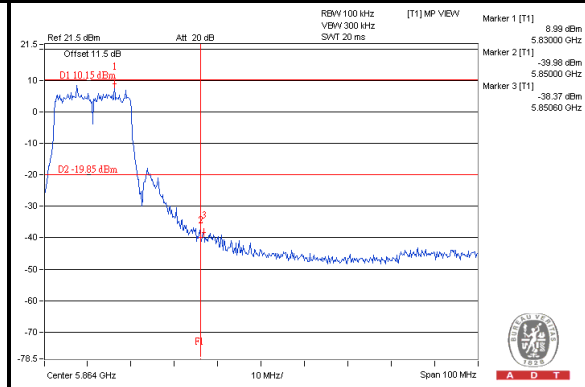



A D T

802.11n(HT40), 2Tx:

Maximum REF

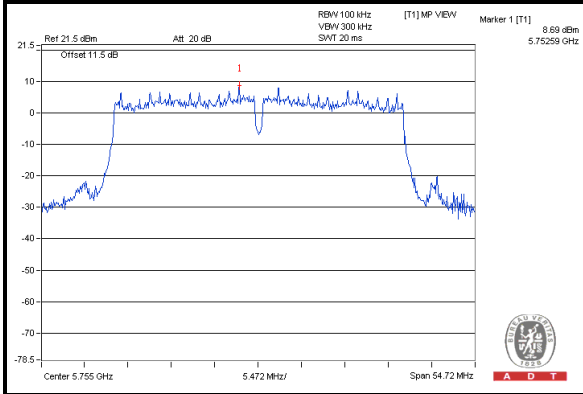

Chain 0

CH 151

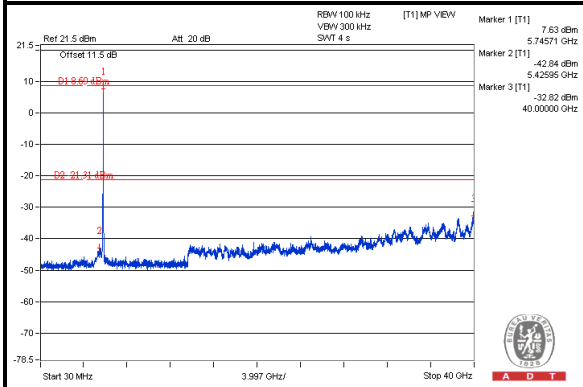

CH 159

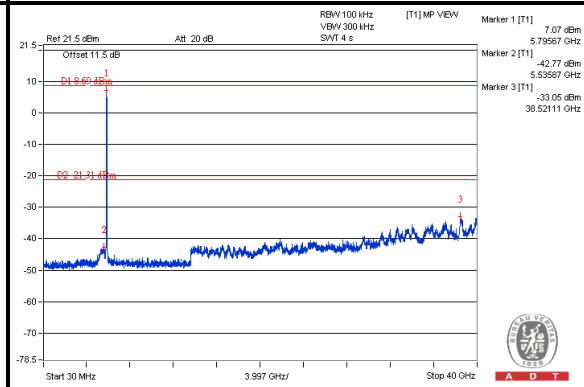

CH 151 Band edge

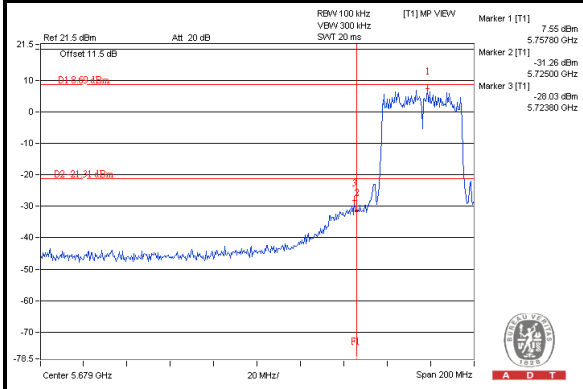

CH 159 Band edge

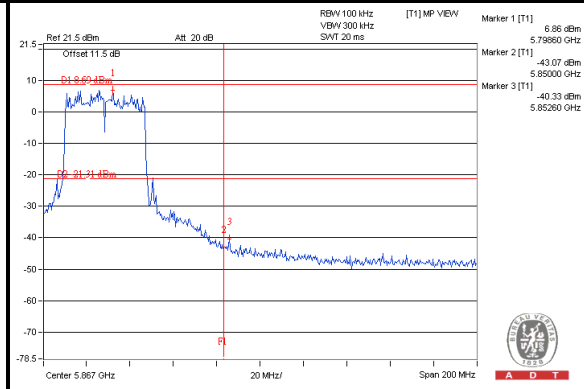



A D T

Chain 1 CH 151

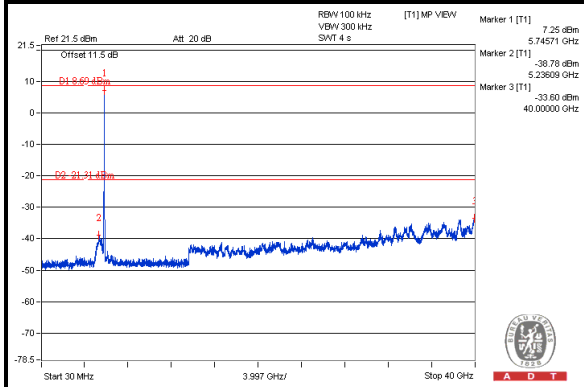

CH 159

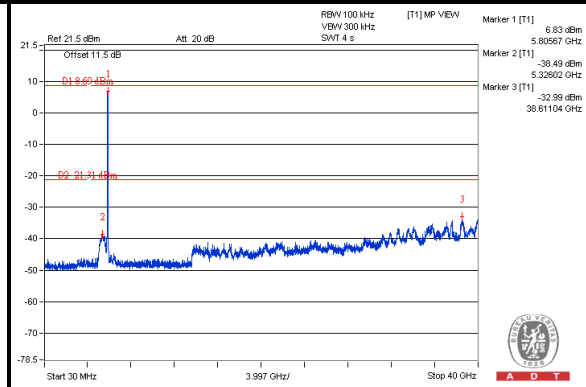

CH 151 Band edge

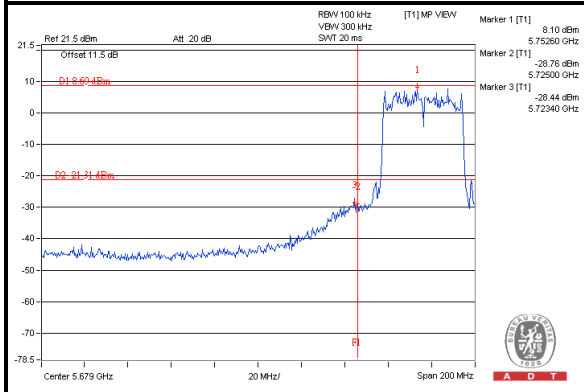

CH 159 Band edge

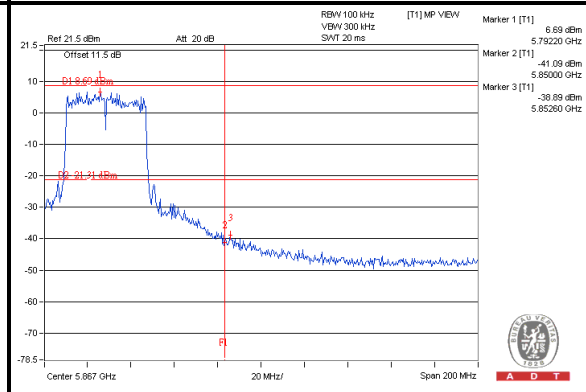



A D T

802.11a, 3Tx:

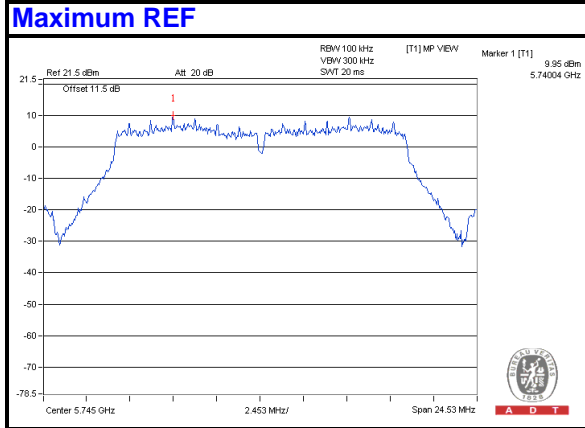

Chain 0

CH 149

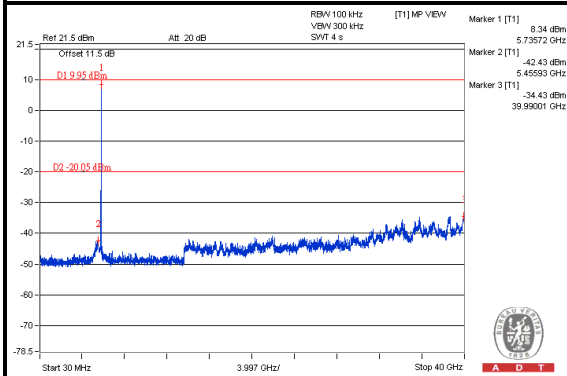

CH 157

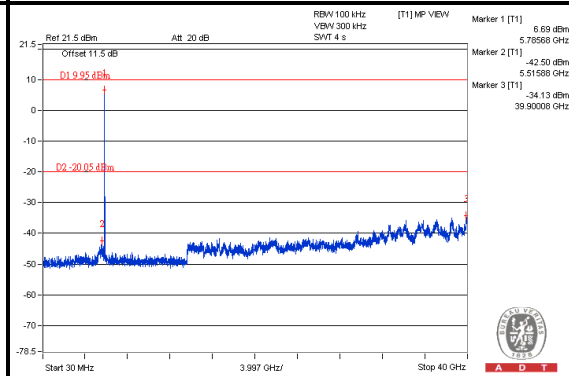

CH 165

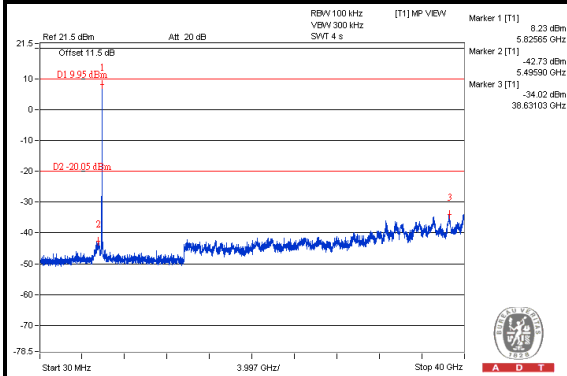

CH 149 Band edge

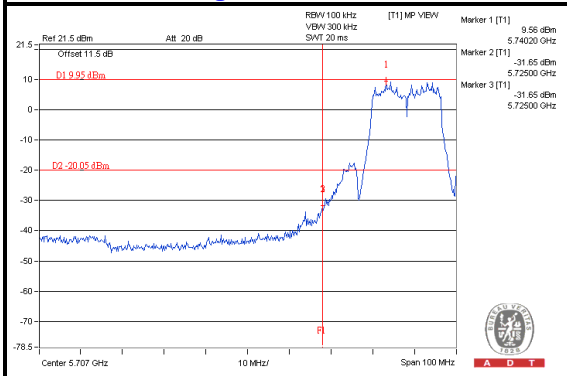

CH 165 Band edge

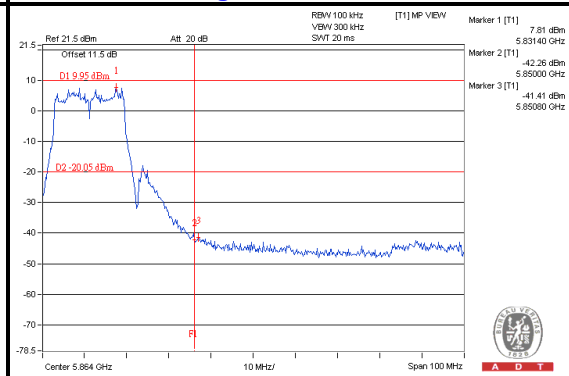



A D T

Chain 1 CH 149

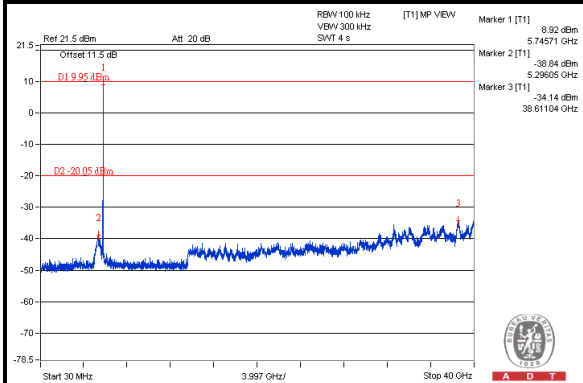

CH 157

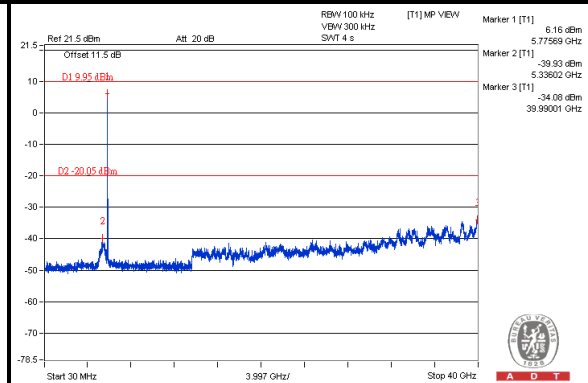

CH 165

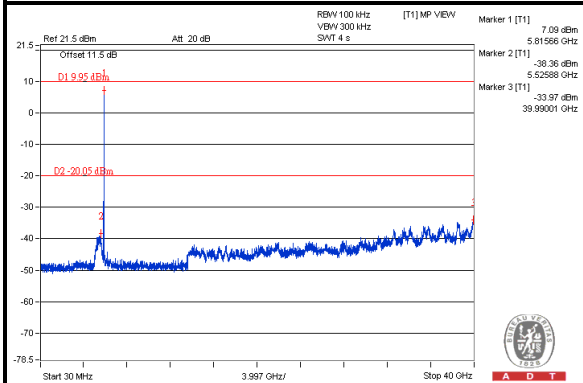

CH 149 Band edge

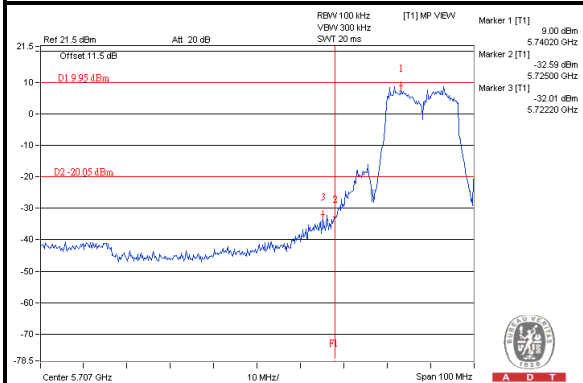

CH 165 Band edge

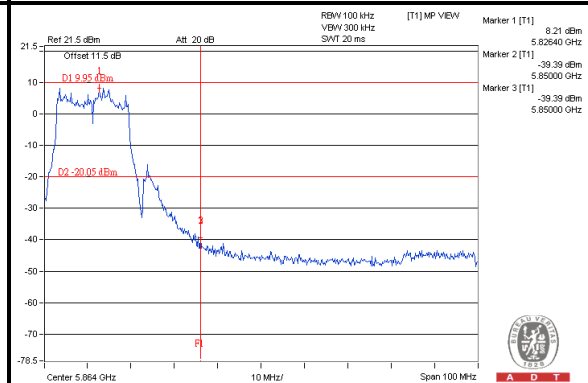



A D T

Chain 2 CH 149

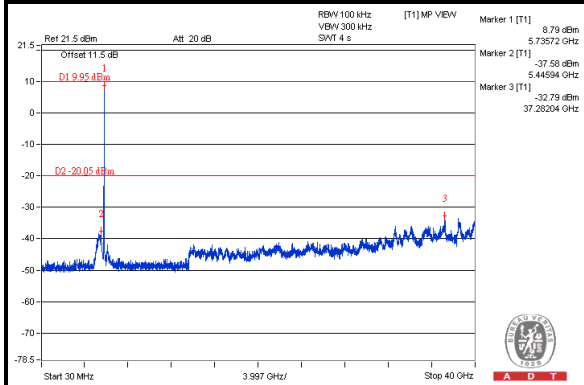

CH 157

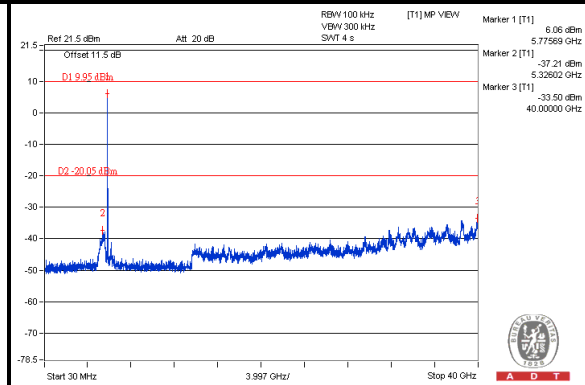

CH 165

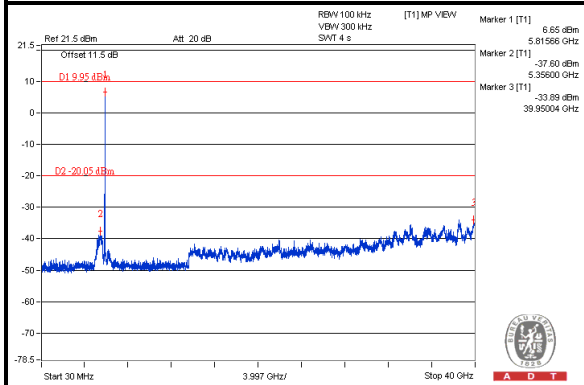

CH 149 Band edge

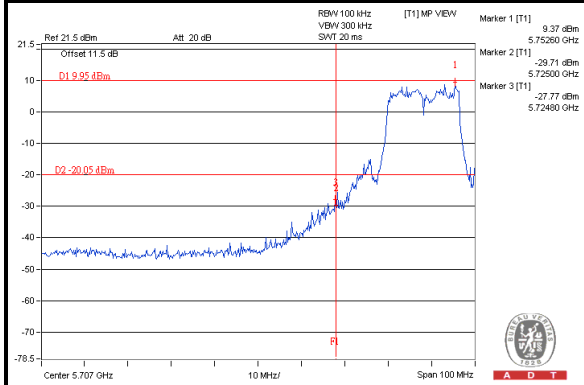

CH 165 Band edge

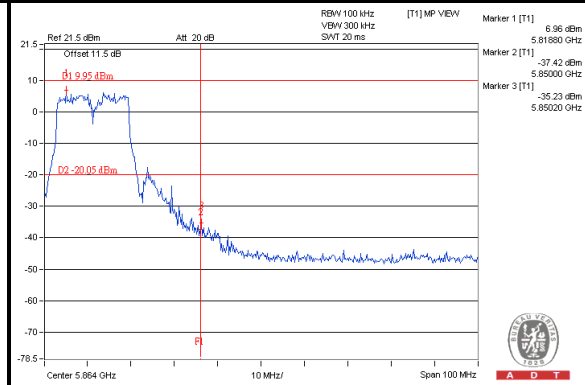



A D T

802.11n(HT20), 3Tx:

Maximum REF

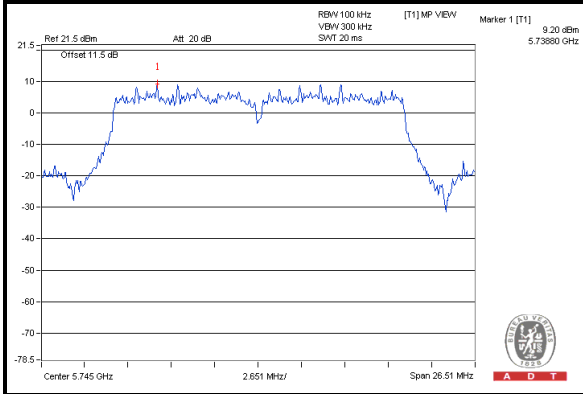

Chain 0

CH 149

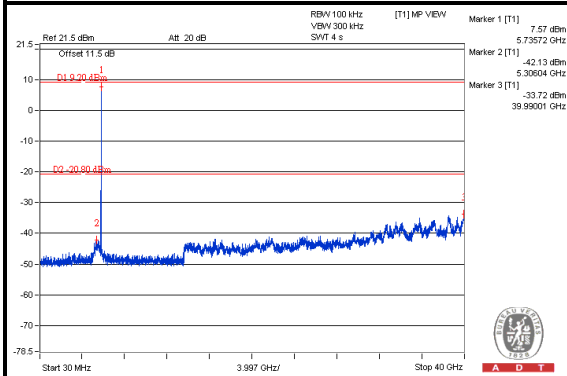

CH 157

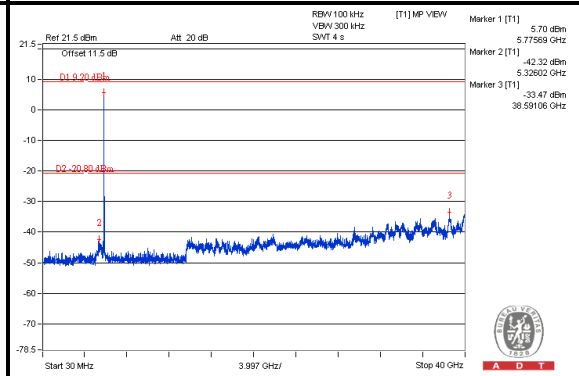

CH 165

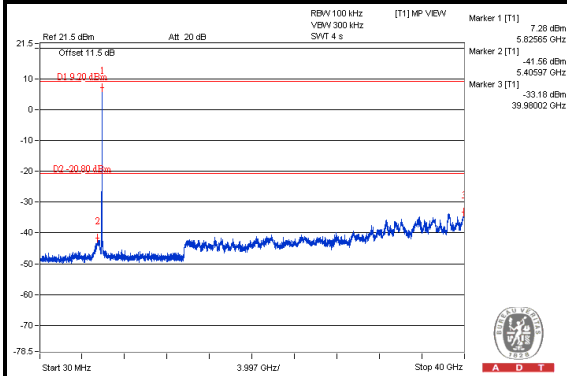

CH 149 Band edge

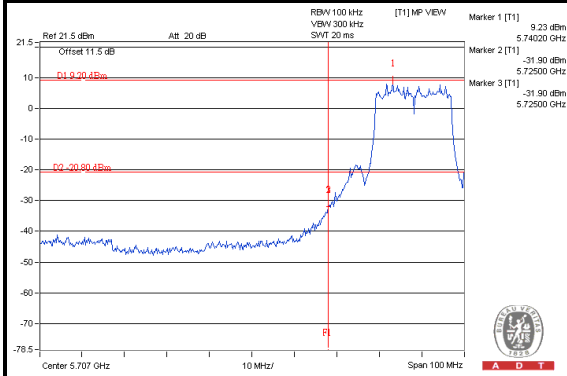

CH 165 Band edge

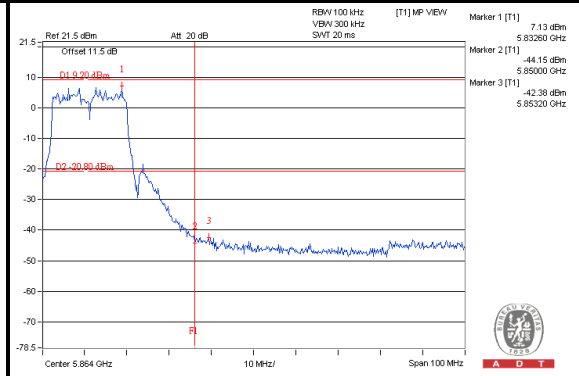



A D T



A D T

Chain 1 CH 149

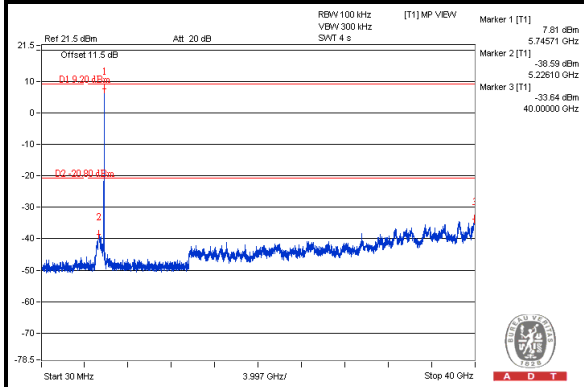

CH 157

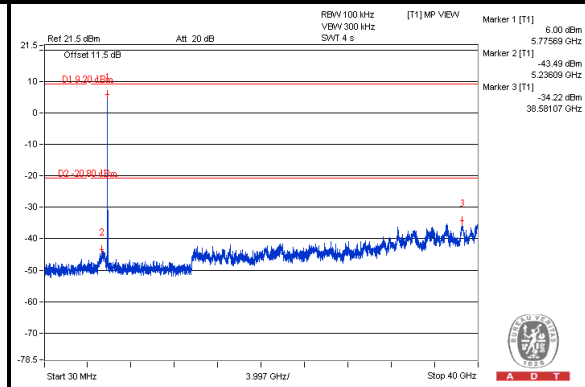

CH 165

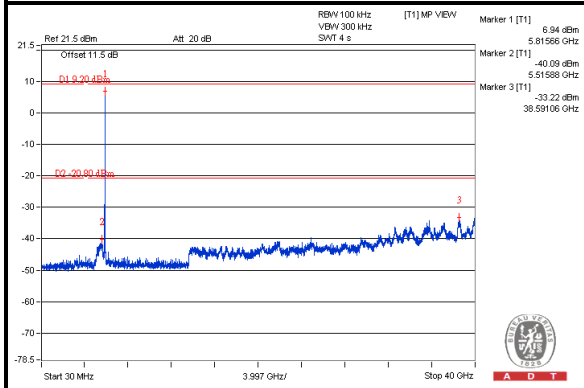

CH 149 Band edge

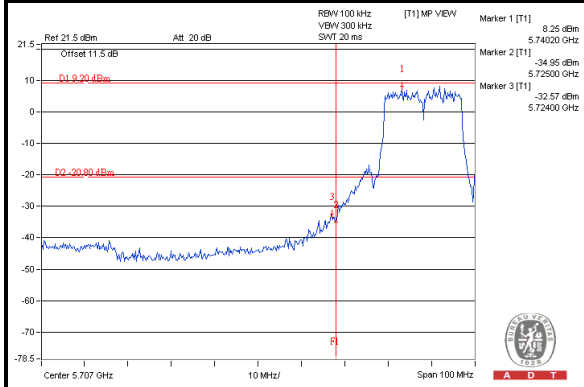

CH 165 Band edge

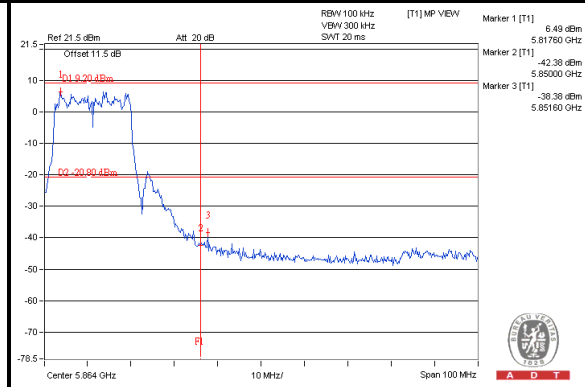



A D T

Chain 2 CH 149

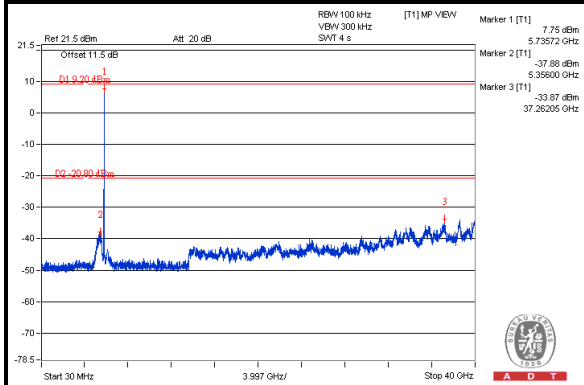

CH 157

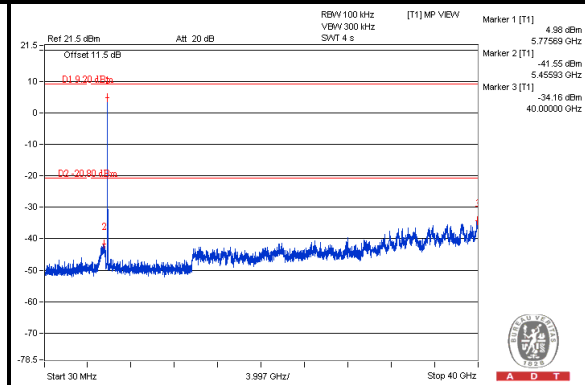

CH 165

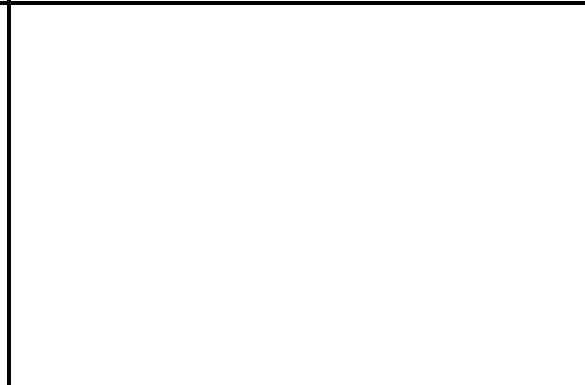
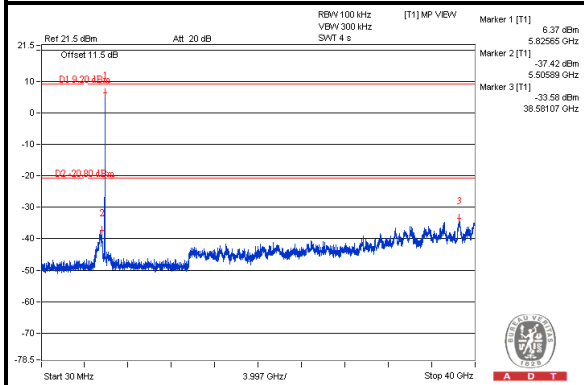

CH 149 Band edge

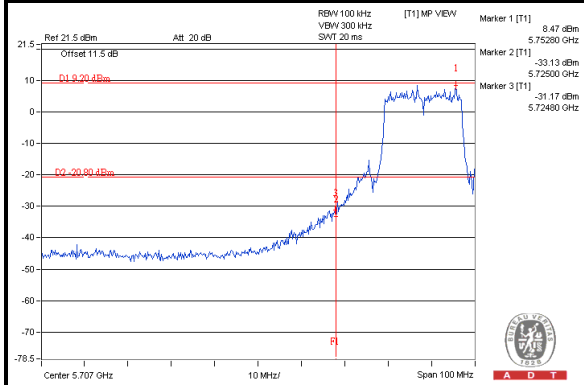

CH 165 Band edge

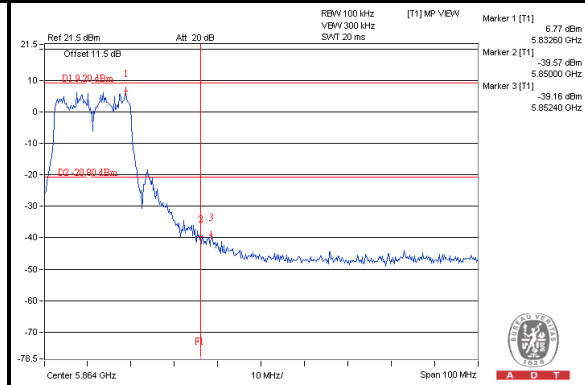



A D T

802.11n(HT40), 3Tx:

Maximum REF

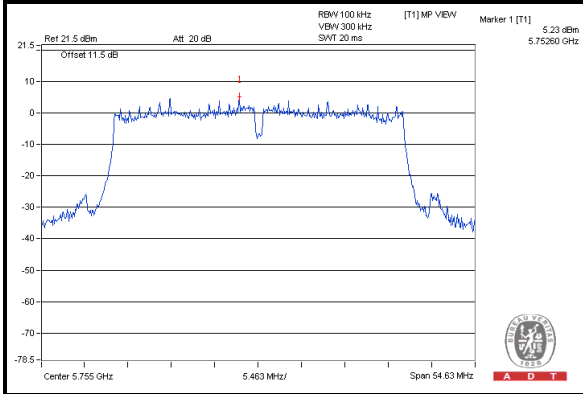

Chain 0

CH 151

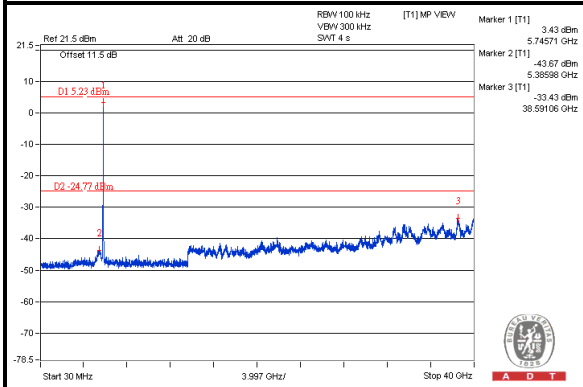

CH 159

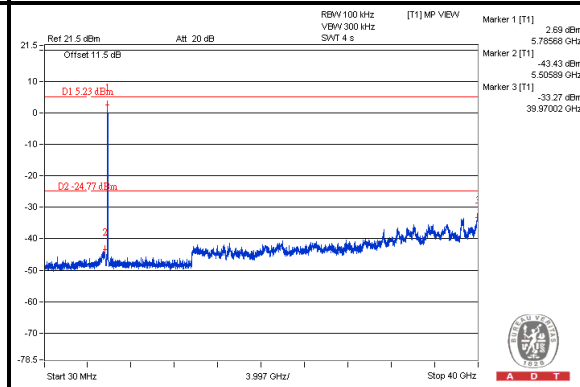

CH 151 Band edge

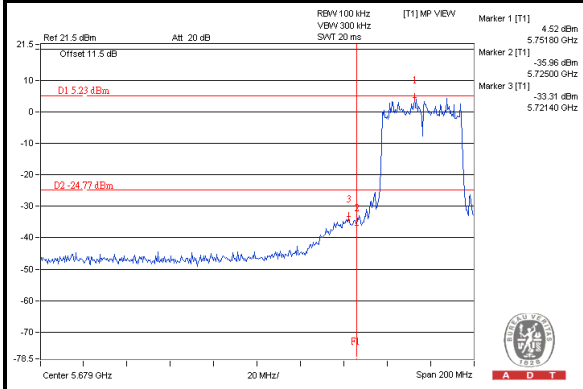

CH 159 Band edge

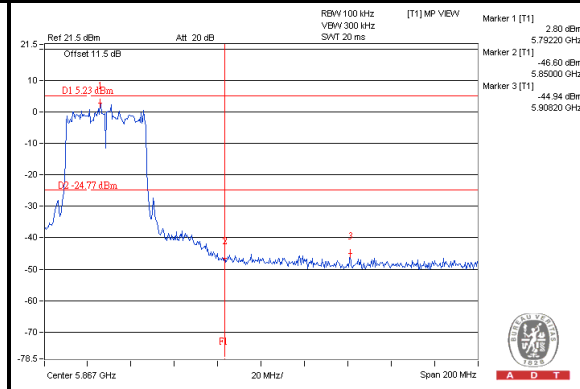



A D T

Chain 1 CH 151

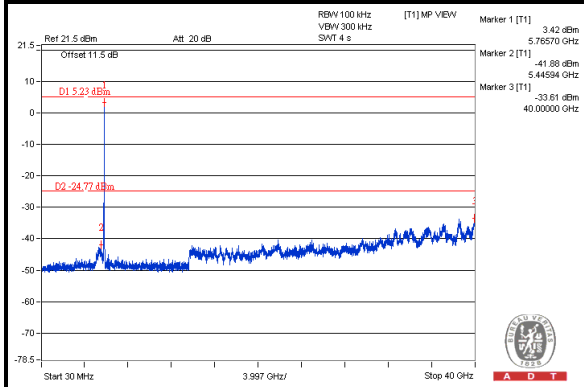

CH 159

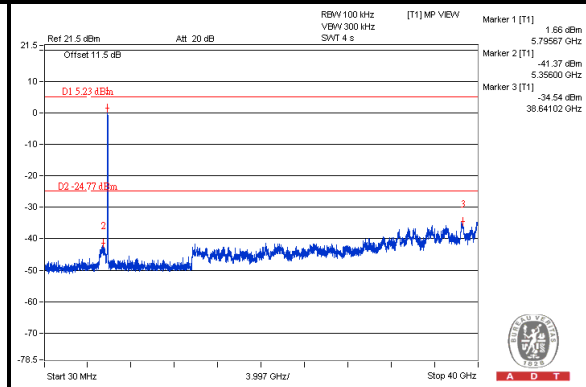

CH 151 Band edge

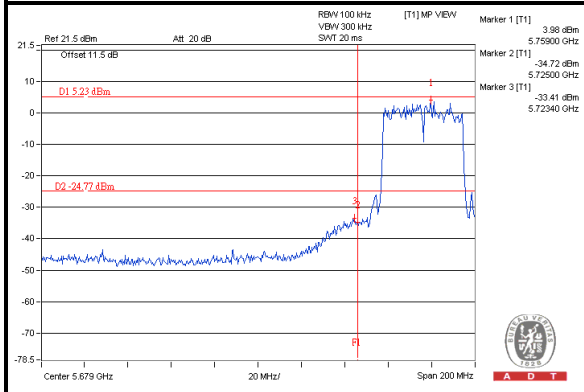

CH 159 Band edge

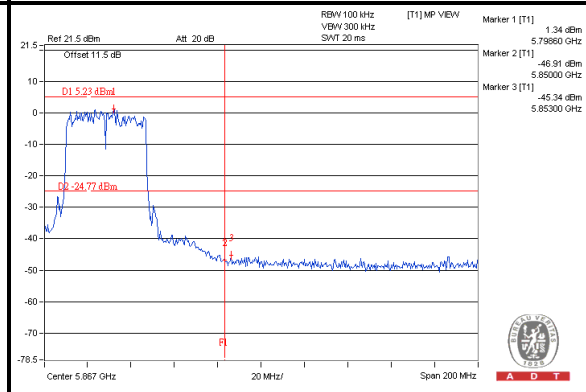



A D T

Chain 2 CH 151

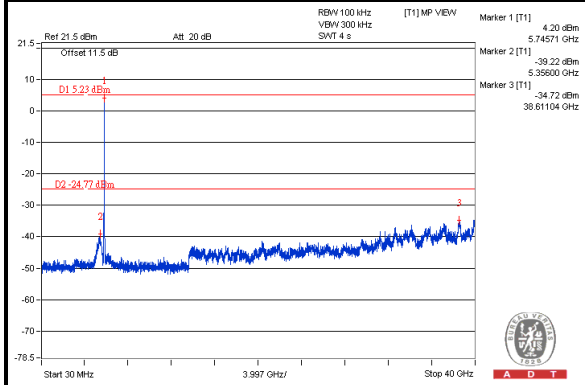

CH 159

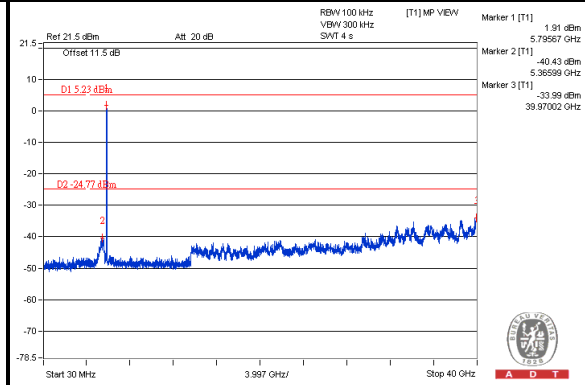

CH 151 Band edge

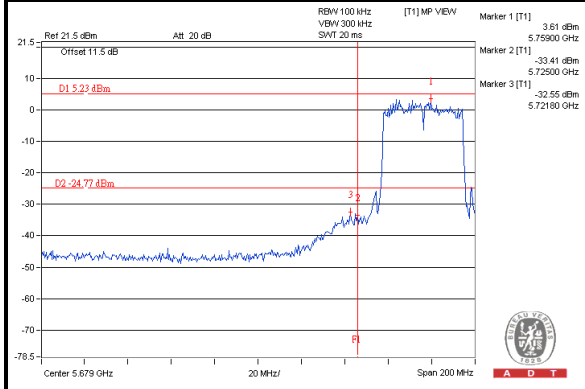

CH 159 Band edge

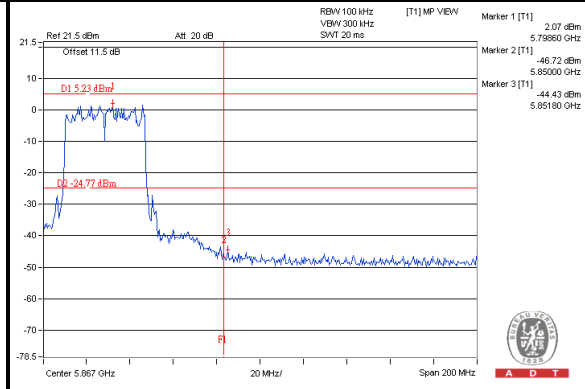



A D T

6. PHOTOGRAPHS OF THE TEST CONFIGURATION

Please refer to the attached file (Test Setup Photo).



7. INFORMATION ON THE TESTING LABORATORIES

We, Bureau Veritas Consumer Products Services (H.K.) Ltd., Taoyuan Branch, were founded in 1988 to provide our best service in EMC, Radio, Telecom and Safety consultation. Our laboratories are accredited and approved according to ISO/IEC 17025.

If you have any comments, please feel free to contact us at the following:

Linko EMC/RF Lab:

Tel: 886-2-26052180

Fax: 886-2-26052943

Hsin Chu EMC/RF Lab:

Tel: 886-3-5935343

Fax: 886-3-5935342

Hwa Ya EMC/RF/Safety/Telecom Lab:

Tel: 886-3-3183232

Fax: 886-3-3270892

Email: service.adt@tw.bureauveritas.com

Web Site: www.bureauveritas-adt.com

The address and road map of all our labs can be found in our web site also.



A D T

8. APPENDIX A - MODIFICATIONS RECORDERS FOR ENGINEERING CHANGES TO THE EUT BY THE LAB

No modifications were made to the EUT by the lab during the test.

--- END ---