

FCC Test Report

Report No.: RF150407E02A-1

Compliance ID : ADBA-SX14015A

Product Name* : ADB-1761W

**For any other product variant refer to above Compliance ID*

FCC ID: MCLADB1761W

Received Date: Feb. 11, 2015

Test Date: Feb. 11 to May 08, 2015

Issued Date: May 28, 2015

Applicant: HON HAI PRECISION IND. CO., LTD.

Address: 5F-1,5 Hsin-An Road Hsinchu, Science-Based Industrial Park Taiwan, R.O.C.

Issued By: Bureau Veritas Consumer Products Services (H.K.) Ltd., Taoyuan Branch Hsin Chu Laboratory

Lab Address: No. 81-1, Lu Liao Keng, 9th Ling,Wu Lung Tsuen, Chiung Lin Hsiang, Hsin Chu Hsien 307, Taiwan R.O.C.

Test Location (1): No. 81-1, Lu Liao Keng, 9th Ling,Wu Lung Tsuen, Chiung Lin Hsiang, Hsin Chu Hsien 307, Taiwan R.O.C.

Test Location (2): No. 49, Ln. 206, Wende Rd., Shangshan Tsuen, Chiung Lin Hsiang, Hsin Chu Hsien 307, Taiwan R.O.C.



This report is for your exclusive use. Any copying or replication of this report to or for any other person or entity, or use of our name or trademark, is permitted only with our prior written permission. This report sets forth our findings solely with respect to the test samples identified herein. The results set forth in this report are not indicative or representative of the quality or characteristics of the lot from which a test sample was taken or any similar or identical product unless specifically and expressly noted. Our report includes all of the tests requested by you and the results thereof based upon the information that you provided to us. You have 60 days from date of issuance of this report to notify us of any material error or omission caused by our negligence, provided, however, that such notice shall be in writing and shall specifically address the issue you wish to raise. A failure to raise such issue within the prescribed time shall constitute your unqualified acceptance of the completeness of this report, the tests conducted and the correctness of the report contents. Unless specific mention, the uncertainty of measurement has been explicitly taken into account to declare the compliance or non-compliance to the specification. The report must not be used by the client to claim product certification, approval, or endorsement by TAF or any government agencies.

Table of Contents

Release Control Record	4
1 Certificate of Conformity	5
2 Summary of Test Results	6
2.1 Measurement Uncertainty.....	6
2.2 Modification Record.....	6
3 General Information	7
3.1 General Description of EUT.....	7
3.2 Description of Test Modes.....	8
3.2.1 Test Mode Applicability and Tested Channel Detail.....	9
3.3 Duty Cycle of Test Signal.....	11
3.4 Description of Support Units.....	12
3.4.1 Configuration of System under Test.....	13
3.5 General Description of Applied Standards.....	15
4 Test Types and Results	16
4.1 Radiated Emission and Bandedge Measurement.....	16
4.1.1 Limits of Radiated Emission and Bandedge Measurement.....	16
4.1.2 Test Instruments.....	17
4.1.3 Test Procedures.....	20
4.1.4 Deviation from Test Standard.....	20
4.1.5 Test Setup.....	21
4.1.6 EUT Operating Conditions.....	21
4.1.7 Test Results.....	22
4.2 Conducted Emission Measurement.....	26
4.2.1 Limits of Conducted Emission Measurement.....	26
4.2.2 Test Instruments.....	26
4.2.3 Test Procedures.....	27
4.2.4 Deviation from Test Standard.....	27
4.2.5 Test Setup.....	27
4.2.6 EUT Operating Conditions.....	27
4.2.7 Test Results.....	28
4.3 6dB Bandwidth Measurement.....	30
4.3.1 Limits of 6dB Bandwidth Measurement.....	30
4.3.2 Test Setup.....	30
4.3.3 Test Instruments.....	30
4.3.4 Test Procedures.....	30
4.3.5 Deviation from Test Standard.....	30
4.3.6 EUT Operating Conditions.....	30
4.3.7 Test Results.....	31
4.4 Conducted Output Power Measurement.....	32
4.4.1 Limits of Conducted Output Power Measurement.....	32
4.4.2 Test Setup.....	32
4.4.3 Test Instruments.....	32
4.4.4 Test Procedures.....	32
4.4.5 Deviation from Test Standard.....	32
4.4.6 EUT Operating Conditions.....	32
4.4.7 Test Results.....	33
4.5 Power Spectral Density Measurement.....	34
4.5.1 Limits of Power Spectral Density Measurement.....	34
4.5.2 Test Setup.....	34
4.5.3 Test Instruments.....	34
4.5.4 Test Procedures.....	34
4.5.5 Deviation from Test Standard.....	34
4.5.6 EUT Operating Conditions.....	34



4.5.7 Test Results	35
4.6 Conducted Out of Band Emission Measurement.....	36
4.6.1 Limits of Conducted Out of Band Emission Measurement	36
4.6.2 Test Setup.....	36
4.6.3 Test Instruments	36
4.6.4 Test Procedures.....	36
4.6.5 Deviation from Test Standard	36
4.6.6 EUT Operating Conditions.....	36
4.6.7 Test Results	36
5 Pictures of Test Arrangements.....	38
Appendix – Information on the Testing Laboratories	39



A D T

Release Control Record

Issue No.	Description	Date Issued
RF150407E02A-1	Original release.	May 28, 2015



A D T

1 Certificate of Conformity

Compliance ID: ADDBA-SX14015A

Product Name*: ADB-1761W

Product Description: IP Set-Top Box

**For any other product variant refer to above Compliance ID*

Brand: ADB

Sample Status: ENGINEERING SAMPLE

Applicant: HON HAI PRECISION IND. CO., LTD.

Test Date: Feb. 11 to May 08, 2015

Standards: 47 CFR FCC Part 15, Subpart C (Section 15.247)
ANSI C63.10:2009

The above equipment has been tested by **Bureau Veritas Consumer Products Services (H.K.) Ltd., Taoyuan Branch**, and found compliance with the requirement of the above standards. The test record, data evaluation & Equipment Under Test (EUT) configurations represented herein are true and accurate accounts of the measurements of the sample's EMC characteristics under the conditions specified in this report.

Prepared by : _____, **Date:** _____
Elsie Hsu / Specialist

Approved by : _____, **Date:** _____
May Chen / Manager

2 Summary of Test Results

47 CFR FCC Part 15, Subpart C (SECTION 15.247)			
FCC Clause	Test Item	Result	Remarks
15.207	AC Power Conducted Emission	PASS	Meet the requirement of limit. Minimum passing margin is -15.57dB at 11.17188MHz.
15.205 / 15.209 / 15.247(d)	Radiated Emissions and Band Edge Measurement	PASS	Meet the requirement of limit. Minimum passing margin is -0.4dB at 2483.50MHz.
15.247(d)	Antenna Port Emission	PASS	Meet the requirement of limit.
15.247(a)(2)	6dB bandwidth	PASS	Meet the requirement of limit.
15.247(b)	Conducted power	PASS	Meet the requirement of limit.
15.247(e)	Power Spectral Density	PASS	Meet the requirement of limit.
15.203	Antenna Requirement	PASS	No antenna connector is used.

2.1 Measurement Uncertainty

Where relevant, the following measurement uncertainty levels have been estimated for tests performed on the EUT as specified in CISPR 16-4-2:

Measurement	Frequency	Expanded Uncertainty (k=2) (\pm)
Conducted Emissions at mains ports	150kHz ~ 30MHz	2.86 dB
Radiated Emissions up to 1 GHz	30MHz ~ 1GHz	5.43 dB
Radiated Emissions above 1 GHz	1GHz ~ 6GHz	3.65 dB
	6GHz ~ 18GHz	3.88 dB
	18GHz ~ 40GHz	4.11 dB

2.2 Modification Record

There were no modifications required for compliance.

3 General Information

3.1 General Description of EUT

Compliance ID:	ADBA-SX14015A
Product Name*:	ADB-1761WF
Product Description:	IP Set-Top Box
<i>*For any other product variant refer to above Compliance ID</i>	
Brand	ADB
Status of EUT	ENGINEERING SAMPLE
Power Supply Rating	DC 12V from power adapter
Modulation Type	O-QPSK
Modulation Technology	DSSS
Transfer Rate	250kbps
Operating Frequency	2405 ~ 2480MHz
Number of Channel	16
Output Power	1.959mW
Antenna Type	Please see NOTE
Antenna Connector	Please see NOTE
Accessory Device	Adapter x 1
Data Cable Supplied	Ethernet cable x 1 (Unshielded, 1.5m) RCA cable x 1 (Unshielded, 1.5m)

Note:

1. The EUT must be supplied with power adapter as following table:

Brand	Model No.	Spec.
DVE	DSA-30PFB-12 FUS 120250	Input: 100-240V, 0.8A, 50/60Hz Output: 12V, 2.5A DC output cable(Unshielded, 1.5m)

2. The antennas provided to the EUT, please refer to the following table:

Antenna No.	Transmitter Circuit	Brand	Model	Ant. Gain(dBi) <Including cable loss>	Frequency range (GHz to GHz)	Antenna Type	Connector Type
1	Chain (0)	INPAQ	NA	2.78	2.4~2.5	PIFA	NA
2	Chain (1)		NA	2.45	2.4~2.5		

3. The above EUT information is declared by manufacturer and for more detailed features description, please refer to the manufacturer's specifications or user's manual.

3.2 Description of Test Modes

16 channels are provided to the EUT:

Channel	Frequency	Channel	Frequency
11	2405	19	2445
12	2410	20	2450
13	2415	21	2455
14	2420	22	2460
15	2425	23	2465
16	2430	24	2470
17	2435	25	2475
18	2440	26	2480

3.2.1 Test Mode Applicability and Tested Channel Detail

EUT CONFIGURE MODE	APPLICABLE TO				DESCRIPTION
	RE \geq 1G	RE<1G	PLC	APCM	
-	√	√	√	√	-

Where **RE \geq 1G**: Radiated Emission above 1GHz & Bandedge Measurement
RE<1G: Radiated Emission below 1GHz
PLC: Power Line Conducted Emission
APCM: Antenna Port Conducted Measurement

Radiated Emission Test (Above 1GHz):

- Pre-Scan has been conducted to determine the worst-case mode from all possible combinations between available modulations, data rates and antenna ports (if EUT with antenna diversity architecture).
- Following channel(s) was (were) selected for the final test as listed below.

AVAILABLE CHANNEL	TESTED CHANNEL	MODULATION TECHNOLOGY	MODULATION TYPE	DATA RATE (kbps)
11 to 26	11, 18, 26	DSSS	O-QPSK	250

Radiated Emission Test (Below 1GHz):

- Pre-Scan has been conducted to determine the worst-case mode from all possible combinations between available modulations, data rates and antenna ports (if EUT with antenna diversity architecture).
- Following channel(s) was (were) selected for the final test as listed below.

AVAILABLE CHANNEL	TESTED CHANNEL	MODULATION TECHNOLOGY	MODULATION TYPE	DATA RATE (kbps)
11 to 26	11	OFDM	O-QPSK	250

Power Line Conducted Emission Test:

- Pre-Scan has been conducted to determine the worst-case mode from all possible combinations between available modulations, data rates and antenna ports (if EUT with antenna diversity architecture).
- Following channel(s) was (were) selected for the final test as listed below.

AVAILABLE CHANNEL	TESTED CHANNEL	MODULATION TECHNOLOGY	MODULATION TYPE	DATA RATE (kbps)
11 to 26	11	OFDM	O-QPSK	250

Antenna Port Conducted Measurement:

- This item includes all test value of each mode, but only includes spectrum plot of worst value of each mode.
- Pre-Scan has been conducted to determine the worst-case mode from all possible combinations between available modulations, data rates and antenna ports (if EUT with antenna diversity architecture).
- Following channel(s) was (were) selected for the final test as listed below.

AVAILABLE CHANNEL	TESTED CHANNEL	MODULATION TECHNOLOGY	MODULATION TYPE	DATA RATE (kbps)
11 to 26	11, 18, 26	DSSS	O-QPSK	250

Test Condition:

APPLICABLE TO	ENVIRONMENTAL CONDITIONS	INPUT POWER	TESTED BY
RE\geq1G	26deg. C, 73%RH	120Vac, 60Hz	Gary Cheng
RE$<$1G	24deg. C, 73%RH	120Vac, 60Hz	Gary Cheng
PLC	23deg. C, 70%RH	120Vac, 60Hz	Barry Lee
APCM	25deg. C, 60%RH	120Vac, 60Hz	Robert Cheng

3.3 Duty Cycle of Test Signal

Duty cycle of test signal is < 98 %, duty factor shall be considered.

Duty cycle = $0.741 \text{ ms} / 3.281 \text{ ms} = 0.226$, Duty factor = $10 * \log(1/0.226) = 6.5$

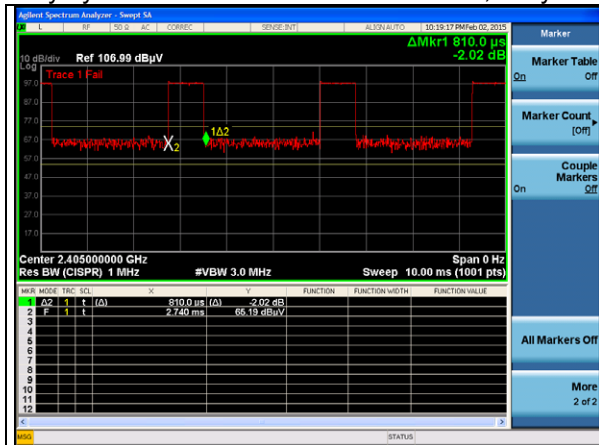

3.4 Description of Support Units

The EUT has been tested as an independent unit together with other necessary accessories or support units. The following support units or accessories were used to form a representative test configuration during the tests.

No.	Product	Brand	Model No.	Serial No.	FCC ID	Remark
A	SONY LCD TV	SONY	KDL-32CX520	3676813	FCC DoC	Provided by Lab
B	USB 3.0 Dongle	Transcend	16GB	NA	NA	Provided by Lab
C	NOTEBOOK COMPUTER	DELL	PP32LA	DSL32S	FCC DoC	Provided by Lab
D	SD Card	Panasonic	128MB	NA	NA	Provided by Lab
E	Audio converter	LINDY	1658-BC	NA	NA	Provided by Lab
F	Speaker	Lenovo	41A5330	NA	NA	Provided by Lab
G	Remote Controller	ADB	NA	NA	NA	Supplied by Client
H	H.D.D	ADB	ADB-HDD-1TB	NA	NA	Supplied by Client
I	2.5 H.D.D	WD	WDBACW0010HBK-SESN	WCAZAL625787	FCC DoC	Provided by Lab

NOTE:

1. All power cords of the above support units are non-shielded (1.8 m).

No.	Cable	Qty.	Length (m)	Shielded (Yes/ No)	Cores (Number)	Remark
1	Coaxial	1	1.5	Yes	0	Provided by Lab
2	A/V	1	1.3	Yes	0	Provided by Lab
3	HDMI (Brand: Baoyuanda, Model: B123W600A-150)	1	1.5	Yes	0	Supplied by Client
4	Fiber	1	1.5	No	0	Provided by Lab
5	(L/R) to 3.5 Audio	1	1.8	Yes	0	Provided by Lab
6	RJ-45	1	10	No	0	Provided by Lab
7	DC	1	1.5	No	0	Supplied by Client
8	USB	1	1	Yes	0	Provided by Lab

3.4.1 Configuration of System under Test

For other tests

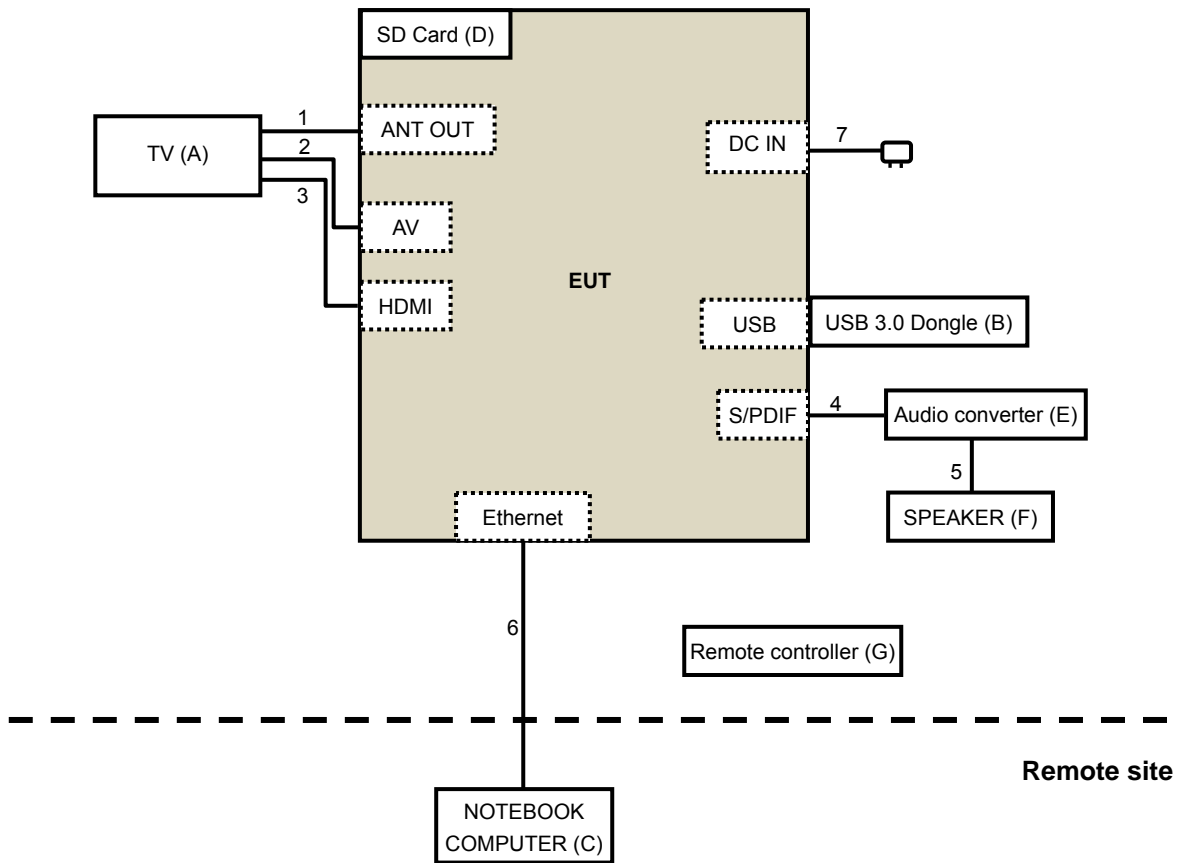

For conducted test

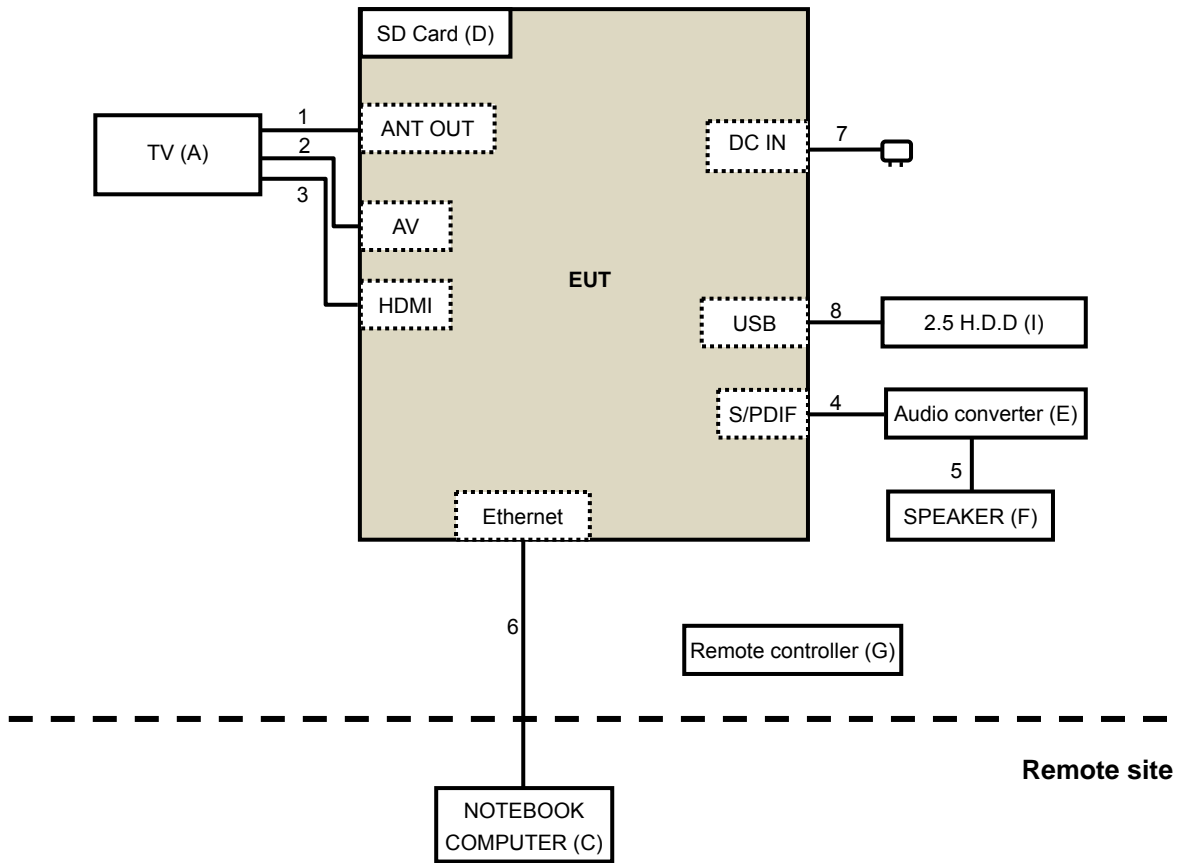

3.5 General Description of Applied Standards

The EUT is a RF Product. According to the specifications of the manufacturer, it must comply with the requirements of the following standards:

FCC Part 15, Subpart C (15.247)

558074 D01 DTS Meas Guidance v03r02

ANSI C63.10-2009

All test items have been performed and recorded as per the above standards.

NOTE: The EUT has been verified to comply with the requirements of FCC Part 15, Subpart B, Class B (DoC). The test report has been issued separately.

4 Test Types and Results

4.1 Radiated Emission and Bandedge Measurement

4.1.1 Limits of Radiated Emission and Bandedge Measurement

Radiated emissions which fall in the restricted bands must comply with the radiated emission limits specified as below table. Other emissions shall be at least 20dB below the highest level of the desired power:

Frequencies (MHz)	Field Strength (microvolts/meter)	Measurement Distance (meters)
0.009 ~ 0.490	2400/F(kHz)	300
0.490 ~ 1.705	24000/F(kHz)	30
1.705 ~ 30.0	30	30
30 ~ 88	100	3
88 ~ 216	150	3
216 ~ 960	200	3
Above 960	500	3

NOTE:

1. The lower limit shall apply at the transition frequencies.
2. Emission level (dBuV/m) = 20 log Emission level (uV/m).
3. For frequencies above 1000MHz, the field strength limits are based on average detector, however, the peak field strength of any emission shall not exceed the maximum permitted average limits, specified above by more than 20dB under any condition of modulation.

4.1.2 Test Instruments

For Below 1GHz test:

DESCRIPTION & MANUFACTURER	MODEL NO.	SERIAL NO.	CALIBRATED DATE	CALIBRATED UNTIL
MXE EMI Receiver Agilent	N9038A	MY50010156	Aug. 11, 2014	Aug. 10, 2015
Pre-Amplifier Mini-Circuits	ZFL-1000VH2 B	AMP-ZFL-04	Nov. 12, 2014	Nov. 11, 2015
Trilog Broadband Antenna SCHWARZBECK	VULB 9168	9168-361	Feb. 27, 2014	Feb. 26, 2015
RF Cable	NA	CHHCAB_001	Oct. 05, 2014	Oct. 04, 2015
Horn_Antenna AISI	AIH.8018	0000220091110	Aug. 26, 2014	Aug. 25, 2015
Pre-Amplifier Agilent	8449B	300801923	Oct. 28, 2014	Oct. 27, 2015
RF Cable	NA	131206 131215 SNMY23685/4	Jan. 16, 2015	Jan. 15, 2016
Spectrum Analyzer R&S	FSV40	100964	July 05, 2014	July 04, 2015
Pre-Amplifier EMCI	EMC184045	980143	Jan. 16, 2015	Jan. 15, 2016
Horn_Antenna SCHWARZBECK	BBHA 9170	9170-424	Aug. 26, 2014	Aug. 25, 2015
RF Cable	NA	RF104-121 RF104-204	Dec. 11, 2014	Dec. 10, 2015
Software	ADT_Radiated _V8.7.07	NA	NA	NA
Antenna Tower & Turn Table CT	NA	NA	NA	NA

Note:

1. The calibration interval of the above test instruments is 12 months and the calibrations are traceable to NML/ROC and NIST/USA.
2. The horn antenna, preamplifier (model: 8449B) are used only for the measurement of emission frequency above 1GHz if tested.
3. The test was performed in 966 Chamber No. H.
4. The FCC Site Registration No. is 797305.
5. The CANADA Site Registration No. is IC 7450H-3.
6. Tested Date: Feb. 11, 2015

For Above 1GHz test:

DESCRIPTION & MANUFACTURER	MODEL NO.	SERIAL NO.	CALIBRATED DATE	CALIBRATED UNTIL
MXE EMI Receiver Agilent	N9038A	MY51210105	July 21, 2014	July 20, 2015
Pre-Amplifier Mini-Circuits	ZFL-1000VH2 B	AMP-ZFL-03	Nov. 12, 2014	Nov. 11, 2015
Trilog Broadband Antenna SCHWARZBECK	VULB 9168	9168-360	Feb. 06, 2015	Feb. 05, 2016
RF Cable	NA	CHGCAB_001	Oct. 04, 2014	Oct. 03, 2015
Horn_Antenna AISI	AIH.8018	0000320091110	Aug. 27, 2014	Aug. 26, 2015
Pre-Amplifier Agilent	8449B	3008A02578	June 24, 2014	June 23, 2015
RF Cable	NA	131205 131214 SNMY23684/4	Jan. 16, 2015	Jan. 15, 2016
Spectrum Analyzer R&S	FSV40	100964	July 05, 2014	July 04, 2015
Pre-Amplifier EMCI	EMC184045	980143	Jan. 16, 2015	Jan. 15, 2016
Horn_Antenna SCHWARZBECK	BBHA 9170	9170-424	Aug. 26, 2014	Aug. 25, 2015
RF Cable	NA	RF104-121 RF104-204	Dec. 11, 2014	Dec. 10, 2015
Antenna Tower & Turn Table CT	NA	NA	NA	NA
Spectrum Analyzer R&S	FSP 40	100060	May 08, 2014	May 07, 2015
Power meter Anritsu	ML2495A	0824006	May 22, 2014	May 21, 2015
Power sensor Anritsu	MA2411B	0738172	May 22, 2014	May 21, 2015

Note:

1. The calibration interval of the above test instruments is 12 months and the calibrations are traceable to NML/ROC and NIST/USA.
2. The horn antenna, preamplifier (model: 8449B) are used only for the measurement of emission frequency above 1GHz if tested.
3. The test was performed in 966 Chamber No. G.
4. The FCC Site Registration No. is 966073.
5. The VCCI Site Registration No. is G-137.
6. The CANADA Site Registration No. is IC 7450H-2.
7. Tested Date: Apr. 16, 2015

For Above 1GHz test:

DESCRIPTION & MANUFACTURER	MODEL NO.	SERIAL NO.	CALIBRATED DATE	CALIBRATED UNTIL
MXE EMI Receiver Agilent	N9038A	MY51210105	July 21, 2014	July 20, 2015
Pre-Amplifier Mini-Circuits	ZFL-1000VH2 B	AMP-ZFL-03	Nov. 12, 2014	Nov. 11, 2015
Trilog Broadband Antenna SCHWARZBECK	VULB 9168	9168-360	Feb. 06, 2015	Feb. 05, 2016
RF Cable	NA	CHGCAB_001	Oct. 04, 2014	Oct. 03, 2015
Horn_Antenna AISI	AIH.8018	0000320091110	Aug. 27, 2014	Aug. 26, 2015
Pre-Amplifier Agilent	8449B	3008A02578	June 24, 2014	June 23, 2015
RF Cable	NA	131205 131214 SNMY23684/4	Jan. 16, 2015	Jan. 15, 2016
Spectrum Analyzer R&S	FSV40	100964	July 05, 2014	July 04, 2015
Pre-Amplifier EMCI	EMC184045	980143	Jan. 16, 2015	Jan. 15, 2016
Horn_Antenna SCHWARZBECK	BBHA 9170	9170-424	Aug. 26, 2014	Aug. 25, 2015
RF Cable	NA	RF104-121 RF104-204	Dec. 11, 2014	Dec. 10, 2015
Antenna Tower & Turn Table CT	NA	NA	NA	NA
Spectrum Analyzer R&S	FSP 40	100060	May 08, 2015	May 07, 2016
Power meter Anritsu	ML2495A	0824006	May 22, 2014	May 21, 2015
Power sensor Anritsu	MA2411B	0738172	May 22, 2014	May 21, 2015

Note:

1. The calibration interval of the above test instruments is 12 months and the calibrations are traceable to NML/ROC and NIST/USA.
2. The horn antenna, preamplifier (model: 8449B) are used only for the measurement of emission frequency above 1GHz if tested.
- 3 The test was performed in 966 Chamber No. G.
4. The FCC Site Registration No. is 966073.
- 5 The VCCI Site Registration No. is G-137.
- 6 The CANADA Site Registration No. is IC 7450H-2.
- 7 Tested Date: May 08, 2015

4.1.3 Test Procedures

- a. The EUT was placed on the top of a rotating table 0.8 meters above the ground at 3 meter chamber room for test. The table was rotated 360 degrees to determine the position of the highest radiation.
- b. The EUT was set 3 meters away from the interference-receiving antenna, which was mounted on the top of a variable-height antenna tower.
- c. The height of antenna is varied from one meter to four meters above the ground to determine the maximum value of the field strength. Both horizontal and vertical polarizations of the antenna are set to make the measurement.
- d. For each suspected emission, the EUT was arranged to its worst case and then the antenna was tuned to heights from 1 meter to 4 meters and the rotatable table was turned from 0 degrees to 360 degrees to find the maximum reading.
- e. The test-receiver system was set to quasi-peak detect function and specified bandwidth with maximum hold mode when the test frequency is below 1 GHz.
- f. The test-receiver system was set to peak and average detect function and specified bandwidth with maximum hold mode when the test frequency is above 1 GHz. If the peak reading value also meets average limit, measurement with the average detector is unnecessary.

Note:

1. The resolution bandwidth and video bandwidth of test receiver/spectrum analyzer is 120kHz for Quasi-peak detection (QP) at frequency below 1GHz.
2. The resolution bandwidth of test receiver/spectrum analyzer is 1 MHz and the video bandwidth is 3 MHz for Peak detection (PK) at frequency above 1GHz.
3. The resolution bandwidth of test receiver/spectrum analyzer is 1MHz and the video bandwidth is $\geq 1/T$ (Duty cycle $< 98\%$) or 10Hz (Duty cycle $\geq 98\%$) for Average detection (AV) at frequency above 1GHz.
4. All modes of operation were investigated and the worst-case emissions are reported.

4.1.4 Deviation from Test Standard

No deviation.

4.1.5 Test Setup

<Frequency Range below 1GHz>

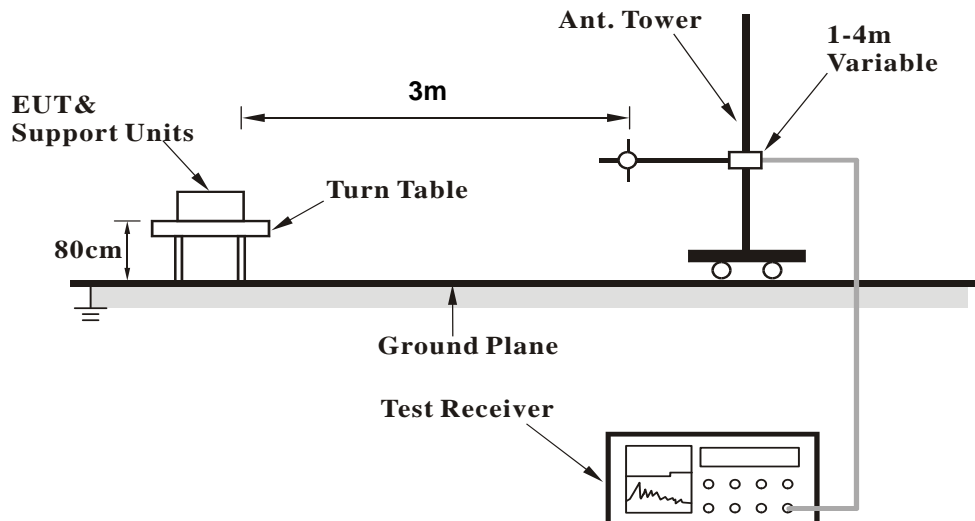

<Frequency Range above 1GHz>

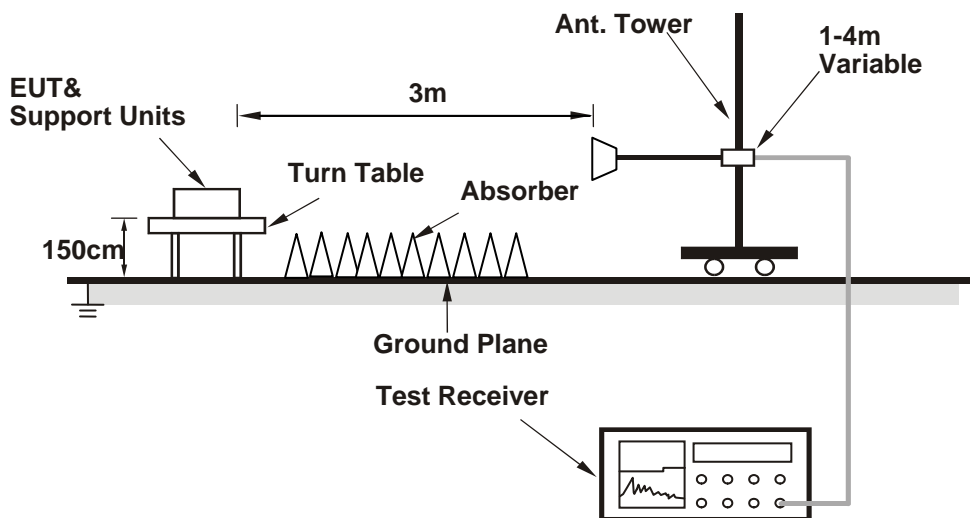

For the actual test configuration, please refer to the attached file (Test Setup Photo).

4.1.6 EUT Operating Conditions

1. Connect the EUT with the support unit C (NOTEBOOK COMPUTER) which is placed on remote site.
2. Controlling software (telnet with command) has been activated to set the EUT on specific status.

4.1.7 Test Results

Above 1GHz Data

CHANNEL	TX Channel 11	DETECTOR FUNCTION	Peak (PK)
FREQUENCY RANGE	1GHz ~ 25GHz		Average (AV)

ANTENNA POLARITY & TEST DISTANCE: HORIZONTAL AT 3 M								
NO.	FREQ. (MHz)	EMISSION LEVEL (dBuV/m)	LIMIT (dBuV/m)	MARGIN (dB)	ANTENNA HEIGHT (m)	TABLE ANGLE (Degree)	RAW VALUE (dBuV)	CORRECTION FACTOR (dB/m)
1	2390.00	49.4 PK	74.0	-24.6	1.85 H	260	82.67	-33.27
2	2390.00	38.8 AV	54.0	-15.2	1.85 H	260	72.07	-33.27
3	*2405.00	98.0 PK			1.29 H	334	131.26	-33.26
4	*2405.00	93.9 AV			1.29 H	334	127.16	-33.26
5	4810.00	49.0 PK	74.0	-25.0	1.64 H	328	79.79	-30.79
6	4810.00	38.4 AV	54.0	-15.6	1.64 H	328	69.19	-30.79

ANTENNA POLARITY & TEST DISTANCE: VERTICAL AT 3 M								
NO.	FREQ. (MHz)	EMISSION LEVEL (dBuV/m)	LIMIT (dBuV/m)	MARGIN (dB)	ANTENNA HEIGHT (m)	TABLE ANGLE (Degree)	RAW VALUE (dBuV)	CORRECTION FACTOR (dB/m)
1	2390.00	49.3 PK	74.0	-24.7	1.14 V	336	54.88	-5.58
2	2390.00	37.6 AV	54.0	-16.4	1.14 V	336	43.18	-5.58
3	*2405.00	94.7 PK			1.06 V	347	100.23	-5.53
4	*2405.00	90.1 AV			1.06 V	347	95.63	-5.53
5	4810.00	56.1 PK	74.0	-17.9	1.58 V	267	53.78	2.32
6	4810.00	49.0 AV	54.0	-5.0	1.58 V	267	46.68	2.32

REMARKS:

1. Emission Level(dBuV/m) = Raw Value(dBuV) + Correction Factor(dB/m)
2. Correction Factor(dB/m) = Antenna Factor(dB/m) + Cable Factor(dB) – Pre-Amplifier Factor(dB)
3. The other emission levels were very low against the limit.
4. Margin value = Emission Level – Limit value
5. " * ": Fundamental frequency.

CHANNEL	TX Channel 18	DETECTOR FUNCTION	Peak (PK)
FREQUENCY RANGE	1GHz ~ 25GHz		Average (AV)

ANTENNA POLARITY & TEST DISTANCE: HORIZONTAL AT 3 M

NO.	FREQ. (MHz)	EMISSION LEVEL (dBuV/m)	LIMIT (dBuV/m)	MARGIN (dB)	ANTENNA HEIGHT (m)	TABLE ANGLE (Degree)	RAW VALUE (dBuV)	CORRECTION FACTOR (dB/m)
1	2390.00	49.8 PK	74.0	-24.2	1.31 H	262	83.07	-33.27
2	2390.00	37.7 AV	54.0	-16.3	1.31 H	262	70.97	-33.27
3	*2440.00	98.3 PK			1.30 H	342	131.45	-33.15
4	*2440.00	94.3 AV			1.30 H	342	127.45	-33.15
5	2483.50	49.8 PK	74.0	-24.2	1.31 H	262	82.80	-33.00
6	2483.50	37.4 AV	54.0	-16.6	1.31 H	262	70.40	-33.00
7	4880.00	48.3 PK	74.0	-25.7	1.65 H	310	79.06	-30.76
8	4880.00	37.6 AV	54.0	-16.4	1.65 H	310	68.36	-30.76
9	7320.00	54.6 PK	74.0	-19.4	1.05 H	105	84.20	-29.60
10	7320.00	43.1 AV	54.0	-10.9	1.05 H	105	72.70	-29.60

ANTENNA POLARITY & TEST DISTANCE: VERTICAL AT 3 M

NO.	FREQ. (MHz)	EMISSION LEVEL (dBuV/m)	LIMIT (dBuV/m)	MARGIN (dB)	ANTENNA HEIGHT (m)	TABLE ANGLE (Degree)	RAW VALUE (dBuV)	CORRECTION FACTOR (dB/m)
1	2390.00	48.4 PK	74.0	-25.6	1.08 V	333	53.98	-5.58
2	2390.00	36.2 AV	54.0	-17.8	1.08 V	333	41.78	-5.58
3	*2440.00	95.3 PK			1.08 V	333	100.62	-5.32
4	*2440.00	90.5 AV			1.08 V	333	95.82	-5.32
5	2483.50	48.3 PK	74.0	-25.7	1.08 V	333	53.35	-5.05
6	2483.50	36.0 AV	54.0	-18.0	1.08 V	333	41.05	-5.05
7	4880.00	56.2 PK	74.0	-17.8	1.60 V	268	53.67	2.53
8	4880.00	49.3 AV	54.0	-4.7	1.60 V	268	46.77	2.53
9	7320.00	54.9 PK	74.0	-19.1	1.00 V	217	45.19	9.71
10	7320.00	43.4 AV	54.0	-10.6	1.00 V	217	33.69	9.71

REMARKS:

1. Emission Level(dBuV/m) = Raw Value(dBuV) + Correction Factor(dB/m)
2. Correction Factor(dB/m) = Antenna Factor(dB/m) + Cable Factor(dB) – Pre-Amplifier Factor(dB)
3. The other emission levels were very low against the limit.
4. Margin value = Emission Level – Limit value
5. " * ": Fundamental frequency.

CHANNEL	TX Channel 26	DETECTOR FUNCTION	Peak (PK)
FREQUENCY RANGE	1GHz ~ 25GHz		Average (AV)

ANTENNA POLARITY & TEST DISTANCE: HORIZONTAL AT 3 M								
NO.	FREQ. (MHz)	EMISSION LEVEL (dBuV/m)	LIMIT (dBuV/m)	MARGIN (dB)	ANTENNA HEIGHT (m)	TABLE ANGLE (Degree)	RAW VALUE (dBuV)	CORRECTION FACTOR (dB/m)
1	*2480.00	97.4 PK			1.29 H	268	130.42	-33.02
2	*2480.00	93.4 AV			1.29 H	268	126.42	-33.02
3	2483.50	64.1 PK	74.0	-9.9	1.29 H	268	97.10	-33.00
4	2483.50	53.6 AV	54.0	-0.4	1.29 H	268	86.60	-33.00
5	4960.00	48.7 PK	74.0	-25.3	1.62 H	317	79.34	-30.64
6	4960.00	38.0 AV	54.0	-16.0	1.62 H	317	68.64	-30.64
7	7440.00	55.3 PK	74.0	-18.7	1.00 H	108	84.78	-29.48
8	7440.00	43.8 AV	54.0	-10.2	1.00 H	108	73.28	-29.48

ANTENNA POLARITY & TEST DISTANCE: VERTICAL AT 3 M								
NO.	FREQ. (MHz)	EMISSION LEVEL (dBuV/m)	LIMIT (dBuV/m)	MARGIN (dB)	ANTENNA HEIGHT (m)	TABLE ANGLE (Degree)	RAW VALUE (dBuV)	CORRECTION FACTOR (dB/m)
1	*2480.00	94.8 PK			1.03 V	352	99.88	-5.08
2	*2480.00	90.2 AV			1.03 V	352	95.28	-5.08
3	2483.50	62.4 PK	74.0	-11.6	1.03 V	352	67.45	-5.05
4	2483.50	50.1 AV	54.0	-3.9	1.03 V	352	55.15	-5.05
5	4960.00	56.0 PK	74.0	-18.0	2.79 V	331	53.14	2.86
6	4960.00	47.0 AV	54.0	-7.0	2.79 V	331	44.14	2.86
7	7440.00	55.4 PK	74.0	-18.6	1.03 V	352	45.64	9.76
8	7440.00	43.8 AV	54.0	-10.2	1.03 V	352	34.04	9.76

REMARKS:

1. Emission Level(dBuV/m) = Raw Value(dBuV) + Correction Factor(dB/m)
2. Correction Factor(dB/m) = Antenna Factor(dB/m) + Cable Factor(dB) – Pre-Amplifier Factor(dB)
3. The other emission levels were very low against the limit.
4. Margin value = Emission Level – Limit value
5. " * ": Fundamental frequency.

Below 1GHz Data

CHANNEL	TX Channel 11	DETECTOR FUNCTION	Quasi-Peak (QP)
FREQUENCY RANGE	30MHz ~ 1GHz		

ANTENNA POLARITY & TEST DISTANCE: HORIZONTAL AT 3 M

NO.	FREQ. (MHz)	EMISSION LEVEL (dBuV/m)	LIMIT (dBuV/m)	MARGIN (dB)	ANTENNA HEIGHT (m)	TABLE ANGLE (Degree)	RAW VALUE (dBuV)	CORRECTION FACTOR (dB/m)
1	149.90	34.6 QP	43.5	-8.9	2.00 H	77	47.46	-12.86
2	285.00	36.3 QP	46.0	-9.7	1.00 H	244	48.72	-12.45
3	298.69	37.6 QP	46.0	-8.4	2.00 H	52	49.51	-11.95
4	410.00	41.0 QP	46.0	-5.0	1.00 H	3	50.30	-9.33
5	432.60	41.4 QP	46.0	-4.6	1.00 H	59	49.76	-8.40
6	469.99	39.5 QP	46.0	-6.5	1.00 H	57	47.31	-7.84

ANTENNA POLARITY & TEST DISTANCE: VERTICAL AT 3 M

NO.	FREQ. (MHz)	EMISSION LEVEL (dBuV/m)	LIMIT (dBuV/m)	MARGIN (dB)	ANTENNA HEIGHT (m)	TABLE ANGLE (Degree)	RAW VALUE (dBuV)	CORRECTION FACTOR (dB/m)
1	73.49	36.8 QP	40.0	-3.2	2.00 V	156	53.11	-16.31
2	261.05	33.2 QP	46.0	-12.8	2.00 V	169	46.72	-13.55
3	322.15	37.3 QP	46.0	-8.8	2.00 V	360	48.27	-11.02
4	399.90	37.7 QP	46.0	-8.3	1.00 V	343	47.30	-9.59
5	410.00	39.4 QP	46.0	-6.6	1.00 V	55	48.73	-9.33
6	608.00	36.5 QP	46.0	-9.5	1.00 V	216	41.12	-4.59

REMARKS:

1. Emission Level(dBuV/m) = Raw Value(dBuV) + Correction Factor(dB/m)
2. Correction Factor(dB/m) = Antenna Factor(dB/m) + Cable Factor(dB) – Pre-Amplifier Factor(dB)
3. The other emission levels were very low against the limit.
4. Margin value = Emission Level – Limit value

4.2 Conducted Emission Measurement

4.2.1 Limits of Conducted Emission Measurement

Frequency (MHz)	Conducted Limit (dBuV)	
	Quasi-peak	Average
0.15 - 0.5	66 - 56	56 - 46
0.50 - 5.0	56	46
5.0 - 30.0	60	50

Note: 1. The lower limit shall apply at the transition frequencies.

2. The limit decreases in line with the logarithm of the frequency in the range of 0.15 to 0.50MHz.

4.2.2 Test Instruments

DESCRIPTION & MANUFACTURER	MODEL NO.	SERIAL NO.	CALIBRATED DATE	CALIBRATED UNTIL
Test Receiver ROHDE & SCHWARZ	ESCS 30	847124/029	Oct. 22, 2014	Oct. 21, 2015
Line-Impedance Stabilization Network (for EUT) SCHWARZBECK	NSLK-8127	8127-522	Sep. 15, 2014	Sep. 14, 2015
Line-Impedance Stabilization Network (for Peripheral) ROHDE & SCHWARZ	ENV216	100071	Nov. 10, 2014	Nov. 09, 2015
RF Cable (JYEBAO)	5D-FB	COCCAB-001	Mar. 09, 2015	Mar. 08, 2016
50 ohms Terminator	N/A	EMC-03	Sep. 22, 2014	Sep. 21, 2015
50 ohms Terminator	N/A	EMC-02	Sep. 30, 2014	Sep. 29, 2015
Software ADT	BV ADT_Cond_V7.3.7.3	NA	NA	NA

Note:

1. The calibration interval of the above test instruments is 12 months and the calibrations are traceable to NML/ROC and NIST/USA.
2. The test was performed in Shielded Room No. C.
- 3 The VCCI Con C Registration No. is C-3611.
- 4 Tested Date: Apr. 16, 2015

4.2.3 Test Procedures

- The EUT was placed 0.4 meters from the conducting wall of the shielded room with EUT being connected to the power mains through a line impedance stabilization network (LISN). Other support units were connected to the power mains through another LISN. The two LISNs provide 50 ohm/ 50uH of coupling impedance for the measuring instrument.
- Both lines of the power mains connected to the EUT were checked for maximum conducted interference.
- The frequency range from 150kHz to 30MHz was searched. Emission levels under (Limit - 20dB) was not recorded.

NOTE: The resolution bandwidth and video bandwidth of test receiver is 9kHz for quasi-peak detection (QP) and average detection (AV) at frequency 0.15MHz-30MHz.

4.2.4 Deviation from Test Standard

No deviation.

4.2.5 Test Setup

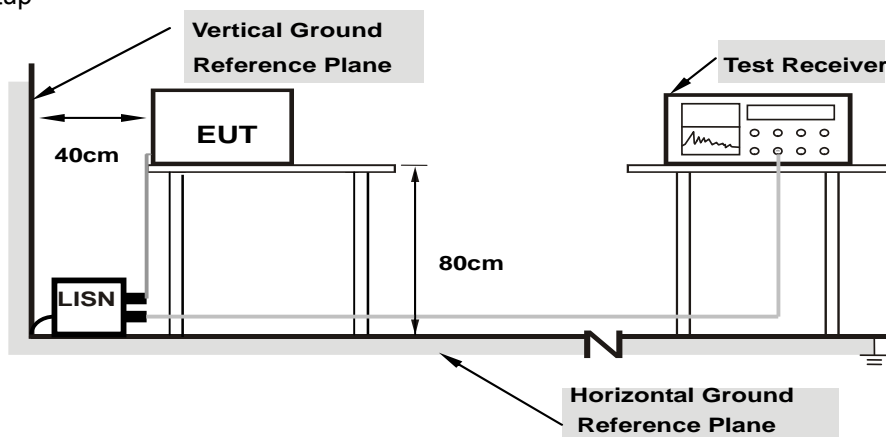

Note: 1.Support units were connected to second LISN.

For the actual test configuration, please refer to the attached file (Test Setup Photo).

4.2.6 EUT Operating Conditions

Same as 4.1.6.

4.2.7 Test Results

Phase	Line (L)	Detector Function	Quasi-Peak (QP) / Average (AV)
-------	----------	-------------------	--------------------------------

No	Freq. [MHz]	Corr.	Reading Value		Emission Level		Limit		Margin	
		Factor	[dB (uV)]		[dB (uV)]		[dB (uV)]		(dB)	
		(dB)	Q.P.	AV.	Q.P.	AV.	Q.P.	AV.	Q.P.	AV.
1	0.16562	0.08	45.71	36.23	45.79	36.31	65.18	55.18	-19.38	-18.86
2	0.21641	0.09	42.13	32.86	42.22	32.95	62.96	52.96	-20.73	-20.00
3	0.32578	0.10	36.59	22.67	36.69	22.77	59.56	49.56	-22.87	-26.79
4	0.48594	0.10	33.33	23.24	33.43	23.34	56.24	46.24	-22.80	-22.89
5	1.73047	0.16	28.64	19.00	28.80	19.16	56.00	46.00	-27.20	-26.84
6	10.88672	0.47	35.93	31.18	36.40	31.65	60.00	50.00	-23.60	-18.35

REMARKS:

1. Q.P. and AV. are abbreviations of quasi-peak and average individually.
2. The emission levels of other frequencies were very low against the limit.
3. Margin value = Emission Level – Limit value
4. Correction Factor = Insertion loss + Cable loss
5. Emission Level = Correction Factor + Reading Value

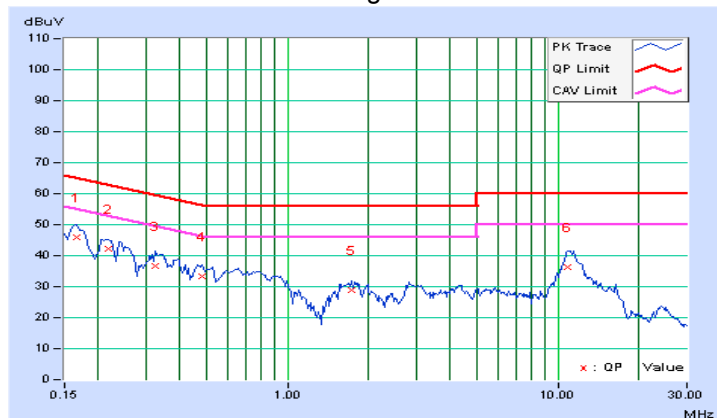

Phase	Neutral (N)	Detector Function	Quasi-Peak (QP) / Average (AV)
-------	-------------	-------------------	--------------------------------

No	Freq. [MHz]	Corr.	Reading Value		Emission Level		Limit		Margin	
		Factor	[dB (uV)]		[dB (uV)]		[dB (uV)]		(dB)	
	(dB)	Q.P.	AV.	Q.P.	AV.	Q.P.	AV.	Q.P.	AV.	
1	0.17734	0.08	43.39	34.01	43.47	34.09	64.61	54.61	-21.14	-20.52
2	0.22422	0.08	38.15	26.02	38.23	26.10	62.66	52.66	-24.43	-26.56
3	0.34922	0.09	35.12	28.09	35.21	28.18	58.98	48.98	-23.77	-20.80
4	0.72422	0.12	32.38	22.42	32.50	22.54	56.00	46.00	-23.50	-23.46
5	1.82813	0.16	27.24	17.17	27.40	17.33	56.00	46.00	-28.60	-28.67
6	11.17188	0.49	38.38	33.94	38.87	34.43	60.00	50.00	-21.13	-15.57

REMARKS:

1. Q.P. and AV. are abbreviations of quasi-peak and average individually.
2. The emission levels of other frequencies were very low against the limit.
3. Margin value = Emission Level – Limit value
4. Correction Factor = Insertion loss + Cable loss
5. Emission Level = Correction Factor + Reading Value

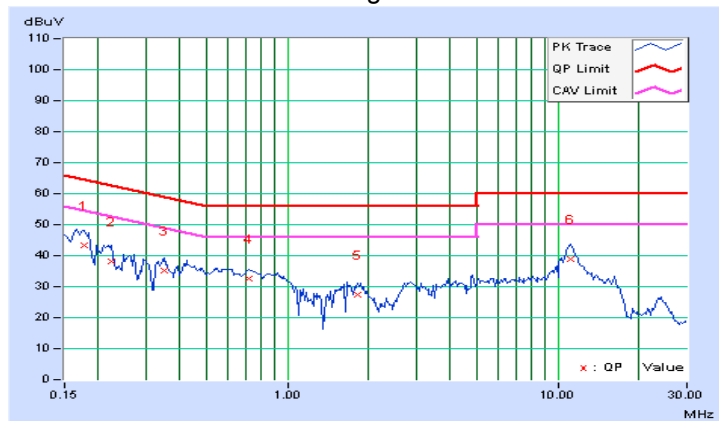

4.3 6dB Bandwidth Measurement

4.3.1 Limits of 6dB Bandwidth Measurement

The minimum of 6dB Bandwidth Measurement is 0.5 MHz.

4.3.2 Test Setup

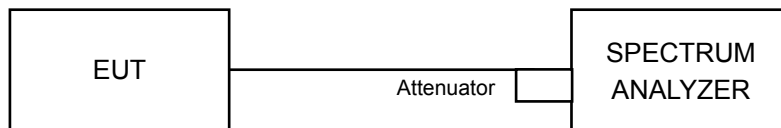

4.3.3 Test Instruments

Refer to section 4.1.2 to get information of above instrument.

4.3.4 Test Procedures

- a. Set resolution bandwidth (RBW) = 100kHz
- b. Set the video bandwidth (VBW) $\geq 3 \times$ RBW, Detector = Peak.
- c. Trace mode = max hold.
- d. Sweep = auto couple.
- e. Measure the maximum width of the emission that is constrained by the frequencies associated with the two amplitude points (upper and lower) that are attenuated by 6 dB relative to the maximum level measured in the fundamental emission

4.3.5 Deviation from Test Standard

No deviation.

4.3.6 EUT Operating Conditions

The software provided by client to enable the EUT under transmission condition continuously at lowest, middle and highest channel frequencies individually.

4.3.7 Test Results

Channel	Frequency (MHz)	6db Bandwidth (MHz)	Minimum Limit (MHz)	Pass / Fail
11	2405	1.16	0.5	Pass
18	2440	1.12	0.5	Pass
26	2480	1.28	0.5	Pass

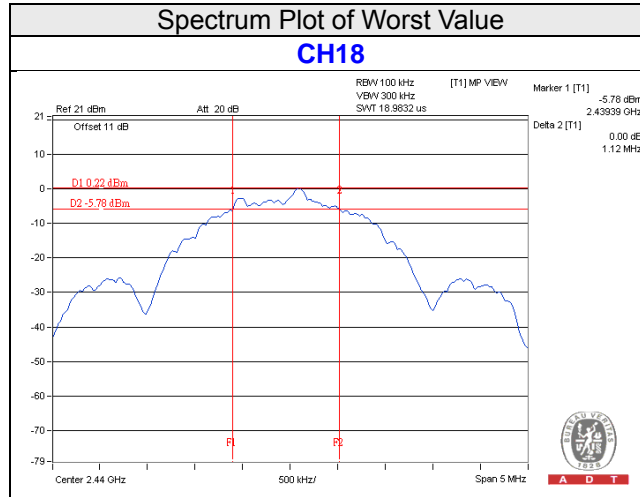

4.4 Conducted Output Power Measurement

4.4.1 Limits of Conducted Output Power Measurement

For systems using digital modulation in the 2400–2483.5 MHz bands: 1 Watt (30dBm)

4.4.2 Test Setup

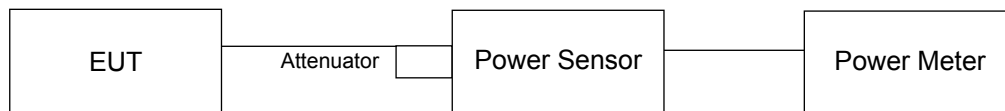

4.4.3 Test Instruments

Refer to section 4.1.2 to get information of above instrument.

4.4.4 Test Procedures

The peak / average power sensor was used on the output port of the EUT. A power meter was used to read the response of the peak / average power sensor. Record the power level.

4.4.5 Deviation from Test Standard

No deviation.

4.4.6 EUT Operating Conditions

Same as Item 4.3.6.

4.4.7 Test Results

FOR PEAK POWER

Channel	Frequency (MHz)	Peak Power (mW)	Peak Power (dBm)	Limit (dBm)	Pass/Fail
11	2405	1.959	2.92	30	Pass
18	2440	1.888	2.76	30	Pass
26	2480	1.622	2.10	30	Pass

FOR AVERAGE POWER

Channel	Frequency (MHz)	Average Power (mW)	Average Power (dBm)
11	2405	1.393	1.44
18	2440	1.315	1.19
26	2480	1.159	0.64

4.5 Power Spectral Density Measurement

4.5.1 Limits of Power Spectral Density Measurement

The Maximum of Power Spectral Density Measurement is 8dBm.

4.5.2 Test Setup

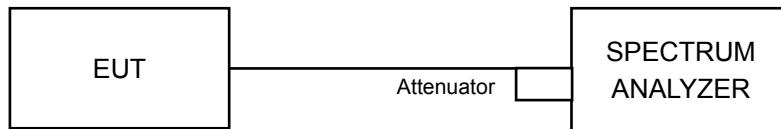

4.5.3 Test Instruments

Refer to section 4.1.2 to get information of above instrument.

4.5.4 Test Procedures

- a. Set analyzer center frequency to DTS channel center frequency.
- b. Set the span to 1.5 times the DTS bandwidth.
- c. Set the RBW to: $3 \text{ kHz} \leq \text{RBW} \leq 100 \text{ kHz}$.
- d. Set the VBW $\geq 3 \times \text{RBW}$.
- e. Detector = peak.
- f. Sweep time = auto couple.
- g. Trace mode = max hold.
- h. Allow trace to fully stabilize.
- i. Use the peak marker function to determine the maximum amplitude level within the RBW.

4.5.5 Deviation from Test Standard

No deviation.

4.5.6 EUT Operating Conditions

Same as Item 4.3.6.

4.5.7 Test Results

Channel	Frequency (MHz)	PSD (dBm)	Limit (dBm)	Pass /Fail
11	2405	-10.59	8	Pass
18	2440	-10.76	8	Pass
26	2480	-11.58	8	Pass

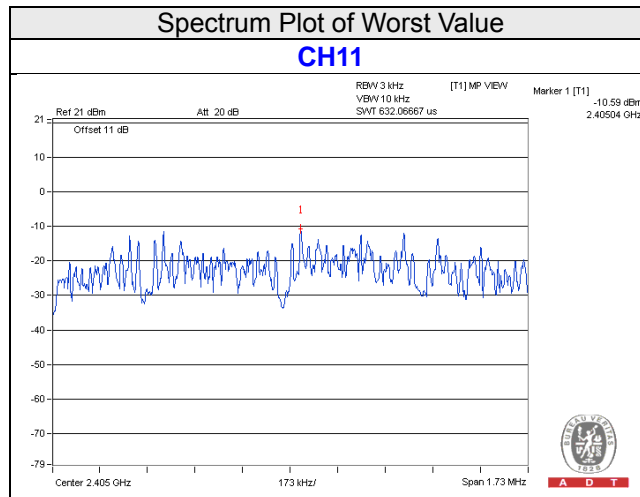

4.6 Conducted Out of Band Emission Measurement

4.6.1 Limits of Conducted Out of Band Emission Measurement

Below 20dB of the highest emission level of operating band (in 100kHz Resolution Bandwidth).

4.6.2 Test Setup

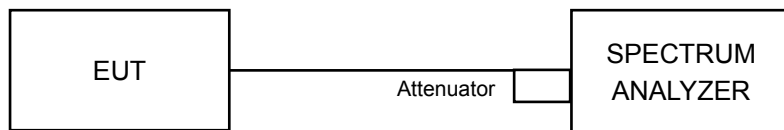

4.6.3 Test Instruments

Refer to section 4.1.2 to get information of above instrument.

4.6.4 Test Procedures

MEASUREMENT PROCEDURE REF

1. Set the RBW = 100 kHz.
2. Set the VBW \geq 300 kHz.
3. Detector = peak.
4. Sweep time = auto couple.
5. Trace mode = max hold.
6. Allow trace to fully stabilize.
7. Use the peak marker function to determine the maximum power level in any 100 kHz band segment within the fundamental EBW.

MEASUREMENT PROCEDURE OOBE

1. Set RBW = 100 kHz.
2. Set VBW \geq 300 kHz.
3. Detector = peak.
4. Sweep = auto couple.
5. Trace Mode = max hold.
6. Allow trace to fully stabilize.
7. Use the peak marker function to determine the maximum amplitude level.

4.6.5 Deviation from Test Standard

No deviation.

4.6.6 EUT Operating Conditions

Same as Item 4.3.6

4.6.7 Test Results

The spectrum plots are attached on the following pages. D1 line indicates the highest level, and D2 line indicates the 20dB offset below D1. It shows compliance with the requirement.

CH 11

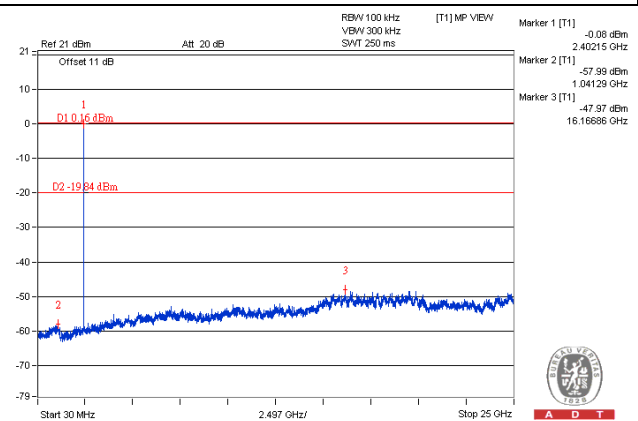
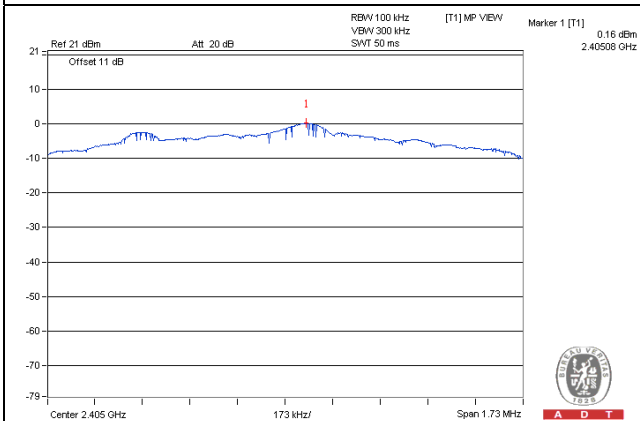

CH 18

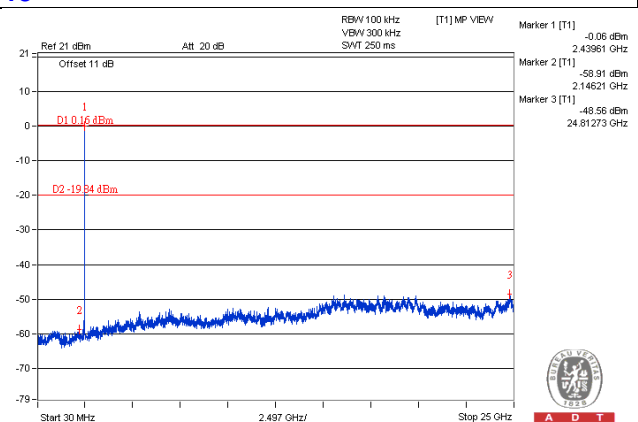
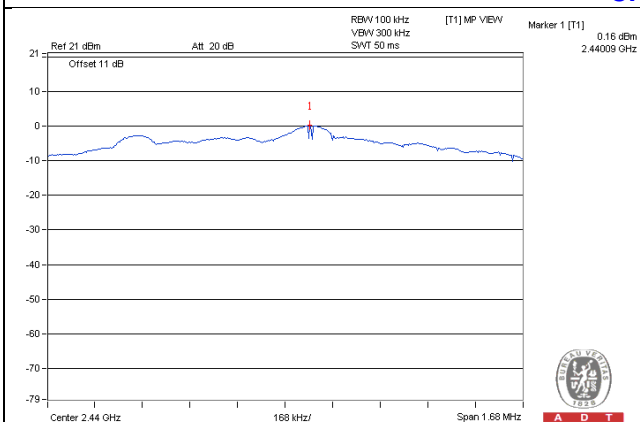

CH 26

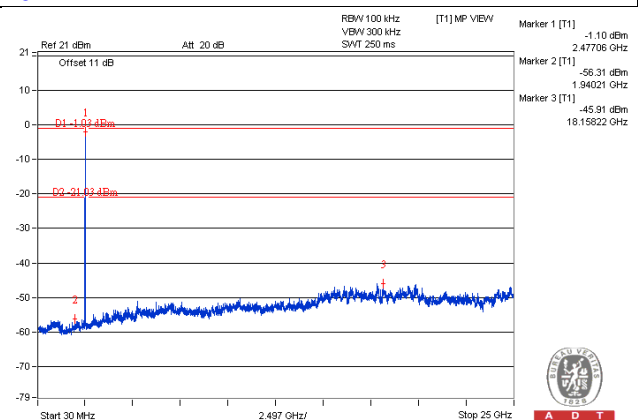
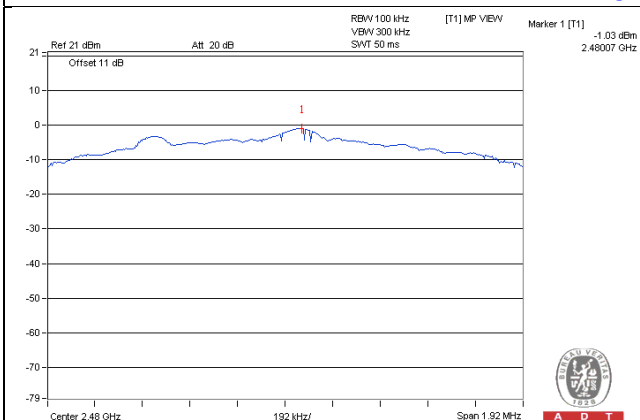

CH 11 Band edge

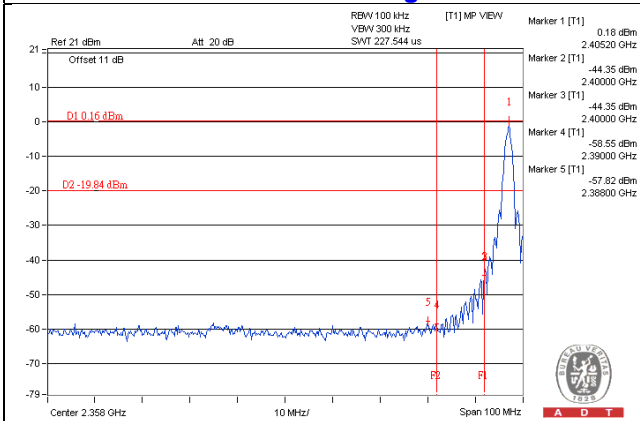

CH 26 Band edge

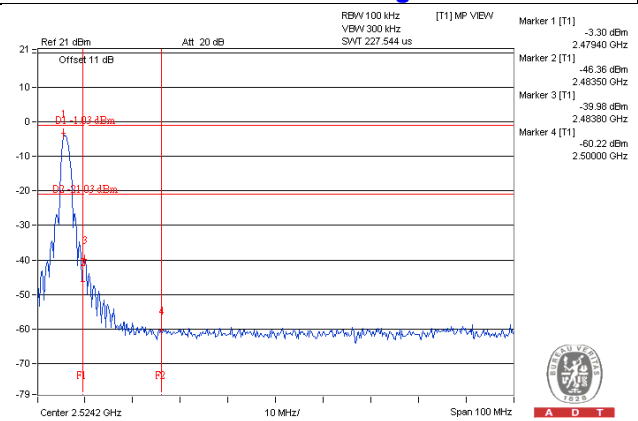

5 Pictures of Test Arrangements

Please refer to the attached file (Test Setup Photo).



Appendix – Information on the Testing Laboratories

We, Bureau Veritas Consumer Products Services (H.K.) Ltd., Taoyuan Branch, were founded in 1988 to provide our best service in EMC, Radio, Telecom and Safety consultation. Our laboratories are accredited and approved according to ISO/IEC 17025.

If you have any comments, please feel free to contact us at the following:

Linko EMC/RF Lab

Tel: 886-2-26052180

Fax: 886-2-26051924

Hsin Chu EMC/RF/Telecom Lab

Tel: 886-3-5935343

Fax: 886-3-5935342

Hwa Ya EMC/RF/Safety Lab

Tel: 886-3-3183232

Fax: 886-3-3270892

Email: service.adt@tw.bureauveritas.com

Web Site: www.bureauveritas-adt.com

The address and road map of all our labs can be found in our web site also.

--- END ---