

Specific Absorption Rate (SAR) Test Report
for
SeaQuad Logistics Inc.
on the
GSM phone

Report No. : O451105-1-2-01
Trade Name : SeaQuad
Model Name : Abalone 200
FCC ID : MCLABALONE200
Date of Testing : May 11~12, 2004
Date of Report. : May 14, 2004
Date of Review : May 17, 2004

- The test results refer exclusively to the presented test model/sample only.
- Without written approval of SPORTON International Inc., the test report shall not be reproduced except in full.

SPORTON International Inc.

6F, No.106, Sec. 1, Hsin Tai Wu Rd., Hsi Chih, Taipei Hsien, Taiwan, R.O.C.



Table of Contents

1. Statement of Compliance ----- 1

2. Administration Data ----- 2

 2.1 Testing Laboratory ----- 2

 2.2 Detail of Applicant ----- 2

 2.3 Detail of Manufacturer ----- 2

 2.4 Application Detail ----- 2

3. General Information ----- 3

 3.1 Description of Device Under Test (DUT) ----- 3

 3.2 Applied Standards: ----- 5

 3.3 Device Category and SAR Limits ----- 6

 3.4 Test Conditions: ----- 6

 3.4.1 Ambient Condition ----- 6

 3.4.2 Test Configuration ----- 6

4. Specific Absorption Rate (SAR) ----- 7

 4.1 Introduction ----- 7

 4.2. SAR Definition ----- 7

5. SAR Measurement Setup ----- 8

 5.1. DASY4 E-Field Probe System ----- 9

 5.1.1. ET3DV6 E-Field Probe Specification ----- 10

 5.1.2 ET3DV6 E-Field Probe Calibration ----- 10

 5.2 DATA Acquisition Electronics (DAE) ----- 11

 5.3 Robot ----- 12

 5.4 Measurement Server ----- 12

 5.5 SAM Twin Phantom ----- 12

 5.6. Device Holder for SAM Twin Phantom ----- 14

 5.7 Data Storage and Evaluation ----- 15

 5.7.1 Data Storage ----- 15

 5.7.2 Data Evaluation ----- 15

 5.8. Test Equipment List ----- 18

6. Tissue Simulating Liquids ----- 19

7. Uncertainty Assessment ----- 21

8. SAR Measurement Evaluation ----- 23

 8.1 Purpose of System Performance check ----- 23

 8.2 System Setup ----- 23

 8.3 Validation Results ----- 25

9. Description for DUT Testing Position ----- 26

10. Measurement Procedures ----- 31

 10.1 Spatial Peak SAR Evaluation ----- 31

 10.2 Scan Procedures ----- 32

 10.3 SAR Averaged Methods ----- 32



11. SAR Test Results-----	33
11.1 Right Cheek-----	33
11.2 Right Tilted -----	33
11.3 Left Cheek-----	33
11.4 Left Tilted -----	33
11.5 Body Worn-keypad up -----	34
11.6 Body Worn-keypad down-----	34
12.References -----	35

Appendix A - System Performance Check Data

Appendix B - SAR Measurement Data

Appendix C - Calibration Data

1. Statement of Compliance

The Specific Absorption Rate (SAR) maximum results found during testing for the **SeaQuad Logistics Inc. GSM phone Abalone 200** are **0.724 W/Kg for PCS head SAR and 0.0776 W/Kg for PCS body SAR** with expanded uncertainty 20.6%. They are in compliance with Specific Absorption Rate (SAR) for general population/uncontrolled exposure limits specified in FCC 47 CFR part 2 (2.1093) and ANSI/IEEE C95.1-1999 and had been tested in accordance with the measurement methods and procedures specified in OET Bulletin 65 Supplement C (Edition 01-01).

Tested by

Approved by

Phillip Lin

Phillip Lin
Project Leader

Daniel Lee 5/1/2004

Dr. C.H. Daniel Lee
SAR Lab. Manager



2. Administration Data

2.1 Testing Laboratory

Company Name : Sporton International Inc.
Department : Antenna Design/SAR
Address : No.52, Hwa-Ya 1st RD., Hwa Ya Technology Park, Kwei-Shan Hsiang, TaoYuan Hsien, Taiwan, R.O.C.
Telephone Number : 886-3-327-3456
Fax Number : 886-3-327-0973

2.2 Detail of Applicant

Company Name : SeaQuad Logistics Inc.
Address : 1200 Old Skokie Road, Highland Park, IL 60035 USA
Telephone Number : 886-3-578-4957
Fax Number : 886-3-577-8112
Contact Person : Te-pi.wang@foxconn.com

2.3 Detail of Manufacturer

Company Name : HonXun Electrical Industry (HangZhou)Co.
Address : Hang Zhou Economic & Technology Development Zone Road No.1

2.4 Application Detail

Date of reception of application: May 11, 2004
Start of test : May 11, 2004
End of test : May 12, 2004



3. General Information

3.1 Description of Device Under Test (DUT)

DUT Type :	GSM phone
Trade Name :	SeaQuad
Model Name :	Abalone 200
FCC ID :	MCLABALONE200
Tx Frequency :	1850-1910 MHz (PCS)
Rx Frequency :	1930-1990MHz (PCS)
Antenna Type :	Fixed External
Maximum Power Rating :	29.08 dBm
IMEI code:	446019197507590
HW Version:	CS008-RM-3A
SW Version:	DH201-SPN-05.01-02.18-02.20
Type of Modulation :	GMSK
DUT Stage:	Production Unit
Application Type :	Certification



Fig. 3.1. Inside view of DUT



Fig. 3.2 Outside view of DUT



3.2 Applied Standards:

The Specific Absorption Rate (SAR) testing specification, method and procedure for this GSM phone is in accordance with the following standards:

47 CFR Part 2 (2.1093),
IEEE C95.1-1999,
IEEE C95.3-1991,
IEEE P1528 -200X, and
OET Bulletin 65 Supplement C (Edition 01-01)



3.3 Device Category and SAR Limits

This device belongs to portable device category because its radiating structure is allowed to be used within 20 centimeters of the body of the user.

Limit for General Population/Uncontrolled exposure should be applied for this device, it is 1.6 W/kg as averaged over any 1 gram of tissue.

3.4 Test Conditions:

3.4.1 Ambient Condition

Item	Head	Body
Ambient Temperature (°C)	20-24°C	
Tissue simulating liquid temperature (°C)	21.5°C	21.2°C
Humidity (%)	<60%	

3.4.2 Test Configuration

The device was controlled by using a base station emulator CMU 200. Communication between the device and the emulator was established by air link. The distance between the DUT and the antenna of the emulator is larger than 50 cm and the output power radiated from the emulator antenna is at least 30 dB smaller than the output power of DUT.

Measurements were performed on the lowest, middle, and highest channel for each testing position for head SAR testing. Measurements were performed only on the middle channel if the SAR is below 3 dB of limit for body SAR testing.

The DUT was set from the emulator to radiate maximum output power during all testing.

For head and body SAR testing, EUT is in GSM link mode, and its crest factor is 8.3.



4. Specific Absorption Rate (SAR)

4.1 Introduction

SAR is related to the rate at which energy is absorbed per unit mass in an object exposed to a radio field. The SAR distribution in a biological body is complicated and is usually carried out by experimental techniques or numerical modeling. The standard recommends limits for two tiers of groups, occupational/controlled and general population/uncontrolled, based on a person's awareness and ability to exercise control over his or her exposure. In general, occupational/controlled exposure limits are higher than the limits for general population/uncontrolled.

4.2. SAR Definition

The SAR definition is the time derivative (rate) of the incremental energy (dW) absorbed by (dissipated in) an incremental mass (dm) contained in a volume element (dv) of a given density.

ρ). The equation description is as below:

$$\mathbf{SAR} = \frac{d}{dt} \left(\frac{dW}{dm} \right) = \frac{d}{dt} \left(\frac{dW}{\rho dv} \right)$$

SAR is expressed in units of Watts per kilogram (W/kg)

SAR measurement can be either related to the temperature elevation in tissue by

$$\mathbf{SAR} = C \frac{\delta T}{\delta t}$$

, where C is the specific heat capacity, δT is the temperature rise and δt the exposure duration,

or related to the electrical field in the tissue by

$$\mathbf{SAR} = \frac{\sigma |E|^2}{\rho}$$

, where σ is the conductivity of the tissue, ρ is the mass density of the tissue and E is the rms electrical field strength.

However for evaluating SAR of low power transmitter, electrical field measurement is typically applied.

5. SAR Measurement Setup

Remote Control Box

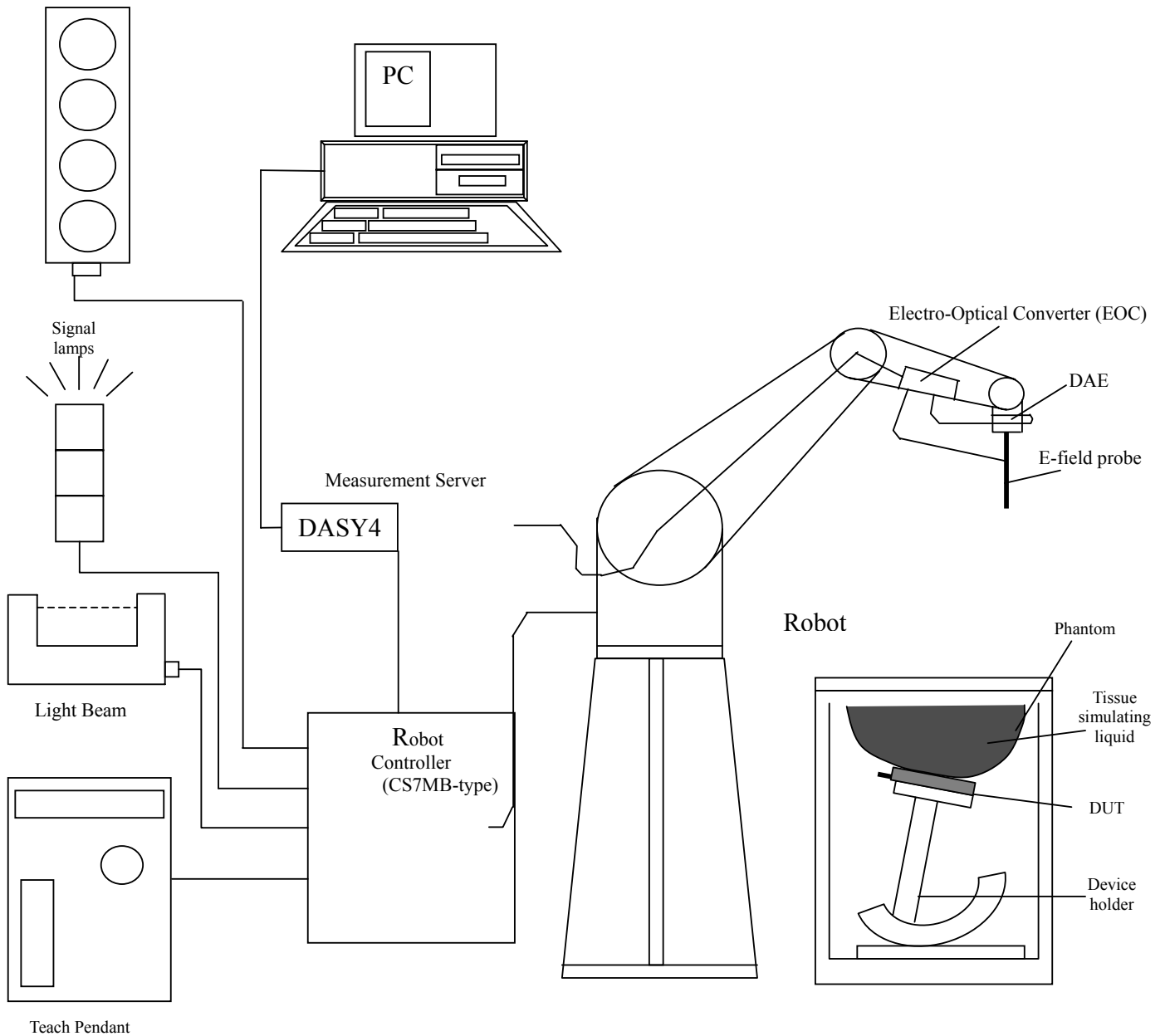

Fig. 5.1 DASY4 system



The DASY4 system for performance compliance tests is illustrated above graphically. This system consists of the following items:

- A standard high precision 6-axis robot with controller, a teach pendant and software
- A data acquisition electronic (DAE) attached to the robot arm extension
- A dosimetric probe equipped with an optical surface detector system
- The electro-optical converter (ECO) performs the conversion between optical and electrical signals
- A measurement server performs the time critical tasks such as signal filtering, control of the robot operation and fast movement interrupts.
- A probe alignment unit which improves the accuracy of the probe positioning
- A computer operating Windows XP
- DASY4 software
- Remote control with teach pendant and additional circuitry for robot safety such as warning lamps, etc.
- The SAM twin phantom
- A device holder
- Tissue simulating liquid
- Dipole for evaluating the proper functioning of the system

Some of the components are described in details in the following sub-sections.

5.1.DASY4 E-Field Probe System

The SAR measurement is conducted with the dosimetric probe ET3DV6 (manufactured by SPEAG). The probe is specially designed and calibrated for use in liquid with high permittivity. The dosimetric probe has special calibration in liquid at different frequency. This probe has a built in optical surface detection system to prevent from collision with phantom.

Calibration: Required once a year.



5.1.1.ET3DV6 E-Field Probe Specification

Construction	Symmetrical design with triangular core Built-in optical fiber for surface detection system Built-in shielding against static charges PEEK enclosure material (resistant to organic solvents)
Calibration	Simulating tissue at frequencies of 900MHz, 1.8GHz and 2.45GHz for brain and muscle (accuracy $\pm 8\%$)
Frequency	10 MHz to > 3 GHz
Directivity	± 0.2 dB in brain tissue (rotation around probe axis) ± 0.4 dB in brain tissue (rotation perpendicular to probe axis)
Dynamic Range	5μ W/g to > 100mW/g; Linearity: ± 0.2 dB
Surface Detection	± 0.2 mm repeatability in air and clear liquids on reflecting surface
Dimensions	Overall length: 330mm Tip length: 16mm Body diameter: 12mm Tip diameter: 6.8mm Distance from probe tip to dipole centers: 2.7mm
Application	General dosimetry up to 3GHz Compliance tests for mobile phones and Wireless LAN Fast automatic scanning in arbitrary phantoms



Fig. 5.2 Probe setup on robot

5.1.2 ET3DV6 E-Field Probe Calibration

Each probe needs to be calibrated according to a dosimetric assessment procedure with accuracy better than $\pm 10\%$. The spherical isotropy shall be evaluated and within ± 0.25 dB. The sensitivity parameters (NormX, NormY, and NormZ), the diode compression parameter (DCP) and the conversion factor (ConvF) of the probe are tested. The calibration data are as below:



Sensitivity	X axis : 1.68 μ V	Y axis : 1.62 μ V	Z axis : 1.71 μ V	
Diode compression point	X axis : 95 mV	Y axis : 95 mV	Z axis : 95 mV	
Conversion factor (Head/Body)	Frequency (MHz)	X axis	Y axis	Z axis
	800~1000	6.6/6.5	6.6/6.5	6.6/6.5
	1710~1990	5.3/5.0	5.3/5.0	5.3/5.0
Boundary effect (Head/Body)	Frequency (MHz)	Alpha	Depth	
	800~1000	0.34/0.31	2.48/2.92	
	1710~1990	0.43/0.51	2.80/2.78	

NOTE:

- The probe parameters have been calibrated by the SPEAG.

5.2 DATA Acquisition Electronics (DAE)

The data acquisition electronics (DAE4) consists of a highly sensitive electrometer-grade preamplifier with auto-zeroing, a channel and gain-switching multiplexer, a fast 16 bit AD-converter and a command decoder and control logic unit. Transmission to the measurement server is accomplished through an optical downlink for data and status information as well as an optical uplink for commands and the clock.

The mechanical probe mounting device includes two different sensor systems for frontal and sideways probe contacts. They are used for mechanical surface detection and probe collision detection.

The input impedance of the DAE4 is 200M Ohm; the inputs are symmetrical and floating. Common mode rejection is above 80dB.

Calibration: Required once a year.



5.3 Robot

The DASY4 system uses the high precision robots RX90BL type out of the newer series from Stäubli SA (France). For the 6-axis controller DASY5 system, the CS7MB robot controller version from Stäubli is used. The RX robot series have many features that are important for our application:

- High precision (repeatability 0.02 mm)
- High reliability (industrial design)
- Jerk-free straight movements
- Low ELF interference (the closed metallic construction shields against motor control fields)
- 6-axis controller

5.4 Measurement Server

The DASY4 measurement server is based on a PC/104 CPU board with
166 MHz CPU
32 MB chipset and
64 MB RAM.

Communication with
the DAE4 electronic box
the 16-bit AD-converter system for optical detection and digital I/O interface.

The measurement server performs all the real-time data evaluation for field measurements and surface detection, controls robot movements and handles safety operations.

Calibration: No calibration required.

5.5 SAM Twin Phantom

The SAM twin phantom is a fiberglass shell phantom with 2mm shell thickness (except the ear region where shell thickness increases to 6mm). It has three measurement areas:

- Left head
- Right head
- Flat phantom

The bottom plate contains three pair of bolts for locking the device holder. The device holder positions are adjusted to the standard measurement positions in the three sections.



A white cover is provided to tap the phantom during off-periods to prevent water evaporation and changes in the liquid parameters.

On the phantom top, three reference markers are provided to identify the phantom position with respect to the robot.

The phantom can be used with the following tissue simulating liquids:

- *Water-sugar based liquid
- *Glycol based liquids



Fig. 5.3 Top view of twin phantom



Fig. 5.4 Bottom view of twin phantom

5.6. Device Holder for SAM Twin Phantom

The SAR in the Phantom is approximately inversely proportional to the square of the distance between the source and the liquid surface. For a source in 5 mm distance, a positioning uncertainty of $\pm 0.5\text{mm}$ would produce a SAR uncertainty of $\pm 20\%$. An accurate device position is therefore crucial for accurate and repeatable measurement. The position in which the devices must be measured, are defined by the standards.

The DASY device holder is designed to cope with different positions given in the standard. It has two scales for the device rotation (with respect to the body axis) and the device inclination (with respect to the line between the ear reference points). The rotation centers for both scales is the ear reference point (EPR). Thus the device needs no repositioning when changing the angles.

The DASY device holder has been made out of low-loss POM material having the following dielectric parameters: relative permittivity $\epsilon_r=3$ and loss tangent $\delta = 0.02$. The amount of dielectric material has been reduced in the closest vicinity of the device, since measurements have suggested that the influence of the clamp on the test results could thus be lowered.



Fig. 5.5 Device Holder



5.7 Data Storage and Evaluation

5.7.1 Data Storage

The DASY4 software stores the assessed data from the data acquisition electronics as raw data (in microvolt readings from the probe sensors), together with all the necessary software parameters for the data evaluation (probe calibration data, liquid parameters and device frequency and modulation data) in measurement files with the extension .DA4. The postprocessing software evaluates the desired unit and format for output each time the data is visualized or exported. This allows verification of the complete software setup even after the measurement and allows correction of erroneous parameter settings. For example, if a measurement has been performed with an incorrect crest factor parameter in the device setup, the parameter can be corrected afterwards and the data can be reevaluated.

The measured data can be visualized or exported in different units or formats, depending on the selected probe type (e.g., [V/m], [A/m], [mW/g]). Some of these units are not available in certain situations or give meaningless results, e.g., a SAR-output in a loseless media, will always be zero. Raw data can also be exported to perform the evaluation with other software packages.

5.7.2 Data Evaluation

The DASY4 postprocessing software (SEMCAD) automatically executes the following procedures to calculate the field units from the microvolt readings at the probe connector. The parameters used in the evaluation are stored in the configuration modules of the software :

Probe parameters :	- Sensitivity	$Norm_i, a_{i,0}, a_{i,1}, a_{i,2}$
	- Conversion factor	$ConvF_i$
	- Diode compression point	dcp_i
Device parameters :	- Frequency	f
	- Crest factor	cf
Media parameters :	- Conductivity	σ
	- Density	ρ

These parameters must be set correctly in the software. They can be found in the component documents or they can be imported into the software from the configuration files issued for the DASY components. In the direct measuring mode of the multimeter option, the parameters of the actual system setup are used. In the scan visualization and export modes, the parameters stored in the corresponding document files are used.

The first step of the evaluation is a linearization of the filtered input signal to account for the compression characteristics of the detector diode. The compensation depends on the input signal, the diode type and the DC-transmission factor from the diode to the evaluation electronics. If the exciting field is pulsed, the crest



factor of the signal must be known to correctly compensate for peak power. The formula for each channel can be given as :

$$V_i = U_i + U_i^2 \cdot \frac{cf}{dcp_i}$$

with V_i = compensated signal of channel i ($i = x, y, z$)
 U_i = input signal of channel i ($i = x, y, z$)
 cf = crest factor of exciting field (DASY parameter)
 dcp_i = diode compression point (DASY parameter)

From the compensated input signals, the primary field data for each channel can be evaluated :

E-field probes : $E_i = \sqrt{\frac{V_i}{Norm_i ConvF}}$

H-field probes : $H_i = \sqrt{V_i \frac{a_{i0} + a_{i1}f + a_{i2}f^2}{f}}$

with V_i = compensated signal of channel i ($i = x, y, z$)
 $Norm_i$ = sensor sensitivity of channel i ($i = x, y, z$)
 $\mu V/(V/m)^2$ for E-field Probes
 $ConvF$ = sensitivity enhancement in solution
 a_{ij} = sensor sensitivity factors for H-field probes
 f = carrier frequency [GHz]
 E_i = electric field strength of channel i in V/m
 H_i = magnetic field strength of channel i in A/m

The RSS value of the field components gives the total field strength (Hermitian magnitude) :

$$E_{tot} = \sqrt{E_x^2 + E_y^2 + E_z^2}$$

The primary field data are used to calculate the derived field units.

$$SAR = E_{tot}^2 \cdot \frac{\sigma}{\rho \cdot 1000}$$

with SAR = local specific absorption rate in mW/g
 E_{tot} = total field strength in V/m
 σ = conductivity in [mho/m] or [Siemens/m]



ρ = equivalent tissue density in g/cm³

* Note that the density is set to 1, to account for actual head tissue density rather than the density of the tissue simulating liquid.

The power flow density is calculated assuming the excitation field to be a free space field.

$$P_{pwe} = \frac{E_{tot}^2}{3770} \quad \text{or} \quad P_{pwe} = H_{tot}^2 \cdot 37.7$$

with P_{pwe} = equivalent power density of a plane wave in mW/cm²
 E_{tot} = total electric field strength in V/m
 H_{tot} = total magnetic field strength in A/m



5.8. Test Equipment List

Manufacture	Name of Equipment	Type/Model	Serial Number	Calibration	
				Last Cal.	Due Date
SPEAG	Dosimetric E-Filed Probe	ET3DV6	1788	Aug. 29, 2003	Aug. 29, 2004
SPEAG	835MHz System Validation Kit	D835V2	499	Feb. 12, 2004	Feb. 12, 2005
SPEAG	900MHz System Validation Kit	D900V2	190	July 17, 2003	July 17, 2004
SPEAG	1800MHz System Validation Kit	D1800V2	2d076	July 16, 2003	July 16, 2004
SPEAG	1900MHz System Validation Kit	D1900V2	5d041	Feb. 17, 2004	Feb. 17, 2005
SPEAG	2450MHz System Validation Kit	D2450V2	736	Aug. 26, 2003	Aug. 26, 2004
SPEAG	Data Acquisition Electronics	DAE3	577	Nov. 21, 2003	Nov. 21, 2004
SPEAG	Device Holder	N/A	N/A	NCR	NCR
SPEAG	Phantom	QD 000 P40 C	TP-1150	NCR	NCR
SPEAG	Robot	Staubli RX90BL	F03/5W15A1/A/01	NCR	NCR
SPEAG	Software	DASY4 V4.1 Build 47	N/A	NCR	NCR
SPEAG	Software	SEMCAD V1.6 Build 116	N/A	NCR	NCR
SPEAG	Measurement Server	SE UMS 001 BA	1021	NCR	NCR
Agilent	S-Parameter Network Analyzer (PNA)	E8358A	US40260131	Oct. 17, 2003	Oct. 17, 2004
Agilent	Dielectric Probe Kit	85070D	US01440205	NCR	NCR
Agilent	Dual Directional Coupler	778D	50422	NCR	NCR
Agilent	Power Amplifier	8449B	3008A01917	Sep. 16, 2003	Sep. 16, 2004
R & S	Radio Communication Tester	CMU200	103937	Oct. 20, 2003	Oct. 20, 2004
Agilent	Power Meter	E4416A	GB41292344	Feb. 12, 2004	Feb. 12, 2005
Agilent	Signal Generator	E8247C	MY43320596	Feb. 10, 2004	Feb. 10, 2005
Agilent	Base Station Emulator	E5515C	GB43460754	Jan. 12, 2004	Jan. 12, 2005

Table 5.1 Test Equipment List



6. Tissue Simulating Liquids

For the measurement of the field distribution inside the SAM phantom with DASY4, the phantom must be filled with around 25 liters of homogeneous body tissue simulating liquid. The liquid height from the ear reference point (ERP) of the phantom to the liquid top surface is 15.2 cm.

The following ingredients for tissue simulating liquid are used:

- **Water:** deionized water (pure H₂O), resistivity $\geq 16M\Omega$ - as basis for the liquid
- **Sugar:** refined sugar in crystals, as available in food shops – to reduce relative permittivity
- **Salt:** pure NaCl – to increase conductivity
- **Cellulose:** Hydroxyethyl-cellulose, medium viscosity (75-125 mPa.s, 2% in water, 20°C), CAS#54290-to increase viscosity and to keep sugar in solution.
- **Preservative:** Preventol D-7 Bayer AG, D-51368 Leverkusen, CAS#55965-84-9- to prevent the spread of bacteria and molds.
- **DGMBE:** Deithlenglycol-monobuthyl ether (DGMBE), Fluka Chemie GmbH, CAS#112-34-5 – to reduce relative permittivity.

Table 6.1 gives the recipes for one liter of head and body tissue simulating liquid for frequency band 1900 MHz.

Ingredient	HSL-1900	MSL-1900
Water	552.42 g	716.56 g
Cellulose	0 g	0 g
Salt	3.06 g	4.0 g
Preventol D-7	0 g	0 g
Sugar	0 g	0 g
DGMBE	444.52 g	300.67 g
Total amount	1 liter (1.0 kg)	1 liter (1.0 kg)
Dielectric Parameters at 22°	f= 1900 MHz $\epsilon_r = 40.0 \pm 5\%$, $\sigma = 1.45 \pm 5\%$ S/m	f= 1900 MHz $\epsilon_r = 53.3 \pm 5\%$, $\sigma = 1.52 \pm 5\%$ S/m

Table 6.1

The dielectric parameters of the liquids were verified prior to the SAR evaluation using an Agilent 85070D Dielectric Probe Kit and an Agilent E8358A Network Analyzer.



Table 6.2 shows the measuring results for head simulating liquid. The testing date for tissue properties were May 11, 2004 and May 12,2004 which were matched with SAR testing date.

	Bands	Frequency(MHz)	Permittivity (ϵ_r)	Conductivity (σ)
Head	PCS band (1850 ~ 1910 MHz)	1850.2	39.5119	1.41386
		1880.0	39.4725	1.44056
		1909.8	39.3728	1.46624
Body	PCS band (1850 ~ 1910 MHz)	1850.2	52.2	1.573
		1880.0	52.2917	1.56617
		1909.8	52	1.54

Table 6.2

The measuring data are consistent with $\epsilon_r = 40.0 \pm 5\%$ and $\sigma = 1.45 \pm 5\%$ for head PCS band and $\epsilon_r = 53.3 \pm 5\%$ and $\sigma = 1.52 \pm 5\%$ for body PCS band.



7. Uncertainty Assessment

The component of uncertainty may generally be categorized according to the methods used to evaluate them. The evaluation of uncertainty by the statistical analysis of a series of observations is termed a Type A evaluation of uncertainty. The evaluation of uncertainty by means other than the statistical analysis of a series of observation is termed a Type B evaluation of uncertainty. Each component of uncertainty, however evaluated, is represented by an estimated standard deviation, termed standard uncertainty, which is determined by the positive square root of the estimated variance.

A Type A evaluation of standard uncertainty may be based on any valid statistical method for treating data. This includes calculating the standard deviation of the mean of a series of independent observations; using the method of least squares to fit a curve to the data in order to estimate the parameter of the curve and their standard deviations; or carrying out an analysis of variance in order to identify and quantify random effects in certain kinds of measurement.

A type B evaluation of standard uncertainty is typically based on scientific judgment using all of the relevant information available. These may include previous measurement data, experience and knowledge of the behavior and properties of relevant materials and instruments, manufacture’s specification, data provided in calibration reports and uncertainties assigned to reference data taken from handbooks. Broadly speaking, the uncertainty is either obtained from an outdoor source or obtained from an assumed distribution, such as the normal distribution, rectangular or triangular distributions indicated in Table 7.1

Uncertainty Distributions	Normal	Rectangular	Triangular	U-shape
Multiplying factor ^(a)	1/k (b)	1/√3	1/√6	1/√2

- (a) standard uncertainty is determined as the product of the multiplying factor and the estimated range of variations in the measured quantity
- (b) k is the coverage factor

Table 7.1

The combined standard uncertainty of the measurement result represents the estimated standard deviation of the result. It is obtained by combining the individual standard uncertainties of both Type A and Type B evaluation using the usual “root-sum-squares” (RSS) methods of combining standard deviations by taking the positive square root of the estimated variances.

Expanded uncertainty is a measure of uncertainty that defines an interval about the measurement result within which the measured value is confidently believed to lie. It is obtained by multiplying the combined standard uncertainty by a coverage factor. Typically, the coverage factor ranges from 2 to 3. Using a coverage factor allows the true value of a measured quantity to be specified with a defined probability within the specified uncertainty range. For purpose of this document, a coverage factor two is used, which corresponds to confidence interval of about 95 %. The DASY4 uncertainty Budget is showed in Table 7.2.



Error Description	Uncertainty Value \pm %	Probability Distribution	Divisor	C_i $1/g$	Standard Unc. (1-g)	v_i or V_{eff}
Measurement System						
Probe Calibration	± 4.8	Normal	1	1	± 4.8	∞
Axial Isotropy	± 4.7	Rectangular	$\sqrt{3}$	$(1-C_p)^{1/2}$	± 1.9	∞
Hemispherical Isotropy	± 9.6	Rectangular	$\sqrt{3}$	$(C_p)^{1/2}$	± 3.9	∞
Boundary Effect	± 1.0	Rectangular	$\sqrt{3}$	1	± 0.6	∞
Linearity	± 4.7	Rectangular	$\sqrt{3}$	1	± 2.7	∞
System Detection Limit	± 1.0	Rectangular	$\sqrt{3}$	1	± 0.6	∞
Readout Electronics	± 1.0	Rectangular	1	1	± 1.0	∞
Response Time	± 0.8	Normal	$\sqrt{3}$	1	± 0.5	∞
Integration time	± 2.6	Rectangular	$\sqrt{3}$	1	± 1.5	∞
RF Ambient Conditions	± 3.0	Rectangular	$\sqrt{3}$	1	± 1.7	∞
Probe Positioner Mech. Tolerance	± 0.4	Rectangular	$\sqrt{3}$	1	± 0.2	∞
Probe Positioning with respect to Phantom Shell	± 2.9	Rectangular	$\sqrt{3}$	1	± 1.7	∞
Extrapolation and Interpolation Algorithms for Max. SAR Evaluation	± 1.0	Rectangular	$\sqrt{3}$	1	± 0.6	∞
Test sample Related						
Test sample Positioning	± 2.9	Normal	1	1	± 2.9	145
Device Holder Uncertainty	± 3.6	Normal	1	1	± 3.6	5
Output Power Variation-SAR drift measurement	± 2.5	Rectangular	$\sqrt{3}$	1	± 1.4	∞
Phantom and Tissue parameters						
Phantom uncertainty(Including shape and thickness tolerances)	± 4.0	Rectangular	$\sqrt{3}$	1	± 2.3	∞
Liquid Conductivity Target tolerance	± 5.0	Rectangular	$\sqrt{3}$	0.64	± 1.8	∞
Liquid Conductivity measurement uncertainty	± 2.5	Normal	1	0.64	± 1.6	∞
Liquid Permittivity Target tolerance	± 5.0	Rectangular	$\sqrt{3}$	0.6	± 1.7	∞
Liquid Permittivity measurement uncertainty	± 2.0	Normal	1	0.6	± 1.2	∞
Combined standard uncertainty					± 10.3	330
Coverage Factor for 95 %		K=2				
Expanded uncertainty (Coverage factor = 2)					± 20.6	

Table 7.2. Uncertainty Budget of DASY

8. SAR Measurement Evaluation

Each DASY system is equipped with one or more system validation kits. These units, together with the predefined measurement procedures within the DASY software, enable the user to conduct the system performance check and system validation. System validation kit includes a dipole, tripod holder to fix it underneath the flat phantom and a corresponding distance holder.

8.1 Purpose of System Performance check

The system performance check verifies that the system operates within its specifications. System and operator errors can be detected and corrected. It is recommended that the system performance check be performed prior to any usage of the system in order to guarantee reproducible results. The system performance check uses normal SAR measurements in a simplified setup with a well characterized source. This setup was selected to give a high sensitivity to all parameters that might fail or vary over time. The system check does not intend to replace the calibration of the components, but indicates situations where the system uncertainty is exceeded due to drift or failure.

8.2 System Setup

In the simplified setup for system evaluation, the DUT is replaced by a calibrated dipole and the power source is replaced by a continuous wave which comes from a signal generator at frequency 1900 MHz. The calibrated dipole must be placed beneath the flat phantom section of the SAM twin phantom with the correct distance holder. The distance holder should touch the phantom surface with a light pressure at the reference marking and be oriented parallel to the long side of the phantom. The equipment setup is shown below:

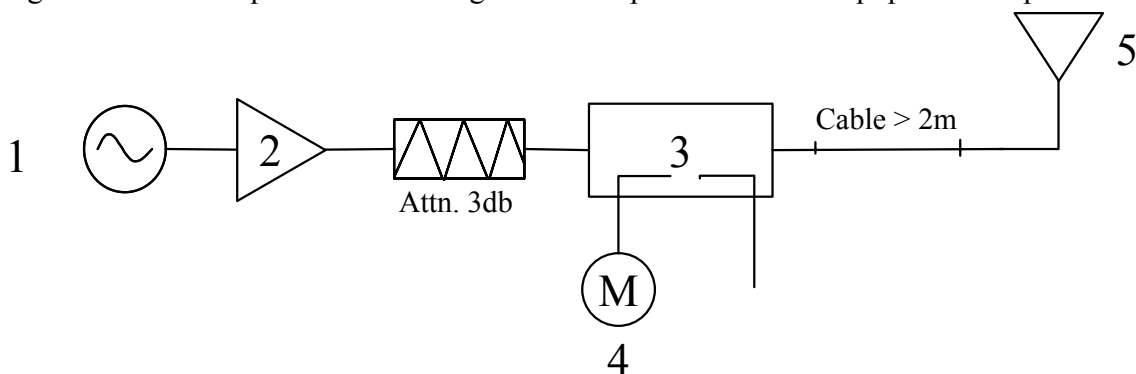

Fig. 8.1



1. Signal Generator
2. Amplifier
3. Directional Coupler
4. Power Meter
5. 1900 MHz Dipole

The output power on dipole port must be calibrated to 20dBm (100mW) before dipole is connected.

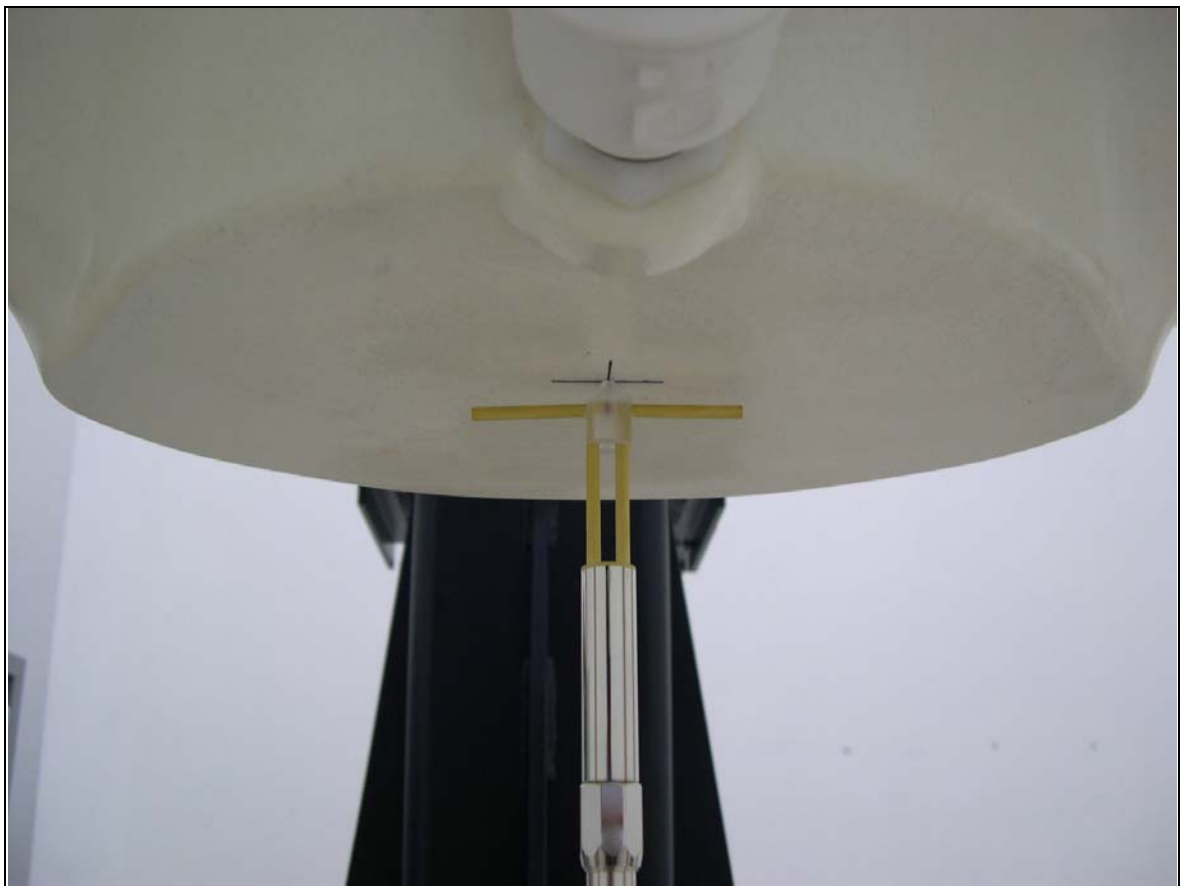

Fig 8.2 Dipole Setup



8.3 Validation Results

Comparing to the original SAR value provided by Speag, the validation data should be within its specification of 10 %. Table 8.1 shows the target SAR and measured SAR after normalized to 1W input power.

		Target (W/kg)	Measurement data (W/kg)	Variation
PCS band (1900MHz) for head	SAR (1g)	41.6	42.8	2.9 %
	SAR (10g)	21.6	22.3	3.2 %
PCS band (1900MHz) for body	SAR (1g)	42	41.7	-0.7 %
	SAR (10g)	22	22.3	1.4 %

Table 8.3

The table above indicates the system performance check can meet the variation criterion.



9. Description for DUT Testing Position

This DUT was tested in 6 different positions. They are left cheek, left tilted, right cheek, right tilted, body worn with keypad up and body worn with keypad down as illustrated below:

- 1) “Cheek Position”
 - i) To position the device with the vertical center line of the body of the device and the horizontal line crossing the center piece in a plane parallel to the sagittal plane of the phantom. While maintaining the device in this plane, align the vertical center line with the reference plane containing the three ear and mouth reference point (M, RE and LE) and align the center of the ear piece with the line RE-LE.
 - ii) To move the device towards the phantom with the ear piece aligned with the line LE-RE until the phone touched the ear. While maintaining the device in the reference plane and maintaining the phone contact with the ear, move the bottom of the phone until any point on the front side is in contact with the cheek of the phantom or until contact with the ear is lost (see Fig. 9.1).
- 2) “Tilted Position”
 - i) To position the device in the “cheek” position described above
 - ii) While maintaining the device the reference plane described above and pivoting against the ear, move it outward away from the mouth by an angle of 15 degrees or until contact with the ear is lost (see Fig. 9.2).
- 3) “Body Worn”
 - i) To position the device parallel to the phantom surface with either keypad up or down
 - ii) To adjust the DUT height to keep the 1.5 cm gap between DUT surface and the phantom.

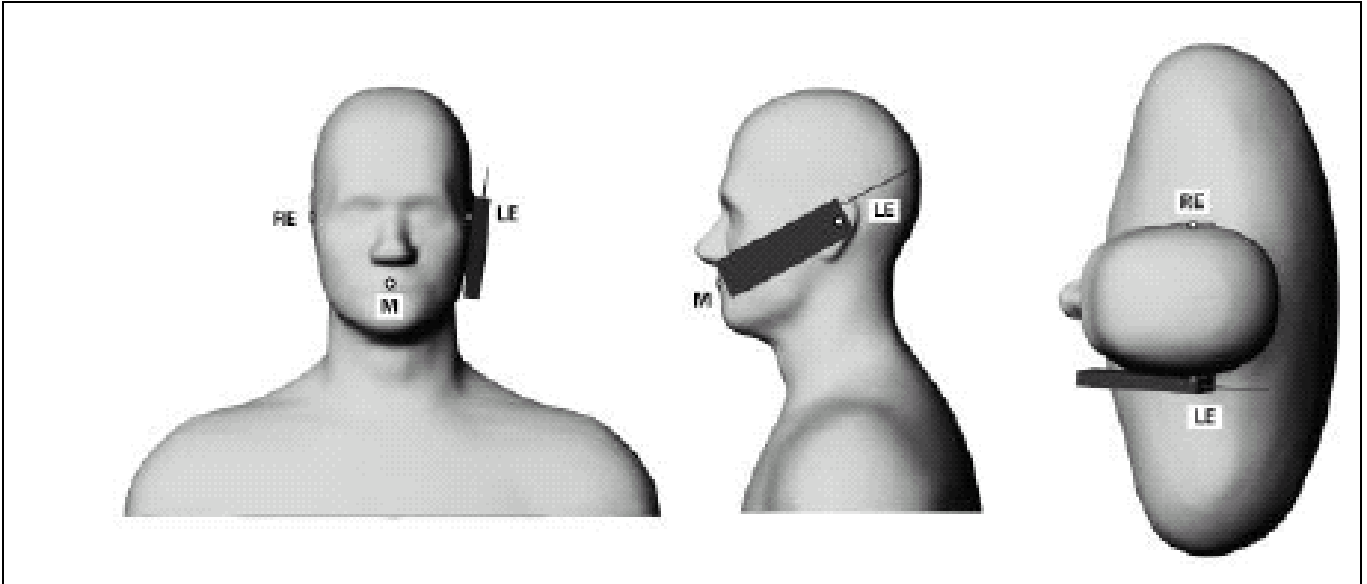

Fig. 9.1 Phone Position 1, “Cheek” or “Touch” Position. The reference points for the right ear (RE), left ear (LE) and mouth (M), which define the plane for phone positioning, are indicated.

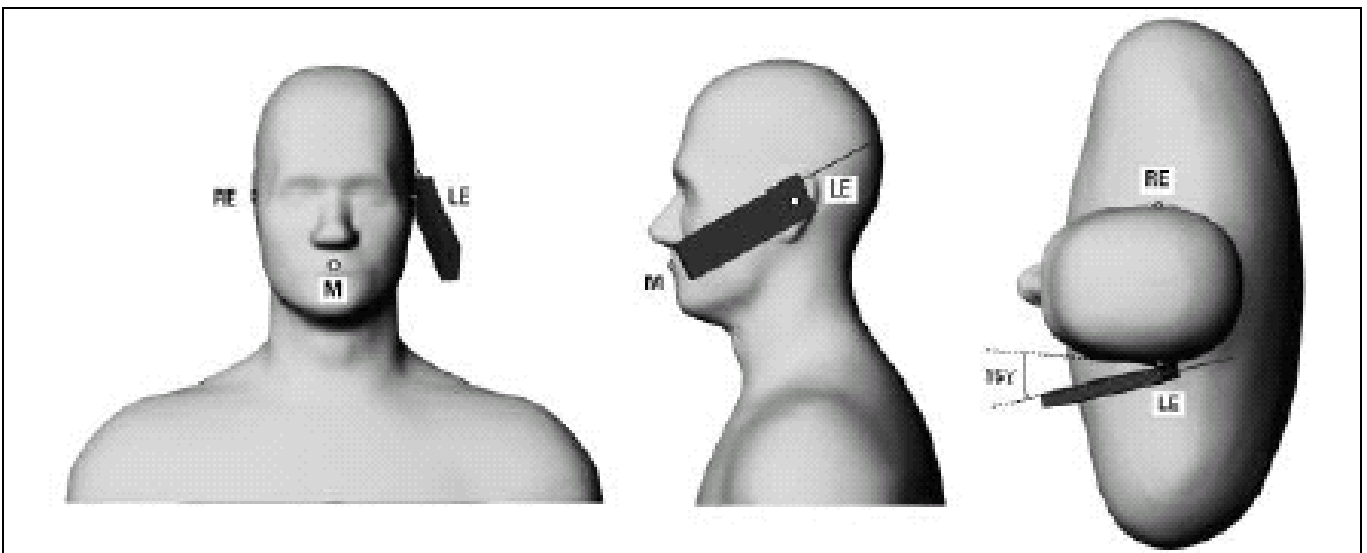

Fig. 9.2 Phone Position 2, “Tilted Position”. The reference point for the right ear (RE), left ear (LE) and mouth (M), which define the plane for phone positioning, are indicated.



Fig. 9.3 Right Cheek

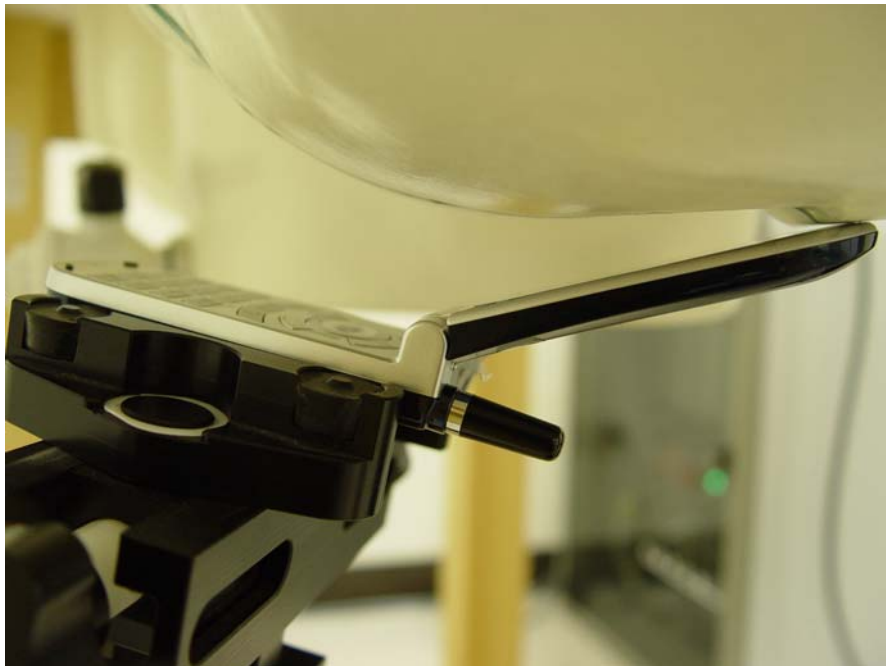

Fig. 9.4 Right Tilted



Fig. 9.5 Left Cheek

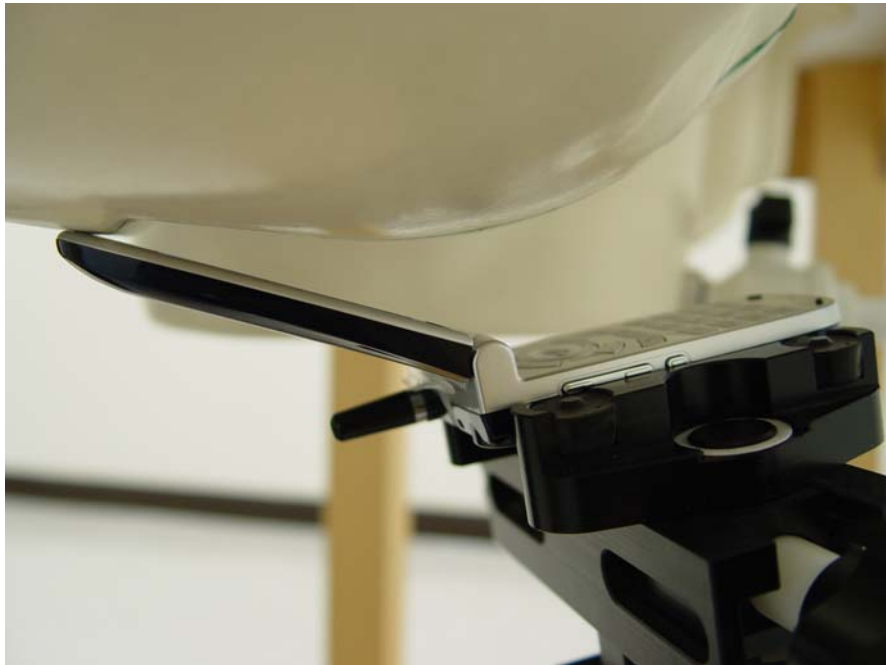

Fig. 9.6 Left Tilted

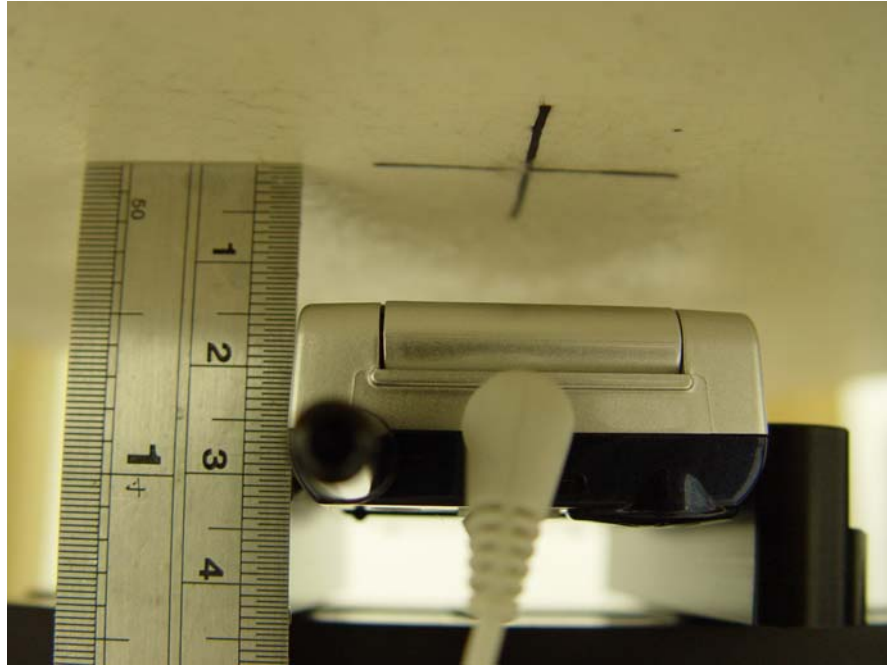

Fig. 9.7 Body Worn-keypad up



Fig. 9.8 Body Worn-keypad down



10. Measurement Procedures

The measurement procedures are as follows:

- Linking DUT with base station emulator CMU200 in middle channel for PCS band
- Setting PCL=0 for PCS on CMU200 to allow DUT to radiate maximum output power
- Measuring output power through RF cable and power meter
- Placing the DUT in the positions described in the last section
- Setting scan area, grid size and other setting on the DASY4 software
- Taking data for the lowest, middle, and highest channel on each testing position

According to the IEEE P1528 draft standard, the recommended procedure for assessing the peak spatial-average SAR value consists of the following steps:

- Power reference measurement
- Area scan
- Zoom scan
- Power reference measurement

10.1 Spatial Peak SAR Evaluation

The procedure for spatial peak SAR evaluation has been implemented according to the IEEE1528-200X standard. It can be conducted for 1g and 10g, as well as for user-specific masses. The DASY4 software includes all numerical procedures necessary to evaluate the spatial peak SAR value.

Base on the Draft: SCC-34, SC-2, WG-2-Computational Dosimetry, IEEE P1528/D0.0 (Draft recommended Practice for Determining the Spatial-Peak Specific Absorption Rate (SAR) Associated with the Use of Wireless Handset-Computational techniques), a new algorithm has been implemented. The spatial-peak SAR can be computed over any required mass.

The base for the evaluation is a "cube" measurement. The measured volume must include the 1g and 10g cubes with the highest averaged SAR values. For that purpose, the center of the measured volume is aligned to the interpolated peak SAR value of a previously performed area scan.

The entire evaluation of the spatial peak values is performed within the postprocessing engine (SEMCAD). The system always gives the maximum values for the 1g and 10g cubes. The algorithm to find the cube with highest averaged SAR is divided into the following stages:

- extraction of the measured data (grid and values) from the Zoom Scan
- calculation of the SAR value at every measurement point based on all stored data (A/D values and measurement parameters)



-
- generation of a high-resolution mesh within the measured volume
 - interpolation of all measured values from the measurement grid to the high-resolution grid
 - extrapolation of the entire 3-D field distribution to the phantom surface over the distance from sensor to surface
 - calculation of the averaged SAR within masses of 1g and 10g

10.2 Scan Procedures

First **Area Scan** is used to locate the approximate location(s) of the local peak SAR value(s). The measurement grid within an **Area Scan** is defined by the grid extent, grid step size and grid offset. Next, in order to determine the EM field distribution in a three-dimensional spatial extension, **Zoom Scan** is required. The **Zoom Scan** measures 5x5x7 points with step size 8, 8 and 5 mm. The **Zoom Scan** is performed around the highest E-field value to determine the averaged SAR-distribution over 1 g.

10.3 SAR Averaged Methods

In DASY4, the interpolation and extrapolation are both based on the modified Quadratic Shepard's method. The interpolation scheme combines a least-square fitted function method and a weighted average method which are the two basic types of computational interpolation and approximation.

Extrapolation routines are used to obtain SAR values between the lowest measurement points and the inner phantom surface. The extrapolation distance is determined by the surface detection distance and the probe sensor offset. The uncertainty increases with the extrapolation distance. To keep the uncertainty within 1% for the 1 g and 10 g cubes, the extrapolation distance should not be larger than 5 mm.



11. SAR Test Results

11.1 Right Cheek

Bands	Chan.	Freq. (MHz)	Modulation type	Conducted Power (dBm)	Power Drift (dB)	Measured 1g SAR (W/kg)	Limits (W/Kg)	Results
PCS	512 (Low)	1850.2	GMSK	29.08	-0.005	0.657	1.6	Pass
	661 (Mid)	1880.0	GMSK	28.8	0.05	0.698	1.6	Pass
	810 (High)	1909.8	GMSK	28.62	-0.08	0.724	1.6	Pass

11.2 Right Tilted

Bands	Chan.	Freq. (MHz)	Modulation type	Conducted Power (dBm)	Power Drift (dB)	Measured 1g SAR (W/kg)	Limits (W/Kg)	Results
PCS	512 (Low)	1850.2	GMSK	29.08	-0.1	0.0484	1.6	Pass
	661 (Mid)	1880.0	GMSK	28.8	-0.09	0.0495	1.6	Pass
	810 (High)	1909.8	GMSK	28.62	-0.02	0.0579	1.6	Pass

11.3 Left Cheek

Bands	Chan.	Freq. (MHz)	Modulation type	Conducted Power (dBm)	Power Drift (dB)	Measured 1g SAR (W/kg)	Limits (W/Kg)	Results
PCS	512 (Low)	1850.2	GMSK	29.08	0.00003	0.356	1.6	Pass
	661 (Mid)	1880.0	GMSK	28.8	-0.07	0.282	1.6	Pass
	810 (High)	1909.8	GMSK	28.62	-0.2	0.247	1.6	Pass

11.4 Left Tilted

Bands	Chan.	Freq. (MHz)	Modulation type	Conducted Power (dBm)	Power Drift (dB)	Measured 1g SAR (W/kg)	Limits (W/Kg)	Results
PCS	512 (Low)	1850.2	GMSK	29.08	-0.008	0.0424	1.6	Pass
	661 (Mid)	1880.0	GMSK	28.8	-0.08	0.0421	1.6	Pass
	810 (High)	1909.8	GMSK	28.62	-0.08	0.0543	1.6	Pass



11.5 Body Worn-keypad up

Bands	Chan.	Freq. (MHz)	Modulation type	Conducted Power (dBm)	Power Drift (dB)	Measured 1g SAR (W/kg)	Limits (W/Kg)	Results
PCS	512 (Low)	1850.2	GMSK	29.08	-	-	-	Pass
	661 (Mid)	1880.0	GMSK	28.8	0.005	0.0475	1.6	Pass
	810 (High)	1909.8	GMSK	28.62	-	-	-	Pass

11.6 Body Worn-keypad down

Bands	Chan.	Freq. (MHz)	Modulation type	Conducted Power (dBm)	Power Drift (dB)	Measured 1g SAR (W/kg)	Limits (W/Kg)	Results
PCS	512 (Low)	1850.2	GMSK	29.08	-	-	-	Pass
	661 (Mid)	1880.0	GMSK	28.8	-0.005	0.0776	1.6	Pass
	810 (High)	1909.8	GMSK	28.62	-	-	-	Pass



12. References

- [1] FCC 47 CFR Part 2 “Frequency Allocations and Radio Treaty Matters; General Rules and Regulations”
- [2] IEEE Std. 1528-200X, Draft CD 1.1 “ Recommended Practice for Determining the Spatial-Peak Specific Absorption Rate (SAR) in the Human Body Due to Wireless Communications Devices: Experimental Techniques”, December 2002
- [3] Supplement C (Edition 01-10) to OET Bulletin 65 (Edition 97-01), “Additional Information for Evaluating Compliance of Mobile and Portable Devices with FCC Limits for Human Exposure to RF Emissions”, June 2001
- [4] IEEE Std. C95.3, “IEEE Recommended Practice for the Measurement of Potentially Hazardous Electromagnetic Fields-RF and Microwave”, 1991
- [5] IEEE Std. C95.1, “IEEE Standard for Safety Levels with Respect to Human Exposure to Radio Frequency Electromagnetic Fields, 3 kHz to 300 GHz”, 1999
- [6] Robert J. Renka, “Multivariate Interpolation Of Large Sets Of Scattered Data”, University of North Texas ACM Transactions on Mathematical Software, vol. 14, no. 2, June 1988, pp. 139-148
- [7] DAYS4 System Handbook



Appendix A - System Performance Check Data

Test Laboratory: Sporton International Inc. SAR Testing Lab

Date/Time: 05/11/04 17:55:33

File Name: System Check Head_1900MHz_20040511.da4

DUT: Dipole 1900 MHz; Type: D1900V2; Serial: D1900V2 - SN:5d041
Program Name: System Performance Check

Communication System: CW; Frequency: 1900 MHz; Duty Cycle: 1:1
Medium: HSL1900 ($\sigma = 1.45767$ mho/m, $\epsilon_r = 39.4074$, $\rho = 1000$ kg/m³)
Phantom section: Flat Section

DASY4 Configuration:

- Probe: ET3DV6 - SN1788; ConvF(5.3, 5.3, 5.3); Calibrated: 8/29/2003
- Sensor-Surface: 4mm (Mechanical And Optical Surface Detection)
- Sensor-Surface: 4mm (Mechanical Surface Detection)
- Electronics: DAE3 Sn577; Calibrated: 11/21/2003
- Phantom: SAM 12; Type: QD 000 P40 C; Serial: TP-1150
- Measurement SW: DASY4, V4.1 Build 47; Postprocessing SW: SEMCAD, V1.6 Build 116

Pin=100mW/Area Scan (61x61x1): Measurement grid: dx=15mm, dy=15mm

Reference Value = 60.3 V/m

Power Drift = -0.02 dB

Maximum value of SAR = 4.86 mW/g

Pin=100mW/Zoom Scan (7x7x7)/Cube 0: Measurement grid: dx=5mm, dy=5mm, dz=5mm

Peak SAR (extrapolated) = 7.35 W/kg

SAR(1 g) = 4.28 mW/g; SAR(10 g) = 2.23 mW/g

Reference Value = 60.3 V/m

Power Drift = -0.02 dB

Maximum value of SAR = 4.75 mW/g

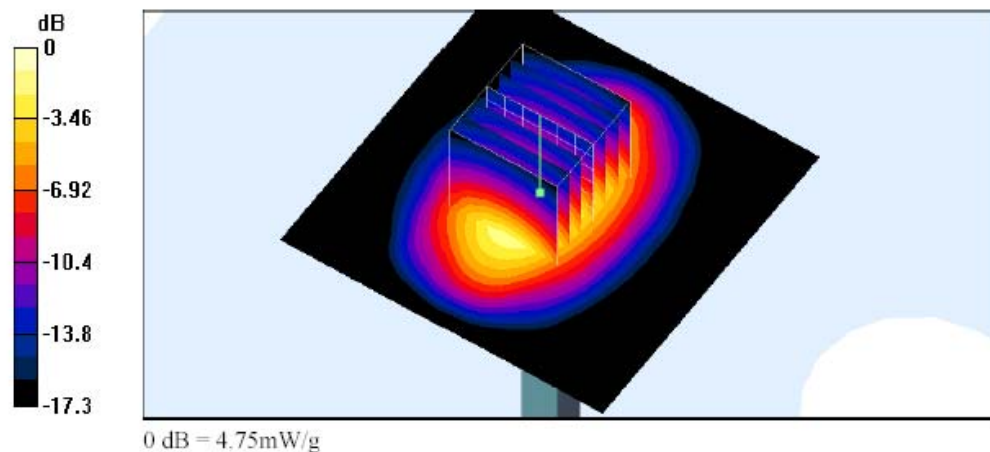



Test Laboratory: Sporton International Inc. SAR Testing Lab

Date/Time: 05/12/04 13:30:18

File Name: System Check Body 1900MHz 20040512.da4

DUT: Dipole 1900 MHz; Type: D1900V2; Serial: D1900V2 - SN:5d041
Program Name: System Performance Check

Communication System: CW; Frequency: 1900 MHz; Duty Cycle: 1:1
Medium: MSL1900 ($\sigma = 1.54443$ mho/m, $\epsilon_r = 52.1182$, $\rho = 1000$ kg/m³)
Phantom section: Flat Section

DASY4 Configuration:

- Probe: ET3DV6 - SN1788; ConvF(5, 5, 5); Calibrated: 8/29/2003
- Sensor-Surface: 4mm (Mechanical And Optical Surface Detection)
- Sensor-Surface: 4mm (Mechanical Surface Detection)
- Electronics: DAE3 Sn577; Calibrated: 11/21/2003
- Phantom: SAM 12; Type: QD 000 P40 C; Serial: TP-1150
- Measurement SW: DASY4, V4.1 Build 47; Postprocessing SW: SEMCAD, V1.6 Build 116

Pin=20mW/Area Scan (61x61x1): Measurement grid: dx=15mm, dy=15mm

Reference Value = 57.2 V/m

Power Drift = -0.01 dB

Maximum value of SAR = 4.69 mW/g

Pin=20mW/Zoom Scan (7x7x7)/Cube 0: Measurement grid: dx=5mm, dy=5mm, dz=5mm

Peak SAR (extrapolated) = 6.96 W/kg

SAR(1 g) = 4.17 mW/g; SAR(10 g) = 2.23 mW/g

Reference Value = 57.2 V/m

Power Drift = -0.01 dB

Maximum value of SAR = 4.7 mW/g

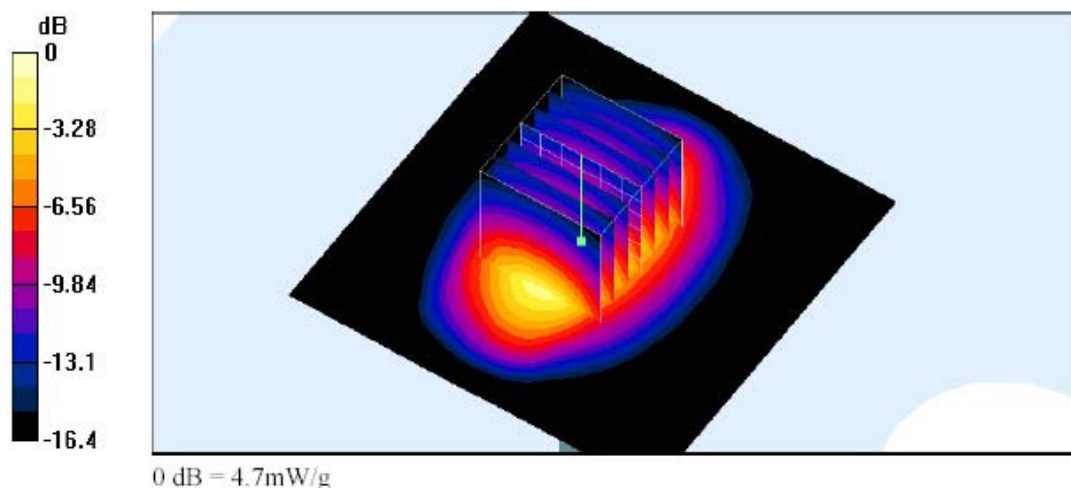



Appendix B - SAR Measurement Data

Test Laboratory: Sporton International Inc. SAR Testing Lab

Date/Time: 05/11/04 18:35:21

File Name: Right Check_PCS Ch512_20040511.da4

DUT: SeaQuad Abalone 200; Type: GSM Mobile Phone; Serial: 446019197507590
Program Name: Right Check

Communication System: DCS 1900; Frequency: 1850.2 MHz; Duty Cycle: 1:8.3

Medium: HSL1900 ($\sigma = 1.41386$ mho/m, $\epsilon_r = 39.5119$, $\rho = 1000$ kg/m³)

Phantom section: Right Section

DASY4 Configuration:

- Probe: ET3DV6 - SN1788; ConvF(5.3, 5.3, 5.3); Calibrated: 8/29/2003

- Sensor-Surface: 4mm (Mechanical And Optical Surface Detection)

- Electronics: DAE3 Sn577; Calibrated: 11/21/2003

- Phantom: SAM 12; Type: QD 000 P40 C; Serial: TP-1150

- Measurement SW: DASY4, V4.1 Build 47; Postprocessing SW: SEMCAD, V1.6 Build 116

Ch512/Area Scan (51x101x1): Measurement grid: dx=15mm, dy=15mm

Reference Value = 5.74 V/m

Power Drift = -0.005 dB

Maximum value of SAR = 0.71 mW/g

Ch512/Zoom Scan (5x5x7)/Cube 0: Measurement grid: dx=8mm, dy=8mm, dz=5mm

Peak SAR (extrapolated) = 0.835 W/kg

SAR(1 g) = 0.657 mW/g; SAR(10 g) = 0.441 mW/g

Reference Value = 5.74 V/m

Power Drift = -0.005 dB

Maximum value of SAR = 0.707 mW/g

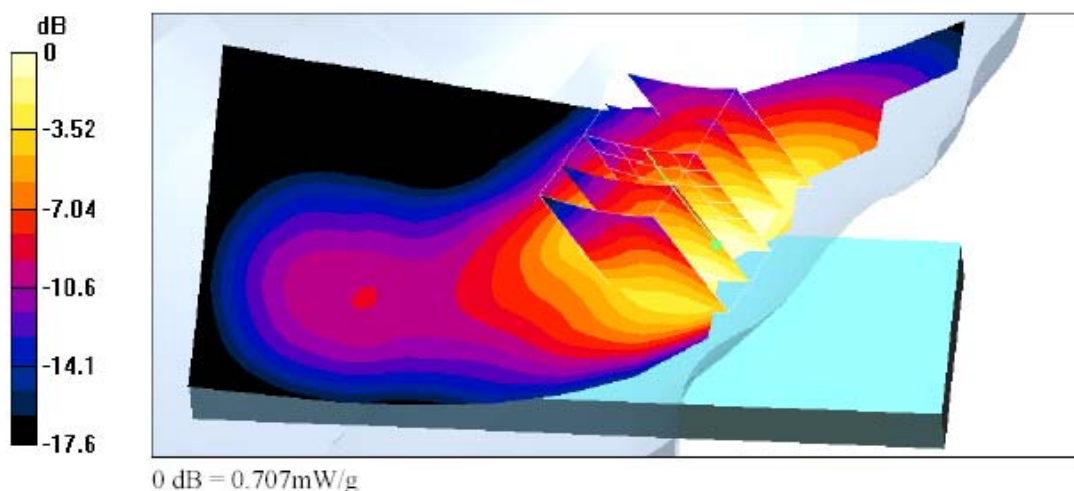



Test Laboratory: Sporton International Inc. SAR Testing Lab

Date/Time: 05/11/04 18:51:34

File Name: Right Cheek_PCS Ch661_20040511.da4

DUT: SeaQuad Abalone 200; Type: GSM Mobile Phone; Serial: 446019197507590
Program Name: Right Cheek

Communication System: DCS 1900; Frequency: 1880 MHz; Duty Cycle: 1:8.3

Medium: HSL 1900 ($\sigma = 1.44056$ mho/m, $\epsilon_r = 39.4725$, $\rho = 1000$ kg/m³)

Phantom section: Right Section

DASY4 Configuration:

- Probe: ET3DV6 - SN1788; ConvF(5.3, 5.3, 5.3); Calibrated: 8/29/2003
- Sensor-Surface: 4mm (Mechanical And Optical Surface Detection)
- Electronics: DAE3 Sn577; Calibrated: 11/21/2003
- Phantom: SAM 12; Type: QD 000 P40 C; Serial: TP-1150
- Measurement SW: DASY4, V4.1 Build 47; Postprocessing SW: SEMCAD, V1.6 Build 116

Ch661/Area Scan (51x101x1): Measurement grid: dx=15mm, dy=15mm

Reference Value = 6.29 V/m

Power Drift = 0.05 dB

Maximum value of SAR = 0.759 mW/g

Ch661/Zoom Scan (5x5x7)/Cube 0: Measurement grid: dx=8mm, dy=8mm, dz=5mm

Peak SAR (extrapolated) = 0.899 W/kg

SAR(1 g) = 0.698 mW/g; SAR(10 g) = 0.466 mW/g

Reference Value = 6.29 V/m

Power Drift = 0.05 dB

Maximum value of SAR = 0.75 mW/g

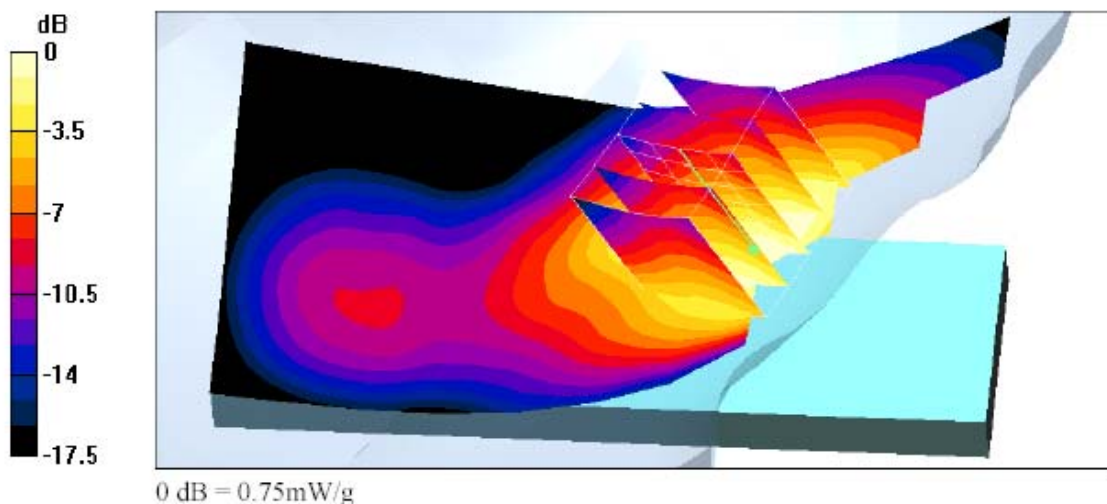



Test Laboratory: Sporton International Inc. SAR Testing Lab

Date/Time: 05/11/04 19:19:07

File Name: Right Cheek_PCS Ch810_20040511.da4

DUT: SeaQuad Abalone 200; Type: GSM Mobile Phone; Serial: 446019197507590
Program Name: Right Cheek

Communication System: DCS 1900; Frequency: 1909.8 MHz; Duty Cycle: 1:8.3

Medium: HSL 1900 ($\sigma = 1.46624$ mho/m, $\epsilon_r = 39.3728$, $\rho = 1000$ kg/m³)

Phantom section: Right Section

DASY4 Configuration:

- Probe: ET3DV6 - SN1788; ConvF(5.3, 5.3, 5.3); Calibrated: 8/29/2003
- Sensor-Surface: 4mm (Mechanical And Optical Surface Detection)
- Electronics: DAE3 Sn577; Calibrated: 11/21/2003
- Phantom: SAM 12; Type: QD 000 P40 C; Serial: TP-1150
- Measurement SW: DASY4, V4.1 Build 47; Postprocessing SW: SEMCAD, V1.6 Build 116

Ch810/Area Scan (51x101x1): Measurement grid: dx=15mm, dy=15mm

Reference Value = 6.89 V/m

Power Drift = -0.08 dB

Maximum value of SAR = 0.782 mW/g

Ch810/Zoom Scan (5x5x7)/Cube 0: Measurement grid: dx=8mm, dy=8mm, dz=5mm

Peak SAR (extrapolated) = 0.945 W/kg

SAR(1 g) = 0.724 mW/g; SAR(10 g) = 0.482 mW/g

Reference Value = 6.89 V/m

Power Drift = -0.08 dB

Maximum value of SAR = 0.779 mW/g

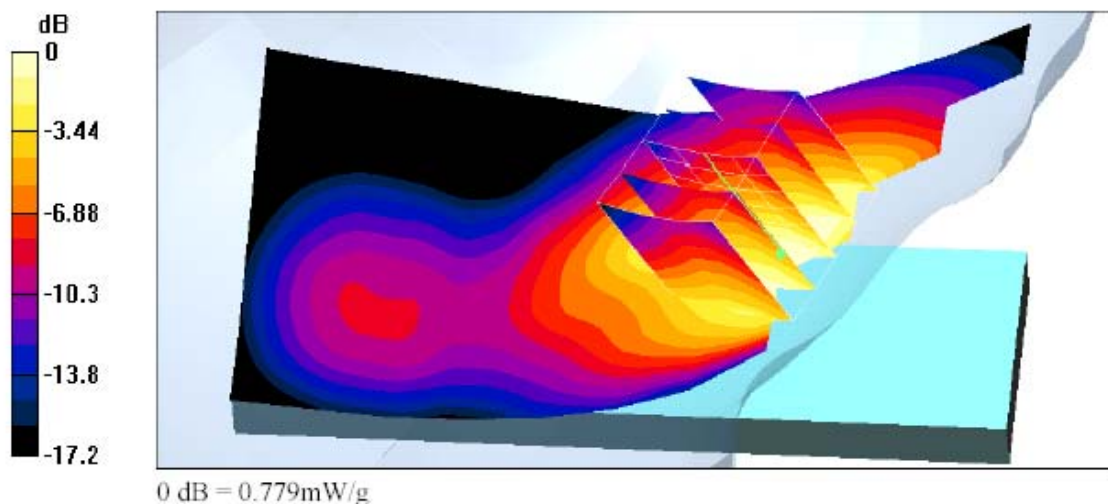



Test Laboratory: Sporton International Inc. SAR Testing Lab

Date/Time: 05/12/04 17:54:24

File Name: Keypad Down With 1.5cm Gap_PCS Ch661_20040512.da4

DUT: SeaQuad Abalone 200; Type: GSM Mobile Phone; Serial: 446019197507590
Program Name: Body_Keypad Down With 1.5cm Gap

Communication System: DCS 1900; Frequency: 1880 MHz; Duty Cycle: 1:8.3

Medium: MSL1900 ($\sigma = 1.56617$ mho/m, $\epsilon_r = 52.2917$, $\rho = 1000$ kg/m³)

Phantom section: Flat Section

DASY4 Configuration:

- Probe: ET3DV6 - SN1788; ConvF(5, 5, 5); Calibrated: 8/29/2003
- Sensor-Surface: 4mm (Mechanical And Optical Surface Detection)
- Electronics: DAE3 Sn577; Calibrated: 11/21/2003
- Phantom: SAM 12; Type: QD 000 P40 C; Serial: TP-1150
- Measurement SW: DASY4, V4.1 Build 47; Postprocessing SW: SEMCAD, V1.6 Build 116

Ch661/Area Scan (51x71x1): Measurement grid: dx=15mm, dy=15mm

Reference Value = 7.16 V/m

Power Drift = -0.005 dB

Maximum value of SAR = 0.0863 mW/g

Ch661/Zoom Scan (5x5x7)/Cube 0: Measurement grid: dx=8mm, dy=8mm, dz=5mm

Peak SAR (extrapolated) = 0.123 W/kg

SAR(1 g) = 0.0776 mW/g; SAR(10 g) = 0.0458 mW/g

Reference Value = 7.16 V/m

Power Drift = -0.005 dB

Maximum value of SAR = 0.0814 mW/g

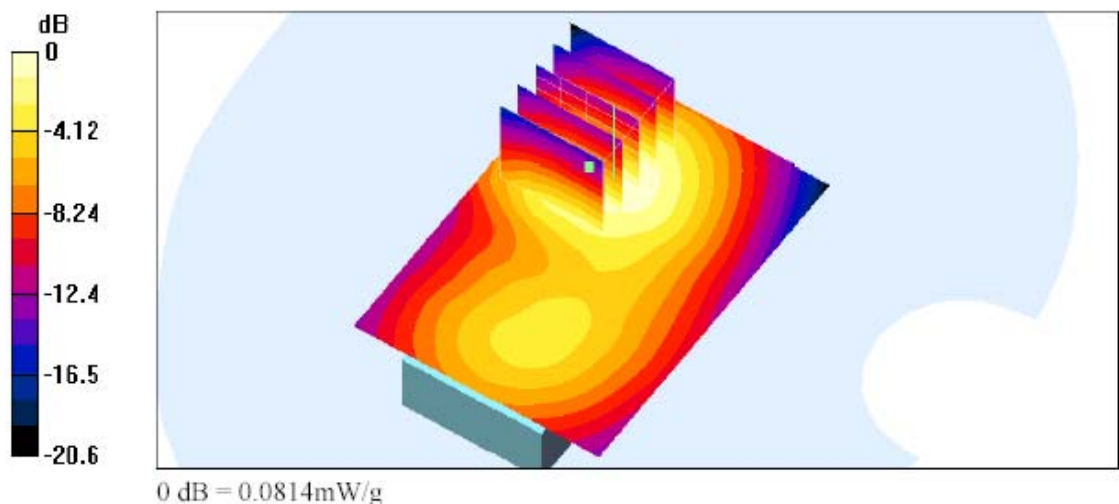



Test Laboratory: Sporton International Inc. SAR Testing Lab

Date/Time: 05/11/04 19:19:07

File Name: Right Cheek_PCS Ch810_20040511.da4

DUT: SeaQuad Abalone 200; Type: GSM Mobile Phone; Serial: 446019197507590
Program Name: Right Cheek

Communication System: DCS 1900; Frequency: 1909.8 MHz; Duty Cycle: 1:8.3

Medium: HSL1900 ($\sigma = 1.46624$ mho/m, $\epsilon_r = 39.3728$, $\rho = 1000$ kg/m³)

Phantom section: Right Section

DASY4 Configuration:

- Probe: ET3DV6 - SN1788; ConvF(5.3, 5.3, 5.3); Calibrated: 8/29/2003
- Sensor-Surface: 4mm (Mechanical And Optical Surface Detection)
- Electronics: DAE3 Sn577; Calibrated: 11/21/2003
- Phantom: SAM 12; Type: QD 000 P40 C; Serial: TP-1150
- Measurement SW: DASY4, V4.1 Build 47; Postprocessing SW: SEMCAD, V1.6 Build 116

Ch810/Area Scan (51x101x1): Measurement grid: dx=15mm, dy=15mm

Reference Value = 6.89 V/m

Power Drift = -0.08 dB

Maximum value of SAR = 0.782 mW/g

Ch810/Zoom Scan (5x5x7)/Cube 0: Measurement grid: dx=8mm, dy=8mm, dz=5mm

Peak SAR (extrapolated) = 0.945 W/kg

SAR(1 g) = 0.724 mW/g; SAR(10 g) = 0.482 mW/g

Reference Value = 6.89 V/m

Power Drift = -0.08 dB

Maximum value of SAR = 0.779 mW/g

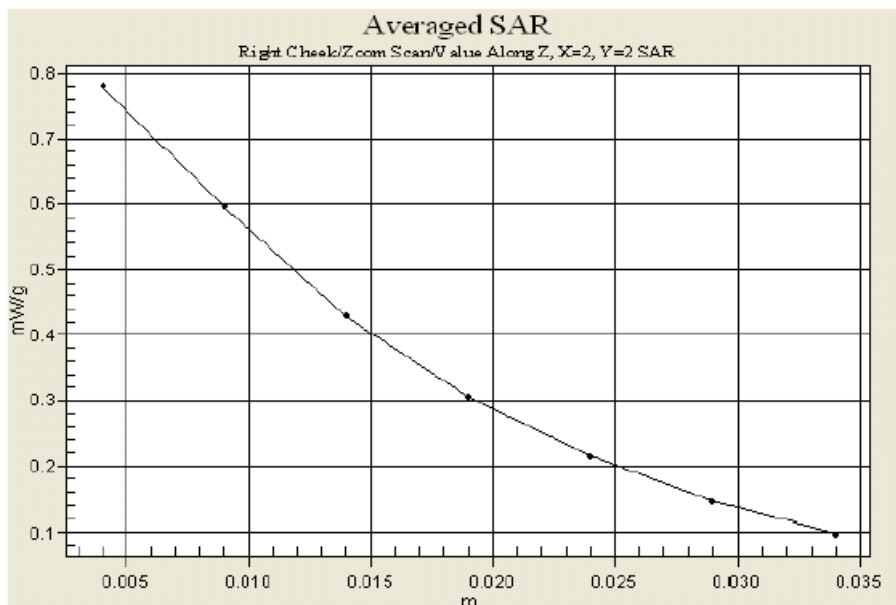



Appendix C – Calibration Data

Calibration Laboratory of
Schmid & Partner
Engineering AG
Zeughausstrasse 43, 8004 Zurich, Switzerland

Client **Sproton Int. (Auden)**

CALIBRATION CERTIFICATE			
Object(s)	D1900V2 - SN:5d041		
Calibration procedure(s)	QA CAL-05 v2 Calibration procedure for dipole validation kits		
Calibration date:	February:17, 2004		
Condition of the calibrated item	In Tolerance (according to the specific calibration document)		
This calibration statement documents traceability of M&TE used in the calibration procedures and conformity of the procedures with the ISO/IEC 17025 international standard.			
All calibrations have been conducted in the closed laboratory facility: environment temperature 22 +/- 2 degrees Celsius and humidity < 75%.			
Calibration Equipment used (M&TE critical for calibration)			
Model Type	ID #	Cal Date (Calibrated by, Certificate No.)	Scheduled Calibration
Power meter EPM E442	GB37480704	6-Nov-03 (METAS, No. 252-0254)	Nov-04
Power sensor HP 8481A	US37292783	6-Nov-03 (METAS, No. 252-0254)	Nov-04
Power sensor HP 8481A	MY41092317	18-Oct-02 (Agilent, No. 20021018)	Oct-04
RF generator R&S SML-03	100698	27-Mar-2002 (R&S, No. 20-92389)	In house check: Mar-05
Network Analyzer HP 8753E	US37390585	18-Oct-01 (SPEAG, In house check Nov-03)	In house check: Oct 05
Calibrated by:	Name Judith Mueller	Function Technician	Signature
Approved by:	Name Katja Pokovic	Function Laboratory Director	Signature
Date issued: February 18, 2004			
This calibration certificate is issued as an intermediate solution until the accreditation process (based on ISO/IEC 17025 International Standard) for Calibration Laboratory of Schmid & Partner Engineering AG is completed.			



Schmid & Partner Engineering AG

s p e a g

Zeughausstrasse 43, 8004 Zurich, Switzerland
Phone +41 1 245 9700, Fax +41 1 245 9779
info@speag.com, http://www.speag.com

DASY

Dipole Validation Kit

Type: D1900V2

Serial: 5d041

Manufactured: July 4, 2003

Calibrated: February 17, 2004



1. Measurement Conditions

The measurements were performed in the flat section of the SAM twin phantom filled with **head simulating liquid** of the following electrical parameters at 1900 MHz:

Relative Dielectricity	38.8	± 5%
Conductivity	1.47 mho/m	± 5%

The DASY4 System with a dosimetric E-field probe ET3DV6 (SN:1507, Conversion factor 4.96 at 1900 MHz) was used for the measurements.

The dipole was mounted on the small tripod so that the dipole feedpoint was positioned below the center marking of the flat phantom section and the dipole was oriented parallel to the body axis (the long side of the phantom). The standard measuring distance was 10mm from dipole center to the solution surface. The included distance spacer was used during measurements for accurate distance positioning.

The coarse grid with a grid spacing of 15mm was aligned with the dipole. The 7x7x7 fine cube was chosen for cube integration.

The dipole input power (forward power) was 250mW ± 3 %. The results are normalized to 1W input power.

2. SAR Measurement with DASY4 System

Standard SAR-measurements were performed according to the measurement conditions described in section 1. The results (see figure supplied) have been normalized to a dipole input power of 1W (forward power). The resulting averaged SAR-values measured with the dosimetric probe ET3DV6 SN:1507 and applying the advanced extrapolation are:

averaged over 1 cm ³ (1 g) of tissue:	41.6 mW/g ± 16.8 % (k=2)¹
averaged over 10 cm ³ (10 g) of tissue:	21.6 mW/g ± 16.2 % (k=2)¹

¹ validation uncertainty



3. Dipole Impedance and Return Loss

The impedance was measured at the SMA-connector with a network analyzer and numerically transformed to the dipole feedpoint. The transformation parameters from the SMA-connector to the dipole feedpoint are:

Electrical delay: **1.200 ns** (one direction)
Transmission factor: **0.993** (voltage transmission, one direction)

The dipole was positioned at the flat phantom sections according to section 1 and the distance spacer was in place during impedance measurements.

Feedpoint impedance at 1900 MHz: $Re\{Z\} = 51.2 \Omega$
 $Im\{Z\} = 4.9\Omega$
Return Loss at 1900 MHz: **-26.1 dB**

4. Measurement Conditions

The measurements were performed in the flat section of the SAM twin phantom filled with **body simulating tissue** of the following electrical parameters at 1900 MHz:

Relative Dielectricity **52.5** $\pm 5\%$
Conductivity **1.58 mho/m** $\pm 5\%$

The DASY4 System with a dosimetric E-field probe ET3DV6 (SN:1507, Conversion factor 4.57 at 1900 MHz) was used for the measurements.

The dipole was mounted on the small tripod so that the dipole feedpoint was positioned below the center marking of the flat phantom section and the dipole was oriented parallel to the body axis (the long side of the phantom). The standard measuring distance was 10mm from dipole center to the solution surface. The included distance spacer was used during measurements for accurate distance positioning.

The coarse grid with a grid spacing of 15mm was aligned with the dipole. The 7x7x7 fine cube was chosen for cube integration.
The dipole input power (forward power) was 250mW $\pm 3\%$. The results are normalized to 1W input power.



5. SAR Measurement with DASY4 System

Standard SAR-measurements were performed according to the measurement conditions described in section 4. The results (see figure supplied) have been normalized to a dipole input power of 1W (forward power). The resulting averaged SAR-values measured with the dosimetric probe ET3DV6 SN:1507 and applying the advanced extrapolation are:

averaged over 1 cm³ (1 g) of tissue: **42.0 mW/g ± 16.8 % (k=2)²**

averaged over 10 cm³ (10 g) of tissue: **22.0 mW/g ± 16.2 % (k=2)²**

6. Dipole Impedance and Return Loss

The dipole was positioned at the flat phantom sections according to section 4 and the distance spacer was in place during impedance measurements.

Feedpoint impedance at 1900 MHz: **Re{Z} = 46.6 Ω**

Im {Z} = 5.1 Ω

Return Loss at 1900 MHz **-24.0 dB**

7. Handling

Do not apply excessive force to the dipole arms, because they might bend. Bending of the dipole arms stresses the soldered connections near the feedpoint leading to a damage of the dipole.

8. Design

The dipole is made of standard semirigid coaxial cable. The center conductor of the feeding line is directly connected to the second arm of the dipole. The antenna is therefore short-circuited for DC-signals.

Small end caps have been added to the dipole arms in order to improve matching when loaded according to the position as explained in Section 1. The SAR data are not affected by this change. The overall dipole length is still according to the Standard.

9. Power Test

After long term use with 40W radiated power, only a slight warming of the dipole near the feedpoint can be measured.

² validation uncertainty