

# RF TEST REPORT

## FCC / ISED

APPLICANT

**Identiv, Inc**

MODEL NAME

**uTrust 5501 F**

DERIVATIVE MODEL NAMES

**uTrust 5501 F HF+LF**

**uTrust 5501 F HF+LF DTC**

**uTrust 5501 F HF**

**uTrust 5501 F LF**

REPORT NUMBER

**HA200605-IDE-002-R01**

# TEST REPORT

**Date of Issue**  
November 11, 2020

**Test Site**  
Hyundai C-Tech, Inc. dba HCT America, Inc.  
1726 Ringwood Ave, San Jose, CA 95131, USA

<b>Applicant</b>	Identiv, Inc
<b>Applicant Address</b>	2201 Walnut Avenue, Suite #100, Fremont, CA 94538, USA
<b>Model Name</b>	uTrust 5501 F
<b>EUT Type</b>	USB RFID Reader Module
<b>Modulation Type</b>	13.56 MHz (ASK), 125 kHz (ASK, PSK, FSK)
<b>FCC Classification</b>	Low Power Communication Device Transmitter
<b>FCC Rule Part(s)</b>	Part 15.225, Part 15.209, Part 15.207
<b>ISED Rule Part(s)</b>	RSS-210 Issue 10 (December 2019), RSS-Gen Issue 5(April 2018)

The device bearing the trade name and model specified above, has been shown to comply with the applicable technical standards as indicated in the measurement report and was tested in accordance with the measurement procedures required. The results of testing in this report apply only to the product which was tested. Other similar equipment will not necessarily produce the same results due to production tolerance and measurement uncertainties.

I attest to the accuracy of data. All measurements reported herein were performed by me or were made under my supervision and are correct to the best of my knowledge and belief. I assume full responsibility for the completeness of these measurements and vouch for the qualifications of all persons taking them.

Hyundai C-Tech, Inc. dba HCT America, Inc. certifies that no party to application has been denied the FCC benefits pursuant to Section 5301 of the Anti-Drug Abuse Act of 1988, 21 U.S.C 862

**Tested By**

Steve In

Test Engineer

**Reviewed By**

Sunwoo Kim

Technical Manager

## REVISION HISTORY

*The revision history for this document is shown in table.*

TEST REPORT NO.	DATE	DESCRIPTION
HA200605-IDE-002-R01	11/11/2020	Initial Issue

## TABLE OF CONTENTS

1. GENERAL INFORMATION.....	4
2. METHODOLOGY .....	5
3. INSTRUMENT CALIBRATION .....	5
4. FACILITIES AND ACCREDITATIONS.....	6
5. ANTENNA REQUIREMENTS .....	7
6. MEASUREMENT UNCERTAINTY .....	8
7. DESCRIPTION OF TESTS .....	9
8. SUMMARY OF TEST RESULTS.....	18
9. TEST RESULT.....	19
9.1 20 dB BANDWIDTH / 99% BANDWIDTH.....	19
9.2 FREQUENCY STABILITY.....	21
9.3 RADIATED SPURIOUS EMISSIONS .....	22
9.4. POWERLINE CONDUCTED EMISSIONS.....	32
10. LIST OF TEST EQUIPMENT.....	36
APPENDIX A. TEST SETUP PHOTOS.....	37
APPENDIX B. PHOTOGRAPHS OF EUT.....	38

## 1. GENERAL INFORMATION

### EUT DESCRIPTION

<b>Base Model</b>	uTrust 5501 F		
<b>Derivative Model(s) <sup>(1)</sup></b>	<b>Model</b>	<b>FCC ID</b>	<b>IC ID</b>
	uTrust 5501 F HF+LF uTrust 5501 F HF+LF DTC	MBPUT5501F-01	7485A-5501F01
	uTrust 5501 F HF	MBPUT5501F-01HF	7485A-5501F01HF
	uTrust 5501 F LF	MBPUT5501F-01LF	7485A-5501F01LF
<b>EUT Type</b>	USB RFID Reader Module		
<b>Power Supply</b>	DC 5V, 350 mA		
<b>RF Specification</b>	125 kHz : ASK, PSK, FSK 13.56 MHz : ASK		
<b>Operating Environment</b>	Indoor		
<b>Operating Temperature <sup>(2)</sup></b>	0 °C – 50 °C		

### RF SPECIFICATION SUBJECT TO THE REPORT

<b>Operating Frequency Range</b>	125 kHz, 13.56 MHz		
<b>RF Specification (Modulation)</b>	<b>FCC ID</b>	MBPUT5501F-01	13.56 MHz (ASK), 125 kHz (ASK, FSK, PSK)
	<b>IC ID</b>	7485A-5501F01	
	<b>FCC ID</b>	MBPUT5501F-01HF <sup>(3)</sup>	13.56 MHz (ASK)
	<b>IC ID</b>	7485A-5501F01HF <sup>(3)</sup>	
	<b>FCC ID</b>	MBPUT5501F-01LF <sup>(4)</sup>	125 kHz (ASK, FSK, PSK)
	<b>IC ID</b>	7485A-5501F01LF <sup>(4)</sup>	
<b>Number of Channels</b>	13.56 MHz : 1 channel 125 kHz : 1 channel		
<b>Antenna Specification</b>	Loop antenna		
<b>Firmware Version <sup>(5)</sup></b>	1.0.0		
<b>Hardware Version <sup>(5)</sup></b>	0.1		
<b>Date(s) of Tests</b>	August 20, 2020 ~ August 24, 2020		

#### Note :

1. Declaration of Similarity of each models was provided by the manufacturer
2. Operating temperature is declared by the manufacturer.
3. HF test results in this report are applied for HF or HF+LF model.
4. LF test results in this report are applied for LF or HF+LF model.
5. Firmware and Hardware Version are as received by the client.

## 2. METHODOLOGY

The measurement procedure described in ANSI C63.10( Version : 2013) 'the American National Standard of Procedures for Compliance Testing of Unlicensed Wireless Devices'.

### EUT CONFIGURATION

The EUT configuration for testing is installed on RF field strength measurement to meet the Commissions requirement and operating in a manner that intends to maximize its emission characteristics in a continuous normal application.

### EUT EXERCISE

The EUT was operated in the engineering mode to fix the Tx frequency that was for the purpose of the measurements. According to its specifications, the EUT must comply with the requirements of the Section 15.207, 15.209 and 15.225 under the FCC Rules Part 15 Subpart C and RSS-GEN issue 5, RSS-210 issue 10.

## GENERAL TEST PROCEDURES

### Conducted Emissions

The EUT is placed on the turntable, which is 0.8 m above ground plane. According to the requirements in Section 6.2 of ANSI C63.10. (Version :2013) Conducted emissions from the EUT measured in the frequency range between 0.15 MHz and 30MHz using CISPR Quasi-peak and average detector modes.

### Radiated Emissions

The EUT is placed on a turn table, which is 0.8 m above ground plane below 1GHz. Above 1GHz with 1.5m using absorbers between the EUT and receive antenna. The turntable shall rotate 360 degrees to determine the position of maximum emission level. EUT is set 3 m away from the receiving antenna, which varied from 1 m to 4 m to find out the highest emission. Also, each emission was to be maximized by changing the polarization of receiving antenna both horizontal and vertical. To find out the maximum emission, the relative positions of this hand-held transmitter (EUT) was rotated through three orthogonal axes according to the requirements in Section 8 of ANSI C63.10. (Version: 2013)

## DESCRIPTION OF TEST MODES

The EUT has been tested per test setup instruction provided by the manufacturer under continuous Tx operating condition. The application software 'ICCTest' was used during testing. Various contactless cards were used to activate different modulations of HF and LF.

## 3. INSTRUMENT CALIBRATION

The measuring equipment, which was utilized in performing the tests documented herein, has been calibrated in accordance with the manufacturer's recommendations for utilizing calibration equipment's, which is traceable to recognized national standards. Especially, all antenna for measurement is calibrated in accordance with the requirements of C63.5 (Version : 2017).

## 4. FACILITIES AND ACCREDITATIONS

### FACILITIES

The SAC (Semi-Anechoic Chamber) and conducted measurement facility used to collect the radiated data are located at 1726 Ringwood Avenue, San Jose, California 95131, USA.

The site is constructed in conformance with the requirements of ANSI C63.4. (Version :2014) and CISPR Publication 22.



### EQUIPMENT

Radiated emissions are measured with one or more of the following types of Linearly polarized antennas: tuned dipole, bi-conical, log periodic, bi-log, and/or ridged waveguide, horn. Spectrum analyzers with pre-selectors and quasi-peak detectors are used to perform radiated measurements.

Conducted emissions are measured with Line Impedance Stabilization Networks and EMI Test Receivers. Calibrated wideband preamplifiers, coaxial cables, and coaxial attenuators are also used for making measurements.

All receiving equipment conforms to CISPR Publication 16-1, "Radio Interference Measuring Apparatus and Measurement Methods."

## 5. ANTENNA REQUIREMENTS

**According to FCC 47 CFR §15.203:**

“An intentional radiator antenna shall be designed to ensure that no antenna other than that furnished by the responsible party can be used with the device. The use of a permanently attached antenna or of an antenna that uses a unique coupling to the intentional radiator shall be considered sufficient to comply with the provisions of this section.”

- (1) The antenna of this E.U.T is permanently attached and there is no provision for connection to an external antenna.
- (2) The E.U.T Complies with the requirement of §15.203



## 6. MEASUREMENT UNCERTAINTY

The measurement uncertainties shown below were calculated in accordance with the requirements of ANSI C63.10-2013.

All measurement uncertainty values are shown with a coverage factor of  $k = 2$  to indicate a 95 % level of confidence. The measurement data shown herein meets or exceeds the  $U_{\text{CISPR}}$  measurement uncertainty values specified in CISPR 16-4-2 and, thus, can be compared directly to specified limits to determine compliance.

Parameter	Expanded Uncertainty ( $\pm$ dB)
Conducted Disturbance (150 kHz ~ 30 MHz)	2.55
Radiated Disturbance (9 kHz ~ 30 MHz)	3.20
Radiated Disturbance (30 MHz ~ 1 GHz)	4.73

## 7. DESCRIPTION OF TESTS

### 7.1. 20 dB Bandwidth / 99 % bandwidth

#### Limit

20 dB bandwidth : According to §15.215(c), the bandwidth at 20 dB down from the highest in-band spectral density is measured with a spectrum analyzer connected to the receive antenna while the EUT is operating in transmission mode at the appropriate frequencies.

99% Bandwidth : Section 6.7, RSS-Gen Issue 5

#### Test Configuration

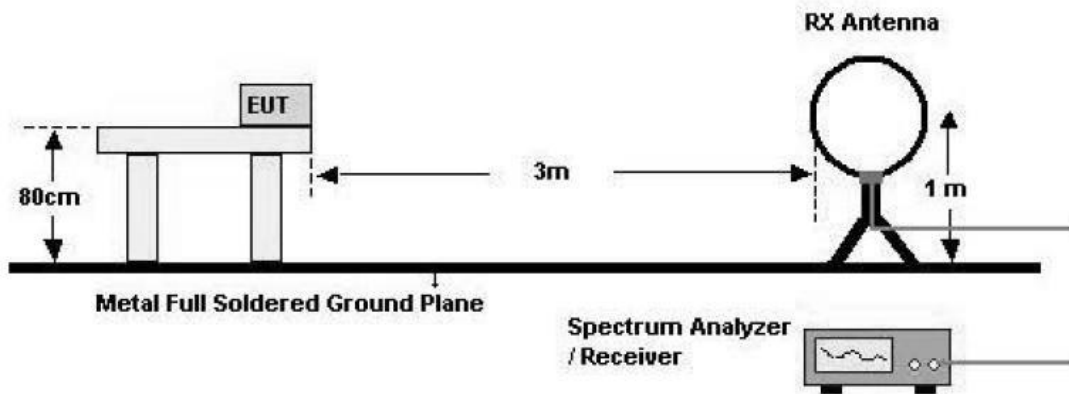

#### Test Procedure (20 dB Bandwidth)

The Spectrum Analyzer setting :

- RBW = 1 kHz
- VBW  $\geq 3 \times$  RBW
- Detector = Peak
- Trace mode = max hold
- Sweep = auto couple
- Allow the trace to stabilize

#### Test Procedure (99 % Bandwidth)

The transmitter output is connected to the spectrum analyzer.

- RBW = 1 kHz
- VBW  $\approx 3 \times$  RBW
- Detector = Peak
- Trace mode = max hold
- Sweep = auto couple
- Allow the trace to stabilize

#### **Note :**

Bandwidth measurement feature in the spectrum analyzer was used to measure 20 dB bandwidth (X dB bandwidth function) and 99 % bandwidth.

## 7.2. Frequency Stability

### Limit

§15.225 (e), RSS-210 Issue 10

The frequency tolerance of the carrier signal shall be maintained within  $\pm 0.01\%$  of the operating frequency.

### Test Configuration

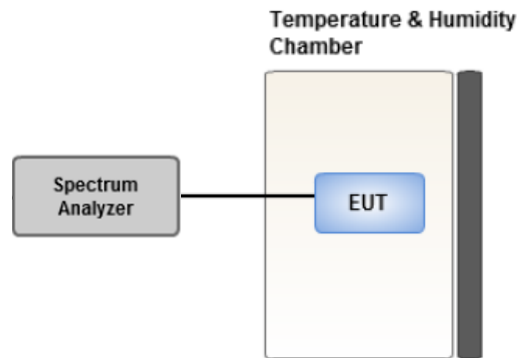

### Test Procedure

For battery operated equipment, the equipment tests shall be performed using a new battery.

- 1) Turn the EUT OFF and place it inside the environmental temperature chamber. For devices that have oscillator heaters, energize only the heater circuit.
- 2) Set the temperature control on the chamber to the highest specified in the regulatory requirements for the type of device and allow the oscillator heater and the chamber temperature to stabilize.
- 3) While maintaining a constant temperature inside the environmental chamber, turn the EUT ON and record the operating frequency at startup, and at 2 minutes, 5 minutes, and 10 minutes after the EUT is energized. Four measurements in total are made.
- 4) Frequency tolerance of the carrier signal shall be maintained within  $\pm 0.01\%$  of the operating frequency.

### **Note:**

- Temperature humidity chamber is used to adjust the temperature between  $-20^{\circ}\text{C}$  and  $+50^{\circ}\text{C}$
- The primary supply voltage was adjusted between 85% to 115% of the nominal value for non hand-carried battery and AC powered equipment. For hand-carried, battery-powered equipment, primary supply voltage is reduced to the battery operating end point which shall be specified by the manufacturer.

### 7.3. Radiated Test

#### Radiated Emission Limits

FCC : 47 CFR § 15.209		
Frequency (MHz)	Field Strength (uV/m)	Measurement Distance (m)
0.009 – 0.490	2400/F(kHz)	300
0.490 – 1.705	24000/F(kHz)	30
1.705 – 30	30	30
30-88	100	3
88-216	150	3
216-960	200	3
Above 960	500	3

ISED : RSS-GEN Section 8.9		
Frequency (MHz)	Field Strength (uV/m)	Measurement Distance (m)
0.009 – 0.490	6.37/F(kHz)	300
0.490 – 1.705	63.7/F(kHz)	30
1.705 – 30	0.08	30
30-88	100	3
88-216	150	3
216-960	200	3
Above 960	500	3

#### Operation within the band 13.110 MHz – 14.010 MHz

FCC : 47 CFR § 15.225 (a), (b), (c), (d) / ISED : RSS-210 ANNEX B.6		
Frequency (MHz)	Field Strength (uV/m)	Measurement Distance (m)
13.553 – 13.567	15,848	30
13.410 ≤ f ≤ 13.553 13.567 ≤ f ≤ 13.710	334	30
13.110 ≤ f ≤ 13.410 13.710 ≤ f ≤ 14.010	106	30

## Test Configuration

Below 30 MHz

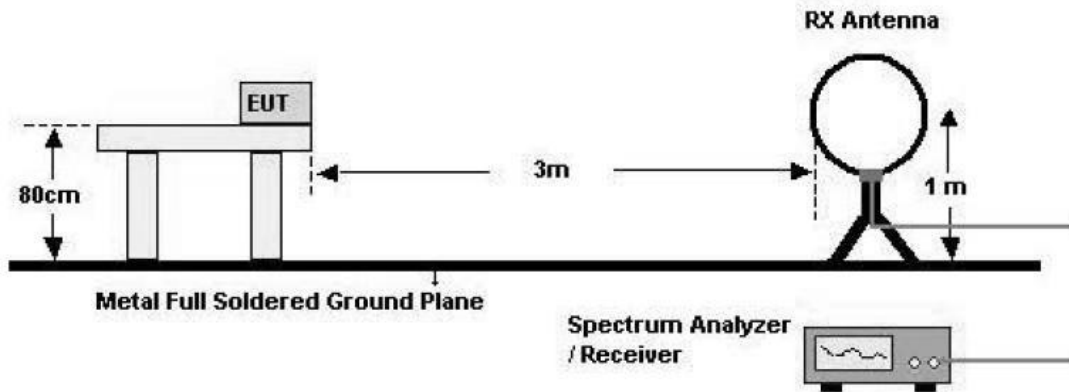

## Test Procedure of Radiated spurious emissions (Below 30 MHz)

1. The EUT was placed on a non-conductive table located on semi-anechoic chamber.
2. The loop antenna was placed at a location 3m from the EUT
3. The EUT is placed on a turntable, which is 0.8m above ground plane.
4. We have done x, y, z planes in EUT and horizontal and vertical polarization in detecting antenna.
5. The turntable shall be rotated for 360 degrees to determine the position of maximum emission level.
6. Distance Correction Factor (0.009 MHz – 0.490 MHz) =  $40 \cdot \log(3 \text{ m}/300 \text{ m}) = - 80 \text{ dB}$   
Measurement Distance: 3 m
7. Distance Correction Factor (0.490 MHz – 30 MHz) =  $40 \cdot \log(3 \text{ m}/30 \text{ m}) = - 40 \text{ dB}$   
Measurement Distance: 3 m
8. Spectrum Setting
  - Frequency Range = 9 kHz ~ 30 MHz
  - Detector = Peak
  - Trace = Max hold
  - RBW = 9 kHz
  - VBW  $\geq 3 \cdot \text{RBW}$
9. Total = Reading Value + Antenna Factor (A.F) + Cable Loss (C.L) + Distance Factor (D.F)
10. There is a comparison data both open-field test site and alternative test site – semi-Anechoic chamber according to 414788 D01. And the results are properly calibrated.

30 MHz - 1 GHz

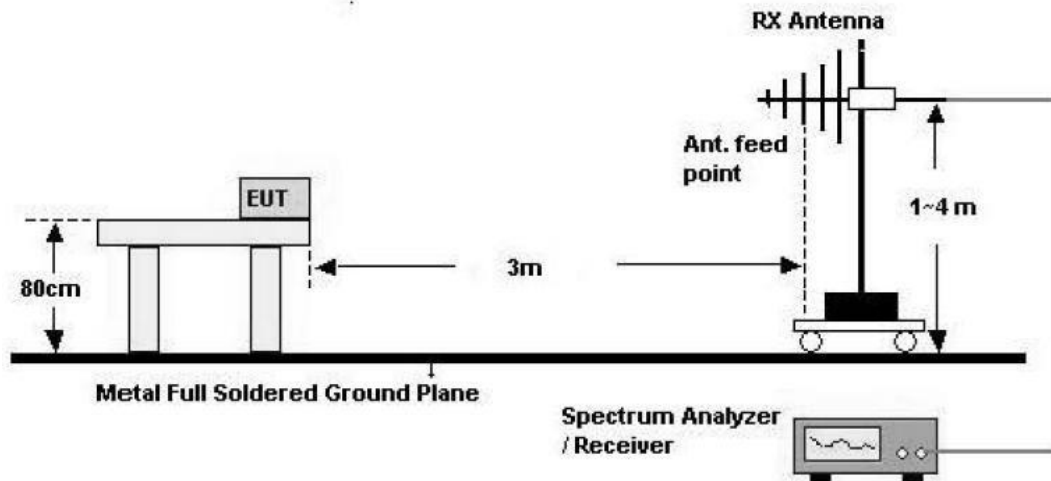

### Test Procedure of Radiated spurious emissions (Below 1GHz)

1. The EUT was placed on a non-conductive table located on semi-anechoic chamber.
2. The EUT is placed on a turntable, which is 0.8m above ground plane.
3. We have done x, y, z planes in EUT and horizontal and vertical polarization in detecting antenna.
4. The turntable shall be rotated for 360 degrees to determine the position of maximum emission level.
5. Spectrum Setting

#### (1) Measurement Type (Peak):

- Measured Frequency Range: 30 MHz – 1 GHz
- Detector = Peak
- Trace = Max hold
- RBW = 100 kHz
- VBW  $\geq 3 \times$  RBW

#### (2) Measurement Type(Quasi-peak):

- Measured Frequency Range: 30 MHz – 1 GHz
- Detector = Quasi-Peak
- RBW = 120 kHz

In general, the method (1) is mainly used

6. Total = Reading Value + Antenna Factor (A.F) + Cable Loss (C.L)

## 7.4. AC Power Line Conducted Emissions

### Limit

47 CFR § 15.207, RSS-GEN Section 8.8

For an intentional radiator that is designed to be connected to the public utility (AC) power line, the radio frequency voltage that is conducted back onto the AC power line on any frequency or frequencies, within the band 150 kHz to 30 MHz, shall not exceed the limits in the following table, as measured using a 50  $\mu$ H/50 ohms line impedance stabilization network (LISN).

Frequency Range (MHz)	Limits (dB $\mu$ V)	
	Quasi-peak	Average
0.15 to 0.50	66 to 56*	56 to 46*
0.50 to 5	56	46
5 to 30	60	50

\*Decreases with the logarithm of the frequency.

Compliance with this provision shall be based on the measurement of the radio frequency voltage between each power line (LINE and NEUTRAL) and ground at the power terminals.

### Test Configuration

See test photographs attached in Annex A for the actual connections between EUT and support equipment.

### Test Procedure

1. The EUT is placed on a wooden table 80 cm above the reference ground plane.
2. The EUT is connected via LISN to a test power supply.
3. The measurement results are obtained as described below:
4. Detectors : Quasi Peak and Average Detector.

According to FCC KDB 174176 D01 Line Conducted FAQ v01r01 :

### **Devices Operating Above 30 MHz**

For a device with a permanent or detachable antenna operating above 30 MHz, measurements must be performed with the antenna connected as specified in clause 6.2 of ANSI C63.10-2013.

### **Devices Operating Below 30 MHz**

For a device with a permanent or detachable antenna operating at or below 30 MHz, the FCC will accept measurements performed with a suitable dummy load in lieu of the antenna under the following conditions:

- (1) Perform the AC power-line conducted tests with the antenna connected to determine compliance with Section 15.207 limits outside the transmitter's fundamental emission band;
- (2) Retest with a dummy load in lieu of the antenna to determine compliance with Section 15.207 limits within the transmitter's fundamental emission band. For a detachable antenna, remove the antenna and connect a suitable dummy load to the antenna connector. For a permanent antenna, remove the antenna and terminate the RF output with a dummy load or network which simulates the antenna in the fundamental frequency band. All measurements must be performed as specified in clause 6.2 of ANSI C63.10-2013.

### Sample Calculation

Quasi-peak(Final Result) = Reading Value + Correction Factor

## 7.5. Worst Case Configuration / Test Mode

### Radiated test

Measurement loop antenna polarization and EUT azimuth were varied to find the maximum level of emissions out of the EUT. In addition, all X, Y, and Z positions were investigated to find the worst-case position.

Final test was performed by placing the EUT at the position (Z) which gives the maximum emission.

All the modulations below were investigated

HF : ASK

LF : ASK, FSK, and PSK

### Conducted test

AC Line conducted emission test was performed in two modes because the EUT operates below 30 MHz

- (1) Antenna connected to the EUT
- (2) Antenna removed from the EUT



## 7.6. Test Configuration

### Radiated Emission

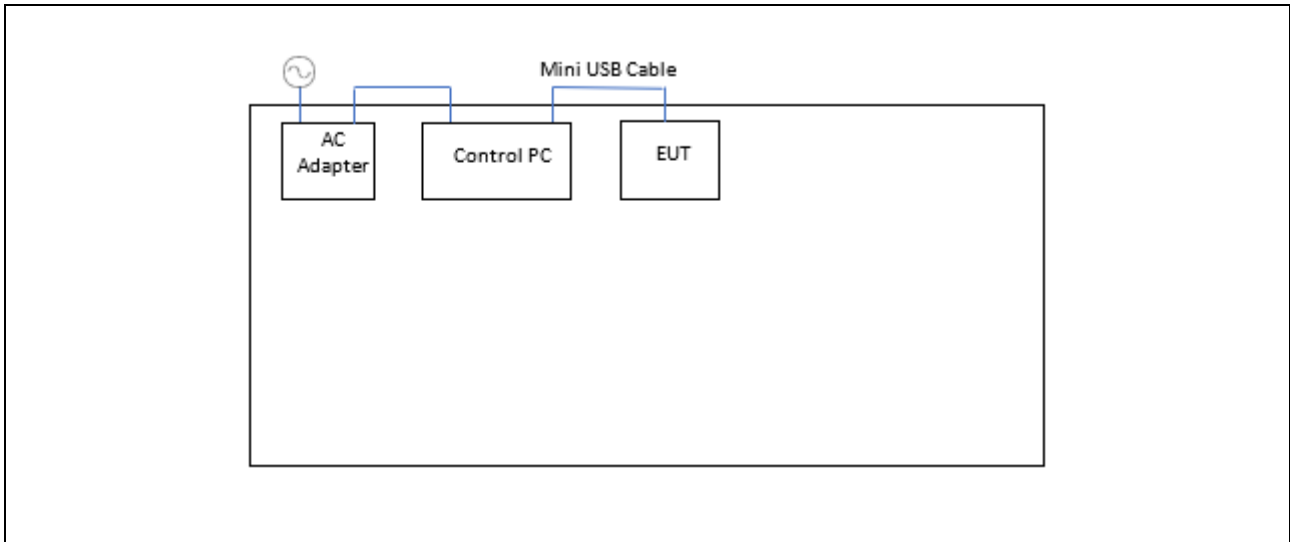

### Conducted Emission

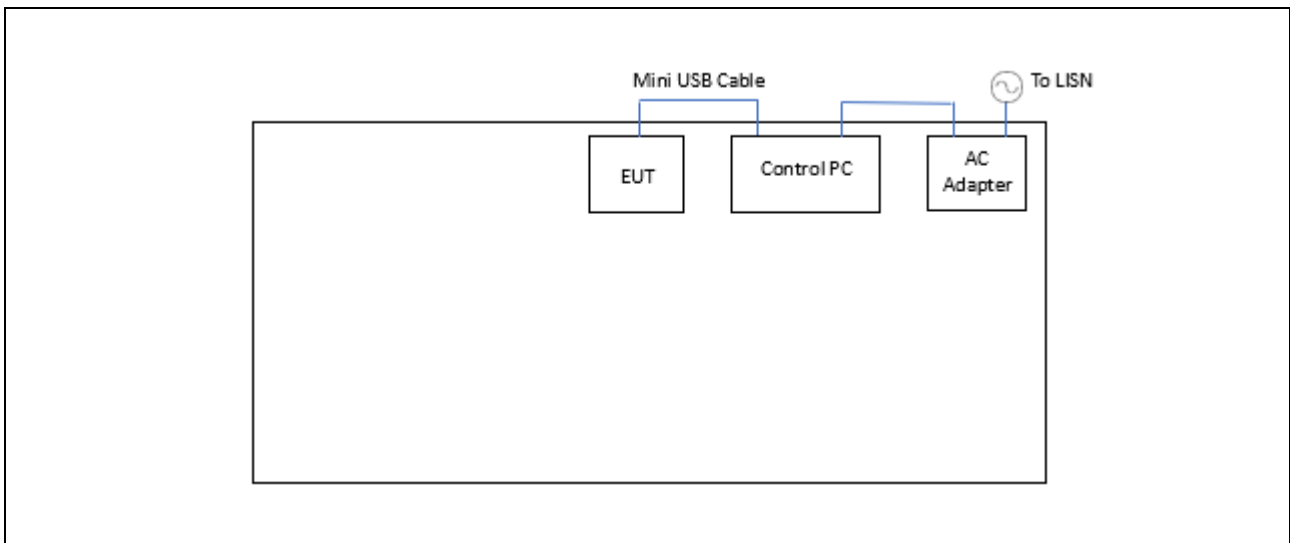

**Note:**

RFID keycard was placed next to the EUT for 13.56 MHz RFID transmission during testing.

### 7.7. List of Support Equipment

Equipment Type	Model No.	Serial Number	Manufacturer	Qty	Note
Laptop	T440	TP00050A	Lenovo	1	-
AC Adapter	ADLX65SDC2A	36200350	Delta	1	100-240 VAC, 1.5A 50-60Hz
mini USB (2m)	-	-	-	1	Not shielded No choke attached

## 8. SUMMARY OF TEST RESULTS

Test Description	FCC Part Section(s)	IC Part Section(s)	Test Limit	Test Condition	Test Result
20 dB Bandwidth	§15.215 (c)	-	N/A	Radiated	PASS
Occupied Bandwidth	-	Section 6.7 RSS-GEN	N/A		PASS
Radiated E-Field Emissions 13.553 MHz - 13.567 MHz	§15.225 (a)	Annex B.6 (a)(i) RSS-210	cf. Section 7.3		PASS
Radiated E-Field Emissions 13.410 MHz ≤ f ≤ 13.553 MHz 13.567 MHz ≤ f ≤ 13.710 MHz	§15.225 (b)	Annex B.6 (a)(ii) RSS-210	cf. Section 7.3		PASS
Radiated E-Field Emissions 13.110 MHz ≤ f ≤ 13.410 MHz 13.710 MHz ≤ f ≤ 14.010 MHz	§15.225 (c)	Annex B.6 (a)(iii) RSS-210	cf. Section 7.3		PASS
Radiated Spurious Emissions	15.209	Section 8.9 RSS-GEN	cf. Section 7.3		PASS
Frequency Stability	§15.225 (e)	RSS-210, B.6	cf. Section 7.2		PASS
AC Power line Conducted Emissions	§15.207	RSS-GEN, 8.8	cf. Section 7.4	Conducted	PASS

## 9. TEST RESULT

### 9.1 20 dB BANDWIDTH / 99% BANDWIDTH

13,56 MHz		20 dB Bandwidth (Hz)	99% Bandwidth (Hz)	Limit
Mode	Frequency (MHz)	Result	Result	
13.56 MHz	ASK	568.0	872.0	N/A

125 kHz		99% Bandwidth (kHz)		Limit
Mode	Frequency (MHz)	Result		
125 kHz	ASK	2.488		N/A
	FSK	2.648		
	PSK	2.592		

TEST PLOTS

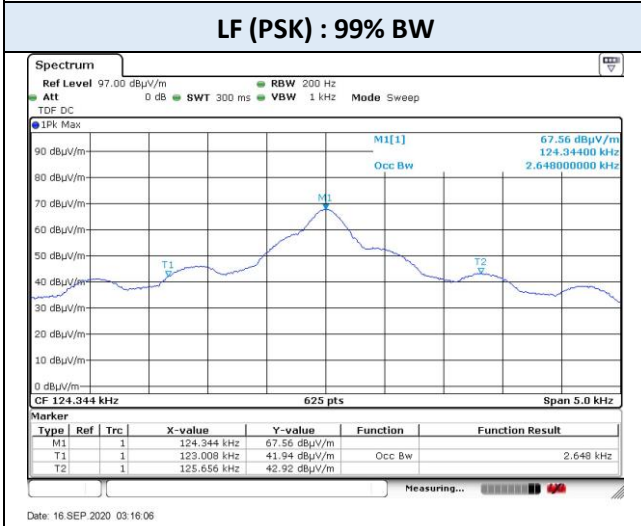
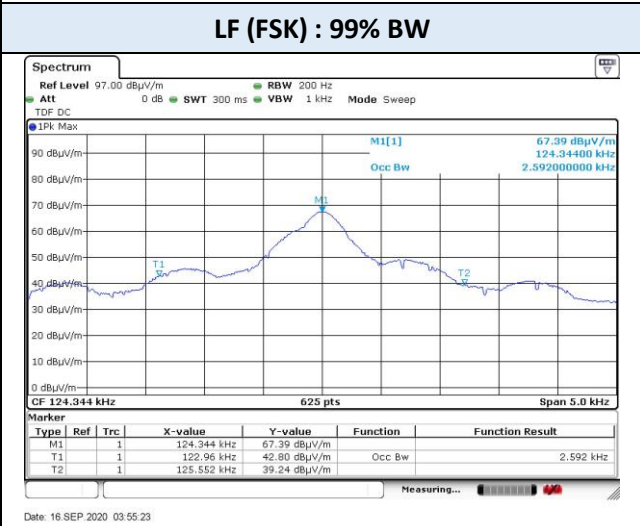
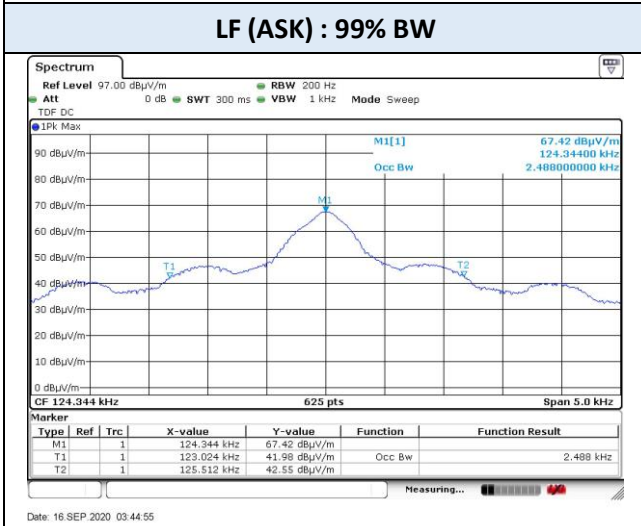
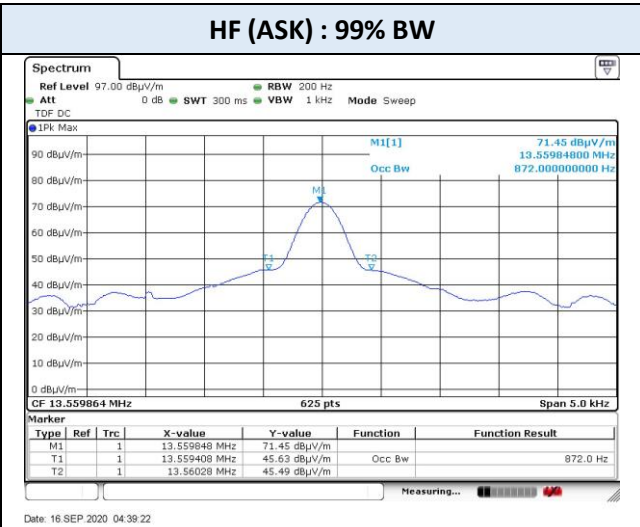
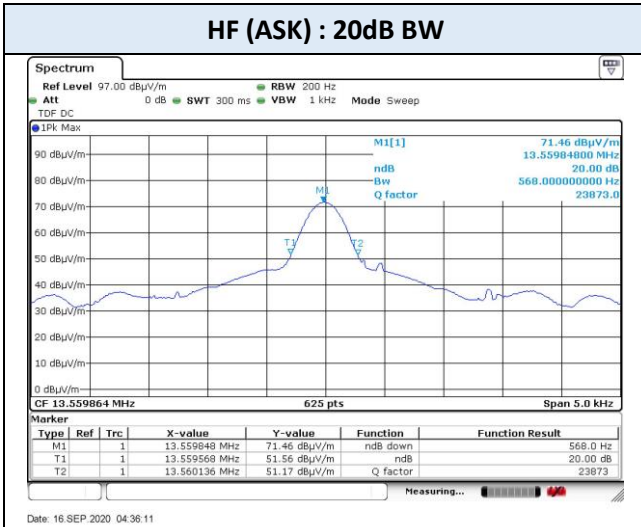

## 9.2 FREQUENCY STABILITY

Operating Frequency      13.56 MHz  
 Reference Voltage        5 V DC  
 Limit                         100 PPM = 1356 Hz

Voltage (%)	Power (VDC)	Temp. (°C)	Frequency [MHz]	Frequency Dev. (Hz)	Frequency (ppm)
100%	5.0	-20	13.559953	-46.5	-3.43
100%		-10	13.559956	-43.8	-3.23
100%		0	13.559924	-75.6	-5.58
100%		+10	13.559900	-100.0	-7.38
100%		+20 (Ref.)	13.559871	-128.7	-9.49
100%		+30	13.559861	-138.9	-10.25
100%		+40	13.559861	-138.6	-10.22
100%		+50	13.559859	-140.9	-10.39
115%		5.75	+20	13.559875	-124.5
85%	4.25	+20	13.559879	-121.0	-8.92

### 9.3 RADIATED SPURIOUS EMISSIONS

#### Radiated Electric Field Emission within band 13.110 – 14.010 MHz

##### 13.553 MHz-13.567 MHz

Frequency (MHz)	Polarization	Reading (dBuV)	Corr. <sup>(1)</sup> (dB)	Total (dBuV/m)	Limit <sup>(2)</sup> (dBuV/m)	Margin (dB)	Measurement Type
13.560	H	50.4	21.3	71.7	124.0	52.3	QP
13.560	V	46.6	21.3	67.9	124.0	56.1	QP

##### 13.410 MHz-13.553 MHz and 13.567 MHz-13.710 MHz

Frequency (MHz)	Polarization	Reading (dBuV)	Corr. <sup>(1)</sup> (dB)	Total (dBuV/m)	Limit <sup>(2)</sup> (dBuV/m)	Margin (dB)	Measurement Type
13.453	H	31.5	21.3	52.8	90.5	37.7	QP
13.454	V	27.1	21.3	48.4	90.5	42.1	QP
13.666	H	31.2	21.3	52.5	90.5	38.0	QP
13.666	V	27.4	21.3	48.7	90.5	41.8	QP

##### 13.110 MHz – 13.410 MHz and 13.710 MHz-14.010 MHz

Frequency (MHz)	Polarization	Reading (dBuV)	Corr. <sup>(1)</sup> (dB)	Total (dBuV/m)	Limit <sup>(2)</sup> (dBuV/m)	Margin (dB)	Measurement Type
13.348	H	30.8	21.3	52.1	80.5	28.4	QP
13.348	V	27.1	21.3	48.4	80.5	32.1	QP
13.771	H	29.9	21.4	51.3	80.5	29.2	QP
13.771	V	26.2	21.4	47.6	80.5	32.9	QP

**Notes:**

1. Correction Factor: Antenna Factor + Cable loss
2. Limit = specific Limits (dBuV) + Distance extrapolation factor
  - The measurement distance is 3 meters.
  - Distance extrapolation factor = 40 log (specific distance / test distance) (dB)

▣ TEST PLOTS

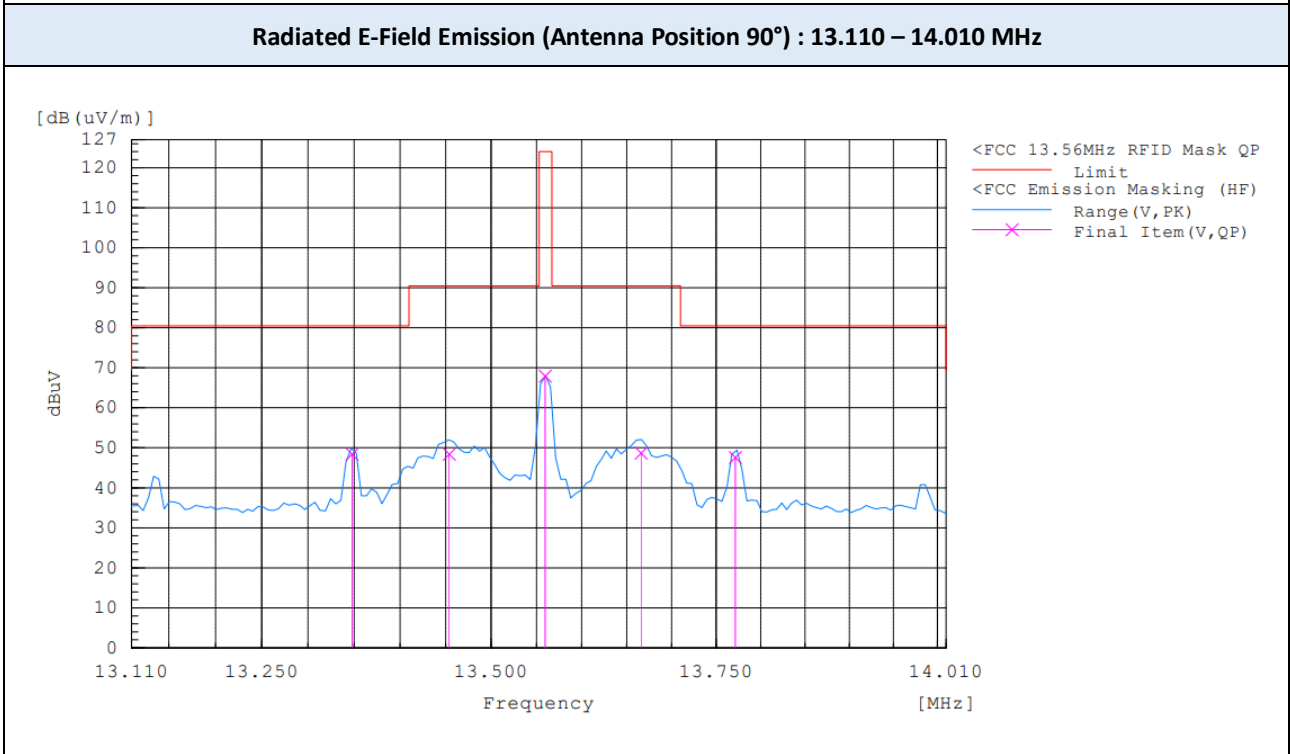
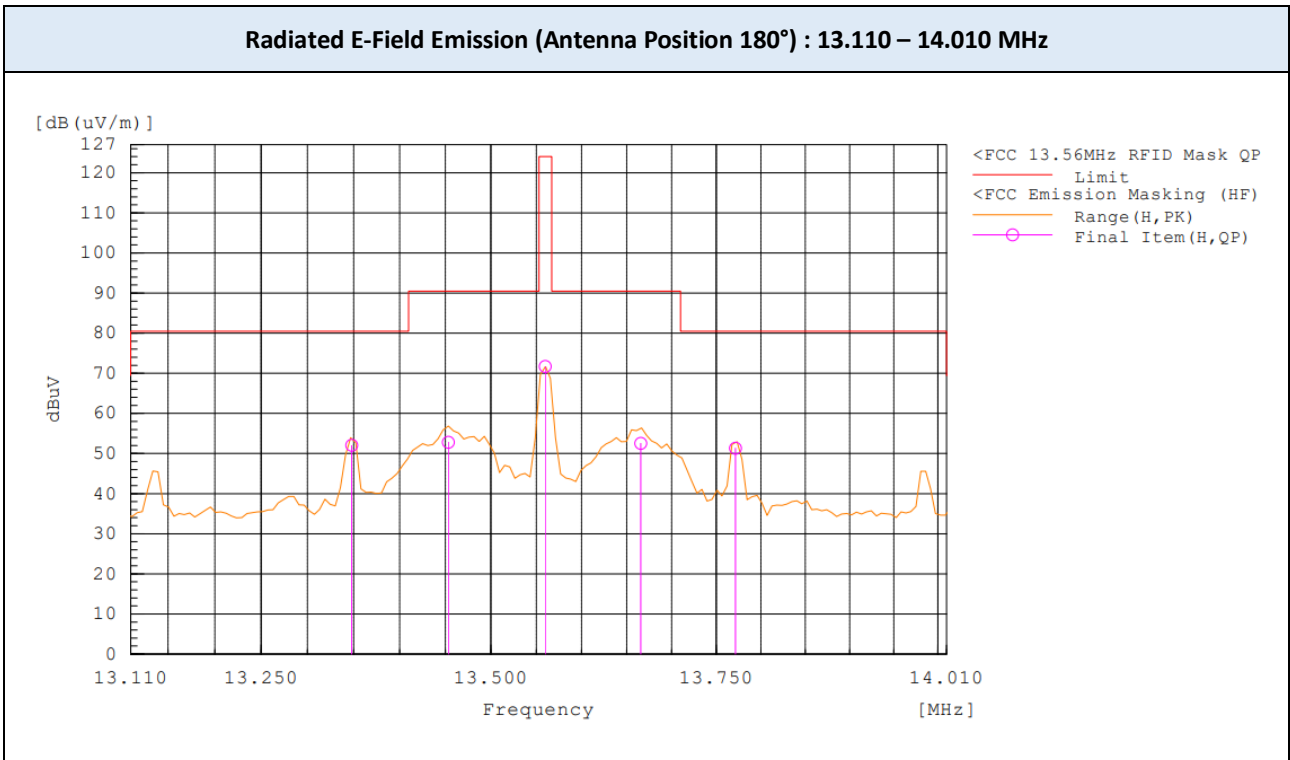

**Note:**

The worst-case plots are included in this report.



**Radiated Spurious Emission**

HF : ASK

Frequency Range : 9 kHz – 30MHz

Frequency (MHz)	Polarization	Reading (dBuV)	Corr. <sup>(2)</sup> (dB)	Total (dBuV/m)	Limit <sup>(3)</sup> (dBuV/m)	Margin (dB)	Measurement Type
0.036	V	9.9	20.8	30.7	116.5	85.8	QP
0.036	H	17.6	20.8	38.4	116.5	78.1	QP
0.072	V	2.3	20.1	22.4	110.5	88.1	QP
0.073	H	15.9	20.1	36.0	110.3	74.3	QP
0.109	H	11.7	19.8	31.5	106.9	75.4	QP
0.146	H	11.1	19.8	30.9	104.3	73.4	QP
0.330	H	18.8	19.7	38.5	97.2	58.7	QP
0.332	V	15.2	19.7	34.9	97.2	62.3	QP
24.351	V	9.2	22.1	31.3	69.5	38.2	QP
25.104	H	9.2	22.1	31.3	69.5	38.2	QP

**Notes:**

1. Correction Factor: Antenna Factor + Cable loss
2. Limit = specific Limits (dBuV) + Distance extrapolation factor
  - The measurement distance is 3 meters.
  - Distance extrapolation factor = 40 log (specific distance / test distance) (dB)

Frequency Range : Below 1 GHz

Frequency (MHz)	Polarization	Reading (dBuV)	Corr. <sup>(2)</sup> (dB)	Total (dBuV/m)	Limit (dBuV/m)	Margin (dB)	Measurement Type
40.680	V	38.2	-7.4	30.8	40	9.2	QP
40.686	H	41.4	-7.4	34.0	40	6.0	QP
94.916	V	43.5	-11.7	31.8	43.5	11.7	QP
94.921	H	46.9	-11.7	35.2	43.5	8.3	QP
126.985	H	36.3	-6.5	29.8	43.5	13.7	QP
203.402	H	45.5	-8.7	36.8	43.5	6.7	QP
216.956	H	46.6	-9.8	36.8	46	9.2	QP

**Notes:**

1. Correction Factor: Antenna Factor + Cable loss

LF : ASK

Frequency Range : 9 kHz – 30MHz

Frequency (MHz)	Polarization	Reading (dBuV)	Corr. <sup>(2)</sup> (dB)	Total (dBuV/m)	Limit <sup>(3)</sup> (dBuV/m)	Margin (dB)	Measurement Type
0.036	V	11.1	20.8	31.9	116.5	84.6	QP
0.036	H	11.3	20.8	32.1	116.5	84.4	QP
0.124 <sup>1)</sup>	V	38.9	19.8	58.7	105.7	47.0	QP
0.124 <sup>1)</sup>	H	43.6	19.8	63.4	105.7	42.3	QP
0.372	V	15.5	19.7	35.2	96.2	61.0	QP
0.373	H	18.3	19.7	38.0	96.2	58.2	QP
22.113	V	9.3	22.0	31.3	69.5	38.2	QP
24.726	H	9.2	22.1	31.3	69.5	38.2	QP

**Notes:**

1. Fundamental frequency for 125 kHz band
2. Correction Factor: Antenna Factor + Cable loss
3. Limit = specific Limits (dBuV) + Distance extrapolation factor
  - The measurement distance is 3 meters.
  - Distance extrapolation factor = 40 log (specific distance / test distance) (dB)

Frequency Range : Below 1 GHz

Frequency (MHz)	Polarization	Reading (dBuV)	Corr. <sup>(2)</sup> (dB)	Total (dBuV/m)	Limit (dBuV/m)	Margin (dB)	Measurement Type
31.364	V	24.4	-0.7	23.7	40	16.3	QP
119.991	H	40.8	-6.8	34.0	43.5	9.5	QP
119.996	V	37.2	-6.8	30.4	43.5	13.1	QP
123.484	H	32.5	-6.6	25.9	43.5	17.6	QP
138.370	H	34.2	-7.0	27.2	43.5	16.3	QP

**Notes:**

1. Correction Factor: Antenna Factor + Cable loss

LF : FSK

Frequency Range : 9 kHz – 30MHz

Frequency (MHz)	Polarization	Reading (dBuV)	Corr. <sup>(2)</sup> (dB)	Total (dBuV/m)	Limit <sup>(3)</sup> (dBuV/m)	Margin (dB)	Measurement Type
0.036	V	11.8	20.8	32.6	116.5	83.9	QP
0.036	H	9.7	20.8	30.5	116.5	86.0	QP
0.124 <sup>1)</sup>	V	37.4	19.8	57.2	105.7	48.5	QP
0.124 <sup>1)</sup>	H	43.0	19.8	62.8	105.7	42.9	QP
0.372	V	14.6	19.7	34.3	96.2	61.9	QP
0.373	H	17.7	19.7	37.4	96.2	58.8	QP
22.143	V	9.3	22.0	31.3	69.5	38.2	QP
24.746	H	8.8	22.1	30.9	69.5	38.6	QP

**Notes:**

1. Fundamental frequency for 125 kHz band
2. Correction Factor: Antenna Factor + Cable loss
3. Limit = specific Limits (dBuV) + Distance extrapolation factor
  - The measurement distance is 3 meters.
  - Distance extrapolation factor = 40 log (specific distance / test distance) (dB)

Frequency Range : Below 1 GHz

Frequency (MHz)	Polarization	Reading (dBuV)	Corr. <sup>(2)</sup> (dB)	Total (dBuV/m)	Limit (dBuV/m)	Margin (dB)	Measurement Type
32.805	V	25.0	-1.7	23.3	40	16.7	QP
116.568	H	32.5	-7.1	25.4	43.5	18.1	QP
119.984	V	37.4	-6.8	30.6	43.5	12.9	QP
120.014	H	40.8	-6.8	34.0	43.5	9.5	QP
123.522	H	31.6	-6.6	25.0	43.5	18.5	QP
135.187	H	35.8	-6.8	29.0	43.5	14.5	QP

**Notes:**

1. Correction Factor: Antenna Factor + Cable loss

LF : PSK

Frequency Range : 9 kHz – 30MHz

Frequency (MHz)	Polarization	Reading (dBuV)	Corr. <sup>(2)</sup> (dB)	Total (dBuV/m)	Limit <sup>(3)</sup> (dBuV/m)	Margin (dB)	Measurement Type
0.036	V	11.5	20.8	32.3	116.5	84.2	QP
0.036	H	11.5	20.8	32.3	116.5	84.2	QP
0.124 <sup>1)</sup>	V	39.0	19.8	58.8	105.7	46.9	QP
0.124 <sup>1)</sup>	H	42.8	19.8	62.6	105.7	43.1	QP
0.372	V	15.1	19.7	34.8	96.2	61.4	QP
0.373	H	18.0	19.7	37.7	96.2	58.5	QP
22.105	V	9.4	22	31.4	69.5	38.1	QP
24.758	H	9.1	22.1	31.2	69.5	38.3	QP

**Notes:**

1. Fundamental frequency for 125 kHz band
2. Correction Factor: Antenna Factor + Cable loss
3. Limit = specific Limits (dBuV) + Distance extrapolation factor
  - The measurement distance is 3 meters.
  - Distance extrapolation factor = 40 log (specific distance / test distance) (dB)

Frequency Range : Below 1 GHz

Frequency (MHz)	Polarization	Reading (dBuV)	Corr. <sup>(2)</sup> (dB)	Total (dBuV/m)	Limit (dBuV/m)	Margin (dB)	Measurement Type
31.728	V	25.5	-0.9	24.6	40	15.4	QP
117.348	H	31.7	-7.0	24.7	43.5	18.8	QP
120.001	V	36.5	-6.8	29.7	43.5	13.8	QP
120.014	H	40.5	-6.8	33.7	43.5	9.8	QP
134.892	H	38.2	-6.8	31.4	43.5	12.1	QP
334.373	H	30.0	-6.1	23.9	46	22.1	QP

**Notes:**

1. Correction Factor: Antenna Factor + Cable loss

▣ TEST PLOTS

**Radiated Spurious Emission 9 kHz – 30 MHz (Antenna Position 180°) : HF ASK**

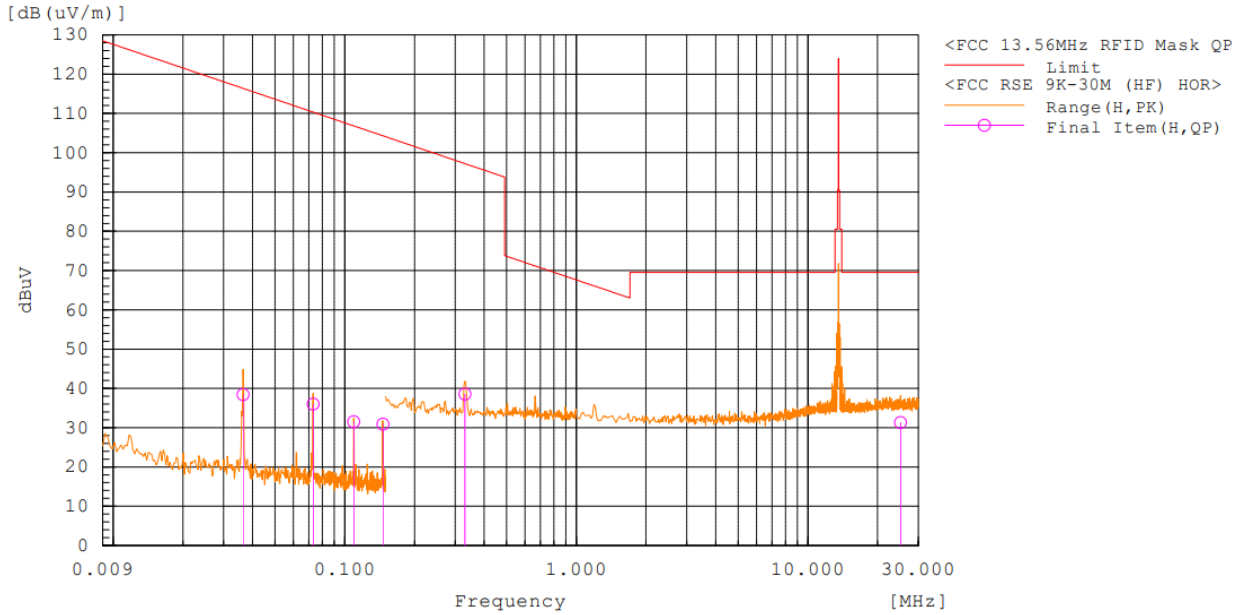

**Radiated Spurious Emission 9 kHz – 30 MHz (Antenna Position 90°) : HF ASK**

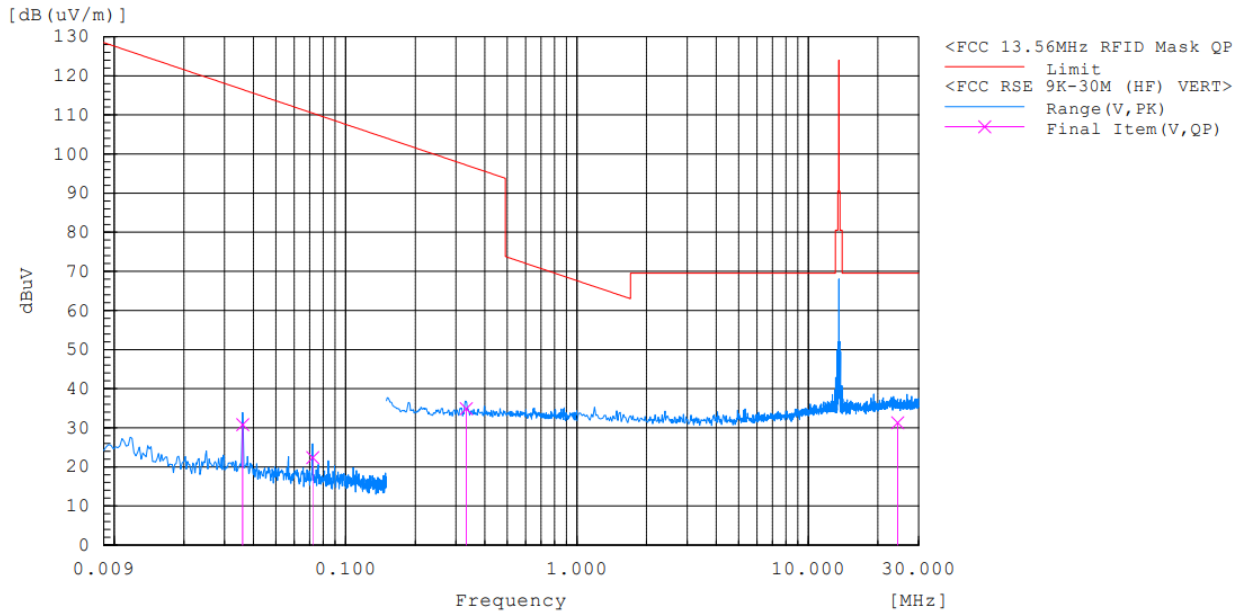

▣ TEST PLOTS

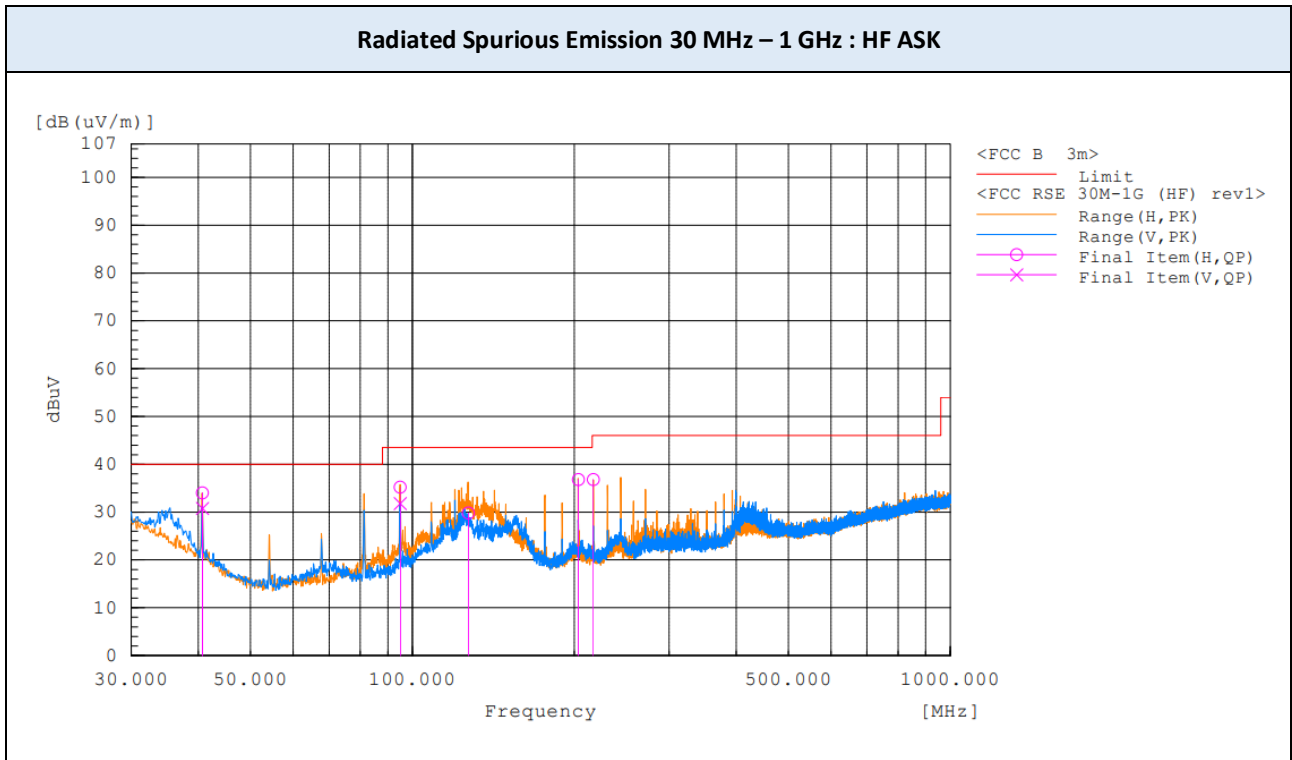

▣ TEST PLOTS

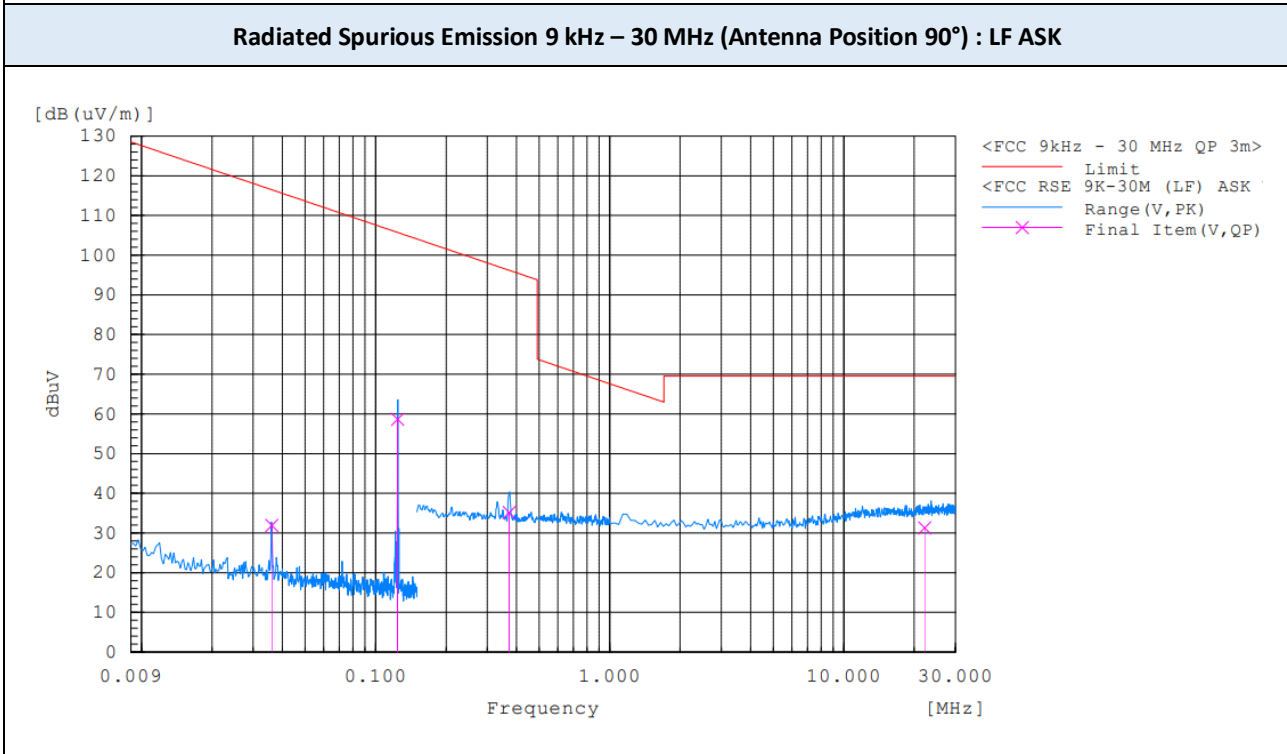
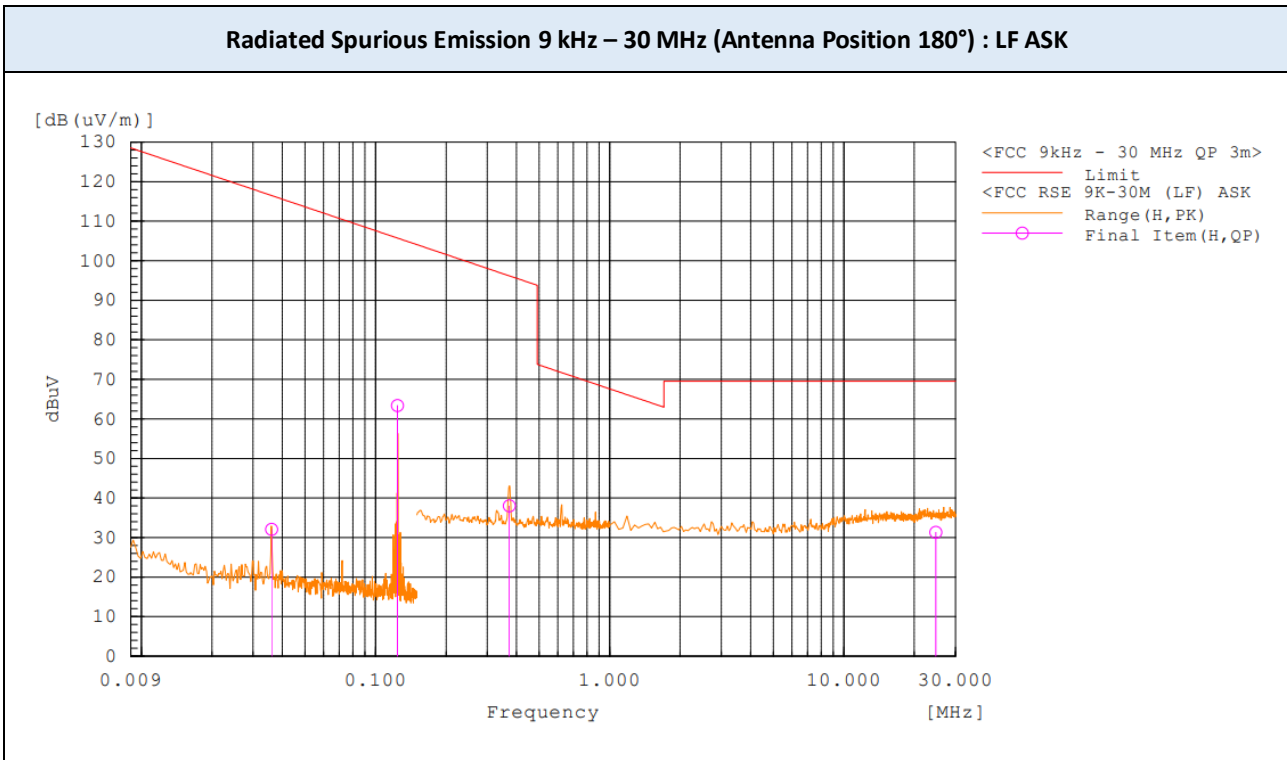

**Note:**  
The worst-case plots are included in this report.

▣ TEST PLOTS

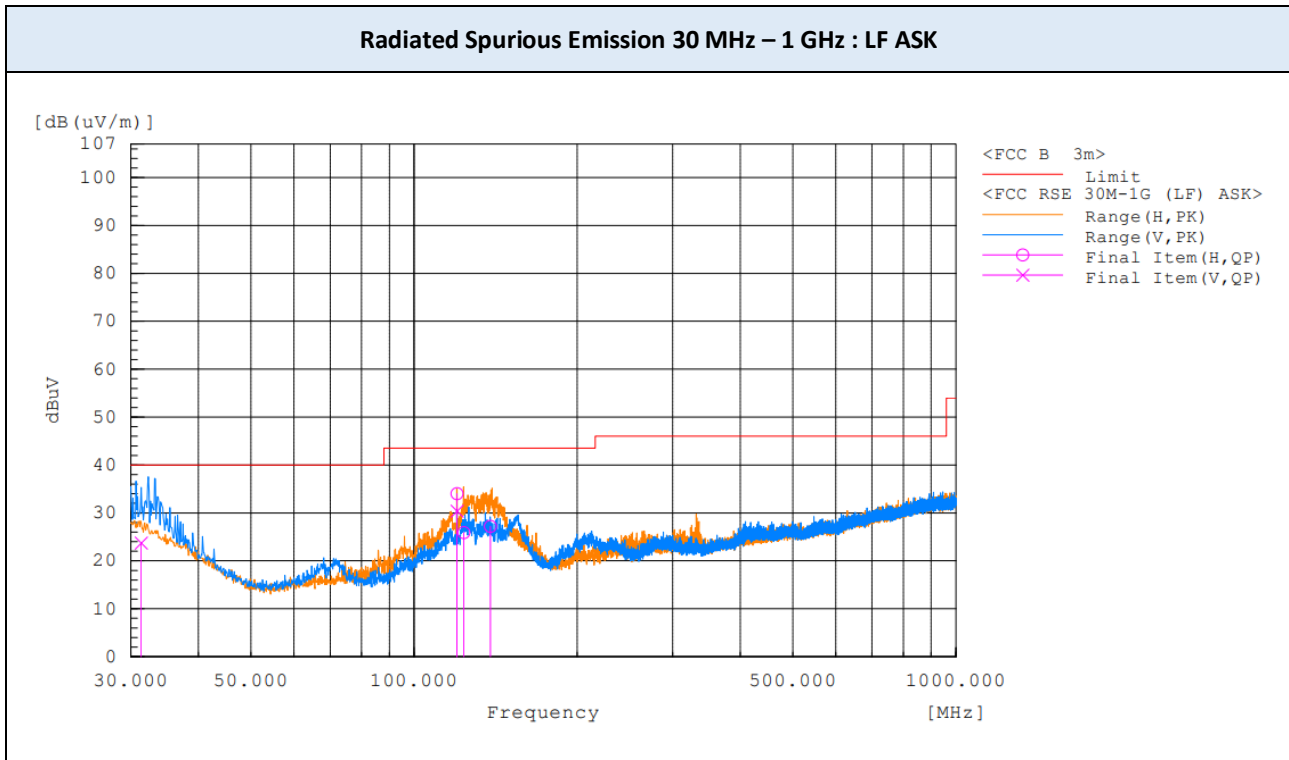

**Note:**

The worst-case plots are included in this report.



#### 9.4. POWERLINE CONDUCTED EMISSIONS

AC Main : Device with antenna connected

Frequency (MHz)	Line	Reading (dB $\mu$ V)		Corr. <sup>1)</sup> (dB)	Level (dB $\mu$ V)		Limit (dB $\mu$ V)		Margin (dB)	
		QP	CAV		QP	CAV	QP	CAV	QP	CAV
0.152	L1	43.2	27.8	9.8	53.0	37.6	65.9	55.9	12.9	18.3
0.160	L1	43.2	26.9	9.8	53.0	36.7	65.5	55.5	12.5	18.8
0.211	L1	36.5	24.5	9.7	46.2	34.2	63.2	53.2	17	19
0.523	L1	29.4	19.5	9.7	39.1	29.2	56	46	16.9	16.8
18.376	L1	20.7	12.7	10.3	31.0	23.0	60	50	29	27

Frequency (MHz)	Line	Reading (dB $\mu$ V)		Corr. <sup>1)</sup> (dB)	Level (dB $\mu$ V)		Limit (dB $\mu$ V)		Margin (dB)	
		QP	CAV		QP	CAV	QP	CAV	QP	CAV
0.150	N	40.7	25.9	9.8	50.5	35.7	66	56	15.5	20.3
0.162	N	42.7	27.3	9.7	52.4	37.0	65.3	55.3	12.9	18.3
0.184	N	37.2	24.7	9.7	46.9	34.4	64.3	54.3	17.4	19.9
0.207	N	36.4	23.7	9.7	46.1	33.4	63.3	53.3	17.2	19.9
0.533	N	29.6	21.2	9.7	39.3	30.9	56	46	16.7	15.1
18.670	N	20.0	12.2	10.3	30.3	22.5	60	50	29.7	27.5

**Note :**

1. Quasi-peak(Final Result) = Reading Value + Correction Factor

AC Main : RF output terminated with dummy load

Frequency (MHz)	Line	Reading (dB $\mu$ V)		Corr. <sup>1)</sup> (dB)	Level (dB $\mu$ V)		Limit (dB $\mu$ V)		Margin (dB)	
		QP	CAV		QP	CAV	QP	CAV	QP	CAV
0.152	L1	39.6	22.2	9.8	49.4	32.0	65.9	55.9	16.5	23.9
0.190	L1	39.6	24.2	9.8	49.4	34.0	64.1	54.1	14.7	20.1
0.534	L1	29.4	19.0	9.7	39.1	28.7	56	46	16.9	17.3
4.800	L1	25.3	23.5	9.9	35.2	33.4	56	46	20.8	12.6
14.398	L1	26.1	22.7	10.1	36.2	32.8	60	50	23.8	17.2
15.826	L1	20.9	13.5	10.2	31.1	23.7	60	50	28.9	26.3
23.997	L1	26.5	23.7	10.4	36.9	34.1	60	50	23.1	15.9

Frequency (MHz)	Line	Reading (dB $\mu$ V)		Corr. <sup>1)</sup> (dB)	Level (dB $\mu$ V)		Limit (dB $\mu$ V)		Margin (dB)	
		QP	CAV		QP	CAV	QP	CAV	QP	CAV
0.150	N	39.2	23.0	9.8	49.0	32.8	66	56	17	23.2
0.173	N	42.4	28.9	9.7	52.1	38.6	64.8	54.8	12.7	16.2
0.220	N	36.1	24.3	9.7	45.8	34.0	62.8	52.8	17	18.8
0.532	N	28.3	18.9	9.7	38.0	28.6	56	46	18	17.4
4.800	N	24.9	23.2	9.9	34.8	33.1	56	46	21.2	12.9
14.399	N	25.6	22.4	10.1	35.7	32.5	60	50	24.3	17.5
18.438	N	21.2	13.6	10.3	31.5	23.9	60	50	28.5	26.1
23.997	N	25.8	22.0	10.4	36.2	32.4	60	50	23.8	17.6

**Note :**

1. Quasi-peak(Final Result) = Reading Value + Correction Factor

▣ TEST PLOTS

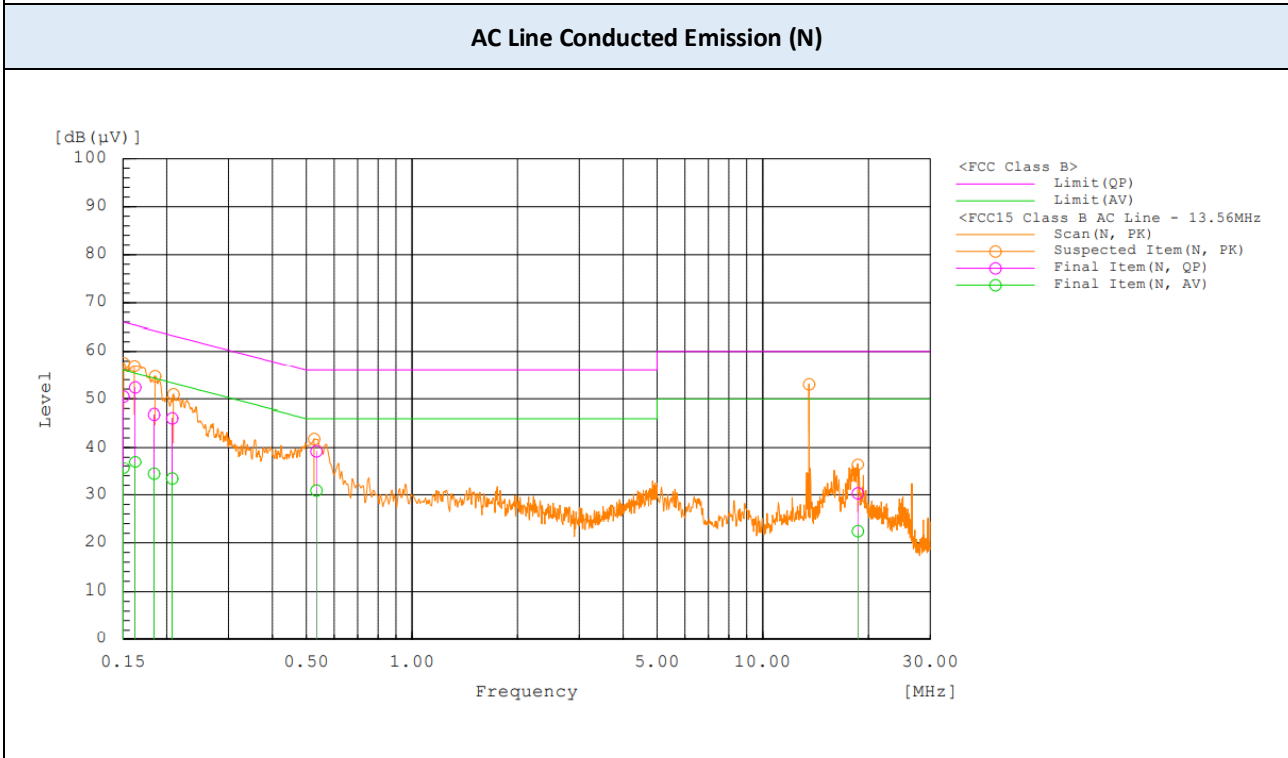
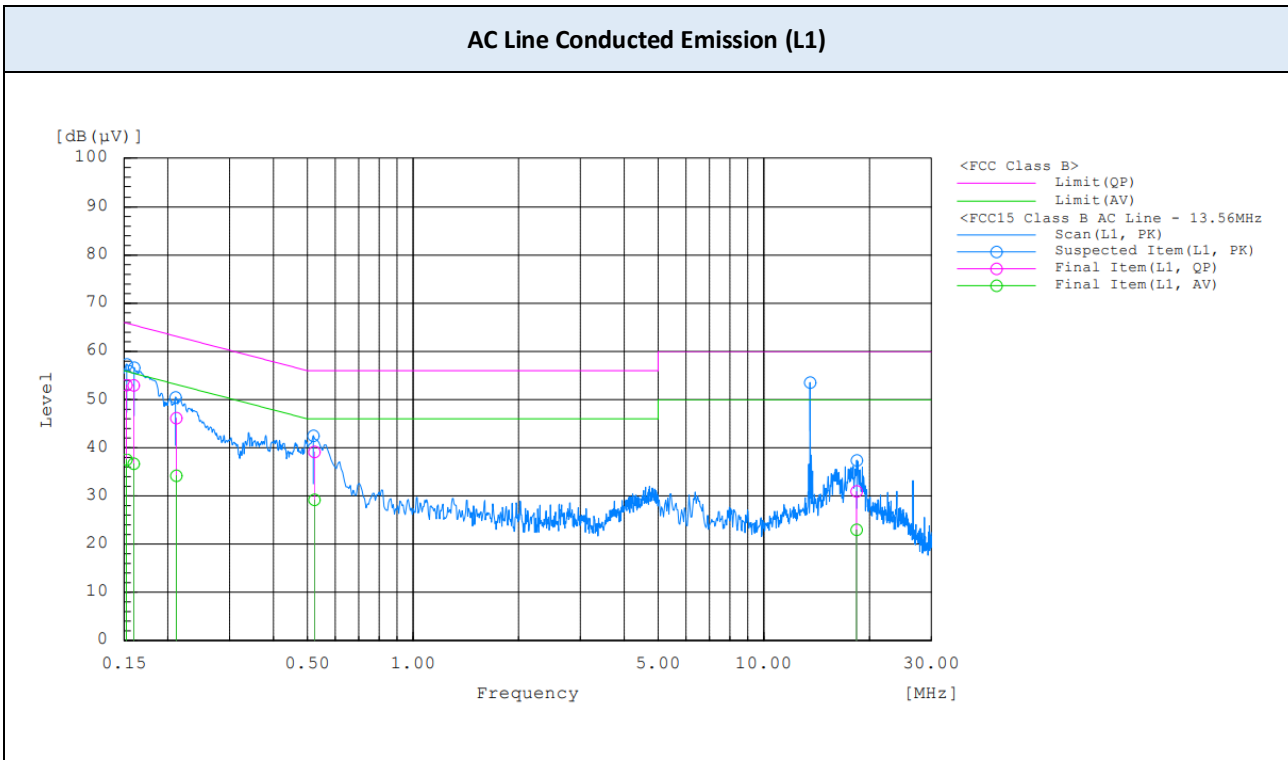

**Note :**

1. Peak at 13.56 MHz is a fundamental frequency HF.

▣ TEST PLOTS

**AC Line Conducted Emission (L1) : RF output terminated with dummy load**

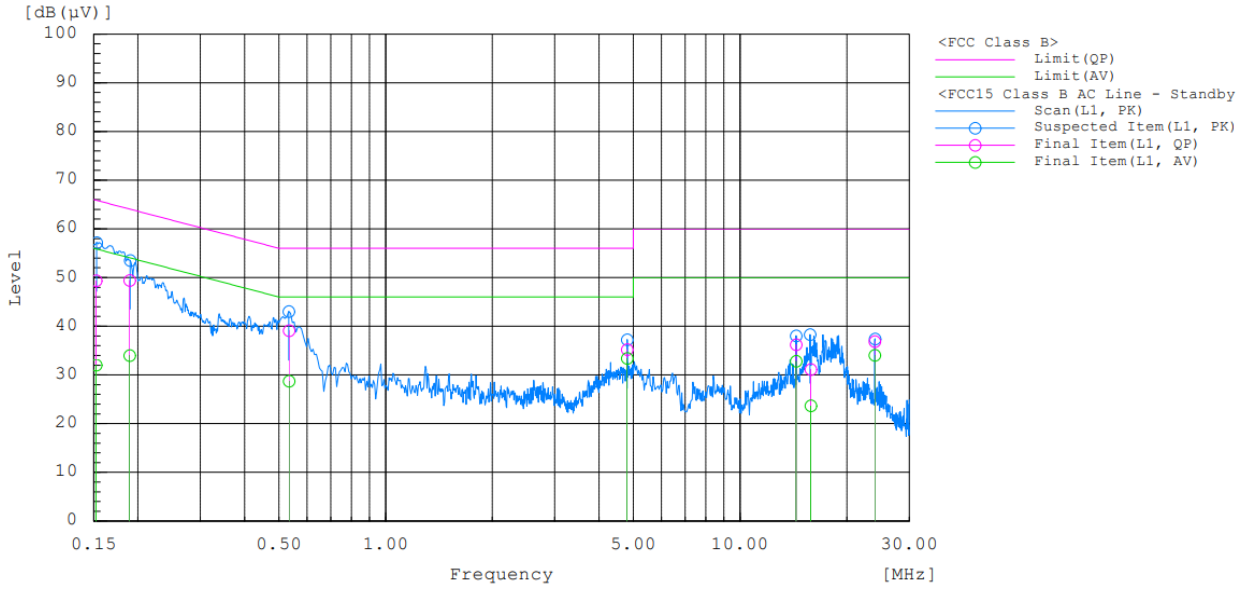

**AC Line Conducted Emission (N) : RF output terminated with dummy load**

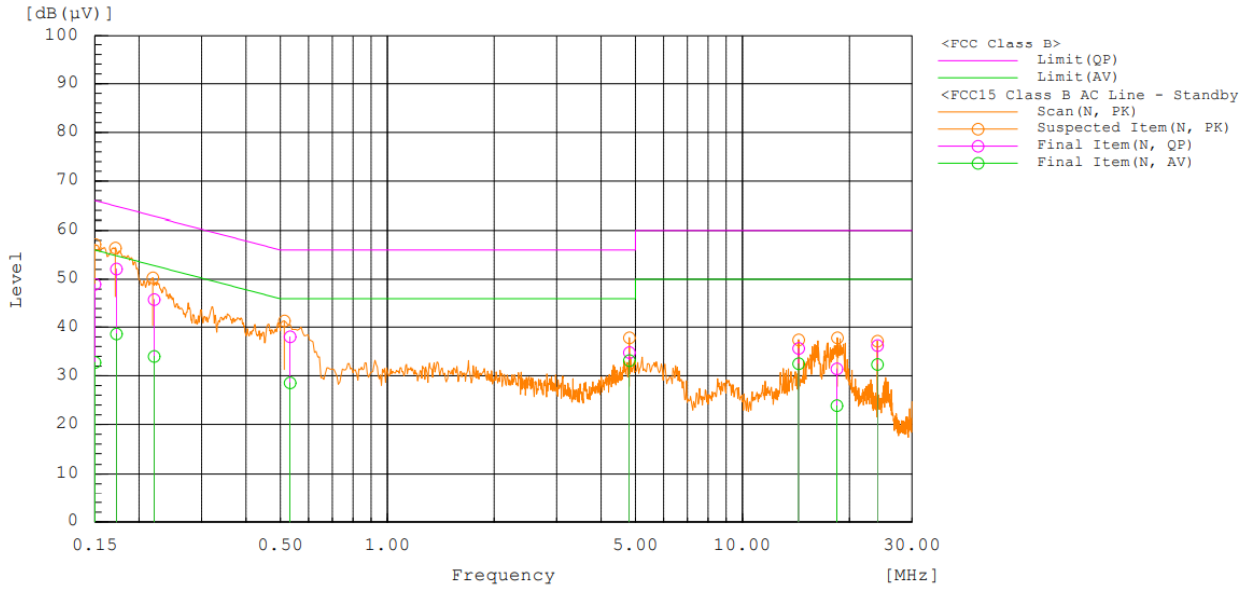

## 10. LIST OF TEST EQUIPMENT

No.	Instrument	Model No.	Calibration Due (mm/dd/yy)	Manufacture	Serial No.
<input checked="" type="checkbox"/>	Signal Analyzer (20 Hz ~ 40.0 GHz)	ESU40	12/20/2020	ROHDE & SCHWARZ	100529
<input checked="" type="checkbox"/>	Signal Analyzer (10 Hz ~ 40.0 GHz)	ESR40	03/23/2021	ROHDE & SCHWARZ	101424
<input type="checkbox"/>	Signal Analyzer (10 Hz ~ 26.5 GHz)	N9020A	11/08/2020	Keysight	MY52091291
<input checked="" type="checkbox"/>	BI-LOG Antenna (30 MHz ~ 1 GHz)	JB1	03/27/2021	Sunol	A061416
<input checked="" type="checkbox"/>	Attenuator (20 dB, DC ~ 26.5 GHz)	8493C	12/13/2020	HP	09072
<input checked="" type="checkbox"/>	POWER AMP (0.3GHz ~ 1GHz)	8447D	08/06/2021	HP	2443A03587
<input checked="" type="checkbox"/>	Loop Antenna (0.009 ~ 30 MHz)	HLA 6121	08/27/2020	TESEQ	43964
<input checked="" type="checkbox"/>	EMI Test Receiver	ESR3	12/20/2020	Rohde & Schwarz	102363
<input checked="" type="checkbox"/>	LISN	3816/2SH	01/19/2021	EMCO	00205729
<input checked="" type="checkbox"/>	LISN	ENV216	01/19/2021	Rohde & Schwarz	101349
<input checked="" type="checkbox"/>	Temp & Humidity Chamber	SH-641	08/05/2021	ESPEC	92002929
<input checked="" type="checkbox"/>	Frequency Counter	53181A	08/03/2021	Agilent	MY40002090

**Note:**

1. Equipment listed above that calibrated during the testing period was set for test after the calibration.
2. Equipment listed above that has a calibration due date during the testing period, the testing is completed before equipment expiration date

## APPENDIX A. TEST SETUP PHOTOS

*The setup photos are provided as a separate document*

## APPENDIX B. PHOTOGRAPHS OF EUT

### B.1. EXTERNAL PHOTOS

*The setup photos are provided as a separate document*

### B.2. INTERNAL PHOTOS

*The setup photos are provided as a separate document*

**END OF TEST REPORT**