

## Nemko Korea Co., Ltd.

159 Osan-ro, Mohyeon-myeon, Cheoin-gu, Yongin-si, Gyeonggi-do, 16885, Republic of Korea

TEL:+82 31 330 1700

FAX:+82 31 330 2332

### FCC and IC EVALUATION REPORT FOR CERTIFICATION

**Applicant :**

Anam Electronics Co., Ltd.  
27, Digital-ro 27ga-gil, Guro-gu, Seoul,  
08375, Republic of Korea.  
Attn. : Byeong-Seob, Lee

Dates of Issue : September 21, 2016

Test Report No. : NK-16-R-077

Test Site : Nemko Korea Co., Ltd.

FCC  
IC

Brand Name

Contact Person

**MBBPWSOUNDBAR  
11657A-PWSOUNDBAR****PARADIGM**

Anam Electronics Co., Ltd.  
27, Digital-ro 27ga-gil, Guro-gu, Seoul,  
08375, Republic of Korea.  
Byeong-Seob, Lee  
Telephone No. : +82-2-6424-4881

Applied Standard: FCC 47 CFR Part 15.247 and IC RSS-247 Issue 1  
Classification: FCC Part 15 Spread Spectrum Transmitter (DSS)  
EUT Type: SOUNDBAR

The device bearing the brand name and model specified above has been shown to comply with the applicable technical standards as indicated in the measurement report and was tested in accordance with the measurement procedures specified in ANSI C63.10-2013. The client should not use it to claim product endorsement by TAF or any government agencies. The test results in the report only apply to the tested sample.

I attest to the accuracy of data and all measurements reported herein were performed by me or were made under my supervision and are correct to the best of my knowledge and belief. I assume full responsibility for the completeness of these measurements and vouch for the qualifications of all persons taking them.

 Sep 21, 2016

Tested By : Wonho Son  
Engineer

 Sep 21, 2016

Reviewed By : Deokha Ryu  
Technical Manager

# TABLE OF CONTENTS

---

<b>1. Scope</b>	<b>4</b>
<b>2. Introduction (Site Description)</b>	<b>5</b>
2.1 Test facility	5
2.2 Accreditation and listing	6
<b>3. Test Conditions &amp; EUT Information</b>	<b>7</b>
3.1 Operation During Test	7
3.1.1 Table of test power setting	7
3.1.2 Table of test channels	7
3.1.3 Antenna TX mode information	7
3.1.4 Additional Information Related to testing	7
3.1.5 Other Information	8
3.2 Support Equipment	8
3.3 Setup Drawing	8
3.4 EUT Information	9
<b>4. Summary of Test Results</b>	<b>10</b>
<b>5. Recommendation / Conclusion</b>	<b>11</b>
<b>6. Antenna Requirements</b>	<b>11</b>
<b>7. Description of Test</b>	<b>12</b>
7.1 Conducted Emissions	12
7.2 Radiated Emissions	13
7.3 20 dB Bandwidth	14
7.4 Carrier Frequency Separation	14
7.5 Transmitter Average Time of Occupancy	15
7.6 Number of Hopping Channels	15
7.7 Maximum Peak Output Power	16
7.8 Conducted Spurious Emissions	16

<b>8.</b>	<b>Test Data</b>	<b>17</b>
	8.1 Conducted Emissions	17
	8.2 Radiated Emissions	20
	8.3 20 dB Modulated Bandwidth	22
	8.4 Carrier Frequency Separation	28
	8.5 Transmitter Average Time of Occupancy	31
	8.6 Number of Hopping Channels	33
	8.7 Peak Output Power and E.I.R.P	34
	8.8 Conducted Spurious Emissions	40
	8.9 Radiated Spurious Emissions	52
	8.10 Radiated Bandedge	58
<b>9.</b>	<b>Test Equipment</b>	<b>61</b>
<b>10</b>	<b>Accuracy of Measurement</b>	<b>62</b>

## 1. SCOPE

---

Measurement and determination of electromagnetic emissions (EME) of radio frequency devices including intentional and/or unintentional radiators for compliance with the technical rules and regulations of the Federal Communications Commission under FCC part 15 and IC RSS-247 Issue1

<b>Responsible Party :</b>	Anam Electronics Co., Ltd. 27, Digital-ro 27ga-gil, Guro-gu, Seoul, 08375, Republic of Korea
<b>Contact Person :</b>	Byeong Seob, Lee
<b>Manufacturer :</b>	Paradigm Electronics Inc 205 Annagem Blvd, Mississauga, ON, L7G 5J4, CANADA

- FCC ID : MBBPWSOUNDBAR
- IC : 11657A-PWSOUNDBAR
- Model: PW SOUNDBAR
- Brand Name: PARADIGM
- EUT Type: SOUNDBAR
- Classification: Part 15 Spread Spectrum Transmitter
- Applied Standard: FCC 47 CFR Part 15 subpart C and IC RSS-247 Issue 1
- Test Procedure(s): ANSI C63.10-2013
- Dates of Test: July 04, 2016 ~ August 11, 2016
- Place of Tests: Nemko Korea Co., Ltd.

## 2. INTRODUCTION

### 2.1 Test facility

The measurement procedure described in American National Standard for Methods of Measurement of Radio-Noise Emissions from Low-Voltage Electrical and Electronic Equipment in the Range of 9 kHz to 40 GHz (ANSI C63.4-2014), the American National Standard for Testing Unlicensed Wireless Devices (ANSI C63.10-2013) was used in determining radiated and conducted emissions emanating from **Anam Electronics Co., Ltd. FCC ID : MBBPWSOUNDBAR** and **IC : 11657A-PWSOUNDBAR**.

These measurement tests were conducted at **Nemko Korea Co., Ltd. EMC Laboratory** .

The site address 159, Osan-ro, Mohyeon-myeon, Cheoin-gu, Yongin-si, Gyeonggi-do, 16885, Republic of Korea.

The area of Nemko Korea Corporation Ltd. EMC Test Site is located in a mountain area at 80 km (48 miles) southeast and Incheon International Airport (Incheon Airport), 30 km (18miles) south-southeast from central Seoul.

It is located in the valley surrounded by mountains in all directions where ambient radio signal conditions are quiet and a favorable area to measure the radio frequency interference on open field test site for the computing and ISM devices manufactures.

The detailed description of the measurement facility was found to be in compliance with the requirements of ANSI C63.4-2014 according to §2.948.









Nemko Korea Co., Ltd.  
 EMC Lab.  
 159, Osan-ro, Mohyeon-myeon,  
 Cheoin-gu, Yongin-si, Gyeonggi-do,  
 16885, Republic of Korea.  
 Tel)+82-31-330-1700  
 Fax)+82-31-322-2332

Fig. 1. The map above shows the Seoul in Korea vicinity area.

The map also shows Nemko Korea Corporation Ltd. EMC Lab. and Incheon Airport.

## 2.2 Accreditation and listing

	Accreditation type	Accreditation number
	CAB Accreditation for DOC	Designation No. KR0026
	KOLAS Accredited Lab. (Korea Laboratory Accreditation Scheme)	Registration No. 155
	Canada IC Registered site	Site No. 2040E
	VCCI registration site(RE/CE/Telecom CE)	Member No. 2118
	EMC CBTL	-
	KCC(RRL)Designated Lab.	Registration No. KR0026

### 3. TEST CONDITIONS & EUT INFORMATION

#### 3.1 Operation During Test

The EUT is the transceiver which is the Bluetooth 4.1 module supporting BDR/EDR/LE mode. The Laptop was used to control the EUT to transmit the wanted TX channel by the testing program (Bluetest) which manufacturer supported. The Laptop was removed after controlling the EUT to transmit the wanted signal. The EUT was tested at the lowest channel, middle channel and the highest channel with the maximum output power in accordance with the manufacturer's specifications. The worst data were recorded in the report.

##### 3.1.1 Table of test power setting

Mode	Frequency Band	Power Setting Level	
		Ext. Power	255
GFSK/ $\pi/4$ DQPSK/ 8DPSK	2402 MHz ~ 2480 MHz	Int. Power	50

##### 3.1.2 Table of test channels

Frequency band	Mode	Test Channel (CH)	Frequency (MHz)
2.4 GHz	GFSK, $\pi/4$ DQPSK, 8DPSK	0	2402
		39	2441
		78	2480

##### 3.1.3 Antenna TX mode information

Frequency band	Mode	Antenna TX mode	Support MIMO
2.4 GHz	GFSK, $\pi/4$ DQPSK, 8DPSK	<input checked="" type="checkbox"/> 1TX, <input type="checkbox"/> 2TX	<input type="checkbox"/> Yes, <input checked="" type="checkbox"/> No

##### 3.1.4. Additional Information Related to Testing

The cable and attenuator loss from 30MHz to 25GHz was reflected in spectrum analyzer with correction factor for all conducted testing.

### 3.1.5 Other information

RF modules certified as below are installed in this device.

Product name	Module name	Remark
Play-Fi	CAPRICA2L	WIFI module
Wireless Adapter Card	RS4	Data transmission device operated in 2.4 GHz band

### 3.2 Support Equipment

EUT	Anam Electronics Co., Ltd. Model : PW SOUNDBAR	S/N: N/A
Laptop Computer	Samsung Electronics Co., Ltd. Model : NT-R580 1.5 m shielded pin connector cable	FCC DOC S/N : ZNU793BZ200566M
AC/DC Adapter	LI SHIN INTERNATIONAL ENTERPRISE CORP. Model : AD-9019S 1.5 m unshielded power cable	FCC DOC S/N : CNBA4400215AD2VH9BQ9 226

### 3.3 Setup Drawing

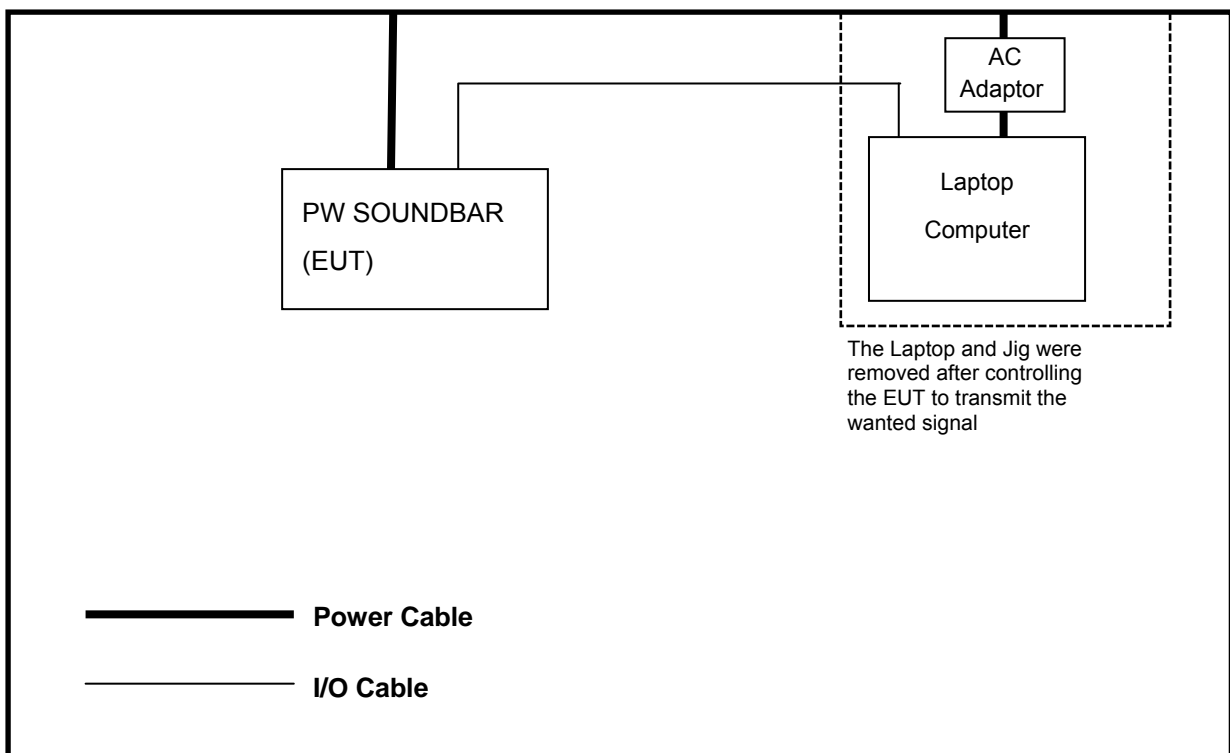



### 3.4 EUT Information

The EUT is the **Anam SOUNDBAR FCC ID: MBBPWSOUNDBAR, IC: 11657A-PWSOUNDBAR**. This unit supports full qualified Bluetooth 4.1 with EDR standard system.

Specifications:

EUT Type	SOUNDBAR
Model Name	PW SOUNDBAR
Brand Name	PARADIGM
RF Frequency	2402 MHz ~ 2480 MHz
Peak Power Output (Conducted)	8.28 dBm
FCC Classification	FCC Part 15 Spread Spectrum Transmitter (DSS)
Method/System	Frequency Hopping Spread Spectrum (FHSS)
Channel Number	79 ch
Modulations	GFSK, $\pi/4$ DQPSK, 8DPSK
Antenna Gain (peak)	0 dBi
Antenna Setup	1TX / 1RX
Voltage	Operating Voltage : 100 Vac ~ 240 Vac Test Voltage : 120 Vac
Temperature Range	0 °C ~ +50 °C
Size (H x W x D)	Table Mount : About 8.9 cm x 117 cm x 12.7 cm Wall Mount : About 12.7 cm x 117 cm x 9.9 cm
Weight	About 5.4 kg
H/W Status	
S/W Status	
Remarks	-

## 4. SUMMARY OF TEST RESULTS

The EUT has been tested according to the following specification:

Name of Test	FCC Paragraph No.	IC Paragraph No.	Result	Remark
Conducted Emission	15.207	RSS-GEN Issue 4 8.8	Complies	
Radiated Emission	15.209	RSS-GEN Issue 4 8.9	Complies	
20dB Bandwidth	15.247(a)(1)	RSS-247 Issue 1 5.1	Complies	
Carrier Frequency Separation	15.247(a)(1)	RSS-247 Issue 1 5.1(2)	Complies	
Transmitter Average Time of Occupancy	15.247(a)(1)(iii)	RSS-247 Issue 1 5.1(4)	Complies	
Peak Output Power and E.I.R.P	15.247(b)(1)	RSS-247 Issue 1 5.4(2)	Complies	
Conducted Spurious Emission	15.247(d)	RSS-247 Issue 1 5.5	Complies	
Radiated Spurious Emission	15.247(d)	RSS-247 Issue 1 5.5	Complies	
Number of Hopping channels	15.247(a)(1)(iii)	RSS-247 Issue 1 5.1(4)	Complies	

## 5. RECOMMENDATION/CONCLUSION

---

The data collected shows that the **Anam SOUNDBAR FCC ID: MBBPWSOUNDBAR, IC: 11657A-PWSOUNDBAR** is in compliance with Part 15.247 of the FCC Rule and RSS-247 Issue 1 of the IC specification.

## 6. ANTENNA REQUIREMENTS

---

### §15.203 of the FCC Rules part 15 Subpart C

: An intentional radiator shall be designed to ensure that no antenna other than that furnished by the responsible party shall be used with the device. The use of a permanently attached antenna or of an antenna that uses a unique coupling to the intentional radiator shall be considered sufficient to comply with the provisions of this section.

The antenna of the **Anam SOUNDBAR FCC ID: MBBPWSOUNDBAR, IC: 11657A-PWSOUNDBAR** is **permanently attached** and there are no provisions for connection to an external antenna. It complies with the requirement of §15.203.

## 7. DESCRIPTION OF TESTS

### 7.1 Conducted Emissions

The Line conducted emission test facility is located inside a 4 x 7 x 2.5 meter shielded enclosure. It is manufactured by EM engineering. The shielding effectiveness of the shielded room is in accordance with MIL-STD-285 or NSA 65-6. A 1 m x 1.5 m wooden table 0.8 m height is placed 0.4 m away from the vertical wall and 1.5 m away from the side of wall of the shielded room. Rohde & Schwarz (ESH3-Z5) and (ESH2-Z5) of the 50 ohm/50  $\mu$ H Line Impedance Stabilization Network (LISN) are bonded to the shielded room. The EUT is powered from the Rohde & Schwarz LISN (ESH3-Z5) and the support equipment is powered from the Rohde & Schwarz LISN (ESH2-Z5). Power to the LISNs are filtered by high-current high insertion loss Power line filters. The purpose of filter is to attenuate ambient signal interference and this filter is also bonded to shielded enclosure. All electrical cables are shielded by tinned copper zipper tubing with inner diameter of 1 / 2 ". If DC power device, power will be derived from the source power supply it normally will be powered from and this supply lines will be connected to the LISNs, All interconnecting cables more than 1 meter were shortened by non inductive bundling (serpentine fashion) to a 1 meter length. Sufficient time for EUT, support equipment, and test equipment was allowed in order for them to warm up to their normal operating condition. The RF output of the LISN was connected to the spectrum analyzer to determine the frequency producing the maximum EME from the EUT. The spectrum was scanned from 150 kHz to 30 MHz with 200 msec sweep time. The frequency producing the maximum level was re-examined using the EMI test receiver. (Rohde & Schwarz ESCS30). The detector functions were set to CISPR quasi-peak mode & average mode. The bandwidth of receiver was set to 9 kHz. The EUT, support equipment, and interconnecting cables were arranged and manipulated to maximize each EME emission. Each emission was maximized by; switching power lines; varying the mode of operation or resolution; clock or data exchange speed; scrolling H pattern to the EUT and of support equipment, and powering the monitor from the floor mounted outlet box and computer aux AC outlet, if applicable; whichever determined the worst case emission.

Each EME reported was calibrated using the R&S signal generator.

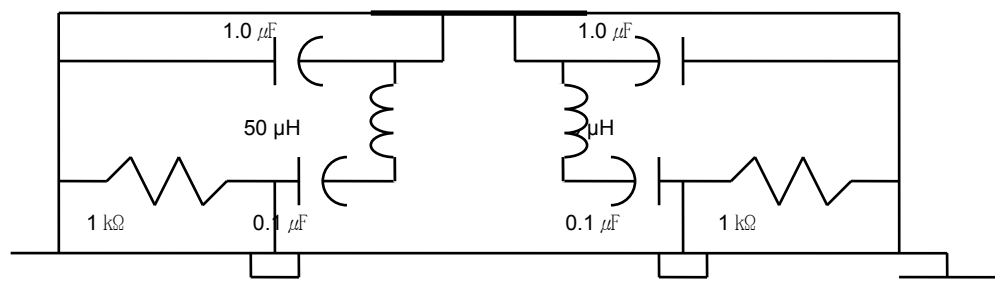

Fig. 2. LISN Schematic Diagram

## 7.2 Radiated Emissions

The measurement was performed at the test site that is specified in accordance with ANSI C63.10-2013.

The spurious emission was scanned from 9 kHz to 30 MHz using Loop Antenna(Rohde&Schwarz, HFH2-Z2) and 30 to 1000 MHz using Trilog broadband test antenna(Schwarzbeck, VULB 9163). Above 1 GHz, Horn antenna (Schwarzbeck BBHA 9120D: up to 18 GHz, Q-par Angus QSH20S20 : 18 to 26.5 GHz, QSH22K20: up to 40 GHz) was used.

For emissions testing at below 1GHz, The test equipment was placed on turntable with 0.8 m above ground. For emission measurements above 1 GHz, The test equipment was placed on turntable with 1.5 m above ground. Sufficient time for the EUT, support equipment, and test equipment was allowed in order for them to warm up to their normal operating condition. The EUT, cable, wire arrangement and mode of operation that has the highest amplitude relative to the limit was selected. Then, the turn table was rotated from 0° to 360° and an antenna mast was moved from 1 m to 4 m height to maximize the suspected highest amplitude signal. The final maximized level was recorded.

At frequencies below 1000 MHz, measurements performed using the CISPR quasi-peak detection. At frequencies above 1000 MHz, measurements performed using the peak and average measurement procedures described in ANSI C63.10-2013. Peak emission levels were measured by setting the analyzer RBW = 1 MHz, VBW = 3 MHz, Detector = Peak, Trace mode = max hold. Average emission levels were measured by setting the analyzer RBW = 1 MHz, VBW = 1 kHz, Detector = Peak, Trace mode = max hold.

Frequency (MHz)	Field strength (microvolts/meter)	Measurement distance (meters)
0.009–0.490	2400/F(kHz)	300
0.490–1.705	24000/F(kHz)	30
1.705–30.0	30	30
30–88	100	3
88–216	150	3
216–960	200	3
Above 960	500	3

Radiated Emissions Limits per 47 CFR 15.209(a) and Radiated Emissions Limits per RSS-GEN Issue 4 8.9

### 7.3 20 dB Bandwidth

#### Test Setup

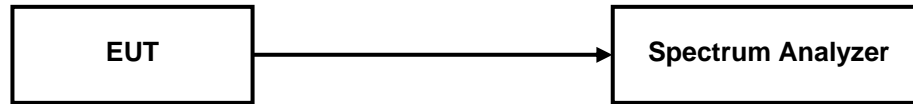

#### Test Procedure

The transmitter is set to the Low, Middle, High channels is connected to the spectrum analyzer.

Span = approximately 2 to 5 times the 20 dB bandwidth, centered on a hopping channel

RBW = 1% to 5% of the OBW

VBW = approximately 3 x RBW

Sweep = auto

Detector function = peak

Trace = max hold

### 7.4 Carrier Frequency Separation

#### Test Setup

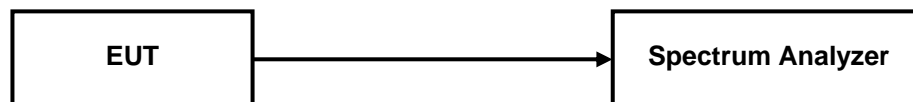

#### Test Procedure

The EUT must have its hopping function enabled. The following spectrum analyzer setting is used.

Span = wide enough to capture the peaks of two adjacent channels

RBW  $\geq$  approximately 30% of the channel spacing; adjust as necessary to best identify the center of each individual channel

VBW  $\geq$  RBW

Sweep = auto

Detector function = peak

Trace = max hold

Allow the trace to stabilize. Use the marker-delta function to determine the separation between the peaks of the adjacent channels.

## 7.5 Transmitter Average Time of Occupancy

### Test Setup

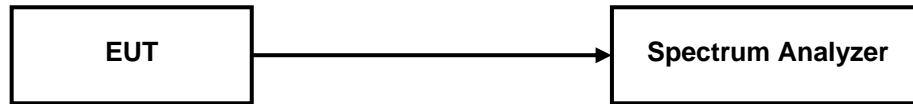

### Test Procedure

The transmitter output is connected to a spectrum analyzer. The following spectrum analyzer setting is used.

Span = Zero span, centered on a hopping channel

RBW  $\gg 1 / T$ , where  $T$  is the expected dwell time per channel.

VBW  $\geq$  RBW

Sweep = as necessary to capture the entire dwell time per hopping channel

Detector function = Peak

Trace = Single sweep

Use the marker-delta function to determine the width of pulse

## 7.6 Number of Hopping Channels

### Test Setup

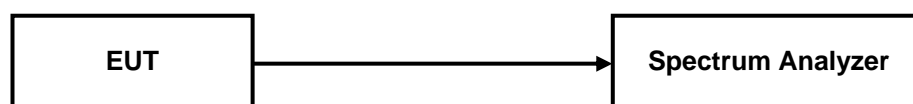

### Test Procedure

Span = The frequency band of operation.

RBW = less than 30% of the channel spacing or the 20 dB bandwidth, whichever is smaller.

VBW  $\geq$  RBW

Sweep = Auto

Detector function = Peak

Trace = Max hold

## 7.7 Peak Output Power

### Test Setup

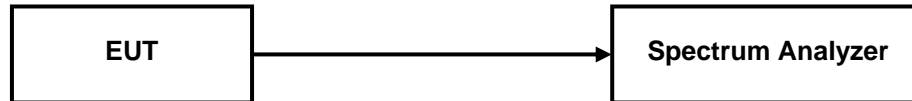

### Test Procedure

The transmitter is set to the Low, Middle, High channels is connected to the spectrum analyzer.

Span = approximately 5 times the 20 dB bandwidth, centered on a hopping channel

RBW = 20 dB bandwidth of the emission being measured

VBW  $\geq$  RBW

Sweep = auto

Detector function = peak

Trace = max hold

## 7.8 Conducted Spurious Emission

### Test Setup

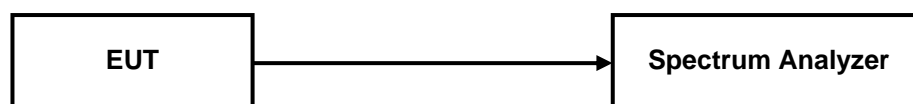

### Test Procedure

Measurements are made over the 30 MHz to 25 GHz range with the transmitter set to the Lowest, middle and highest channels.

RBW = 100kHz

VBW = 300kHz

Sweep = auto

Detector function = peak

Trace = max hold



## 8. TEST DATA

### 8.1 Conducted Emissions

#### FCC §15.207, IC RSS-GEN Issue 4 8.8

Frequency (MHz)	Level (dB $\mu$ V)		*) Factor (dB)	**) Line	Limit (dB $\mu$ V)		Margin (dB)	
	Q-Peak	Average			Q-Peak	Average	Q-Peak	Average
0.61	41.1	31.6	10.20	N	56.0	46.0	14.9	14.4
0.71	44.9	34.9	10.20	N	56.0	46.0	11.1	11.1
1.16	40.1	32.5	10.23	N	56.0	46.0	15.9	13.5
2.49	40.1	30.4	10.31	L	56.0	46.0	15.9	15.6
3.00	39.3	29.4	10.34	L	56.0	46.0	16.7	16.6
3.43	38.9	31.7	10.37	L	56.0	46.0	17.1	14.3

**Line Conducted Emissions Tabulated Data**

**Notes:**

1. Measurements using CISPR quasi-peak mode & average mode.
2. All modes of operation were investigated and the worst -case emission are reported. See attached Plots.
3. \*) Factor = LISN + Cable Loss
4. \*\*) LINE : L = Line , N = Neutral
5. 2480MHz was the worst case channel.
6. The limit is on the FCC §15.207 and IC RSS-GEN issue4 8.8.

# PLOTS OF EMISSIONS

● **Conducted Emission at the Mains port (Line)**

Nemko Korea (NK-16-R-077)

29 Jul 2016 14:01

**Conducted Emissions**

EUT: SOUNDBAR  
 Manuf: Anam Electronics Co., Ltd.  
 Op Cond: a.c. 120 V, 60 Hz (BT)  
 Operator: Wonho.Son  
 Test Spec: FCC Part 15  
 Comment: MODEL : PW SOUNDBAR  
 LINE : Line  
 Result File: r077\_l.dat :

Scan Settings (1 Range)

Frequencies			Receiver Settings					
Start	Stop	Step	IF BW	Detector	M-Time	Atten	Preamp	OpRge
150kHz	30MHz	3.9063kHz	9kHz	PK+AV	20msec	20 dB	OFF	60dB

Transducer	No.	Start	Stop	Name
	1	150kHz	30MHz	ESH3_Z5_Line

Final Measurement: Detectors: X QP / + AV  
 Meas Time: 1sec  
 Subranges: 8  
 Acc Margin: 60 dB

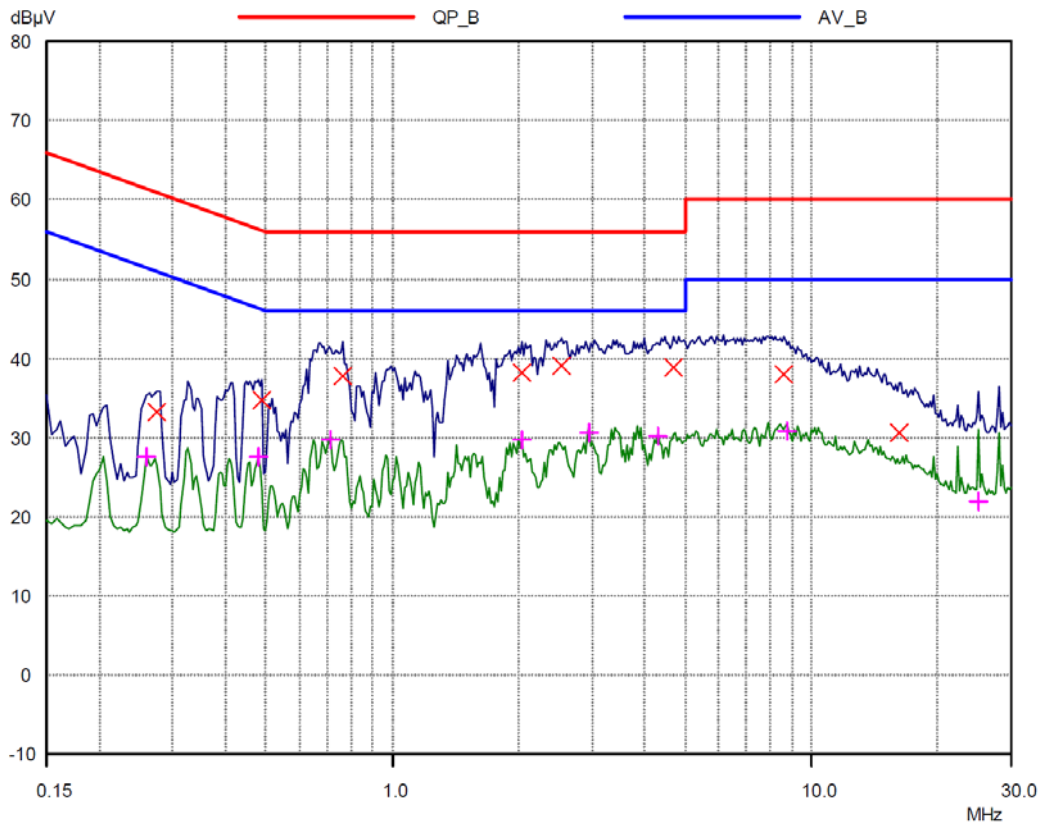

# PLOTS OF EMISSIONS

● **Conducted Emission at the Mains port (Neutral)**

Nemko Korea (NK-16-R-077)

29 Jul 2016 13:47

**Conducted Emissions**

EUT: SOUNDBAR  
 Manuf: Anam Electronics Co., Ltd.  
 Op Cond: a.c. 120 V, 60 Hz (BT)  
 Operator: Wonho.Son  
 Test Spec: FCC Part 15  
 Comment: MODEL : PW SOUNDBAR  
 LINE : Neutral  
 Result File: r077\_n.dat :

Scan Settings (1 Range)

Frequencies			Receiver Settings					
Start	Stop	Step	IF BW	Detector	M-Time	Atten	Preamp	OpRge
150kHz	30MHz	3.9063kHz	9kHz	PK+AV	20msec	20 dB	OFF	60dB

Transducer	No.	Start	Stop	Name
	1	150kHz	30MHz	ESH3_Z5_Neutral

Final Measurement: Detectors: X QP / + AV  
 Meas Time: 1sec  
 Subranges: 8  
 Acc Margin: 60 dB

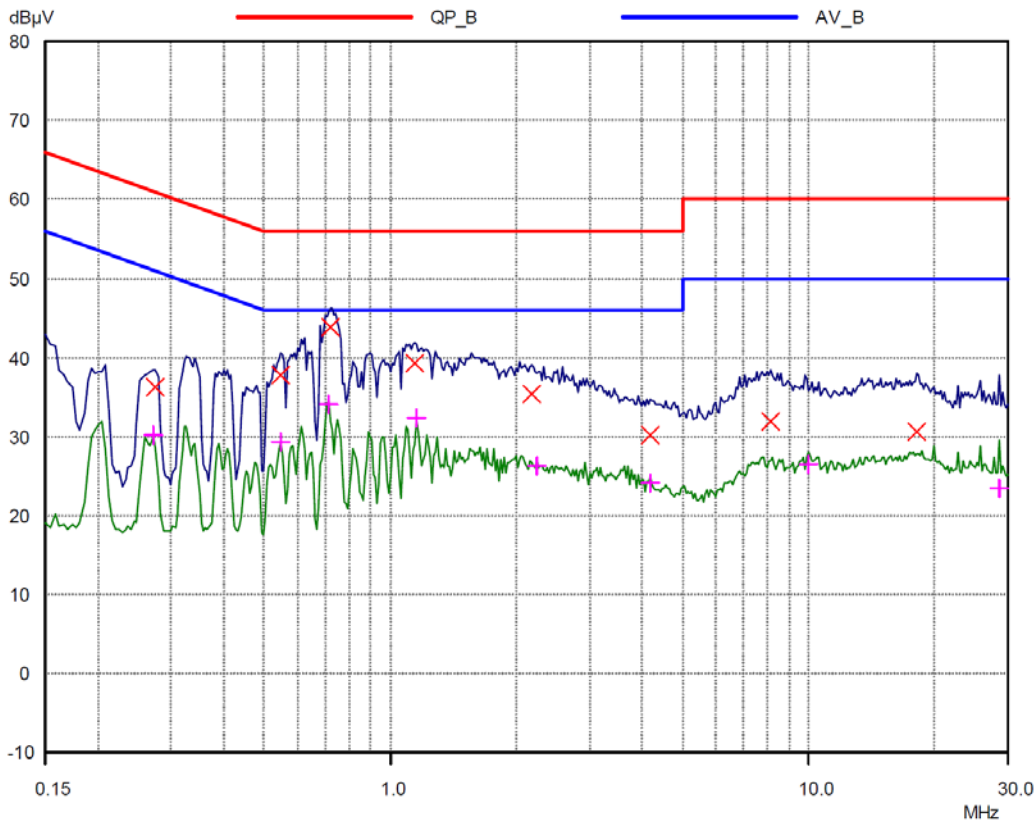

# TEST DATA

## 8.2 Radiated Emissions

### FCC §15.209, IC RSS-GEN Issue 4 8.9

#### Result

Frequency (MHz)	Reading (dB $\mu$ V/m)	Pol* (H/V)	Antenna Heights (cm)	Turntable Angles (°)	AF+CL+Amp (dB)**	Result (dB $\mu$ V/m)	Limit (dB $\mu$ V/m)	Margin (dB)
99.11	62.00	H	270	155	-23.5	38.5	43.5	5.0
270.32	61.80	H	370	284	-20.4	41.4	46.0	4.6
319.50	59.10	H	130	34	-19.0	40.1	46.0	5.9
417.81	52.40	H	100	34	-15.5	36.9	46.0	9.1
758.08	41.00	V	100	20	-9.1	31.9	46.0	14.1
909.35	43.10	V	100	315	-6.7	36.4	46.0	9.6

Radiated Measurements at 3 meters

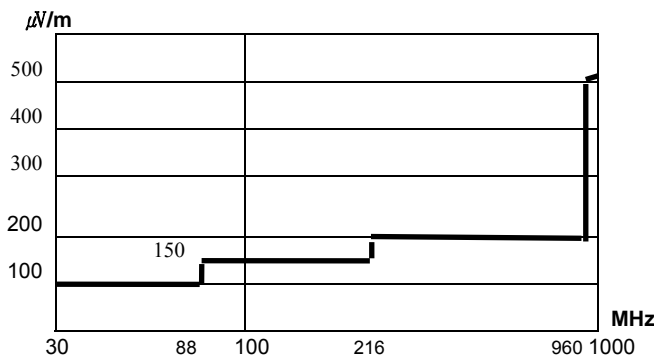

Fig. 3. Limits at 3 meters

#### Notes:

1. All modes were measured and the worst-case emission was reported.
2. The radiated limits are shown on Figure 3. Above 1GHz the limit is 500  $\mu$ V /m.
3. \*Pol. H = Horizontal, V = Vertical
4. \*\*AF + CL + Amp. = Antenna Factor + Cable Loss + Amplifier.
5. Measurements using CISPR quasi-peak mode below 1 GHz.
6. The radiated emissions testing were made by rotating the receive antenna with horizontal, Vertical polarization. The worst date was recorded.
7. No emission found between lowest internal used/generated frequency to 30MHz (9kHz~30MHz).

# PLOTS OF EMISSIONS

## Worst Case : 2480 MHz (below 1GHz) GFSK modulation

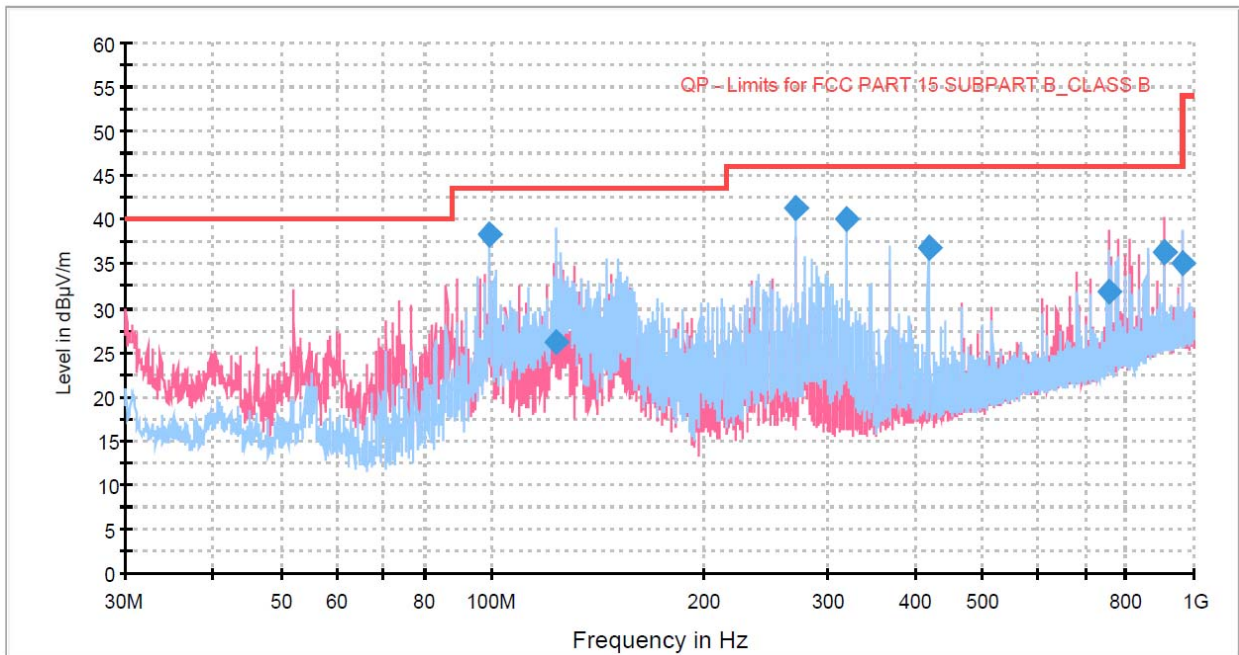

## TEST DATA

### 8.3 20 dB Modulated Bandwidth

FCC §15.247(a)(1)(iii), IC RSS-247 Issue 1, 5.1

Test Mode : Set to Lowest channel, Middle channel and Highest channel

#### Result

Modulation Mode	Frequency (MHz)	Result (kHz)	Limit (kHz)
GFSK	2402	947.2	Non specified
GFSK	2441	940.1	Non specified
GFSK	2480	944.8	Non specified
$\pi/4$ DQPSK	2402	1227.0	Non specified
$\pi/4$ DQPSK	2441	1269.0	Non specified
$\pi/4$ DQPSK	2480	1230.0	Non specified
8DPSK	2402	1263.0	Non specified
8DPSK	2441	1258.0	Non specified
8DPSK	2480	1259.0	Non specified

# PLOTS OF EMISSIONS

## 20 dB Bandwidth, Lowest Channel (2402 MHz, GFSK Mode)

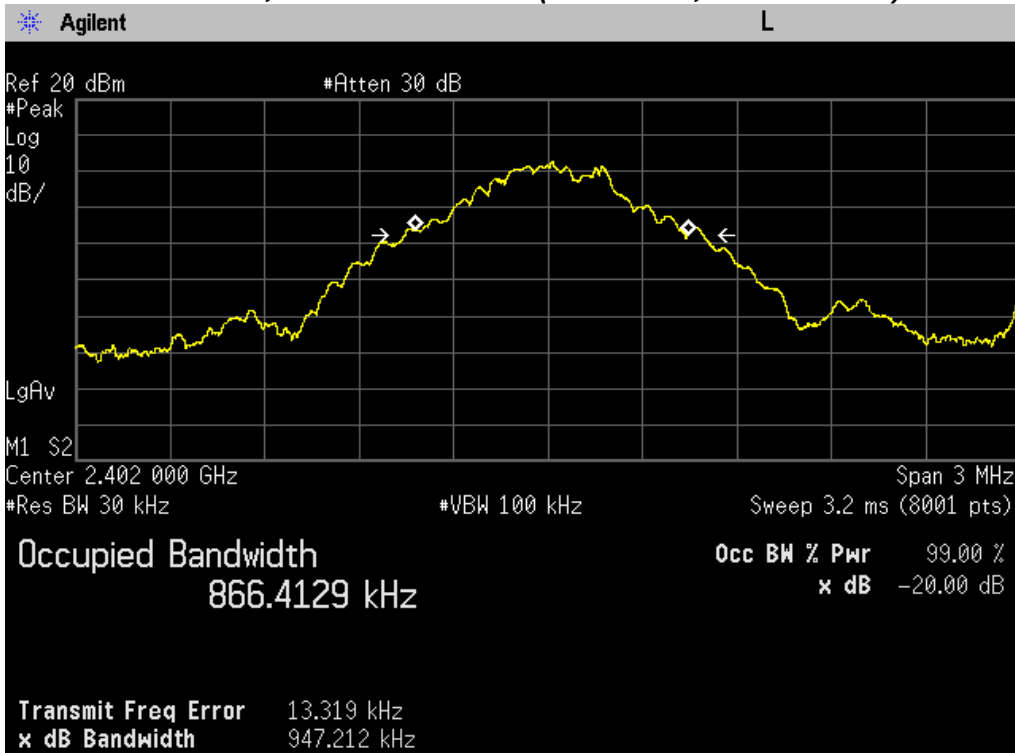

## 20 dB Bandwidth, Middle Channel (2441 MHz, GFSK Mode)

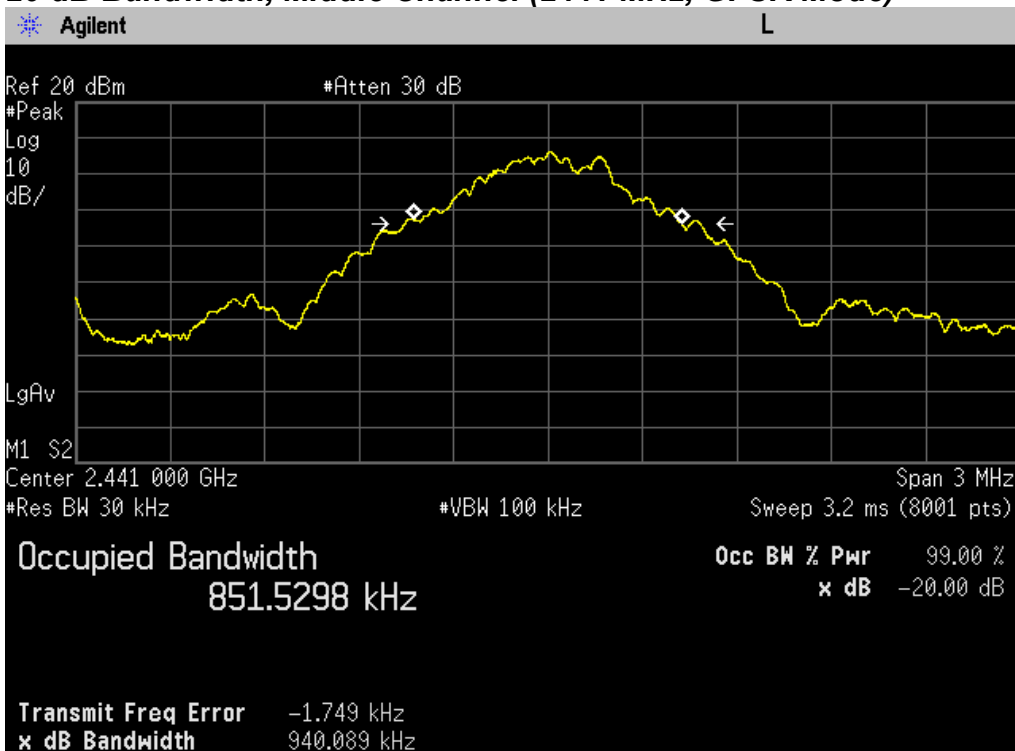

# PLOTS OF EMISSIONS

## 20 dB Bandwidth, Highest Channel (2480 MHz, GFSK Mode)

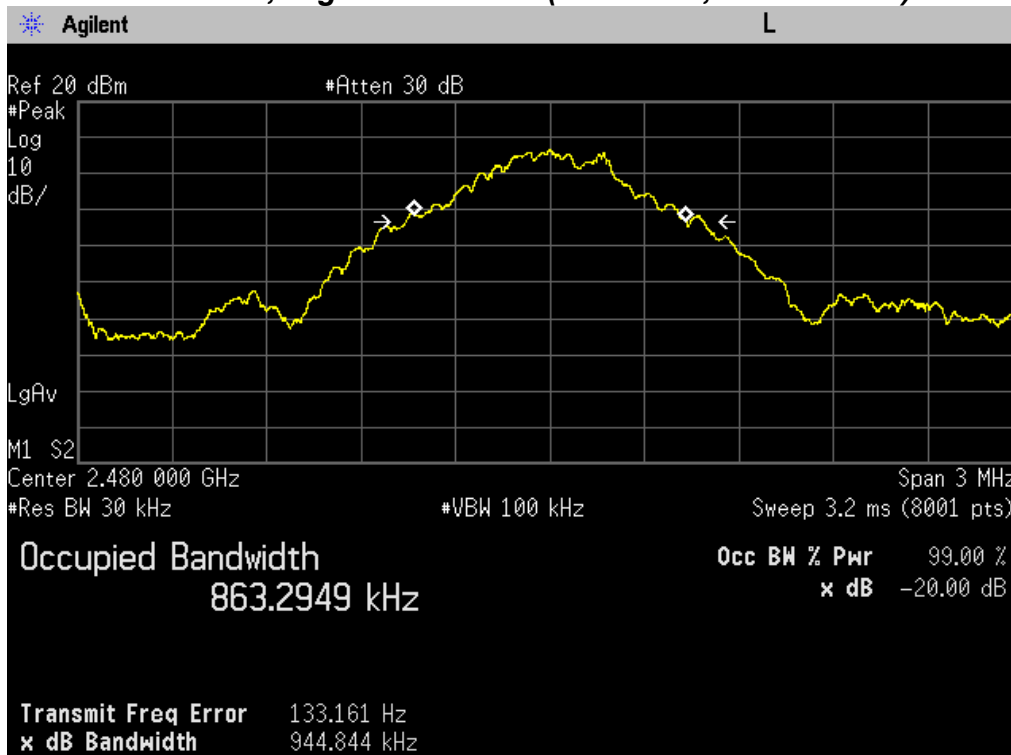

## 20 dB Bandwidth, Lowest Channel (2402 MHz, $\pi/4$ DQPSK Mode)

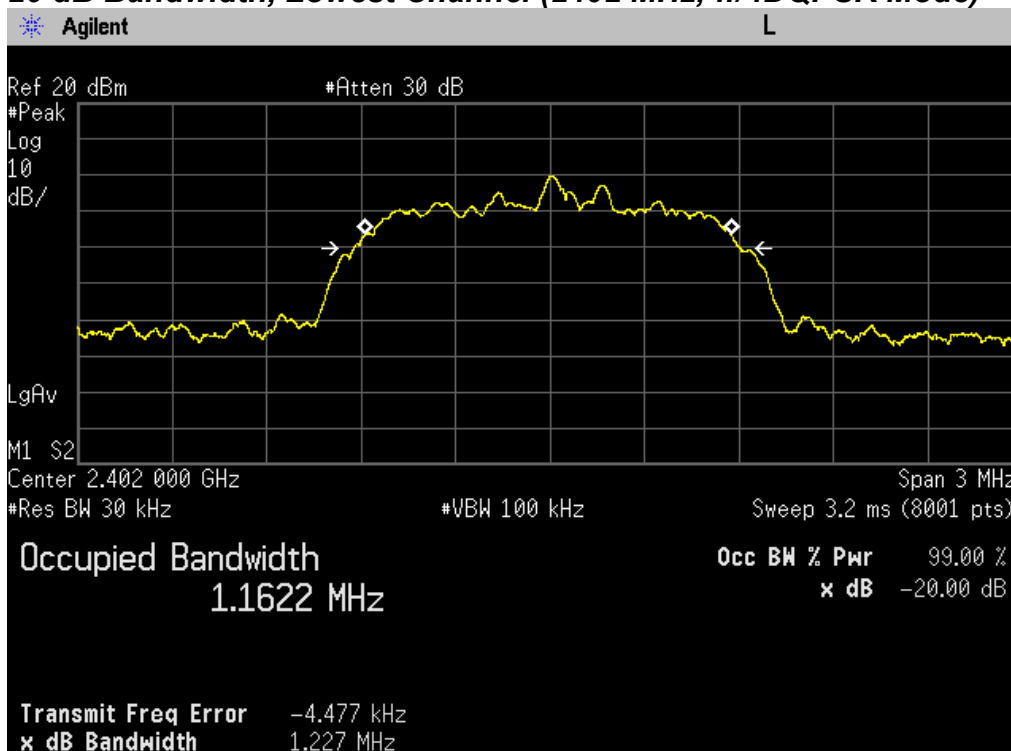



# PLOTS OF EMISSIONS

## 20 dB Bandwidth, Middle Channel (2441 MHz, $\pi/4$ DQPSK Mode)

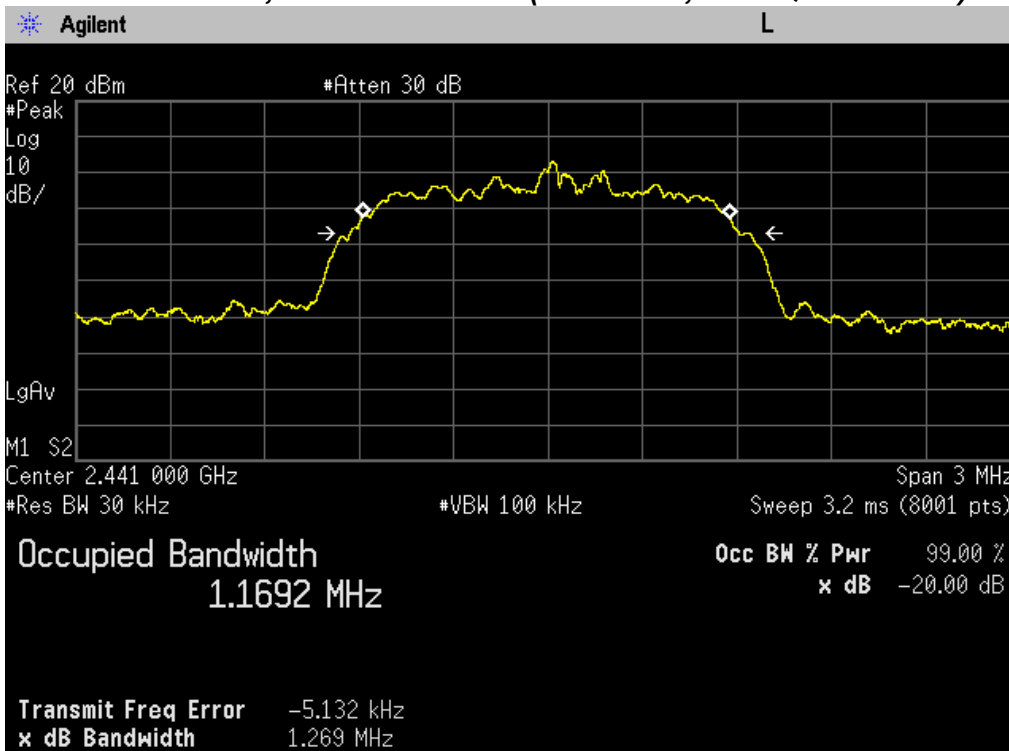

## 20 dB Bandwidth, Highest Channel (2480 MHz, $\pi/4$ DQPSK Mode)



# PLOTS OF EMISSIONS

## 20 dB Bandwidth, Lowest Channel (2402 MHz, 8DPSK Mode)

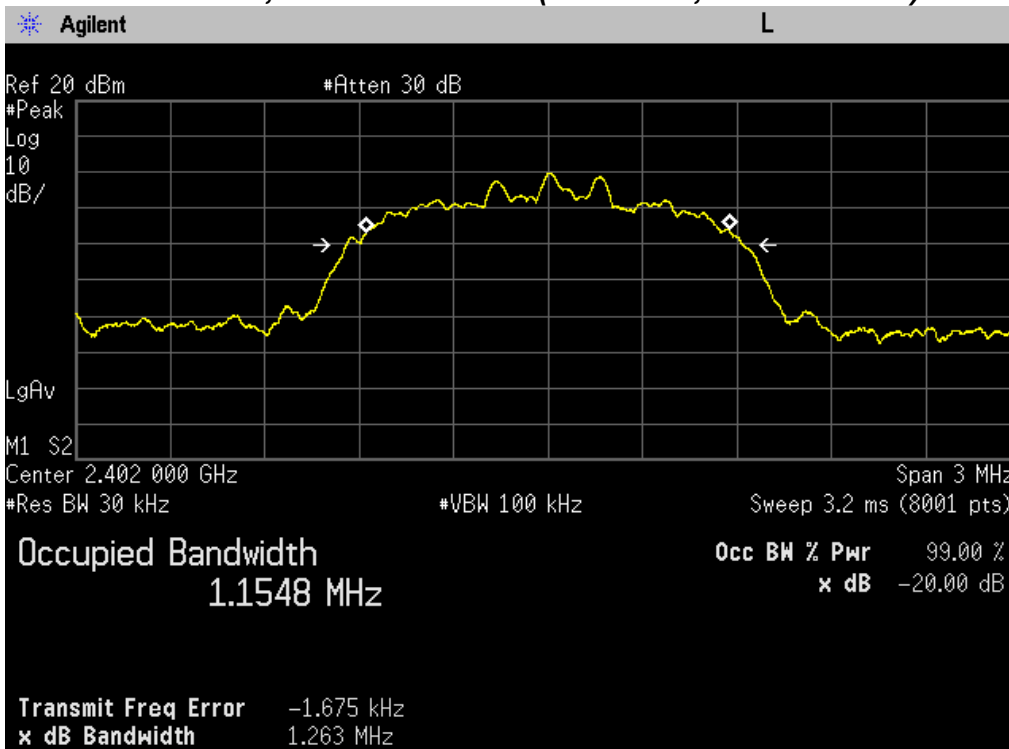

## 20 dB Bandwidth, Middle Channel (2441 MHz, 8DPSK Mode)

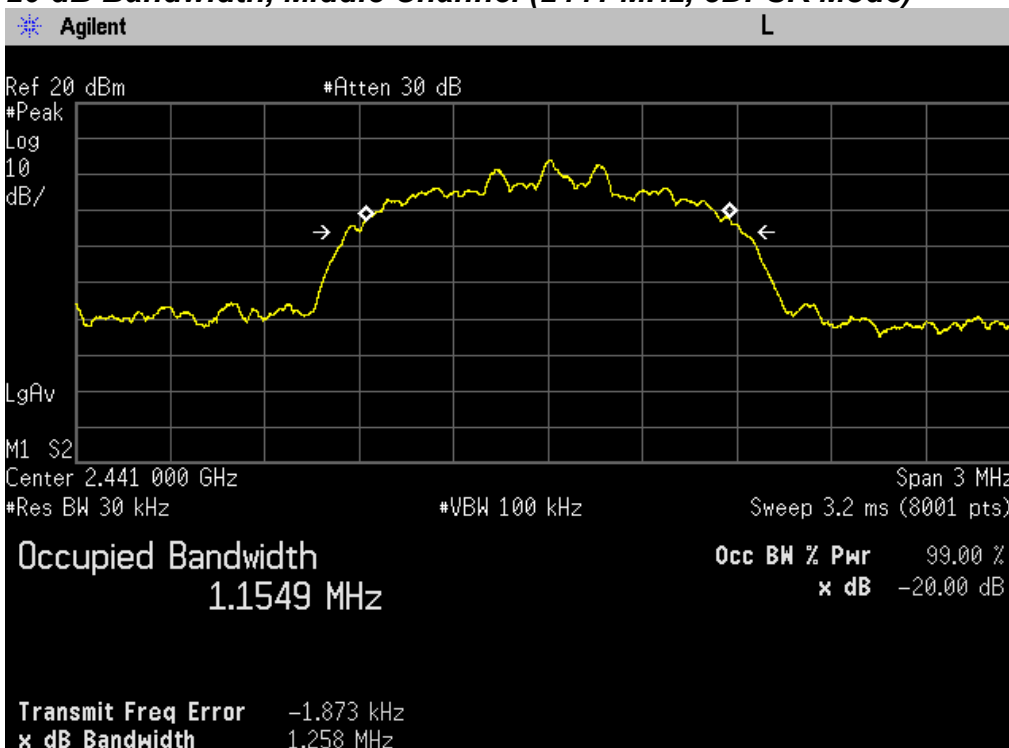

# PLOTS OF EMISSIONS

## 20 dB Bandwidth, Highest Channel (2480 MHz, 8DPSK Mode)

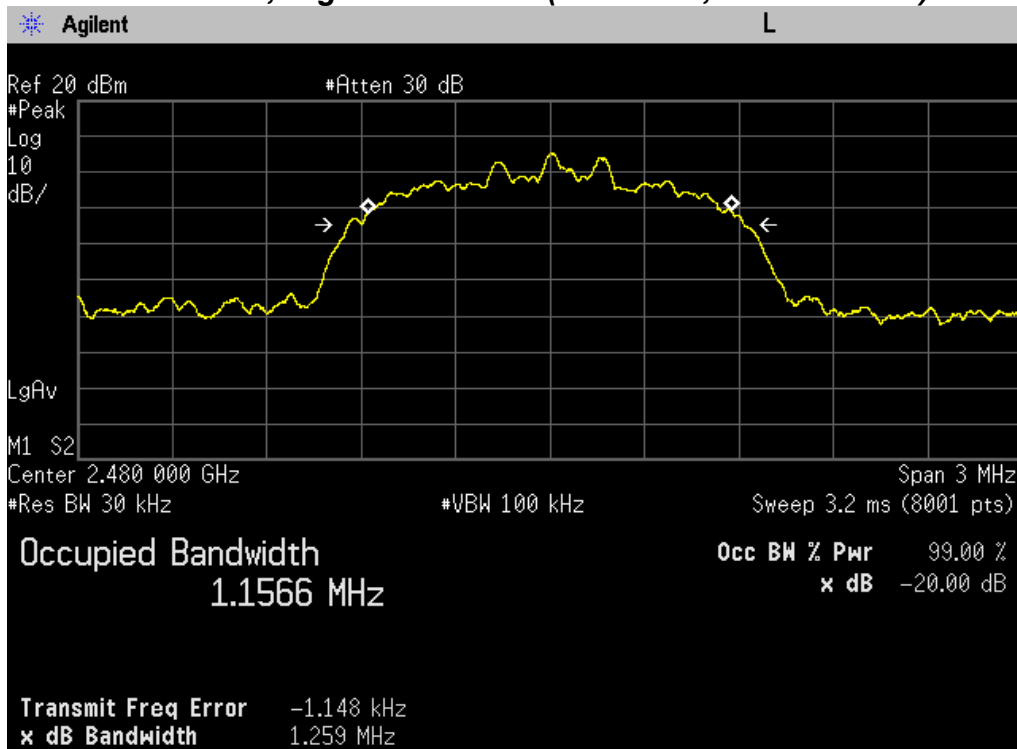

## TEST DATA

---

### 8.4 Carrier Frequency Separation

FCC §15.247(a)(1), IC RSS-247 Issue 1, 5.1(2)

Test Mode : Set to Hopping mode

#### Result

Modulation Mode	Carrier Frequency Separation (kHz)	Limit (2 / 3 of 20dB Bandwidth) (kHz)	Margin (kHz)
GFSK	1000	626.7	373.3
$\pi/4$ DQPSK	1000	818.0	182.0
8DPSK	1030	838.7	161.3

#### Note:

The EUT complies with the minimum channel separation requirement when it is operating **1x/EDR mode using 79 channels** and when operating in **AFH mode using 20 channels**.

# PLOTS OF EMISSIONS

## Carrier Frequency Separation (GFSK Mode)

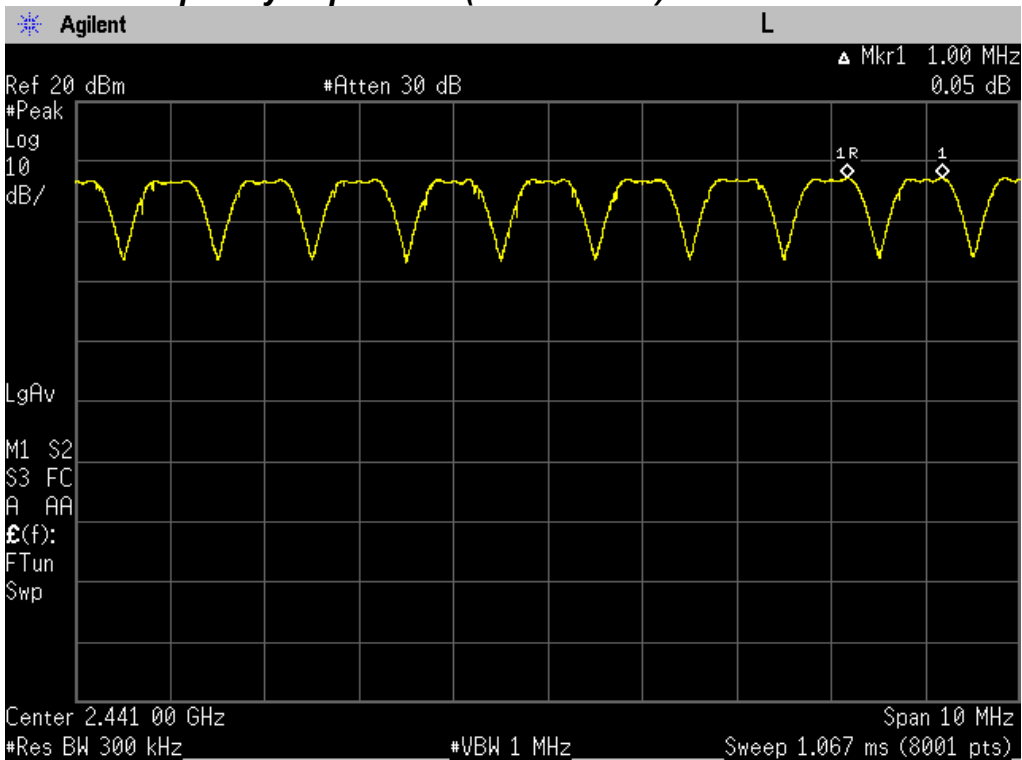

## Carrier Frequency Separation ( $\pi/4$ DQPSK Mode)

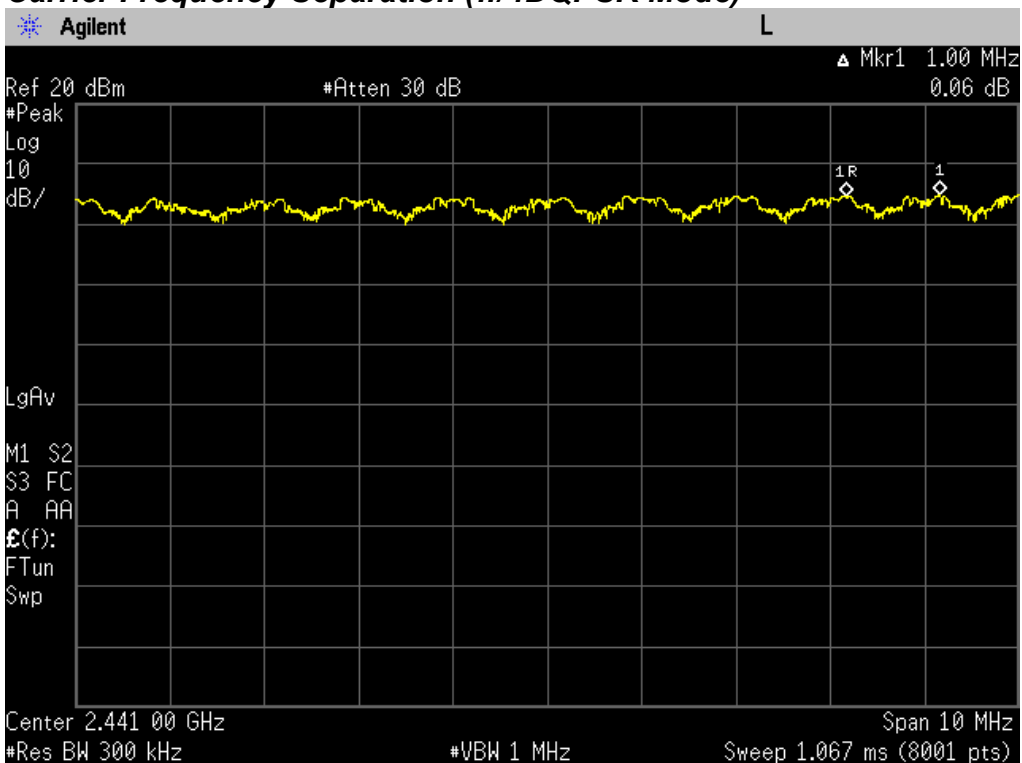

# PLOTS OF EMISSIONS

## Carrier Frequency Separation (8DPSK Mode)

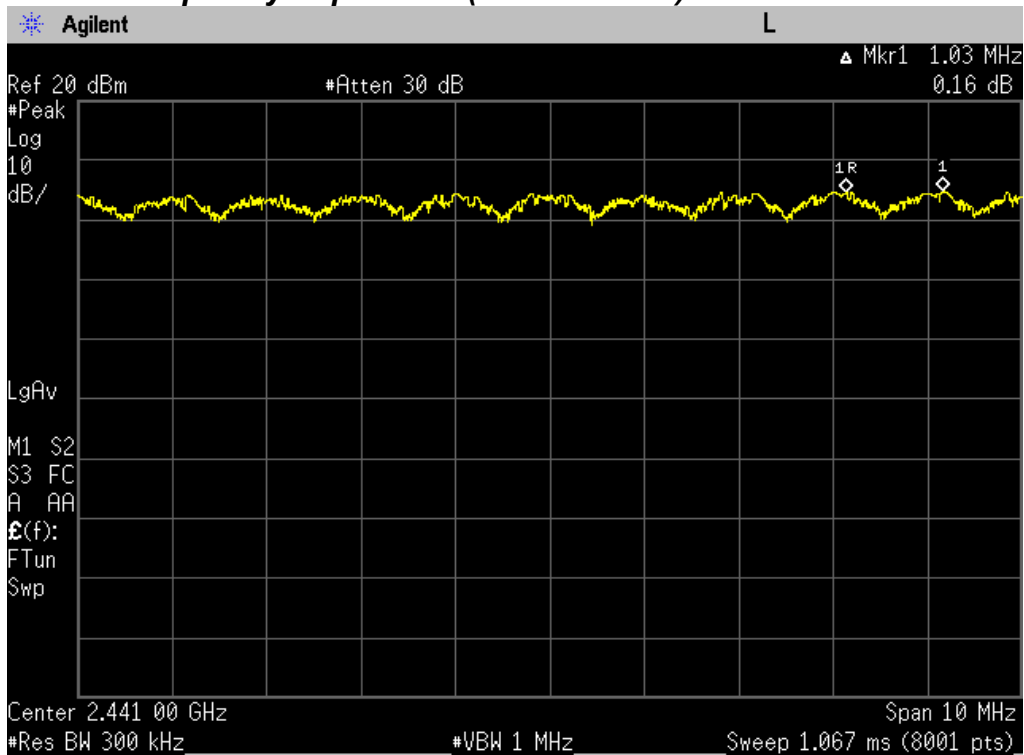

# TEST DATA

## 8.5 Transmitter Average Time of Occupancy

FCC §15.247(a)(1), IC RSS-247 Issue 1, 5.1(4)

Test mode : Set to Hopping mode

### Result

Mode	Pulse width (ms)	<sup>*)</sup> Numbers of slots	<sup>**)</sup> Average time of Occupancy (ms)	Limit (ms)	Margin (ms)
1x/EDR	2.89	106.7	308.4	≤ 400	91.6
AFH	2.89	53.3	154.1	≤ 400	245.9

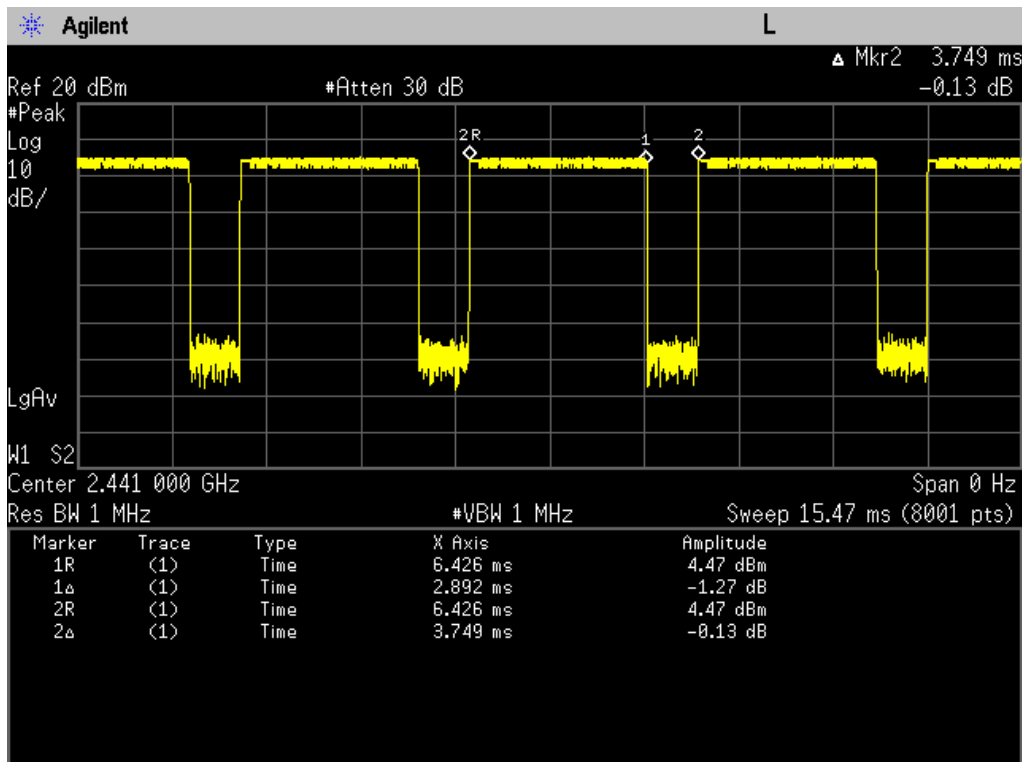

**1x/EDR mode**

- 1) This result was measured at DH5 mode in **1x/EDR mode**, which has longest time in one transmission burst.
- 2) Bluetooth 1x/EDR mode has a channel hopping rate of 1600 hops/s and 79 hopping channels.
- 3) The average time of occupancy in the specified 31.6 second period (79 channels x 0.4 s) is equal to pulse width x (hopping rate / 6) / 79 x (0.4 x hopping channels).
- 4) \*) Numbers of slots in 31.6 sec =  $(1600 / 6) / 79 \times 31.6$
- 5) \*\*) Average time of Occupancy =  $2.89 \text{ ms} \times 106.7 = 308.4 \text{ ms}$

**AFH mode**

- 1) This result was measured at DH5 mode in **AFH mode**, which has longest time in one transmission burst.
- 2) Bluetooth AFH mode has a channel hopping rate of 800 hops/s and 20 hopping channels.
- 3) The average time of occupancy in the specified 8 second period (20 channels x 0.4 s) is equal to pulse width x (hopping rate / 6) / 20 x (0.4 x hopping channels).
- 4) \*) Numbers of slots in 20 sec =  $(800 / 6) / 20 \times 8$
- 5) \*\*) Average time of Occupancy =  $2.89 \text{ ms} \times 53.33 = 154.1 \text{ ms}$



# TEST DATA

## 8.6 Number of Hopping Channels

FCC §15.247(a)(1)(iii), IC RSS-247 Issue 1, 5.1(4)

Test mode : Set to Hopping mode

### Result

The EUT complies with the minimum number of hopping channels when it is operating **1x/EDR mode using 79 channels** and when operating in **AFH mode using 20 channels**.

**Top half of Authorized band(1x mode)**

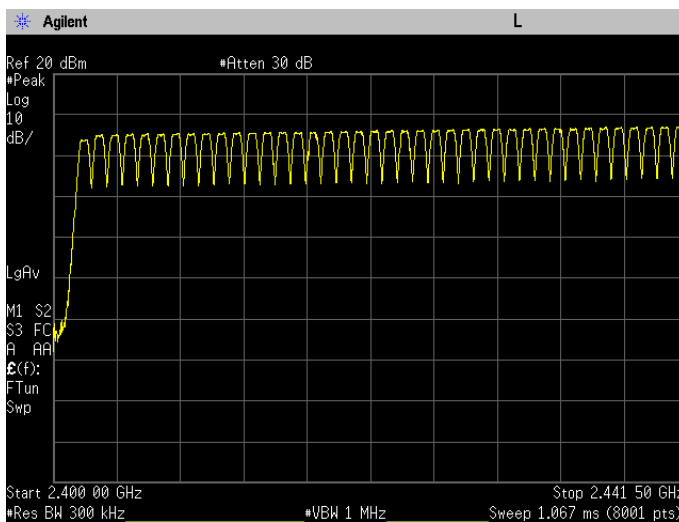

**Bottom half of Authorized band(1x mode)**

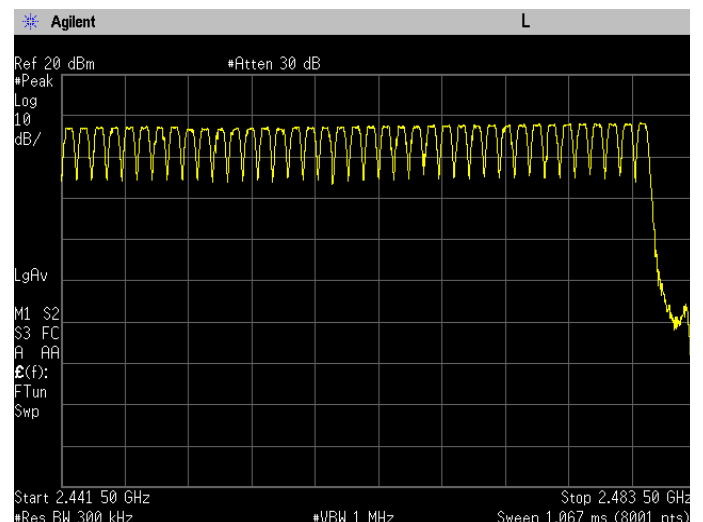

## TEST DATA

### 8.7 Peak Output Power and E.I.R.P

FCC §15.247(b)(1), IC RSS-247 Issue 1, 5.4(2)

Test Mode : Set to Lowest channel, Middle channel and Highest channel

#### Result

Modulation	Frequency (MHz)	Peak Power (dBm)	Limit (dBm)	E.I.R.P* (dBm)	E.I.R.P Limit (dB)	Result
GFSK	2402	4.05	30.00	4.05	36.00	Complies
GFSK	2441	7.15	30.00	7.15	36.00	Complies
GFSK	2480	8.28	30.00	8.28	36.00	Complies
$\pi/4$ DQPSK	2402	1.82	30.00	1.82	36.00	Complies
$\pi/4$ DQPSK	2441	5.81	30.00	5.81	36.00	Complies
$\pi/4$ DQPSK	2480	7.04	30.00	7.04	36.00	Complies
8DPSK	2402	2.11	30.00	2.11	36.00	Complies
8DPSK	2441	6.05	30.00	6.05	36.00	Complies
8DPSK	2480	7.28	30.00	7.28	36.00	Complies

#### Note:

The following formular was used for spectrum offset:

$Spectrum\ offset\ (dB) = Attenuator\ (dB) + Cable\ Loss\ (dB) + SMA\ Type\ Connector\ Loss\ (dB)$

\*) E.I.R.P was calculated by following equation according to KDB412172 D01 Determining ERP and EIRP v01

$$E.I.R.P = P_T + G_T - L_C$$

$P_T$  = Peak outputpower (dBm)

$G_T$  = Gain of the transmitting antenna in dBi, Peak antenna gain is 0 dBi.

$L_C$  = Signal attenuation in the connecting cable between the transmitter and antenna in dB. This factor of an integral antenna is negligible.

# PLOT OF TEST DATA

**Maximum Peak Output Power, Lowest channel (2402 MHz, GFSK mode)**

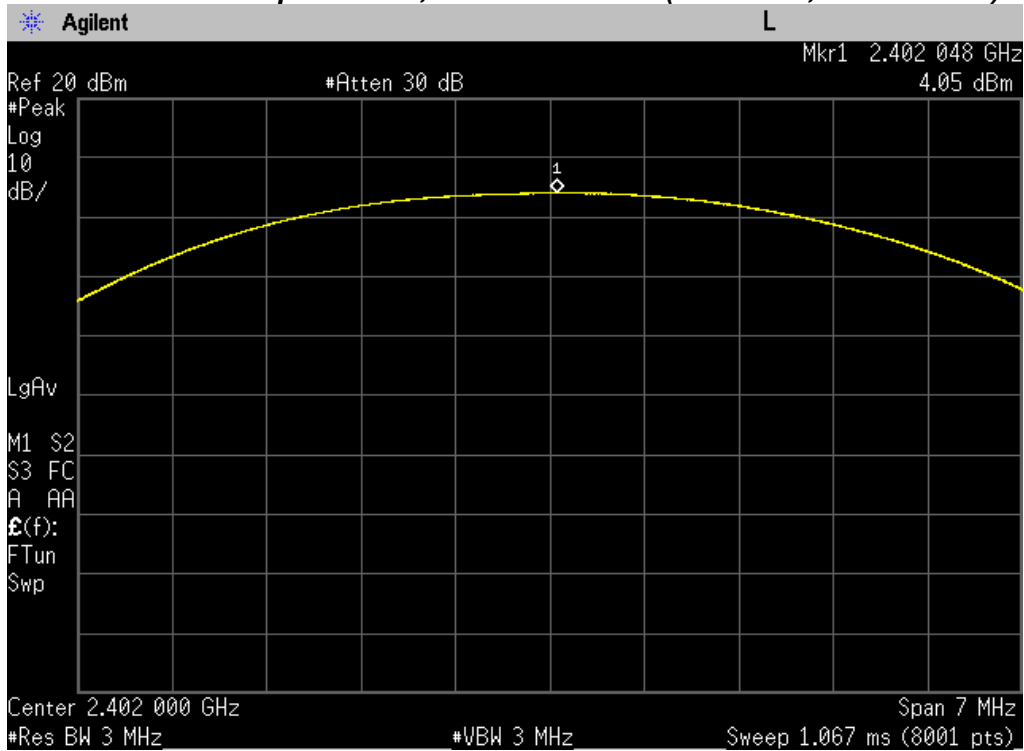

**Maximum Peak Output Power, Middle channel (2441 MHz, GFSK mode)**

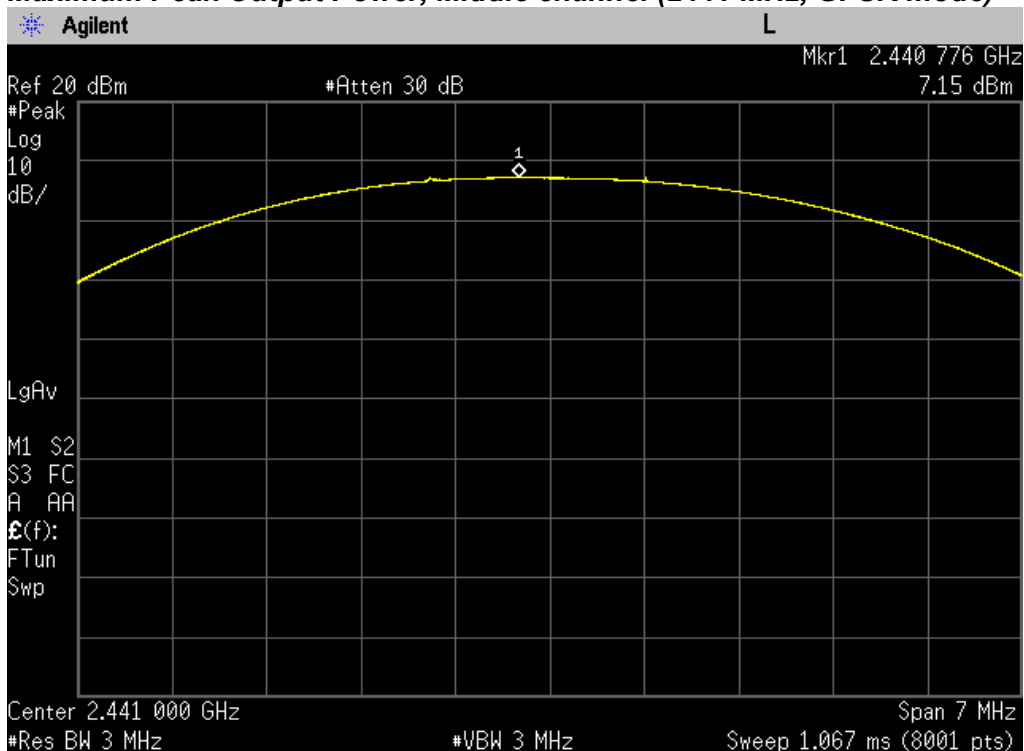

# PLOT OF TEST DATA

**Maximum Peak Output Power, Highest channel (2480 MHz, GFSK mode)**

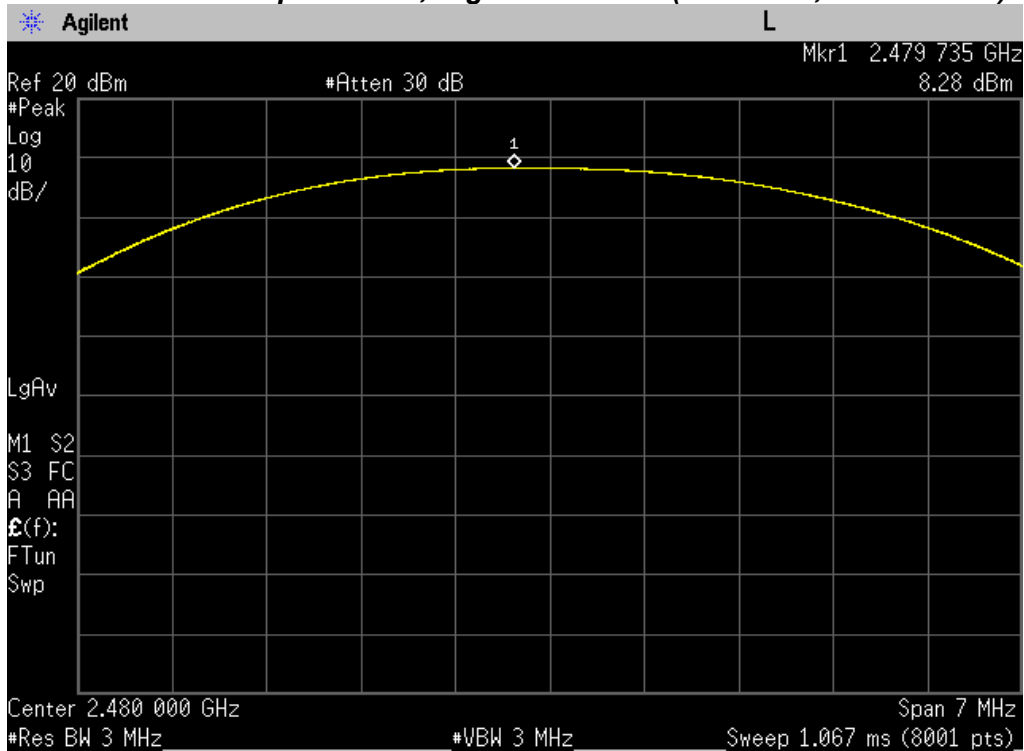

**Maximum Peak Output Power, Lowest channel (2402 MHz,  $\pi/4$ DQPSK)**

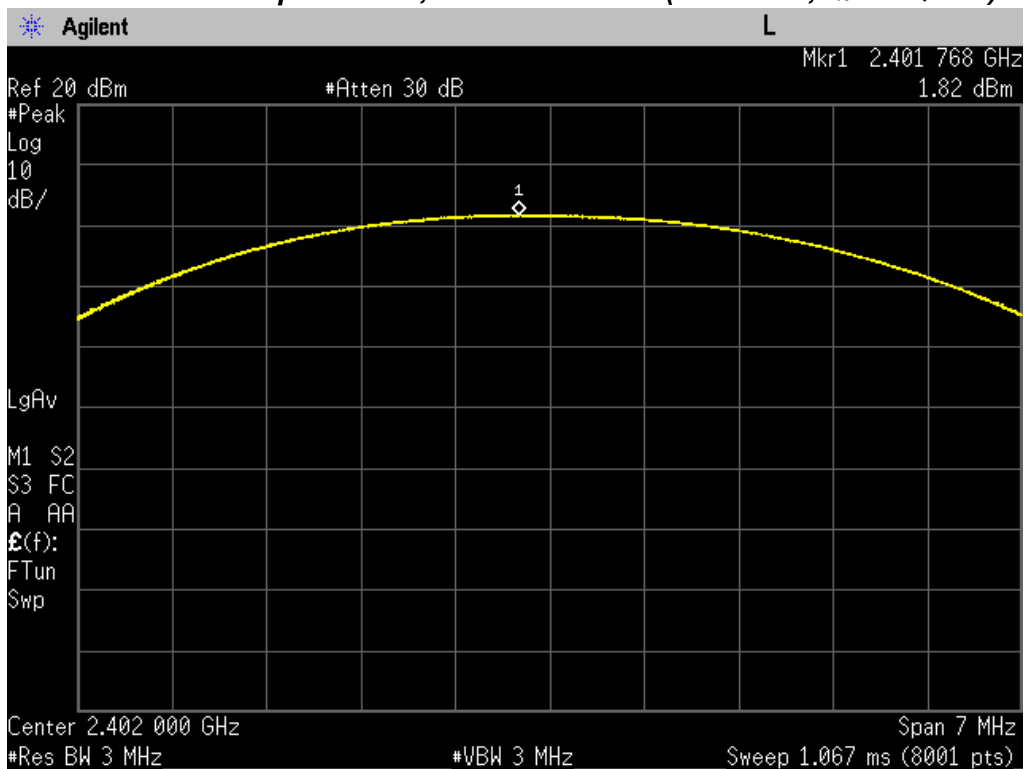

# PLOT OF TEST DATA

## Maximum Peak Output Power, Middle channel (2441 MHz, $\pi/4$ DQPSK)

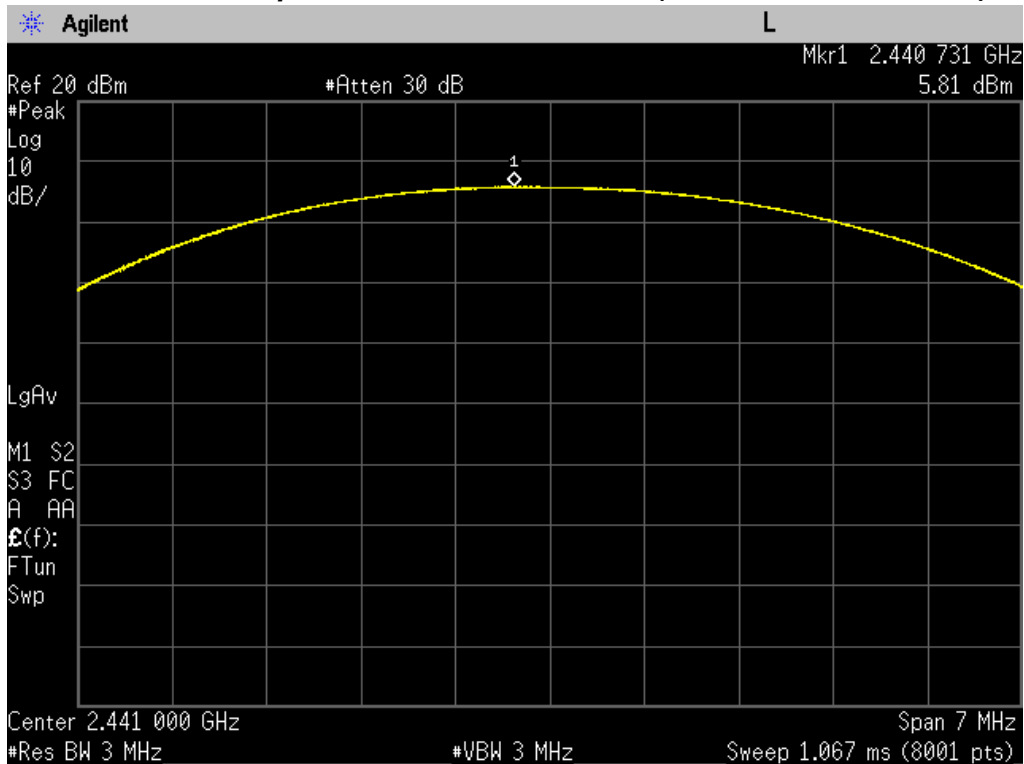

## Maximum Peak Output Power, Highest channel (2480 MHz, $\pi/4$ DQPSK)

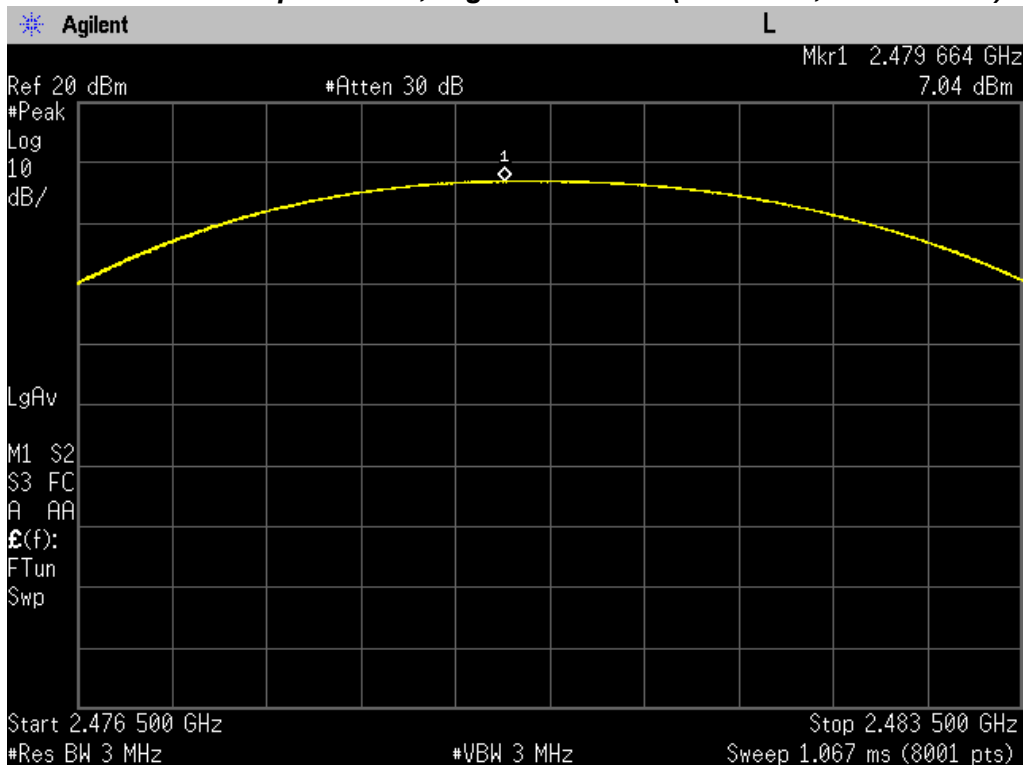

# PLOT OF TEST DATA

**Maximum Peak Output Power, Lowest channel (2402 MHz, 8DPSK)**

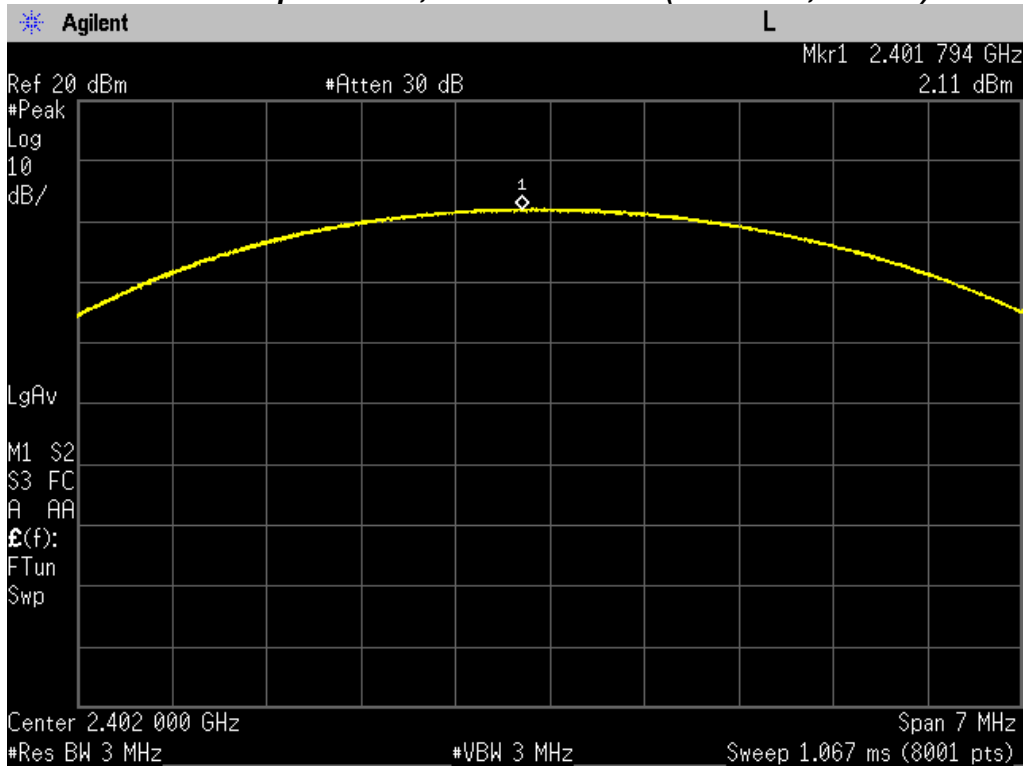

**Maximum Peak Output Power, Middle channel (2441 MHz, 8DPSK)**

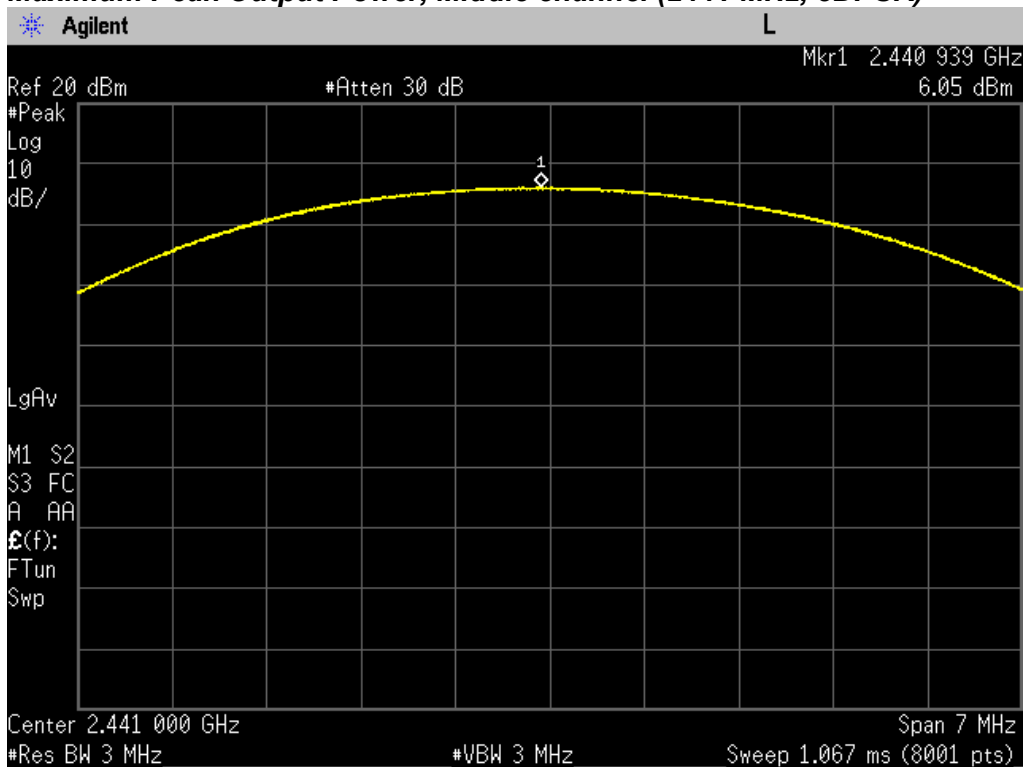

# PLOT OF TEST DATA

## Maximum Peak Output Power, Highest channel (2480 MHz, 8DPSK)

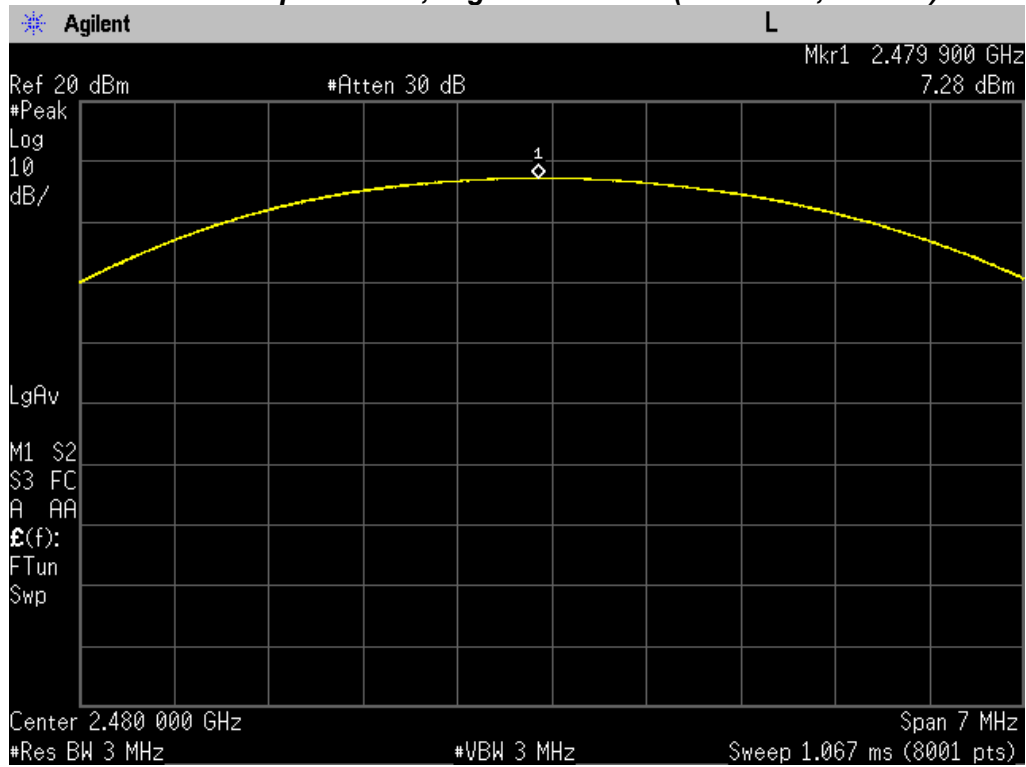

## TEST DATA

### 8.8 Conducted Spurious Emission

FCC §15.247(d), IC RSS-247 Issue 1, 5.5

Test Mode : Set to Lowest channel, Middle channel and Highest channel

#### Result

Modulation Mode	Frequency (MHz)	Result	Limit (dBc)
GFSK	2402	More than 20 dBc	20
GFSK	2441	More than 20 dBc	20
GFSK	2480	More than 20 dBc	20
$\pi/4$ DQPSK	2402	More than 20 dBc	20
$\pi/4$ DQPSK	2441	More than 20 dBc	20
$\pi/4$ DQPSK	2480	More than 20 dBc	20
8DPSK	2402	More than 20 dBc	20
8DPSK	2441	More than 20 dBc	20
8DPSK	2480	More than 20 dBc	20

#### Note:

The cable and attenuator loss from 30 MHz to 25 GHz was reflected in spectrum analyzer with correction factor for the spurious emissions test.



# PLOT OF TEST DATA

## Conducted Spurious Emissions, 30 MHz ~ 26.5 GHz (2402 MHz, GFSK Mode)

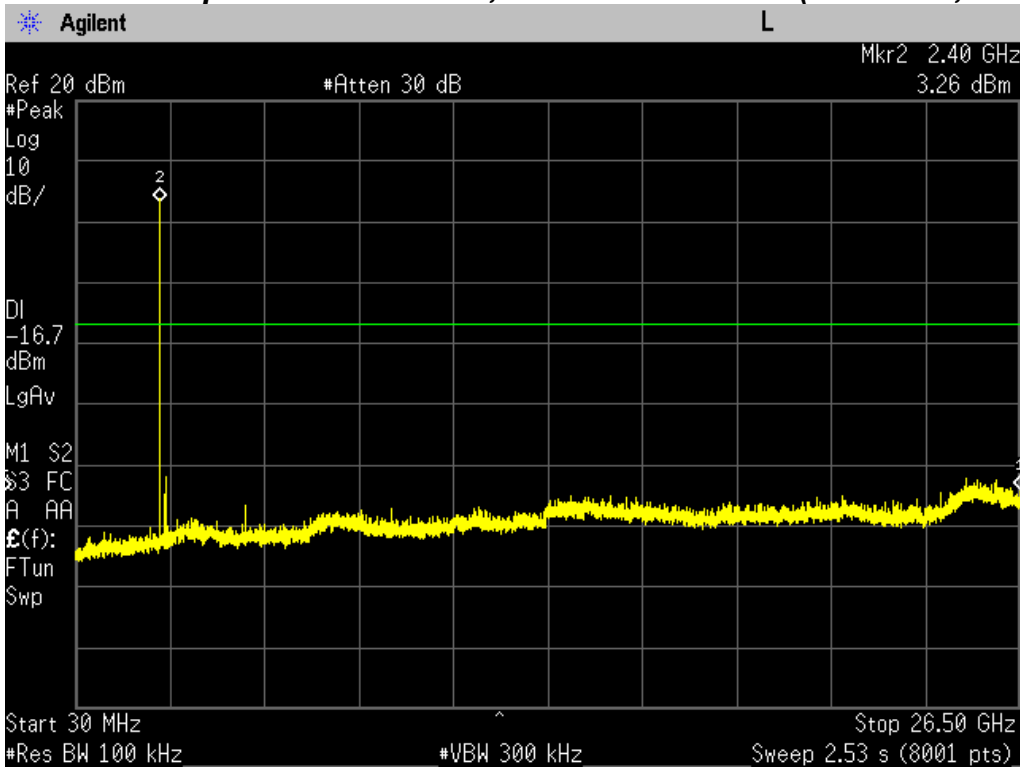

## Conducted Spurious Emissions, 30 MHz ~ 26.5 GHz (2441 MHz, GFSK Mode)

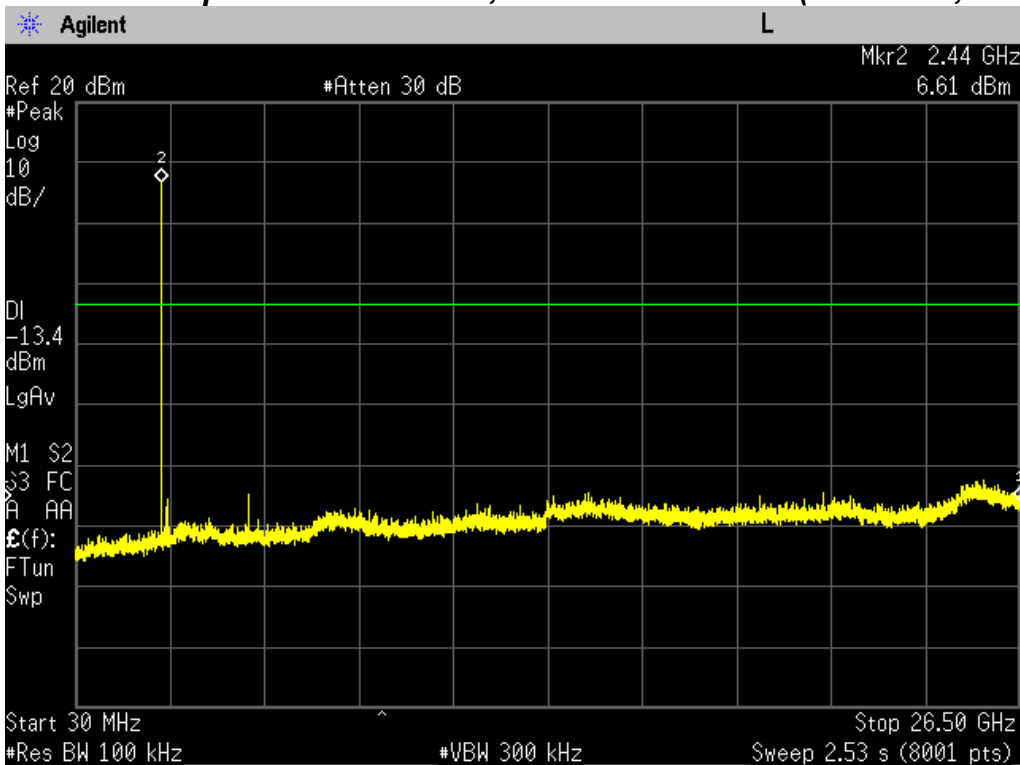

# PLOT OF TEST DATA

## Conducted Spurious Emissions, 30 MHz ~ 26.5 GHz (2480 MHz, GFSK Mode)

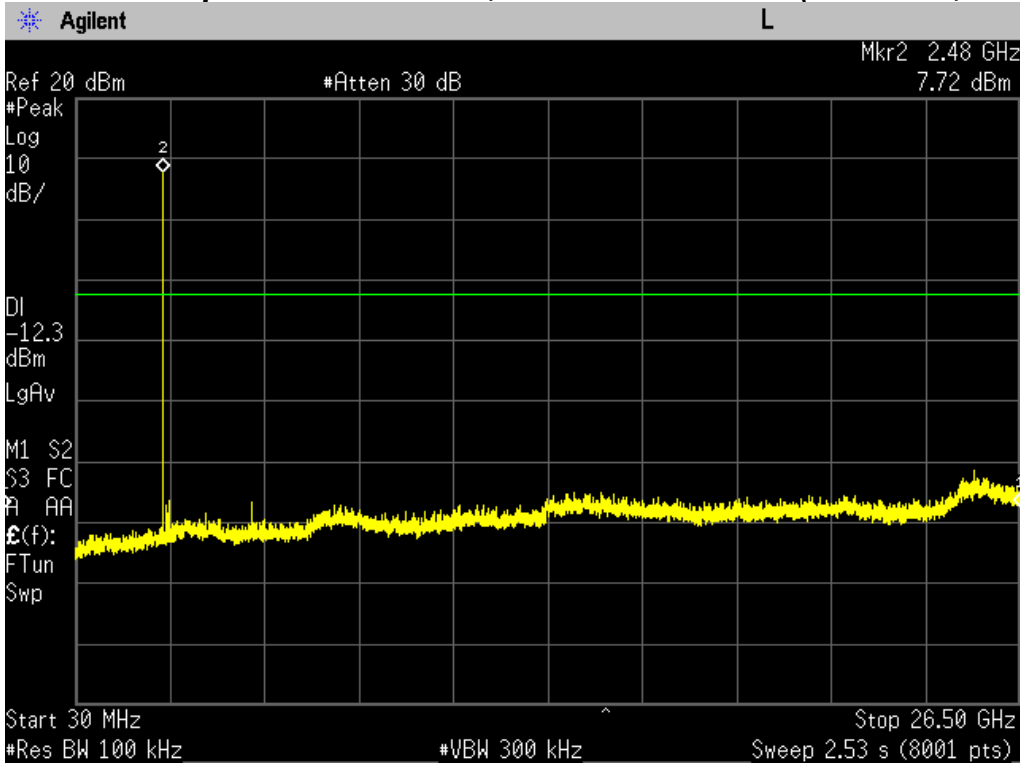

## Conducted Spurious Emissions, 30 MHz ~ 26.5 GHz(2402 MHz, $\pi/4$ DQPSK Mode)

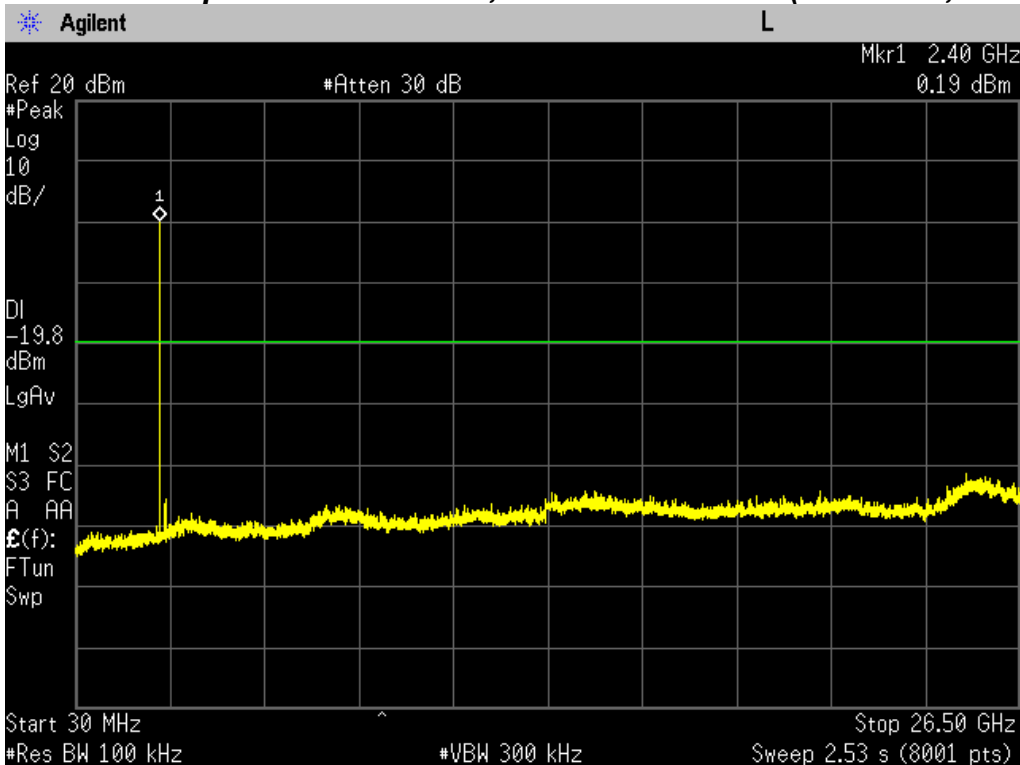

# PLOT OF TEST DATA

## Conducted Spurious Emissions, 30 MHz ~ 26.5 GHz(2441 MHz, $\pi/4$ DQPSK Mode)

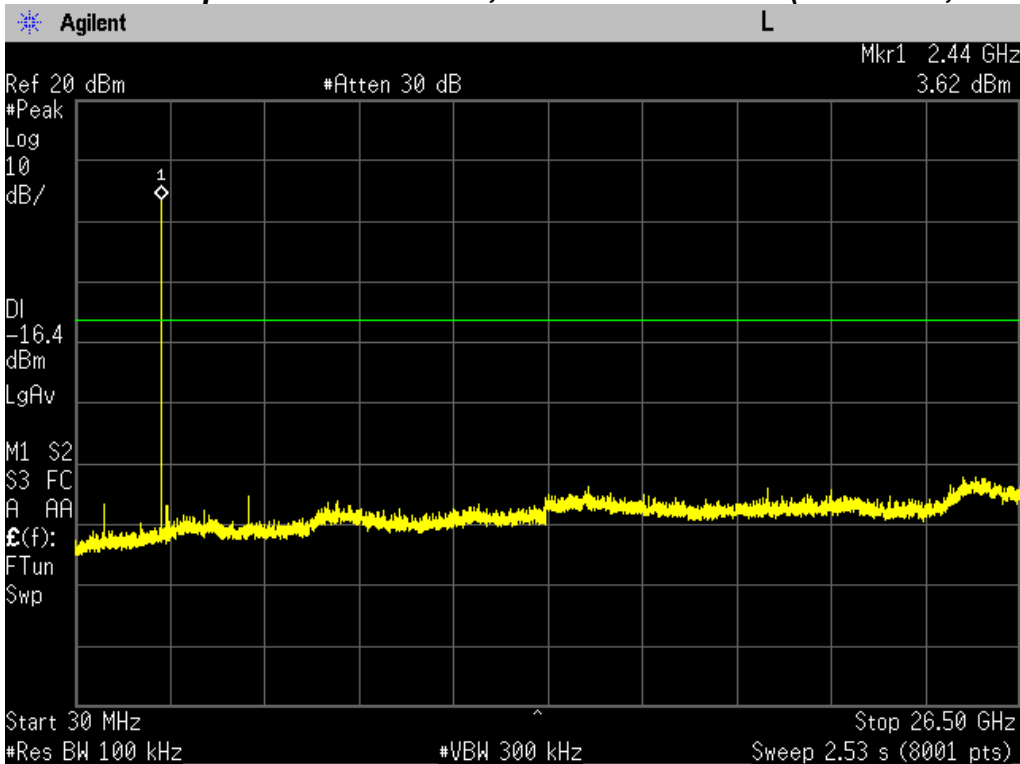

## Conducted Spurious Emissions, 30 MHz ~ 26.5 GHz(2480 MHz, $\pi/4$ DQPSK Mode)

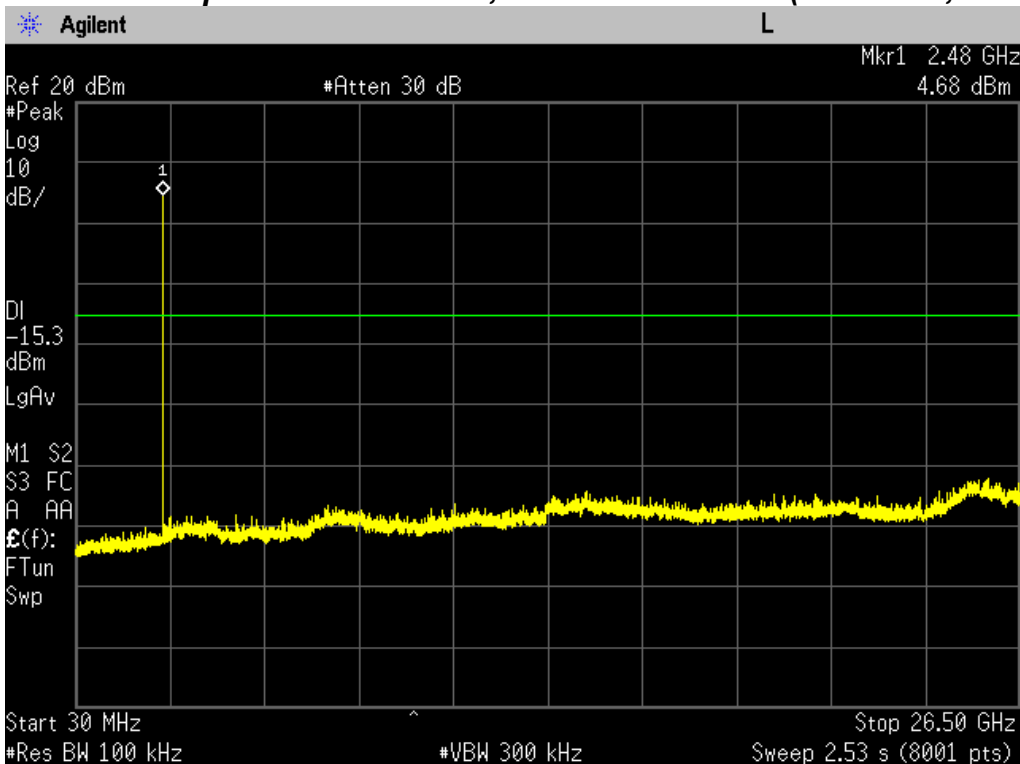

# PLOT OF TEST DATA

## Conducted Spurious Emissions, 30 MHz ~ 26.5 GHz (2402 MHz, 8DPSK Mode)

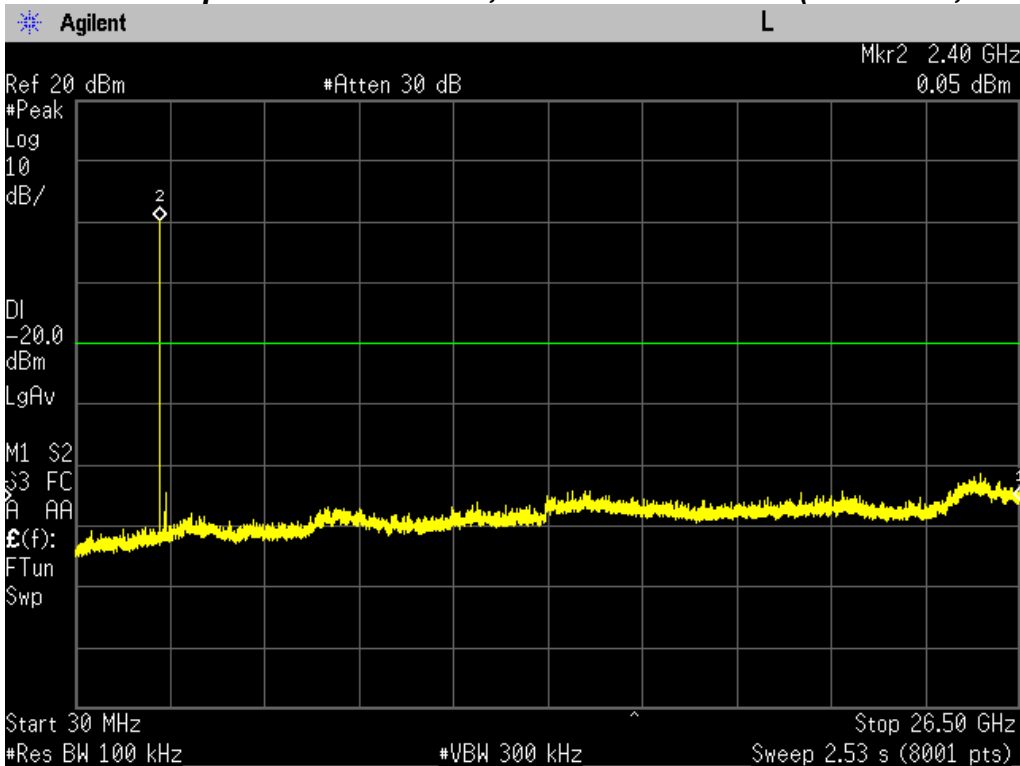

## Conducted Spurious Emissions, 30 MHz ~ 26.5 GHz (2441 MHz, 8DPSK Mode)

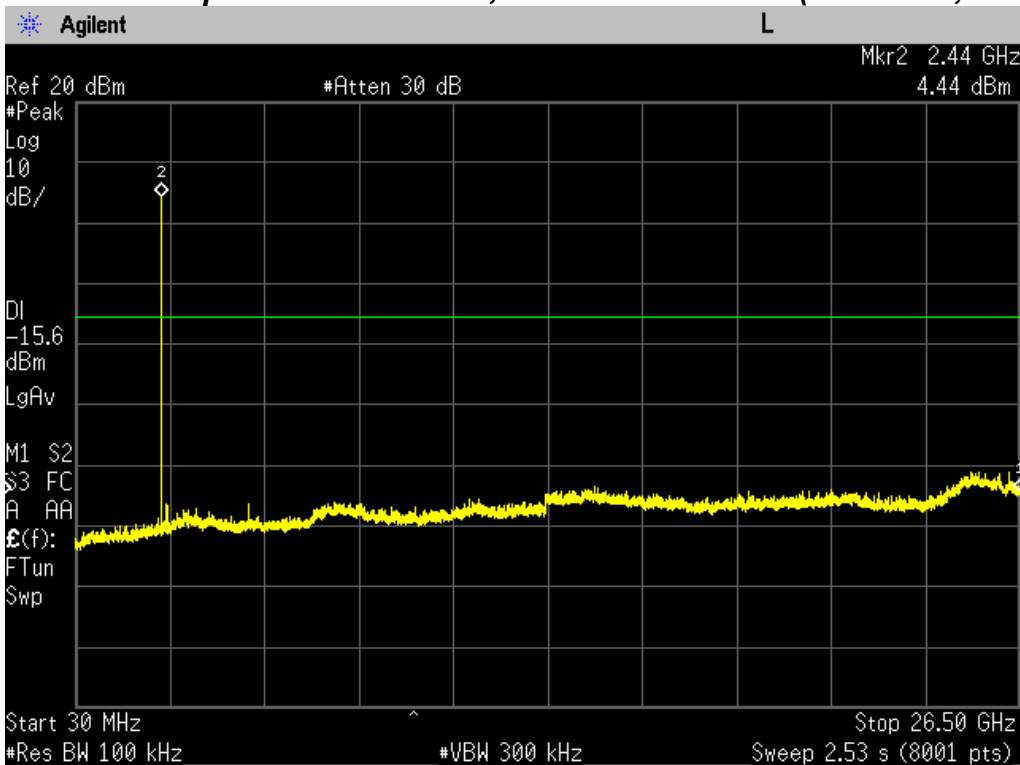

# PLOT OF TEST DATA

## Conducted Spurious Emissions, 30 MHz ~ 26.5 GHz (2480 MHz, 8DPSK Mode)

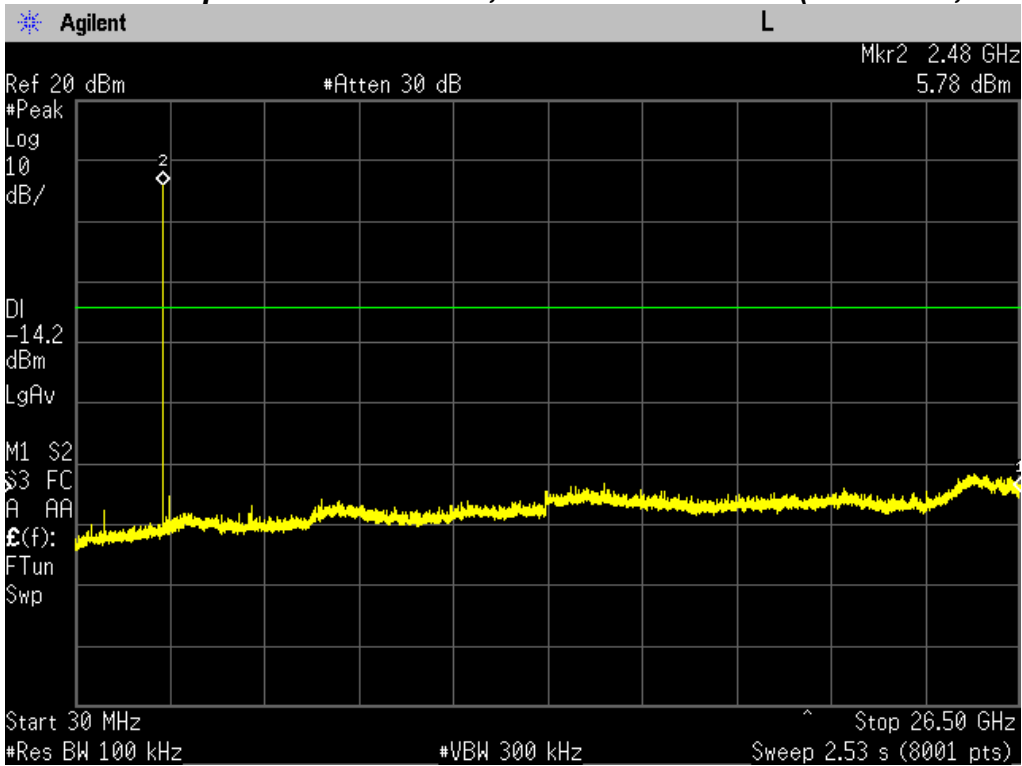

# PLOT OF TEST DATA

## Band Edge Lowest Channel (2402 MHz, GFSK, Non-hopping mode)

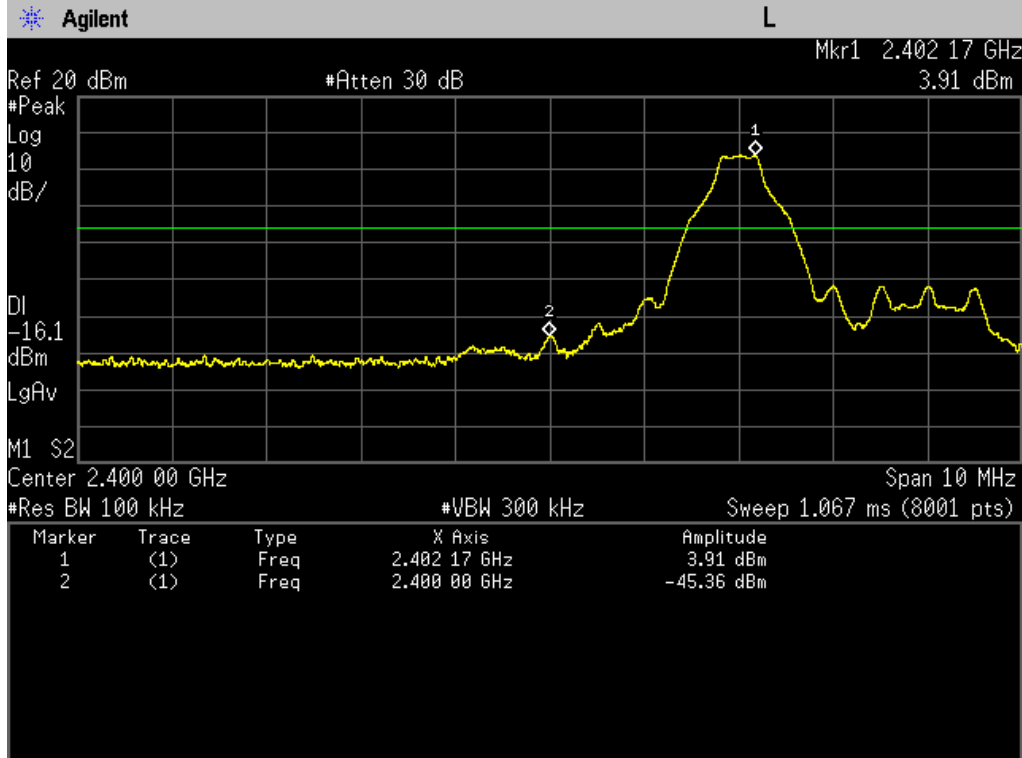

## Band Edge Lowest Channel (2402 MHz, GFSK, Hopping mode)

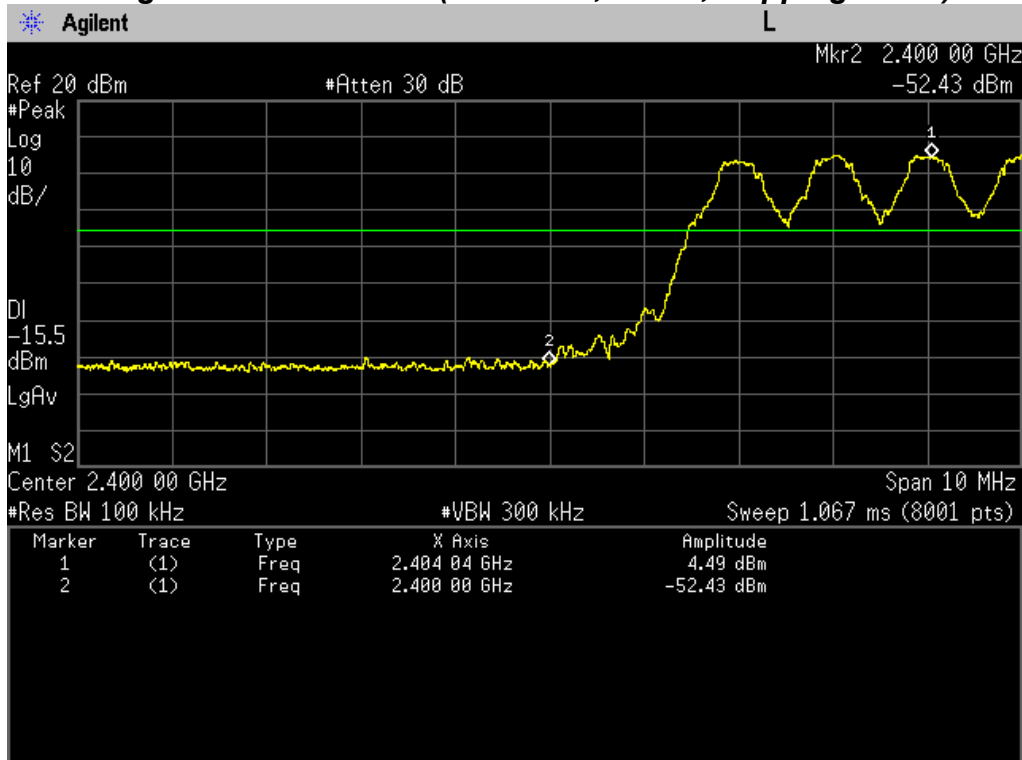

# PLOT OF TEST DATA

## Band Edge Highest Channel (2480 MHz, GFSK, Non-hopping mode)

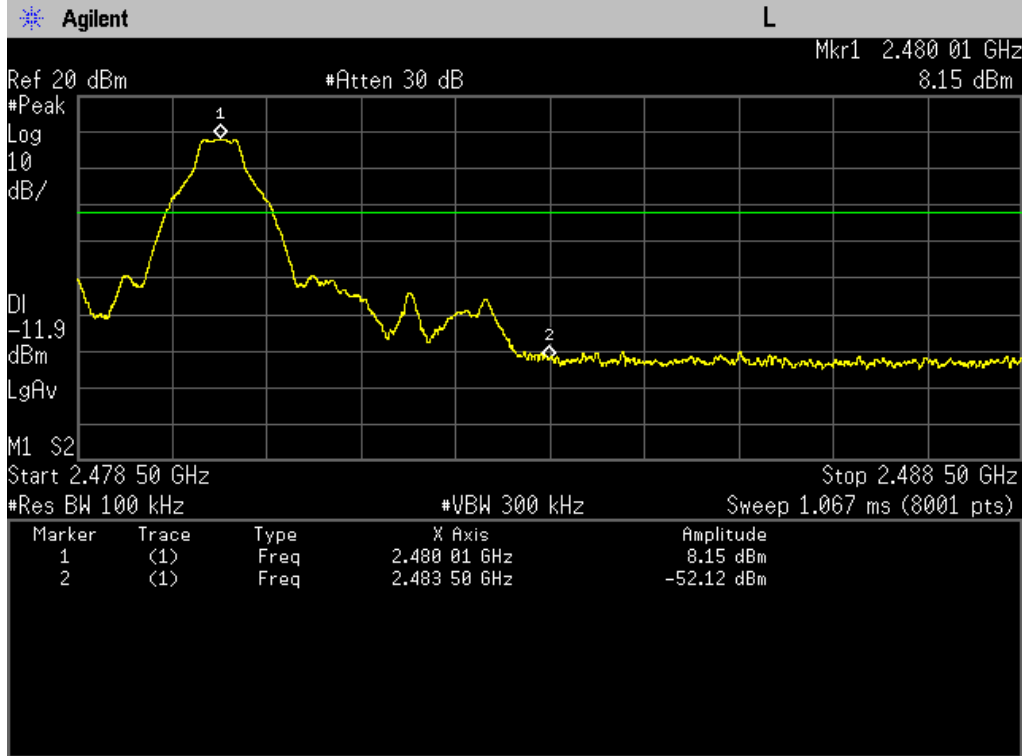

## Band Edge Highest Channel (2480 MHz, GFSK, Hopping mode)

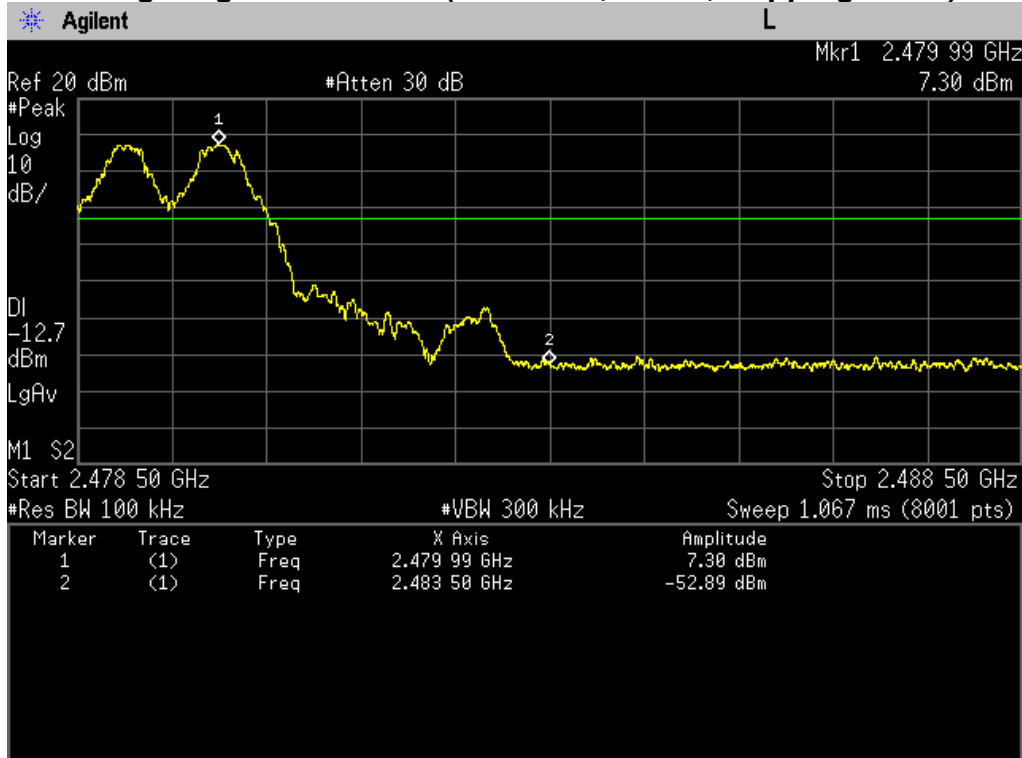

# PLOT OF TEST DATA

## Band Edge Lowest Channel(2402 MHz, $\pi/4$ DQPSK, Non-hopping mode)

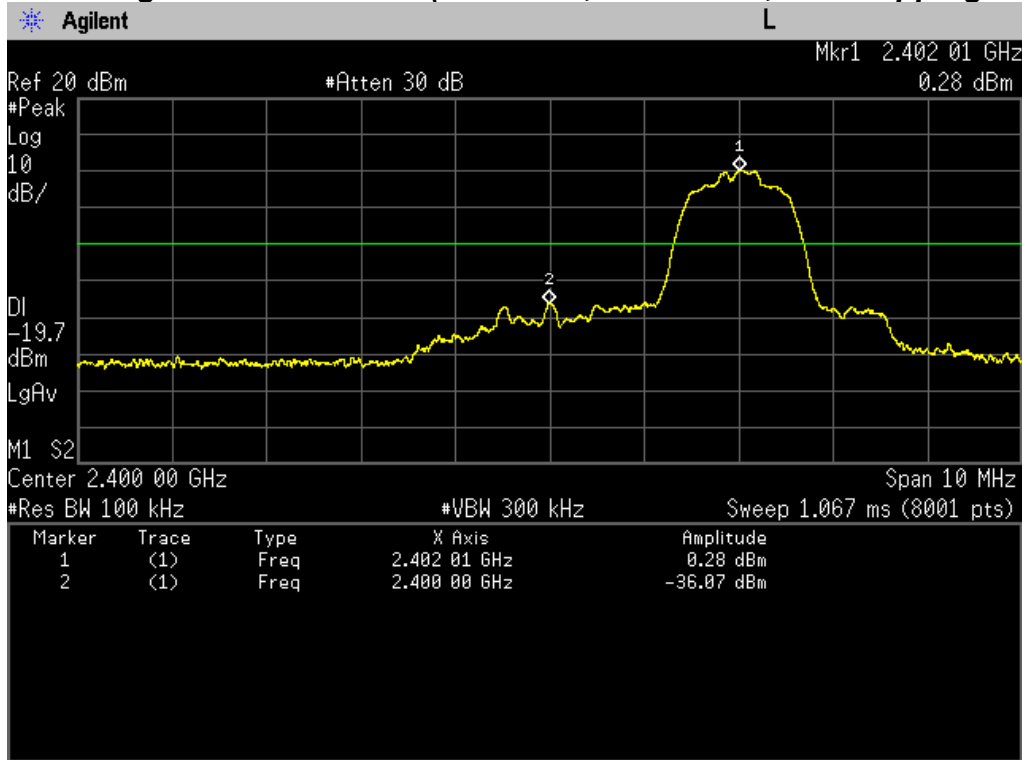

## Band Edge Lowest Channel(2402 MHz, $\pi/4$ DQPSK, Hopping mode)

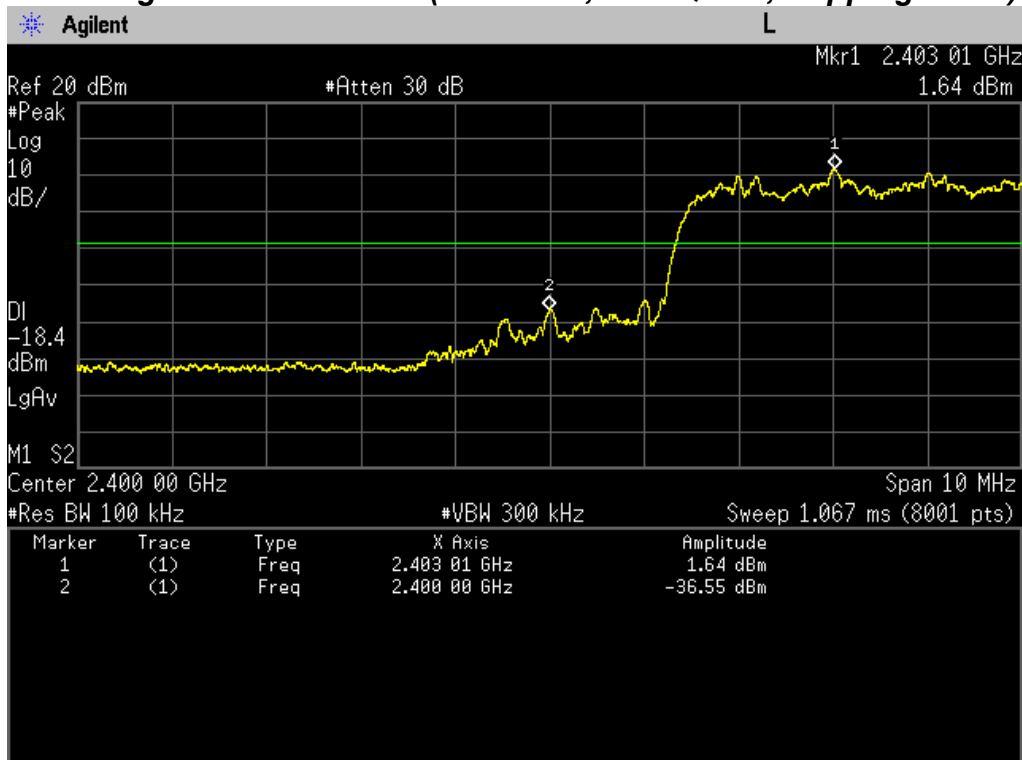



# PLOT OF TEST DATA

## Band Edge Highest Channel(2480 MHz, $\pi/4$ DQPSK, Non-hopping mode)

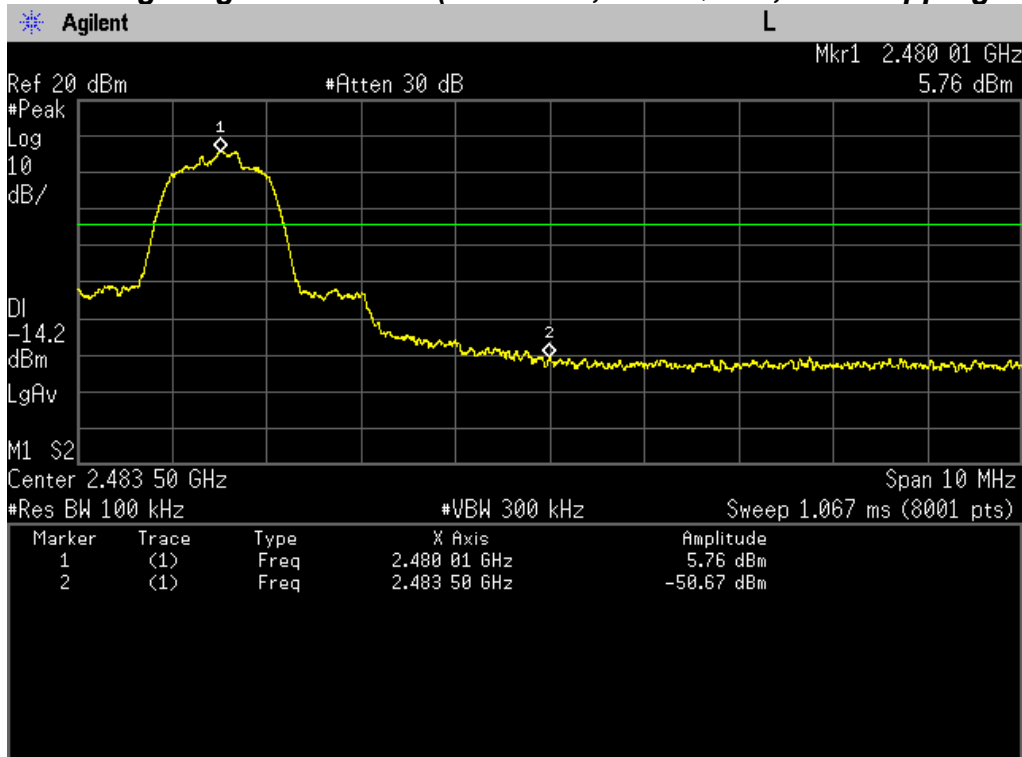

## Band Edge Highest Channel(2480 MHz, $\pi/4$ DQPSK, Hopping mode)

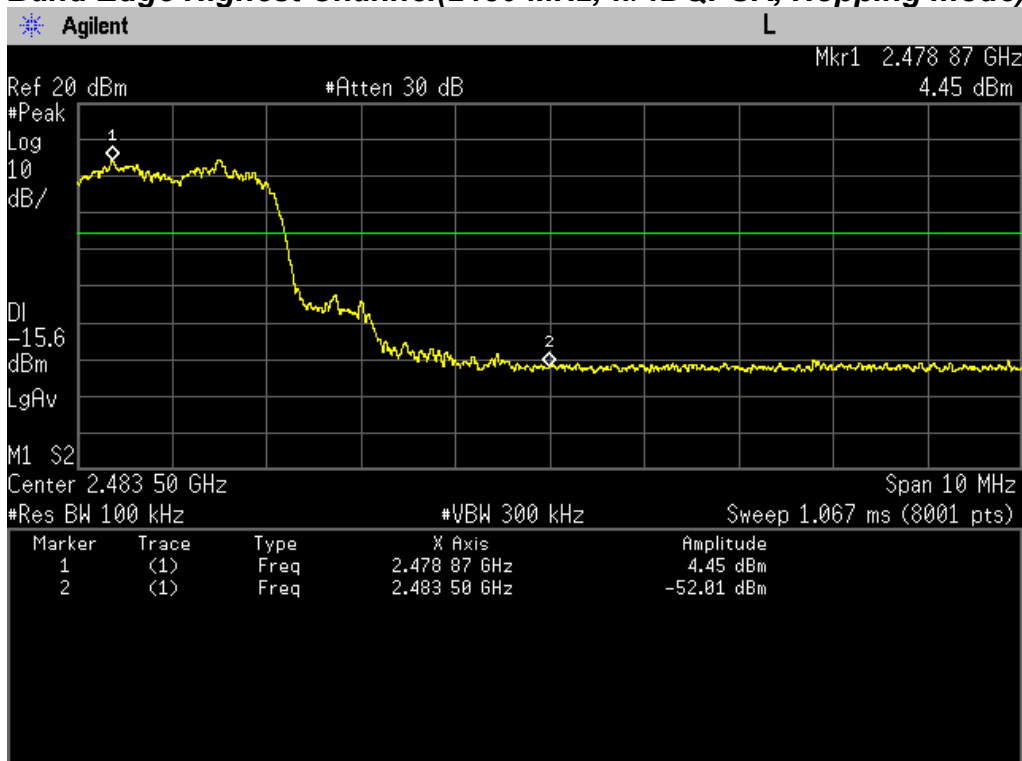

# PLOT OF TEST DATA

## Band Edge Lowest Channel(2402 MHz, 8DPSK, Non-hopping mode)

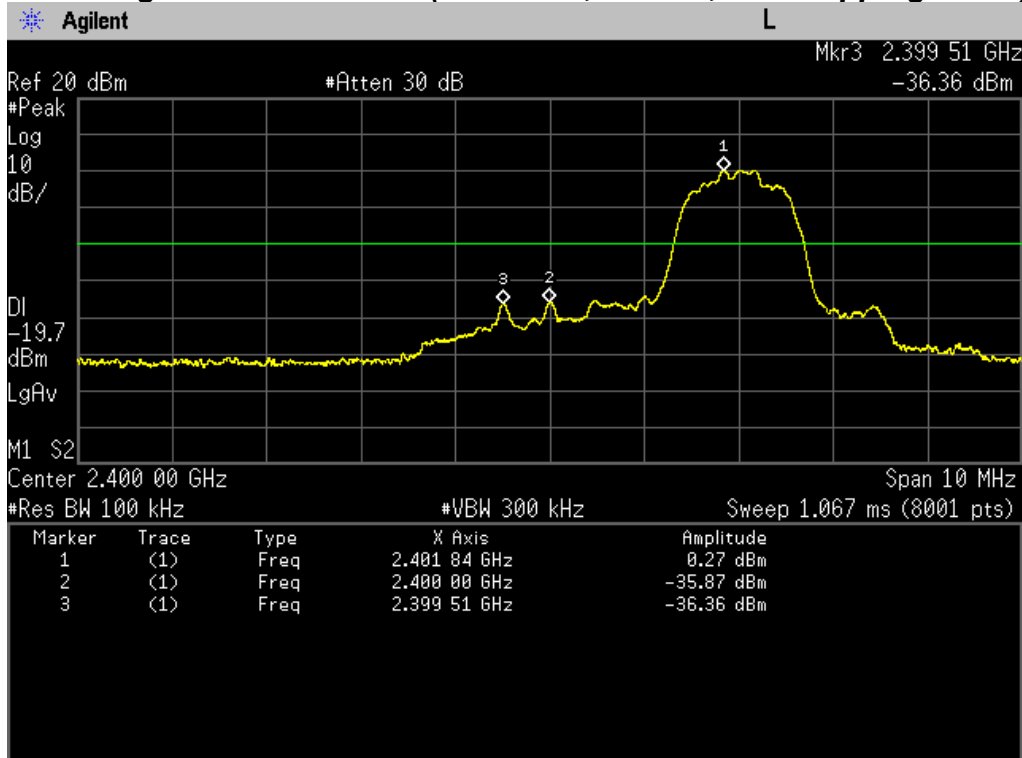

## Band Edge Lowest Channel(2402 MHz, 8DPSK, Hopping mode)

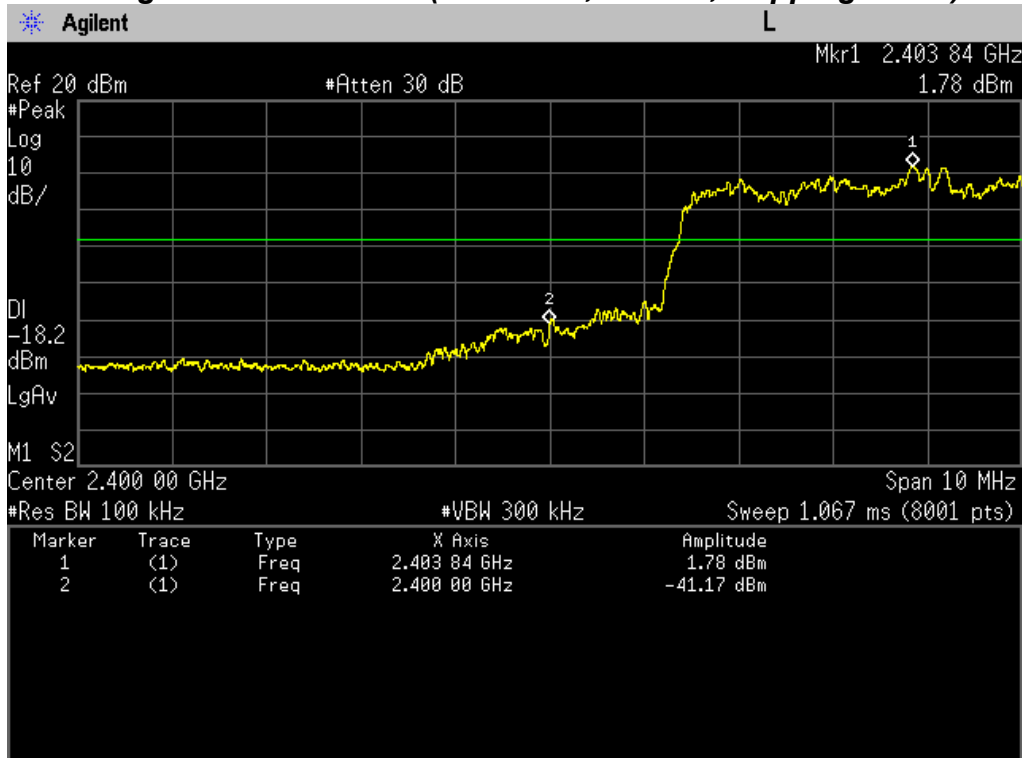

# PLOT OF TEST DATA

## Band Edge Highest Channel(2480 MHz, 8DPSK, Non-hopping mode)

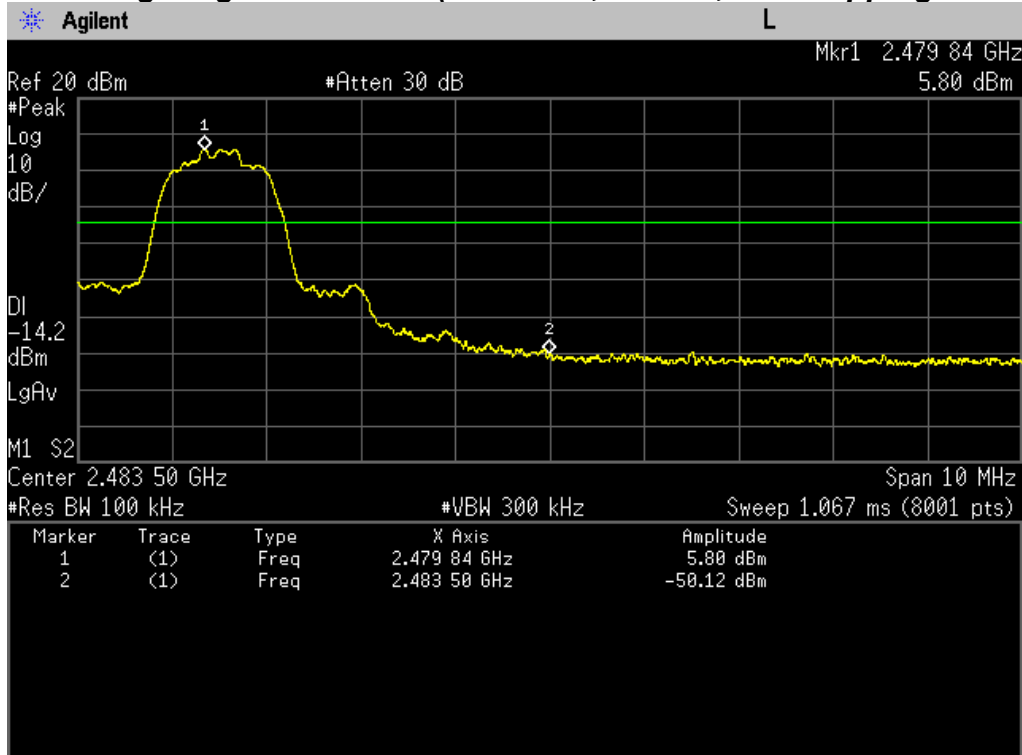

## Band Edge Highest Channel(2480 MHz, 8DPSK, Hopping mode)

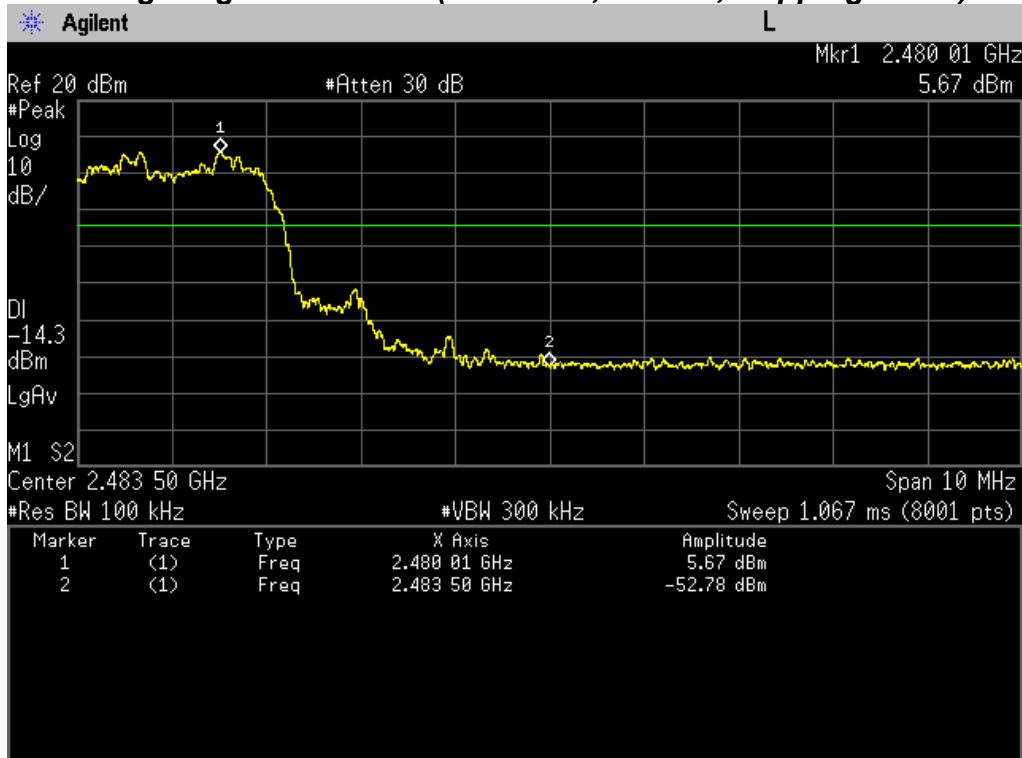

# TEST DATA

## 8.9 Radiated Spurious Emission

**FCC §15.247(d), IC RSS-247 Issue 1, 5.5**

**Test Mode : Set to Lowest channel, Middle channel and Highest channel**

### Result

#### **Lowest Channel**

Frequency (MHz)	Reading (dBµV)	Pol* (H/V)	mode	AF+CL+Amp (dB)**	Result (dBµV/m)	Limit (dBµV/m)	Margin (dB)
4804.33	46.8	V	peak	9.4	56.2	74.0	17.8
4804.03	38.7	V	average	9.4	48.1	54.0	5.9
7206.59	44.0	V	peak	16.3	60.3	74.0	13.7
7205.98	33.3	V	average	16.3	49.6	54.0	4.4

#### **Middle Channel**

Frequency (MHz)	Reading (dBµV)	Pol* (H/V)	mode	AF+CL+Amp (dB)**	Result (dBµV/m)	Limit (dBµV/m)	Margin (dB)
4884.44	45.4	V	peak	9.7	55.1	74.0	18.9
4884.02	38.6	V	average	9.7	48.3	54.0	5.7
7325.27	44.1	H	peak	16.8	60.9	74.0	13.1
7325.98	35.2	H	average	16.8	***29.5	54.0	24.5

#### **Highest Channel**

Frequency (MHz)	Reading (dBµV)	Pol* (H/V)	mode	AF+CL+Amp (dB)**	Result (dBµV/m)	Limit (dBµV/m)	Margin (dB)
4959.71	45.5	V	peak	9.9	55.4	74.0	18.6
4960.18	38.4	V	average	10.0	48.4	54.0	5.6
7440.01	44.8	H	peak	17.0	61.8	74.0	12.2
7440.01	36.7	H	average	17.0	***31.2	54.0	22.8

**Notes:**

1. \*Pol. H = Horizontal V = Vertical
2. \*\*AF + CL + Amp. = Antenna Factor + Cable Loss + Amplifier.
3. Other spurious was under 20 dB below Fundamental.
4. \*\*\* Duty Cycle Correction Factor Calculation (Worst case : AFH mode)
  - Channel hop rate = 800 hops/second
  - Adjusted channel hop rate for DH5 mode = 133.33 hops/second
  - Time per channel hop =  $1/133.33$  hops/second = 7.50 ms
  - Time to cycle through all channels =  $7.50 \times 20$  channels = 150 ms
  - Number of times transmitter hits on one channel =  $100 \text{ ms} / 150 \text{ ms} = 1 \text{ time(s)}$
  - Worst case dwell time = 7.50 ms
  - Duty cycle correction factor =  $20\log_{10}(7.50\text{ms}/100\text{ms}) = -22.5 \text{ dB}$
5. GFSK modulation mode was the worst condition.
6. The radiated emissions testing were made by rotating EUT through three orthogonal axes and rotating the receive antenna with horizontal, Vertical polarization. The worst data was recorded.
7. Peak emissions were measured using RBW = 1 MHz, VBW = 3 MHz, Detector = Peak.
8. Average emissions were measured using RBW = 1 MHz, VBW = 1 kHz, Detector = Peak.
9. The spectrum was measured from 9 kHz to 10<sup>th</sup> harmonic and the worst-case emissions were reported. No significant emissions were found beyond the 3rd harmonic for this device.

# PLOTS OF EMISSIONS

## Worst Case : 2480 MHz GFSK modulation : 1 GHz to 8 GHz

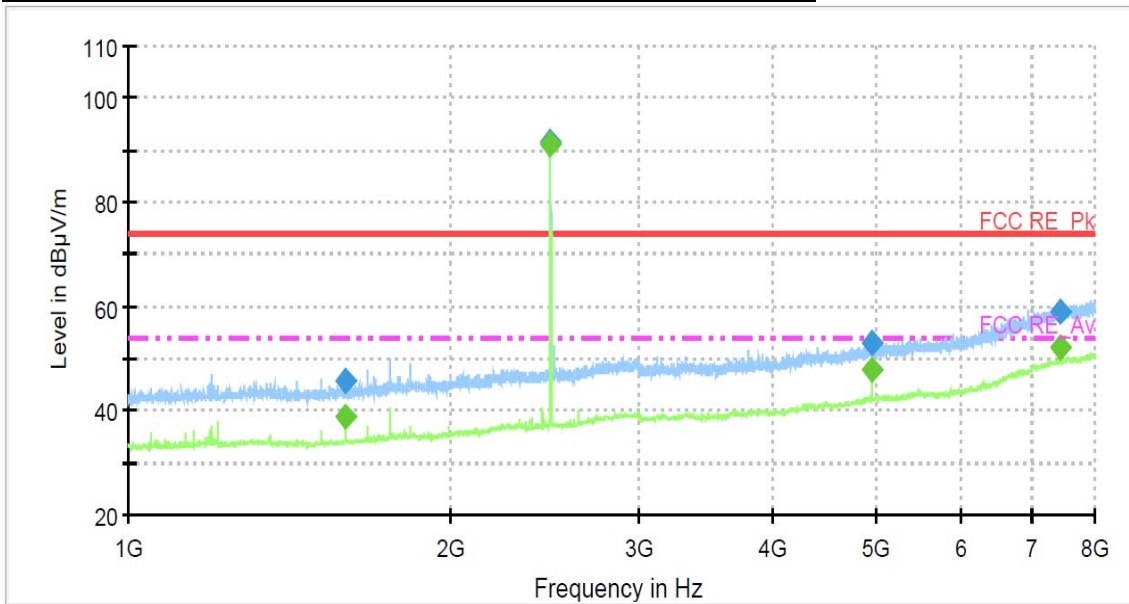

## Worst Case : 2480 MHz GFSK modulation : 8 GHz to 18 GHz

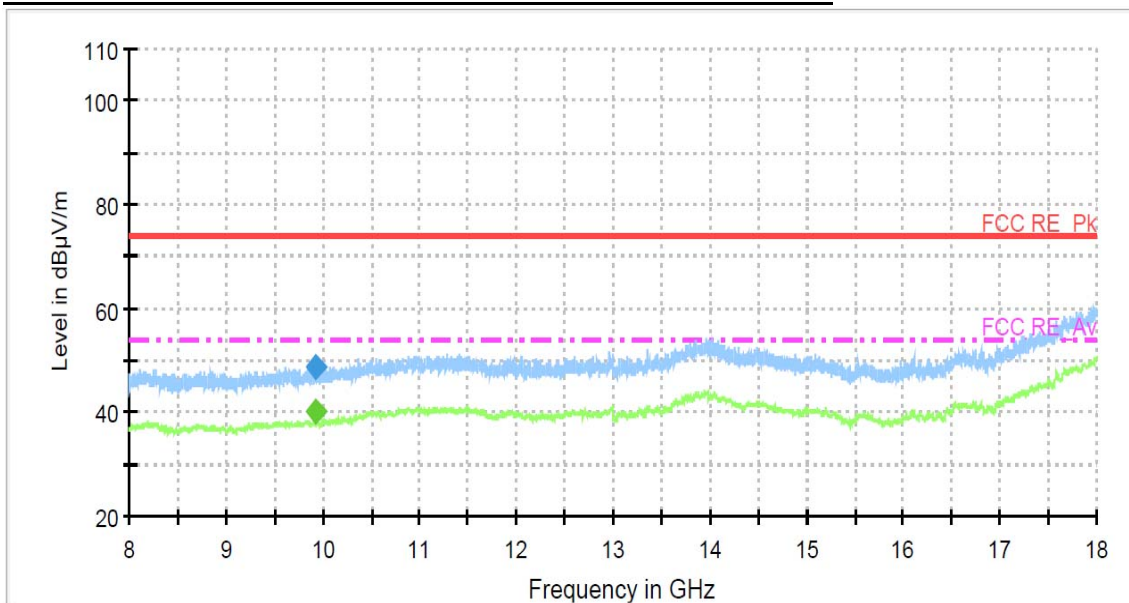

# PLOTS OF EMISSIONS

**Worst Case : 2480 MHz GFSK modulation : 18 GHz to 26 GHz**

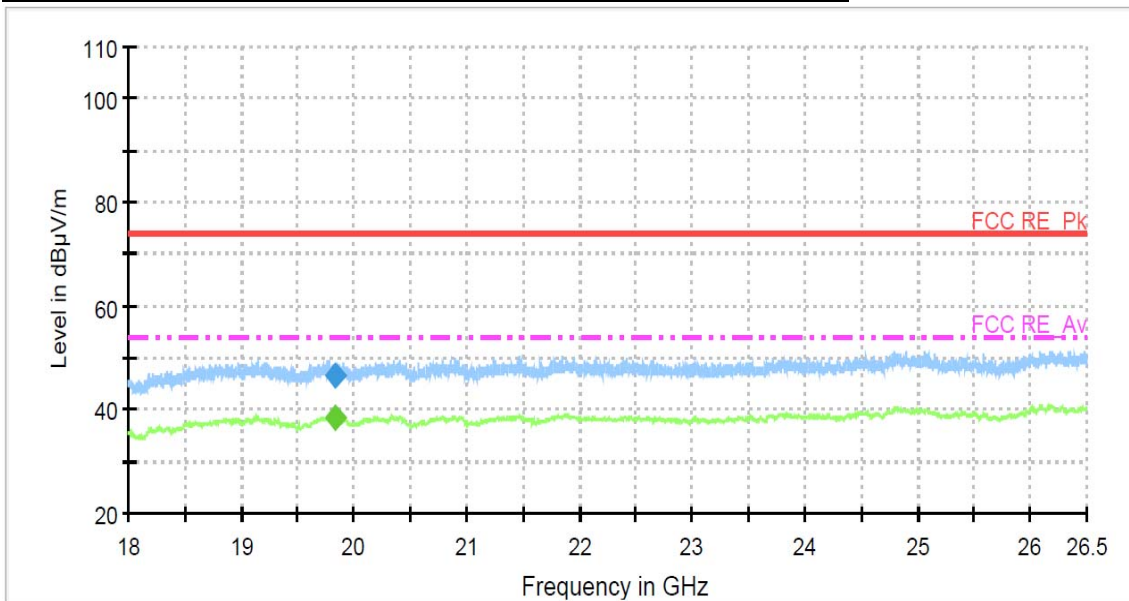

**Worst Case : 2480 MHz GFSK modulation : 2<sup>nd</sup> Harmonic Pk**

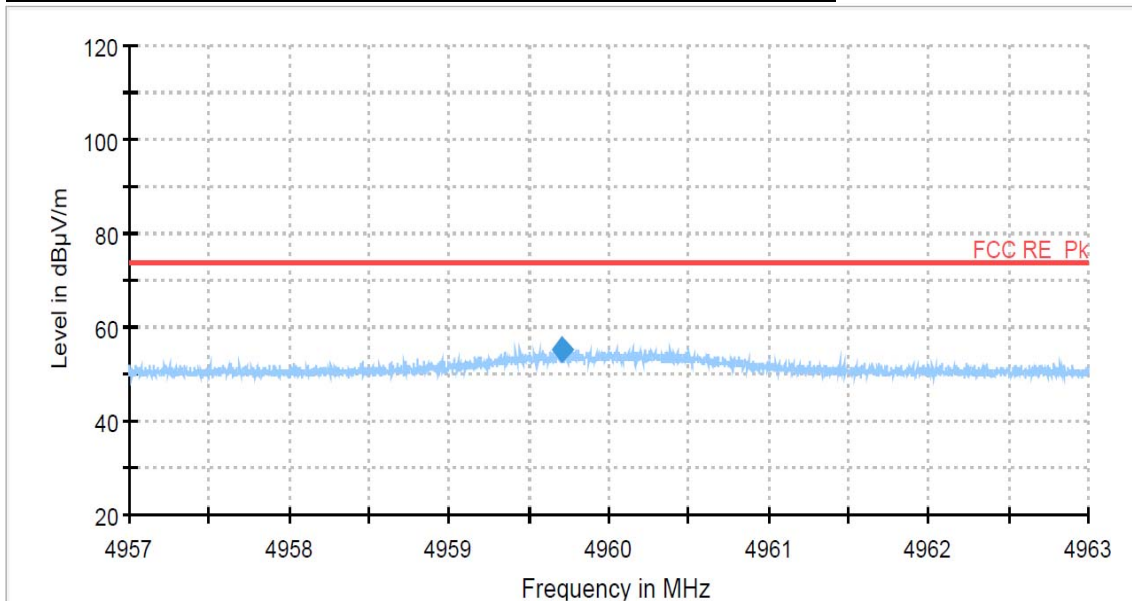

# PLOTS OF EMISSIONS

**Worst Case : 2480 MHz GFSK modulation : 2<sup>nd</sup> Harmonic Av**

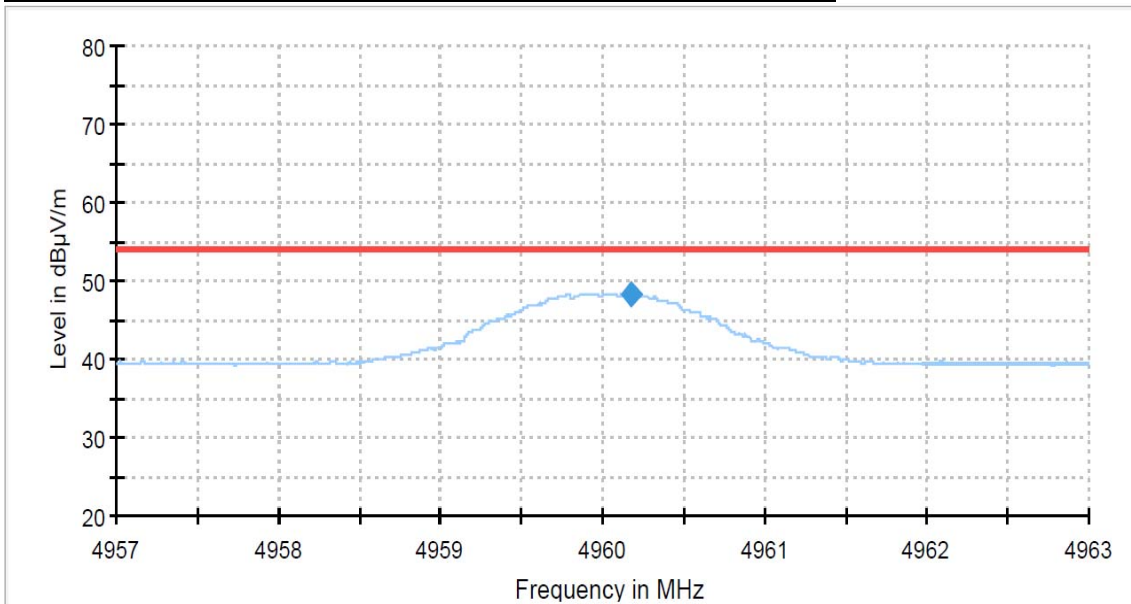

**Worst Case : 2480 MHz GFSK modulation : 3<sup>rd</sup> Harmonic Pk**

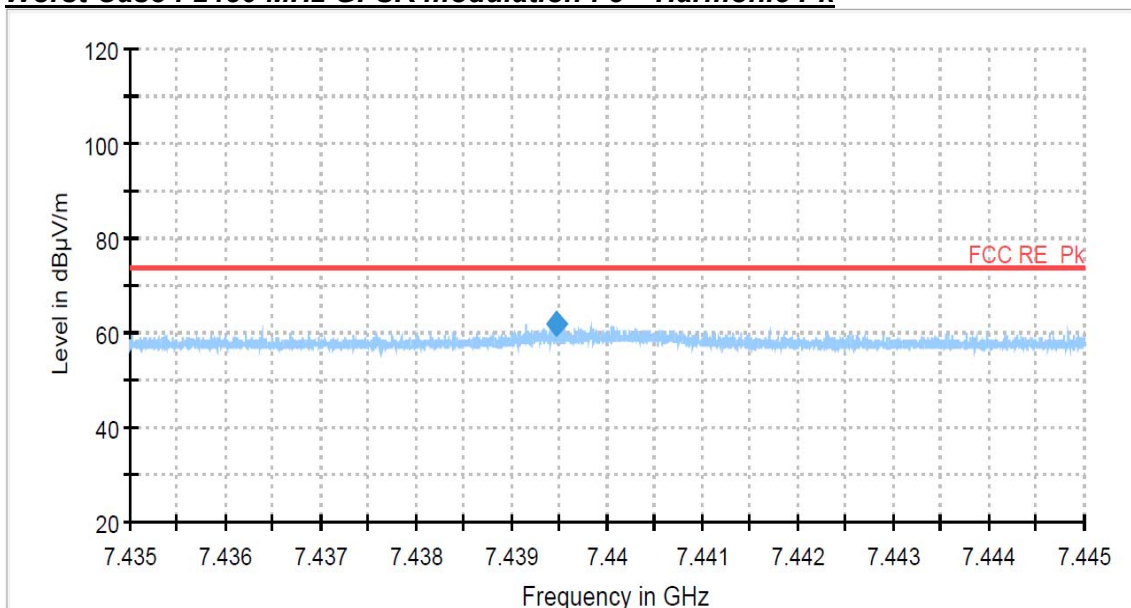



# PLOTS OF EMISSIONS

## Worst Case : 2480 MHz GFSK modulation : 3<sup>rd</sup> Harmonic Av

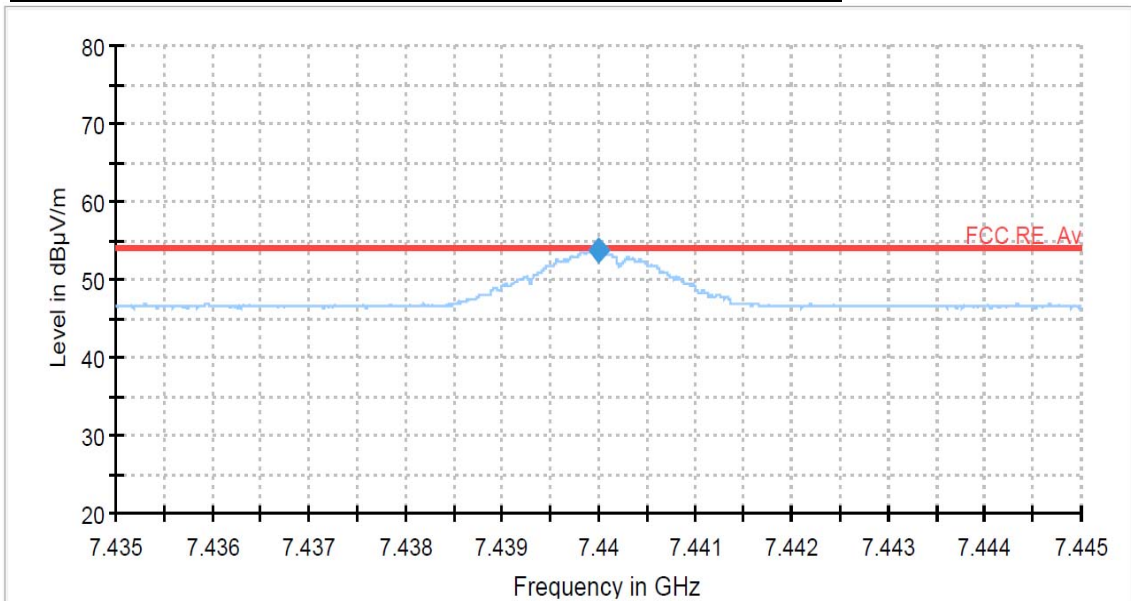

# TEST DATA

## 8.10 Radiated Bandedge

FCC §15.247(d), IC RSS-247 Issue 1, 5.5

Test Mode : Set to Lowest channel, Highest channel

### Result

#### **Lowest and Highest Channels**

Frequency (MHz)	Reading (dBμV)	Pol* (H/V)	mode	AF+CL+Amp (dB)**	Result (dBμV/m)	Limit (dBμV/m)	Margin (dB)
2390.00	44.1	H	peak	0.4	44.5	74.0	29.5
2390.00	33.9	H	average	0.4	34.3	54.0	19.7
2483.50	54.7	H	peak	0.8	55.5	74.0	18.5
2483.50	51.6	H	average	0.8	52.4	54.0	1.6

#### **Note:**

1. \*Pol. H = Horizontal V = Vertical
2. \*\*AF + CL + Amp. = Antenna Factor + Cable Loss + Amplifier.
3. Other spurious was under 20 dB below Fundamental.
4. GFSK modulation mode was the worst condition.
5. The radiated emissions testing were made by rotating EUT through three orthogonal axes and rotating the receive antenna with horizontal, Vertical polarization. The worst data was recorded.
6. Peak emissions were measured using RBW = 1 MHz, VBW = 3 MHz, Detector = Peak.
7. Average emissions were measured using RBW = 1 MHz, VBW = 1kHz, Detector = Peak

# PLOT OF TEST DATA

**Restricted Band Spurious Emissions, Lowest channel(GFSK, Peak)**

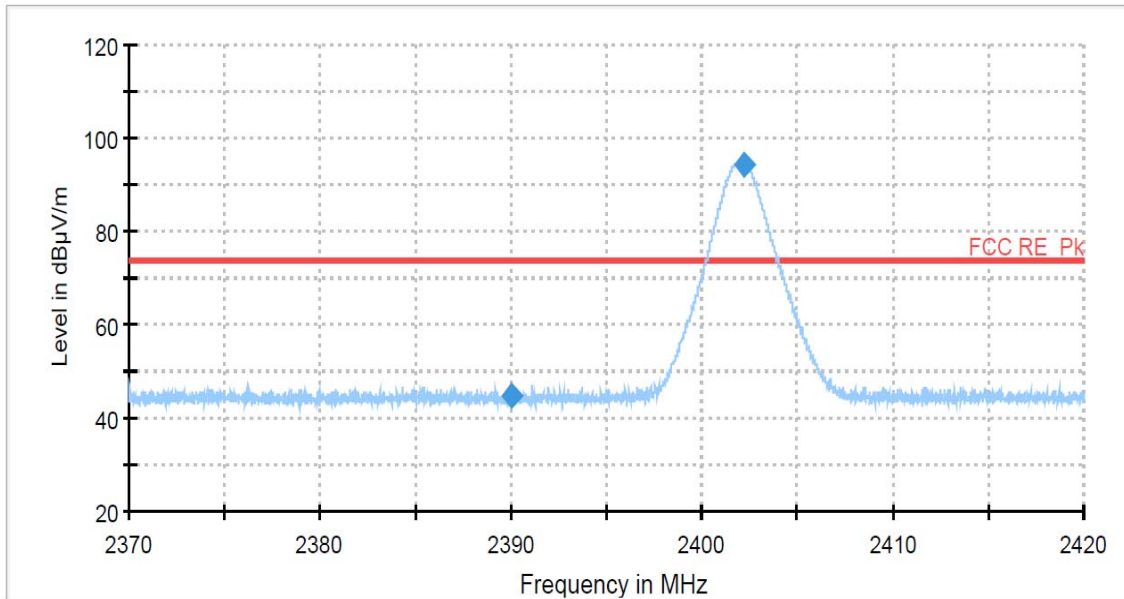

**Restricted Band Spurious Emissions, Lowest channel(GFSK, Average)**

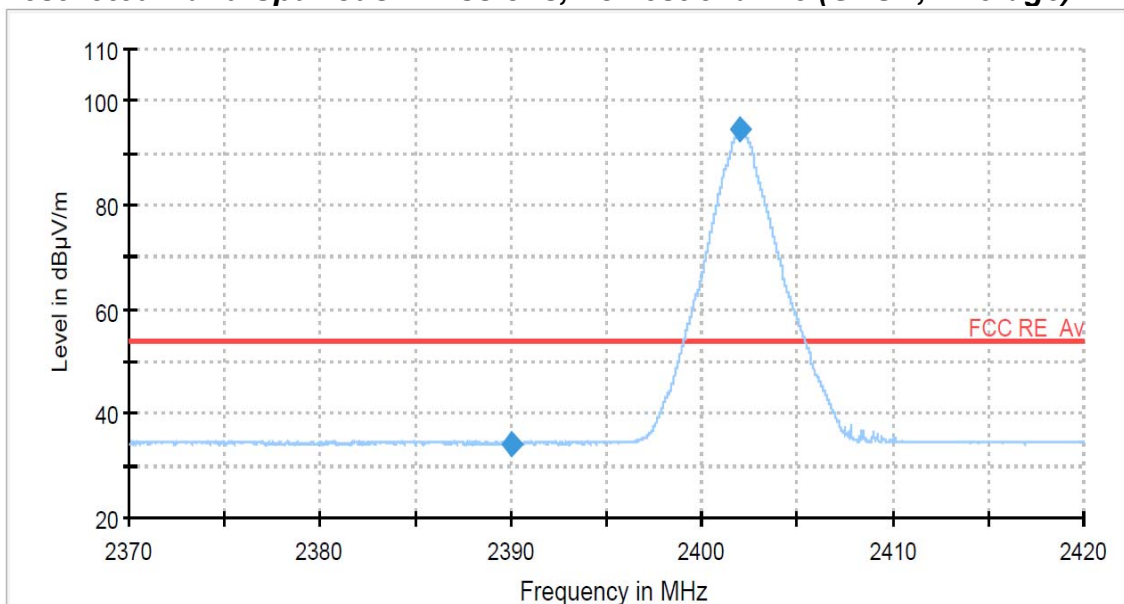

# PLOT OF TEST DATA

**Restricted Band Spurious Emissions, Highest channel (GFSK, Peak)**

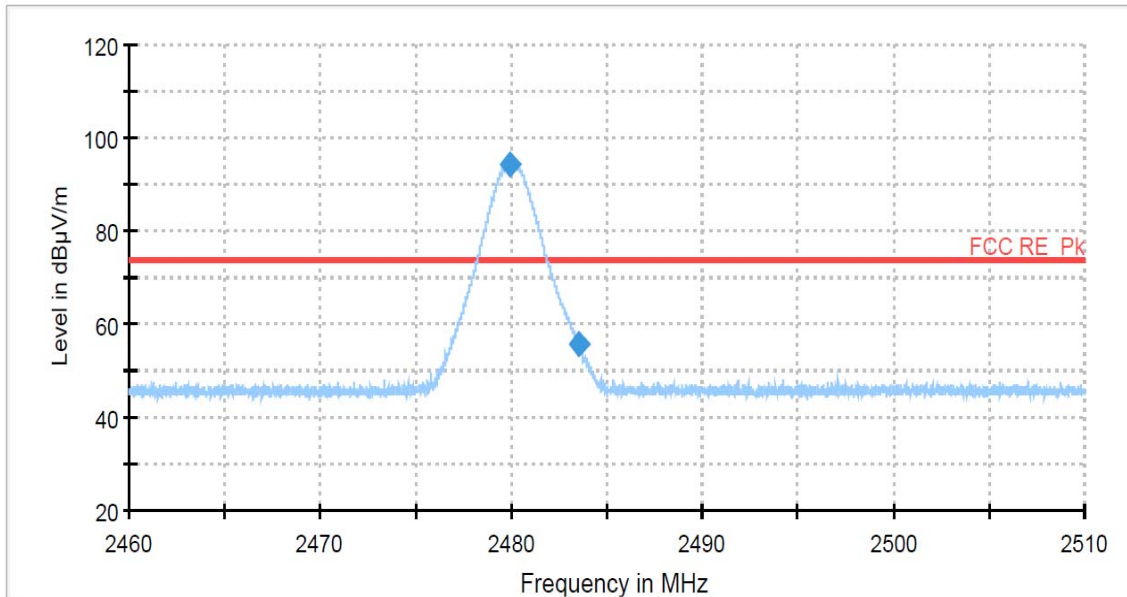

**Restricted Band Spurious Emissions, Highest channel (GFSK, Average)**

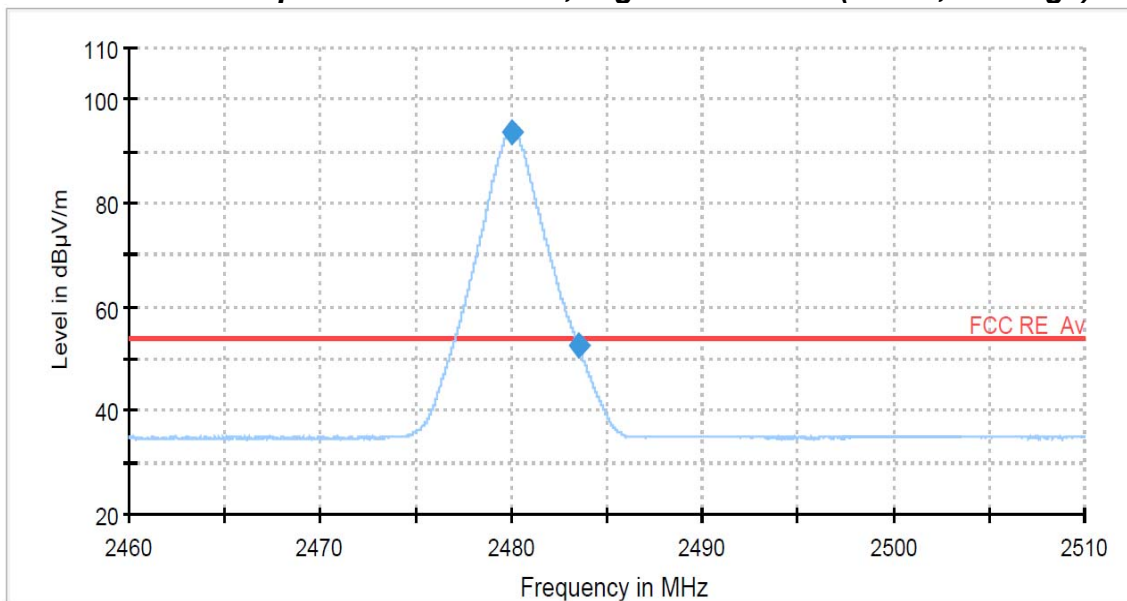

## 9. TEST EQUIPMENT

No.	Instrument	Manufacturer	Model	Serial No.	Calibration Date	Calibration Interval
1	*Test Receiver	R & S	ESU 40	100202	Apr. 04 2016	1 year
2	*Test Receiver	R & S	ESCS30	100302	Oct. 06 2015	1 year
3	*Attenuator	PASTERNAK	PE7395-10	1441	Jan. 19 2016	1 year
4	*Attenuator	FAIRVIEW	SA3N5W-06	N/A	Apr. 04 2016	1 year
5	*Attenuator	FAIRVIEW	SA3N5W-10	N/A	Apr. 04 2016	1 year
6	Attenuator	WEINSCHEL	56-10	58765	Oct. 02 2015	1 year
7	*Amplifier	R & S	SCU 01	10030	Apr. 04 2016	1 year
8	*Amplifier	R & S	SCU18	10065	Apr. 04 2016	1 year
9	*Amplifier	R & S	SCU26	10011	Jul. 15 2016	1 year
10	Amplifier	R & S	SCU40	10008	Jul. 15 2016	1 year
11	*Pre Amplifier	HP	8449B	3008A00107	Jan. 07 2016	1 year
12	Spectrum Analyzer	R & S	FSW43	100732	Apr. 05 2016	1 year
13	*Spectrum Analyzer	Agilent	N9020A	MY51110087	Oct. 15 2015	1 year
14	*Spectrum Analyzer	R&S	FSP40	100361	Jul. 15 2016	1 year
15	*Loop Antenna	R & S	HFH2-Z2	100279	Feb. 22 2016	2 year
16	*Horn Antenna	SCHWARZBECK	BBHA9120D	9120D-474	Sep. 01 2014	2 year
17	*Horn Antenna	Q-par Angus	QSH20S20	8179	Apr. 30 2015	2 year
18	Horn Antenna	Q-par Angus	QSH22K20	8180	Apr. 30 2015	2 year
19	*Trilog-Broadband Antenna	SCHWARZBECK	VULB 9163	9163-423	Nov. 04 2015	2 year
20	LISN	R & S	ESH3-Z5	833874/006	Oct. 06 2015	1 year
21	*Controller	INNCO	CO2000-G	CO2000/562/23890210/L	N/A	N/A
22	*Turn Table	INNCO	DT3000-3T	N/A	N/A	N/A
23	*Antenna Mast	INNCO	MA4000-EP	N/A	N/A	N/A
24	*Open Switch And Control Unit	R & S	OSP-120	100015	N/A	N/A
25	*Anechoic Chamber	Seo-Young EMC	N/A	N/A	N/A	N/A
26	*Position Controller	INNCO	CO2000	12480406/L	N/A	N/A
27	*Turn Table	INNCO	DS1200S	N/A	N/A	N/A
28	*Antenna Mast	INNCO	MA4000	N/A	N/A	N/A
29	*Anechoic Chamber	Seo-Young EMC	N/A	N/A	N/A	N/A
30	Shielded Room	Seo-Young EMC	N/A	N/A	N/A	N/A
31	*Open Switch And Control Unit	R & S	OSP-120	100081	N/A	N/A

\*) Test equipment used during the test

## 10. ACCURACY OF MEASUREMENT

The Measurement Uncertainties stated were calculated in accordance with the requirements of measurement uncertainty contained in CISPR 16-4-2 with the confidence level of 95%

### 1. Conducted Uncertainty Calculation

Source of Uncertainty	$X_i$	Uncertainty of $X_i$		Coverage factor $k$	$u(X_i)$ (dB)	$C_i$	$C_i u(X_i)$ (dB)
		Value (dB)	Probability Distribution				
Receiver reading	<b>RI</b>	± 0.1	normal 1	1.000	0.1	1	0.1
Attenuation AMN-Receiver	<b>LC</b>	± 0.08	normal 2	2.000	0.04	1	0.04
AMN Voltage division factor	<b>LAMN</b>	± 0.8	normal 2	2.000	0.4	1	0.4
Sine wave voltage	<b>dVSW</b>	± 2.00	normal 2	2.000	1.00	1	1.00
Pulse amplitude response	<b>dVPA</b>	± 1.50	rectangular	1.732	0.87	1	0.87
Pulse repetition rate response	<b>dVPR</b>	± 1.50	rectangular	1.732	0.87	1	0.87
Noise floor proximity	<b>dVNF</b>	± 0.00	-	-	0.00	1	0.00
AMN Impedance	<b>dZ</b>	± 1.80	triangular	2.449	0.73	1	0.73
Ⓐ Mismatch	<b>M</b>	+ 0.70	U-Shaped	1.414	0.49	1	0.49
Ⓑ Mismatch	<b>M</b>	- 0.80	U-Shaped	1.414	- 0.56	1	- 0.56
Measurement System Repeatability	<b>RS</b>	0.05	normal 1	1.000	0.05	1	0.05
Remark	Ⓐ: AMN-Receiver Mismatch : + Ⓑ: AMN-Receiver Mismatch : -						
Combined Standard Uncertainty	Normal			± 1.88			
Expanded Uncertainty U	Normal ( $k = 2$ )			± 3.76			

## 2. Radiation Uncertainty Calculation

Source of Uncertainty	$X_i$	Uncertainty of $X_i$		Coverage factor $k$	$u(X_i)$ (dB)	$C_i$	$C_i u(X_i)$ (dB)
		Value (dB)	Probability Distribution				
Measurement System Repeatability	<b>RI</b>	0.34	normal 1	1.00	0.34	1	0.34
Receiver reading	<b>dVsw</b>	± 0.02	normal 2	2.00	0.01	1	0.01
Sine wave voltage	<b>dVpa</b>	± 0.17	normal 2	2.00	0.09	1	0.09
Pulse amplitude response	<b>dVpr</b>	± 0.92	normal 2	2.00	0.46	1	0.46
Pulse repetition rate response	<b>dVnf</b>	± 0.35	normal 2	2.00	0.18	1	0.18
Noise floor proximity	<b>AF</b>	± 0.50	normal 2	2.00	0.25	1	0.25
Antenna Factor Calibration	<b>CL</b>	± 2.00	rectangular	$\sqrt{3}$	1.15	1	1.15
Cable Loss	<b>AD</b>	± 1.00	normal 2	2.00	0.50	1	0.50
Antenna Directivity	<b>AH</b>	± 0.00	rectangular	$\sqrt{3}$	0.00	1	0.00
Antenna Factor Height Dependence	<b>AP</b>	± 2.00	rectangular	$\sqrt{3}$	1.15	1	1.15
Antenna Phase Centre Variation	<b>AI</b>	± 0.20	rectangular	$\sqrt{3}$	0.12	1	0.12
Antenna Factor Frequency Interpolation	<b>SI</b>	± 0.25	rectangular	$\sqrt{3}$	0.14	1	0.14
Site Imperfections	<b>DV</b>	± 4.00	triangular	$\sqrt{6}$	1.63	1	1.63
Measurement Distance Variation	<b>Dbal</b>	± 0.60	rectangular	$\sqrt{3}$	0.35	1	0.35
Antenna Balance	<b>DCross</b>	± 0.90	rectangular	$\sqrt{3}$	0.52	1	0.52
Cross Polarisation	<b>M</b>	± 0.00	rectangular	$\sqrt{3}$	0.00	1	0.18
Mismatch	<b>M</b>	+ 0.98 - 1.11	U-Shaped	$\sqrt{2}$	0.74	1	0.74
EUT Volume Diameter	<b>M</b>	0.33	normal 1	1.00	0.33	1	0.11
Remark							
Combined Standard Uncertainty	Normal						
Expanded Uncertainty U	Normal ( $k = 2$ )						