

Nemko Korea Co., Ltd.

159 Osan-ro, Mohyeon-myeon, Cheoin-gu, Yongin-si, Gyeonggi-do, 16885, Republic of Korea

TEL:+82 31 330 1700

FAX:+82 31 322 2332

FCC and IC EVALUATION REPORT FOR CERTIFICATION

Applicant :

Anam Electronics Co., Ltd.
27, Digital-ro 27ga-gil, Guro-gu, Seoul,
08375, Republic of Korea.
Attn. : Byeong-Seob, Lee

Dates of Issue : September 05, 2017

Test Report No. : NK-17-R-194

Test Site : Nemko Korea Co., Ltd.

FCC
IC

Brand Name

Contact Person

**MBBDSB50BT
11657A-DSB50BT****DENON**

Anam Electronics Co., Ltd.
27, Digital-ro 27ga-gil, Guro-gu, Seoul,
08375, Republic of Korea.
Byeong-Seob, Lee
Telephone No. : +82-2-6424-4881

Applied Standard: FCC 47 CFR Part 15.247 and IC RSS-247 Issue 2
Classification: Digital Transmission System (DTS)
EUT Type: BT SPEAKER

The device bearing the brand name and model specified above has been shown to comply with the applicable technical standards as indicated in the measurement report and was tested in accordance with the measurement procedures specified in ANSI C63.10-2013. The client should not use it to claim product endorsement by TAF or any government agencies. The test results in the report only apply to the tested sample.

I attest to the accuracy of data and all measurements reported herein were performed by me or were made under my supervision and are correct to the best of my knowledge and belief. I assume full responsibility for the completeness of these measurements and vouch for the qualifications of all persons taking them.



Tested By : Seungyong Shin
Engineer

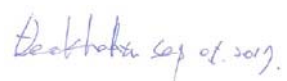

Reviewed By : Deokha Ryu
Technical Manager

TABLE OF CONTENTS

1. Scope	4
2. Introduction (Site Description)	5
2.1 Test facility	5
2.2 Accreditation and listing	6
3. Test Conditions & EUT Information	7
3.1 Operation During Test	7
3.1.1 Table of test power setting	7
3.1.2 Table of test channels	7
3.1.3 Antenna Tx mode information	7
3.1.4 Table of Test modes	7
3.1.5 Additional Information Related to Testing	8
3.2 Support Equipment	8
3.3 Setup Drawing	9
3.4 EUT Information	10
4. Summary of Test Results	11
5. Recommendation / Conclusion	12
6. Antenna Requirements	12
7. Description of Test	13
7.1 Radiated Emissions	13
7.2 6 dB Bandwidth	14
7.3 Peak Output Power and E.I.R.P.	15
7.4 Peak Power Spectral Density	16
7.5 Conducted Spurious Emissions	17

8.	Test Data	18
8.1	Radiated Emissions	18
8.2	6 dB Modulated Bandwidth	20
8.3	Peak Output Power and E.I.R.P	23
8.4	Peak Power Spectral Density	26
8.5	Conducted Spurious Emissions	29
8.6	Radiated Spurious Emissions	33
8.7	Radiated Band Edge	37
9.	Test Equipment	39
10.	Accuracy of Measurement	40

1. SCOPE

Measurement and determination of electromagnetic emissions (EME) of radio frequency devices including intentional and/or unintentional radiators for compliance with the technical rules and regulations of the Federal Communications Commission under FCC part 15 and IC RSS-247 Issue2.

Responsible Party :	Anam Electronics Co., Ltd. 27, Digital-ro 27ga-gil, Guro-gu, Seoul, 08375, Republic of Korea
Contact Person :	Byeong Seob, Lee
Manufacturer :	D&M HOLDINGS INC. D&M Building, 2-1 Nisshin-cho, Kawasaki-ku, Kawasaki-shi, Kanagawa-ken, 210-8569, JAPAN

- FCC ID: MBBDSB50BT
- IC : 11657A-DSB50BT
- Model: DSB50BT
- HVIN: DSB50BT
- Brand Name: DENON
- EUT Type: BT SPEAKER
- Classification: Digital Transmission System (DTS)
- Applied Standard: FCC 47 CFR Part 15 subpart C and IC RSS-247 Issue 2
- Test Procedure(s): ANSI C63.10-2013 and FCC guidance of Guidance 558074
D01 DTS Meas Guidance v04
- Dates of Test: August 11, 2017 ~ September 04, 2017
- Place of Tests: Nemko Korea Co., Ltd.

2. INTRODUCTION

2.1 Test facility

The measurement procedure described in American National Standard for Methods of Measurement of Radio-Noise Emissions from Low-Voltage Electrical and Electronic Equipment in the Range of 9 kHz to 40 GHz (ANSI C63.4-2014), the American National Standard for Testing Unlicensed Wireless Devices (ANSI C63.10-2013) was used in determining radiated and conducted emissions emanating from **Anam Electronics Co., Ltd. FCC ID : MBBDSB50BT and IC : 11657A-DSB50BT.**

These measurement tests were conducted at **Nemko Korea Co., Ltd. EMC Laboratory .**

The site address 159, Osan-ro, Mohyeon-myeon, Cheoin-gu, Yongin-si, Gyeonggi-do, 16885, Republic of Korea.

The area of Nemko Korea Corporation Ltd. EMC Test Site is located in a mountain area at 80 km (48 miles) southeast and Incheon International Airport (Incheon Airport), 30 km (18miles) south-southeast from central Seoul.

It is located in the valley surrounded by mountains in all directions where ambient radio signal conditions are quiet and a favorable area to measure the radio frequency interference on open field test site for the computing and ISM devices manufactures.







The detailed description of the measurement facility was found to be in compliance with the requirements of ANSI C63.4-2014 according to §2.948.



Nemko Korea Co., Ltd.
 EMC Lab.
 159, Osan-ro, Mohyeon-myeon,
 Cheoin-gu, Yongin-si, Gyeonggi-do,
 16885, Republic of Korea.
 Tel)+82-31-330-1700
 Fax)+82-31-322-2332

Fig. 1. The map above shows the Seoul in Korea vicinity area.
 The map also shows Nemko Korea Corporation Ltd. EMC Lab. and Incheon Airport.

2.2 Accreditation and listing

Accreditation type		Accreditation number
	CAB Accreditation for DOC	Designation No. KR0026
	KOLAS Accredited Lab. (Korea Laboratory Accreditation Scheme)	Registration No. 155
	Canada IC Registered site	Site No. 2040E
	VCCI registration site(RE/CE/Telecom CE)	Member No. 2118
	EMC CBTL	-
	KCC(RRL)Designated Lab.	Registration No. KR0026

3. TEST CONDITIONS & EUT INFORMATION

3.1 Operation During Test

The EUT is the transceiver which is the Bluetooth 4.2 module supporting BDR/EDR/LE mode. The Laptop was used to control the EUT to transmit the wanted TX channel by the testing program (Bluetest) which manufacturer supported. The Laptop was removed after controlling the EUT to transmit the wanted signal. The EUT was tested at the lowest channel, middle channel and the highest channel with the maximum output power in accordance with the manufacturer's specifications. The worst data were recorded in the report.

3.1.1 Table of test power setting

Frequency band	Mode	Power setting Level
2402~2480 MHz	LE	Default

3.1.2 Table of test channels

Frequency band	Mode	Test Channel (CH)	Frequency (MHz)
2.4 GHz	LE	37	2402
		18	2442
		39	2480

3.1.3 Antenna TX mode information

Frequency band	Mode	Antenna TX mode	Support MIMO
2.4 GHz	LE	<input checked="" type="checkbox"/> 1TX, <input type="checkbox"/> 2TX	<input type="checkbox"/> Yes, <input checked="" type="checkbox"/> No

3.1.4 Additional Information Related to Testing

The cable and attenuator loss from 30MHz to 26.5GHz was reflected in spectrum analyzer with correction factor for all conducted testing.

3.1.5 Table of test modes

Test Items	Mode	Modulation	Test Channel (CH)
Conducted Emissions	LE	GFSK	39
Radiated Emissions			39
6 dB Bandwidth			37/18/39
Peak Output Power			37/18/39
Peak Power Spectral Density			37/18/39
Conducted Spurious Emission			37/18/39
Radiated Spurious Emission, Band edge Emission			37/18/39

3.2 Support Equipment

EUT	Anam Electronics Co., Ltd. Model : DSB50BT	S/N: N/A
Laptop Computer	HP Model : G62-355TU 1.5 m shielded pin connector cable	FCC DOC S/N : CNF0489WDT
AC/DC Adapter	HP Model : PPP009D 1.5 m unshielded power cable	FCC DOC S/N : WBGSV0ACXZH162

3.3 Setup Drawing

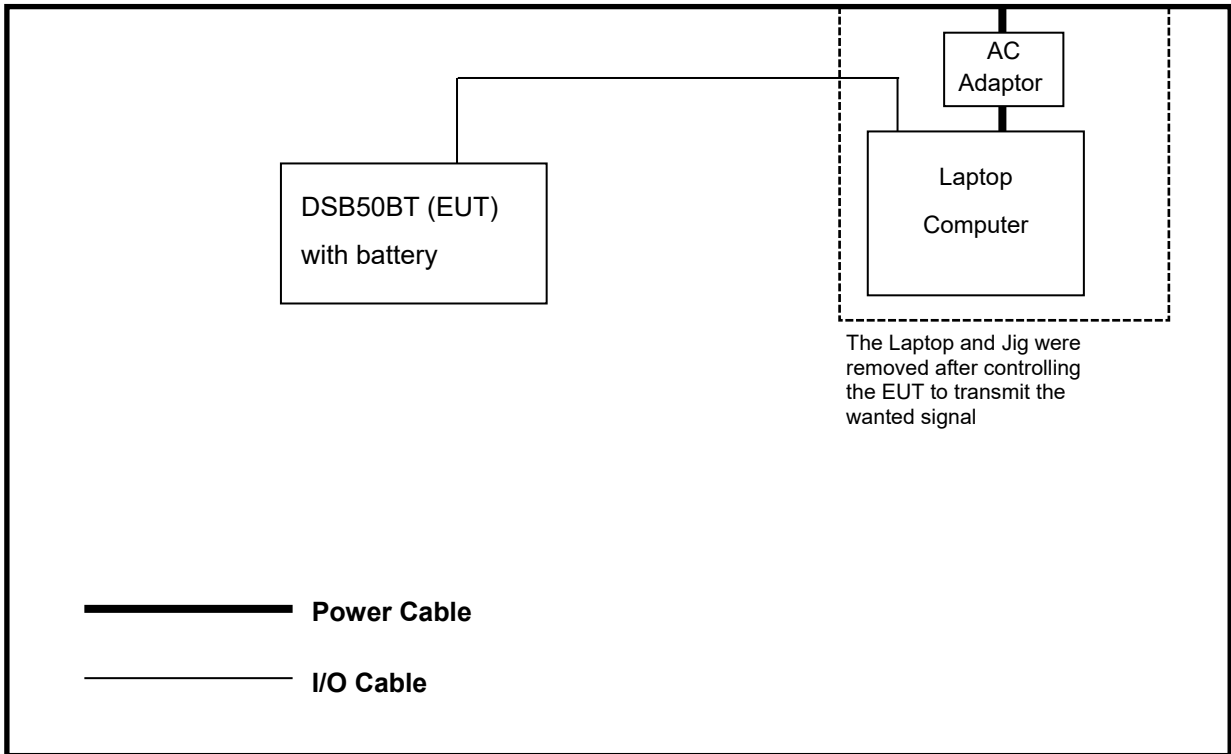

3.4 EUT Information

The EUT is the **Anam BT SPEAKER FCC ID: MBBDSB50BT, IC: 11657A-DSB50BT.**

This unit supports full qualified Bluetooth 4.2 with LE standard system.

Specifications:

EUT Type	BT SPEAKER
Model Name	DSB50BT
Brand Name	DENON
RF Frequency	2402 MHz ~ 2480 MHz
Peak Output Power(Conducted) E.I.R.P	5.66 dBm 9.03 dBm
FCC Classification	Digital Transmission System (DTS)
Channel Number	40 ch
Modulation	GFSK(BLE)
Antenna Gain (peak)	3.37 dBi
Antenna Setup	1TX / 1RX
Voltage	Operating Voltage : 3.7Vdc (Battery) Test Voltage : 3.7 Vdc
Temperature Range	-10°C ~ +50 °C
Size (H x W x D)	About 5.7 mm x 16.0 mm x 5.5 mm
Weight	About 394 g
HVIN (Hardware version number)	DSB50BT
FVIN (Firmware Version Identification Number)	FWV034
Remarks	-

4. SUMMARY OF TEST RESULTS

The EUT has been tested according to the following specification:

Name of Test	FCC Paragraph No.	IC Paragraph No.	Result	Remark
Conducted Emission	15.207	RSS-GEN Issue 4 8.8	Complies	
Radiated Emission	15.209	RSS-GEN Issue 4 8.9	Complies	
6 dB Bandwidth	15.247(a)(2)	RSS-247 Issue 2 5.2	Complies	
Peak Output Power and E.I.R.P	15.247(b)(3)	RSS-247 Issue 2 5.4	Complies	
Power Spectral Density	15.247(e)	RSS-247 Issue 2 5.2	Complies	
Conducted Spurious Emission	15.247(d)	RSS-247 Issue 2 5.5	Complies	
Radiated Spurious Emission	15.247(d)	RSS-247 Issue 2 5.5	Complies	

5. RECOMMENDATION/CONCLUSION

The data collected shows that the **Anam BT SPEAKER FCC ID: MBBDSB50BT, IC: 11657A-DSB50BT** is in compliance with Part 15.247 of the FCC Rule and RSS-247 Issue 2 of the IC specification.

6. ANTENNA REQUIREMENTS

§15.203 of the FCC Rules part 15 Subpart C

: An intentional radiator shall be designed to ensure that no antenna other than that furnished by the responsible party shall be used with the device. The use of a permanently attached antenna or of an antenna that uses a unique coupling to the intentional radiator shall be considered sufficient to comply with the provisions of this section.

The antenna of the **Anam BT SPEAKER FCC ID: MBBDSB50BT, IC: 11657A-DSB50BT** is **permanently attached** and there are no provisions for connection to an external antenna. It complies with the requirement of §15.203.

7. DESCRIPTION OF TESTS

7.1 Radiated Emissions

The measurement was performed at the test site that is specified in accordance with ANSI C63.10-2013.

The spurious emission was scanned from 9 kHz to 30 MHz using Loop Antenna(Rohde&Schwarz, HFH2-Z2) and 30 to 1000 MHz using Trilog broadband test antenna(Schwarzbeck, VULB 9163). Above 1 GHz, Horn antenna (Schwarzbeck BBHA 9120D: up to 18 GHz, Q-par Angus QSH20S20 : 18 to 26.5 GHz) was used.

For emissions testing at below 1GHz, The test equipment was placed on turntable with 0.8 m above ground. For emission measurements above 1 GHz, The test equipment was placed on turntable with 1.5 m above ground. Sufficient time for the EUT, support equipment, and test equipment was allowed in order for them to warm up to their normal operating condition. The EUT, cable, wire arrangement and mode of operation that has the highest amplitude relative to the limit was selected. Then, the turn table was rotated from 0° to 360° and an antenna mast was moved from 1 m to 4 m height to maximize the suspected highest amplitude signal. The final maximized level was recorded.

At frequencies below 1000 MHz, measurements performed using the CISPR quasi-peak detection. At frequencies above 1000 MHz, measurements performed using the peak and average measurement procedures described in KDB "558074 D01 DTS Meas Guidance v04 in section 12.2.4 and 12.2.5.3. Peak emission levels were measured by setting the analyzer RBW = 1 MHz, VBW = 3 MHz, Detector = Peak, Trace mode = max hold. Average emission levels were measured by setting the analyzer RBW = 1 MHz, VBW = 3 kHz, Detector = Peak, Trace mode = max hold. Allow max hold to run for at least 50 times (1/duty cycle) traces.

Frequency (MHz)	Field strength (microvolts/meter)	Measurement distance (meters)
0.009–0.490	2400/F(kHz)	300
0.490–1.705	24000/F(kHz)	30
1.705–30.0	30	30
30–88	100	3
88–216	150	3
216–960	200	3
Above 960	500	3

Radiated Emissions Limits per 47 CFR 15.209(a) and RSS-GEN issue 4 8.9

7.2 6 dB Bandwidth

Test Setup

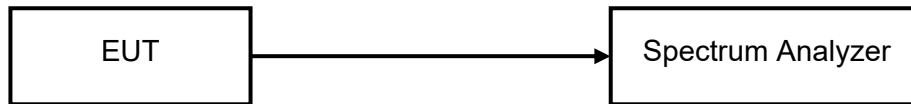

Test Procedure

EUTs 6 dB bandwidth is measured at low, middle, high channels with a spectrum analyzer connected to the antenna terminal while the EUTs operating at its maximum power control level.

The spectrum analyzer setting is as follows.

RBW = 100 kHz

VBW \geq 3 x RBW

Detector = Peak

Trace mode = max hold

Sweep = auto couple

Allow the trace to stabilize.

The bandwidth measurement function on the spectrum analyzer is used to measure the 6 dB bandwidth.

7.3 Peak Output Power and E.I.R.P

Test Setup

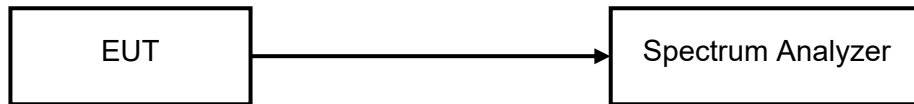

Test Procedure

EUTs Maximum Peak Conducted Output Power is measured at low, middle, high channels with a spectrum analyzer connected to the antenna terminal while the EUTs operating at its maximum power control level.

The spectrum analyzer setting is as follows.

RBW = 1 MHz

VBW = 3 MHz

Span = fully encompass the DTS bandwidth

Detector = peak

Sweep time = auto couple

Trace mode = max hold

Allow the trace to stabilize.

Use peak marker function to determine the peak amplitude level.

E.I.R.P is calculated according to KDB412172 D01 Determining ERP and EIRP v01r01

7.4 Peak Power Spectral Density

Test Setup

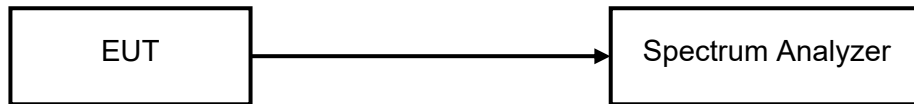

Test Procedure

EUTs Peak Power Spectral Density is measured at low, middle, high channels with a spectrum analyzer connected to the antenna terminal while the EUTs operating at its maximum power control level.

The spectrum analyzer setting is as follows.

Center frequency = DTS channel center frequency

Span = 1.5 times the DTS channel bandwidth

RBW \geq 3kHz

VBW \geq 3 x RBW

Detector = peak

Sweep time = auto couple

Trace mode = max hold

Allow the trace to stabilize.

The peak search function on the spectrum analyzer is used to determine the maximum amplitude level within the RBW.

7.5 Conducted Spurious Emissions

Test Setup

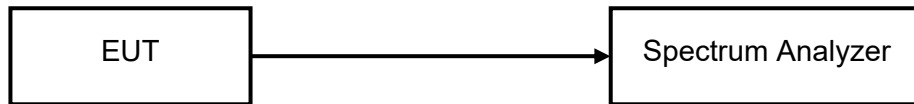

Test Procedure

EUTs Conducted spurious emissions are measured at low, middle, high channels with a spectrum analyzer connected to the antenna terminal while the EUTs operating at its maximum power control level.

The spectrum analyzer setting is as follows.

1) Reference Level

RBW = 100 kHz

VBW \geq 300 kHz

Span = 1.5 times the DTS channel bandwidth

Detector = peak

Sweep time = auto couple

Trace mode = max hold

Allow the trace to stabilize.

Use the peak marker function to determine the maximum PSD level.

Note that the channel found to contain the maximum PSD level can be used to establish the reference level.

2) Unwanted Emissions

RBW = 100 kHz

VBW \geq 300 kHz

Span = encompass the spectrum to be examined

Detector = peak

Sweep time = auto couple

Trace mode = max hold

Allow the trace to stabilize.

The amplitude of all unwanted emissions outside of the authorized frequency band is confirmed that it is attenuated by at least the minimum requirements specified.

8. TEST DATA

8.1 Radiated Emissions

FCC §15.209, RSS-Gen Issue 4 8.9

Result

Frequency (MHz)	Reading (dB μ V/m)	Pol* (H/V)	Antenna Heights (cm)	Turntable Angles (°)	AF+CL+Amp (dB)**	Result (dB μ V/m)	Limit (dB μ V/m)	Margin (dB)
38.54	51.10	V	100	171	-22.6	28.5	40.0	11.5
41.25	44.70	V	100	159	-22.2	22.5	40.0	17.5
51.05	59.40	V	100	225	-22.2	37.2	40.0	2.8
57.16	50.80	V	100	355	-22.6	28.2	40.0	11.8
104.01	43.00	V	100	204	-24.3	18.7	43.5	24.8
144.85	45.30	V	100	139	-27.2	18.1	43.5	25.4
489.83	36.40	H	100	13	-15.2	21.2	46.0	24.8

Radiated Measurements at 3meters

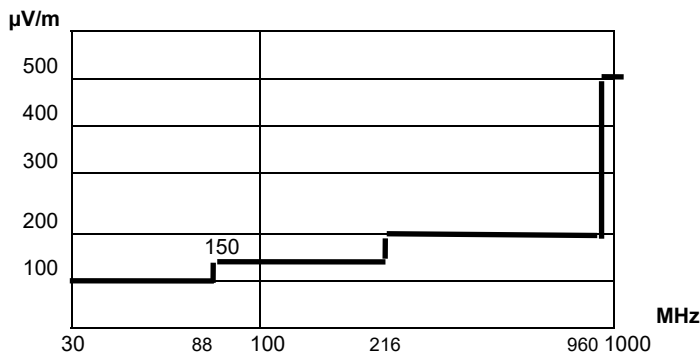

Fig. 3. Limits at 3 meters

Notes:

- All modes were measured and the worst-case emission was reported.
- The radiated limits are shown on Figure 3. Above 1GHz the limit is 500 μ V /m.
- *Pol. H = Horizontal, V = Vertical
- **AF + CL + Amp. = Antenna Factor + Cable Loss + Amplifier.
- Measurements using CISPR quasi-peak mode below 1 GHz.
- The radiated emissions testing were made by rotating the receive antenna with horizontal, Vertical polarization. The worst date was recorded.
- GFSK on the middle channel (2442MHz) is the worst case channel.
- No emission found between lowest internal used/generated frequency to 30MHz (9kHz~30MHz).
- The limit is on the FCC §15.209 and RSS-Gen Issue4 8.9

PLOTS OF EMISSIONS

Worst Case : 2442 MHz(below 1GHz) GFSK modulation

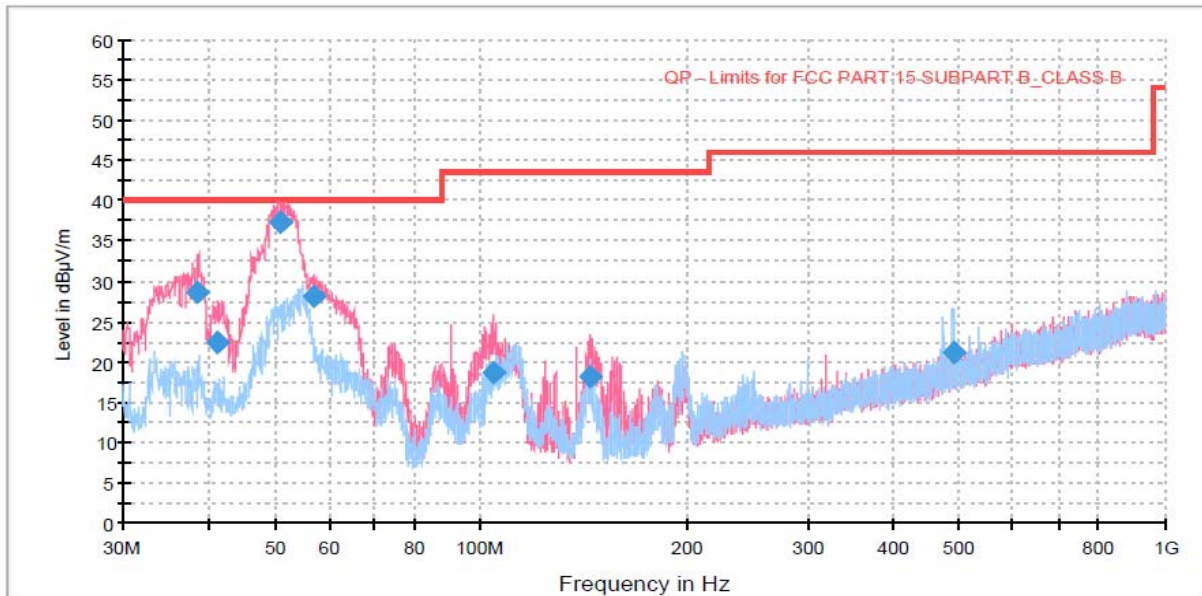

TEST DATA

8.2 6 dB Modulated Bandwidth

FCC §15.247(a)(2), IC RSS-247 Issue 2 5.2

Test Mode : Set to Lowest channel, Middle channel and Highest channel

Result

Channel	Frequency (MHz)	6 dB modulated bandwidth (MHz)	Limit (MHz)	Margin (MHz)
Lowest	2402	0.69	0.50	0.19
Middle	2442	0.69	0.50	0.19
Highest	2480	0.71	0.50	0.21

PLOTS OF EMISSIONS

6 dB Bandwidth, Lowest Channel (2402 MHz)

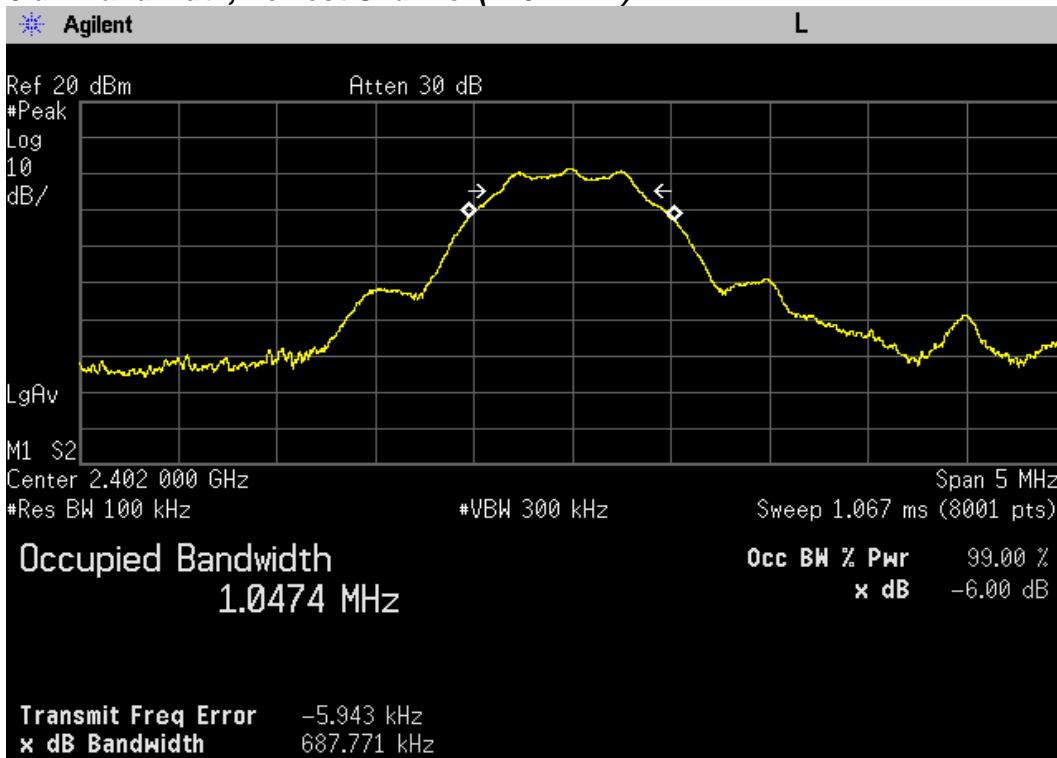

6 dB Bandwidth, Middle Channel (2442 MHz)

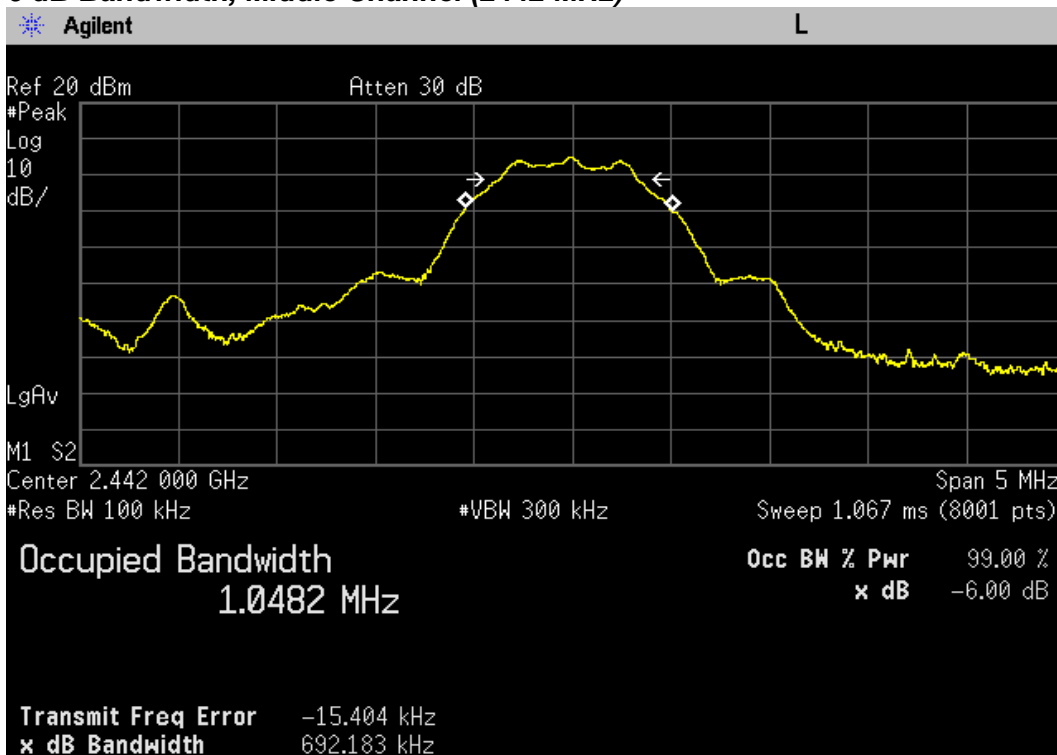

PLOTS OF EMISSIONS

6 dB Bandwidth, Highest Channel (2480 MHz)

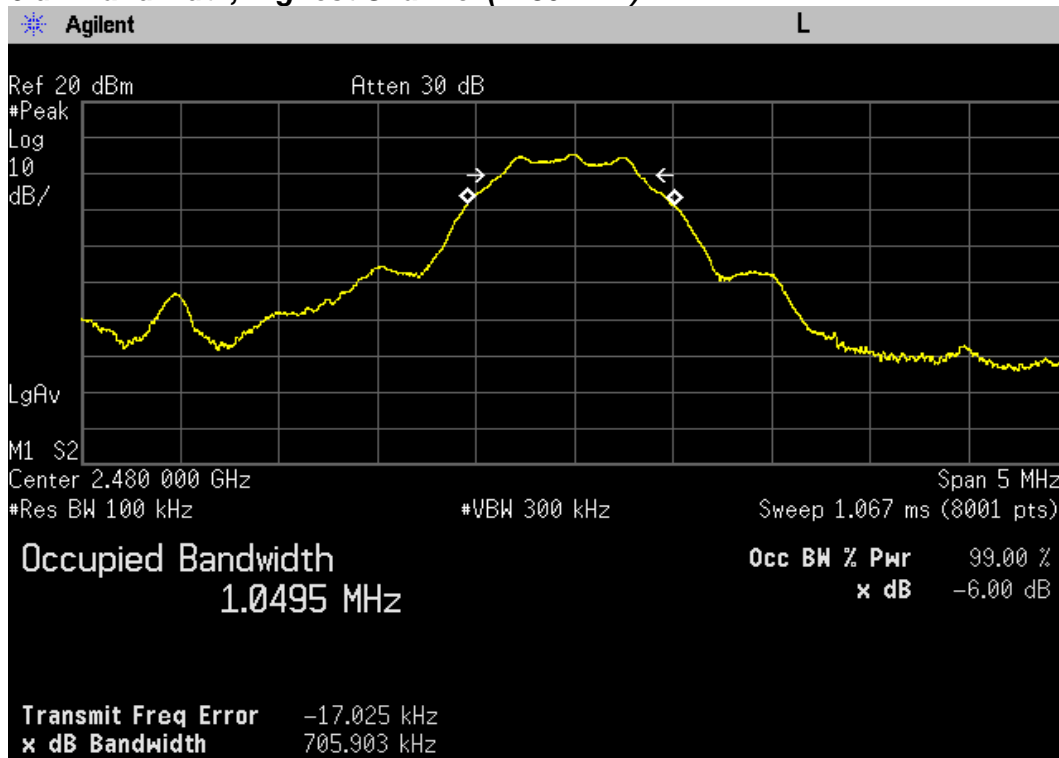

TEST DATA

8.3 Peak Output Power and E.I.R.P.

FCC §15.247(b)(3), IC RSS-247 Issue 2 5.4

Test Mode : Set to Lowest channel, Middle channel and Highest channel

Result

Frequency (MHz)	Peak Output Power (dBm)	Limit (dBm)	E.I.R.P* (dBm)	E.I.R.P Limit (dBm)	Result
2402	1.69	30.00	5.06	36.00	Complies
2442	4.97	30.00	8.34	36.00	Complies
2480	5.66	30.00	9.03	36.00	Complies

Note:

The following formular was used for spectrum offset:

$Spectrum\ offset\ (dB) = Attenuator\ (dB) + Cable\ Loss\ (dB) + SMA\ Type\ Connector\ Loss\ (dB)$

*) E.I.R.P was calculated by following equation according to KDB412172 D01 Determining ERP and EIRP v01r01.

$$E.I.R.P = P_T + G_T - L_C$$

P_T = Peak outputpower (dBm)

G_T = Gain of the transmitting antenna in dBi, Peak antenna gain is 3.37dBi.

L_C = Signal attenuation in the connecting cable between the transmitter and antenna in dB. This factor of an integral antenna is negligible.

PLOT OF TEST DATA

Maximum Peak Output Power, Lowest Channel (2402 MHz)

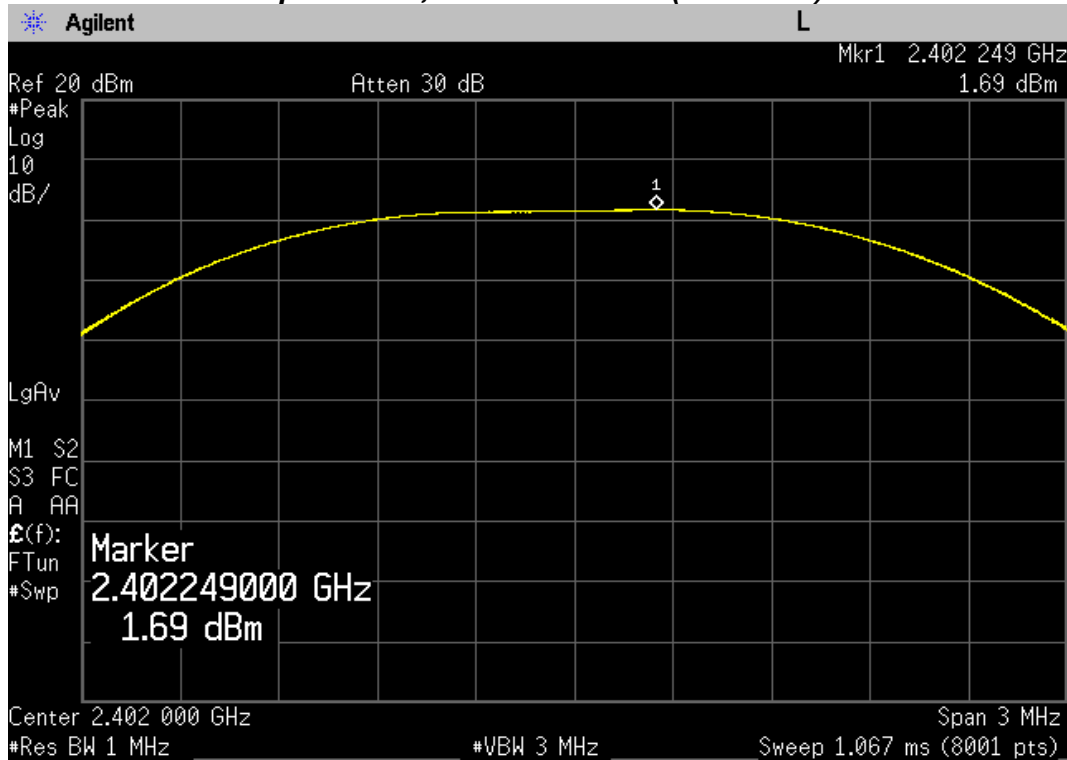

Maximum Peak Output Power, Middle Channel (2442 MHz)

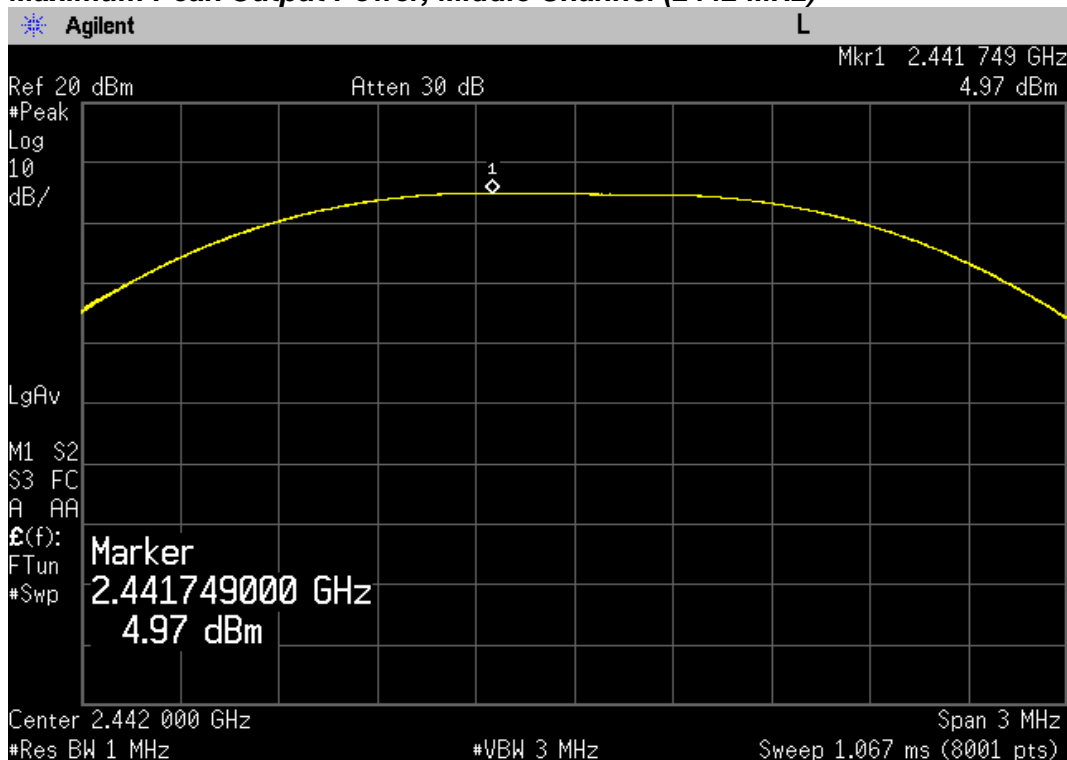

PLOT OF TEST DATA

Maximum Peak Output Power, Highest Channel (2480 MHz)

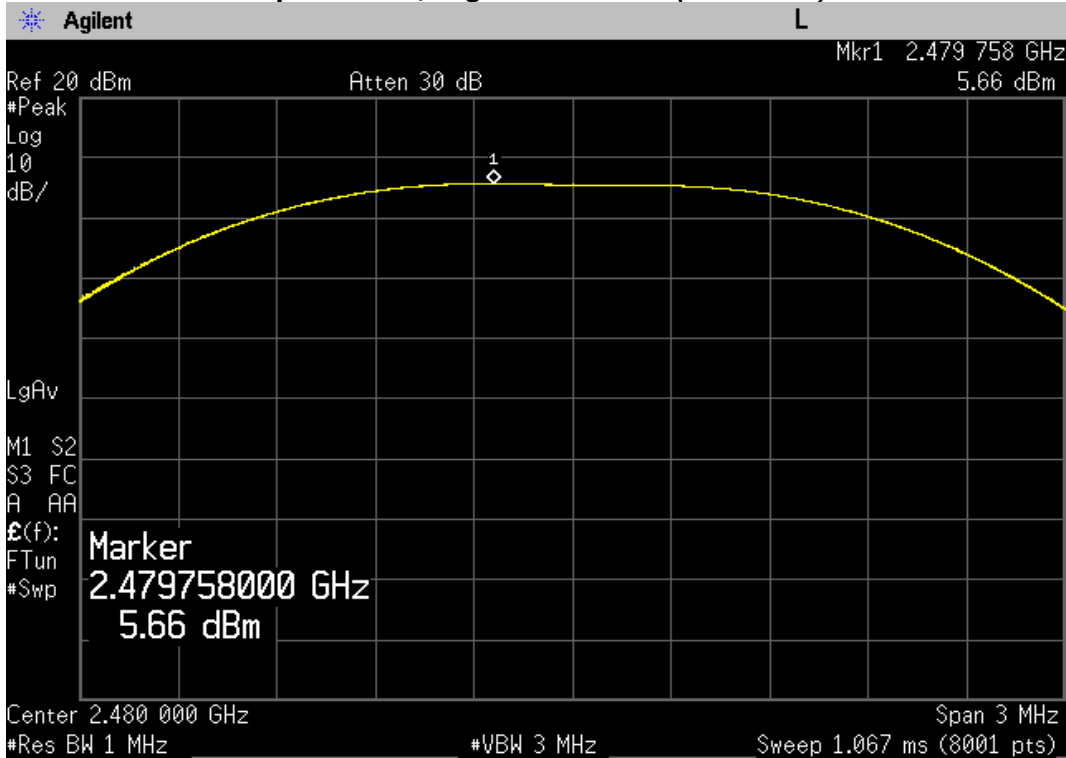

TEST DATA

8.4 Peak Power Spectral Density

FCC §15.247(e), IC RSS-247 Issue 2 5.2

Test Mode : Set to Lowest channel, Middle channel and Highest channel

Result

Channel	Frequency(MHz)	Result(dBm)	Limit (dBm)
Low	2402	1.41	8.0
Middle	2442	4.72	8.0
High	2480	5.43	8.0

Note:

The following equation was used for spectrum offset:

$\text{Spectrum offset (dB)} = \text{Attenuator (dB)} + \text{Cable Loss (dB)} + \text{SMA Type Connector Loss (dB)}$

PLOT OF TEST DATA

Peak Power Spectral Density, Lowest Channel (2402 MHz)

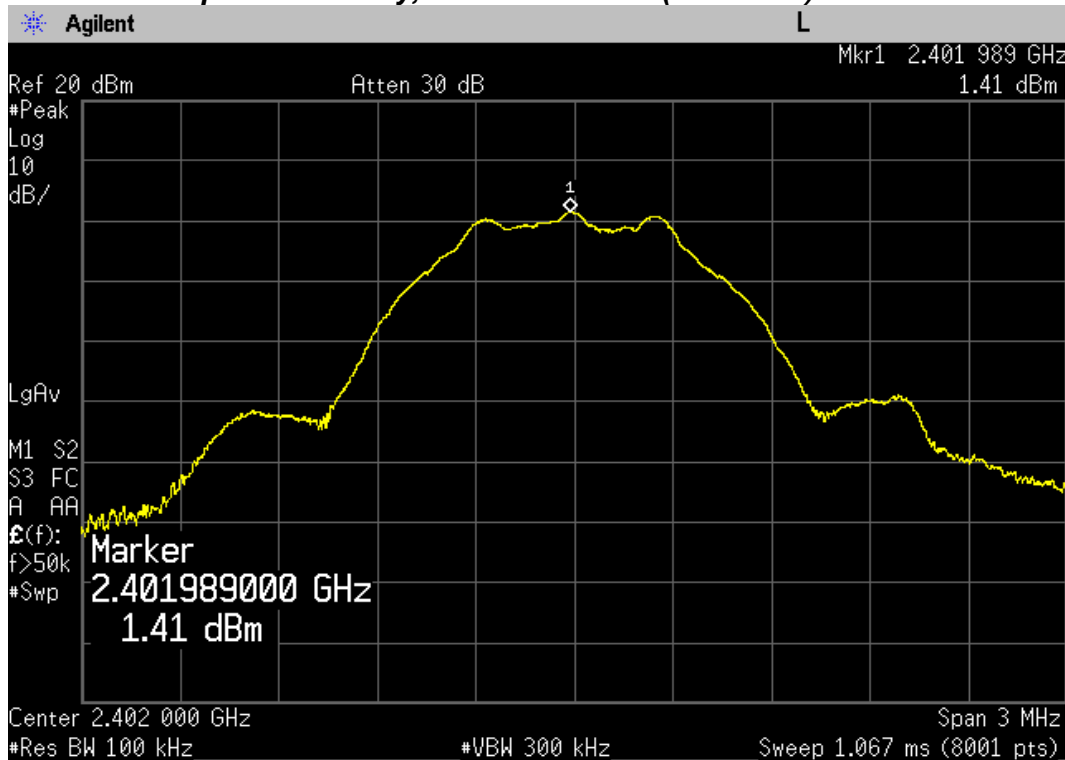

Peak Power Spectral Density, Middle Channel (2442 MHz)

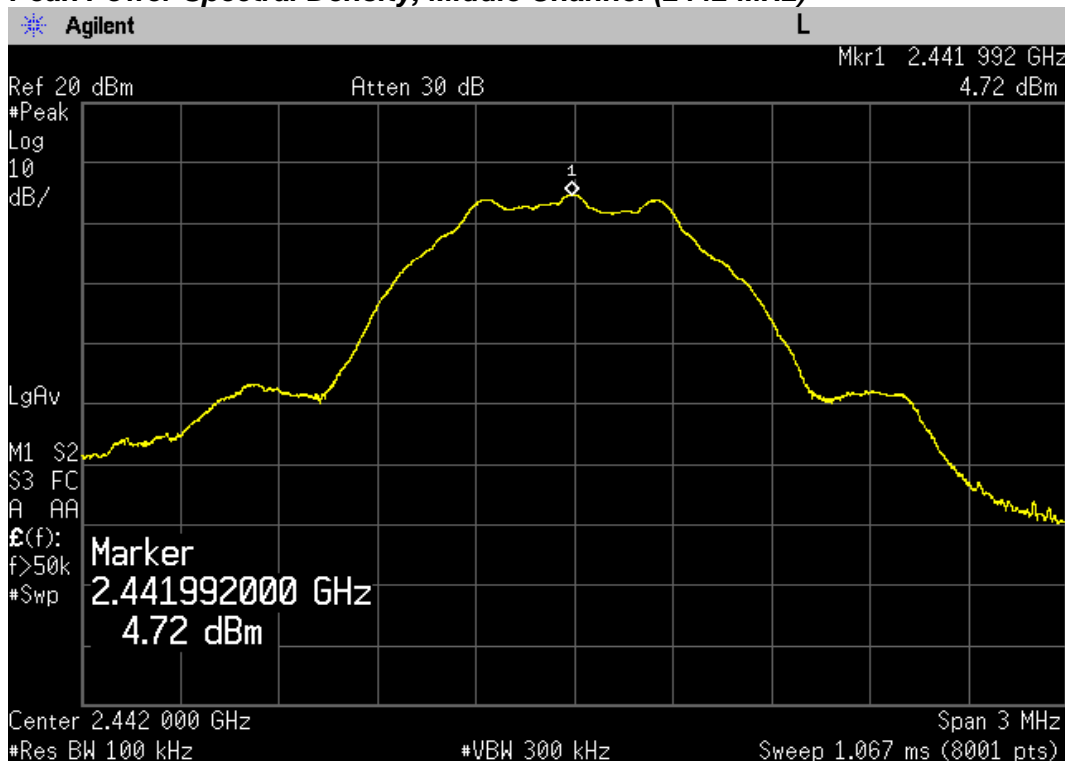

PLOT OF TEST DATA

Peak Power Spectral Density, Highest Channel (2480 MHz)

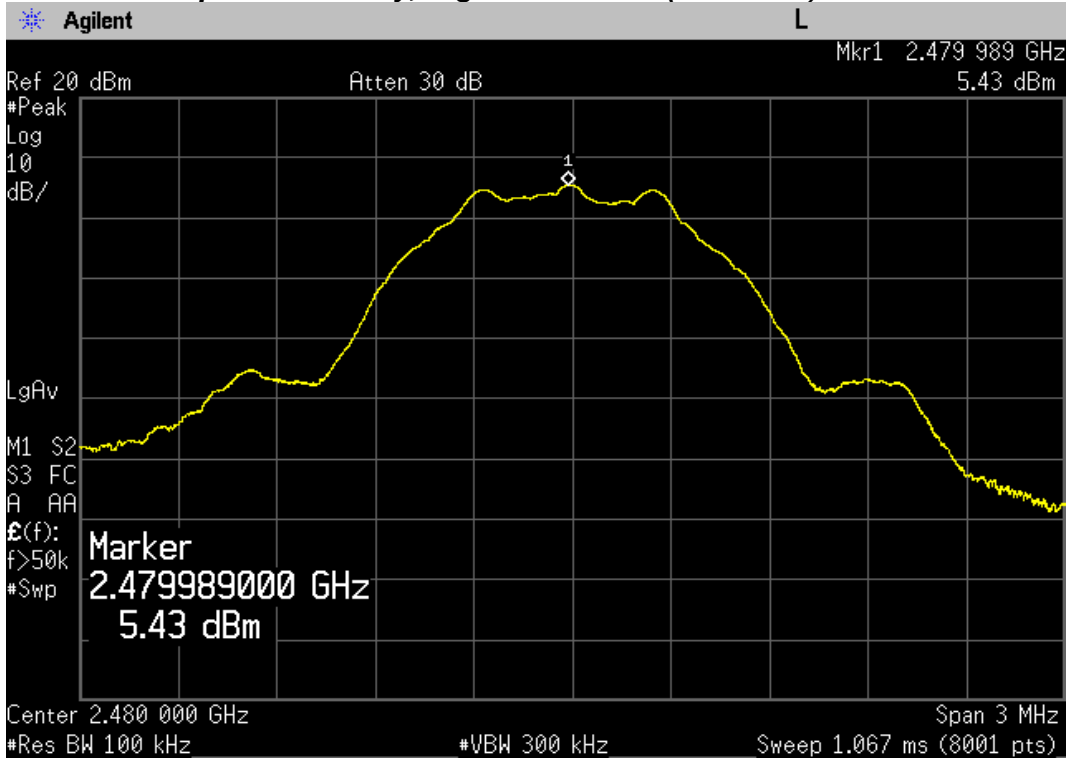

TEST DATA

8.5 Conducted Spurious Emissions

FCC §15.247(d), IC RSS-247 Issue 2 5.5

Test Mode : Set to Lowest channel, Middle channel and Highest channel

Result

Channel	Frequency (MHz)	Reference Level (dBm)*	Conducted Spurious Emissions (dBc)	Limit (dBc)
Low	2402	1.41	More than 20 dBc	20
Middle	2442	4.72	More than 20 dBc	20
High	2480	5.43	More than 20 dBc	20

Note:

**Peak Power Spectral Density measured in 8.4 was used for Reference Level.*

The cable and attenuator loss from 30 MHz to 26.5 GHz was reflected in spectrum analyzer with correction factor for the spurious emissions test.

PLOT OF TEST DATA

Conducted Spurious Emissions, 30 MHz ~ 26.5 GHz (2402 MHz)

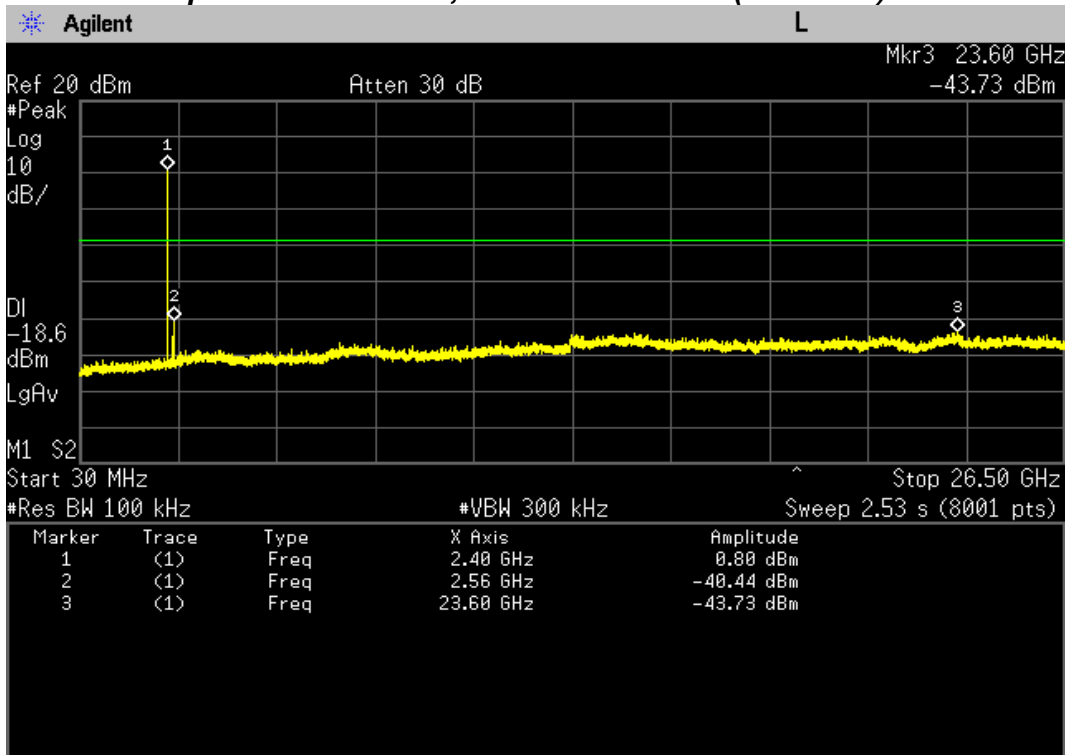

Conducted Spurious Emissions, 30 MHz ~ 26.5 GHz (2442 MHz)

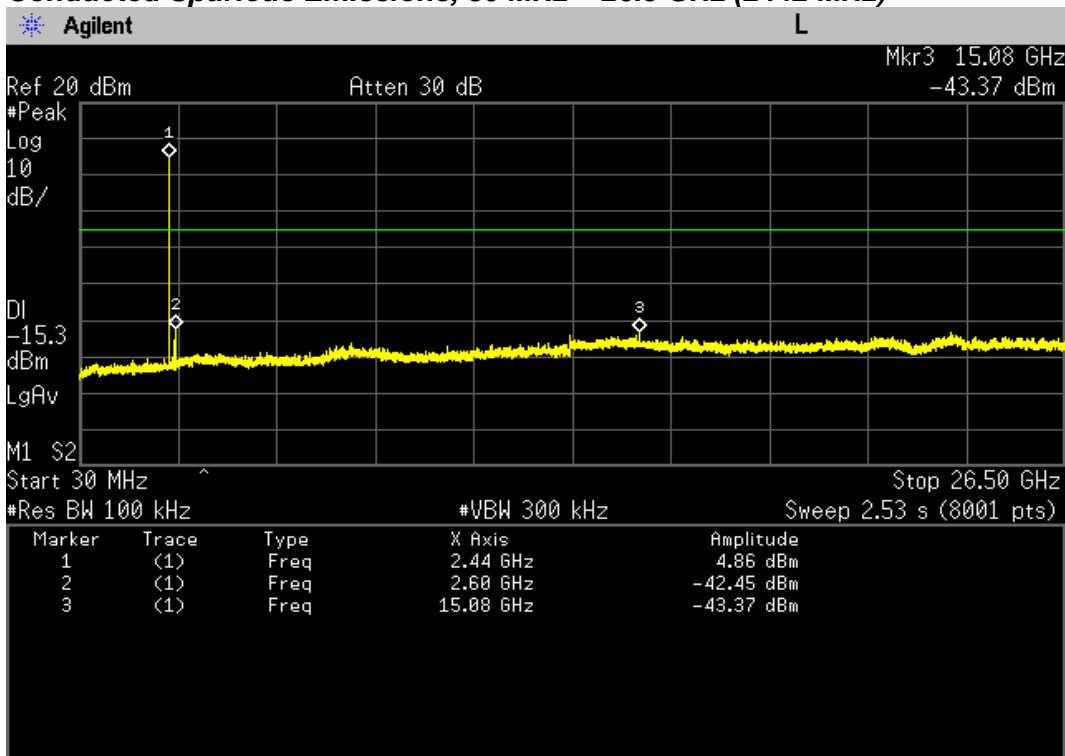

PLOT OF TEST DATA

Conducted Spurious Emissions, 30 MHz ~ 26.5 GHz (2480 MHz)

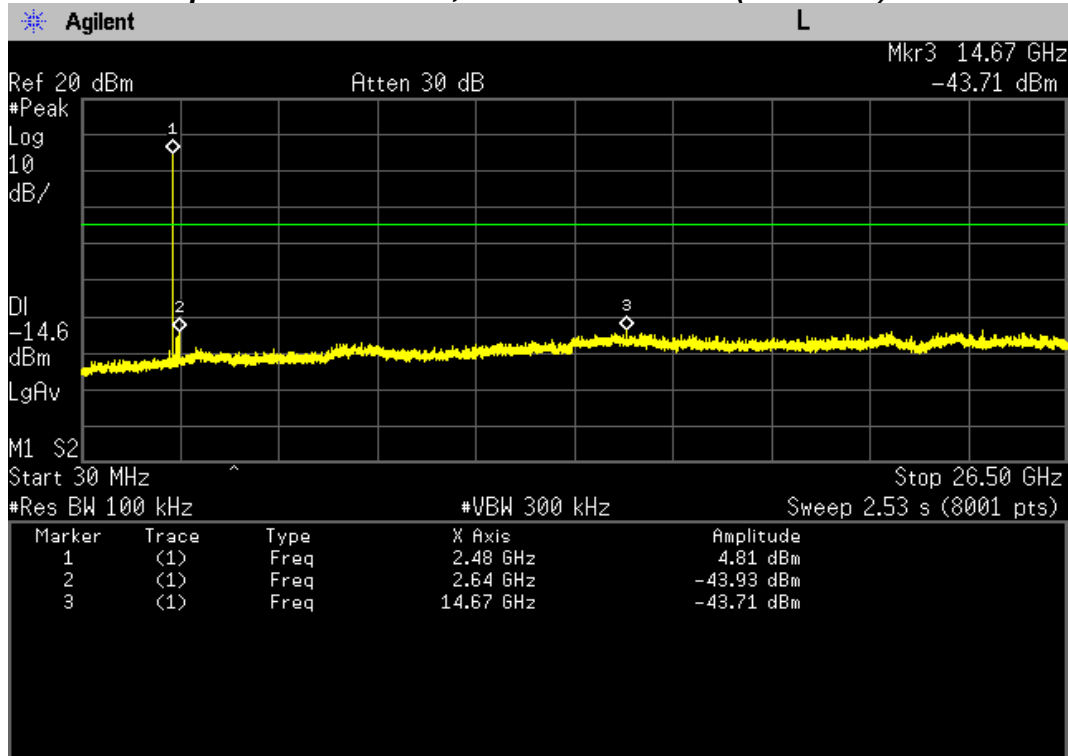

PLOT OF TEST DATA

Band Edge, Lowest Channel (2402 MHz)

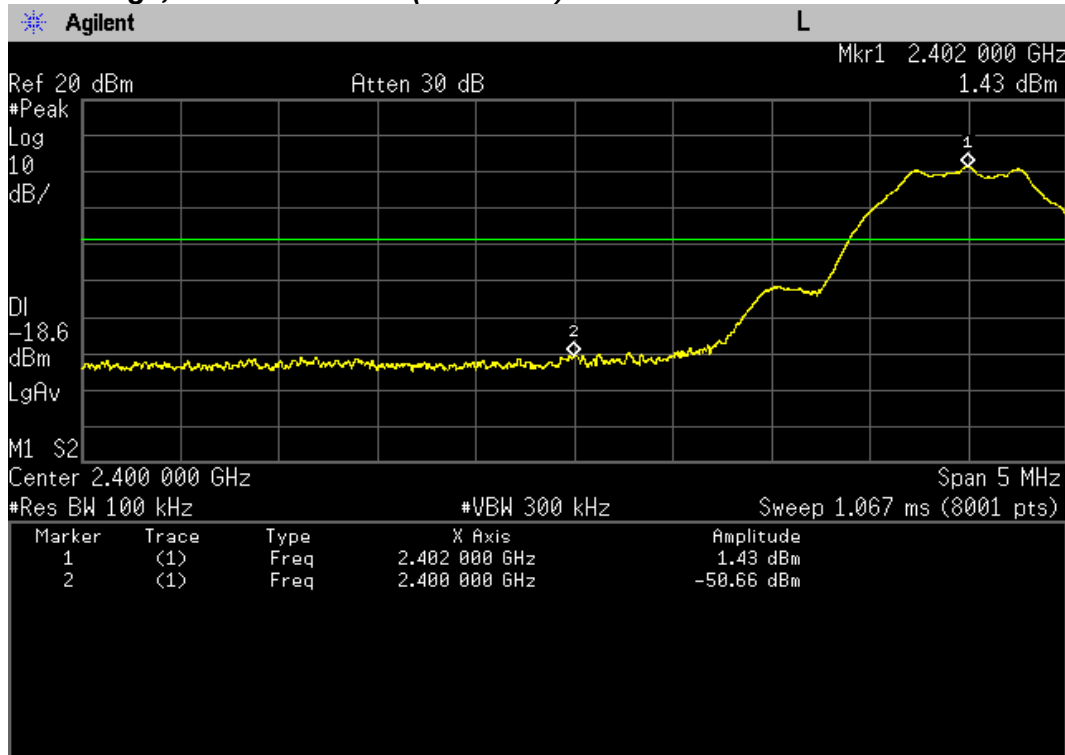

Band Edge, Highest Channel (2480 MHz)

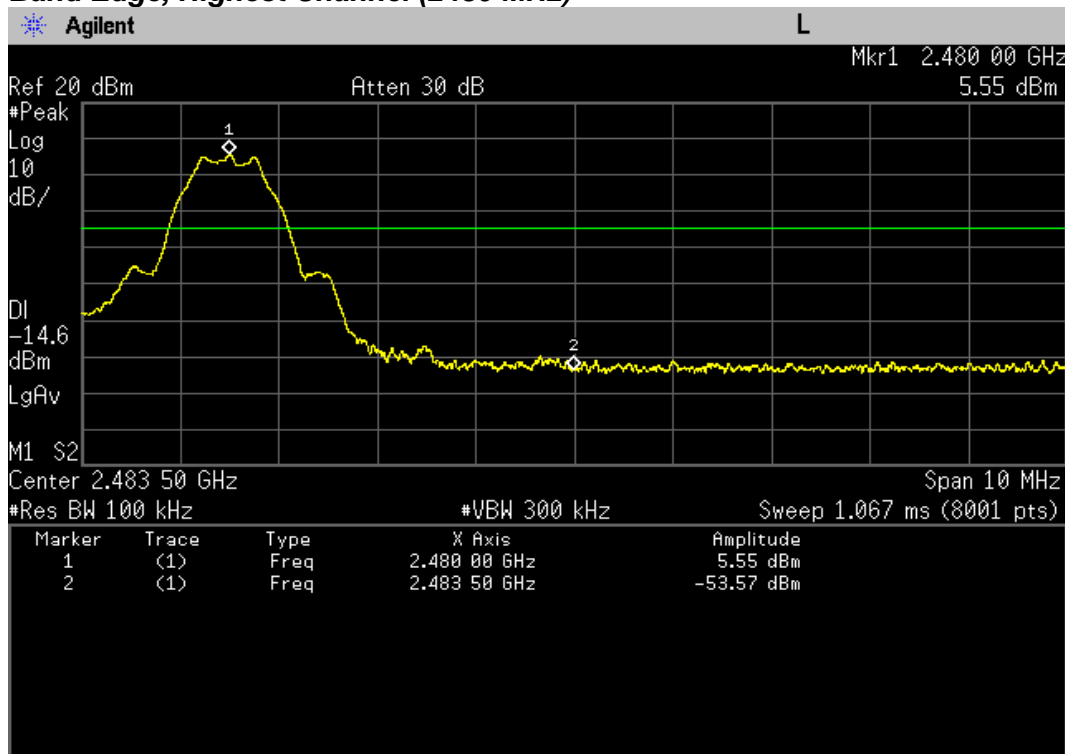

TEST DATA

8.6 Radiated Spurious Emissions

FCC §15.247(d), IC RSS-247 Issue 2 5.5

Test Mode : Set to Lowest channel, Middle channel and Highest channel

Result

Lowest Channel

Frequency (MHz)	Reading (dB μ V)	Pol* (H/V)	mode	AF +CL+Amp (dB)**	Result (dB μ V/m)	Limit (dB μ V/m)	Margin (dB)
7205.99***	40.3	V	peak	8.4	48.7	54.0	5.3

Middle Channel

Frequency (MHz)	Reading (dB μ V)	Pol* (H/V)	mode	AF +CL+Amp (dB)**	Result (dB μ V/m)	Limit (dB μ V/m)	Margin (dB)
7326.83	45.8	H	peak	8.4	54.2	74.0	19.8
7325.90	35.0	V	average	8.4	47.6	54.0	6.5

Highest Channel

Frequency (MHz)	Reading (dB μ V)	Pol* (H/V)	mode	AF +CL+Amp (dB)**	Result (dB μ V/m)	Limit (dB μ V/m)	Margin (dB)
7439.67	45.3	V	peak	8.5	53.8	74.0	20.2
7439.79	38.6	V	average	8.5	47.1	54.0	6.9

Note:

1. *Pol. H = Horizontal V = Vertical
2. **AF + CL + Amp. = Antenna Factor + Cable Loss + Amplifier.
3. ***This result was measured with RBW 100kHz and peak detection because it is in non-restricted frequency band.
4. Other spurious was under 20 dB below Fundamental.
5. GFSK modulation on the middle channel (2442MHz) was the worst condition.
6. The radiated emissions testing were made by rotating EUT through three orthogonal axes and rotating the receive antenna with horizontal, Vertical polarization. The worst data was recorded.
7. Peak emissions were measured using RBW = 1 MHz, VBW = 3 MHz, Detector = Peak.
8. Average emissions were measured using RBW = 1 MHz, VBW = 3kHz, Detector = Peak
9. The spectrum was measured from 9 kHz to 10th harmonic and the worst-case emissions were reported. No significant emissions were found beyond the 3rd harmonic for this device.

PLOTS OF EMISSIONS

Worst Case : 2442 MHz GFSK modulation : 1 GHz to 8 GHz

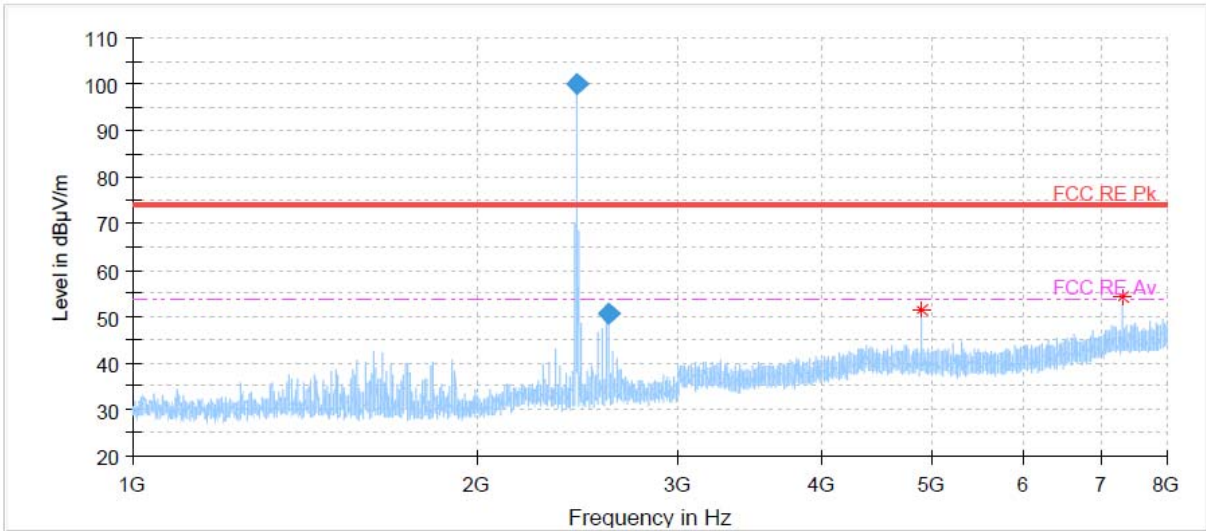

Worst Case : 2442 MHz GFSK modulation : 8 GHz to 18 GHz

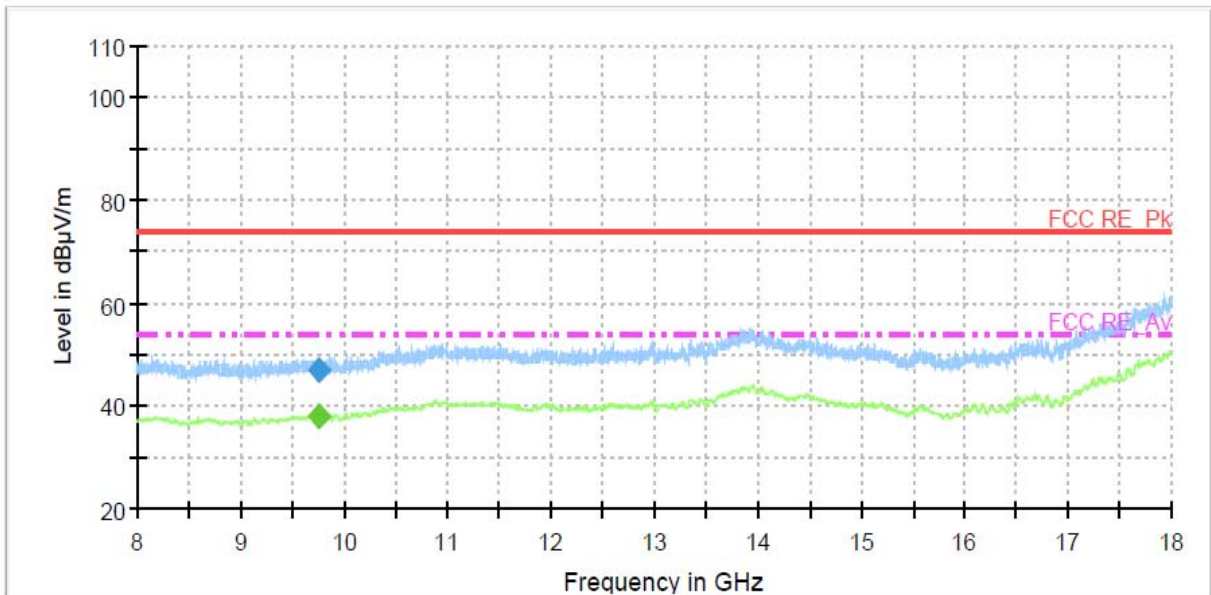

PLOTS OF EMISSIONS

Worst Case : 2442 MHz GFSK modulation : 18 GHz to 26.5 GHz

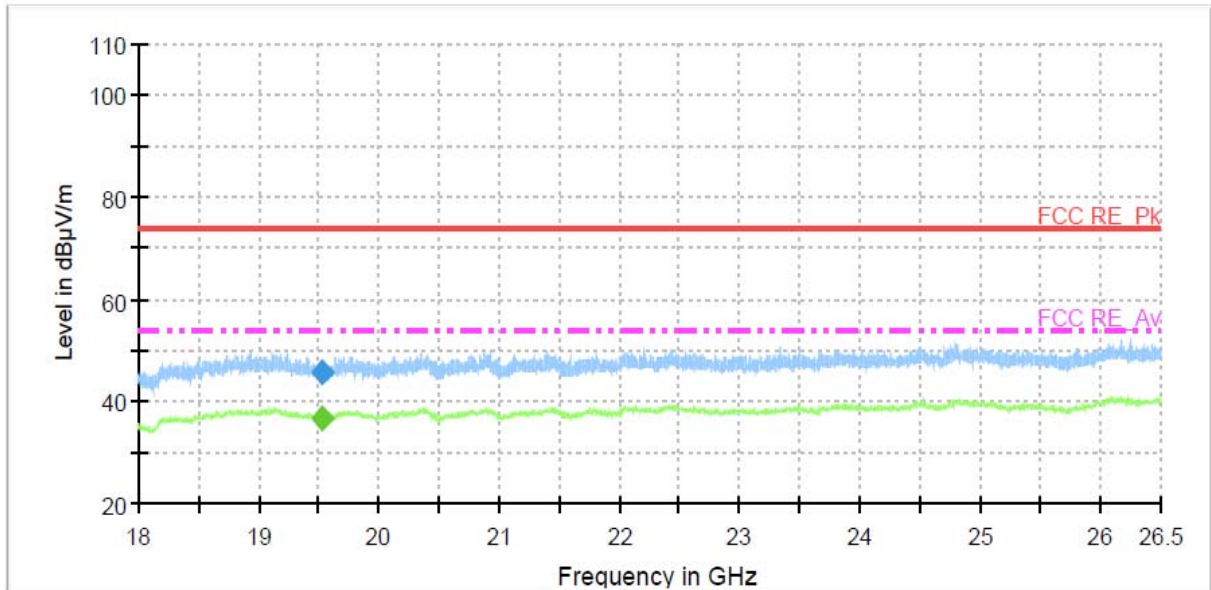

TEST DATA

8.7 Radiated Band Edge

FCC §15.247(d), IC RSS-247 Issue 2, 5.5

Test Mode : Set to Lowest channel, Middle channel and Highest channel

Result

Lowest and Highest Channels

Frequency (MHz)	Reading (dB μ V)	Pol* (H/V)	mode	AF+CL+Amp (dB)**	Result (dB μ V/m)	Limit (dB μ V/m)	Margin (dB)
2390.00***	48.9	V	peak	-8.5	40.4	74.0	33.6
2483.50***	52.5	V	peak	-8.6	43.9	74.0	30.1

Note:

1. *Pol. H = Horizontal V = Vertical
2. **AF + CL + Amp. = Antenna Factor + Cable Loss + Amplifier.
3. ***Average measurement was not performed because peak-detected emission complies with the average limit.
4. Other spurious was under 20 dB below Fundamental.
5. The radiated emissions testing were made by rotating EUT through three orthogonal axes and rotating the receive antenna with horizontal, Vertical polarization. The worst data was recorded.
6. Peak emissions were measured using RBW = 1 MHz, VBW = 3 MHz, Detector = Peak.

PLOT OF TEST DATA

Restricted Band Spurious Emissions, Lowest channel (Peak)

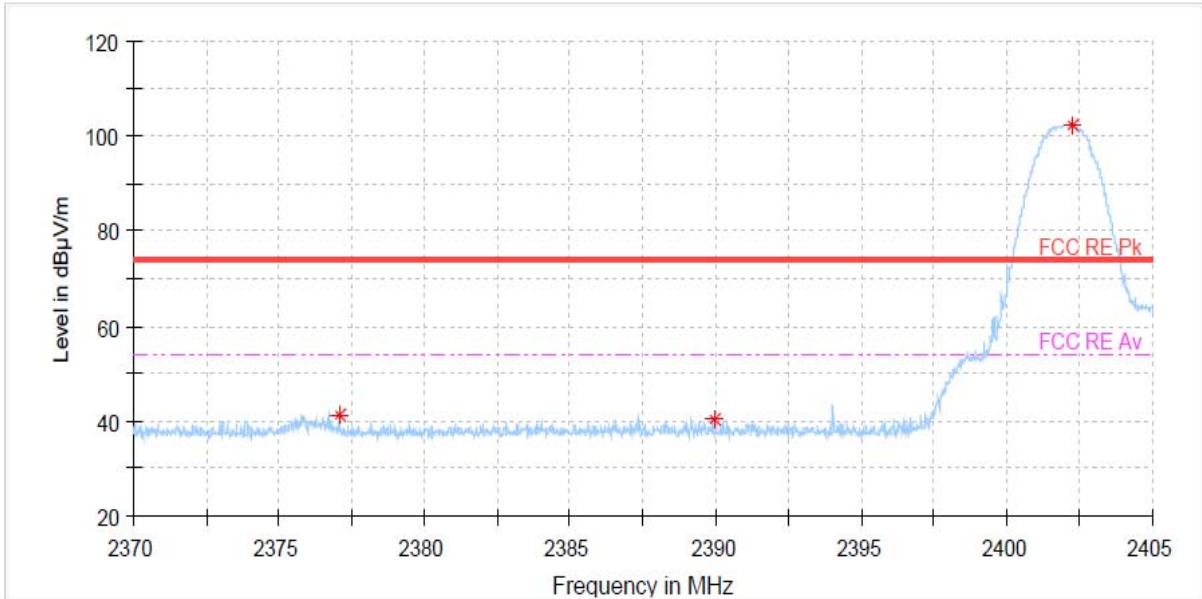

Restricted Band Spurious Emissions, Highest channel (Peak)

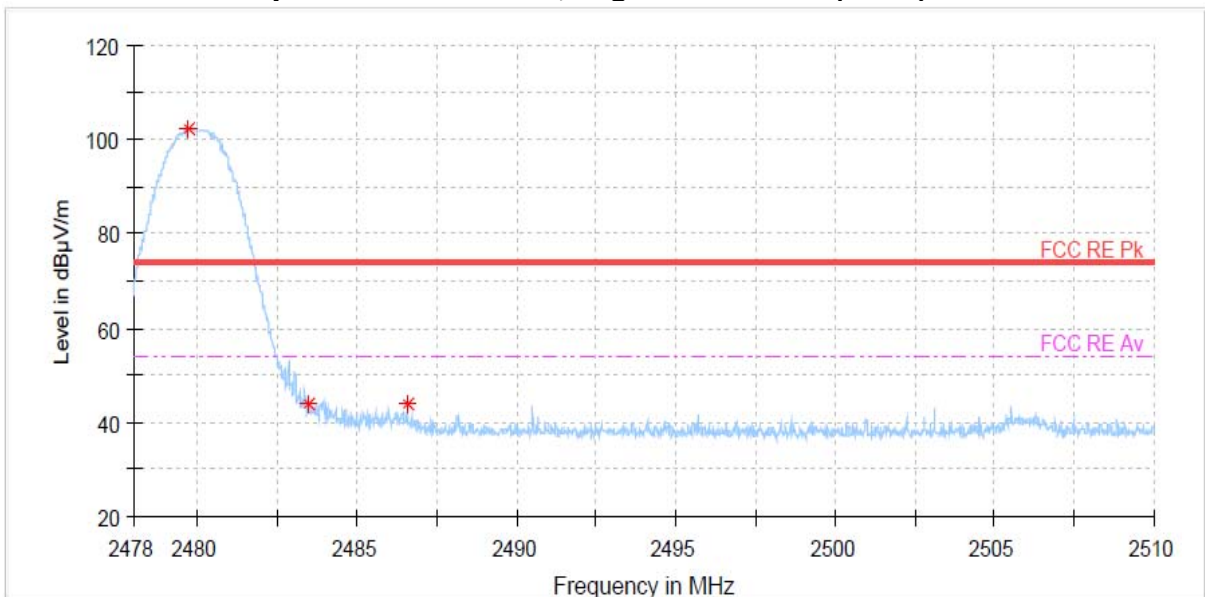

9. TEST EQUIPMENT

No.	Instrument	Manufacturer	Model	Serial No.	Calibration Date	Calibration Interval
1	*Test Receiver	R & S	ESU 40	100202	Apr. 04 2017	1 year
2	Test Receiver	R & S	ESCI	101041	Apr. 03 2017	1 year
3	*Attenuator	PASTERNAK	PE7395-10	1441-1	Jul. 13 2017	1 year
4	*Attenuator	FAIRVIEW	SA3N5W-06	N/A	Jan. 09 2017	1 year
5	*Attenuator	FAIRVIEW	SA3N5W-10	N/A	Apr. 03 2017	1 year
6	Attenuator	WEINSCHL	56-10	58765	Oct. 09 2016	1 year
7	*Amplifier	R & S	SCU 01	10029	Apr. 03 2017	1 year
8	*Amplifier	R & S	SCU18F	180025	Apr. 03 2017	1 year
9	*Amplifier	R & S	SCU26D	1984522	Apr. 11 2017	1 year
10	Amplifier	R & S	SCU40	100380	Jul. 13 2017	1 year
11	Pre Amplifier	HP	8449B	3008A00107	Jan. 10 2017	1 year
12	Spectrum Analyzer	R & S	FSW43	100732	Apr. 11 2017	1 year
13	*Spectrum Analyzer	Agilent	E4440A	MY44022567	Oct. 09 2016	1 year
14	*Spectrum Analyzer	R & S	FSW43	104084	Apr. 04 2017	1 year
15	*Loop Antenna	R & S	HFH2-Z2	100279	Feb. 22 2016	2 year
16	*Horn Antenna	SCHWARZBECK	BBHA9120D	01615	May. 18 2017	2 year
17	*Horn Antenna	Q-par Angus	QSH20S20	8179	Aug. 01 2017	2 year
18	Horn Antenna	Q-par Angus	QSH22K20	8180	Aug. 02 2017	2 year
19	*Trilog-Broadband Antenna	SCHWARZBECK	VULB 9163	9163-454	Feb. 11 2016	2 year
20	Two-Line V-Network	R & S	ENV216	101156	Apr. 04 2017	1 year
21	*Position Controller	INNCO	CO2000	12480406/L	N/A	N/A
22	*Controller	INNCO	CO3000	CO3000/937/38330516/L	N/A	N/A
23	*Turn Table	INNCO	DS1200S	N/A	N/A	N/A
24	*Turn Table	INNCO	DT2000-2t	N/A	N/A	N/A
25	*Antenna Mast	INNCO	MA4000	N/A	N/A	N/A
26	*TILT Antenna Mast	INNCO	MA4640-XP-EP	N/A	N/A	N/A
27	*Open Switch And Control Unit	R & S	OSP-120	100081	N/A	N/A
28	*Open Switch And Control Unit	R & S	OSP-120	100015	N/A	N/A
29	*Shielded Room	Seo-Young EMC	N/A	N/A	N/A	N/A
30	*Anechoic Chamber	Seo-Young EMC	N/A	N/A	N/A	N/A
31	*WiFi Filter Bank	R & S	U083	N/A	N/A	N/A
32	*WiFi Filter Bank	R & S	U082	N/A	N/A	N/A

*) Test equipment used during the test

10. ACCURACY OF MEASUREMENT

The Measurement Uncertainties stated were calculated in accordance with the requirements of measurement uncertainty contained in CISPR 16-4-2 with the confidence level of 95%

1. Conducted Uncertainty Calculation

Source of Uncertainty	X_i	Uncertainty of X_i		Coverage factor k	$u(X_i)$ (dB)	C_i	$C_i u(X_i)$ (dB)
		Value (dB)	Probability Distribution				
Receiver reading	RI	± 0.1	normal 1	1.000	0.1	1	0.1
Attenuation AMN-Receiver	LC	± 0.08	normal 2	2.000	0.04	1	0.04
AMN Voltage division factor	LAMN	± 0.8	normal 2	2.000	0.4	1	0.4
Sine wave voltage	dVSW	± 2.00	normal 2	2.000	1.00	1	1.00
Pulse amplitude response	dVPA	± 1.50	rectangular	1.732	0.87	1	0.87
Pulse repetition rate response	dVPR	± 1.50	rectangular	1.732	0.87	1	0.87
Noise floor proximity	dVNF	± 0.00	-	-	0.00	1	0.00
AMN Impedance	dZ	± 1.80	triangular	2.449	0.73	1	0.73
Ⓐ Mismatch	M	+ 0.70	U-Shaped	1.414	0.49	1	0.49
Ⓑ Mismatch	M	- 0.80	U-Shaped	1.414	- 0.56	1	- 0.56
Measurement System Repeatability	RS	0.05	normal 1	1.000	0.05	1	0.05
Remark	Ⓐ: AMN-Receiver Mismatch : + Ⓑ: AMN-Receiver Mismatch : -						
Combined Standard Uncertainty	Normal			± 1.88			
Expended Uncertainty U	Normal ($k = 2$)			± 3.76			

2. Radiation Uncertainty Calculation

Source of Uncertainty	X_i	Uncertainty of X_i		Coverage factor k	$u(X_i)$ (dB)	C_i	$C_i u(X_i)$ (dB)
		Value (dB)	Probability Distribution				
Measurement System Repeatability	RI	0.34	normal 1	1.00	0.34	1	0.34
Receiver reading	dVsw	± 0.02	normal 2	2.00	0.01	1	0.01
Sine wave voltage	dVpa	± 0.17	normal 2	2.00	0.09	1	0.09
Pulse amplitude response	dVpr	± 0.92	normal 2	2.00	0.46	1	0.46
Pulse repetition rate response	dVnf	± 0.35	normal 2	2.00	0.18	1	0.18
Noise floor proximity	AF	± 0.50	normal 2	2.00	0.25	1	0.25
Antenna Factor Calibration	CL	± 2.00	rectangular	$\sqrt{3}$	1.15	1	1.15
Cable Loss	AD	± 1.00	normal 2	2.00	0.50	1	0.50
Antenna Directivity	AH	± 0.00	rectangular	$\sqrt{3}$	0.00	1	0.00
Antenna Factor Height Dependence	AP	± 2.00	rectangular	$\sqrt{3}$	1.15	1	1.15
Antenna Phase Centre Variation	AI	± 0.20	rectangular	$\sqrt{3}$	0.12	1	0.12
Antenna Factor Frequency Interpolation	SI	± 0.25	rectangular	$\sqrt{3}$	0.14	1	0.14
Site Imperfections	DV	± 4.00	triangular	$\sqrt{6}$	1.63	1	1.63
Measurement Distance Variation	Dbal	± 0.60	rectangular	$\sqrt{3}$	0.35	1	0.35
Antenna Balance	DCross	± 0.90	rectangular	$\sqrt{3}$	0.52	1	0.52
Cross Polarisation	M	± 0.00	rectangular	$\sqrt{3}$	0.00	1	0.18
Mismatch	M	+ 0.98 - 1.11	U-Shaped	$\sqrt{2}$	0.74	1	0.74
EUT Volume Diameter	M	0.33	normal 1	1.00	0.33	1	0.11
Remark							
Combined Standard Uncertainty	Normal						
Expanded Uncertainty U	Normal ($k = 2$)						

