

Nemko Korea Co., Ltd.

155 & 159, Osan-Ro, Mohyeon-Eup, Cheoin-Gu, Yongin-Si, Gyeonggi-Do 16885 KOREA, REPUBLIC OF

TEL:+82 31 330-1700 FAX:+82 31 322 2332

FCC and IC EVALUATION REPORT FOR CERTIFICATION

Applicant :

Anam Electronics Co., Ltd.
27, Digital-ro 27ga-gil, Guro-gu, Seoul,
08375, Republic of Korea.
Attn. : Byeong-Seob, Lee

Dates of Issue : March 14, 2019
Test Report No. : NK-19-R-008
Test Site : Nemko Korea Co., Ltd.

FCC ID
IC

MBBA118
11657A-A118

Brand Name

Linkplay

Contact Person

Anam Electronics Co., Ltd.
27, Digital-ro 27ga-gil, Guro-gu, Seoul, 08375,
Republic of Korea.
Byeong-Seob, Lee
Telephone No. : +82-2-6424-4881

Applied Standard: FCC 47 CFR Part 15.247 and IC RSS-247 Issue 2
Classification: Digital Transmission System (DTS)
EUT Type: Linkplay Wireless Smart Audio Module

The device bearing the brand name and model specified above has been shown to comply with the applicable technical standards as indicated in the measurement report and was tested in accordance with the measurement procedures specified in ANSI C63.10-2013. The client should not use it to claim product endorsement by TAF or any government agencies. The test results in the report only apply to the tested sample.

I attest to the accuracy of data and all measurements reported herein were performed by me or were made under my supervision and are correct to the best of my knowledge and belief. I assume full responsibility for the completeness of these measurements and vouch for the qualifications of all persons taking them.

 Mar 14, 2019

Tested By : Yonghwan Kim
Engineer

 Mar. 14, 2019

Reviewed By : Seungyong Shin
Technical Manager

TABLE OF CONTENTS

1. Scope	4
2. Introduction (Site Description)	5
2.1 Test facility	5
2.2 Accreditation and listing	6
3. Test Conditions & EUT Information	7
3.1 Operation During Test	7
3.1.1 Table of test power setting	7
3.1.2 Table of test channels	7
3.1.3 Antenna information	7
3.1.4 Additional Information Related to Testing	8
3.1.5 Table of test modes	8
3.2 Support Equipment	9
3.3 Setup Drawing	9
3.4 EUT Information	10
4. Summary of Test Results	11
5. Recommendation / Conclusion	12
6. Antenna Requirements	12
7. Description of Test	13
7.1 Conducted Emissions	13
7.2 Radiated Emissions	14
7.3 6 dB Bandwidth	15
7.4 Peak Output Power and E.I.R.P	16
7.5 Peak Power Spectral Density	17
7.6 Conducted Spurious Emissions	18

8. Test Data	19
8.1 Conducted Emissions	19
8.2 Radiated Emissions	21
8.3 6 dB Bandwidth	23
8.4 Peak Output Power and E.I.R.P.	26
8.5 Peak Power Spectral Density	29
8.6 Conducted Spurious Emissions	32
8.7 Radiated Spurious Emissions	37
8.8 Radiated Band Edge	40
9. Test Equipment	42
10. Accuracy of Measurement	43

1. SCOPE

Measurement and determination of electromagnetic emissions (EME) of radio frequency devices including intentional and/or unintentional radiators for compliance with the technical rules and regulations of the Federal Communications Commission under FCC part 15 and IC RSS-247 Issue2.

Responsible Party :	Anam Electronics Co., Ltd. 27, Digital-ro 27ga-gil, Guro-gu, Seoul, 08375, Republic of Korea
Contact Person :	Byeong Seob, Lee
Manufacturer :	Linkplay Technology, Inc. 5225 Canyon Crest Dr. Riverside, CA 92507, USA

- FCC ID: MBBA118
- IC: 11657A-A118
- Model: A118
- HVIN: A118
- Brand Name: Linkplay
- EUT Type: Linkplay Wireless Smart Audio Module
- Classification: Digital Transmission System (DTS)
- Applied Standard: FCC 47 CFR Part 15.247 and IC RSS-247 Issue 2
- Test Procedure(s): ANSI C63.10-2013
KDB 558074 D01 15.247 Meas Guidance v05
- Dates of Test: January 28, 2019 ~ February 19, 2019
- Place of Test: Nemko Korea Co., Ltd.

2. INTRODUCTION

2.1 Test facility

The measurement procedure described in American National Standard for Methods of Measurement of Radio-Noise Emissions from Low-Voltage Electrical and Electronic Equipment in the Range of 9 kHz to 40 GHz (ANSI C63.4-2014), the American National Standard for Testing Unlicensed Wireless Devices (ANSI C63.10-2013) was used in determining radiated and conducted emissions emanating from **Anam Electronics Co., Ltd. FCC ID : MBBA118** and **IC : 11657A-A118**.

These measurement tests were conducted at **Nemko Korea Co., Ltd. EMC Laboratory**.

The site address 155 & 159, Osan-Ro, Mohyeon-Eup, Cheoin-Gu, Yongin-Si, Gyeonggi-Do 16885 KOREA, REPUBLIC OF.

The area of Nemko Korea Corporation Ltd. EMC Test Site is located in a mountain area at 80 km (48 miles) southeast and Incheon International Airport (Incheon Airport), 30 km (18miles) south-southeast from central Seoul.

It is located in the valley surrounded by mountains in all directions where ambient radio signal conditions are quiet and a favorable area to measure the radio frequency interference on open field test site for the computing and ISM devices manufactures.

The detailed description of the measurement facility was found to be in compliance with the requirements of ANSI C63.4-2014 according to §2.948.









Nemko Korea Co., Ltd.
EMC Lab.
155 & 159, Osan-Ro, Mohyeon-Eup,
Cheoin-Gu, Yongin-Si, Gyeonggi-Do
16885 KOREA, REPUBLIC OF
Tel)+82-31-330-1700
Fax)+82-31-322-2332

Fig. 1. The map above shows the Seoul in Korea vicinity area.

The map also shows Nemko Korea Corporation Ltd. EMC Lab. and Incheon Airport.

2.2 Accreditation and listing

Accreditation type		Accreditation number
	CAB Accreditation for DOC	Designation No. KR0026
	KOLAS Accredited Lab. (Korea Laboratory Accreditation Scheme)	Registration No. 155
	Canada IC Registered site	Site No. 2040E
	VCCI registration site(RE/CE/Telecom CE)	Member No. 2118
	EMC CBTL	-
	KCC(RRL)Designated Lab.	Registration No. KR0026

3. TEST CONDITIONS & EUT INFORMATION

3.1 Operation During Test

The EUT is the transceiver which is Bluetooth 4.2 module supporting BDR/EDR/LE mode.

The Laptop was used to control the EUT to transmit the wanted TX channel continuously (duty cycle < 98%) by the testing program (ADB) supported by manufacturer.

The operating voltage of EUT was 3.4 Vdc supplied from jig board connected to USB port on Laptop PC.

The EUT was tested at the lowest, middle and the highest channels with the maximum output power in accordance with the manufacturer's specifications. The worst data were recorded in the report.

3.1.1 Table of test power setting

Frequency	Mode	Power setting Level
2402 MHz ~ 2480 MHz	LE	Default

3.1.2 Table of test channels

Frequency band	Mode	Test Channel (CH)	Frequency (MHz)
2.4 GHz	LE	37	2402
		18	2442
		39	2480

3.1.3 Antenna information

Frequency band	Mode	Antenna TX mode	Support CDD	Support MIMO
2.4 GHz	LE	<input checked="" type="checkbox"/> 1TX, <input type="checkbox"/> 2TX	<input type="checkbox"/> Yes, <input checked="" type="checkbox"/> No	<input type="checkbox"/> Yes, <input checked="" type="checkbox"/> No

3.1.4 Additional Information Related to Testing

The cable and attenuator loss from 30MHz to 26.5GHz was reflected in spectrum analyzer with correction factor for all conducted testing.

3.1.5 Table of test modes

Test Items	Mode	Modulation	Test Channel (CH)
Conducted Emissions	LE	GFSK	39
Radiated Emissions	LE	GFSK	39
6 dB Bandwidth	LE	GFSK	37/18/39
Maximum Conducted Output Power	LE	GFSK	37/18/39
Power Spectral Density	LE	GFSK	37/18/39
Conducted Spurious Emission, Radiated Spurious Emission, Band edge Emission	LE	GFSK	37/18/39

3.2 Support Equipment

EUT	Anam Electronics Co., Ltd. Model : A118	S/N: N/A
Laptop Computer	HP Model : G62-355TU	FCC DOC S/N : CNF0489WDT
AC/DC Adapter	HP Model : PPP009D 1.5 m unshielded power cable	FCC DOC S/N : WBGSV0ACXZH162

3.3 Setup Drawing

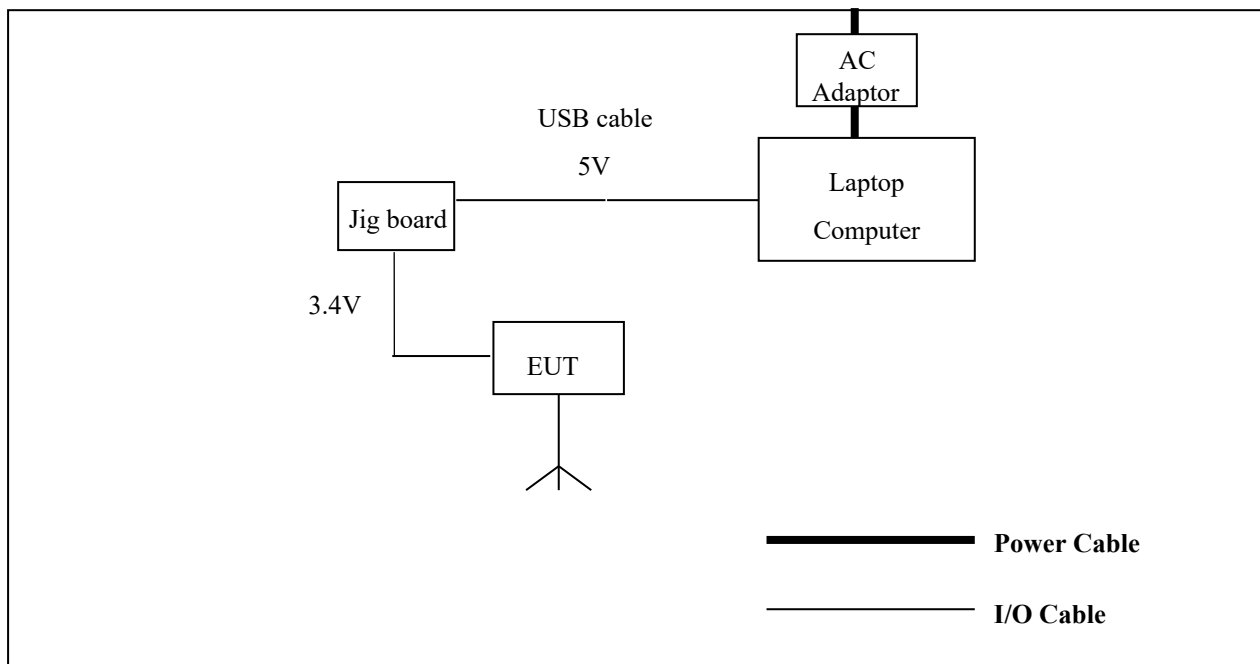

3.4 EUT Information

The EUT is the **Anam Electronics Co., Ltd. Linkplay Wireless Smart Audio Module FCC ID: MBBA118, IC: 11657A-A118.**

Specifications:

EUT Type	Linkplay Wireless Smart Audio Module
Model Name	A118
Brand Name	Linkplay
Frequency of Operation	2402 MHz ~ 2480 MHz
Peak Output Power(Conducted)	-0.91 dBm
FCC Classification	Digital Transmission System (DTS)
Number of Channels	40 CH
Modulations	GFSK(BLE)
Antenna Gain (peak)	5.6 dBi
Antenna Setup	1TX / 1RX
Voltage	3.4 Vdc
Temperature Range	-20 °C ~ +55 °C
Size (W x H x D)	About 42 mm x 10 mm x 54 mm
Weight	About 18 g
HVIN (Hardware Version Number)	A118
FVIN (Firmware Version Identification Number)	V3.6.6720
Remarks	-

4. SUMMARY OF TEST RESULTS

The EUT has been tested according to the following specification:

Name of Test	FCC Paragraph No.	IC Paragraph No.	Result	Remark
Conducted Emission	15.207	RSS-GEN Issue 4 8.8	Complies	
Radiated Emission	15.209	RSS-GEN Issue 4 8.9	Complies	
6 dB Bandwidth	15.247(a)(2)	RSS-247 Issue 2 5.2	Complies	
Maximum Conducted Output Power	15.247(b)(3)	RSS-247 Issue 2 5.4	Complies	
Power Spectral Density	15.247(e)	RSS-247 Issue 2 5.2	Complies	
Conducted Spurious Emission	15.247(d)	RSS-247 Issue 2 5.5	Complies	
Radiated Spurious Emission	15.247(d)	RSS-247 Issue 2 5.5	Complies	
Maximum Permissible Exposure	1.1307(b)	RSS-102 Issue 5	Complies	

5. RECOMMENDATION/CONCLUSION

The data collected shows that the **Anam Electronics Co., Ltd. Linkplay Wireless Smart Audio Module FCC ID: MBBA118, IC: 11657A-A118** is in compliance with Part 15.247 of the FCC Rule and RSS-247 Issue 2 of the IC Specification.

6. ANTENNA REQUIREMENTS

§15.203 of the FCC Rules part 15 Subpart C

: An intentional radiator shall be designed to ensure that no antenna other than that furnished by the responsible party shall be used with the device. The use of a permanently attached antenna or of an antenna that uses a unique coupling to the intentional radiator shall be considered sufficient to comply with the provisions of this section.

The antenna of the **Anam Electronics Co., Ltd. Linkplay Wireless Smart Audio Module FCC ID: MBBA118, IC: 11657A-A118** is **permanently attached** and there are no provisions for connection to an external antenna. It complies with the requirement of §15.203.

Used Antenna	
Model name	Max. gain (dBi)
W619-1B235B-A	5.60
W619-1B110B-A2	4.87
W619-1B170B-A	5.60
W548-1G240B-A	5.42

7. DESCRIPTION OF TESTS

7.1 Conducted Emissions

The Line conducted emission test facility is located inside a 4 x 7 x 2.5 meter shielded enclosure. It is manufactured by EM engineering. The shielding effectiveness of the shielded room is in accordance with MIL-STD-285 or NSA 65-6. A 1 m x 1.5 m wooden table 0.8 m height is placed 0.4 m away from the vertical wall and 1.5 m away from the side of wall of the shielded room. Rohde & Schwarz (ESH3-Z5) and (ESH2-Z5) of the 50 ohm/50 μ H Line Impedance Stabilization Network (LISN) are bonded to the shielded room. The EUT is powered from the Rohde & Schwarz LISN (ESH3-Z5) and the support equipment is powered from the Rohde & Schwarz LISN (ESH2-Z5). Power to the LISNs are filtered by high-current high insertion loss Power line filters. The purpose of filter is to attenuate ambient signal interference and this filter is also bonded to shielded enclosure. All electrical cables are shielded by tinned copper zipper tubing with inner diameter of 1 / 2 ". If DC power device, power will be derived from the source power supply it normally will be powered from and this supply lines will be connected to the LISNs, All interconnecting cables more than 1 meter were shortened by non-inductive bundling (serpentine fashion) to a 1 meter length. Sufficient time for EUT, support equipment, and test equipment was allowed in order for them to warm up to their normal operating condition. The RF output of the LISN was connected to the spectrum analyzer to determine the frequency producing the maximum EME from the EUT. The spectrum was scanned from 150 kHz to 30 MHz with 200 msec sweep time. The frequency producing the maximum level was re-examined using the EMI test receiver. (Rohde & Schwarz ESCS30). The detector functions were set to CISPR quasi-peak mode & average mode. The bandwidth of receiver was set to 9 kHz. The EUT, support equipment, and interconnecting cables were arranged and manipulated to maximize each EME emission. Each emission was maximized by; switching power lines; varying the mode of operation or resolution; clock or data exchange speed; scrolling H pattern to the EUT and of support equipment, and powering the monitor from the floor mounted outlet box and computer aux AC outlet, if applicable; whichever determined the worst case emission. Each EME reported was calibrated using the R&S signal generator.

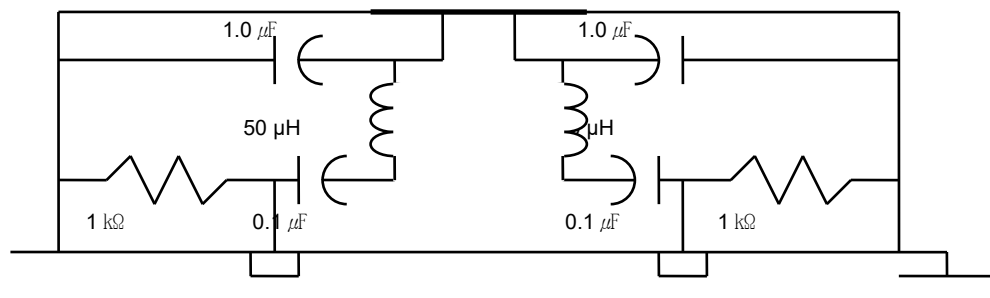

Fig. 2. LISN Schematic Diagram

7.2 Radiated Emissions

The measurement was performed at the test site that is specified in accordance with ANSI C63.10-2013.

The spurious emission was scanned from 9 kHz to 30 MHz using Loop Antenna(Rohde&Schwarz, HFH2-Z2) and 30 to 1000 MHz using Trilog broadband test antenna(Schwarzbeck, VULB 9163). Above 1 GHz, Horn antenna (Schwarzbeck BBHA 9120D: up to 18 GHz, Q-par Angus QSH20S20 : 18 to 26.5 GHz) was used.

For emissions testing at below 1GHz, The test equipment was placed on turntable with 0.8 m above ground. For emission measurements above 1 GHz, The test equipment was placed on turntable with 1.5 m above ground. Sufficient time for the EUT, support equipment, and test equipment was allowed in order for them to warm up to their normal operating condition. The EUT, cable, wire arrangement and mode of operation that has the highest amplitude relative to the limit was selected. Then, the turn table was rotated from 0° to 360° and an antenna mast was moved from 1 m to 4 m height to maximize the suspected highest amplitude signal. The final maximized level was recorded.

At frequencies below 1000 MHz, measurements performed using the CISPR quasi-peak detection. At frequencies above 1000 MHz, measurements performed using the peak and average measurement procedures described in ANSI 63.10-2013 section 11.12. Peak emission levels were measured by setting the analyzer RBW = 1 MHz, VBW = 3 MHz, Detector = Peak, Trace mode = max hold. Average emission levels were measured by setting the analyzer RBW = 1 MHz, VBW = 3kHz, Detector = Peak, Trace mode = max hold. Allow max hold to run for at least 50 times (1/duty cycle) traces.

Frequency (MHz)	Field strength (microvolts/meter)	Measurement distance (meters)
0.009–0.490	2400/F(kHz)	300
0.490–1.705	24000/F(kHz)	30
1.705–30.0	30	30
30–88	100	3
88–216	150	3
216–960	200	3
Above 960	500	3

Radiated Emissions Limits per 47 CFR 15.209(a) and RSS-GEN Issue 4 8.9

7.3 6 dB Bandwidth

Test Setup

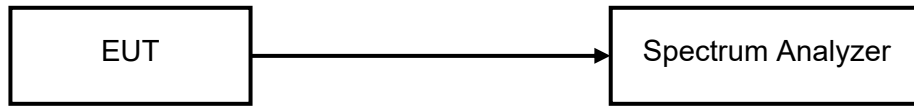

Test Procedure

EUTs 6 dB bandwidth is measured at low, middle, high channels with a spectrum analyzer connected to the antenna terminal while the EUTs operating at its maximum power control level. The spectrum analyzer setting is as follows.

RBW = 100 kHz

VBW > 3 x RBW

Detector = Peak

Trace mode = max hold

Sweep = auto couple

The bandwidth measurement function on the spectrum analyzer is used to measure the 6 dB bandwidth.

7.4 Peak Output Power and E.I.R.P

Test Setup

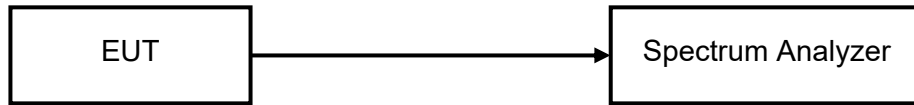

Test Procedure

EUTs Maximum Peak Conducted Output Power is measured at low, middle, high channels with a spectrum analyzer connected to the antenna terminal while the EUTs operating at its maximum power control level.

The spectrum analyzer setting is as follows.

RBW = 1 MHz

VBW = 3 MHz

Span = fully encompass the DTS bandwidth

Detector = peak

Sweep time = auto couple

Trace mode = max hold

Allow the trace to stabilize.

Use peak marker function to determine the peak amplitude level.

E.I.R.P is calculated according to KDB412172 D01 Determining ERP and EIRP v01r01

7.5 Peak Power Spectral Density

Test Setup

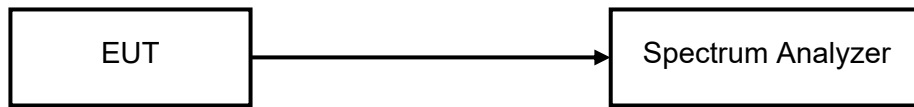

Test Procedure

EUTs Peak Power Spectral Density is measured at low, middle, high channels with a spectrum analyzer connected to the antenna terminal while the EUTs operating at its maximum power control level.

The spectrum analyzer setting is as follows.

Center frequency = DTS channel center frequency

Span = 1.5 times the DTS channel bandwidth

RBW \geq 3kHz

VBW \geq 3 x RBW

Detector = peak

Sweep time = auto couple

Trace mode = max hold

Allow the trace to stabilize.

The peak search function on the spectrum analyzer is used to determine the maximum amplitude level within the RBW.

7.6 Conducted Spurious Emissions

Test Setup

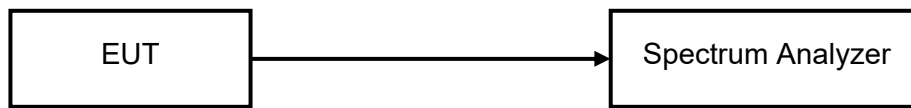

Test Procedure

EUTs Conducted spurious emissions are measured at low, middle, high channels with a spectrum analyzer connected to the antenna terminal while the EUTs operating at its maximum power control level. The spectrum analyzer setting is as follows.

1) Reference Level

Center frequency = DTS channel center frequency

Span $\geq 1.5 \times$ DTS bandwidth

RBW = 100 kHz

VBW $\geq 3 \times$ RBW

Detector = peak

Sweep time = auto couple

Trace mode = max hold

Allow trace to fully stabilize.

Use the peak marker function to determine the maximum PSD level.

Note that the channel found to contain the maximum PSD level can be used to establish the reference level.

2) Unwanted Emissions

Set the center frequency and span to encompass frequency range to be measured.

RBW = 100 kHz

VBW $\geq 3 \times$ RBW

Detector = peak

Sweep time = auto couple

Trace mode = max hold

Allow trace to fully stabilize.

Use the peak marker function to determine the maximum amplitude level.

8. TEST DATA

8.1 Conducted Emissions

FCC §15.207, RSS-GEN Issue 4 8.8

Result

Frequency (MHz)	Level (dB μ V)		*) Factor (dB)	**) Line	Limit (dB μ V)		Margin (dB)	
	Q-Peak	Average			Q-Peak	Average	Q-Peak	Average
0.15	55.0	44.4	10.50	N	65.8	55.8	10.8	11.4
0.16	55.9	45.2	10.50	N	65.4	55.4	9.5	10.2
0.23	46.6	38.5	10.50	L	62.3	52.3	15.7	13.8
0.31	37.0	30.4	10.50	L	60.0	50.0	23.0	19.6
0.39	29.9	17.9	10.50	N	58.1	48.1	28.2	30.2
11.39	36.2	29.0	11.00	L	60.0	50.0	23.8	21.0

Line Conducted Emissions Tabulated Data

Notes:

1. Measurements using CISPR quasi-peak mode & average mode.
2. All modes of operation were investigated and the worst -case emission are reported. See attached Plots.
3. *) Factor = LISN + Cable Loss
4. **) LINE : L = Line , N = Neutral
5. The limit is on the FCC §15.207(a) and IC RSS-GEN issue4 8.8.

PLOTS OF EMISSIONS

Conducted Emission at the Mains port (Line + Neutral)

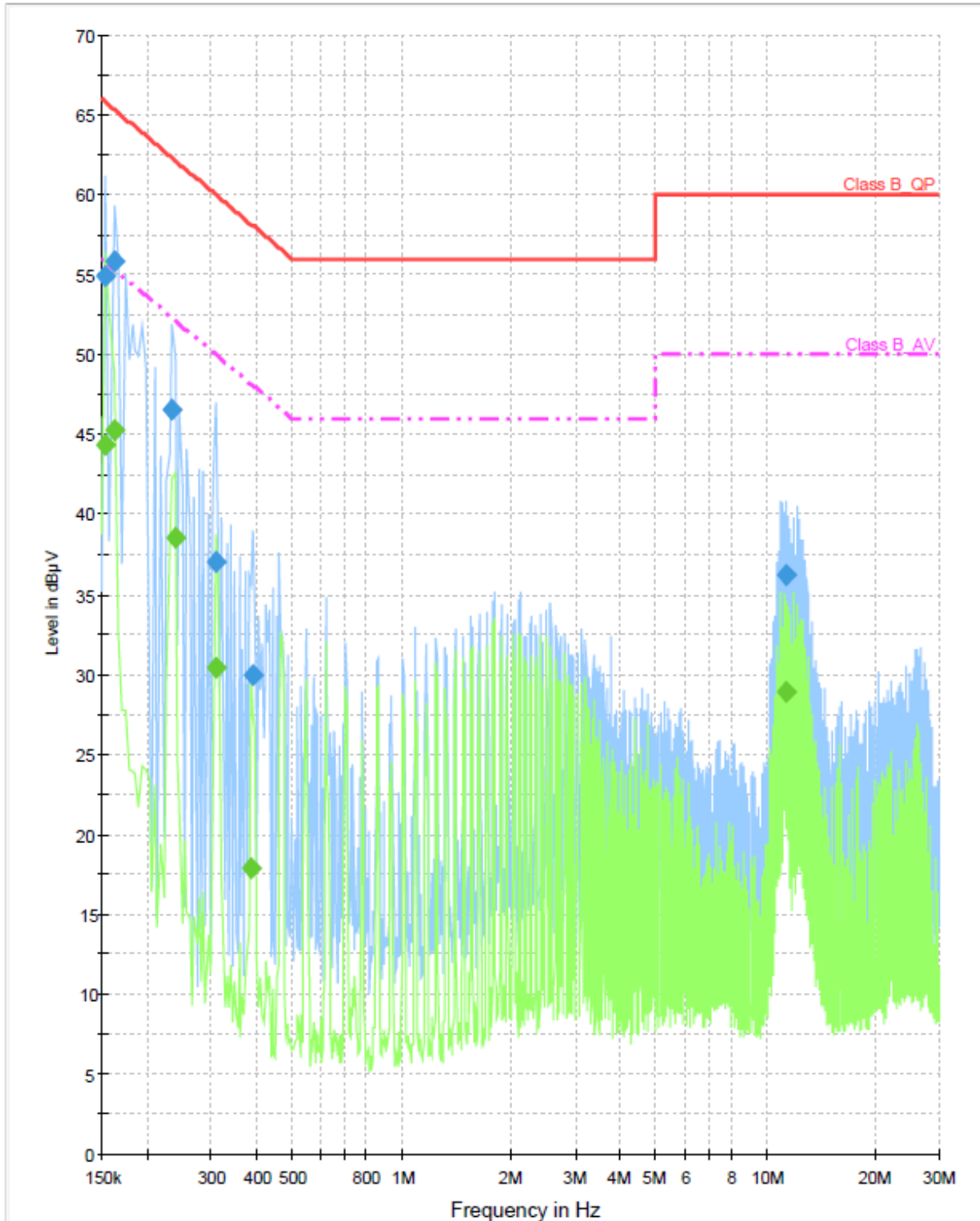

TEST DATA

8.2 Radiated Emissions

FCC §15.209, IC RSS-Gen Issue 4 8.9

Result

Frequency	Reading	Pol*	Antenna Heights	Turntable	AF+CL+Amp	Result	Limit	Margin
(MHz)	(dB μ V/m)	(H/V)	(cm)	Angles (°)	(dB)**	(dB μ V/m)	(dB μ V/m)	(dB)
119.99	64.37	H	270	251	-25.5	38.9	43.5	4.6
121.67	64.26	H	312	253	-25.8	38.5	43.5	5.0
122.10	67.10	H	296	252	-25.9	41.2	43.5	2.3
122.53	64.89	H	298	253	-26.0	38.9	43.5	4.6
146.24	58.98	H	330	32	-27.4	31.6	43.5	11.9
147.15	58.42	H	330	31	-27.3	31.1	43.5	12.4

Radiated Measurements at 3meters

Notes:

1. All modes were measured and the worst-case emission was reported.
2. *Pol. H = Horizontal, V = Vertical
3. **AF + CL + Amp. = Antenna Factor + Cable Loss + Amplifier.
4. Measurements using CISPR quasi-peak mode below 1 GHz.
5. The radiated emissions testing were made by rotating EUT through three orthogonal axes and rotating the receive antenna with horizontal, Vertical polarization. The worst data was recorded.
6. Highest channel (2480MHz) is the worst case.
7. No emission found between lowest internal used/generated frequency to 30MHz (9kHz~30MHz).
8. The limit is on the FCC §15.209 and RSS-Gen Issue4 8.9.

PLOTS OF EMISSIONS

Worst Case

Radiated emission below 1GHz_2480 MHz

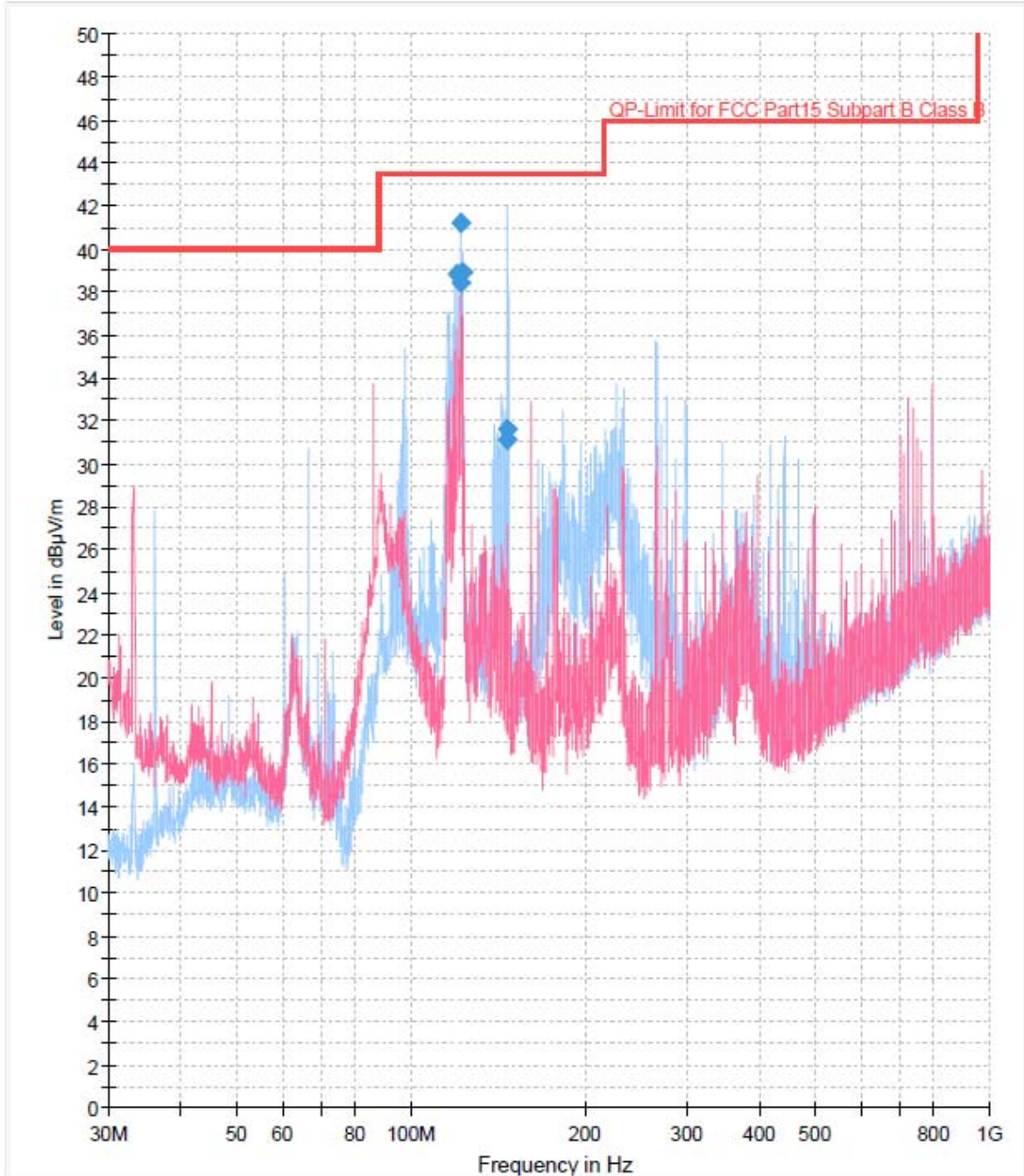

TEST DATA

8.3 6 dB Bandwidth

FCC §15.247(a)(2), IC RSS-247 Issue 2 5.2

Test Mode : Set to Lowest channel, Middle channel and Highest channel,

Result

Channel	Frequency (MHz)	6 dB modulated bandwidth (MHz)	Limit (MHz)	Margin (MHz)	99% emission bandwidth (MHz)
Lowest	2402	0.73	0.50	0.23	1.08
Middle	2442	0.73	0.50	0.23	1.08
Highest	2480	0.73	0.50	0.23	1.08

PLOTS OF EMISSIONS

6 dB Bandwidth, Lowest Channel (2402 MHz)

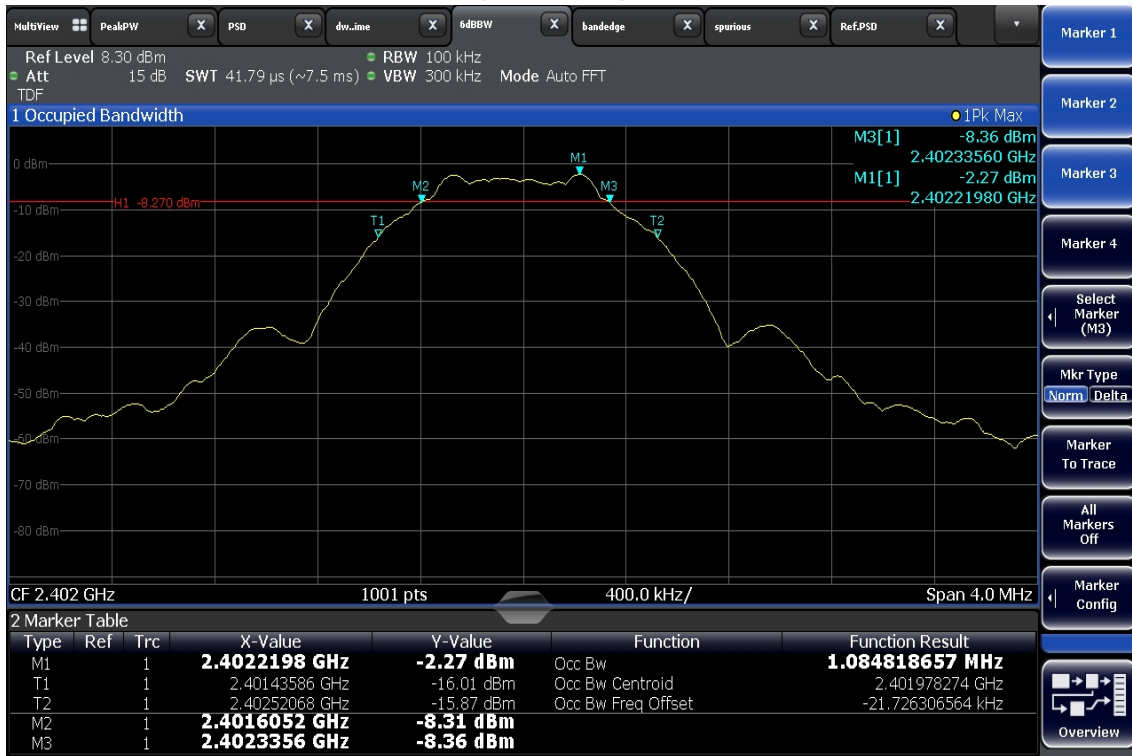

6 dB Bandwidth, Middle Channel (2442 MHz)

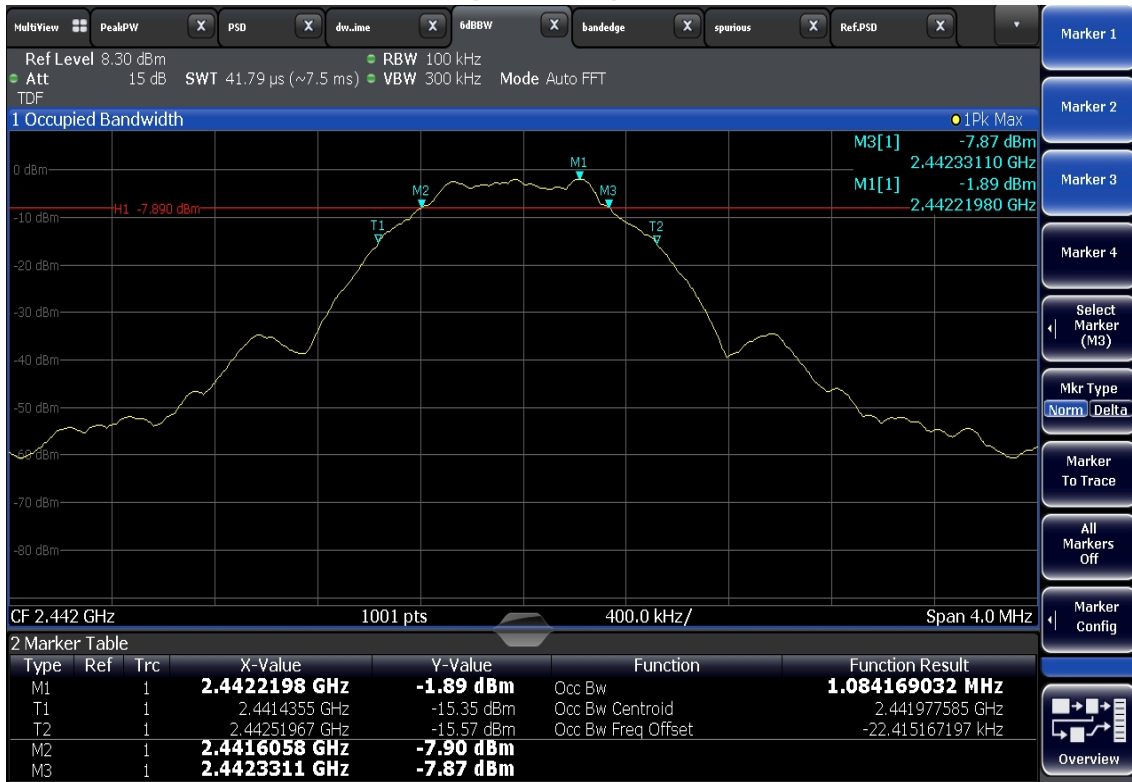

PLOTS OF EMISSIONS

6 dB Bandwidth, Highest Channel (2480 MHz)

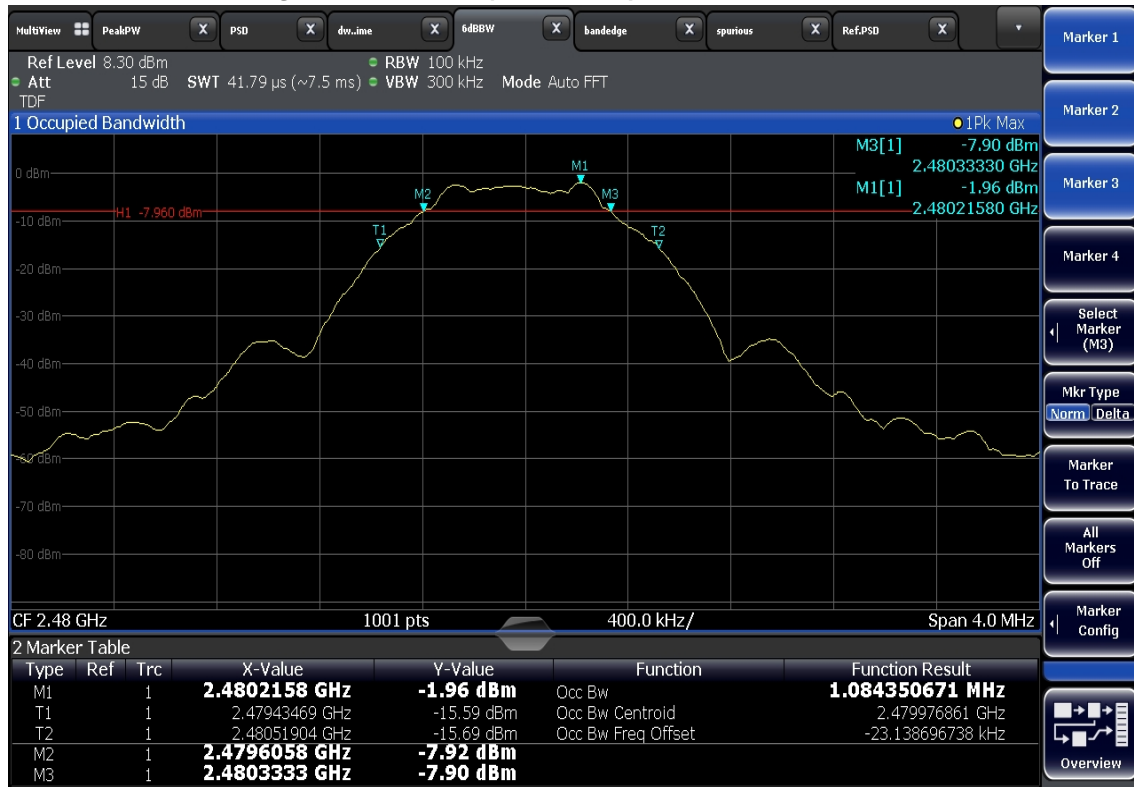

TEST DATA

8.4 Peak Output Power and E.I.R.P.

FCC §15.247(b)(3), IC RSS-247 Issue 2 5.4

Test Mode : Set to Lowest channel, Middle channel and Highest channel,

Result

Channel	Frequency (MHz)	Peak Output Power (dBm)	Limit (dBm)	E.I.R.P (dBm)	E.I.R.P Limit (dBm)
Lowest	2402	-1.27	30.00	4.33	36.00
Middle	2442	-0.91	30.00	4.69	36.00
Highest	2480	-0.94	30.00	4.66	36.00

Note:

1. E.I.R.P was calculated by following equation according to KDB412172 D01 Determining ERP and EIRP v01r01.

$$E.I.R.P = P_T + G_T - L_C$$

P_T = Peak output power (dBm)

G_T = Gain of the transmitting antenna in dBi, Directional antenna gain is **5.6 dBi**.

L_C = Signal attenuation in the connecting cable between the transmitter and antenna in dB. This factor of an integral antenna is negligible.

2. The following equation was used for spectrum offset:

$$\text{Spectrum offset (dB)} = \text{Attenuator (dB)} + \text{Cable Loss (dB)} + \text{SMA Type Connector Loss (dB)}$$

PLOTS OF EMISSIONS

Maximum Peak Output Power, Lowest Channel (2402 MHz)

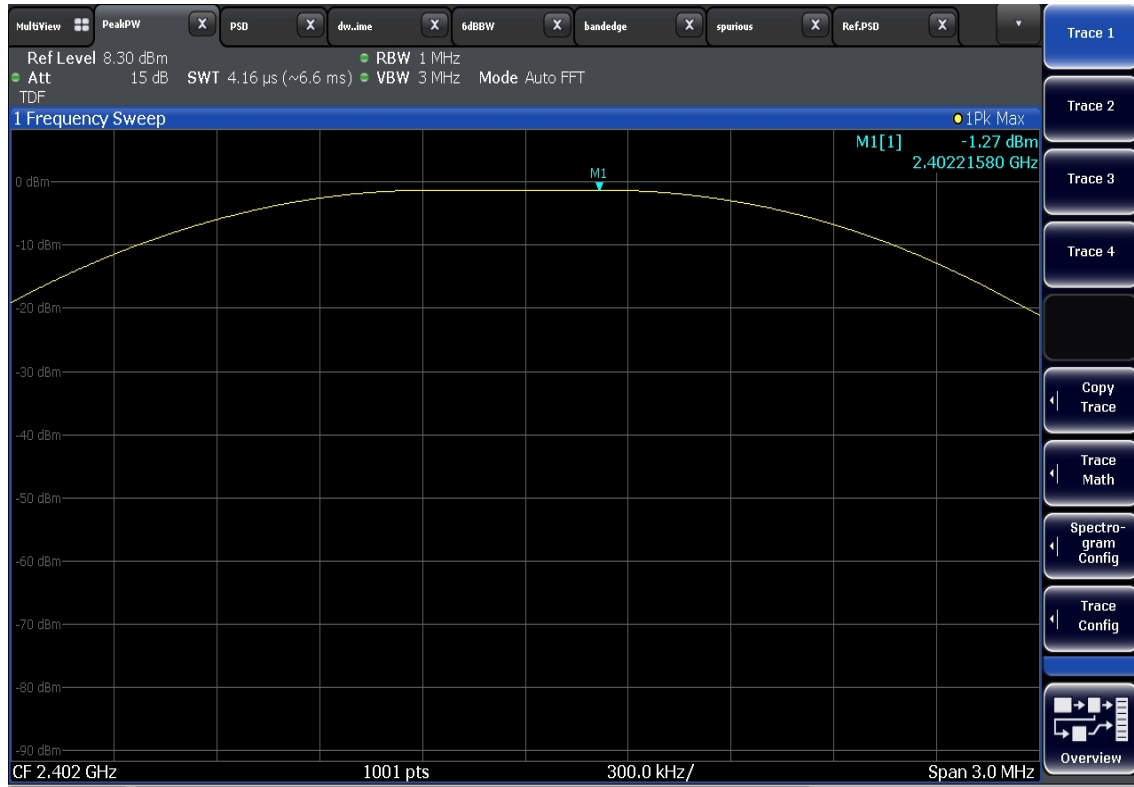

Maximum Peak Output Power, Middle Channel (2442 MHz)

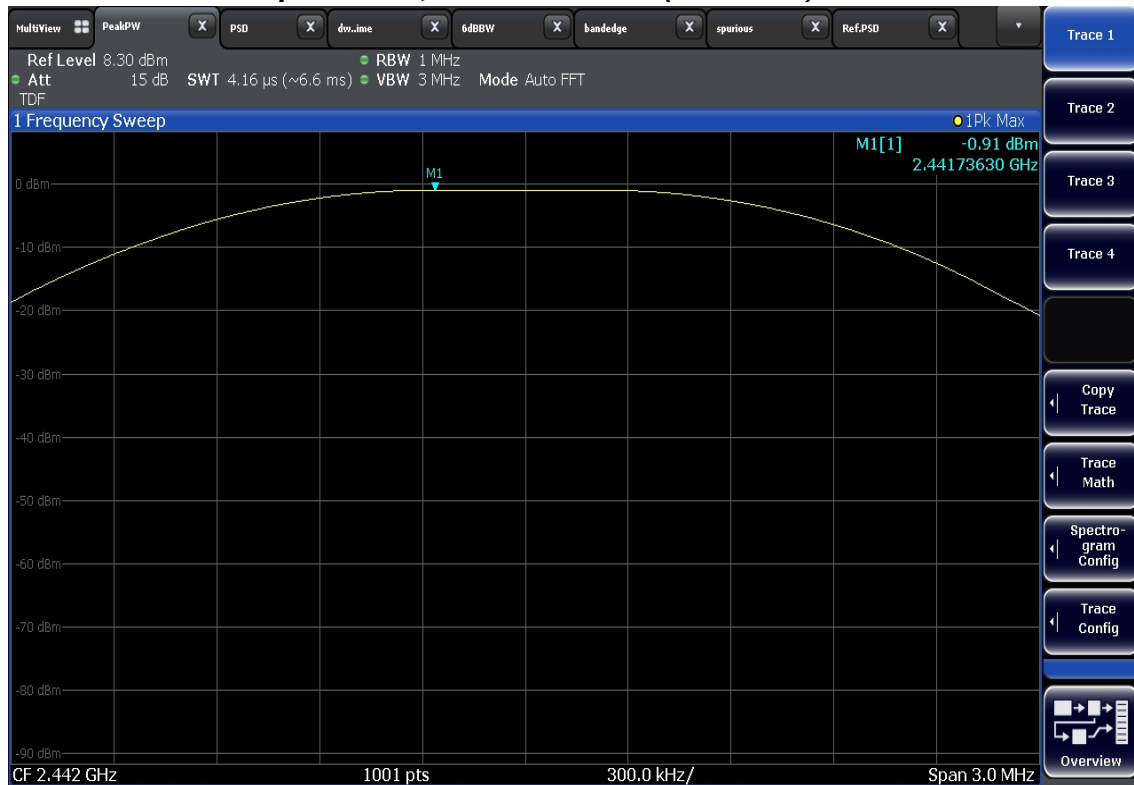

PLOTS OF EMISSIONS

Maximum Peak Output Power, Highest Channel (2480 MHz)

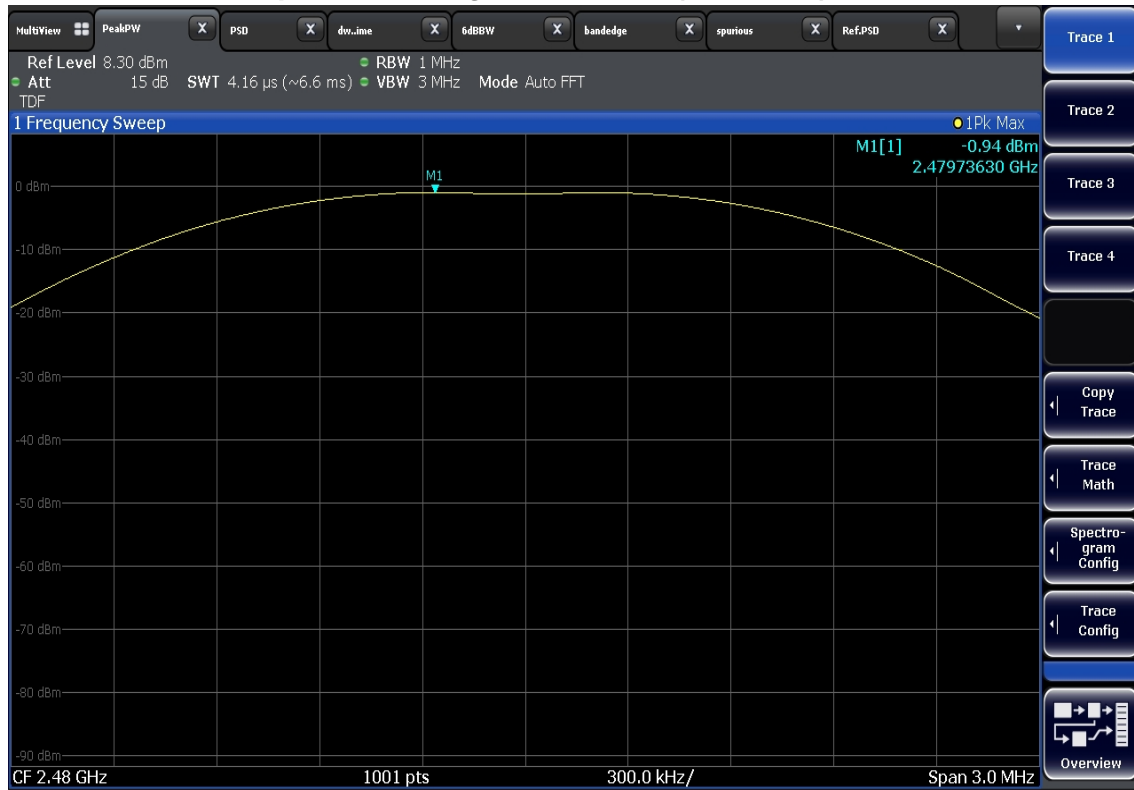

TEST DATA

8.5 Peak Power Spectral Density

FCC §15.247(e), IC RSS-247 Issue 2 5.2

Test Mode : Set to Lowest channel, Middle channel and Highest channel.

Result

Channel	Frequency (MHz)	Peak Power Spectral Density (dBm/100kHz)	Limit (dBm/3kHz)
Lowest	2402	-11.60	8.00
Middle	2442	-11.26	8.00
Highest	2480	-11.27	8.00

Note:

1. The following equation was used for spectrum offset:

$$\text{Spectrum offset (dB)} = \text{Attenuator (dB)} + \text{Cable Loss (dB)} + \text{SMA Type Connector Loss (dB)}$$

PLOTS OF EMISSIONS

Peak Power Spectral Density, Lowest Channel (2402 MHz)

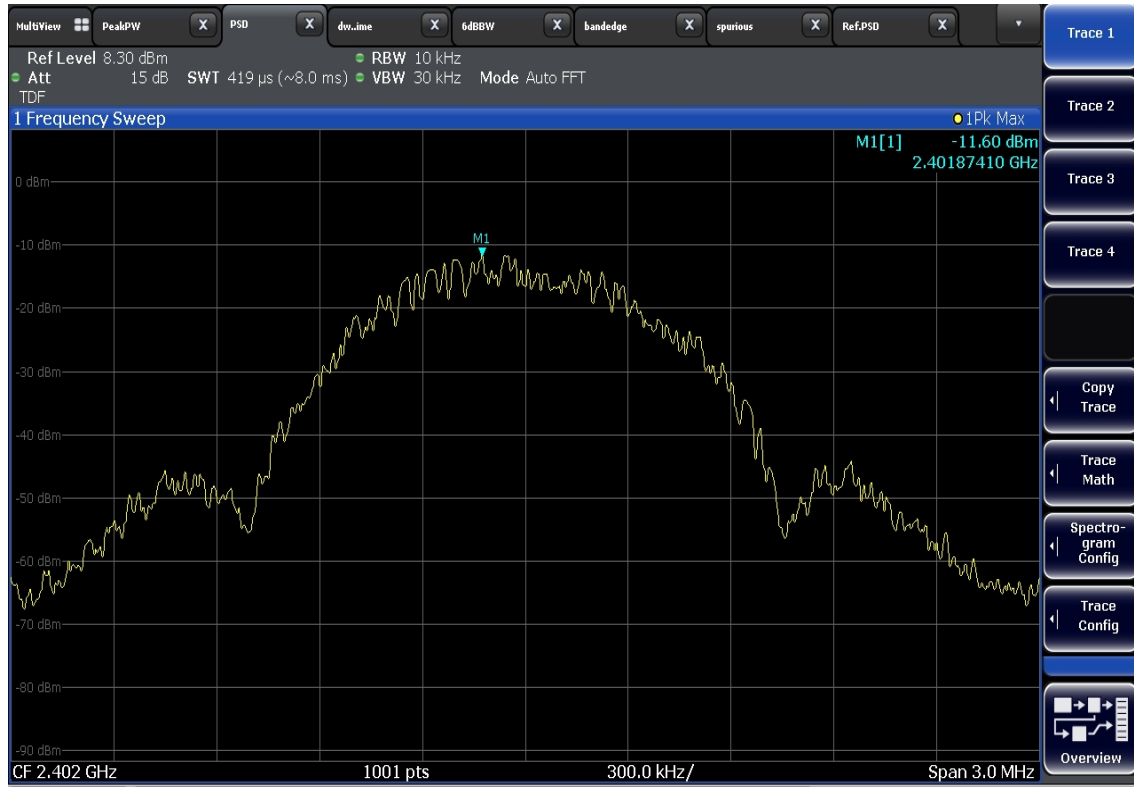

Peak Power Spectral Density, Middle Channel (2442 MHz)

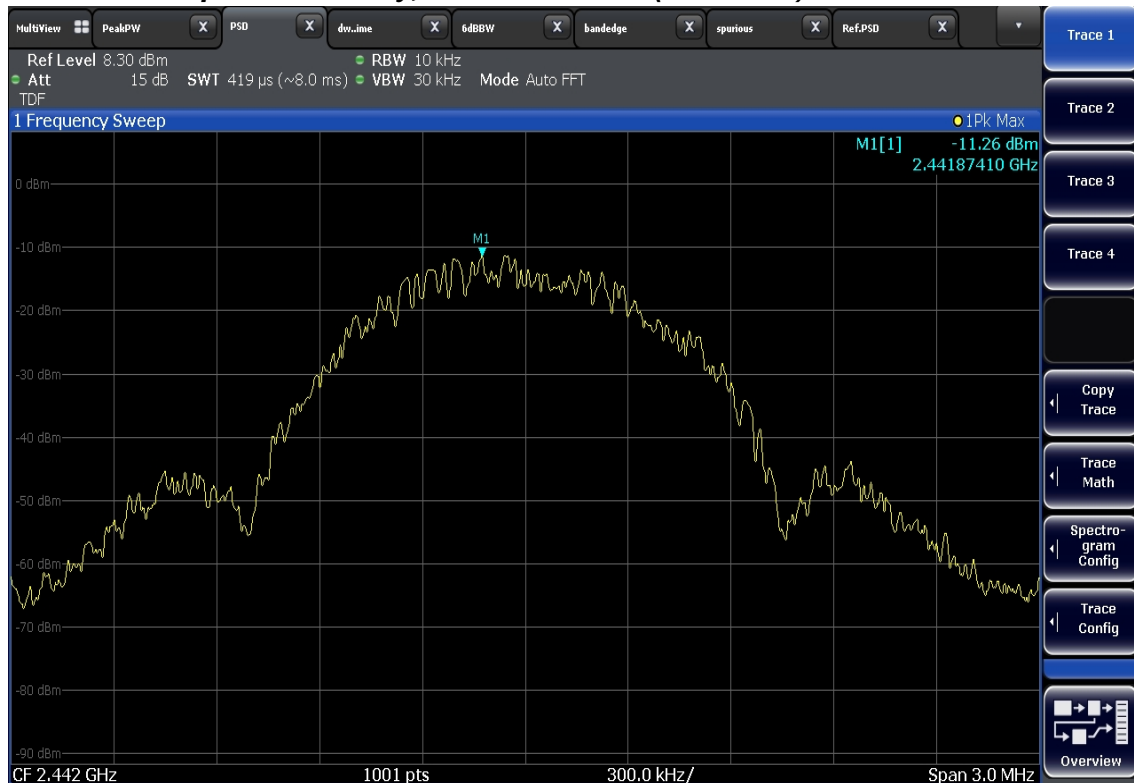

PLOTS OF EMISSIONS

Peak Power Spectral Density, Highest Channel (2480 MHz)

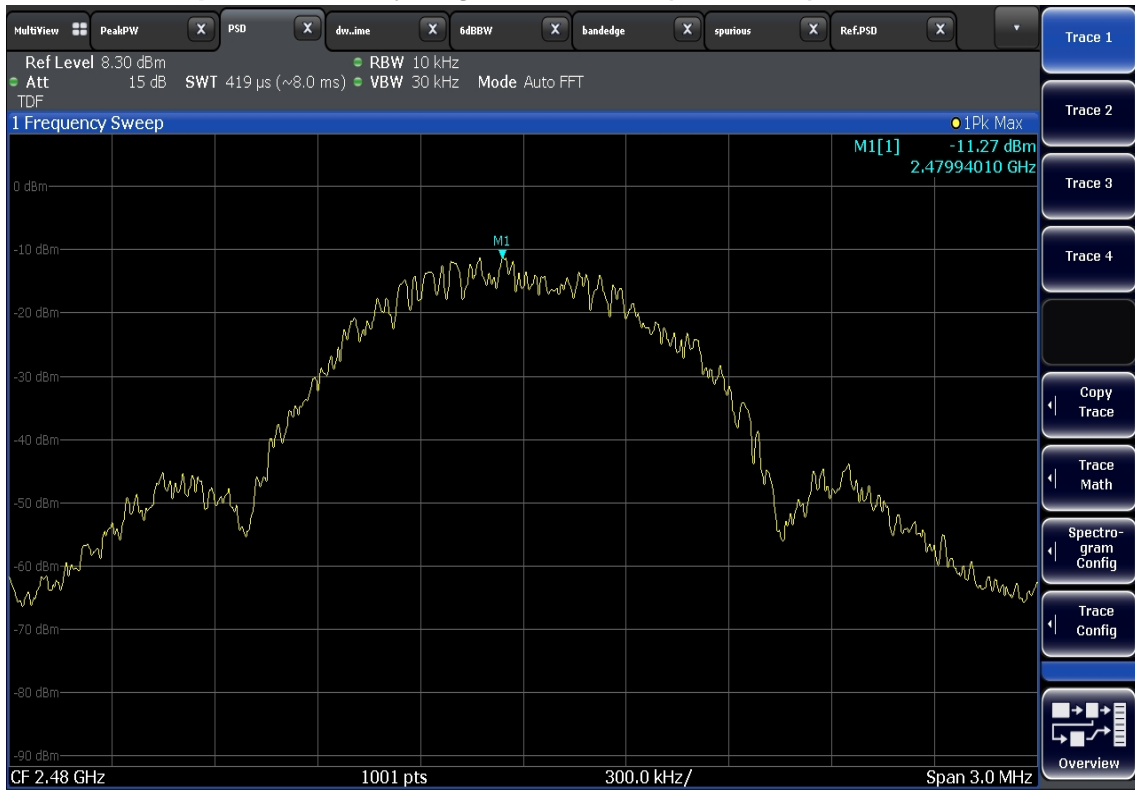

TEST DATA

8.6 Conducted Spurious Emissions

FCC §15.247(d), IC RSS-247 Issue 2 5.5

Test Mode : Set to Lowest channel, Middle channel and Highest channel,

Result

Channel	Frequency (MHz)	Reference Level (dBm/100kHz)	Conducted Spurious Emissions (dBc)	Limit (dBc)
Lowest	2402	-2.27	More than 30 dBc	30
Middle	2442	-1.91	More than 30 dBc	30
Highest	2480	-2.38	More than 30 dBc	30

Notes:

The cable and attenuator loss from 30 MHz to 26.5 GHz was reflected in spectrum analyzer with correction factor for the spurious emissions test.

PLOTS OF EMISSIONS

Reference Power Spectral Density, Lowest Channel (2402 MHz)

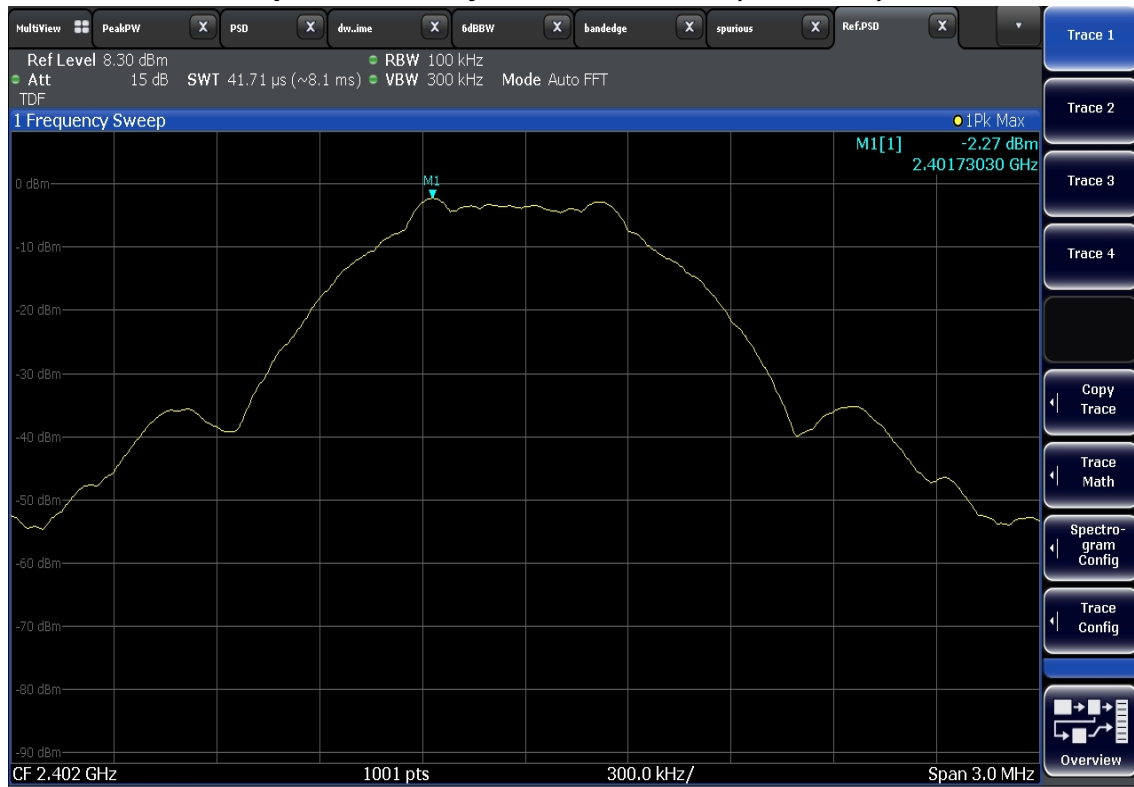

Band Edge, Lowest Channel (2402 MHz)

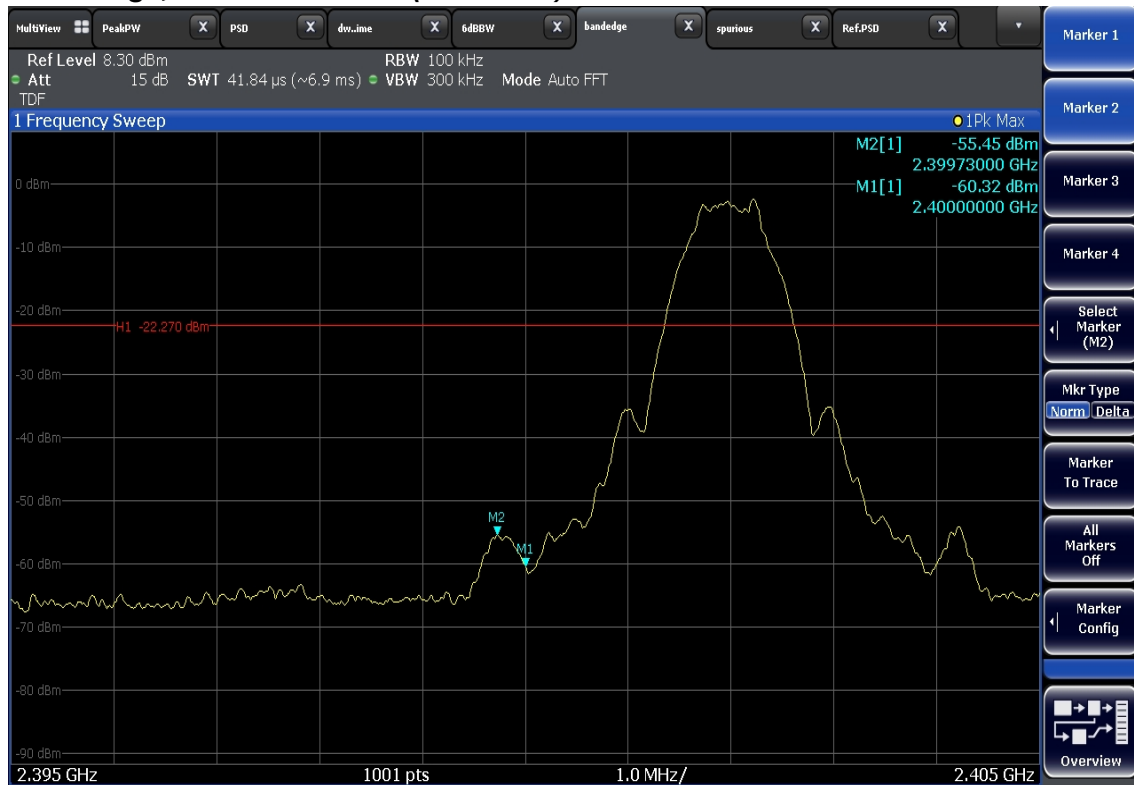

PLOTS OF EMISSIONS

Conducted Spurious Emissions, 30 MHz ~ 26.5 GHz (2402 MHz)

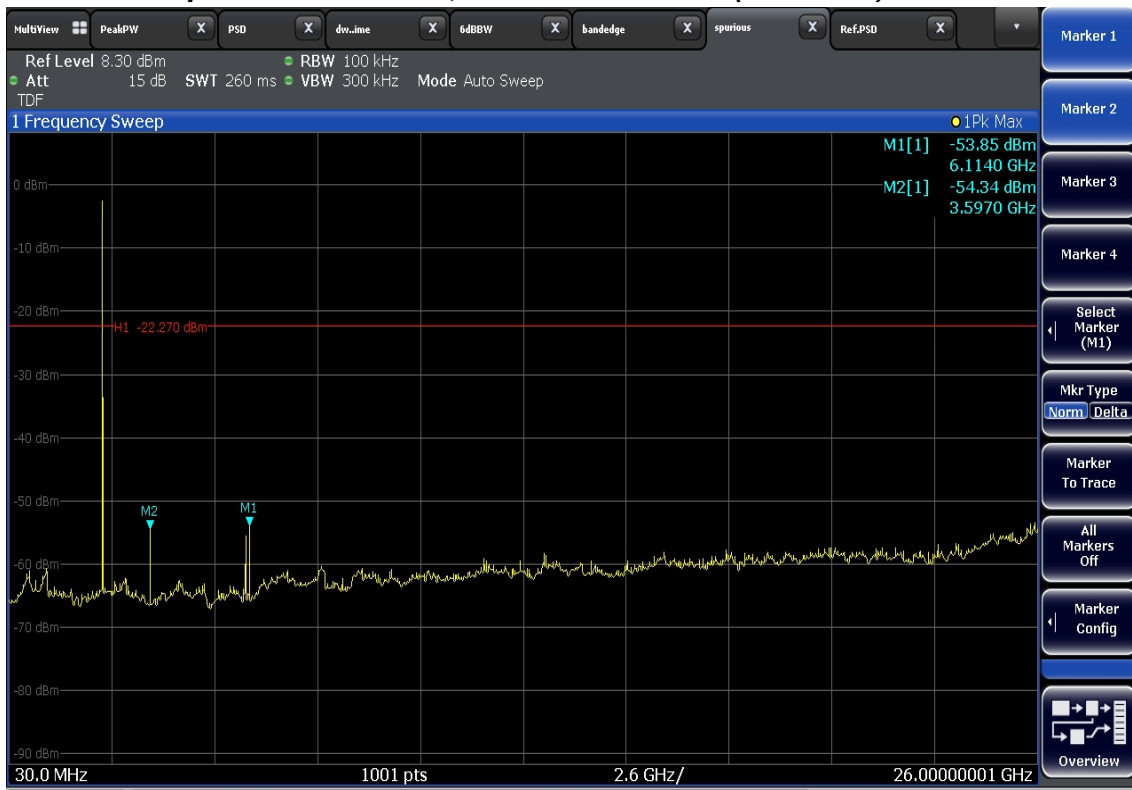

Reference Power Spectral Density, Middle Channel (2442 MHz)

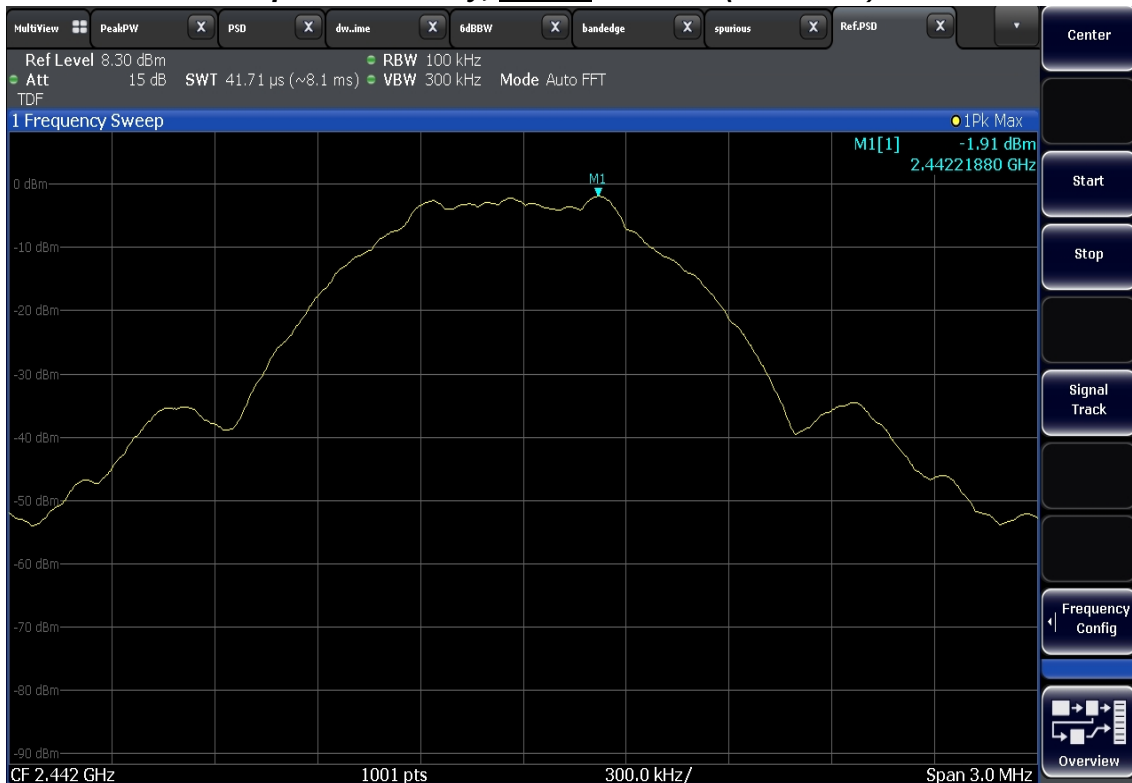

PLOTS OF EMISSIONS

Conducted Spurious Emissions, 30 MHz ~ 26.5 GHz (2442 MHz)

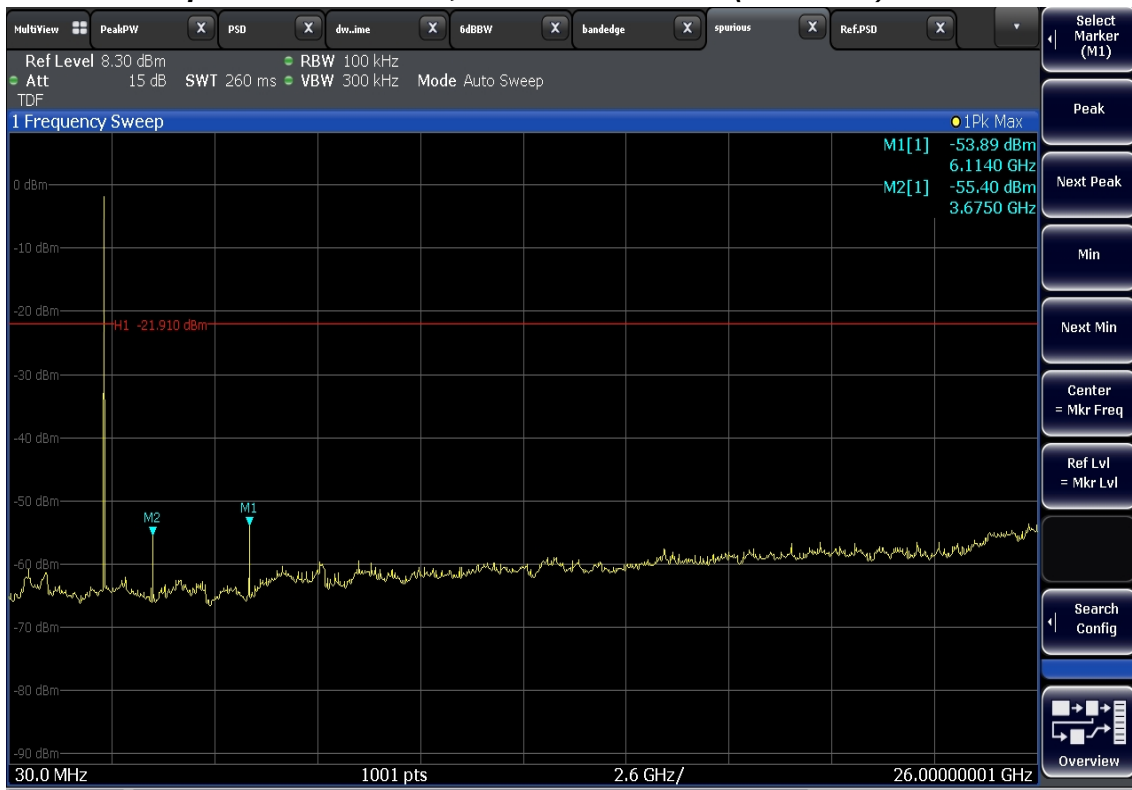

Reference Power Spectral Density, Highest Channel (2480 MHz)

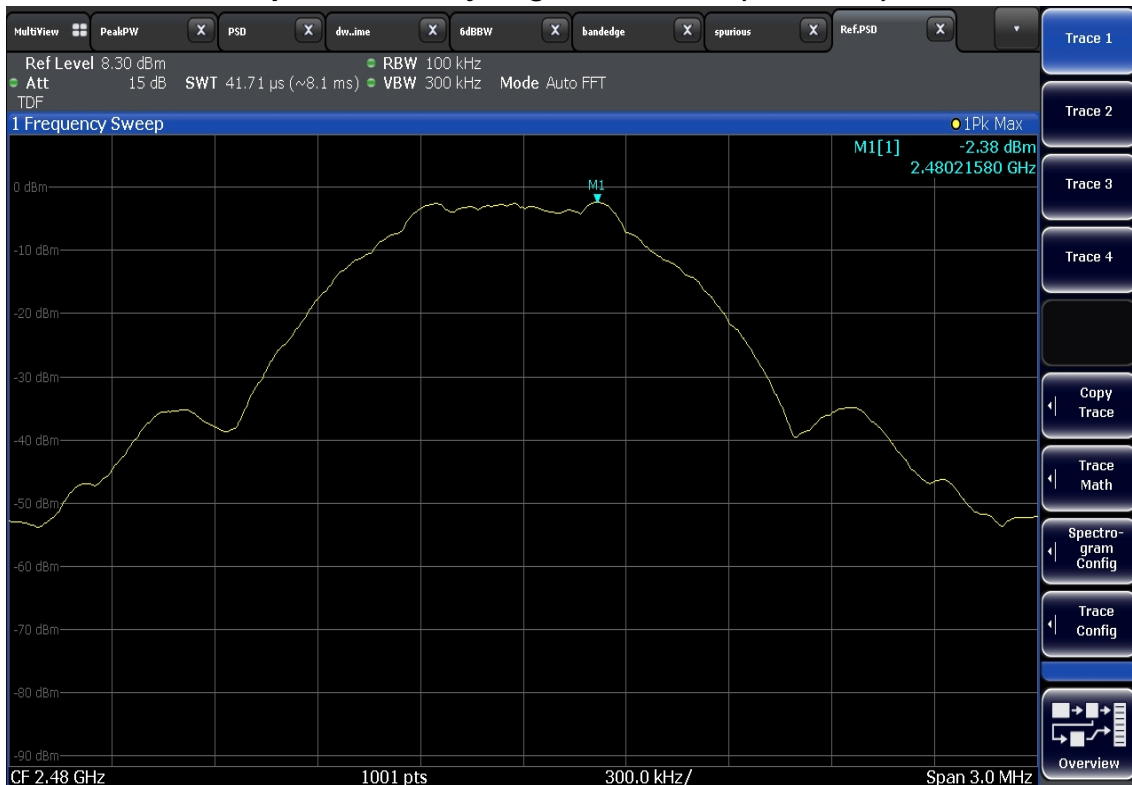

PLOTS OF EMISSIONS

Band Edge, Highest Channel (2480 MHz)

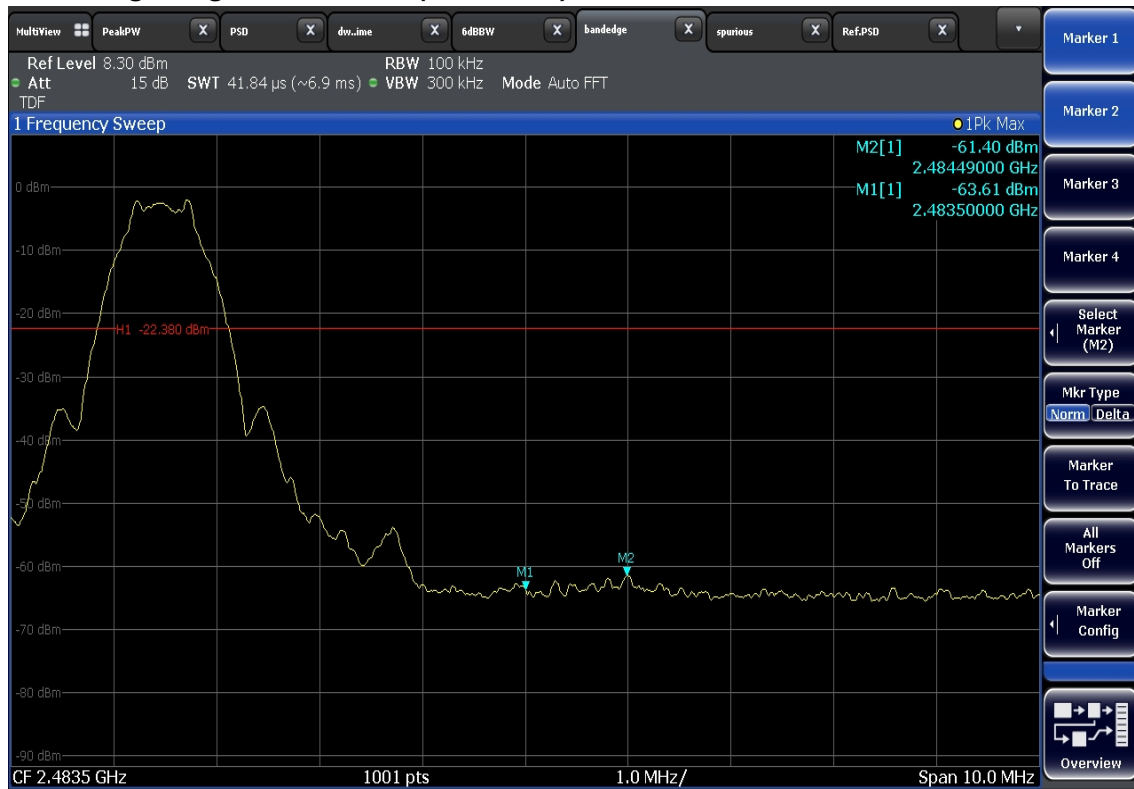

Conducted Spurious Emissions, 30 MHz ~ 26.5 GHz (2480 MHz)

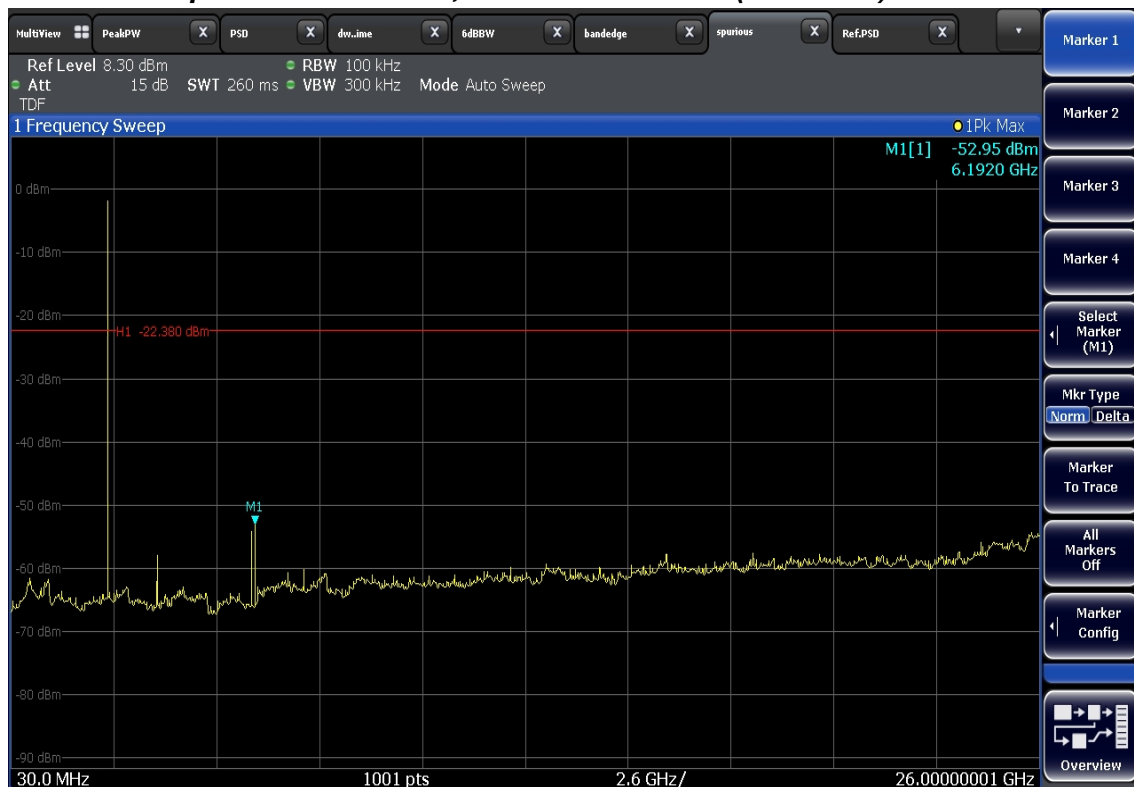

TEST DATA

8.7 Radiated Spurious Emissions

FCC §15.247(d), IC RSS-247 Issue 2 5.5

Test Mode : Set to Lowest channel, Middle channel and Highest channel,

Result

Lowest Channel

Frequency (MHz)	Reading (dB μ V)	Pol* (H/V)	mode	AF+CL+Amp (dB)**	Result (dB μ V/m)	Limit (dB μ V/m)	Margin (dB)
4758.00	47.0	V	peak	0.4	47.4	74.0	26.6

Middle Channel

Frequency (MHz)	Reading (dB μ V)	Pol* (H/V)	mode	AF+CL+Amp (dB)**	Result (dB μ V/m)	Limit (dB μ V/m)	Margin (dB)
3965.00	50.3	V	peak	-1.8	48.5	74.0	25.5

Highest Channel

Frequency (MHz)	Reading (dB μ V)	Pol* (H/V)	mode	AF+CL+Amp (dB)**	Result (dB μ V/m)	Limit (dB μ V/m)	Margin (dB)
3965.33	49.6	V	peak	-1.8	47.8	74.0	26.2

Note:

1. *Pol. H = Horizontal V = Vertical
2. **AF + CL + Amp. = Antenna Factor + Cable Loss + Amplifier.
3. Average measurement was not performed when peak-detected emission complies with the average limit.
4. Other spurious was under 30 dB below Fundamental.
5. Middle channel (2442MHz) was the worst condition.
6. The radiated emissions testing were made by rotating EUT through three orthogonal axes and rotating the receive antenna with horizontal, Vertical polarization. The worst data was recorded.
7. Peak emissions were measured using RBW = 1 MHz, VBW = 3 MHz, Detector = Peak.
8. Average emissions were measured using RBW = 1 MHz, VBW = 3 kHz, Detector = Peak.
9. The spectrum was measured from 9 kHz to 10th harmonic and the worst-case emissions were reported. No significant emissions were found beyond the 3rd harmonic for this device.

PLOTS OF EMISSIONS

Worst Case

Middle channel : 1 GHz to 8 GHz_Peak

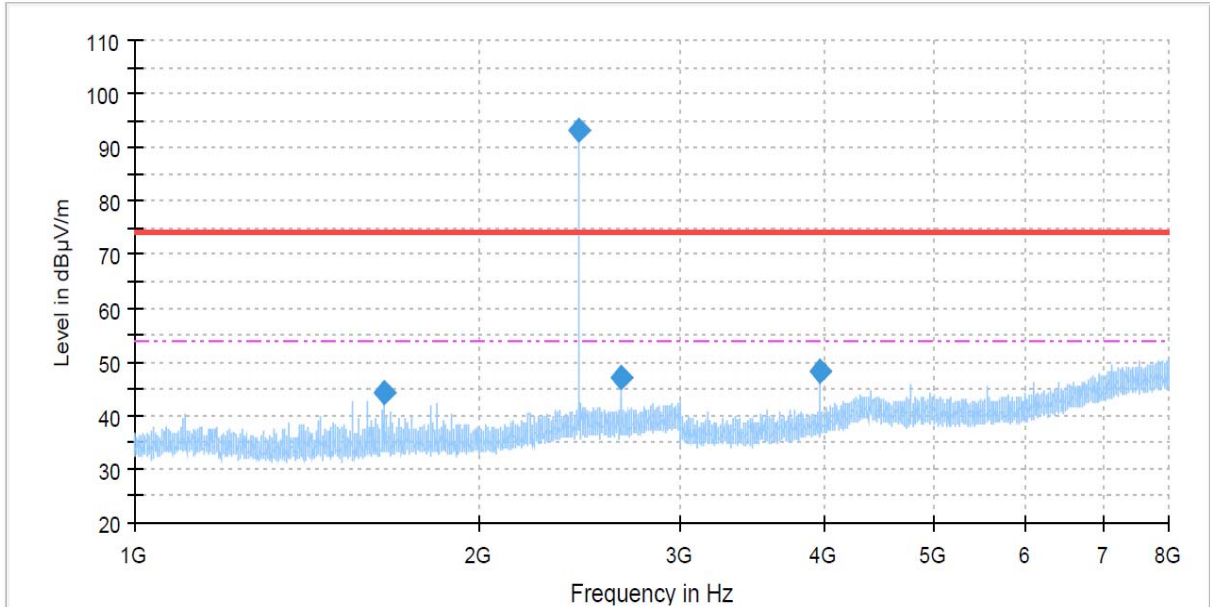

Middle channel : 8 GHz to 18 GHz_Peak

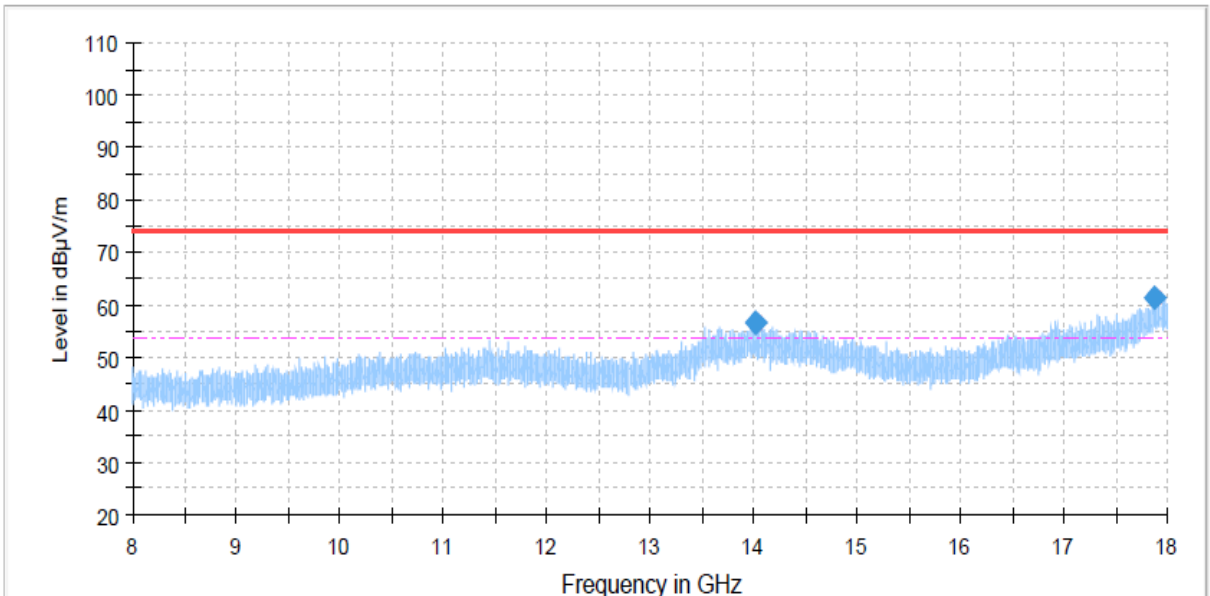

PLOTS OF EMISSIONS

Middle channel : 8 GHz to 18 GHz_Average

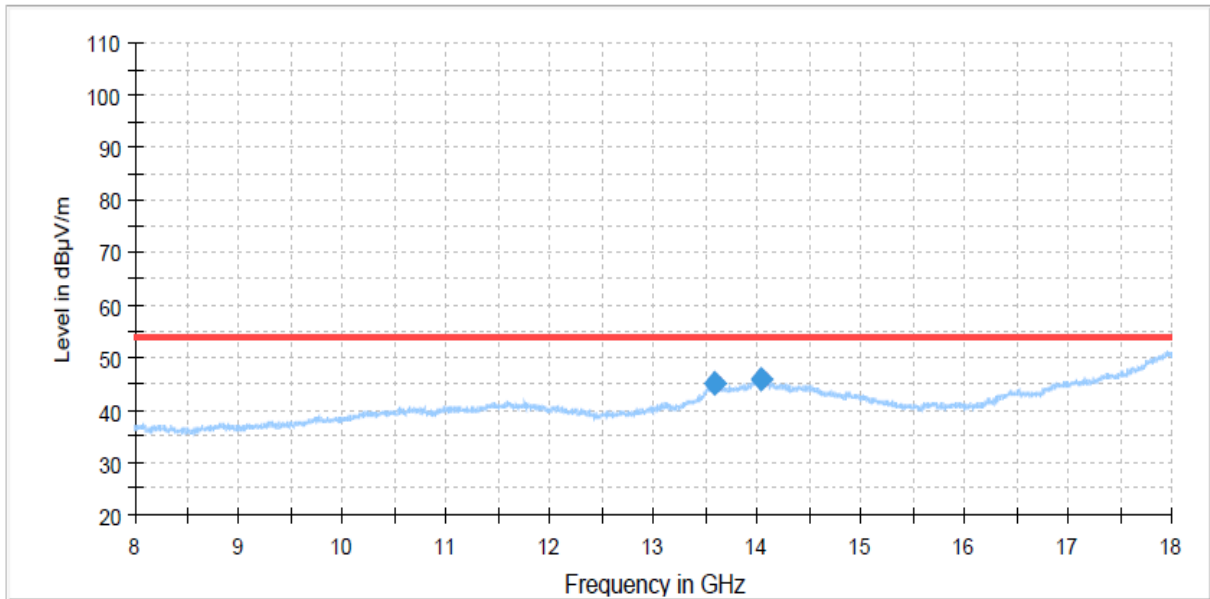

Middle channel : 18 GHz to 26.5 GHz_Peak

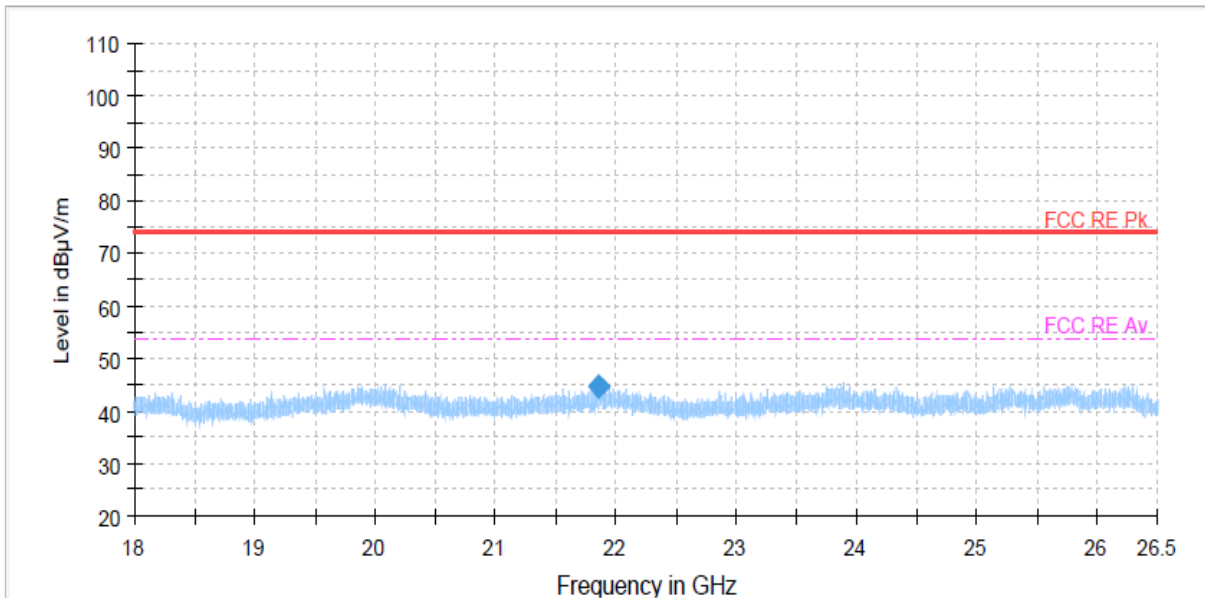

TEST DATA

8.8 Radiated Band Edge

FCC §15.247(d), IC RSS-247 Issue 2 5.5

Test Mode : Set to Lowest channel and Highest channel

Result

Lowest Channel

Frequency (MHz)	Reading (dBμV)	Pol* (H/V)	mode	AF+CL+Amp (dB)**	Result (dBμV/m)	Limit (dBμV/m)	Margin (dB)
2378.84	51.1	H	peak	-8.2	42.9	74.0	31.1
2390.00	48.1	H	peak	-8.3	39.8	74.0	34.3

Highest Channel

Frequency (MHz)	Reading (dBμV)	Pol* (H/V)	mode	AF+CL+Amp (dB)**	Result (dBμV/m)	Limit (dBμV/m)	Margin (dB)
2483.50	47.8	H	peak	-8.0	39.8	74.0	34.2
2496.43	50.2	V	peak	-8.0	42.2	74.0	31.9

Note:

1. *Pol. H = Horizontal V = Vertical
2. **AF + CL + Amp. = Antenna Factor + Cable Loss + Amplifier.
3. Average measurement was not performed when peak-detected emission complies with the average limit.
4. Other spurious was under 30 dB below Fundamental.
5. Lowest channel (2402MHz) mode was the worst condition.
6. The radiated emissions testing were made by rotating EUT through three orthogonal axes and rotating the receive antenna with horizontal, Vertical polarization. The worst data was recorded.
7. Peak emissions were measured using RBW = 1 MHz, VBW = 3 MHz, Detector = Peak.

PLOT OF TEST DATA

Worst Case

Highest Channel_Peak

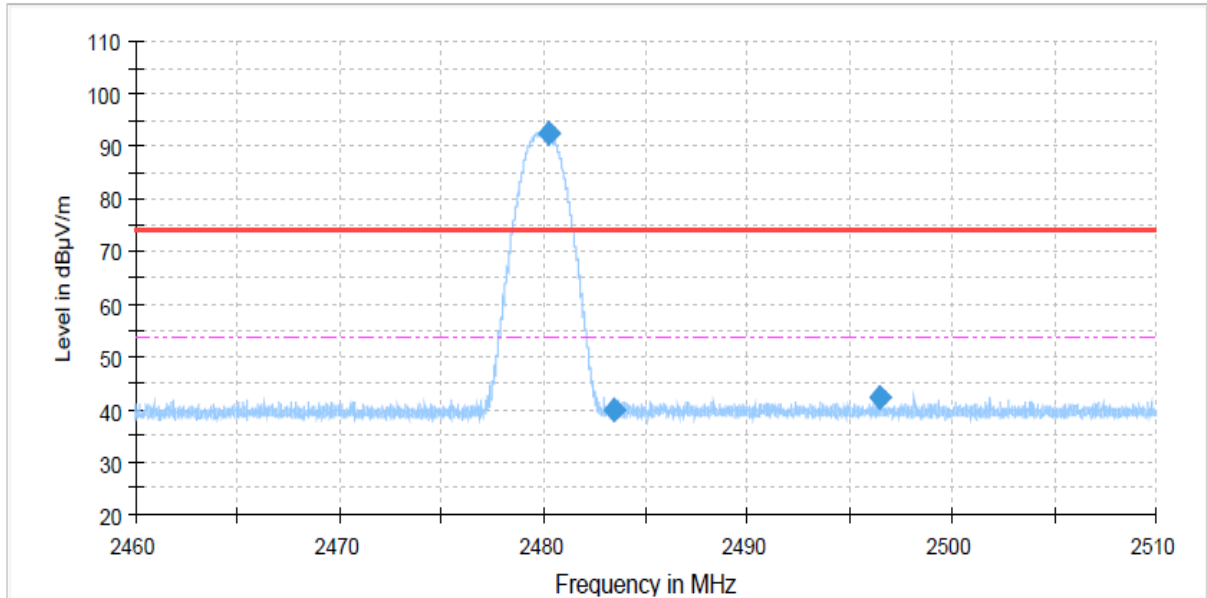

9. TEST EQUIPMENT

No.	Instrument	Manufacturer	Model	Serial No.	Calibration Date	Calibration Interval
1	*Test Receiver	R & S	ESU 40	100202	May. 24 2018	1 year
2	*Test Receiver	R & S	ESCS30	100302	Oct. 11 2018	1 year
3	*Attenuator	PASTERNAK	PE7395-10	1441-1	Jul. 07 2018	1 year
4	*Attenuator	FAIRVIEW	SA3N5W-06	N/A	Jul. 14 2018	1 year
5	*Attenuator	FAIRVIEW	SA3N5W-10	N/A	Apr. 04 2018	1 year
6	*Attenuator	WEINSCHEL	56-10	58765	Oct. 12 2018	1 year
7	*Amplifier	R & S	SCU 01	10029	Apr. 02 2018	1 year
8	*Amplifier	R & S	SCU18F	180025	Apr. 02 2018	1 year
9	*Amplifier	R & S	SCU26	10011	Jul. 16 2018	1 year
10	*Amplifier	R & S	SCU40	100380	Jul. 16 2018	1 year
11	Spectrum Analyzer	R & S	FSW43	100732	Apr. 02 2018	1 year
12	*Spectrum Analyzer	Agilent	E4440A	MY44022567	Oct. 11 2018	1 year
13	*Spectrum Analyzer	R & S	FSW43	104084	Apr. 02 2018	1 year
14	*Loop Antenna	R & S	HFH2-Z2	100279	Feb. 13 2019	2 year
15	*Horn Antenna	SCHWARZBECK	BBHA9120D	9120D-474	Jun. 28 2017	2 year
16	*Horn Antenna	Q-par Angus	QSH20S20	8179	Aug. 01 2017	2 year
17	*Horn Antenna	Q-par Angus	QSH22K20	8180	Aug. 02 2017	2 year
18	*Trilog-Broadband Antenna	SCHWARZBECK	VULB 9163	946	May. 18 2017	2 year
19	*LISN	R & S	ESH3-Z5	833874/006	Oct. 12 2018	1 year
20	*ESH2-Z5 Artificial Mains Network	R & S	ESH2-Z5	100227	Apr. 03 2018	1 year
21	*Position Controller	INNCO	CO2000	12480406/L	N/A	N/A
22	*Controller	INNCO	CO3000	CO3000/937/38330516/L	N/A	N/A
23	*Turn Table	INNCO	DS1200S	N/A	N/A	N/A
24	*Turn Table	INNCO	DT2000-2t	N/A	N/A	N/A
25	*Antenna Mast	INNCO	MA4000	N/A	N/A	N/A
26	*TILT Antenna Mast	INNCO	MA4640-XP-EP	N/A	N/A	N/A
27	*Open Switch And Control Unit	R & S	OSP-120	100081	N/A	N/A
28	*Open Switch And Control Unit	R & S	OSP-120	101766	N/A	N/A
29	*Shielded Room	Seo-Young EMC	N/A	N/A	N/A	N/A
30	*Anechoic Chamber	Seo-Young EMC	N/A	N/A	N/A	N/A
31	*WiFi Filter Bank	R & S	U083	N/A	N/A	N/A
32	*WiFi Filter Bank	R & S	U082	N/A	N/A	N/A

*) Test equipment used during the test

10. ACCURACY OF MEASUREMENT

The Measurement Uncertainties stated were calculated in accordance with the requirements of measurement uncertainty contained in CISPR 16-4-2 with the confidence level of 95%

1. Conducted Uncertainty Calculation

Source of Uncertainty	X_i	Uncertainty of X_i		Coverage factor k	$u(X_i)$ (dB)	C_i	$C_i u(X_i)$ (dB)
		Value (dB)	Probability Distribution				
Receiver reading	RI	± 0.1	normal 1	1.000	0.1	1	0.1
Attenuation AMN-Receiver	LC	± 0.08	normal 2	2.000	0.04	1	0.04
AMN Voltage division factor	LAMN	± 0.8	normal 2	2.000	0.4	1	0.4
Sine wave voltage	dVSW	± 2.00	normal 2	2.000	1.00	1	1.00
Pulse amplitude response	dVPA	± 1.50	rectangular	1.732	0.87	1	0.87
Pulse repetition rate response	dVPR	± 1.50	rectangular	1.732	0.87	1	0.87
Noise floor proximity	dVNF	± 0.00	-	-	0.00	1	0.00
AMN Impedance	dZ	± 1.80	triangular	2.449	0.73	1	0.73
Ⓐ Mismatch	M	+ 0.70	U-Shaped	1.414	0.49	1	0.49
Ⓑ Mismatch	M	- 0.80	U-Shaped	1.414	- 0.56	1	- 0.56
Measurement System Repeatability	RS	0.05	normal 1	1.000	0.05	1	0.05
Remark	Ⓐ: AMN-Receiver Mismatch : + Ⓑ: AMN-Receiver Mismatch : -						
Combined Standard Uncertainty	Normal			± 1.88			
Expanded Uncertainty U	Normal ($k = 2$)			± 3.76			

2. Radiation Uncertainty Calculation

Source of Uncertainty	X_i	Uncertainty of X_i		Coverage factor k	$u(X_i)$ (dB)	C_i	$C_i u(X_i)$ (dB)
		Value (dB)	Probability Distribution				
Measurement System Repeatability	RS	0.34	normal 1	1.00	0.34	1	0.34
Receiver reading	Ri	± 0.02	normal 2	2.00	0.01	1	0.01
Sine wave voltage	dVsw	± 0.17	normal 2	2.00	0.09	1	0.09
Pulse amplitude response	dVpa	± 0.92	normal 2	2.00	0.46	1	0.46
Pulse repetition rate response	dVpr	± 0.35	normal 2	2.00	0.18	1	0.18
Noise floor proximity	dVnf	± 0.50	normal 2	2.00	0.25	1	0.25
Antenna Factor Calibration	AF	± 2.00	rectangular	$\sqrt{3}$	1.15	1	1.15
Cable Loss	CL	± 1.00	normal 2	2.00	0.50	1	0.50
Antenna Directivity	AD	± 0.00	rectangular	$\sqrt{3}$	0.00	1	0.00
Antenna Factor Height Dependence	AH	± 2.00	rectangular	$\sqrt{3}$	1.15	1	1.15
Antenna Phase Centre Variation	AP	± 0.20	rectangular	$\sqrt{3}$	0.12	1	0.12
Antenna Factor Frequency Interpolation	Ai	± 0.25	rectangular	$\sqrt{3}$	0.14	1	0.14
Site Imperfections	Si	± 4.00	triangular	$\sqrt{6}$	1.63	1	1.63
Measurement Distance Variation	DV	± 0.60	rectangular	$\sqrt{3}$	0.35	1	0.35
Antenna Balance	Dbal	± 0.90	rectangular	$\sqrt{3}$	0.52	1	0.52
Cross Polarisation	DCross	± 0.00	rectangular	$\sqrt{3}$	0.00	1	0.18
Mismatch	M	+ 0.98 - 1.11	U-Shaped	$\sqrt{2}$	0.74	1	0.74
EUT Volume Diameter	Vd	0.33	normal 1	1.00	0.33	1	0.11
Remark							
Combined Standard Uncertainty	Normal						
Expanded Uncertainty U	Normal ($k = 2$)						