

SAR Test Report

Product Name : NoteBook PC

Model No. : 9212XY

Applicant : MiTAC Technology Corp.

Address : 4F, No.1, R&D Road 2, Hsinchu Science-Based
Industrial Park, Hsinchu, Taiwan, R.O.C.

Date of Receipt : 2008/11/20

Issued Date : 2008/12/08

Report No. : 08B279R-HPUSP10V01

Version : V1.0

The test results relate only to the samples tested.

The test report shall not be reproduced except in full without the written approval of Quietek Corporation.

Test Report Certification

Issued Date: 2008/12/05

Report No.:08B279R-HPUSP10V01



Product Name : NoteBook PC
 Applicant : MiTAC Technology Corp.
 Address : 4F, No.1, R&D Road 2, Hsinchu Science-Based Industrial Park, Hsinchu, Taiwan, R.O.C.
 Manufacturer : Getac Technology (Kunshan) Co., Ltd.
 Model No. : 9212XY
 Trade Name : MTC / Getac
 WLAN Model No. : Intel® WiFi Link 5300
 Applicable Standard : FCC Oet65 Supplement C June 2001
 IEEE Std. 1528-2003 47CFR § 2.1093
 Test Result : Max. SAR Measurement (1g)
 2.4GHz Band (2412MHz~2462MHz): 0.236 W/kg
 5.2GHz Band (5200MHz~5320MHz): 0.376 W/kg
 5.8GHz Band (5500MHz~5825MHz): 0.445 W/kg

Application Type Certification

The test results relate only to the samples tested.
 The test report shall not be reproduced except in full without the written approval of Quietek Corporation.

Documented By : Nicole Huang
 (Engineering Adm. Assistant / Nicole Huang)

Tested By : Jung Chang
 (Engineer / Jung Chang)

Approved By : Vincent Lin
 (Manager / Vincent Lin)

TABLE OF CONTENTS

Description	Page
1. General Information.....	5
1.1 EUT Description	5
1.2 Test Environment	6
2. SAR Measurement System.....	7
2.1 ALSAS-10U System Description	7
2.1.1 Applications	7
2.1.2 Area Scans.....	7
2.1.3 Zoom Scan (Cube Scan Averaging).....	8
2.1.4 ALSAS-10U Interpolation and Extrapolation Uncertainty.....	8
2.2 Isotropic E-Field Probe	8
2.2.1 Isotropic E-Field Probe Specification	10
2.3 Boundary Detection Unit and Probe Mounting Device	10
2.4 Daq-Paq (Analog to Digital Electronics).....	11
2.5 Axis Articulated Robot	11
2.6 ALSAS Universal Workstation.....	12
2.7 Universal Device Positioner.....	12
2.8 Phantom Types.....	12
2.8.1 APREL SAM Phantoms	13
2.8.2 APREL Laboratories Universal Phantom	13
3. Tissue Simulating Liquid	14
3.1 The composition of the tissue simulating liquid	14
3.2 Tissue Calibration Result	14
3.3 Tissue Dielectric Parameters for Head and Body Phantoms	17
4. SAR Measurement Procedure.....	18
4.1 SAR System Validation.....	18
4.1.1 Validation Dipoles.....	18
4.1.2 Validation Result	18
4.2 SAR Measurement Procedure.....	19
5. SAR Exposure Limits	21
6. Test Equipment List.....	22
7. Measurement Uncertainty.....	23
8. Test Results	23

8.1 SAR Test Results Summary 24

Appendix..... 27

Appendix A. SAR System Validation Data

Appendix B. SAR measurement Data

Appendix C. Test Setup Photographs & EUT Photographs

Appendix D. Probe Calibration Data

Appendix E. Dipole Calibration Data

1. General Information

1.1 EUT Description

Product Name	NoteBook PC
Trade Name	MTC / Getac
Model No.	9212XY
FCC ID	MAU9212
WLAN Model No.	Intel® WiFi Link 5300
TX Frequency	2412MHz~2462MHz 5180MHz~5320MHz 5500MHz~5825MHz
Number of Channel	2.4GHz Band: 11 5.2GHz Band: 64 5.8GHz Band (802.11n): 165
Type of Modulation	DSSS/OFDM
Antenna Type	PIFA
Device Category	Portable
RF Exposure Environment	Uncontrolled
Transfer Rate	802.11b: 11Mbps 802.11g: 54Mbps 802.11a: 54Mbps 802.11n: 144Mbps / 300Mbps

1.2 Test Environment

Ambient conditions in the laboratory:

Items	Required	Actual
Temperature (°C)	18-25	22.5
Humidity (%RH)	30-70	54

Site Description:

Accredited by TAF
Accredited Number: 0914
Effective through: December 12, 2008



Site Name: Quietek Corporation

Site Address: No. 5, Ruei-Shu Valley, Ruei-Ping Tsuen,
Lin-Kou Shiang, Taipei,
Taiwan, R.O.C.
TEL : 886-2-8601-3788 / FAX : 886-2-8601-3789
E-Mail : service@quietek.com

2. SAR Measurement System

2.1 ALSAS-10U System Description

ALSAS-10-U is fully compliant with the technical and scientific requirements of IEEE 1528, IEC 62209, CENELEC, ARIB, ACA, and the Federal Communications Commission. The system comprises of a six axes articulated robot which utilizes a dedicated controller.

ALSAS-10U uses the latest methodologies and FDTD modeling to provide a platform which is repeatable with minimum uncertainty.

2.1.1 Applications

Predefined measurement procedures compliant with the guidelines of CENELEC, IEEE, IEC, FCC, etc are utilized during the assessment for the device. Automatic detection for all SAR maxima are embedded within the core architecture for the system, ensuring that peak locations used for centering the zoom scan are within a 1mm resolution and a 0.05mm repeatable position. System operation range currently available up-to 6 GHz in simulated tissue.

2.1.2 Area Scans

Area scans are defined prior to the measurement process being executed with a user defined variable spacing between each measurement point (integral) allowing low uncertainty measurements to be conducted. Scans defined for FCC applications utilize a 10mm² step integral, with 1mm interpolation used to locate the peak SAR area used for zoom scan assessments.

Where the system identifies multiple SAR peaks (which are within 25% of peak value) the system will provide the user with the option of assessing each peak location individually for zoom scan averaging.



2.1.3 Zoom Scan (Cube Scan Averaging)

The averaging zoom scan volume utilized in the ALSAS-10U software is in the shape of a cube and the side dimension of a 1 g or 10 g mass is dependent on the density of the liquid representing the simulated tissue. A density of 1000 kg/m³ is used to represent the head and body tissue density and not the phantom liquid density, in order to be consistent with the definition of the liquid dielectric properties, i.e. the side length of the 1 g cube is 10mm, with the side length of the 10 g cube 21,5mm.

When the cube intersects with the surface of the phantom, it is oriented so that 3 vertices touch the surface of the shell or the center of a face is tangent to the surface. The face of the cube closest to the surface is modified in order to conform to the tangent surface.

The zoom scan integer steps can be user defined so as to reduce uncertainty, but normal practice for typical test applications (including FCC) utilize a physical step of 5x5x8 (8mmx8mmx5mm) providing a volume of 32mm in the X & Y axis, and 35mm in the Z axis.

2.1.4 ALSAS-10U Interpolation and Extrapolation Uncertainty

The overall uncertainty for the methodology and algorithms the used during the SAR calculation was evaluated using the data from IEEE 1528 based on the example f3 algorithm:

$$f_3(x, y, z) = A \frac{a^2}{\frac{a^2}{4} + x'^2 + y'^2} \cdot \left(e^{-\frac{2z}{a}} + \frac{a^2}{2(a + 2z)^2} \right)$$

2.2 Isotropic E-Field Probe

The isotropic E-Field probe has been fully calibrated and assessed for isotropicity, and boundary effect within a controlled environment. Depending on the frequency for which the probe is calibrated the method utilized for calibration will change. A number of methods is used for calibrating probes, and these are outlined in the table below:

Calibration Frequency	Air Calibration	Tissue Calibration
2450MHz	Waveguide	Temperature
5200MHz	Waveguide	Temperature
5800MHz	Waveguide	Temperature

The E-Field probe utilizes a triangular sensor arrangement as detailed in the diagram below:

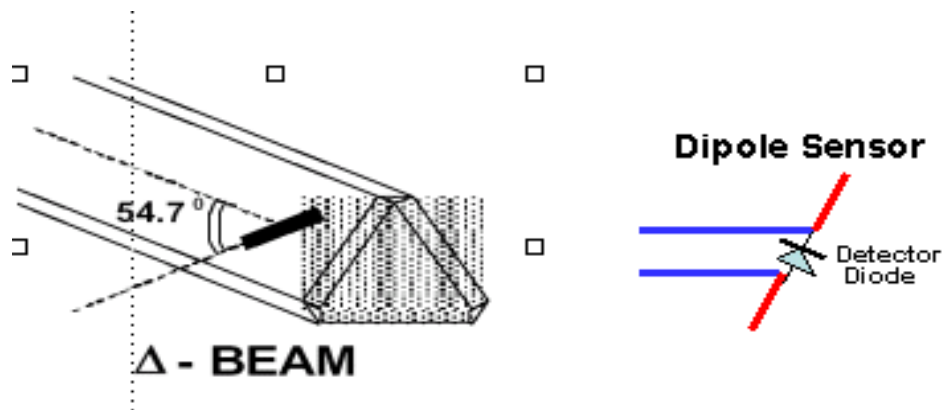

SAR is assessed with a calibrated probe which moves at a default height of 5mm from the center of the diode, which is mounted to the sensor, to the phantom surface (in the Z Axis). The 5mm offset height has been selected so as to minimize any resultant boundary effect due to the probe being in close proximity to the phantom surface.

The following algorithm is an example of the function used by the system for linearization of the output from the probe when measuring complex modulation schemes.

$$V_i = U_i + U_i^2 \cdot \frac{cf}{dcp_i}$$

2.2.1 Isotropic E-Field Probe Specification

Calibration in Air	Frequency Dependent Below 2GHz Calibration in air performed in a TEM Cell Above 2GHz Calibration in air performed in waveguide
Sensitivity	0.70 $\mu\text{V}/(\text{V}/\text{m})^2$ to 0.85 $\mu\text{V}/(\text{V}/\text{m})^2$
Dynamic Range	0.0005 W/kg to 100W/kg
Isotropic Response	Better than 0.2dB
Diode Compression point (DCP)	Calibration for Specific Frequency
Probe Tip Radius	< 5mm
Sensor Offset	1.56 (+/- 0.02mm)
Probe Length	290mm
Video Bandwidth	@ 500 Hz: 1dB @1.02 KHz: 3dB
Boundary Effect	Less than 2% for distance greater than 2.4mm
Spatial Resolution	Diameter less than 5mm Compliant with Standards

2.3 Boundary Detection Unit and Probe Mounting Device

ALSAS-10U incorporates a boundary detection unit with a sensitivity of 0.05mm for detecting all types of surfaces. The robust design allows for detection during probe tilt (probe normalize) exercises, and utilizes a second stage emergency stop. The signal electronics are fed directly into the robot controller for high accuracy surface detection in lateral and axial detection modes (X, Y, & Z).

The probe is mounted directly onto the Boundary Detection unit for accurate tooling and displacement calculations controlled by the robot kinematics. The probe is connect to an isolated probe interconnect where the output stage of the probe is fed directly into the amplifier stage of the Daq-Paq.

2.4 Daq-Paq (Analog to Digital Electronics)

ALSAS-10U incorporates a fully calibrated Daq-Paq (analog to digital conversion system) which has a 4 channel input stage, sent via a 2 stage auto-set amplifier module. The input signal is amplified accordingly so as to offer a dynamic range from 5µV to 800mV. Integration of the fields measured is carried out at board level utilizing a Co-Processor which then sends the measured fields down into the main computational module in digitized form via an RS232 communications port. Probe linearity and duty cycle compensation is carried out within the main Daq-Paq module.

ADC	12 Bit
Amplifier Range	20mV to 200mV and 150mV to 800mV
Field Integration	Local Co-Processor utilizing proprietary integration algorithms
Number of Input Channels	4 in total 3 dedicated and 1 spare
Communication	Packet data via RS232

2.5 Axis Articulated Robot



ALSAS-10U utilizes a six axis articulated robot, which is controlled using a Pentium based real-time movement controller. The movement kinematics engine utilizes proprietary (Thermo CRS) interpolation and extrapolation algorithms, which allow full freedom of movement for each of the six joints within the working envelope. Utilization of joint 6 allows for full probe rotation with a tolerance better than 0.05mm around the central axis.

Robot/Controller Manufacturer	Thermo CRS
Number of Axis	Six independently controlled axis
Positioning Repeatability	0.05mm
Controller Type	Single phase Pentium based C500C
Robot Reach	710mm
Communication	RS232 and LAN compatible

2.6 ALSAS Universal Workstation

ALSAS Universal workstation allows for repeatability and fast adaptability. It allows users to do calibration, testing and measurements using different types of phantoms with one set up, which significantly speeds up the measurement process.

2.7 Universal Device Positioner

The universal device positioner allow complete freedom of movement of the EUT. Developed to hold a EUT in a free-space scenario any additional loading attributable to the material used in the construction of the positioner has been eliminated. Repeatability has been enhanced through the linear scales which form the design used to indicate positioning for any given test scenario in all major axes. A 15° tilt indicator is included for the of aid cheek to tilt movements for head SAR analysis. Overall uncertainty for measurements have been reduced due to the design of the Universal device positioner, which allows positioning of a device in as near to a free-space scenario as possible, and by providing the means for complete repeatability.



2.8 Phantom Types

The ALSAS-10U allows the integration of multiple phantom types. SAM Phantoms fully compliant with IEEE 1528, Universal Phantom, and Universal Flat.

2.8.1 APREL SAM Phantoms

The SAM phantoms developed using the IEEE SAM CAD file. They are fully compliant with the requirements for both IEEE 1528 and FCC Supplement C. Both the left and right SAM phantoms are interchangeable, transparent and include the IEEE 1528 grid with visible NF and MB lines.

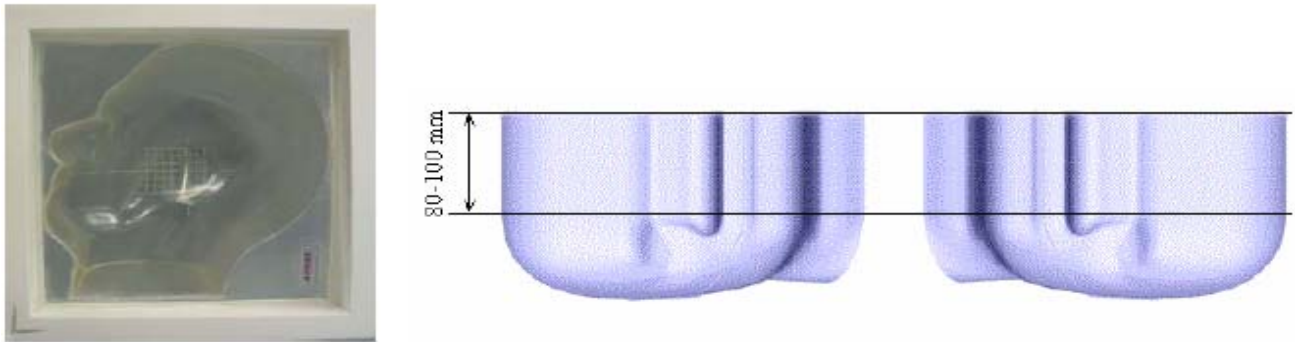

2.8.2 APREL Laboratories Universal Phantom

The Universal Phantom is used on the ALSAS-10U as a system validation phantom. The Universal Phantom has been fully validated both experimentally from 800MHz to 6GHz and numerically using XFDTD numerical software. The shell thickness is 2mm overall, with a 4mm spacer located at the NF/MB intersection providing an overall thickness of 6mm in line with the requirements of IEEE-1528.



The design allows for fast and accurate measurements, of handsets, by allowing the conservative SAR to be evaluated at on frequency for both left and right head experiments in one measurement.

3. Tissue Simulating Liquid

3.1 The composition of the tissue simulating liquid

INGREDIENT (% Weight)	2450MHz Head	2450MHz Body	5200MHz Head	5200MHz Body	5800MHz Head	5800MHz Body
Water	46.7	73.2	67.63	76	68.29	75.68
Salt	0.00	0.04	0.00	0.00	0.00	0.43
Sugar	0.00	0.00	0.00	0.00	0.00	0.00
HEC	0.00	0.00	0.00	0.00	0.00	0.00
Preventol	0.00	0.00	0.00	0.00	0.00	0.00
DGBE	53.3	26.7	3.38	4.44	2.44	4.42
Triton X-100	0.00	0.00	28.99	19.56	29.27	19.47

3.2 Tissue Calibration Result

The dielectric parameters of the liquids were verified prior to the SAR evaluation using APREL Dielectric Probe Kit and Anritsu MS4623B Vector Network Analyzer.

Head Tissue Simulant Measurement				
Frequency [MHz]	Description	Dielectric Parameters		Tissue Temp. [°C]
		ϵ_r	σ [s/m]	
2450MHz	Reference result ± 5% window	40.1 38.095 to 42.105	1.78 1.691 to 1.869	N/A
	01-Dec-08	40.97	1.81	21.6

Body Tissue Simulant Measurement				
Frequency [MHz]	Description	Dielectric Parameters		Tissue Temp. [°C]
		ϵ_r	σ [s/m]	
2450MHz	Reference result ± 5% window	52.7 50.065 to 55.335	1.95 1.8525 to 2.0475	N/A
	01-Dec-08	54.25	1.97	21.6
2412 MHz	Low channel	54.36	1.95	21.6
2437 MHz	Mid channel	54.19	1.97	21.6
2462 MHz	High channel	54.15	1.98	21.6

Head Tissue Simulant Measurement				
Frequency [MHz]	Description	Dielectric Parameters		Tissue Temp. [°C]
		ϵ_r	σ [s/m]	
5200MHz	Reference result ± 5% window	39.94 37.943 to 41.937	5.24 4.987 to 5.502	N/A
	01-Dec-08	39.71	5.346	21.6

Body Tissue Simulant Measurement				
Frequency [MHz]	Description	Dielectric Parameters		Tissue Temp. [°C]
		ϵ_r	σ [s/m]	
5200MHz	Reference result ± 5% window	48.9 46.455 to 51.345	5.35 5.0825 to 5.6175	N/A
	01-Dec-08	49.53	5.47	21.6
5180 MHz	Low channel	49.55	5.41	21.6
5260 MHz	Mid channel	49.39	5.56	21.6
5320 MHz	High channel	49.32	5.57	21.6

Head Tissue Simulant Measurement				
Frequency [MHz]	Description	Dielectric Parameters		Tissue Temp. [°C]
		ϵ_r	σ [s/m]	
5800MHz	Reference result ± 5% window	35.15 33.393 to 36.908	6.4 6.08 to 6.72	N/A
	01-Dec-08	35.19	6.35	21.6

Body Tissue Simulant Measurement				
Frequency [MHz]	Description	Dielectric Parameters		Tissue Temp. [°C]
		ϵ_r	σ [s/m]	
5800MHz	Reference result ± 5% window	48.2 45.79 to 50.61	6 5.7 to 6.3	N/A
	01-Dec-08	49.10	6.14	21.6
5500 MHz	Low channel	49.23	6.11	21.6
5640 MHz	Mid channel	49.14	6.13	21.6
5825 MHz	High channel	48.91	6.15	21.6

3.3 Tissue Dielectric Parameters for Head and Body Phantoms

The head tissue dielectric parameters recommended by the IEEE SCC-34/SC-2 in P1528 have been incorporated in the following table. These head parameters are derived from planar layer models simulating the highest expected SAR for the dielectric properties and tissue thickness variations in a human head. Other head and body tissue parameters that have not been specified in P1528 are derived from the tissue dielectric parameters computed from the 4-Cole-Cole equations described in Reference [12] and extrapolated according to the head parameters specified in P1528.

Target Frequency (MHz)	Head		Body	
	ϵ_r	σ (S/m)	ϵ_r	σ (S/m)
150	52.3	0.76	61.9	0.80
300	45.3	0.87	58.2	0.92
450	43.5	0.87	56.7	0.94
835	41.5	0.90	55.2	0.97
900	41.5	0.97	55.0	1.05
915	41.5	0.98	55.0	1.06
1450	40.5	1.20	54.0	1.30
1610	40.3	1.29	53.8	1.40
1800 – 2000	40.0	1.40	53.3	1.52
2450	39.2	1.80	52.7	1.95
3000	38.5	2.40	52.0	2.73
5800	35.3	5.27	48.2	6.00

(ϵ_r = relative permittivity, σ = conductivity and $\rho = 1000 \text{ kg/m}^3$)

4. SAR Measurement Procedure

4.1 SAR System Validation

4.1.1 Validation Dipoles

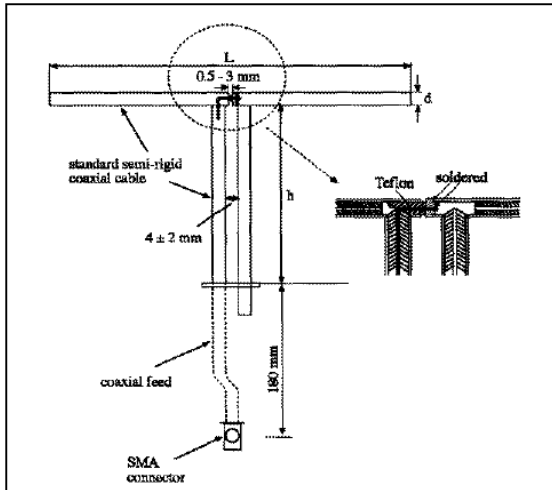

The dipoles used is based on the IEEE-1528 standard, and is complied with mechanical and electrical specifications in line with the requirements of both IEEE and FCC Supplement C. the table below provides details for the mechanical and electrical specifications for the dipoles.

Frequency	L (mm)	h (mm)	d (mm)
2450MHz	53.5	30.4	3.6
5200MHz	23.1	14.2	3.6
5800MHz	21.2	13.1	3.6

4.1.2 Validation Result

System Performance Check at 2450MHz				
Validation Kit: ASL-D-2450-S-2				
Frequency [MHz]	Description	SAR [w/kg] 1g	SAR [w/kg] 10g	Tissue Temp. [°C]
2450 MHz	Reference result ± 10% window	48.07 43.263 to 52.877	25.65 23.085 to 28.215	N/A
	01-Dec-08	49.925	25.886	21.6

Note: All SAR values are normalized to 1W forward power.

System Performance Check at 5200MHz			
Validation Kit: ASL-D-5200-S-2			
Frequency [MHz]	Description	SAR [w/kg] 1g	Tissue Temp. [°C]
5200 MHz	Reference result ± 5% window	58.8 55.86 to 61.74	N/A
	01-Dec-08	56.861	21.6
Note: All SAR values are normalized to 1W forward power.			

System Performance Check at 5800MHz			
Validation Kit: ASL-D-5800-S-2			
Frequency [MHz]	Description	SAR [w/kg] 1g	Tissue Temp. [°C]
5500 MHz	Reference result ± 5% window	57.9 55.005 to 60.795	N/A
	01-Dec-08	63.612	21.6
Note: All SAR values are normalized to 1W forward power.			

4.2 SAR Measurement Procedure

The ALSAS-10U calculates SAR using the following equation,

$$SAR = \frac{\sigma |E|^2}{\rho}$$

σ: represents the simulated tissue conductivity

ρ: represents the tissue density

The EUT is set to transmit at the required power in line with product specification, at each frequency relating to the LOW, MID, and HIGH channel settings.

Pre-scans are made on the device to establish the location for the transmitting antenna,

using a large area scan in either air or tissue simulation fluid.

The EUT is placed against the Universal Phantom where the maximum area scan dimensions are larger than the physical size of the resonating antenna. When the scan size is not large enough to cover the peak SAR distribution, it is modified by either extending the area scan size in both the X and Y directions, or the device is shifted within the predefined area.

The area scan is then run to establish the peak SAR location (interpolated resolution set at 1mm^2) which is then used to orient the center of the zoom scan. The zoom scan is then executed and the 1g and 10g averages are derived from the zoom scan volume (interpolated resolution set at 1mm^3).

5. SAR Exposure Limits

SAR assessments have been made in line with the requirements of IEEE-1528, FCC Supplement C, and comply with ANSI/IEEE C95.1-1992 “Uncontrolled Environments” limits. These limits apply to a location which is deemed as “Uncontrolled Environment” which can be described as a situation where the general public may be exposed to an RF source with no prior knowledge or control over their exposure.

Limits for General Population/Uncontrolled Exposure (W/kg)

Type Exposure	Uncontrolled Environment Limit
Spatial Peak SAR (1g cube tissue for brain or body)	1.60 W/kg
Spatial Average SAR (whole body)	0.08 W/kg
Spatial Peak SAR (10g for hands, feet, ankles and wrist)	4.00 W/kg

6. Test Equipment List

Instrument	Manufacturer	Model No.	Serial No.	Last Calibration	Next Calibration
Data Acquisition Package	Apriel	ALS-DAQ-PAQ-2	QTK-337	Nov. 2006	only once
Apriel Laboratories Probe	Apriel	ALS-E020	265	May. 2008	May. 2009
Apriel Reference Dipole 2450Mhz	Apriel	ALS-D-2450-S-2	QTK-319	May. 2008	May. 2010
Apriel Reference Dipole 5200Mhz	Apriel	ALS-D-5200-S-2	QTK-320	May. 2008	May. 2010
Apriel Reference Dipole 5800Mhz	Apriel	ALS-D-5800-S-2	QTK-321	May. 2008	May. 2010
Boundary Detection Sensor System	Apriel	ALS-PMDPS-2	QTK-336	N/A	N/A
Dielectric Probe Kit	Apriel	ALS-PR-DIEL	QTK-296	N/A	N/A
Universal Work Station	Apriel	ALS-UWS	QTK-326	N/A	N/A
Device Holder 2.0	Apriel	ALS-H-E-SET-2	QTK-294	N/A	N/A
Left Ear SAM Phantom	Apriel	ALS-P-SAM-L	QTK-292	N/A	N/A
Right Ear SAM Phantom	Apriel	ALS-P-SAM-R	QTK-288	N/A	N/A
Universal Phantom	Apriel	ALS-P-UP-1	QTK-246	N/A	N/A
Apriel Dipole Spacer	Apriel	ALS-DS-U	QTK-295	N/A	N/A
SAR Software	Apriel	ALSAS-10	Ver. 2.3.6	N/A	N/A
CRS C500C Controller	Thermo	ALS-C500	RCF0404433	N/A	N/A
CRF F3 Robot	Thermo	ALS-F3	RAF0412222	N/A	N/A
Power Amplifier	Mini-Circuit	ZHL-42	D051404-20	N/A	N/A
Directional Coupler	Agilent	778D-012	50550	N/A	N/A
Universal Radio Communication Tester	Rohde & Schwarz	CMU 200	104846	Mar. 2008	Mar. 2009
Vector Network	Anritsu	MS4623B	992801	Aug. 2008	Aug. 2009
Signal Generator	Anritsu	MG3692A	042319	Jun. 2008	Jun. 2009
Power Meter	Anritsu	ML2487A	6K00001447	Apr. 2008	Apr. 2009
Wide Bandwidth Sensor	Anritsu	MA2491	030677	Apr. 2008	Apr. 2009

7. Measurement Uncertainty

Exposure Assessment Measurement Uncertainty

Source of Uncertainty	Tolerance Value	Probability Distribution	Divisor	c_1^* (1-g)	c_1^* (10-g)	Standard Uncertainty (1-g) %	Standard Uncertainty (10-g) %
Measurement System							
Probe Calibration	3.5	normal	1	1	1	3.5	3.5
Axial Isotropy	3.7	rectangular	$\sqrt{3}$	$(1-cp)^{1/2}$	$(1-cp)^{1/2}$	1.5	1.5
Hemispherical Isotropy	10.9	rectangular	$\sqrt{3}$	\sqrt{cp}	\sqrt{cp}	4.4	4.4
Boundary Effect	1.0	rectangular	$\sqrt{3}$	1	1	0.6	0.6
Linearity	4.7	rectangular	$\sqrt{3}$	1	1	2.7	2.7
Detection Limit	1.0	rectangular	$\sqrt{3}$	1	1	0.6	0.6
Readout Electronics	1.0	normal	1	1	1	1.0	1.0
Response Time	0.9	rectangular	$\sqrt{3}$	1	1	0.5	0.5
Integration Time	1.7	rectangular	$\sqrt{3}$	1	1	1.0	1.0
RF Ambient Condition	3.0	rectangular	$\sqrt{3}$	1	1	1.7	1.7
Probe Positioner Mech.	0.4	rectangular	$\sqrt{3}$	1	1	0.2	0.2
Restriction							
Probe Positioning with respect to Phantom Shell	2.9	rectangular	$\sqrt{3}$	1	1	1.7	1.7
Extrapolation and Integration	3.7	rectangular	$\sqrt{3}$	1	1	2.1	2.1
Test Sample Positioning	4.0	normal	1	1	1	4.0	4.0
Device Holder Uncertainty	2.0	normal	1	1	1	2.0	2.0
Drift of Output Power	4.7	rectangular	$\sqrt{3}$	1	1	2.7	2.7
Phantom and Setup							
Phantom Uncertainty(shape & thickness tolerance)	3.4	rectangular	$\sqrt{3}$	1	1	2.0	2.0
Liquid Conductivity(target)	5.0	rectangular	$\sqrt{3}$	0.7	0.5	2.0	1.4
Liquid Conductivity(meas.)	0.1	normal	1	0.7	0.5	0.1	0.0
Liquid Permittivity(target)	2.0	rectangular	$\sqrt{3}$	0.6	0.5	0.7	0.6
Liquid Permittivity(meas.)	2.6	normal	1	0.6	0.5	1.6	1.3
Combined Uncertainty		RSS				9.6	9.5
Combined Uncertainty (coverage factor=2)		Normal (k=2)				19.3	18.9

8. Test Results

8.1 SAR Test Results Summary

SAR MEASUREMENT						
Ambient Temperature (°C) : 22.5 ±2				Relative Humidity (%) : 54		
Liquid Temperature (°C) : 21.6 ±2				Depth of Liquid (cm) : >15		
Product: NoteBook PC						
Test Mode: 802.11b- Tx3 Antenna						
Test Position Body	Antenna Position	Frequency		Conducted Power (dBm)	SAR 1g (W/kg)	Limit (W/kg)
		Channel	MHz			
Bottom	Fixed	1	2412	16.40	0.176	1.6
Bottom	Fixed	6	2437	15.51	0.236	1.6
Bottom	Fixed	11	2462	17.32	0.178	1.6
Test Mode: 802.11g- Tx3 Antenna						
Bottom	Fixed	1	2412	14.70	**	1.6
Bottom	Fixed	6	2437	15.11	0.099	1.6
Bottom	Fixed	11	2462	14.05	**	1.6
Test Mode: 802.11n(20M) - Tx3 Antenna						
Bottom	Fixed	6	2437	13.16	0.214	1.6
Test Mode: 802.11n(40M) - Tx3 Antenna						
Bottom	Fixed	6	2437	12.55	0.192	1.6

SAR MEASUREMENT						
Ambient Temperature (°C) : 22.5 ±2			Relative Humidity (%): 54			
Liquid Temperature (°C) : 21.6 ±2			Depth of Liquid (cm):>15			
Product: NoteBook PC						
Test Mode: 802.11a, 5200 MHz- Tx3 Antenna						
Test Position Body	Antenna Position	Frequency		Conducted Power (dBm)	SAR 1g (W/kg)	Limit (W/kg)
		Channel	MHz			
Bottom	Fixed	36	5180	14.54	0.346	1.6
Bottom	Fixed	44	5220	16.32	0.376	1.6
Bottom	Fixed	52	5260	15.26	0.267	1.6
Bottom	Fixed	64	5320	15.32	0.210	1.6
Test Mode: 802.11n(20M), 5200 MHz - Tx3 Antenna						
Bottom	Fixed	44	5220	16.06	0.283	1.6
Test Mode: 802.11n(40M), 5200 MHz - Tx3 Antenna						
Bottom	Fixed	46	5230	12.38	0.280	1.6

SAR MEASUREMENT						
Ambient Temperature (°C) : 22.5 ±2			Relative Humidity (%): 54			
Liquid Temperature (°C) : 21.6 ±2			Depth of Liquid (cm):>15			
Product: NoteBook PC						
Test Mode: 802.11a, 5800 MHz- Tx3 Antenna						
Test Position Body	Antenna Position	Frequency		Conducted Power (dBm)	SAR 1g (W/kg)	Limit (W/kg)
		Channel	MHz			
Bottom	Fixed	100	5500	15.02	0.282	1.6
Bottom	Fixed	120	5600	15.40	0.325	1.6
Bottom	Fixed	140	5700	16.03	0.445	1.6
Bottom	Fixed	149	5745	13.89	0.322	1.6
Bottom	Fixed	157	5785	16.87	0.370	1.6
Bottom	Fixed	165	5825	13.46	0.265	1.6
Test Mode: 802.11n(20M), 5800 MHz - Tx3 Antenna						
Bottom	Fixed	140	5700	15.59	0.305	1.6
Test Mode: 802.11n(40M), 5800 MHz - Tx3 Antenna						
Bottom	Fixed	137	5670	12.46	0.328	1.6

Test Mode: 802.11a, 5800 MHz – Tx1 Antenna						
Bottom	Fixed	140	5700	16.13	0.323	1.6
Test Mode: 802.11a, 5800 MHz – Tx2 Antenna						
Bottom	Fixed	140	5700	15.84	0.354	1.6
Note : After evaluated single, dual and triple transmit, the worst case was found on single Tx3.						

Appendix**Appendix A. SAR System Validation Data****Appendix B. SAR measurement Data****Appendix C. Test Setup Photographs & EUT Photographs****Appendix D. Probe Calibration Data****Appendix E. Dipole Calibration Data**

Appendix A. SAR System Validation Data

ALSAS-10U VER 2.3.6 APREL Laboratories

SAR Test Report

Report Date : 01-Dec-2008
Measurement Date : 01-Dec-2008

Product Data

Device Name : Dipole-2450
Type : Dipole
Frequency : 2450.00 MHz
Max. Transmit Pwr : 1 W
Drift Time : 0 min(s)
Length : 51.5 mm
Width : 3.6 mm
Depth : 30.4 mm
Power Drift-Start : 25.254 W/kg
Power Drift-Finish: 25.951 W/kg
Power Drift (%) : 2.759

Phantom Data

Type : Uni-Phantom
Size (mm) : 280 x 280 x 200
Location : Center

Tissue Data

Type : HEAD
Serial No. : 325-H
Frequency : 2450.00 MHz
Last Calib. Date : 01-Dec-2008
Temperature : 21.60 °C
Ambient Temp. : 22.50 °C
Humidity : 54.00 RH%
Epsilon : 40.94 F/m
Sigma : 1.81 S/m
Density : 1000.00 kg/cu. m

Probe Data

Name : Probe 265
Model : E020
Type : E-Field Triangle
Serial No. : 265
Last Calib. Date : 09-May-2008
Frequency : 2450.00 MHz
Duty Cycle Factor: 1
Conversion Factor: 3.55
Probe Sensitivity: 1.20 1.20 1.20 $\mu\text{V}/(\text{V}/\text{m})^2$
Compression Point: 95.00 mV
Offset : 1.56 mm

Measurement Data

Crest Factor : 1
Tissue Temp. : 21.60 °C
Ambient Temp. : 22.50 °C
Area Scan : 5x7x1 : Measurement x=12mm, y=12mm, z=4mm
Zoom Scan : 7x7x7 : Measurement x=5mm, y=5mm, z=5mm
Frequency : 2450 MHz

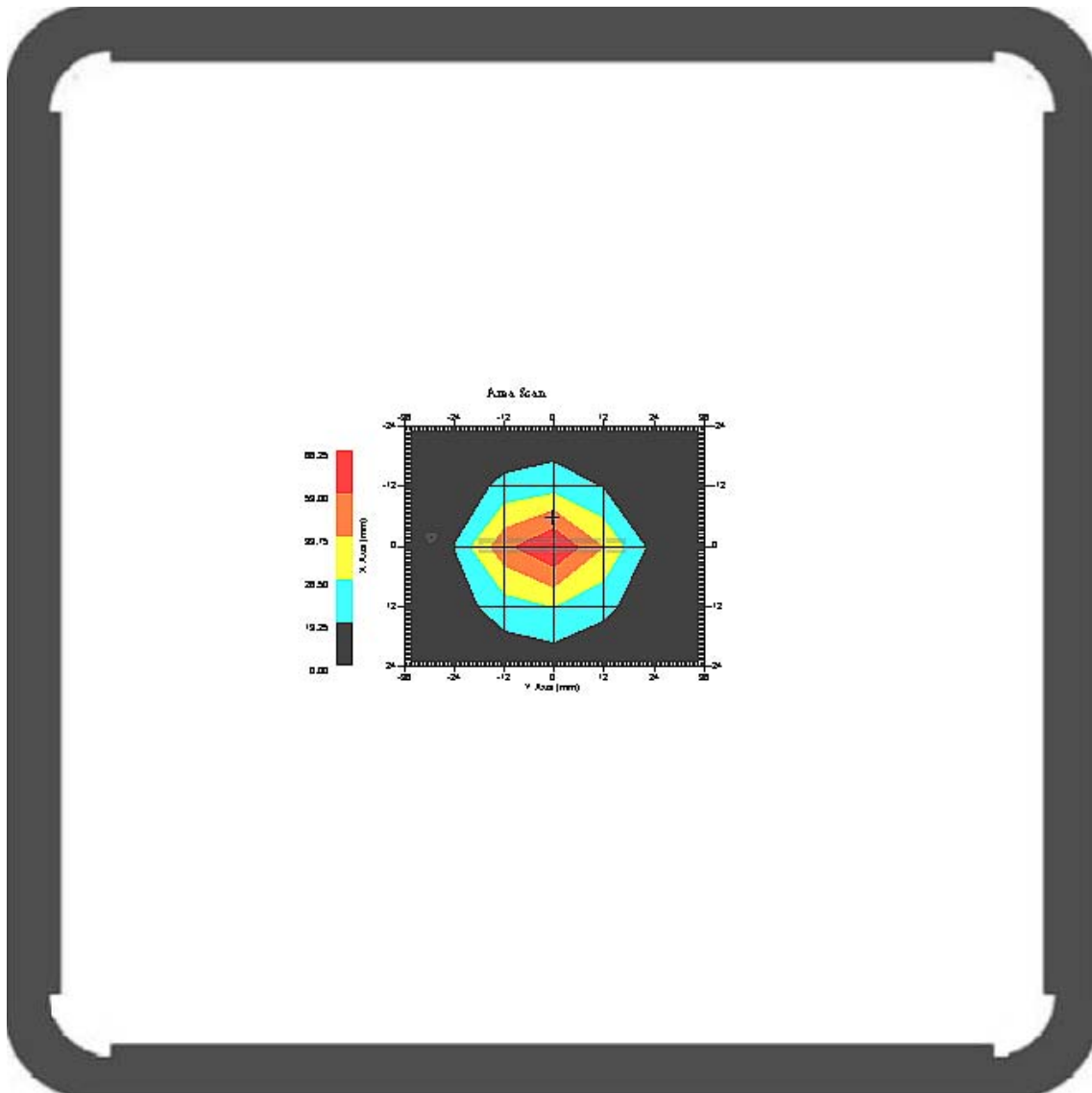

1 gram SAR value : 49.925 W/kg
10 gram SAR value : 25.886 W/kg
Area Scan Peak SAR : 66.251 W/kg
Zoom Scan Peak SAR : 110.958 W/kg

This is previous page plot (zoom in)

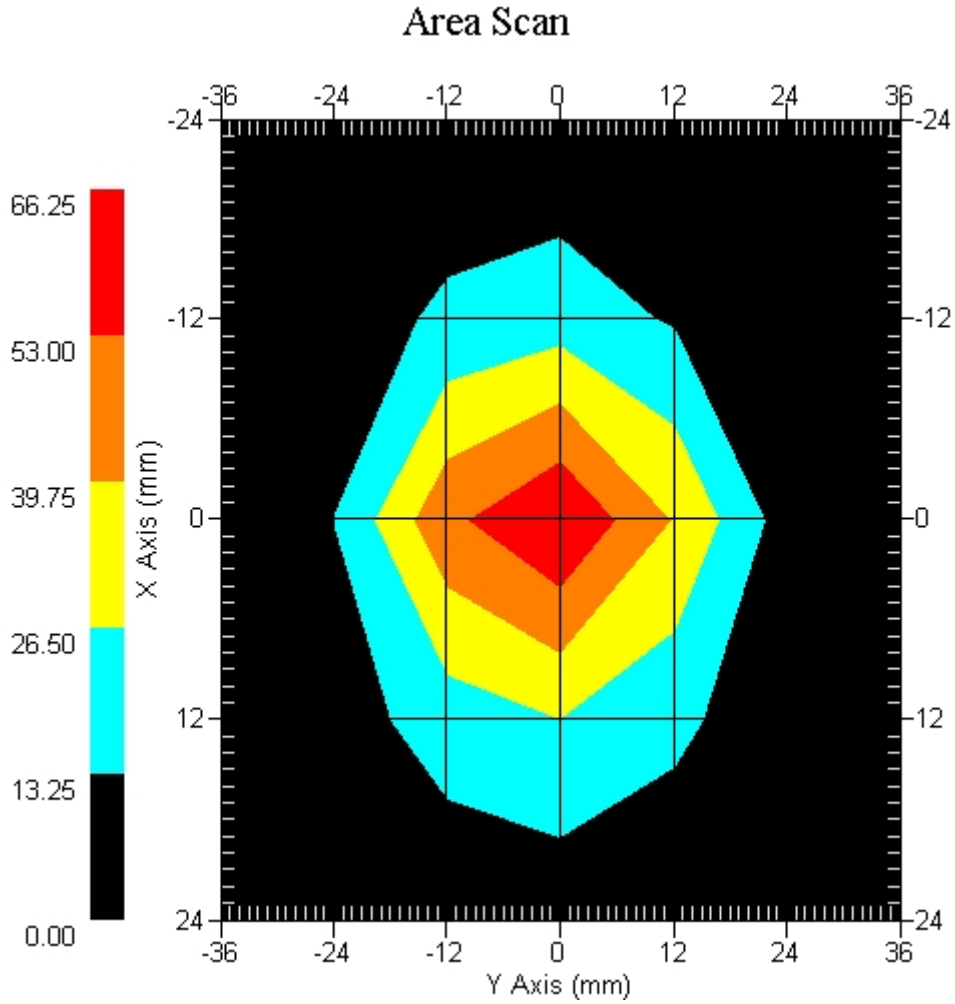

SAR-Z Axis
at Hotspot x:0.03 y:-0.01

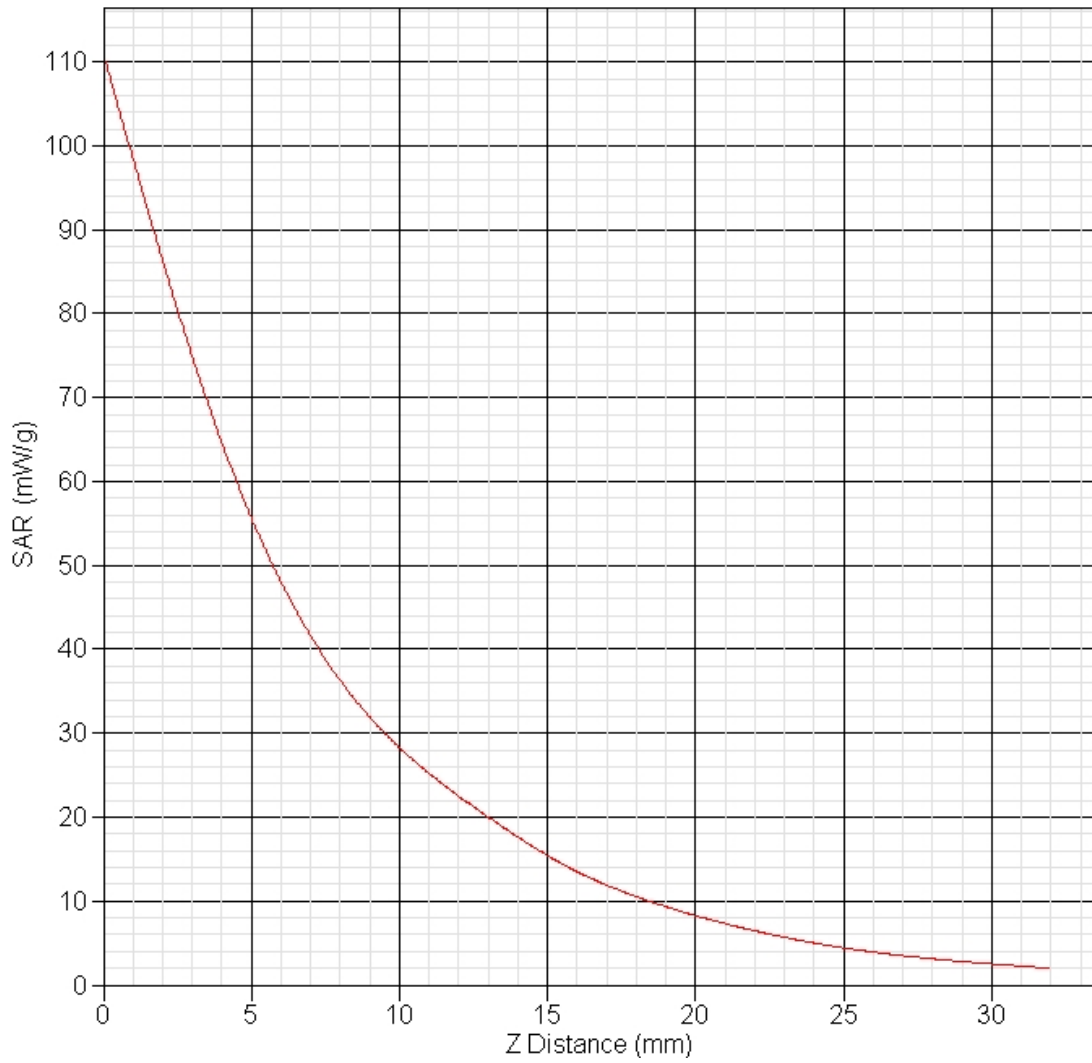

ALSAS-10U VER 2.3.6 APREL Laboratories

SAR Test Report

Report Date : 01-Dec-2008
Measurement Date : 01-Dec-2008

Product Data

Device Name : Dipole-5200
Type : Dipole
Frequency : 5200.00 MHz
Max. Transmit Pwr : 1 W
Drift Time : 0 min(s)
Length : 23 mm
Width : 3.6 mm
Depth : 89.8 mm
Power Drift-Start : 30.887 W/kg
Power Drift-Finish: 30.307 W/kg
Power Drift (%) : -1.878

Phantom Data

Type : Uni-Phantom
Size (mm) : 280 x 280 x 200
Location : Center

Tissue Data

Type : HEAD
Serial No. : 326-H
Frequency : 5200.00 MHz
Last Calib. Date : 01-Dec-2008
Temperature : 21.60 °C
Ambient Temp. : 22.50 °C
Humidity : 54.00 RH%
Epsilon : 39.71 F/m
Sigma : 53.46 S/m
Density : 1000.00 kg/cu. m

Probe Data

Name : Probe 265
Model : E020
Type : E-Field Triangle
Serial No. : 265
Last Calib. Date : 09-May-2008
Frequency : 5200.00 MHz
Duty Cycle Factor: 1
Conversion Factor: 3.5
Probe Sensitivity: 1.20 1.20 1.20 $\mu\text{V}/(\text{V}/\text{m})^2$
Compression Point: 95.00 mV
Offset : 1.56 mm

Measurement Data

Crest Factor : 1
Tissue Temp. : 21.60 °C
Ambient Temp. : 22.50 °C
Area Scan : 5x6x1 : Measurement x=12mm, y=12mm, z=4mm
Zoom Scan : 7x7x7 : Measurement x=5mm, y=5mm, z=5mm
Frequency : 5200 MHz

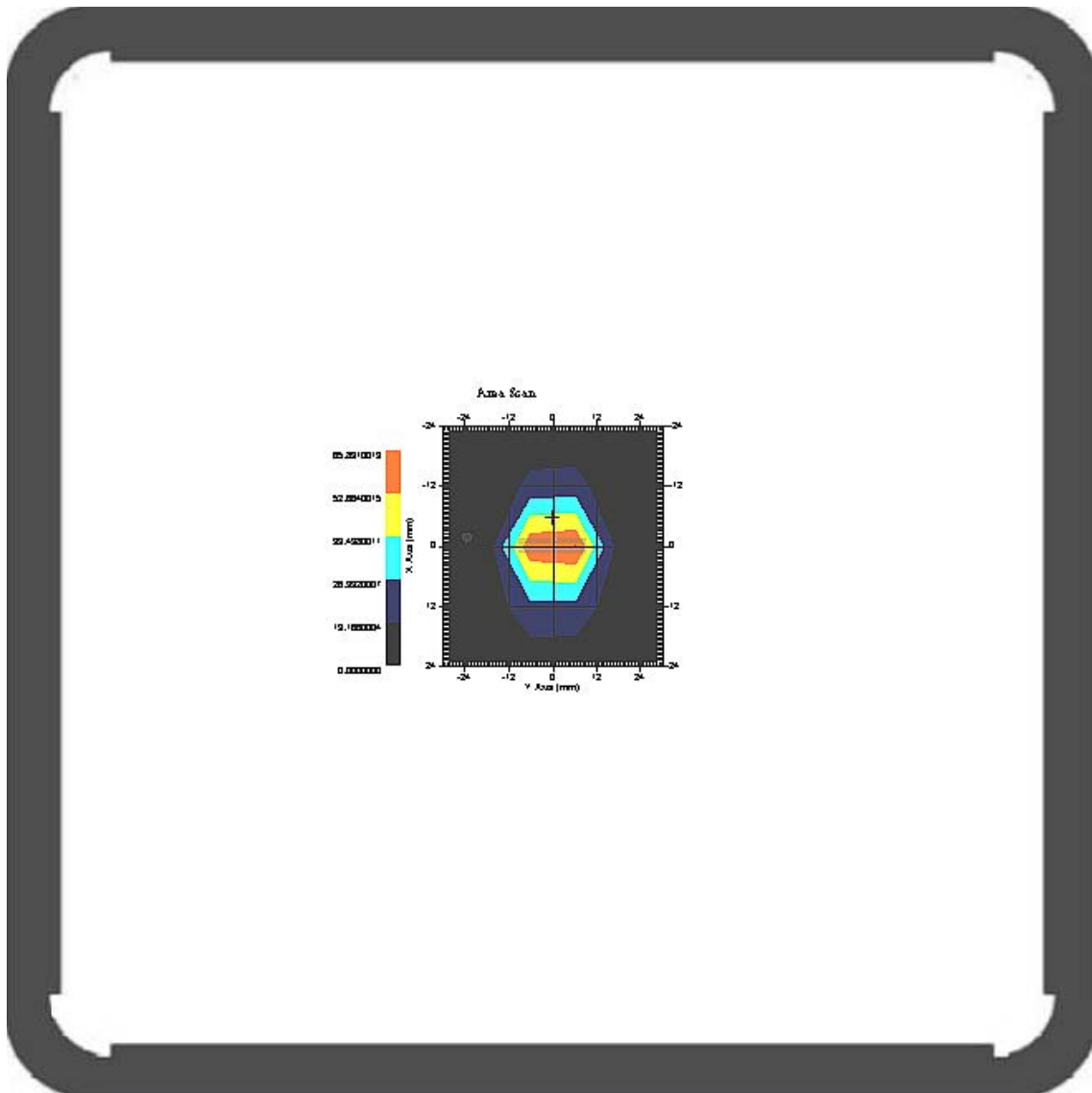

1 gram SAR value : 56.861 W/kg
10 gram SAR value : 21.690 W/kg
Area Scan Peak SAR : 65.829 W/kg
Zoom Scan Peak SAR : 190.152 W/kg

This is previous page plot (zoom in)

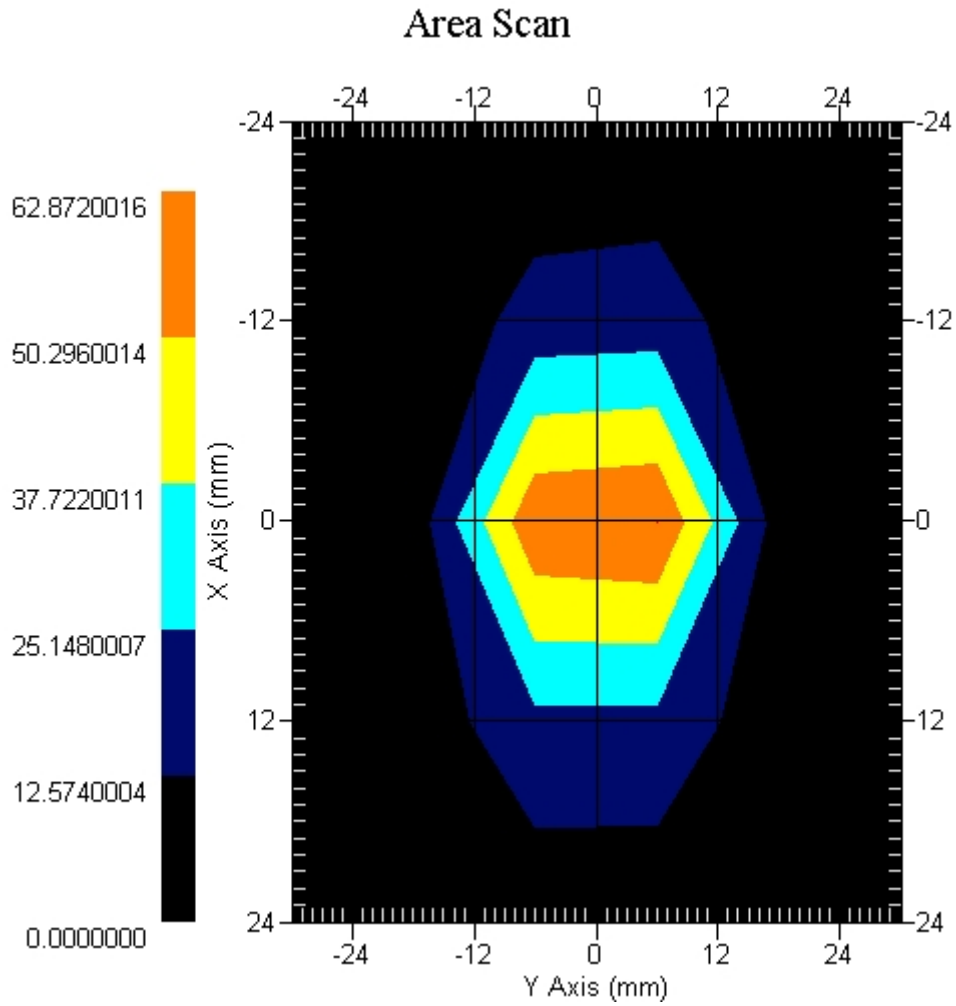

SAR-Z Axis
at Hotspot x:0.07 y:-2.01

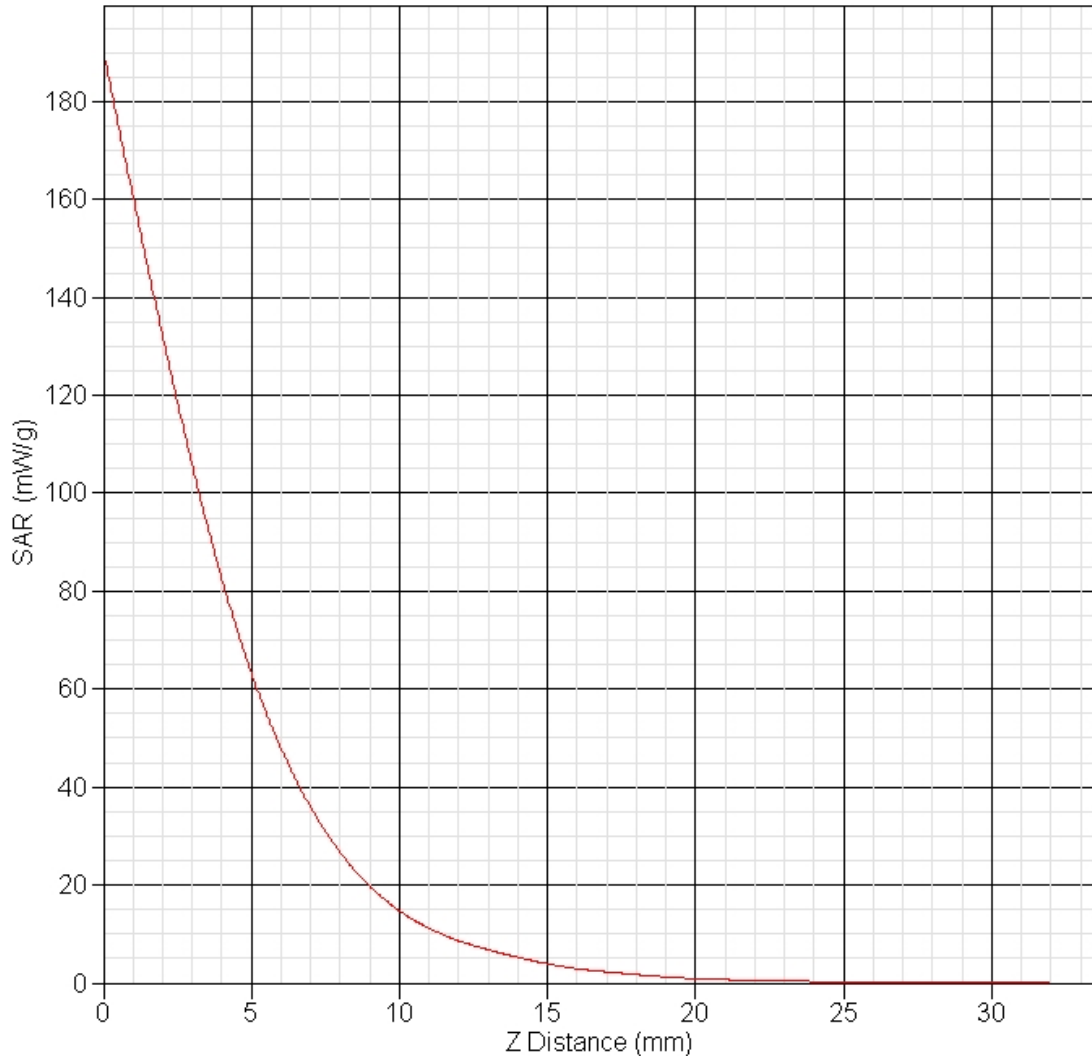

ALSAS-10U VER 2.3.6 APREL Laboratories

SAR Test Report

Report Date : 01-Dec-2008
Measurement Date : 01-Dec-2008

Product Data

Device Name : Dipole-5800
Type : Dipole
Frequency : 5800.00 MHz
Max. Transmit Pwr : 1 W
Drift Time : 0 min(s)
Length : 21.4 mm
Width : 3.6 mm
Depth : 89.8 mm
Power Drift-Start : 29.565 W/kg
Power Drift-Finish: 30.066 W/kg
Power Drift (%) : 1.964

Phantom Data

Type : Uni-Phantom
Size (mm) : 280 x 280 x 200
Location : Center

Tissue Data

Type : HEAD
Serial No. : 327-H
Frequency : 5800.00 MHz
Last Calib. Date : 01-Dec-2008
Temperature : 21.60 °C
Ambient Temp. : 22.50 °C
Humidity : 54.00 RH%
Epsilon : 35.19 F/m
Sigma : 6.35 S/m
Density : 1000.00 kg/cu. m

Probe Data

Name : Probe 265
Model : E020
Type : E-Field Triangle
Serial No. : 265
Last Calib. Date : 09-May-2008
Frequency : 5800.00 MHz
Duty Cycle Factor: 1
Conversion Factor: 3.4
Probe Sensitivity: 1.20 1.20 1.20 $\mu\text{V}/(\text{V}/\text{m})^2$
Compression Point: 95.00 mV
Offset : 1.56 mm

Measurement Data

Crest Factor : 1
Temperature : 21.60 °C
Ambient Temp. : 22.50 °C
Area Scan : 5x6x1 : Measurement x=12mm, y=12mm, z=4mm
Zoom Scan : 7x7x7 : Measurement x=5mm, y=5mm, z=5mm
Frequency : 5800 MHz

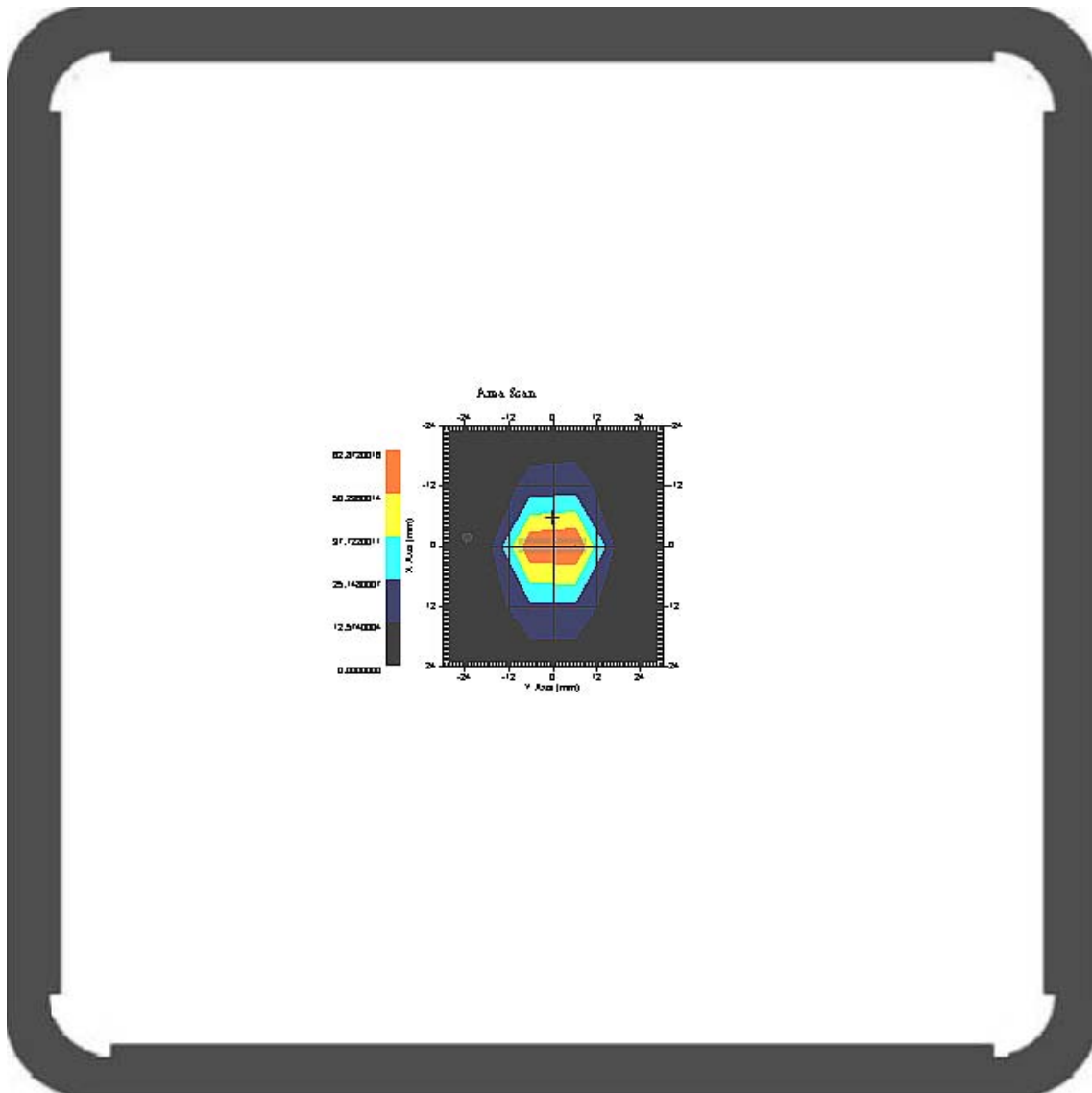

1 gram SAR value : 63.612 W/kg
10 gram SAR value : 21.873 W/kg
Area Scan Peak SAR : 62.870 W/kg
Zoom Scan Peak SAR : 192.159 W/kg

This is previous page plot (zoom in)

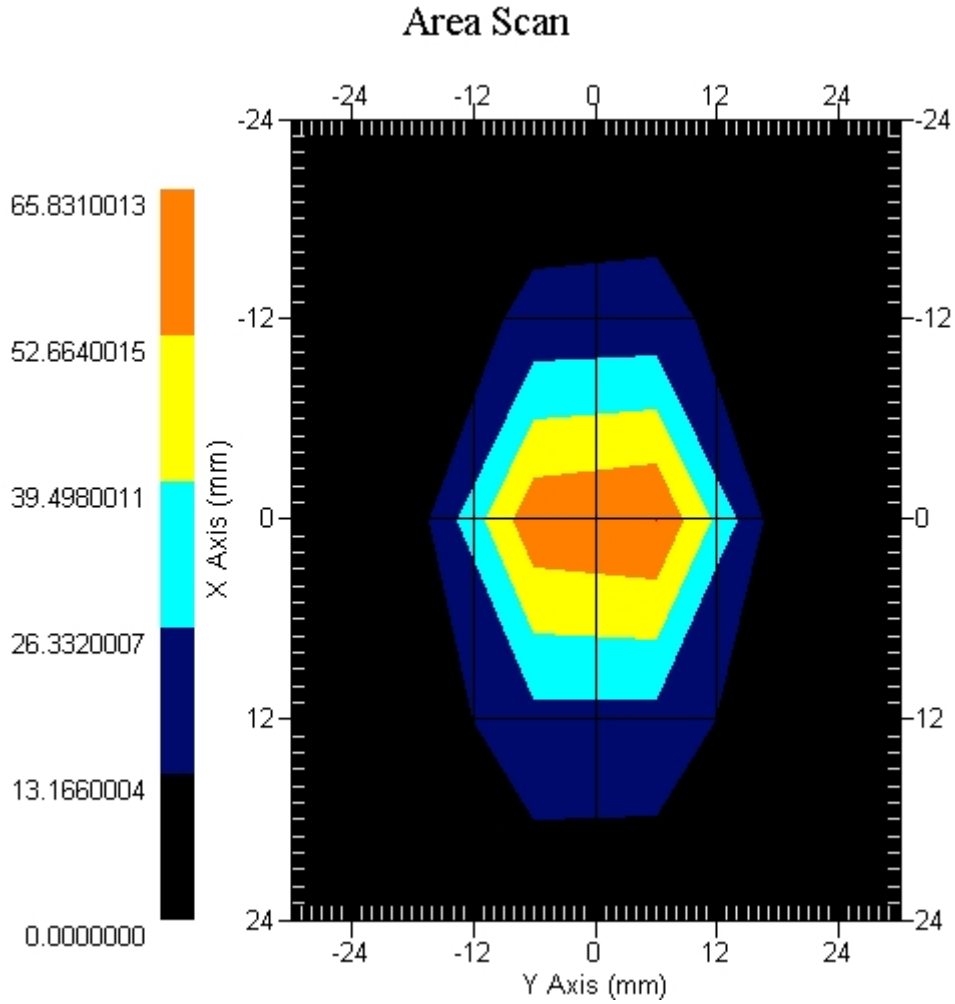

SAR-Z Axis
at Hotspot x:0.14 y:-2.01

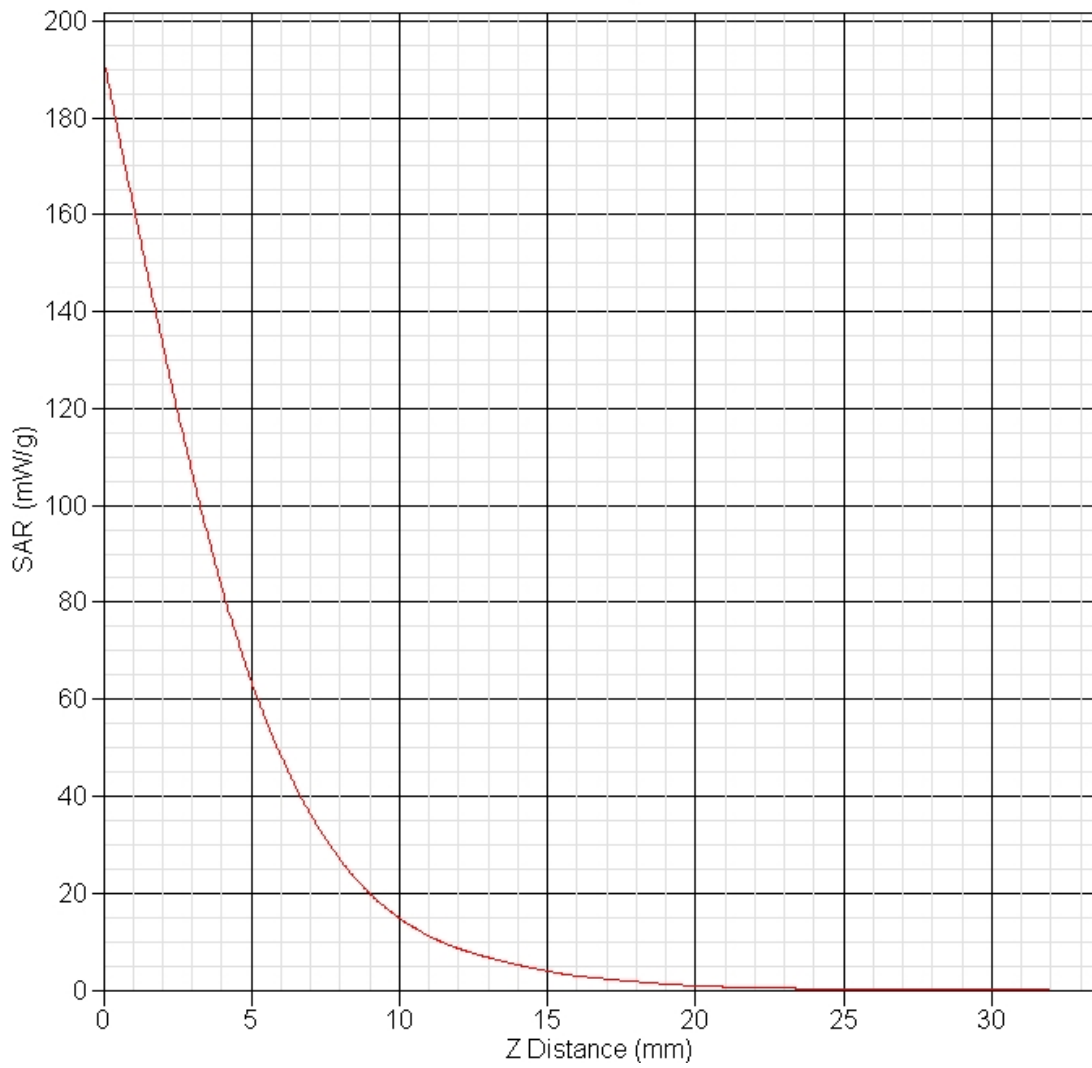

Appendix B. SAR measurement Data

ALSAS-10U VER 2.3.6 APREL Laboratories

SAR Test Report –Test Mode: 802.11b- Tx3 Antenna

Report Date : 01-Dec-2008
Measurement Date : 01-Dec-2008

Product Data

Device Name : NoteBook PC
Type : Other
Model : 9212XY
Frequency : 2450.00 MHz
Drift Time : 0 min(s)
Length : 296 mm
Width : 210 mm
Depth : 231 mm
Antenna Type : Internal

Phantom Data

Type : Uni-Phantom
Size (mm) : 280 x 280 x 200
Location : Center

Tissue Data

Type : BODY
Serial No. : 325-B
Frequency : 2450.00 MHz
Last Calib. Date : 01-Dec-2008
Temperature : 21.60 °C
Ambient Temp. : 22.50 °C
Humidity : 54.00 RH%
Epsilon : 54.25 F/m
Sigma : 1.97 S/m
Density : 1000.00 kg/cu. m

Probe Data

Name : Probe 265
Model : E020
Type : E-Field Triangle
Serial No. : 265
Last Calib. Date : 09-May-2008
Frequency : 2450.00 MHz
Duty Cycle Factor: 1
Conversion Factor: 3.55
Probe Sensitivity: 1.20 1.20 1.20 $\mu\text{V}/(\text{V}/\text{m})^2$
Compression Point: 95.00 mV
Offset : 1.56 mm

Measurement Data

Crest Factor : 1
Tissue Temp. : 21.60 °C
Ambient Temp. : 22.50 °C
Area Scan : 5x5x1 : Measurement x=12mm, y=12mm, z=4mm
Zoom Scan : 5x5x8 : Measurement x=8mm, y=8mm, z=4mm
Power Drift-Start : 0.035 W/kg
Power Drift-Finish: 0.035 W/kg
Power Drift (%) : 0.661

DUT Position : Touch
Channel : 1

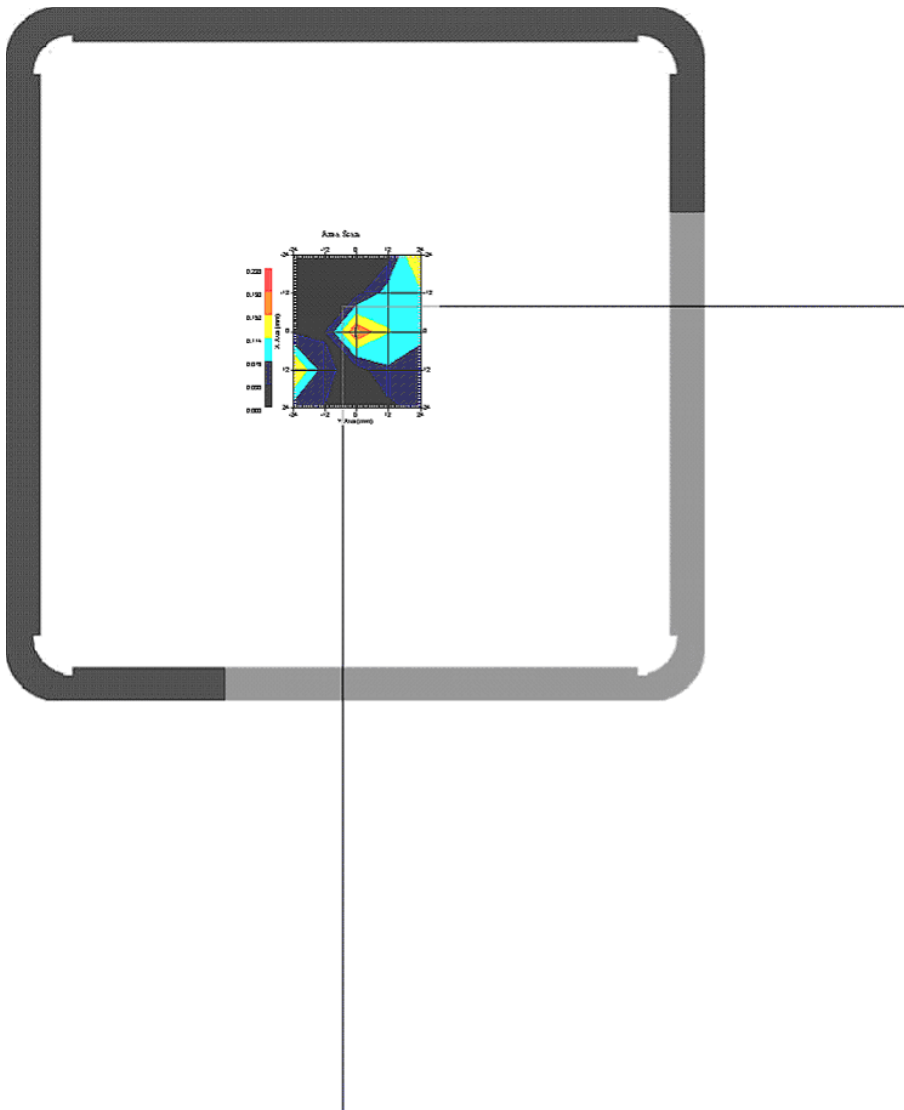

1 gram SAR value : 0.176 W/kg
10 gram SAR value : 0.090 W/kg
Area Scan Peak SAR : 0.191 W/kg
Zoom Scan Peak SAR : 0.230 W/kg

This is previous page plot (zoom in)

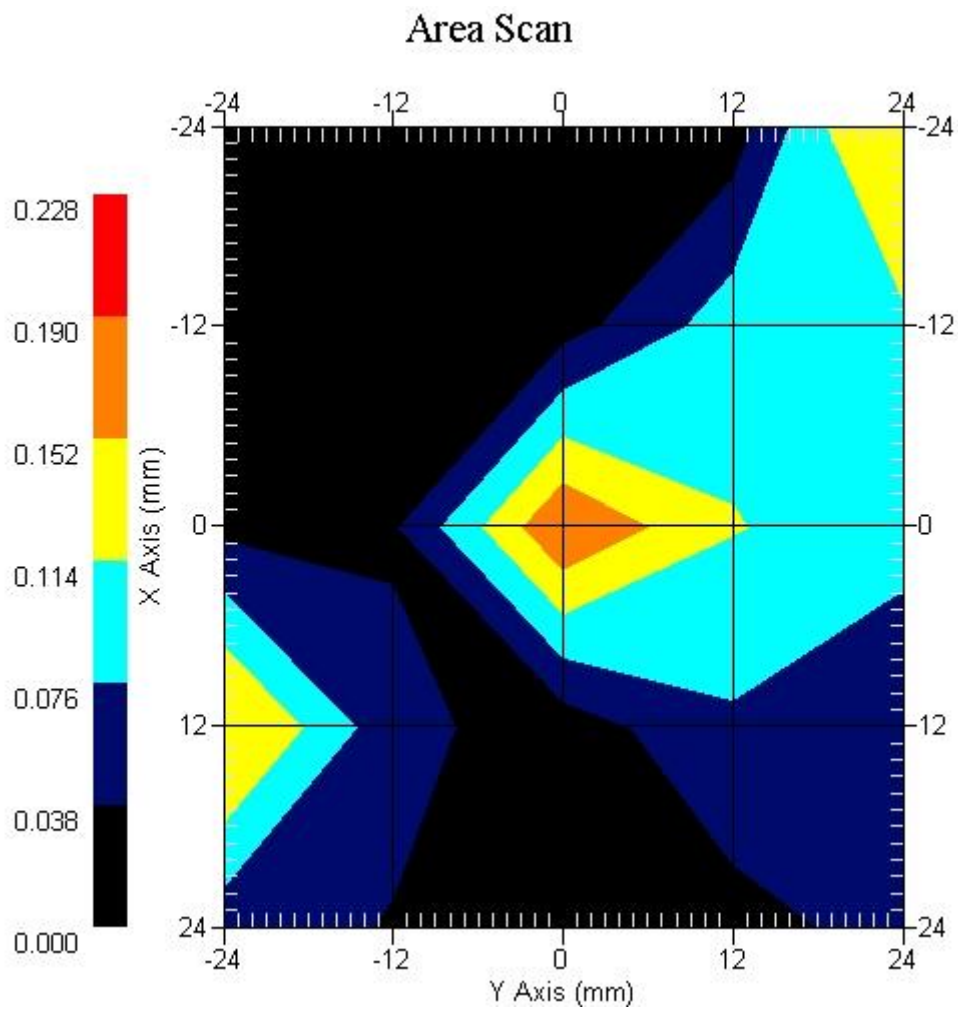

Measurement Data

Crest Factor : 1
Tissue Temp. : 21.60 °C
Ambient Temp. : 22.50 °C
Area Scan : 5x5x1 : Measurement x=12mm, y=12mm, z=4mm
Zoom Scan : 5x5x8 : Measurement x=8mm, y=8mm, z=4mm
Power Drift-Start : 0.029 W/kg
Power Drift-Finish: 0.029 W/kg
Power Drift (%) : -0.536

DUT Position : Touch
Channel : 6

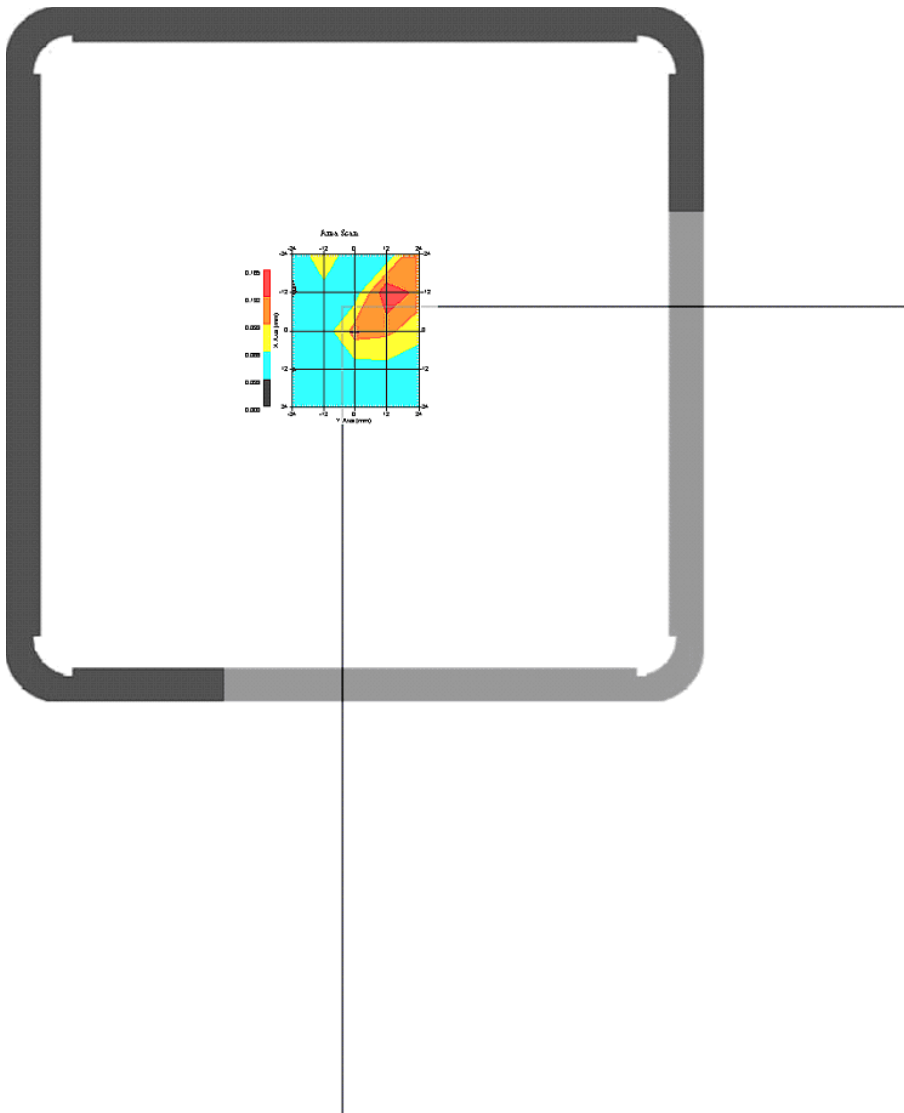

1 gram SAR value : 0.236 W/kg
10 gram SAR value : 0.154 W/kg
Area Scan Peak SAR : 0.165 W/kg
Zoom Scan Peak SAR : 0.590 W/kg

This is previous page plot (zoom in)

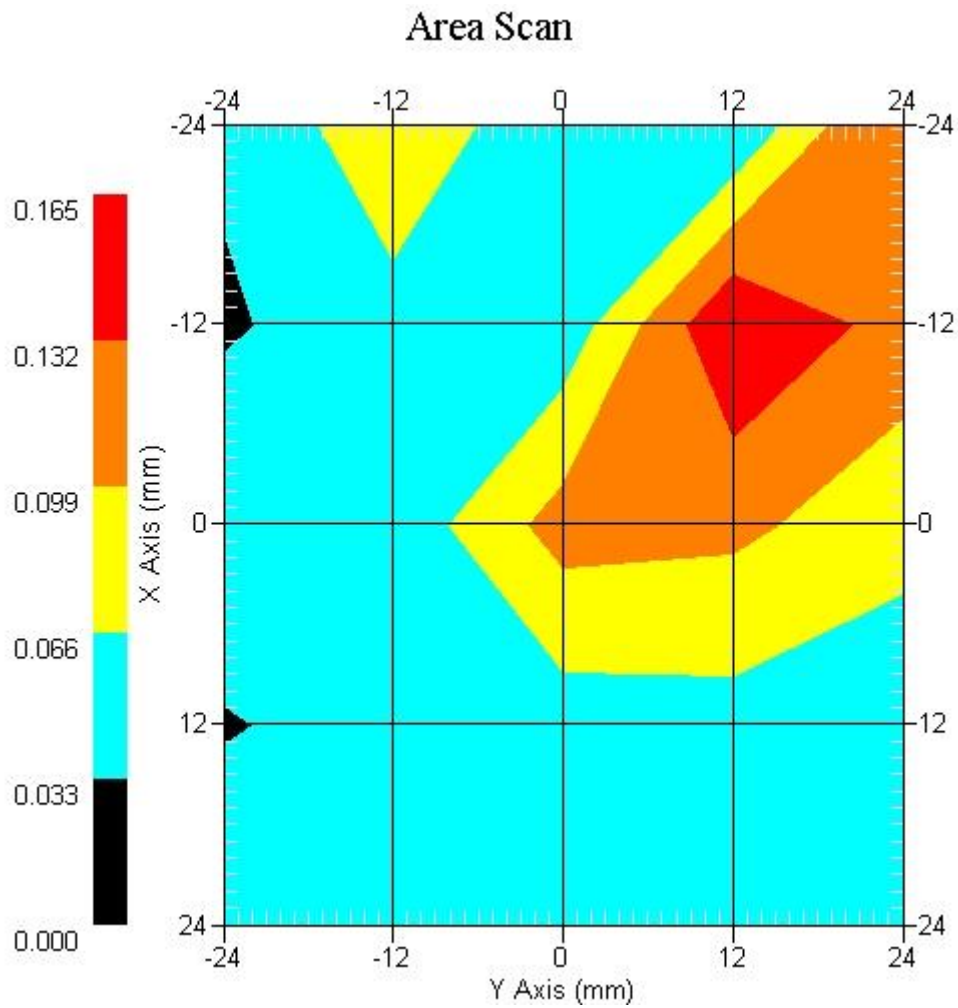

Measurement Data

Crest Factor : 1
Tissue Temp. : 21.60 °C
Ambient Temp. : 22.50 °C
Area Scan : 5x5x1 : Measurement x=12mm, y=12mm, z=4mm
Zoom Scan : 5x5x8 : Measurement x=8mm, y=8mm, z=4mm
Power Drift-Start : 0.023 W/kg
Power Drift-Finish: 0.023 W/kg
Power Drift (%) : 0.630

DUT Position : Touch
Channel : 11

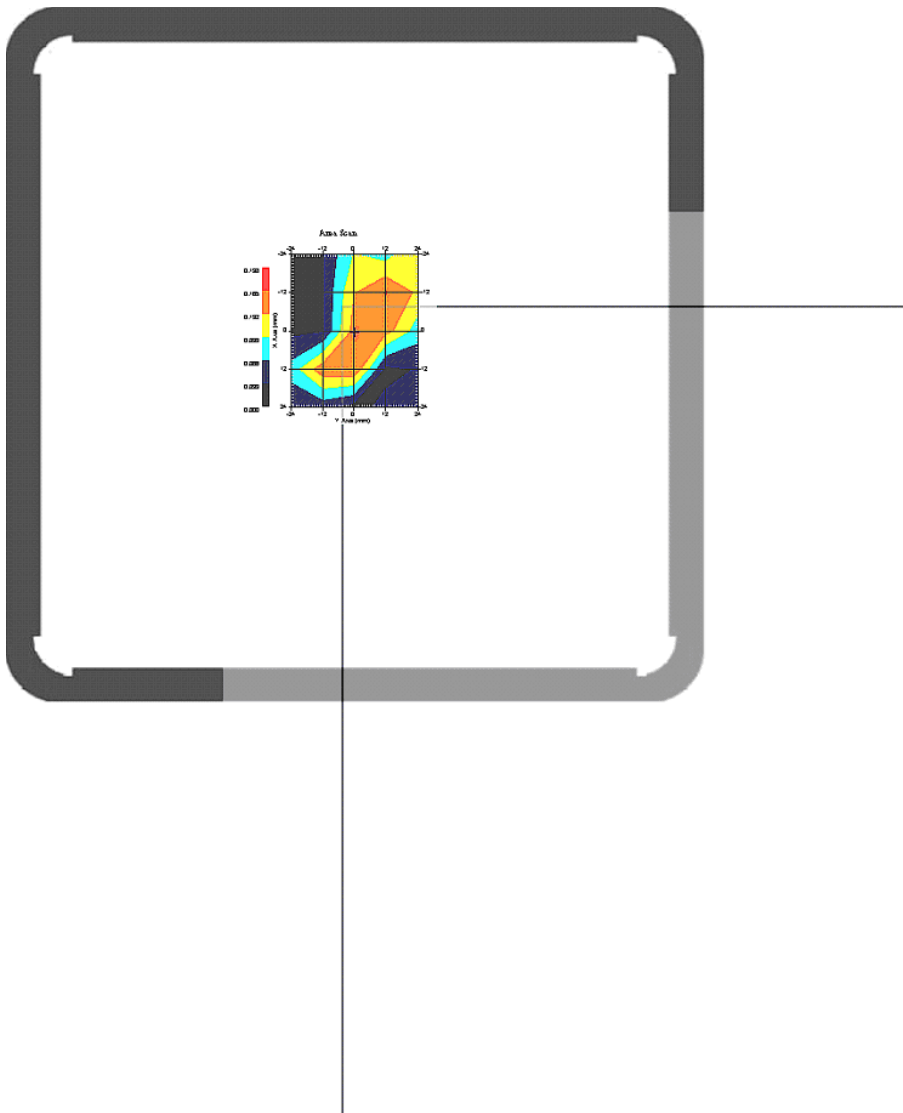

1 gram SAR value : 0.178 W/kg
10 gram SAR value : 0.111 W/kg
Area Scan Peak SAR : 0.167 W/kg
Zoom Scan Peak SAR : 0.350 W/kg

This is previous page plot (zoom in)

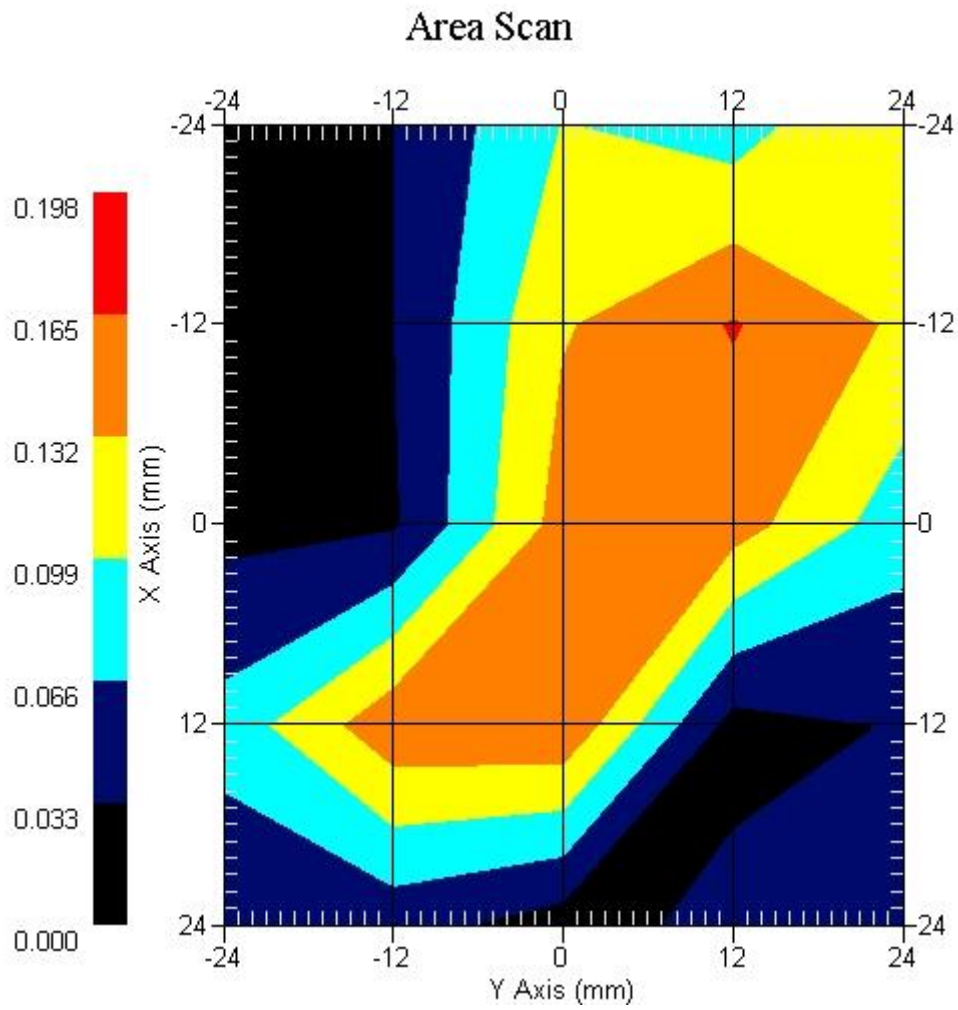

ALSAS-10U VER 2.3.6 APREL Laboratories
SAR Test Report –802.11g- Tx3 AntennaReport Date : 01-Dec-2008
Measurement Date : 01-Dec-2008

Product Data

Device Name : NoteBook PC
Type : Other
Model : 9212XY
Frequency : 2450.00 MHz
Drift Time : 0 min(s)
Length : 296 mm
Width : 210 mm
Depth : 231 mm
Antenna Type : Internal

Phantom Data

Type : Uni-Phantom
Size (mm) : 280 x 280 x 200
Location : Center

Tissue Data

Type : BODY
Serial No. : 325-B
Frequency : 2450.00 MHz
Last Calib. Date : 01-Dec-2008
Temperature : 21.60 °C
Ambient Temp. : 22.50 °C
Humidity : 54.00 RH%
Epsilon : 54.25 F/m
Sigma : 1.97 S/m
Density : 1000.00 kg/cu. m

Probe Data

Name : Probe 265
Model : E020
Type : E-Field Triangle
Serial No. : 265
Last Calib. Date : 09-May-2008
Frequency : 2450.00 MHz
Duty Cycle Factor: 1
Conversion Factor: 3.55
Probe Sensitivity: 1.20 1.20 1.20 $\mu\text{V}/(\text{V}/\text{m})^2$
Compression Point: 95.00 mV
Offset : 1.56 mm

Measurement Data

Crest Factor : 1
Tissue Temp. : 21.60 °C
Ambient Temp. : 22.50 °C
Area Scan : 5x5x1 : Measurement x=12mm, y=12mm, z=4mm
Zoom Scan : 5x5x8 : Measurement x=8mm, y=8mm, z=4mm
Power Drift-Start : 0.037 W/kg
Power Drift-Finish: 0.037 W/kg
Power Drift (%) : -0.870

DUT Position : Touch
Channel : 6

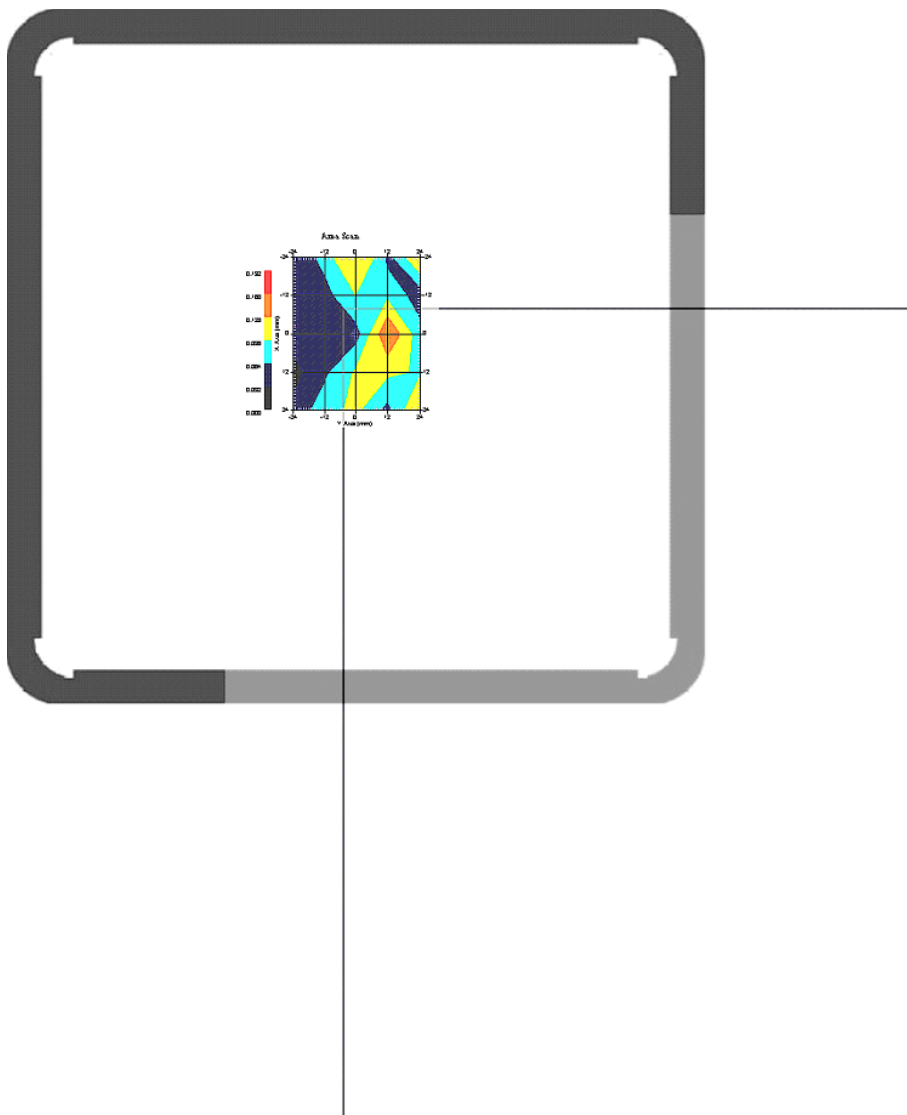

1 gram SAR value : 0.099 W/kg
10 gram SAR value : 0.061 W/kg
Area Scan Peak SAR : 0.161 W/kg
Zoom Scan Peak SAR : 0.180 W/kg

This is previous page plot (zoom in)

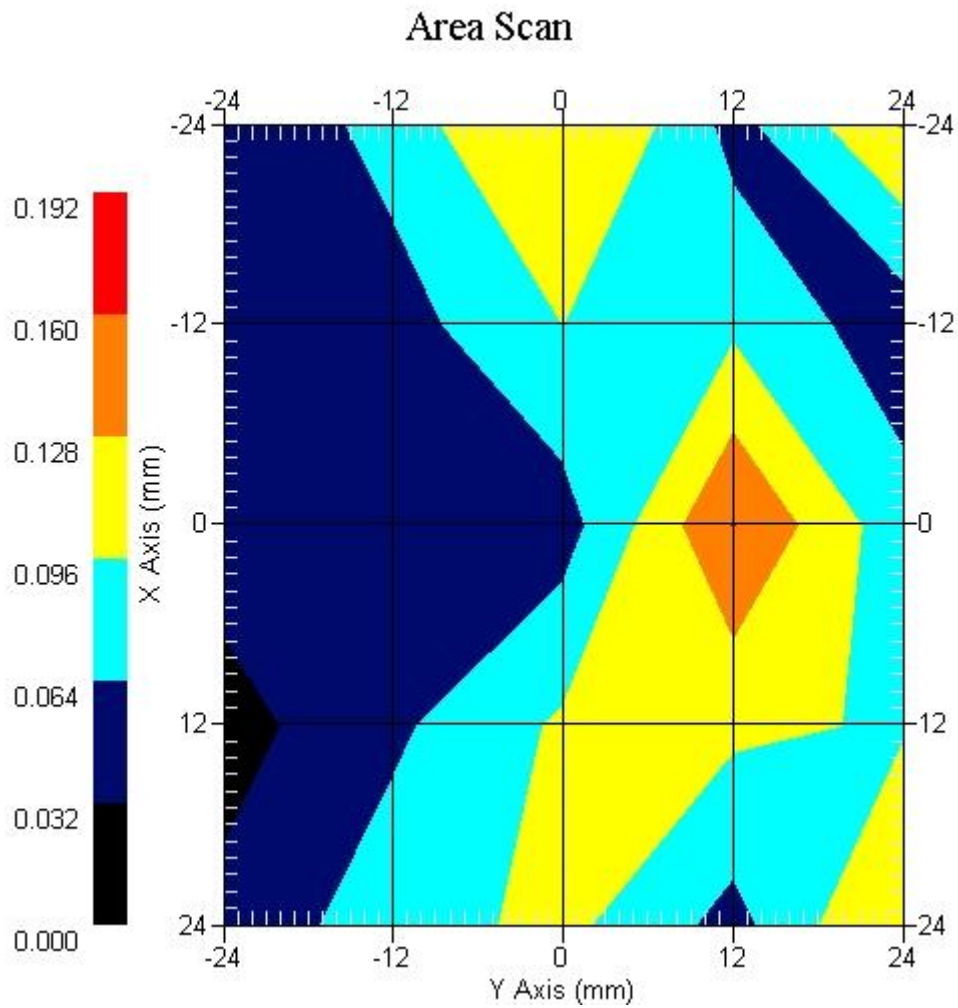

ALSAS-10U VER 2.3.6 APREL Laboratories
SAR Test Report -802.11n(20M) - Tx3 Antenna

Report Date : 01-Dec-2008
Measurement Date : 01-Dec-2008

Product Data

Device Name : NoteBook PC
Type : Other
Model : 9212XY
Frequency : 2450.00 MHz
Drift Time : 0 min(s)
Length : 296 mm
Width : 210 mm
Depth : 231 mm
Antenna Type : Internal

Phantom Data

Type : Uni-Phantom
Size (mm) : 280 x 280 x 200
Location : Center

Tissue Data

Type : BODY
Serial No. : 325-B
Frequency : 2450.00 MHz
Last Calib. Date : 01-Dec-2008
Temperature : 21.60 °C
Ambient Temp. : 22.50 °C
Humidity : 54.00 RH%
Epsilon : 54.25 F/m
Sigma : 1.97 S/m
Density : 1000.00 kg/cu. m

Probe Data

Name : Probe 265
Model : E020
Type : E-Field Triangle
Serial No. : 265
Last Calib. Date : 09-May-2008
Frequency : 2450.00 MHz
Duty Cycle Factor: 1
Conversion Factor: 3.55
Probe Sensitivity: 1.20 1.20 1.20 $\mu\text{V}/(\text{V}/\text{m})^2$
Compression Point: 95.00 mV
Offset : 1.56 mm

Measurement Data

Crest Factor : 1
Tissue Temp. : 21.60 °C
Ambient Temp. : 22.50 °C
Area Scan : 5x5x1 : Measurement x=12mm, y=12mm, z=4mm
Zoom Scan : 5x5x8 : Measurement x=8mm, y=8mm, z=4mm
Power Drift-Start : 0.050 W/kg
Power Drift-Finish: 0.052 W/kg
Power Drift (%) : 4.328

DUT Position : Touch
Channel : 6

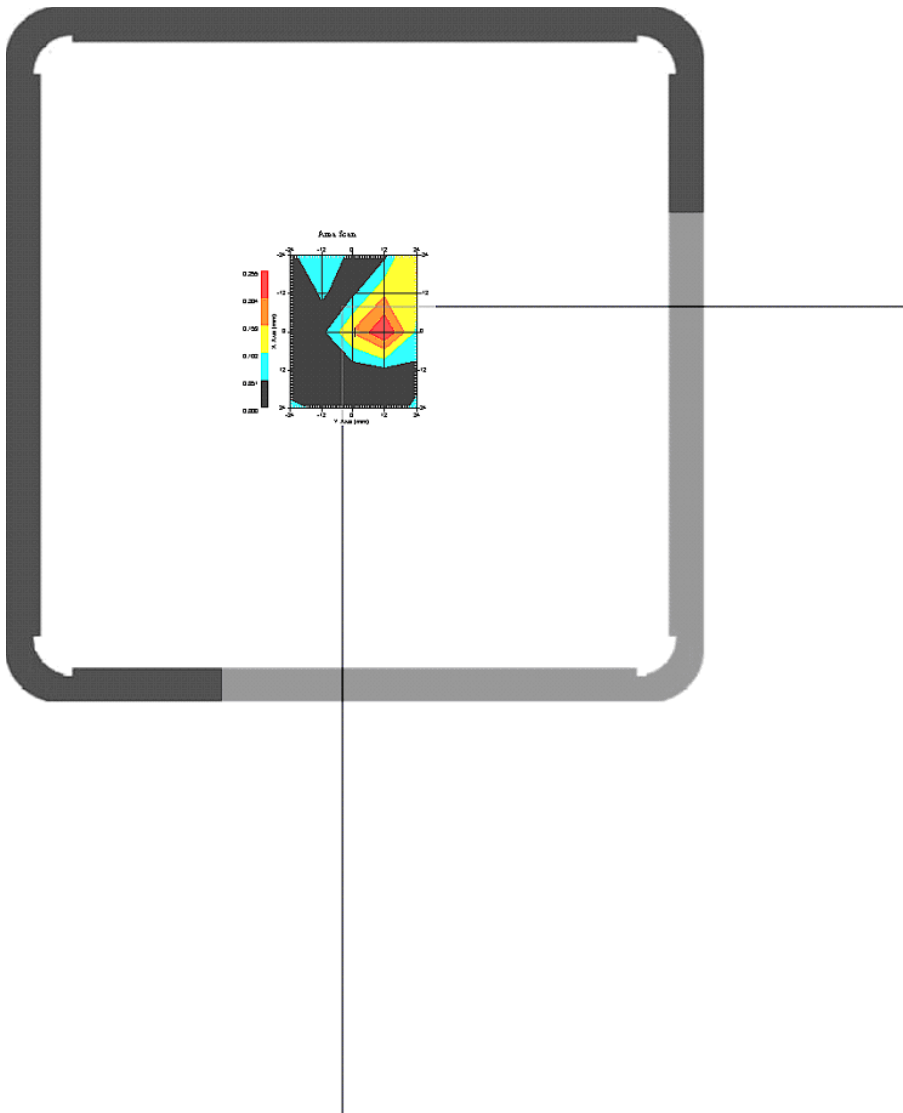

1 gram SAR value : 0.214 W/kg
10 gram SAR value : 0.093 W/kg
Area Scan Peak SAR : 0.253 W/kg
Zoom Scan Peak SAR : 0.620 W/kg

This is previous page plot (zoom in)

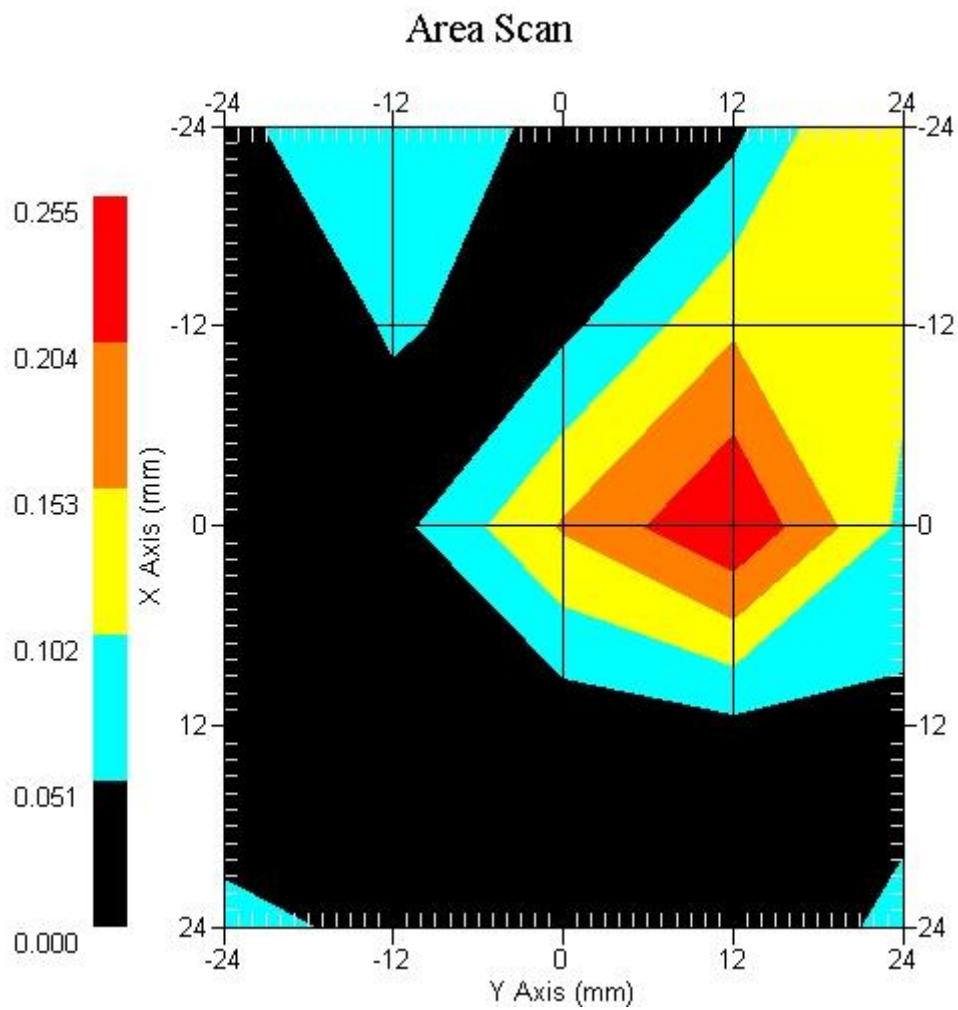

ALSAS-10U VER 2.3.6 APREL Laboratories SAR Test Report -802.11n(40M) - Tx3 Antenna

Report Date : 01-Dec-2008
Measurement Date : 01-Dec-2008

Product Data

Device Name : NoteBook PC
Type : Other
Model : 9212XY
Frequency : 2450.00 MHz
Drift Time : 0 min(s)
Length : 296 mm
Width : 210 mm
Depth : 231 mm
Antenna Type : Internal

Phantom Data

Type : Uni-Phantom
Size (mm) : 280 x 280 x 200
Location : Center

Tissue Data

Type : BODY
Serial No. : 325-B
Frequency : 2450.00 MHz
Last Calib. Date : 01-Dec-2008
Temperature : 21.60 °C
Ambient Temp. : 22.50 °C
Humidity : 54.00 RH%
Epsilon : 54.25 F/m
Sigma : 1.97 S/m
Density : 1000.00 kg/cu. m

Probe Data

Name : Probe 265
Model : E020
Type : E-Field Triangle
Serial No. : 265
Last Calib. Date : 09-May-2008
Frequency : 2450.00 MHz
Duty Cycle Factor: 1
Conversion Factor: 3.55
Probe Sensitivity: 1.20 1.20 1.20 $\mu\text{V}/(\text{V}/\text{m})^2$
Compression Point: 95.00 mV
Offset : 1.56 mm

Measurement Data

Crest Factor : 1
Tissue Temp. : 21.60 °C
Ambient Temp. : 22.50 °C
Area Scan : 5x5x1 : Measurement x=12mm, y=12mm, z=4mm
Zoom Scan : 5x5x8 : Measurement x=8mm, y=8mm, z=4mm
Power Drift-Start : 0.045 W/kg
Power Drift-Finish: 0.044 W/kg
Power Drift (%) : -2.222

DUT Position : Touch
Channel : 6

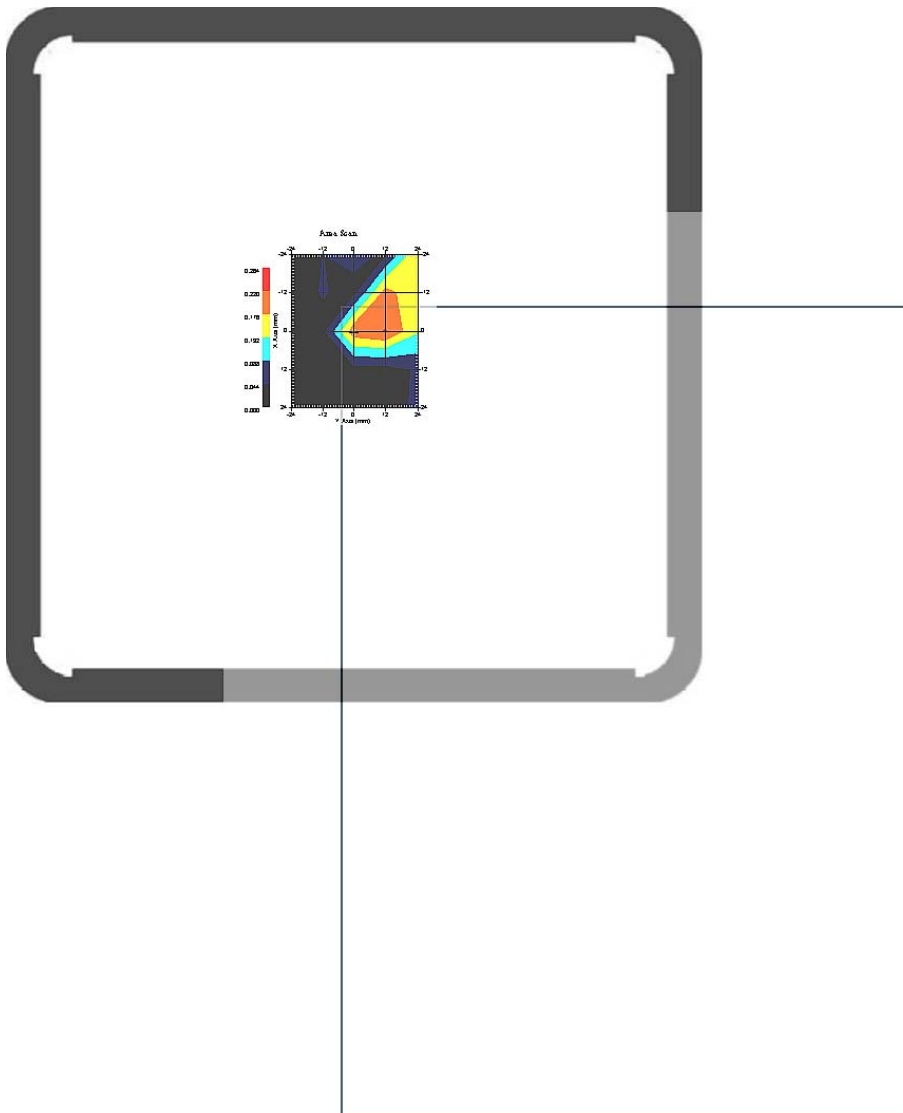

1 gram SAR value : 0.192 W/kg
10 gram SAR value : 0.081 W/kg
Area Scan Peak SAR : 0.222 W/kg
Zoom Scan Peak SAR : 0.730 W/kg

This is previous page plot (zoom in)

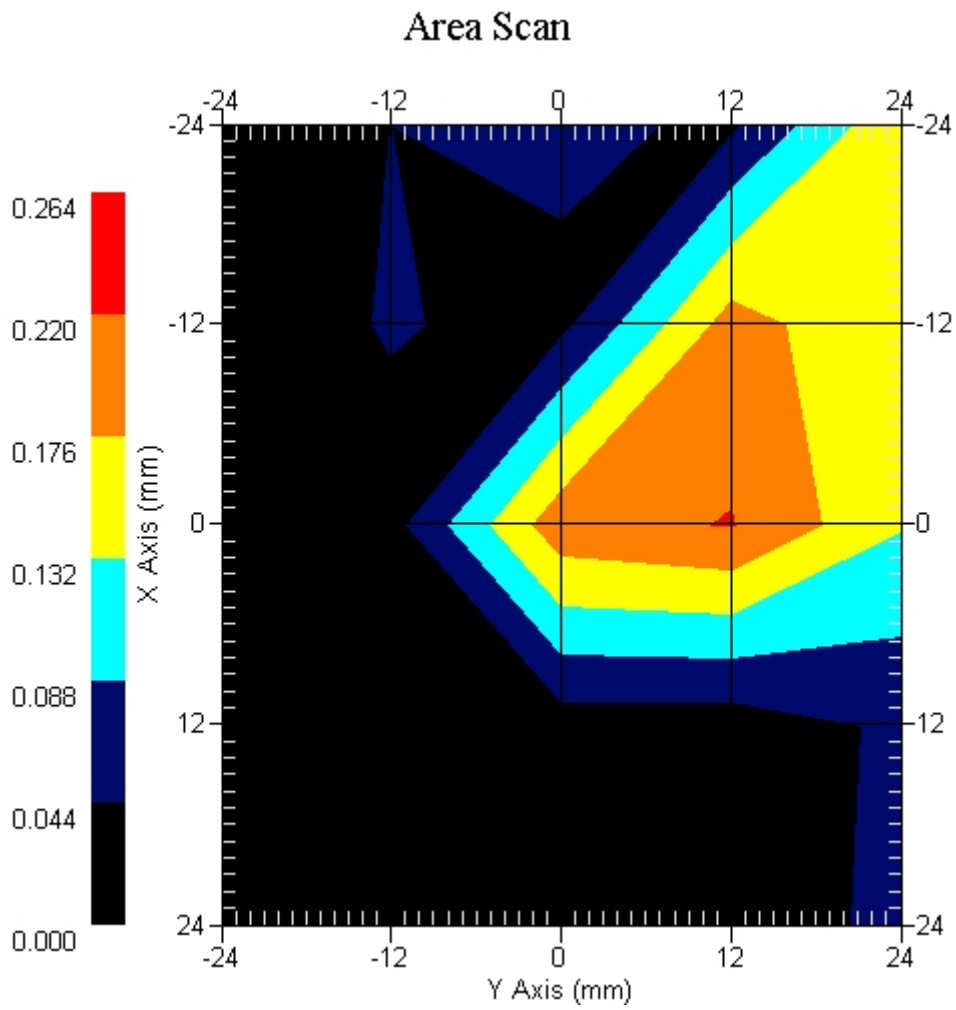

802.11b- Tx3 Antenna, EUT Bottom Z-Axis plot

Channel: 6

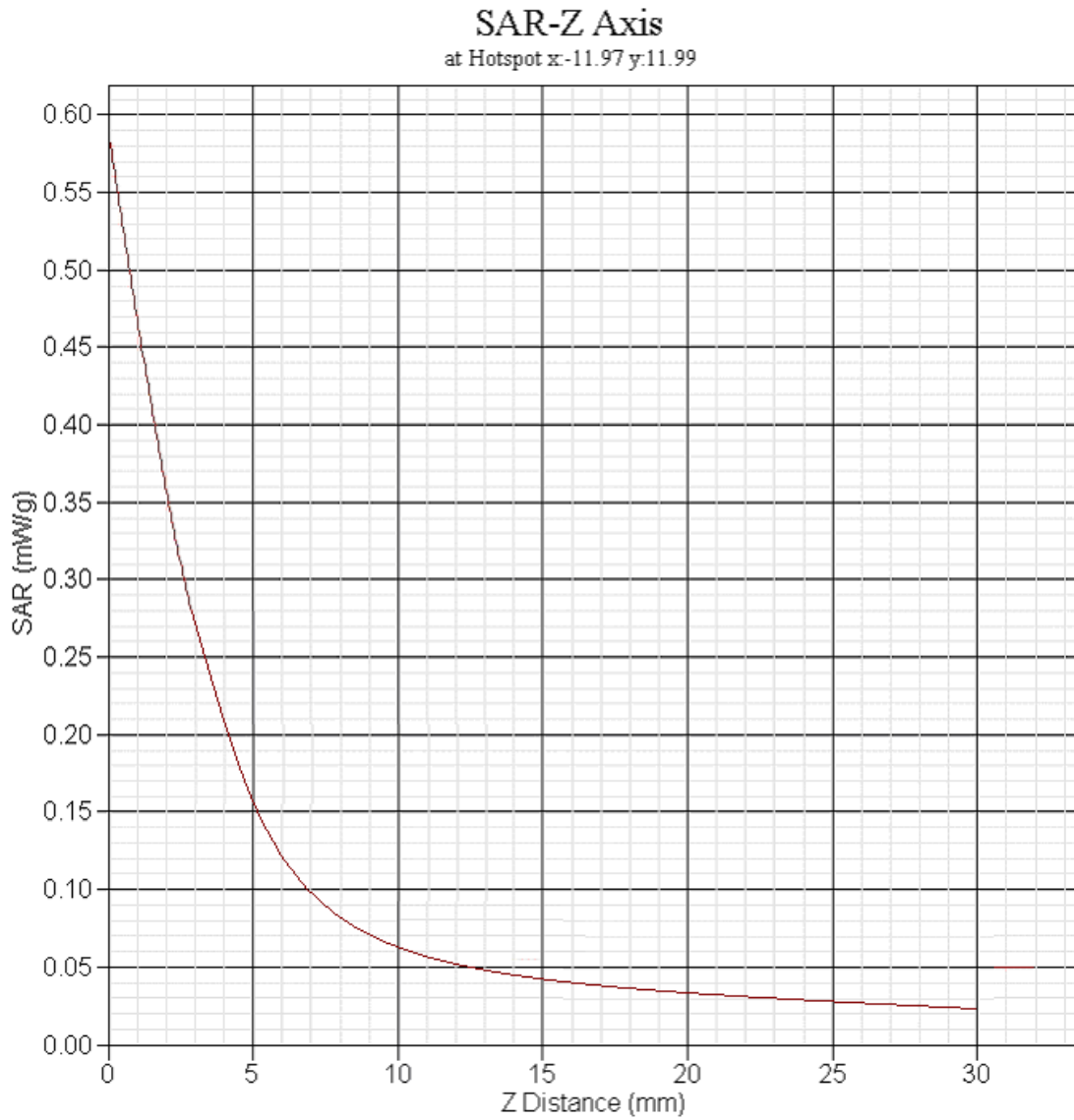

SAR measurement Data

ALSAS-10U VER 2.3.6 APREL Laboratories

SAR Test Report -802.11a, 5200 MHz- Tx3 Antenna

Report Date : 01-Dec-2008
Measurement Date : 01-Dec-2008

Product Data

Device Name : NoteBook PC
Type : Other
Model : 9212XY
Frequency : 5200.00 MHz
Drift Time : 0 min(s)
Length : 296 mm
Width : 210 mm
Depth : 231 mm
Antenna Type : Internal

Phantom Data

Type : Uni-Phantom
Size (mm) : 280 x 280 x 200
Location : Center

Tissue Data

Type : BODY
Serial No. : 326-B
Frequency : 5200.00 MHz
Last Calib. Date : 01-Dec-2008
Temperature : 21.60 °C
Ambient Temp. : 22.50 °C
Humidity : 54.00 RH%
Epsilon : 49.53 F/m
Sigma : 5.47 S/m
Density : 1000.00 kg/cu. m

Probe Data

Name : Probe 265
Model : E020
Type : E-Field Triangle
Serial No. : 265
Last Calib. Date : 09-May-2008
Frequency : 5200.00 MHz
Duty Cycle Factor: 1
Conversion Factor: 4.3
Probe Sensitivity: 1.20 1.20 1.20 $\mu\text{V}/(\text{V}/\text{m})^2$
Compression Point: 95.00 mV
Offset : 1.56 mm

Measurement Data

Crest Factor : 1
Tissue Temp. : 21.60 °C
Ambient Temp. : 22.50 °C
Area Scan : 5x5x1 : Measurement x=12mm, y=12mm, z=4mm
Zoom Scan : 9x9x7 : Measurement x=4mm, y=4mm, z=5mm
Power Drift-Start : 0.053 W/kg
Power Drift-Finish: 0.051 W/kg
Power Drift (%) : -3.773

DUT Position : Touch
Channel : 36

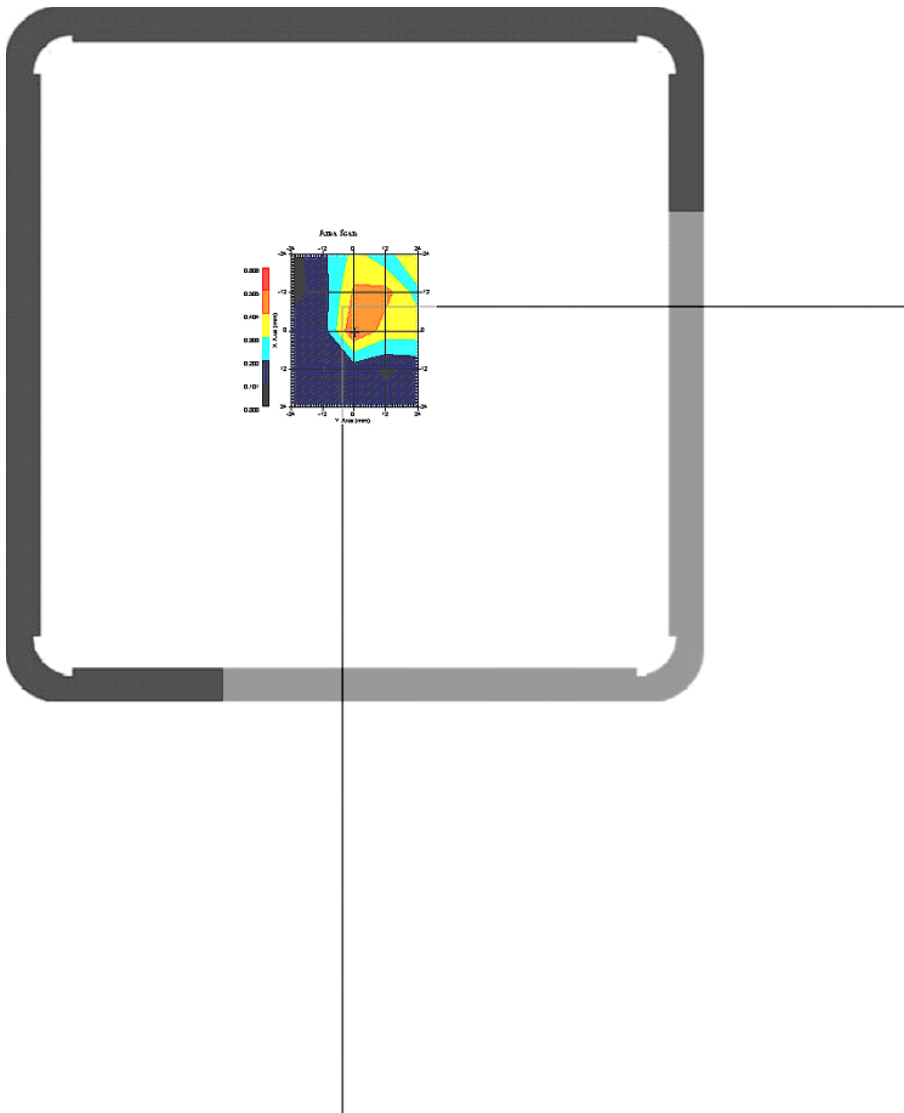

1 gram SAR value : 0.346 W/kg
10 gram SAR value : 0.183 W/kg
Area Scan Peak SAR : 0.507 W/kg
Zoom Scan Peak SAR : 0.731 W/kg

This is previous page plot (zoom in)

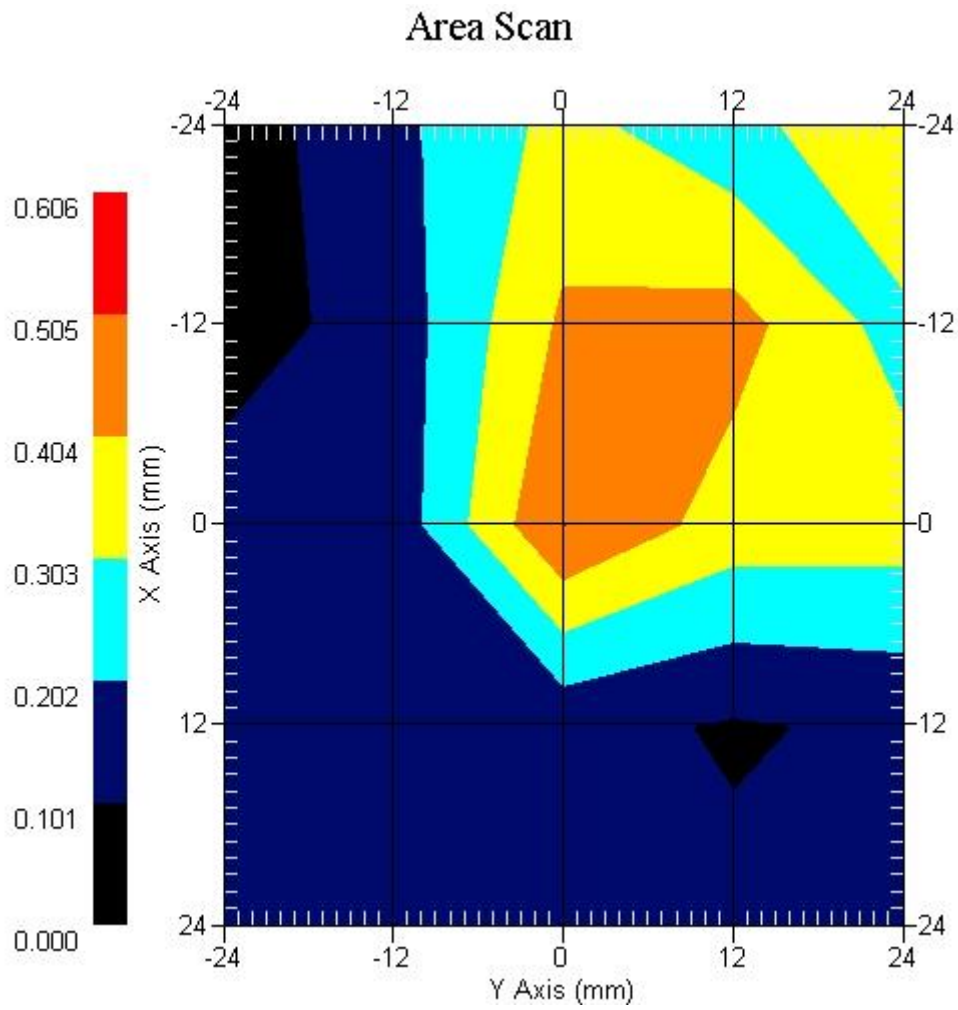

Measurement Data

Crest Factor : 1
Tissue Temp. : 21.60 °C
Ambient Temp. : 22.50 °C
Area Scan : 5x5x1 : Measurement x=12mm, y=12mm, z=4mm
Zoom Scan : 9x9x7 : Measurement x=4mm, y=4mm, z=5mm
Power Drift-Start : 0.045 W/kg
Power Drift-Finish: 0.044 W/kg
Power Drift (%) : -2.222

DUT Position : Touch
Channel : 44

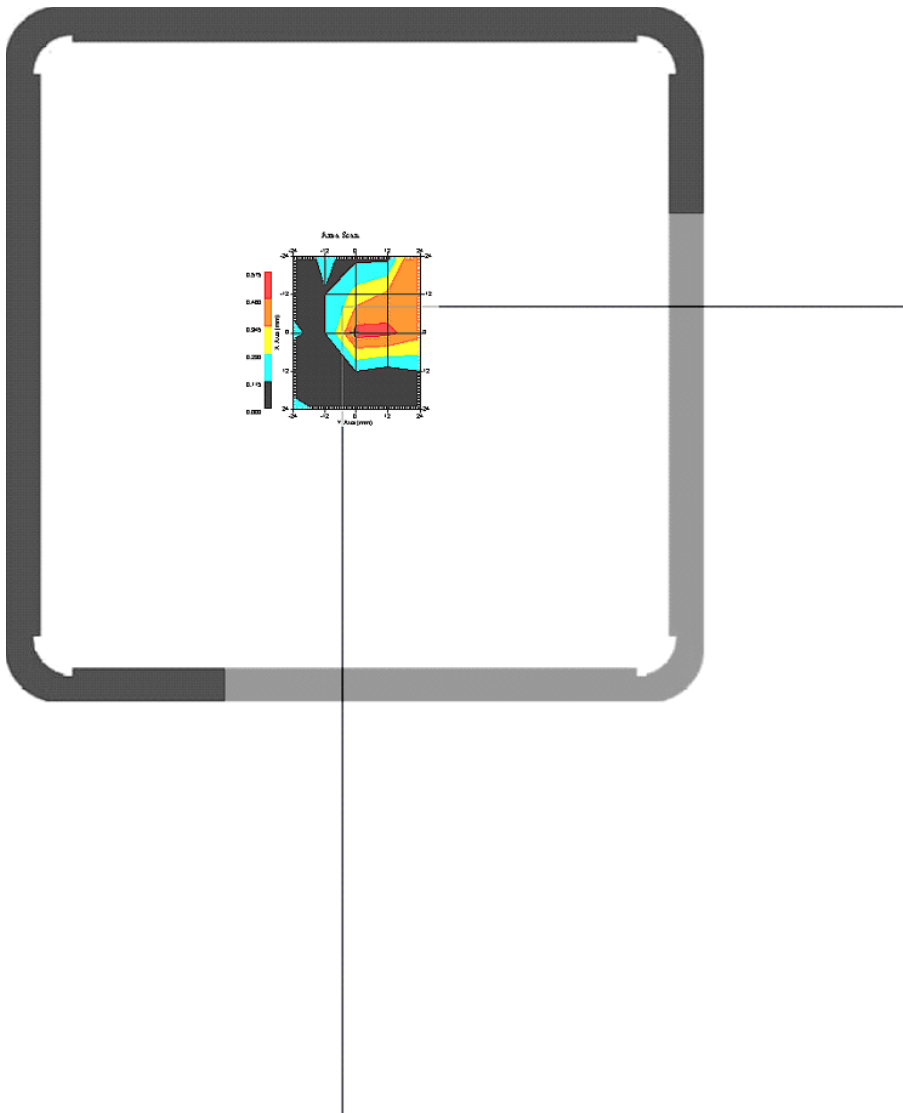

1 gram SAR value : 0.376 W/kg
10 gram SAR value : 0.211 W/kg
Area Scan Peak SAR : 0.575 W/kg
Zoom Scan Peak SAR : 0.631 W/kg

This is previous page plot (zoom in)

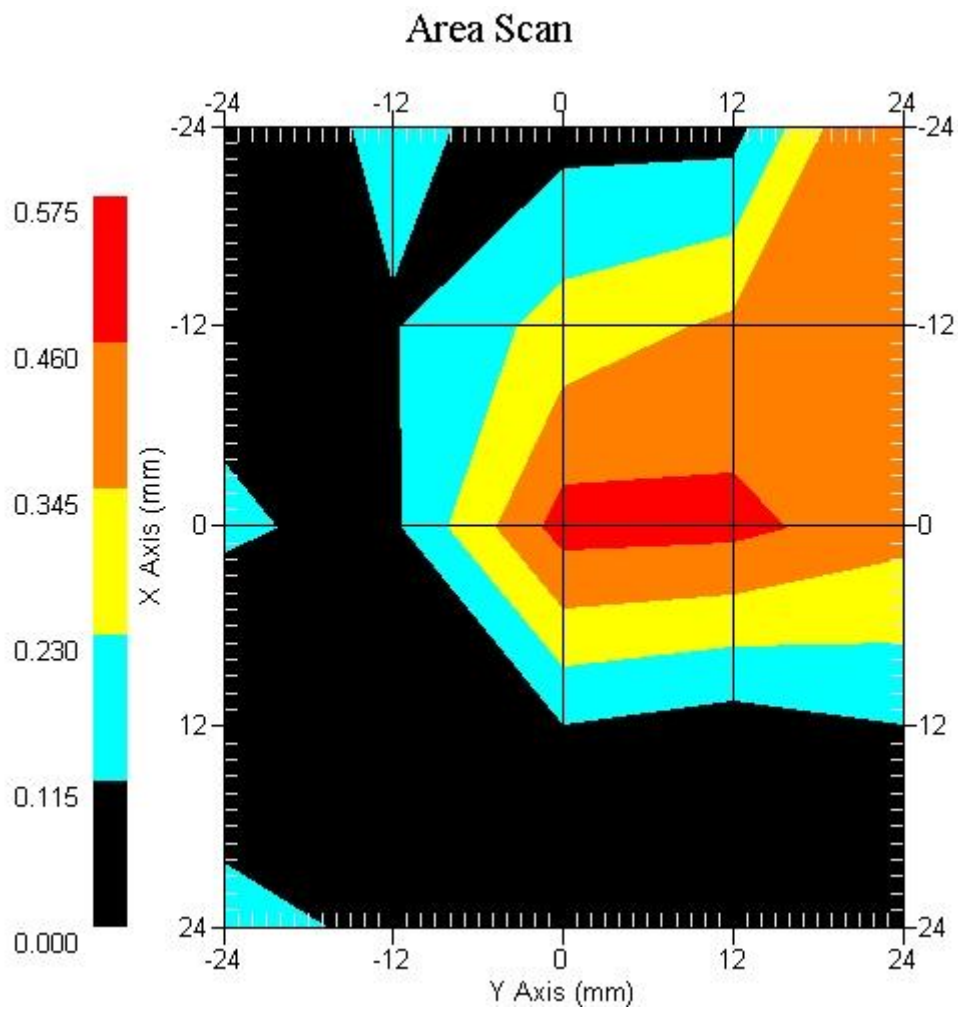

Measurement Data

Crest Factor : 1
Tissue Temp. : 21.60 °C
Ambient Temp. : 22.50 °C
Area Scan : 5x5x1 : Measurement x=12mm, y=12mm, z=4mm
Zoom Scan : 9x9x7 : Measurement x=4mm, y=4mm, z=5mm
Power Drift-Start : 0.051 W/kg
Power Drift-Finish: 0.051 W/kg
Power Drift (%) : -0.549

DUT Position : Touch
Channel : 52

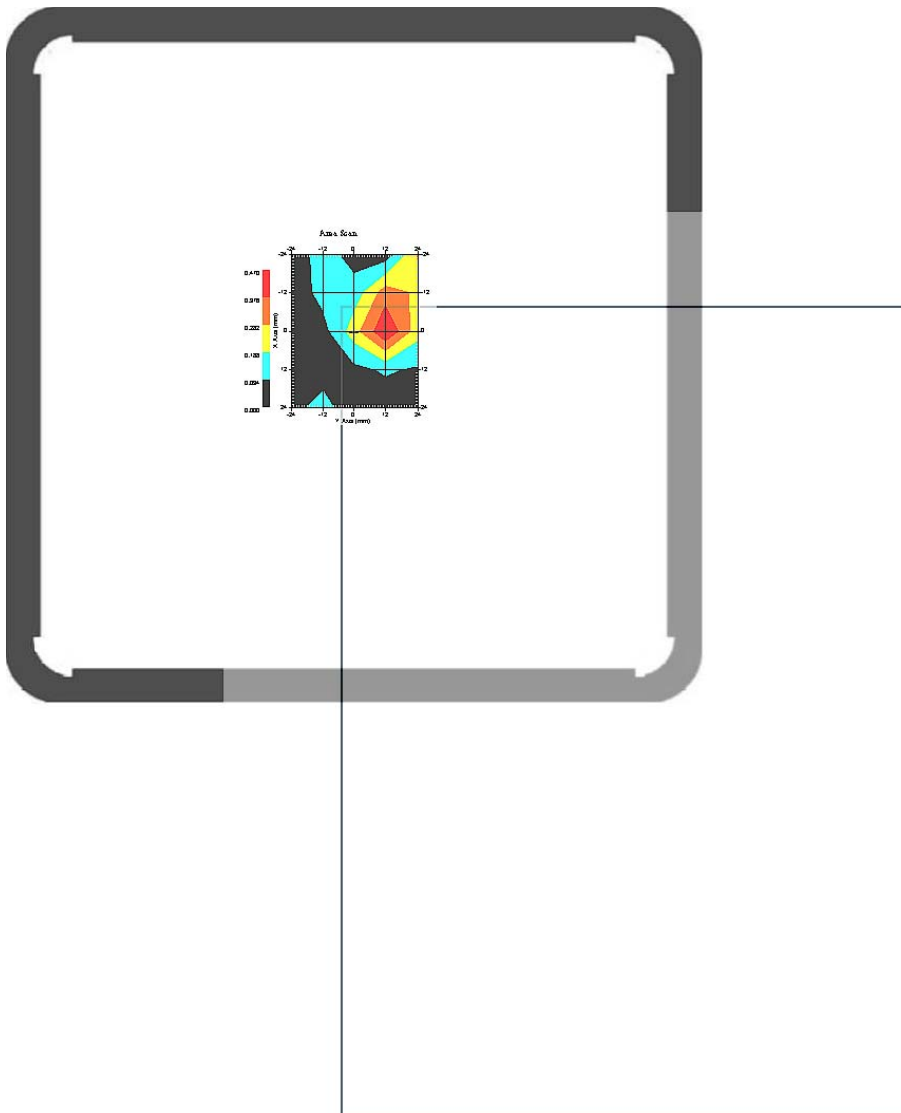

1 gram SAR value : 0.267 W/kg
10 gram SAR value : 0.148 W/kg
Area Scan Peak SAR : 0.468 W/kg
Zoom Scan Peak SAR : 0.671 W/kg

This is previous page plot (zoom in)

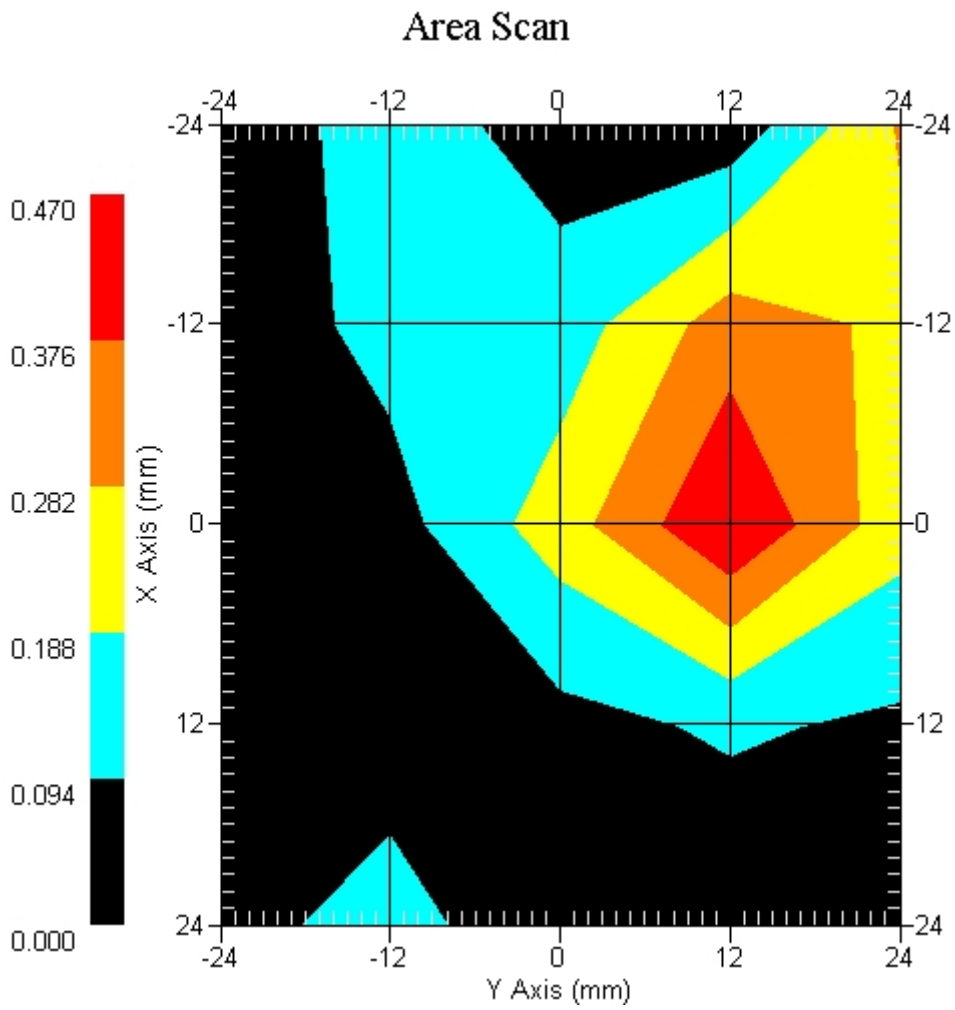

Measurement Data

Crest Factor : 1
Tissue Temp. : 21.60 °C
Ambient Temp. : 22.50 °C
Area Scan : 5x5x1 : Measurement x=12mm, y=12mm, z=4mm
Zoom Scan : 9x9x7 : Measurement x=4mm, y=4mm, z=5mm
Power Drift-Start : 0.050 W/kg
Power Drift-Finish: 0.048 W/kg
Power Drift (%) : -4.000

DUT Position : Touch
Channel : 64

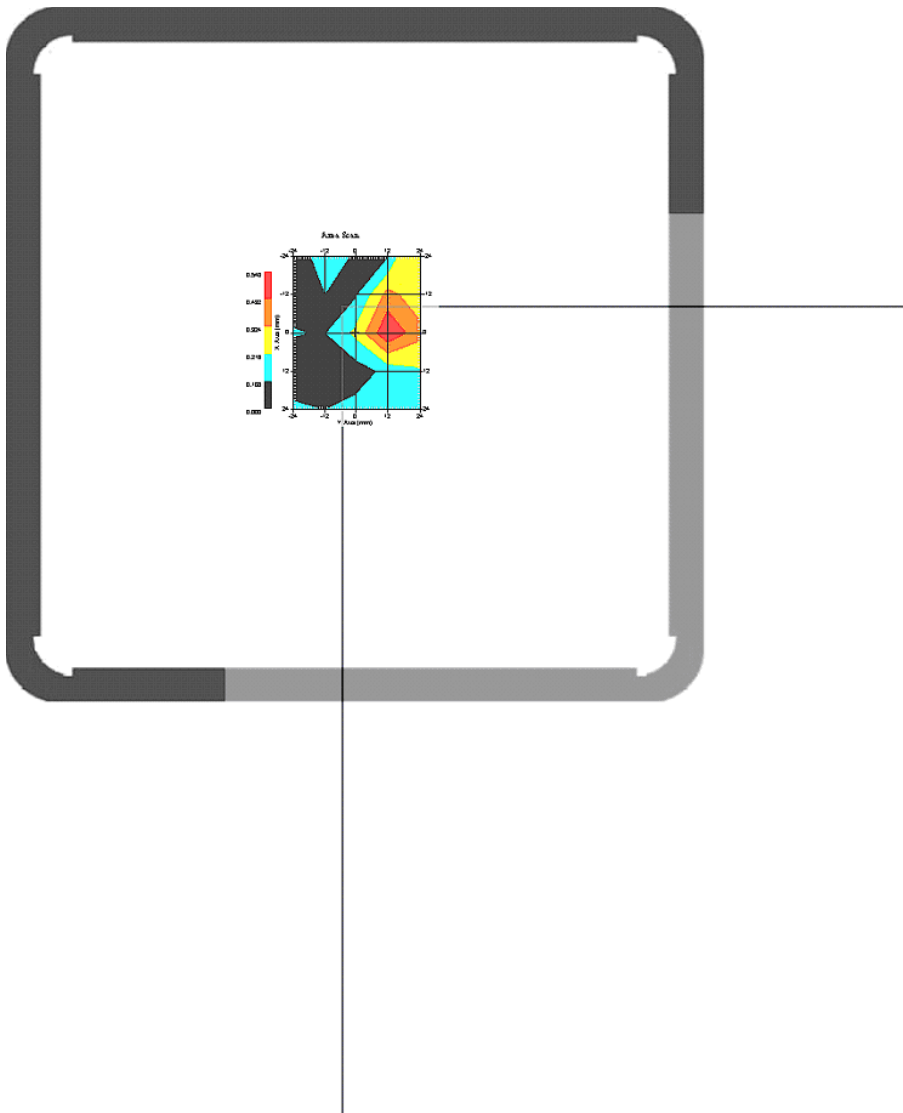

1 gram SAR value : 0.210 W/kg
10 gram SAR value : 0.174 W/kg
Area Scan Peak SAR : 0.540 W/kg
Zoom Scan Peak SAR : 0.500 W/kg

This is previous page plot (zoom in)

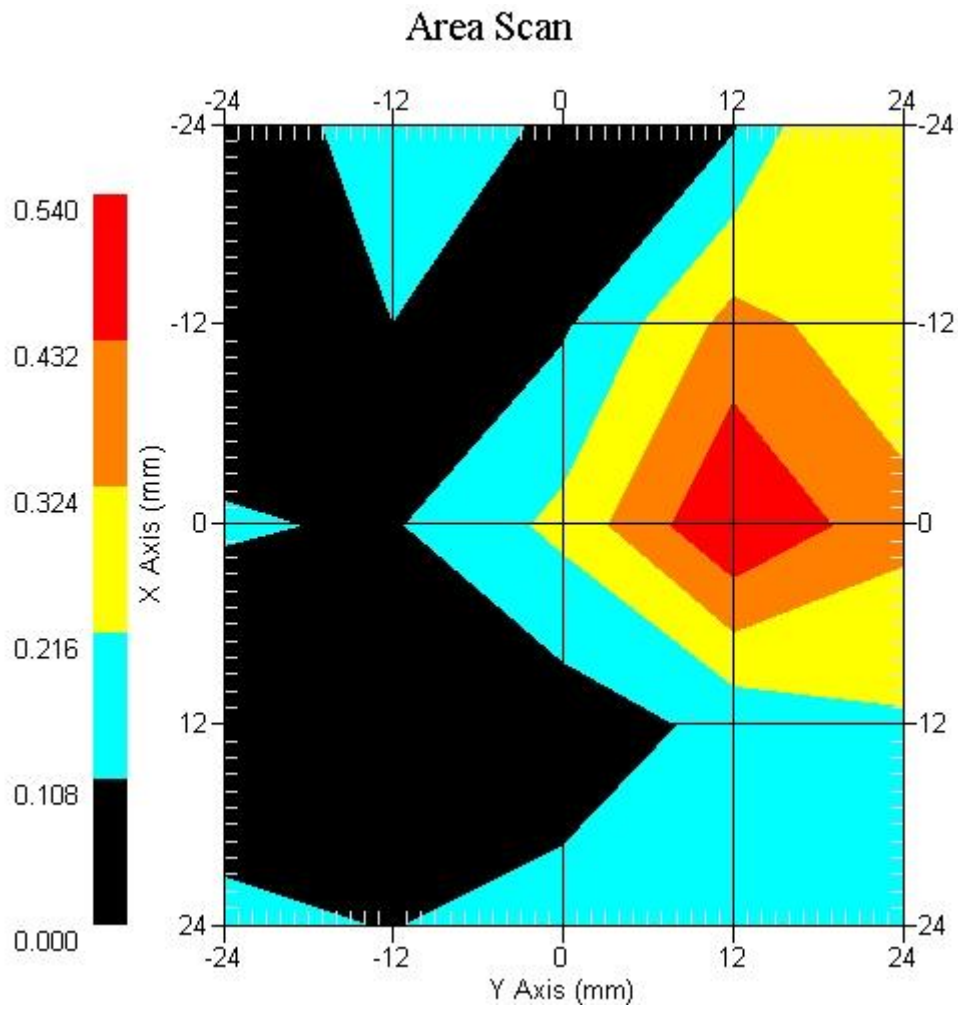

ALSAS-10U VER 2.3.6 APREL Laboratories
SAR Test Report -802.11n(20M), 5200 MHz - Tx3 AntennaReport Date : 01-Dec-2008
Measurement Date : 01-Dec-2008

Product Data

Device Name : NoteBook PC
Type : Other
Model : 9212XY
Frequency : 5200.00 MHz
Drift Time : 0 min(s)
Length : 296 mm
Width : 210 mm
Depth : 231 mm
Antenna Type : Internal

Phantom Data

Type : Uni-Phantom
Size (mm) : 280 x 280 x 200
Location : Center

Tissue Data

Type : BODY
Serial No. : 326-B
Frequency : 5200.00 MHz
Last Calib. Date : 01-Dec-2008
Temperature : 21.60 °C
Ambient Temp. : 22.50 °C
Humidity : 54.00 RH%
Epsilon : 49.53 F/m
Sigma : 5.47 S/m
Density : 1000.00 kg/cu. m

Probe Data

Name : Probe 265
Model : E020
Type : E-Field Triangle
Serial No. : 265
Last Calib. Date : 09-May-2008
Frequency : 5200.00 MHz
Duty Cycle Factor: 1
Conversion Factor: 4.3
Probe Sensitivity: 1.20 1.20 1.20 $\mu\text{V}/(\text{V}/\text{m})^2$
Compression Point: 95.00 mV
Offset : 1.56 mm

Measurement Data

Crest Factor : 1
Tissue Temp. : 21.60 °C
Ambient Temp. : 22.50 °C
Area Scan : 5x5x1 : Measurement x=12mm, y=12mm, z=4mm
Zoom Scan : 9x9x7 : Measurement x=4mm, y=4mm, z=5mm
Power Drift-Start : 0.048 W/kg
Power Drift-Finish: 0.048 W/kg
Power Drift (%) : -0.765

DUT Position : Touch
Channel : 44

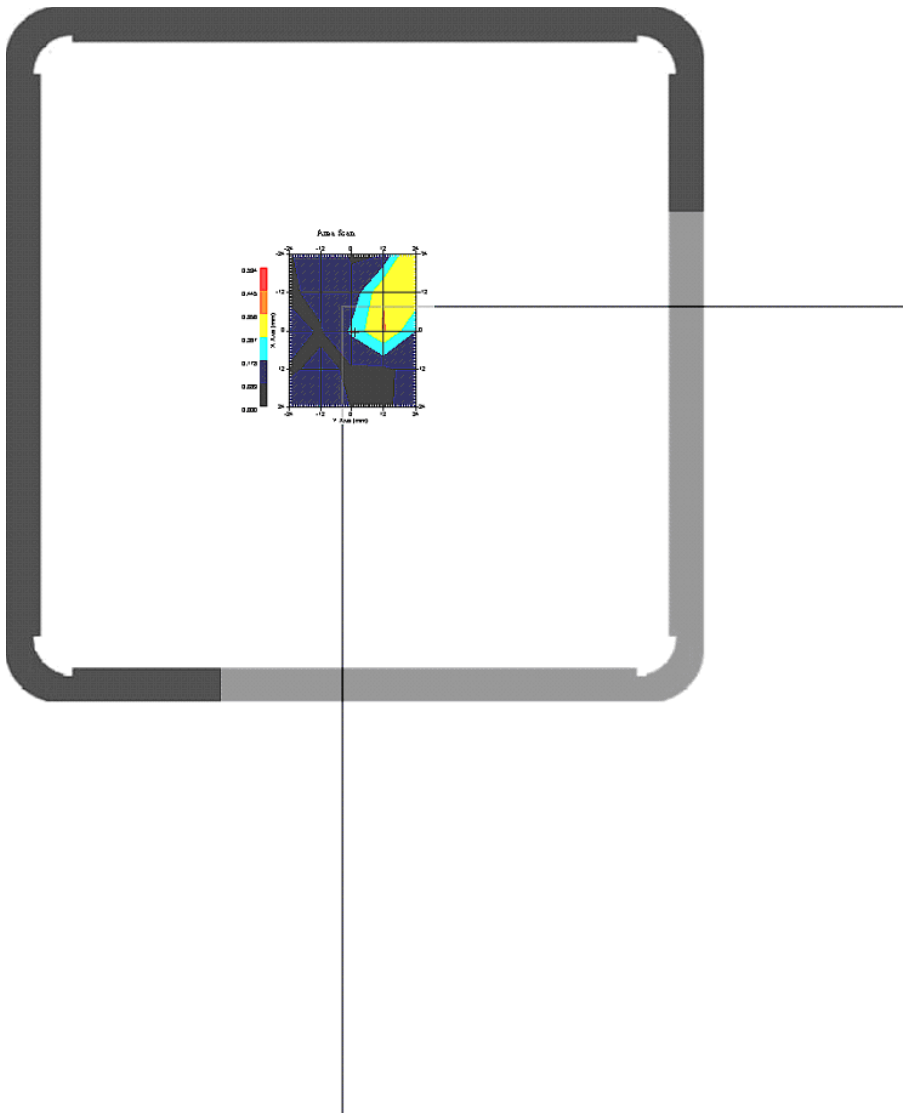

1 gram SAR value : 0.283 W/kg
10 gram SAR value : 0.189 W/kg
Area Scan Peak SAR : 0.446 W/kg
Zoom Scan Peak SAR : 0.641 W/kg

This is previous page plot (zoom in)

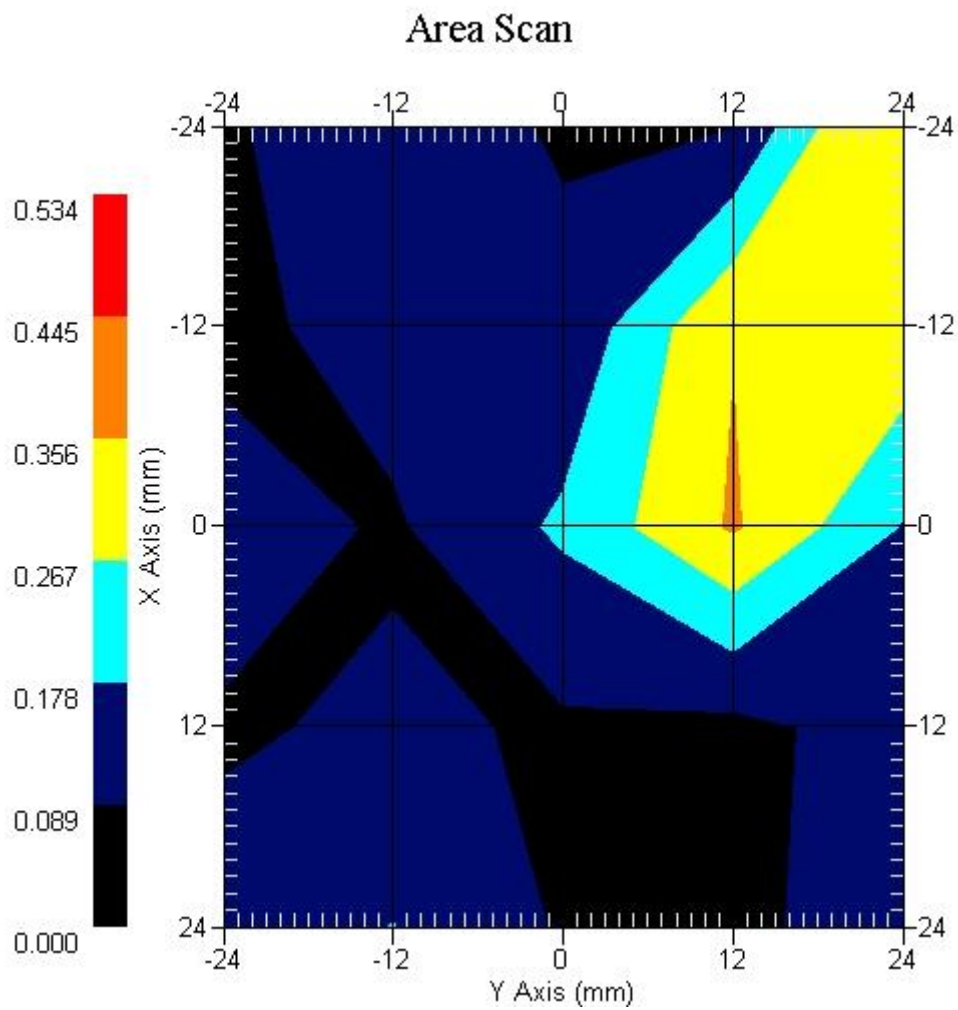

ALSAS-10U VER 2.3.6 APREL Laboratories
SAR Test Report -802.11n(40M), 5200 MHz - Tx3 AntennaReport Date : 01-Dec-2008
Measurement Date : 01-Dec-2008

Product Data

Device Name : NoteBook PC
Type : Other
Model : 9212XY
Frequency : 5200.00 MHz
Drift Time : 0 min(s)
Length : 296 mm
Width : 210 mm
Depth : 231 mm
Antenna Type : Internal

Phantom Data

Type : Uni-Phantom
Size (mm) : 280 x 280 x 200
Location : Center

Tissue Data

Type : BODY
Serial No. : 326-B
Frequency : 5200.00 MHz
Last Calib. Date : 01-Dec-2008
Temperature : 21.60 °C
Ambient Temp. : 22.50 °C
Humidity : 54.00 RH%
Epsilon : 49.53 F/m
Sigma : 5.47 S/m
Density : 1000.00 kg/cu. m

Probe Data

Name : Probe 265
Model : E020
Type : E-Field Triangle
Serial No. : 265
Last Calib. Date : 09-May-2008
Frequency : 5200.00 MHz
Duty Cycle Factor: 1
Conversion Factor: 4.3
Probe Sensitivity: 1.20 1.20 1.20 $\mu\text{V}/(\text{V}/\text{m})^2$
Compression Point: 95.00 mV
Offset : 1.56 mm

Measurement Data

Crest Factor : 1
Tissue Temp. : 21.60 °C
Ambient Temp. : 22.50 °C
Area Scan : 5x5x1 : Measurement x=12mm, y=12mm, z=4mm
Zoom Scan : 9x9x7 : Measurement x=4mm, y=4mm, z=5mm
Power Drift-Start : 0.034 W/kg
Power Drift-Finish: 0.034 W/kg
Power Drift (%) : -0.970

DUT Position : Touch
Channel : 46

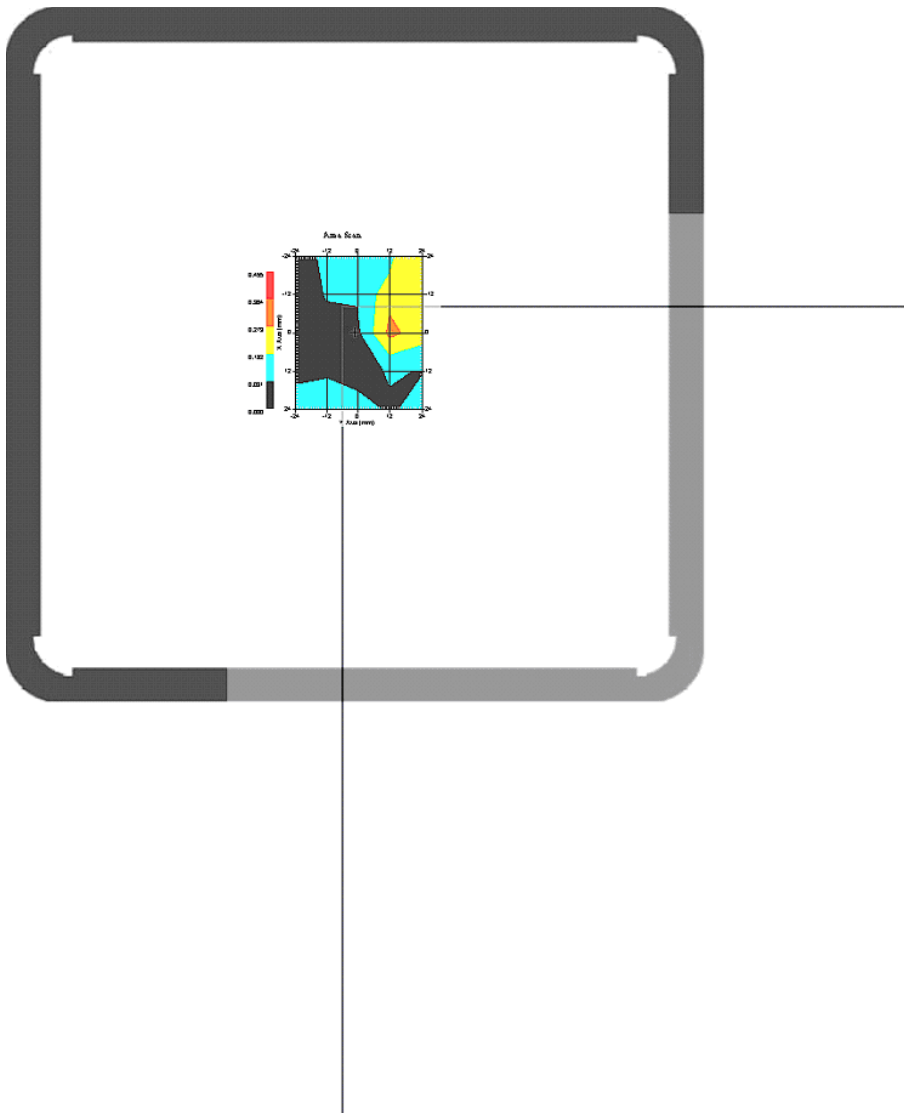

1 gram SAR value : 0.280 W/kg
10 gram SAR value : 0.187 W/kg
Area Scan Peak SAR : 0.454 W/kg
Zoom Scan Peak SAR : 0.500 W/kg

This is previous page plot (zoom in)

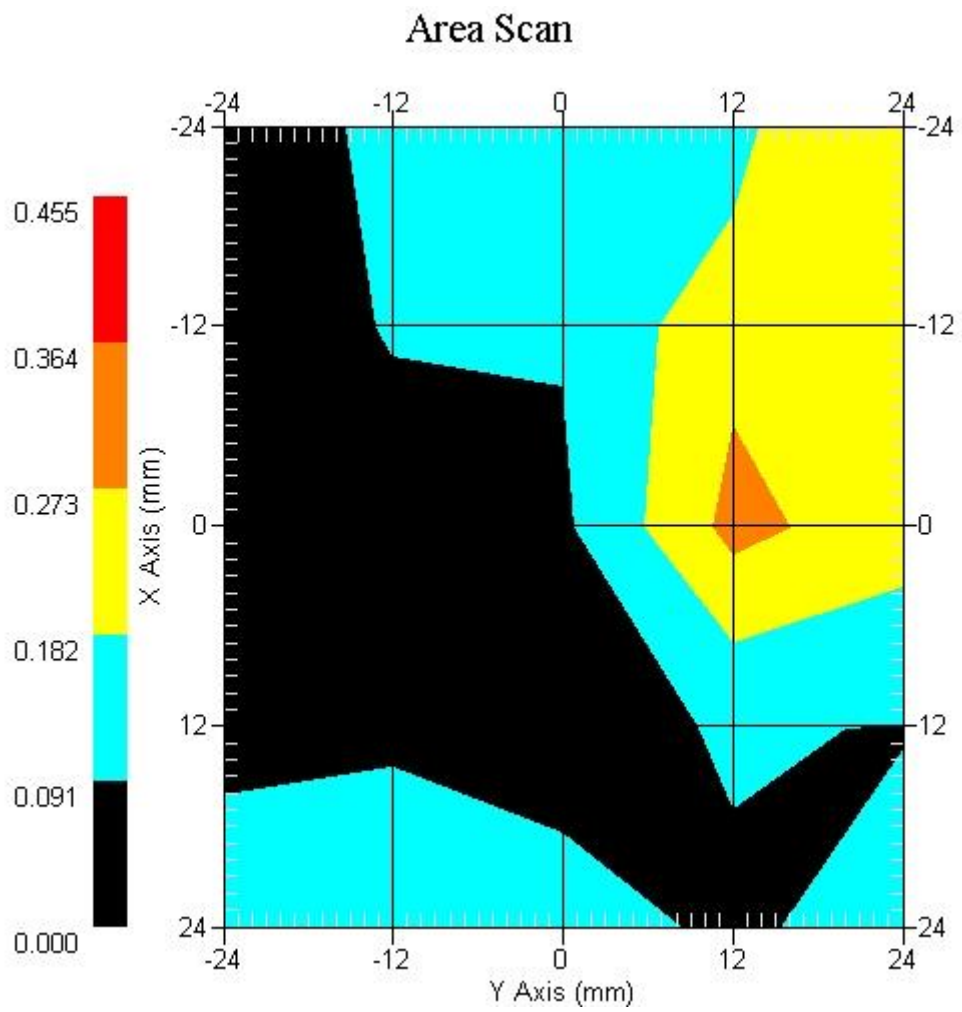

802.11a, 5200 MHz- Tx3 Antenna, EUT Bottom Z-Axis plot
Channel: 44

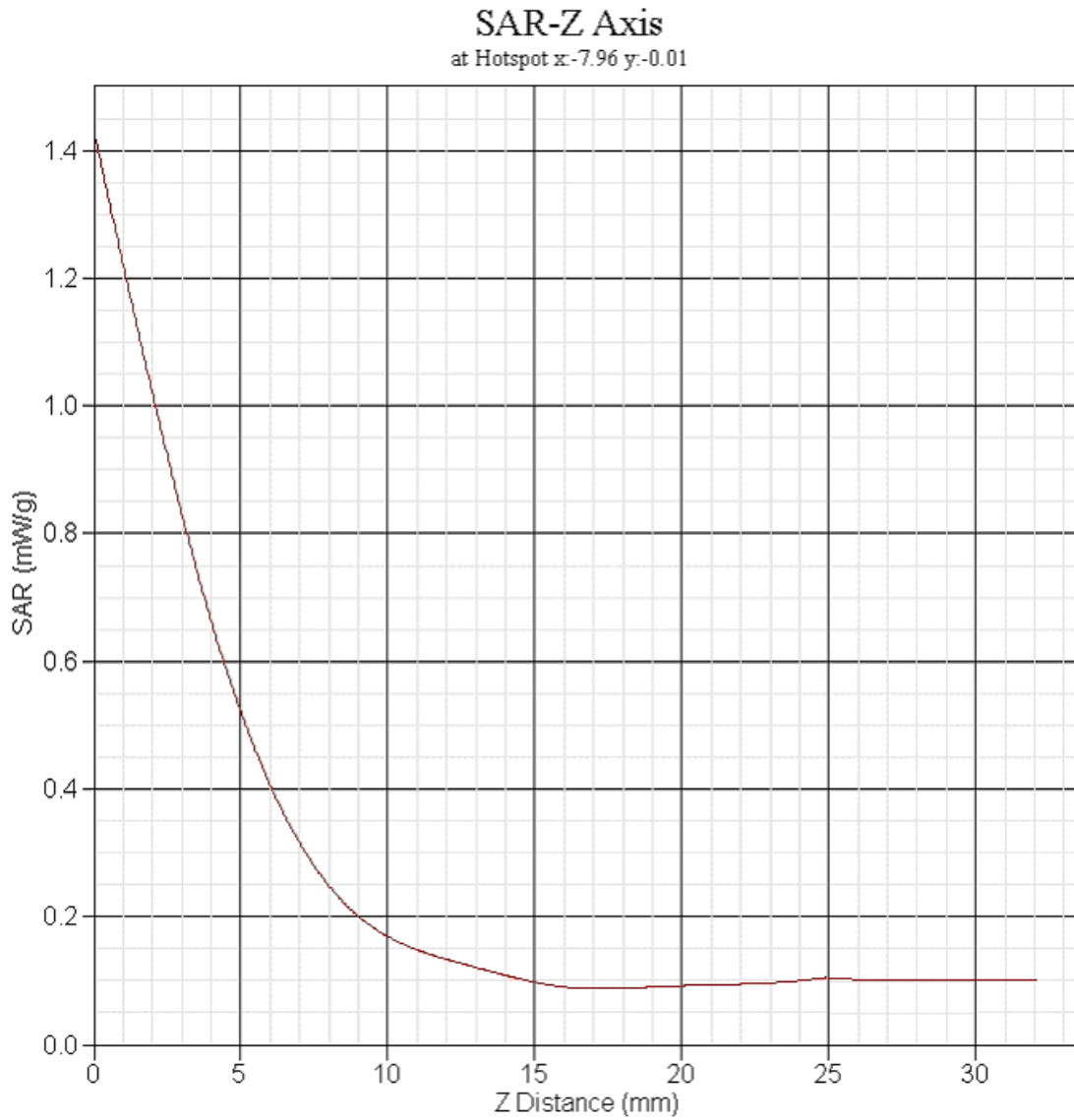

SAR measurement Data

ALSAS-10U VER 2.3.6 APREL Laboratories

SAR Test Report -802.11a, 5800 MHz- Tx3 Antenna

Report Date : 01-Dec-2008
Measurement Date : 01-Dec-2008

Product Data

Device Name : NoteBook PC
Type : Other
Model : 9212XY
Frequency : 5800.00 MHz
Drift Time : 0 min(s)
Length : 296 mm
Width : 210 mm
Depth : 231 mm
Antenna Type : Internal

Phantom Data

Type : Uni-Phantom
Size (mm) : 280 x 280 x 200
Location : Center

Tissue Data

Type : BODY
Serial No. : 327-B
Frequency : 5800.00 MHz
Last Calib. Date : 01-Dec-2008
Temperature : 21.60 °C
Ambient Temp. : 22.50 °C
Humidity : 54.00 RH%
Epsilon : 49.10 F/m
Sigma : 6.14 S/m
Density : 1000.00 kg/cu. m

Probe Data

Name : Probe 265
Model : E020
Type : E-Field Triangle
Serial No. : 265
Last Calib. Date : 09-May-2008
Frequency : 5800.00 MHz
Duty Cycle Factor: 1
Conversion Factor: 3.9
Probe Sensitivity: 1.20 1.20 1.20 $\mu\text{V}/(\text{V}/\text{m})^2$
Compression Point: 95.00 mV
Offset : 1.56 mm

Measurement Data

Crest Factor : 1
 Tissue Temp. : 21.60 °C
 Ambient Temp. : 22.50 °C
 Area Scan : 5x5x1 : Measurement x=12mm, y=12mm, z=4mm
 Zoom Scan : 9x9x7 : Measurement x=4mm, y=4mm, z=5mm
 Power Drift-Start : 0.208 W/kg
 Power Drift-Finish: 0.200 W/kg
 Power Drift (%) : -3.662

DUT Position : Touch
 Channel : 100

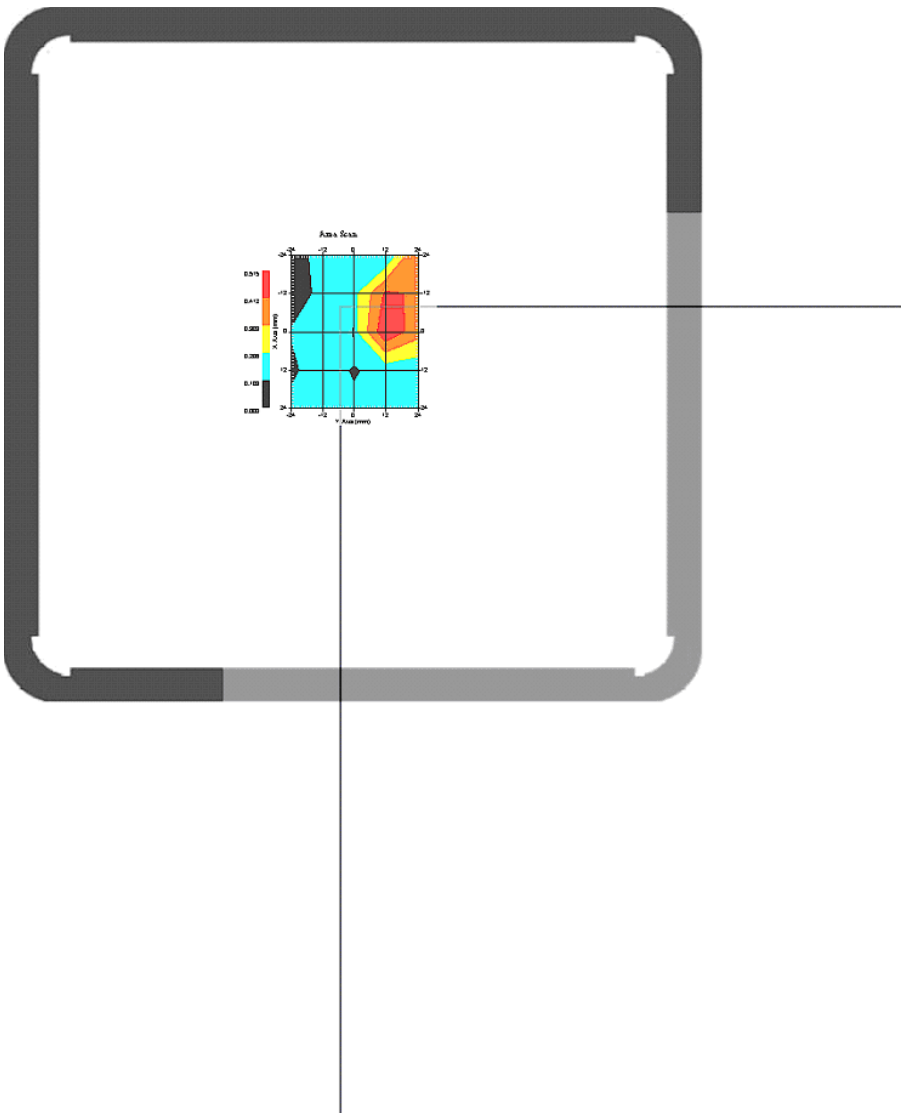

1 gram SAR value : 0.282 W/kg
 10 gram SAR value : 0.208 W/kg
 Area Scan Peak SAR : 0.513 W/kg
 Zoom Scan Peak SAR : 0.630 W/kg

This is previous page plot (zoom in)

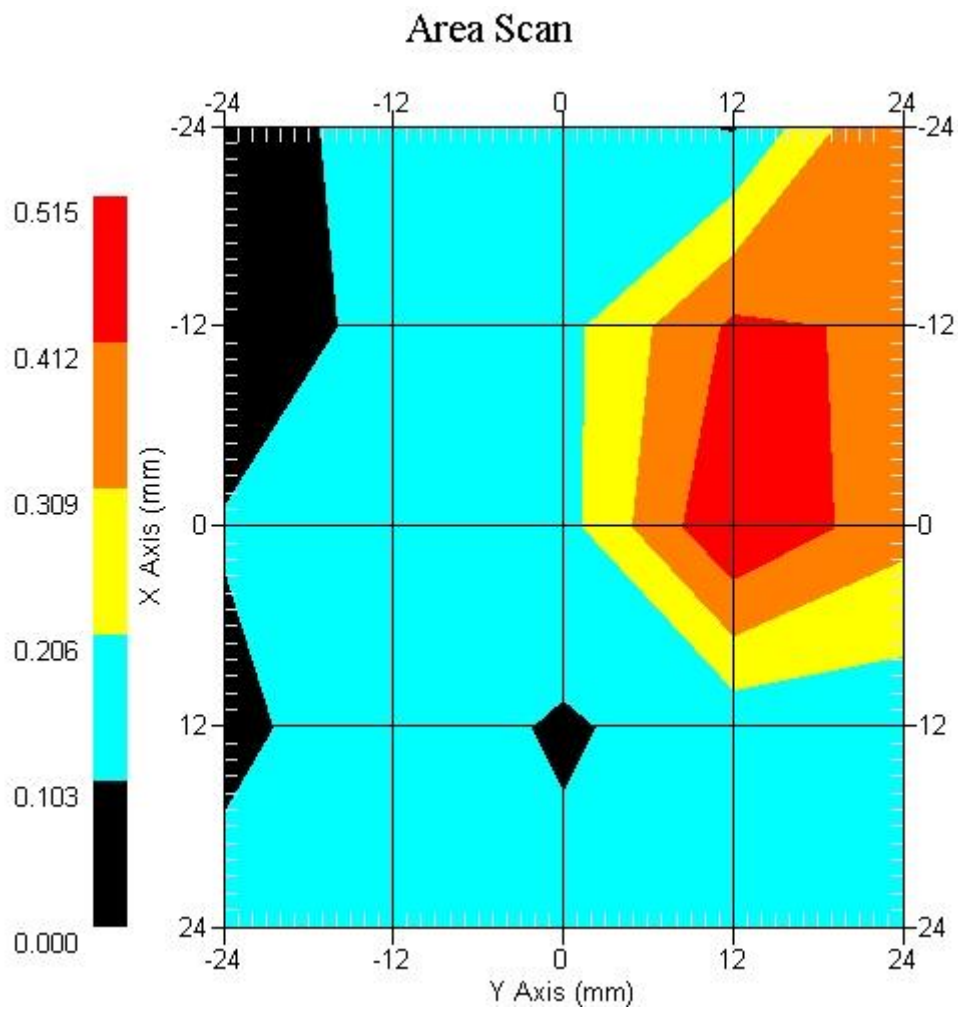

Measurement Data

Crest Factor : 1
Tissue Temp. : 21.60 °C
Ambient Temp. : 22.50 °C
Area Scan : 5x5x1 : Measurement x=12mm, y=12mm, z=4mm
Zoom Scan : 9x9x7 : Measurement x=4mm, y=4mm, z=5mm
Power Drift-Start : 0.020 W/kg
Power Drift-Finish: 0.020 W/kg
Power Drift (%) : -0.079

DUT Position : Touch
Channel : 120

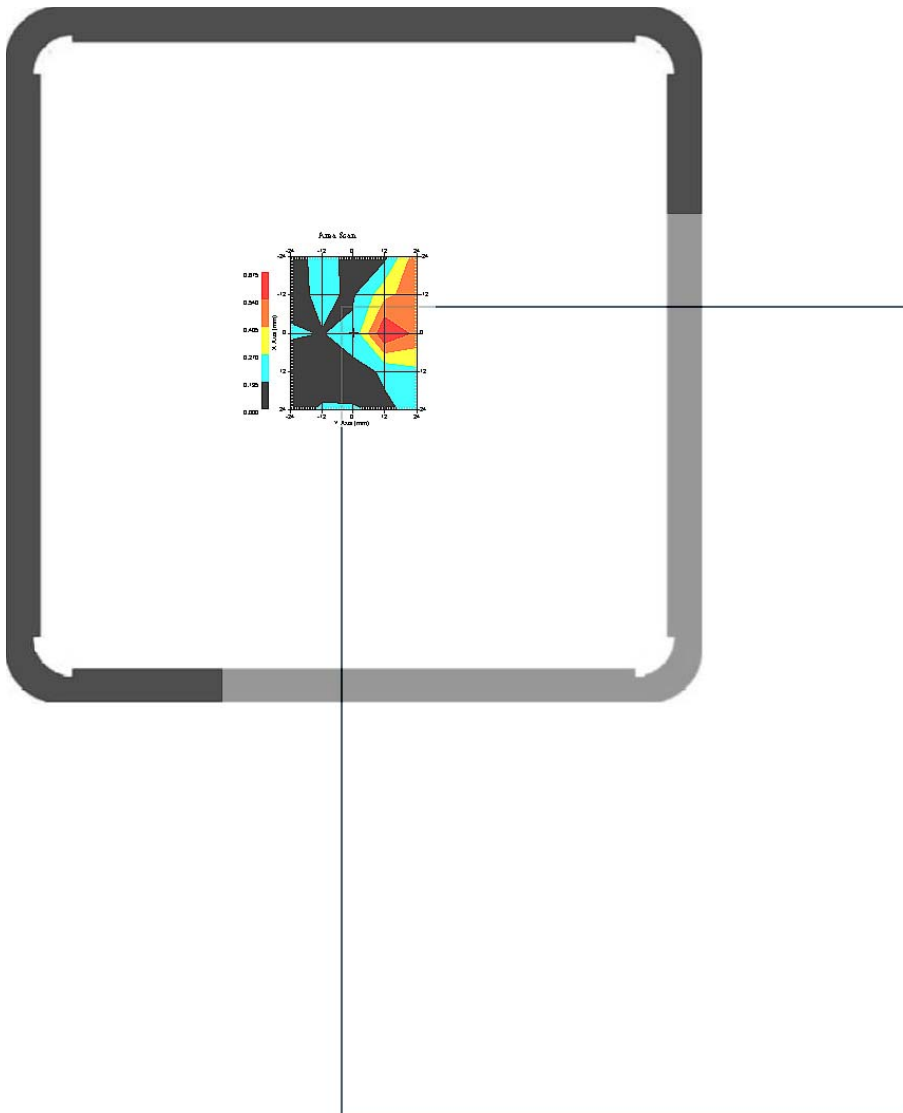

1 gram SAR value : 0.325 W/kg
10 gram SAR value : 0.218 W/kg
Area Scan Peak SAR : 0.675 W/kg
Zoom Scan Peak SAR : 0.700 W/kg

This is previous page plot (zoom in)

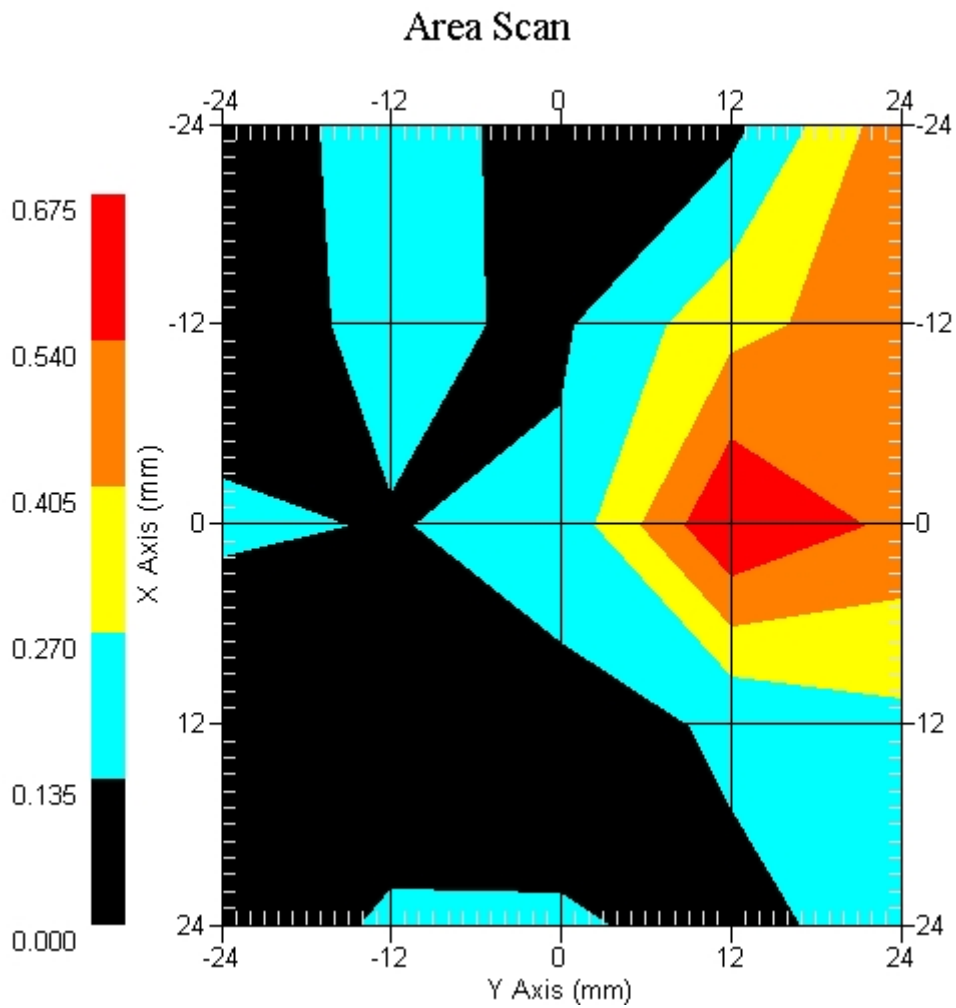

Measurement Data

Crest Factor : 1
Tissue Temp. : 21.60 °C
Ambient Temp. : 22.50 °C
Area Scan : 5x5x1 : Measurement x=12mm, y=12mm, z=4mm
Zoom Scan : 9x9x7 : Measurement x=4mm, y=4mm, z=5mm
Power Drift-Start : 0.030 W/kg
Power Drift-Finish: 0.030 W/kg
Power Drift (%) : -0.413

DUT Position : Touch
Channel : 140

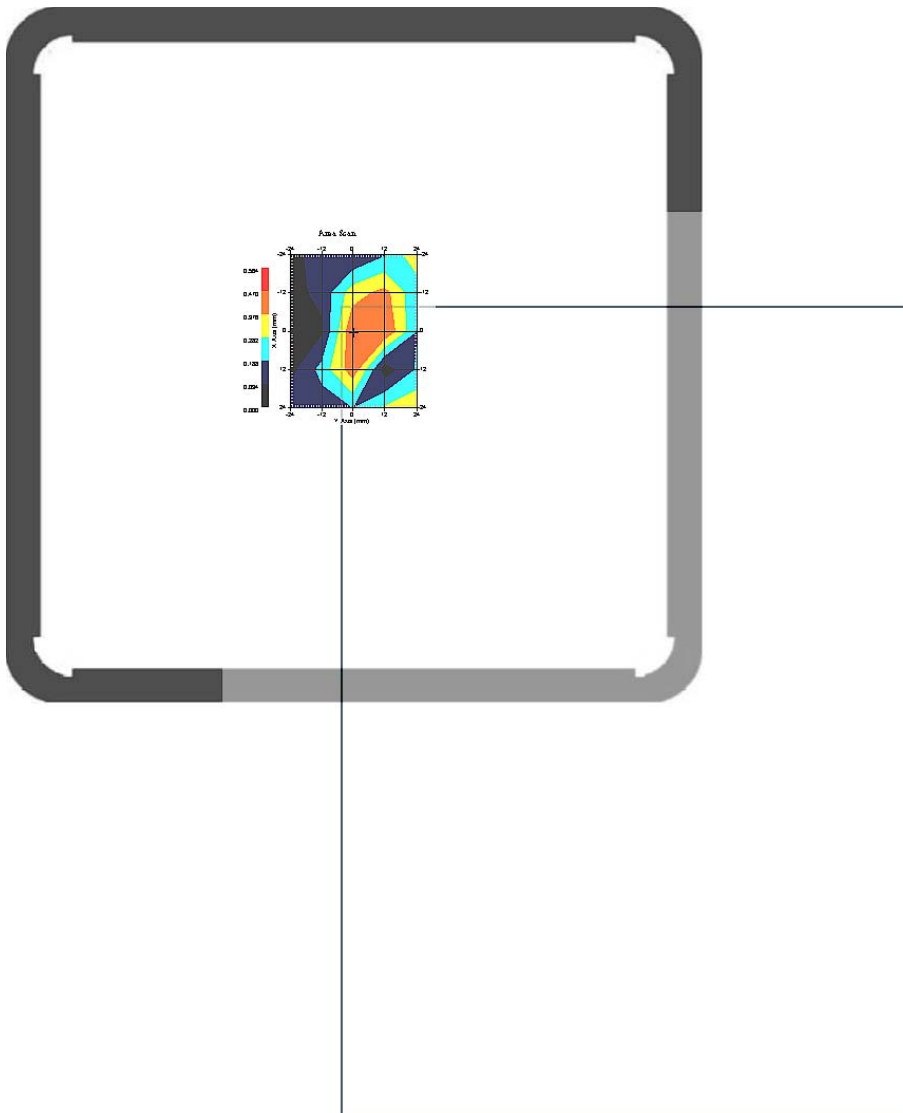

1 gram SAR value : 0.445 W/kg
10 gram SAR value : 0.291 W/kg
Area Scan Peak SAR : 0.471 W/kg
Zoom Scan Peak SAR : 0.600 W/kg

This is previous page plot (zoom in)

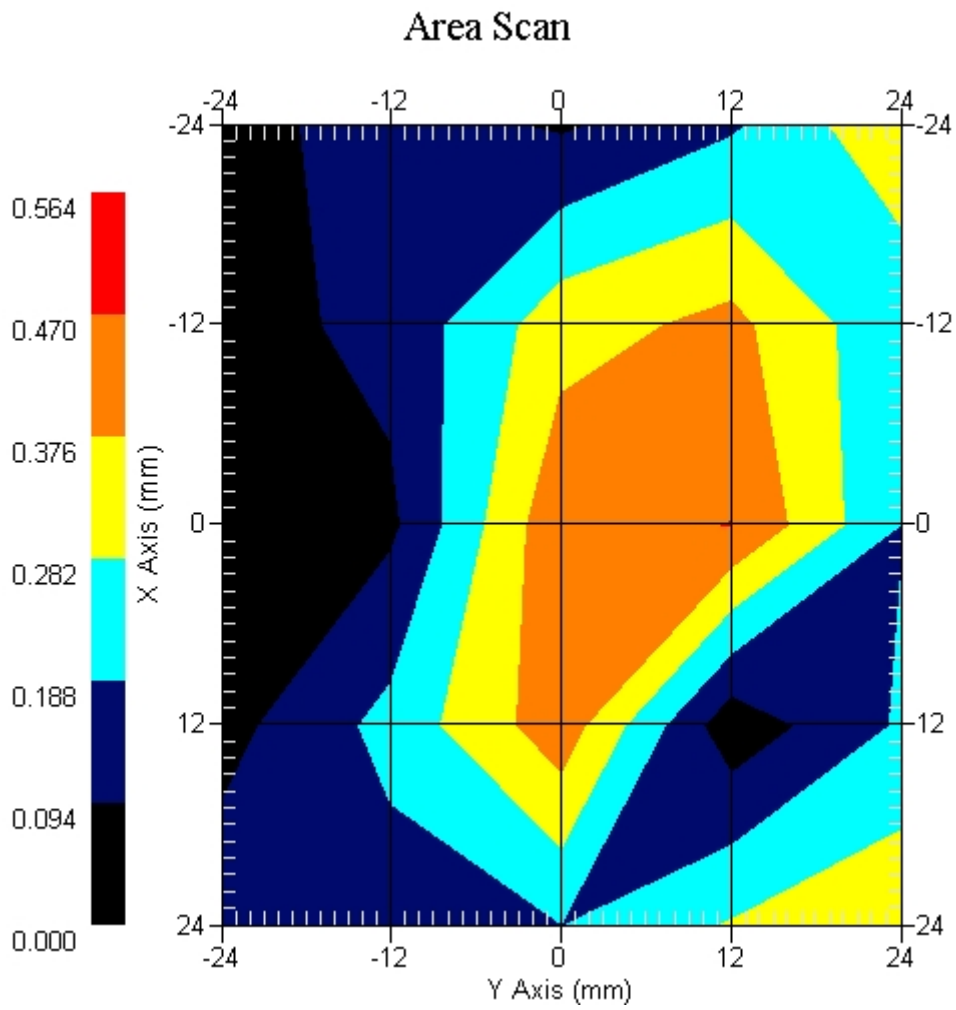

Measurement Data

Crest Factor : 1
Tissue Temp. : 21.60 °C
Ambient Temp. : 22.50 °C
Area Scan : 5x5x1 : Measurement x=12mm, y=12mm, z=4mm
Zoom Scan : 9x9x7 : Measurement x=4mm, y=4mm, z=5mm
Power Drift-Start : 0.025 W/kg
Power Drift-Finish: 0.025 W/kg
Power Drift (%) : -0.688

DUT Position : Touch
Channel : 149

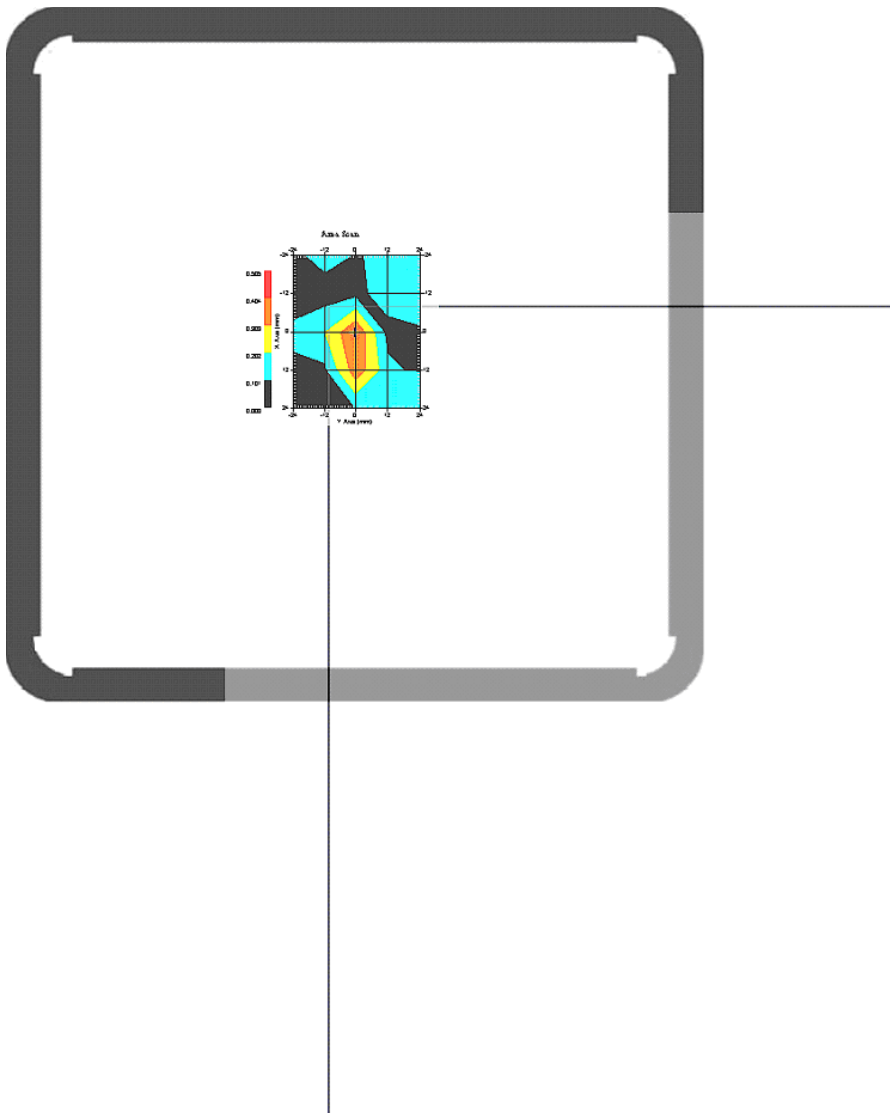

1 gram SAR value : 0.322 W/kg
10 gram SAR value : 0.257 W/kg
Area Scan Peak SAR : 0.504 W/kg
Zoom Scan Peak SAR : 0.544 W/kg

This is previous page plot (zoom in)

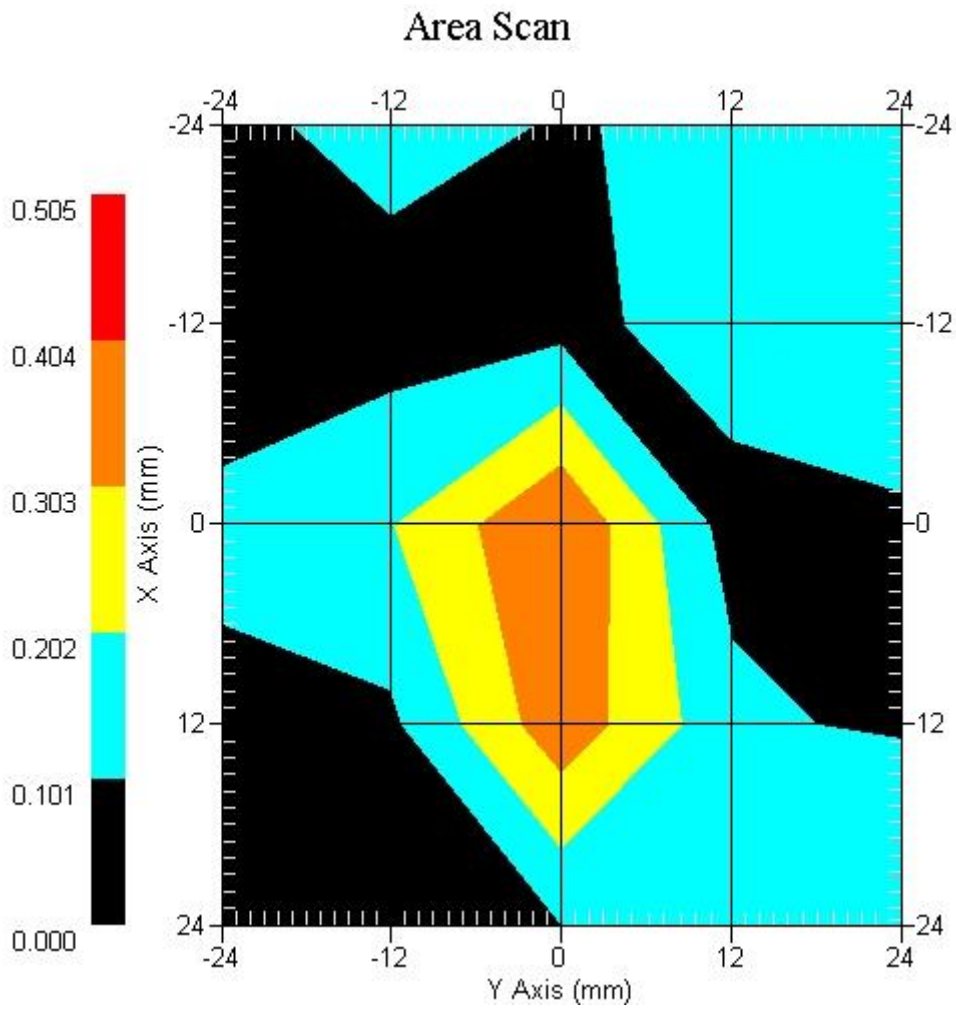

Measurement Data

Crest Factor : 1
 Tissue Temp. : 21.60 °C
 Ambient Temp. : 22.50 °C
 Area Scan : 5x5x1 : Measurement x=12mm, y=12mm, z=4mm
 Zoom Scan : 9x9x7 : Measurement x=4mm, y=4mm, z=5mm
 Power Drift-Start : 0.027 W/kg
 Power Drift-Finish: 0.027 W/kg
 Power Drift (%) : -0.935

DUT Position : Touch
 Channel : 157

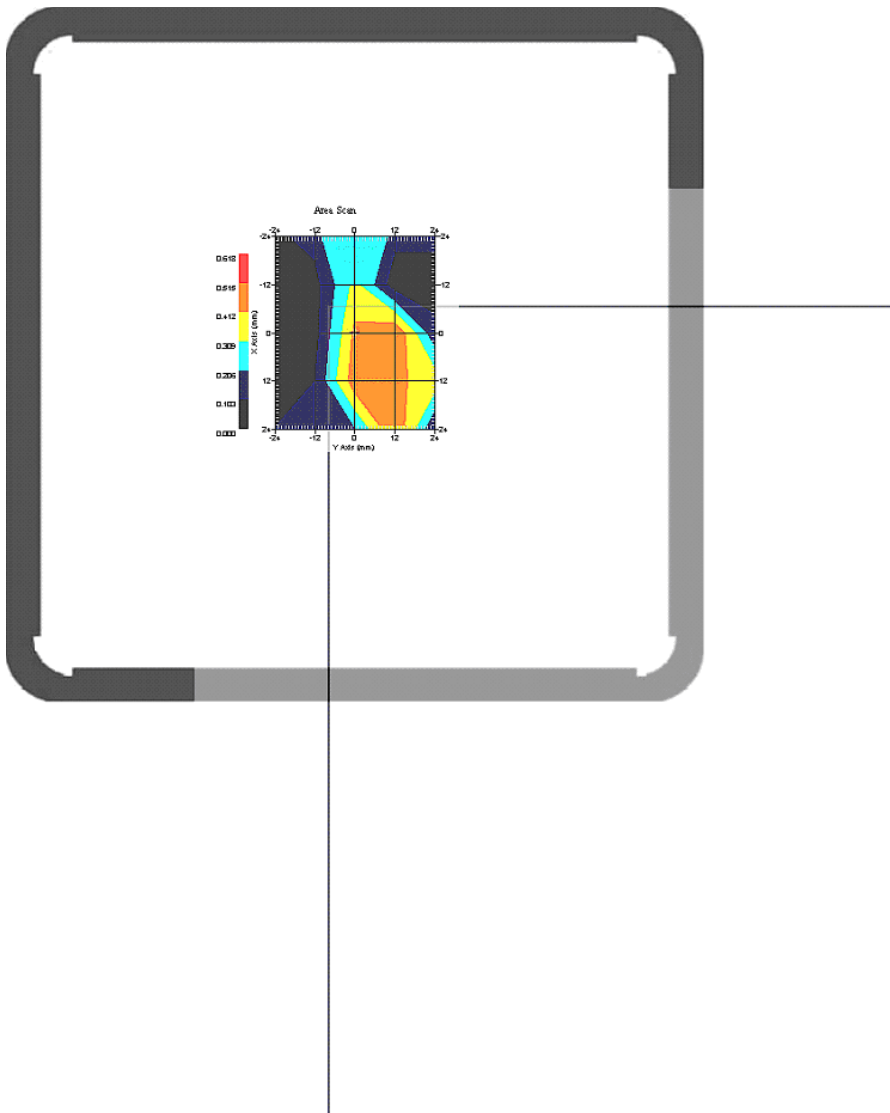

1 gram SAR value : 0.370 W/kg
 10 gram SAR value : 0.401 W/kg
 Area Scan Peak SAR : 0.516 W/kg
 Zoom Scan Peak SAR : 0.608 W/kg

This is previous page plot (zoom in)

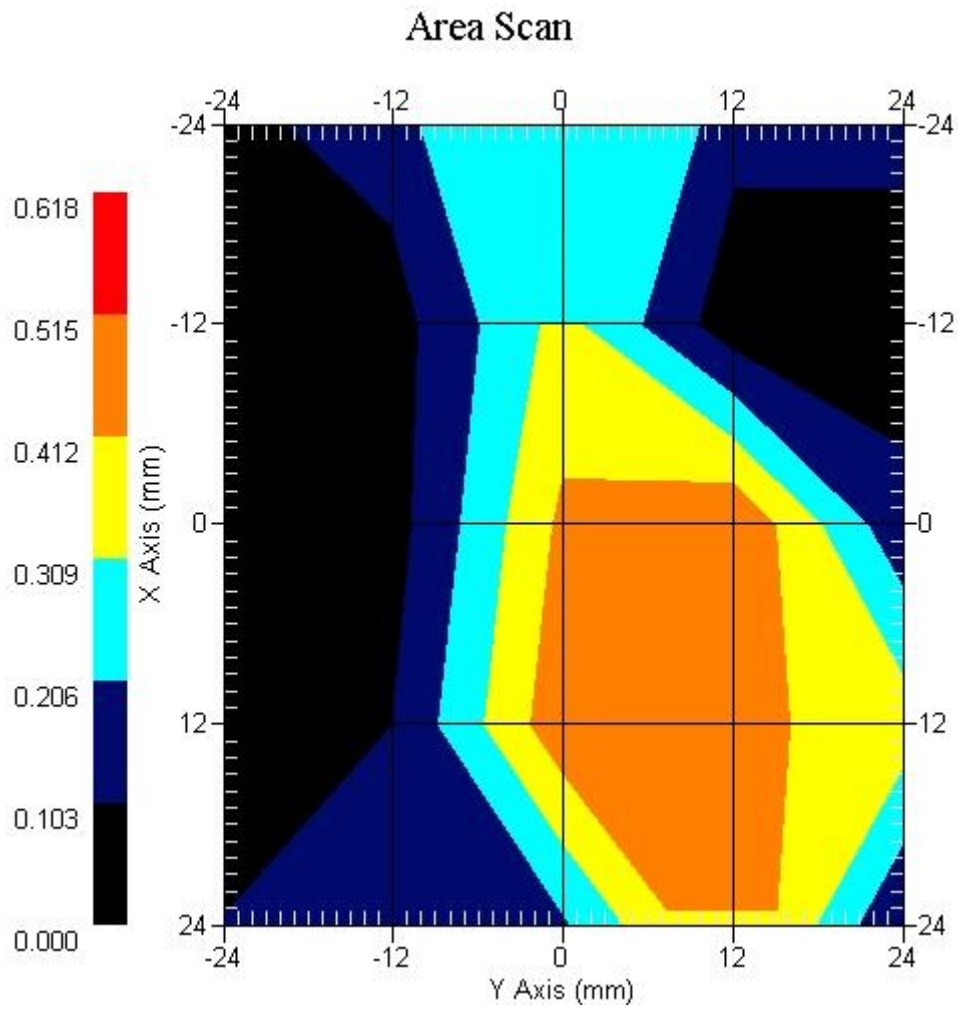

Measurement Data

Crest Factor : 1
 Tissue Temp. : 21.60 °C
 Ambient Temp. : 22.50 °C
 Area Scan : 5x5x1 : Measurement x=12mm, y=12mm, z=4mm
 Zoom Scan : 9x9x7 : Measurement x=4mm, y=4mm, z=5mm
 Power Drift-Start : 0.028 W/kg
 Power Drift-Finish: 0.028 W/kg
 Power Drift (%) : -0.390

DUT Position : Touch
 Channel : 165

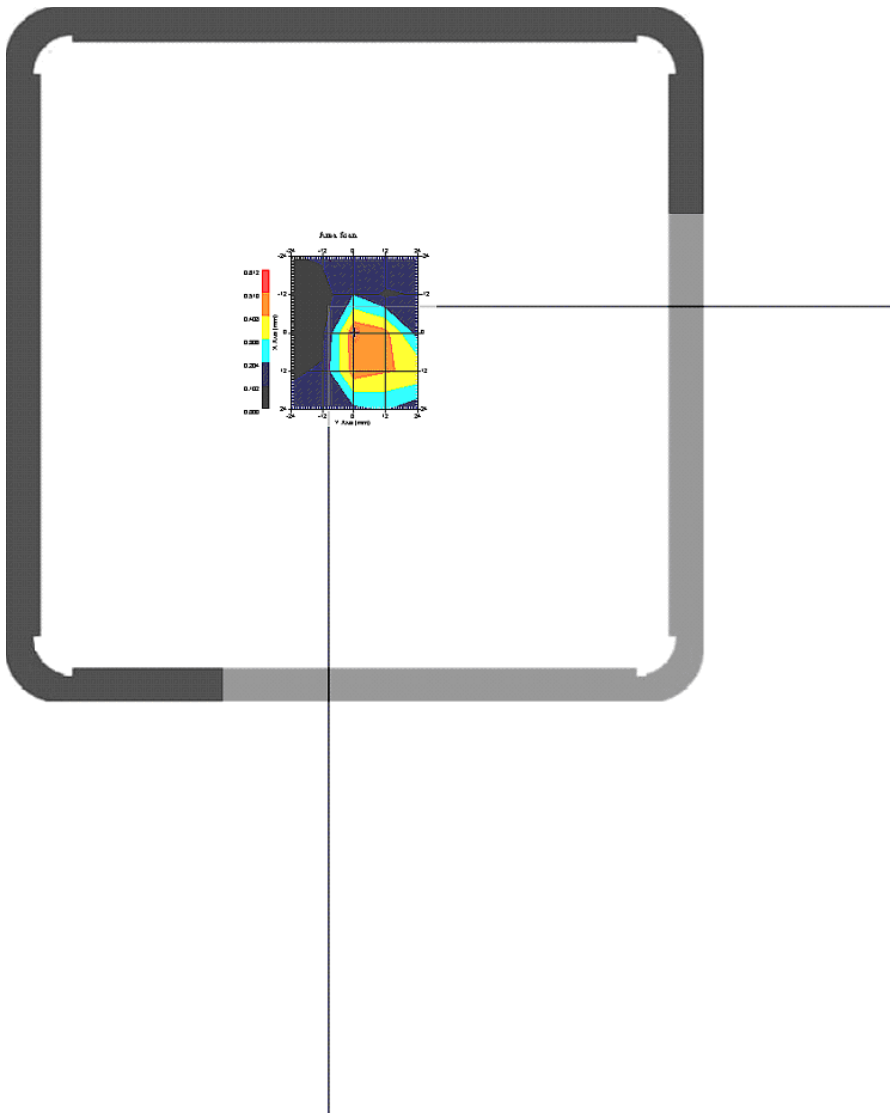

1 gram SAR value : 0.265 W/kg
 10 gram SAR value : 0.305 W/kg
 Area Scan Peak SAR : 0.511 W/kg
 Zoom Scan Peak SAR : 0.564 W/kg

This is previous page plot (zoom in)

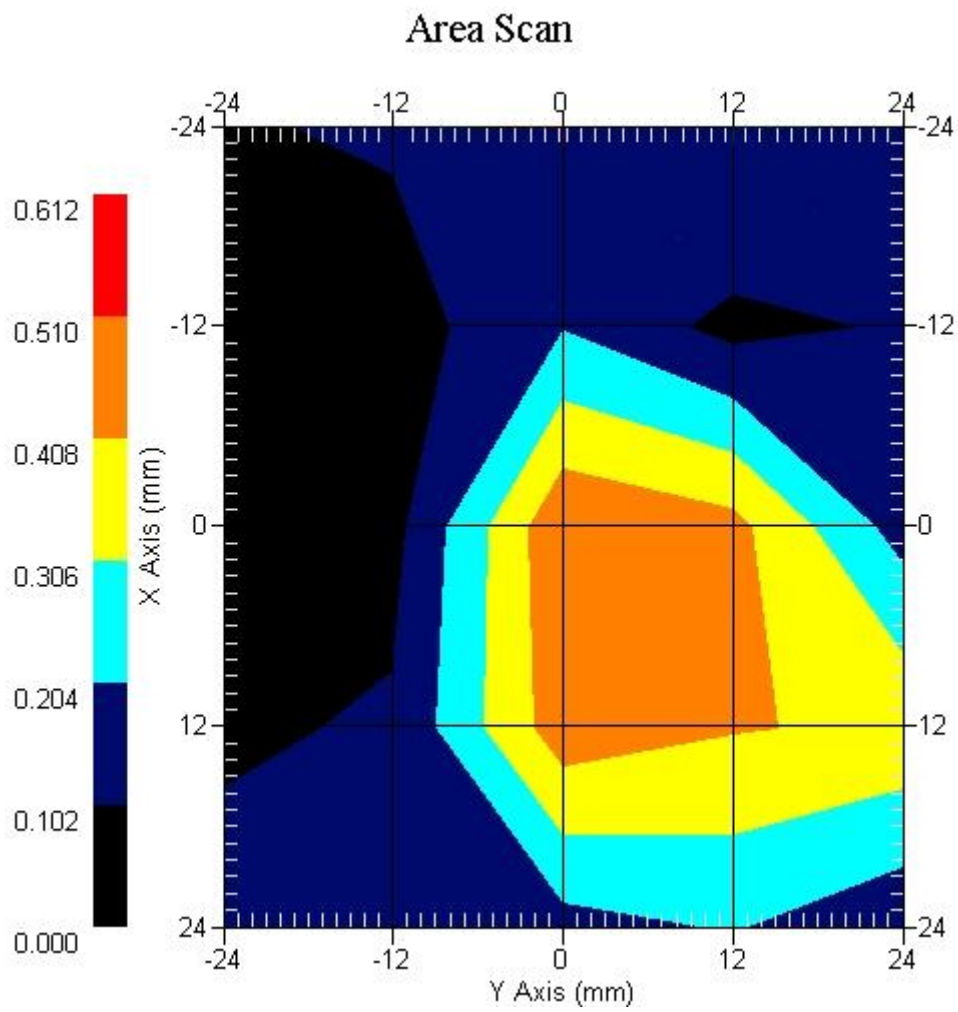

ALSAS-10U VER 2.3.6 APREL Laboratories

SAR Test Report -802.11n(20M), 5800 MHz - Tx3 Antenna

Report Date : 01-Dec-2008
Measurement Date : 01-Dec-2008

Product Data

Device Name : NoteBook PC
Type : Other
Model : 9212XY
Frequency : 5800.00 MHz
Drift Time : 0 min(s)
Length : 296 mm
Width : 210 mm
Depth : 231 mm
Antenna Type : Internal

Phantom Data

Type : Uni-Phantom
Size (mm) : 280 x 280 x 200
Location : Center

Tissue Data

Type : BODY
Serial No. : 327-B
Frequency : 5800.00 MHz
Last Calib. Date : 01-Dec-2008
Temperature : 21.60 °C
Ambient Temp. : 22.50 °C
Humidity : 54.00 RH%
Epsilon : 49.10 F/m
Sigma : 6.14 S/m
Density : 1000.00 kg/cu. m

Probe Data

Name : Probe 265
Model : E020
Type : E-Field Triangle
Serial No. : 265
Last Calib. Date : 09-May-2008
Frequency : 5800.00 MHz
Duty Cycle Factor: 1
Conversion Factor: 3.9
Probe Sensitivity: 1.20 1.20 1.20 $\mu\text{V}/(\text{V}/\text{m})^2$
Compression Point: 95.00 mV
Offset : 1.56 mm

Measurement Data

Crest Factor : 1
Tissue Temp. : 21.60 °C
Ambient Temp. : 22.50 °C
Area Scan : 5x5x1 : Measurement x=12mm, y=12mm, z=4mm
Zoom Scan : 9x9x7 : Measurement x=4mm, y=4mm, z=5mm
Power Drift-Start : 0.036 W/kg
Power Drift-Finish: 0.036 W/kg
Power Drift (%) : 0.461

DUT Position : Touch
Channel : 140

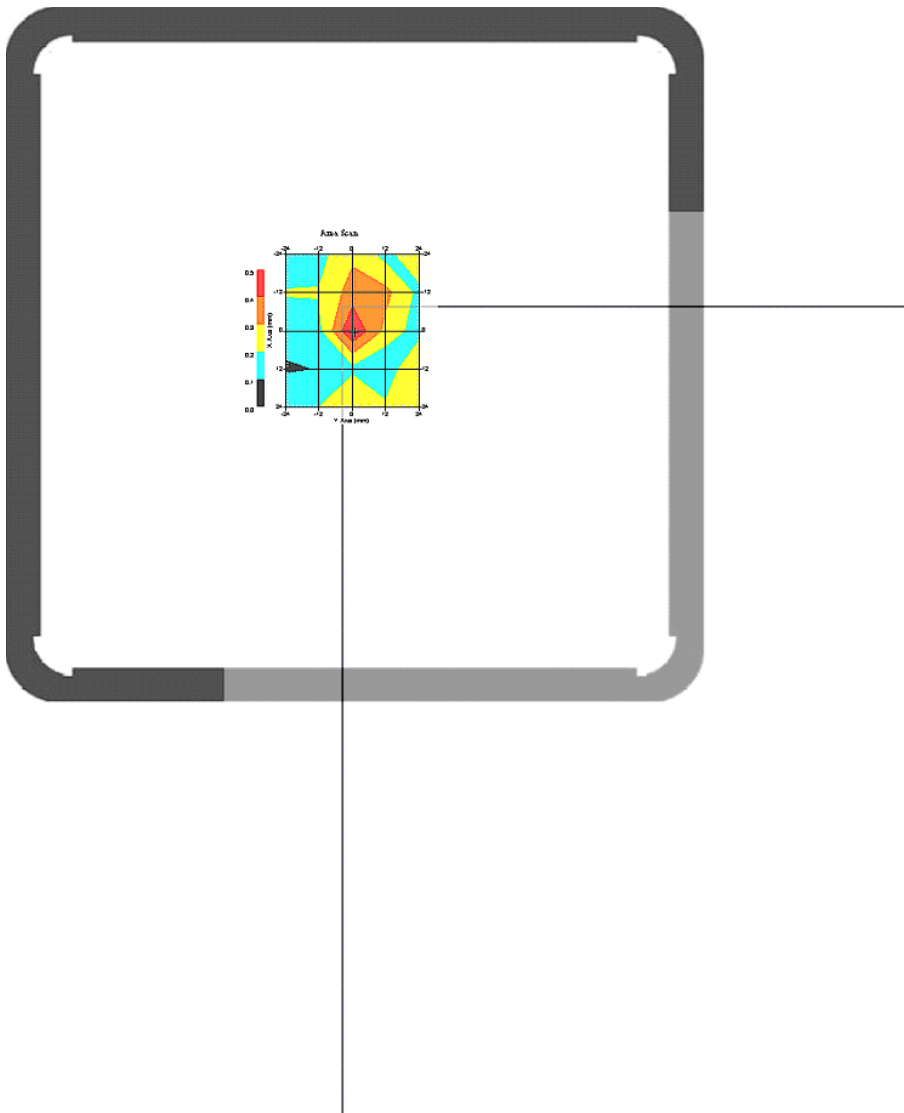

1 gram SAR value : 0.305 W/kg
10 gram SAR value : 0.295 W/kg
Area Scan Peak SAR : 0.500 W/kg
Zoom Scan Peak SAR : 0.579 W/kg

This is previous page plot (zoom in)

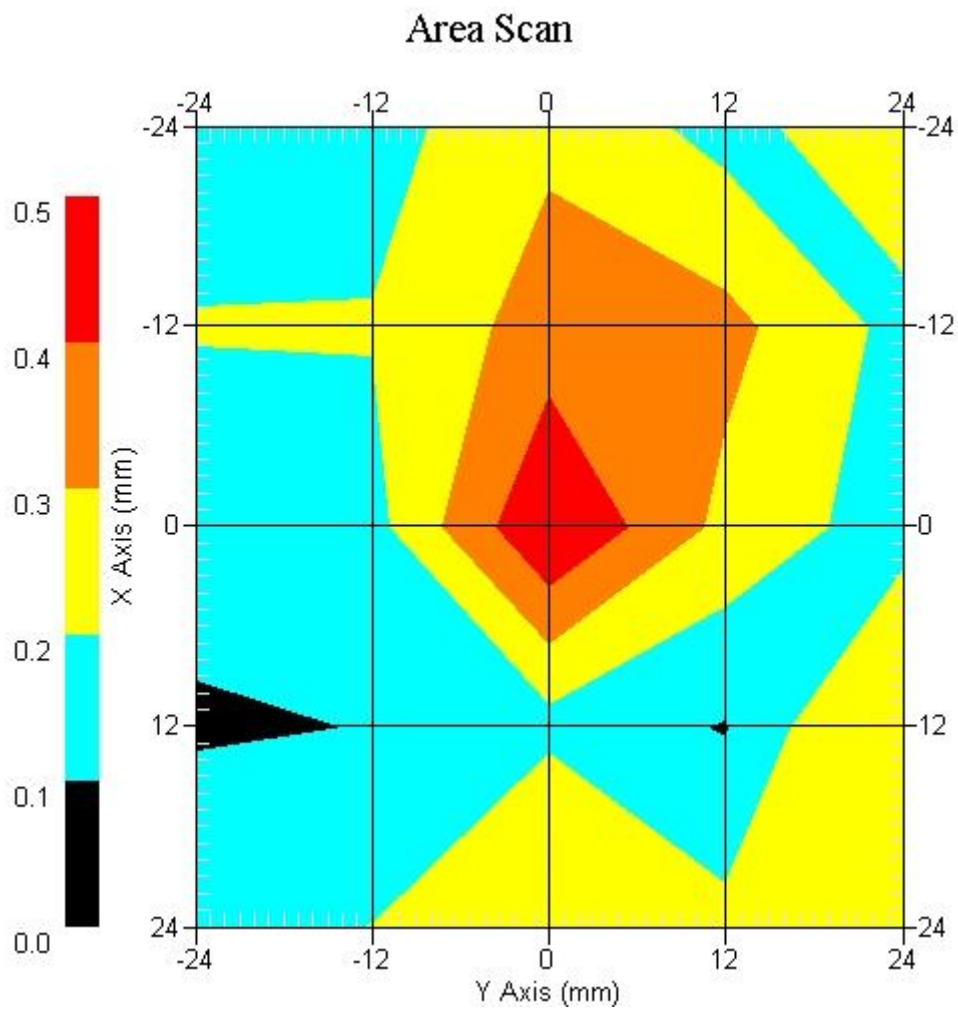

ALSAS-10U VER 2.3.6 APREL Laboratories

SAR Test Report -802.11n(40M), 5800 MHz - Tx3 Antenna

Report Date : 01-Dec-2008
Measurement Date : 01-Dec-2008

Product Data

Device Name : NoteBook PC
Type : Other
Model : 9212XY
Frequency : 5800.00 MHz
Drift Time : 0 min(s)
Length : 296 mm
Width : 210 mm
Depth : 231 mm
Antenna Type : Internal

Phantom Data

Type : Uni-Phantom
Size (mm) : 280 x 280 x 200
Location : Center

Tissue Data

Type : BODY
Serial No. : 327-B
Frequency : 5800.00 MHz
Last Calib. Date : 01-Dec-2008
Temperature : 21.60 °C
Ambient Temp. : 22.50 °C
Humidity : 54.00 RH%
Epsilon : 49.10 F/m
Sigma : 6.14 S/m
Density : 1000.00 kg/cu. m

Probe Data

Name : Probe 265
Model : E020
Type : E-Field Triangle
Serial No. : 265
Last Calib. Date : 09-May-2008
Frequency : 5800.00 MHz
Duty Cycle Factor: 1
Conversion Factor: 3.9
Probe Sensitivity: 1.20 1.20 1.20 $\mu\text{V}/(\text{V}/\text{m})^2$
Compression Point: 95.00 mV
Offset : 1.56 mm

Measurement Data

Crest Factor : 1
Tissue Temp. : 21.60 °C
Ambient Temp. : 22.50 °C
Area Scan : 5x5x1 : Measurement x=12mm, y=12mm, z=4mm
Zoom Scan : 9x9x7 : Measurement x=4mm, y=4mm, z=5mm
Power Drift-Start : 0.020 W/kg
Power Drift-Finish: 0.020 W/kg
Power Drift (%) : -0.128

DUT Position : Touch
Channel : 134

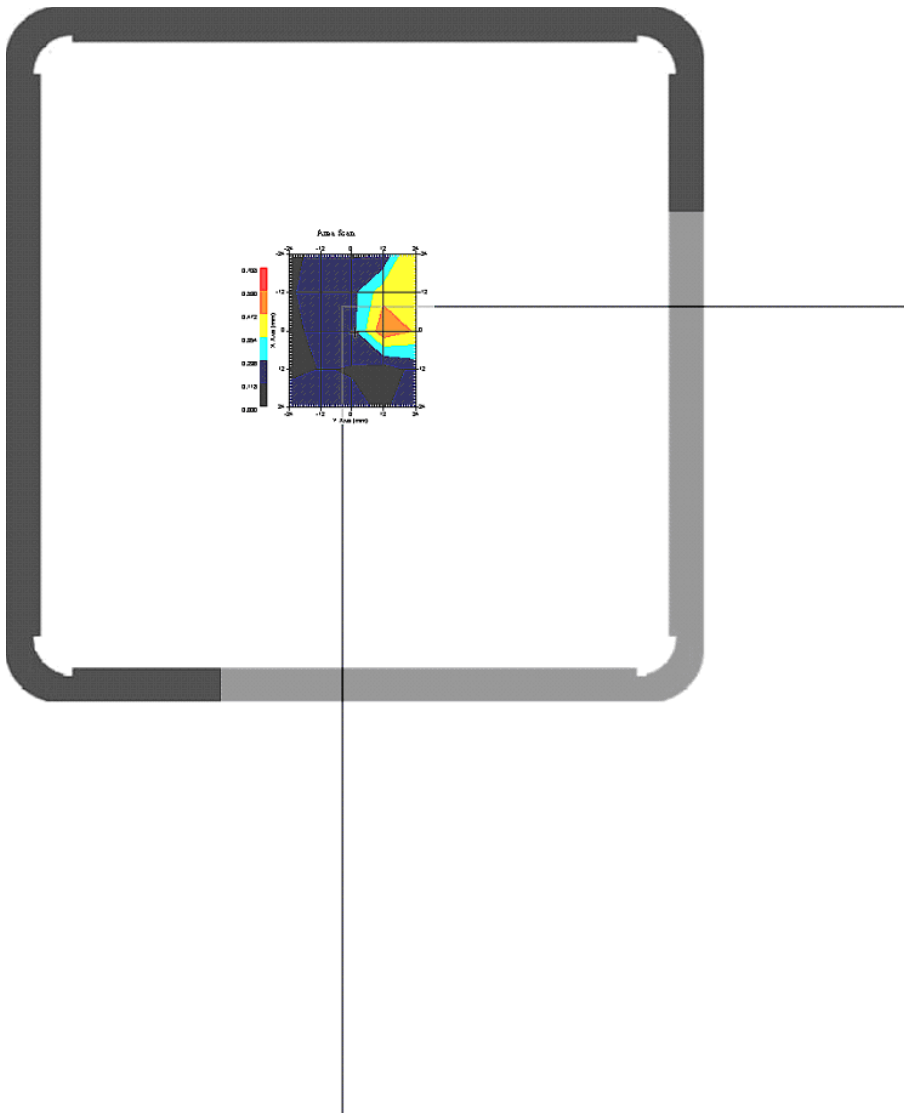

1 gram SAR value : 0.328 W/kg
10 gram SAR value : 0.258 W/kg
Area Scan Peak SAR : 0.592 W/kg
Zoom Scan Peak SAR : 0.680 W/kg

This is previous page plot (zoom in)

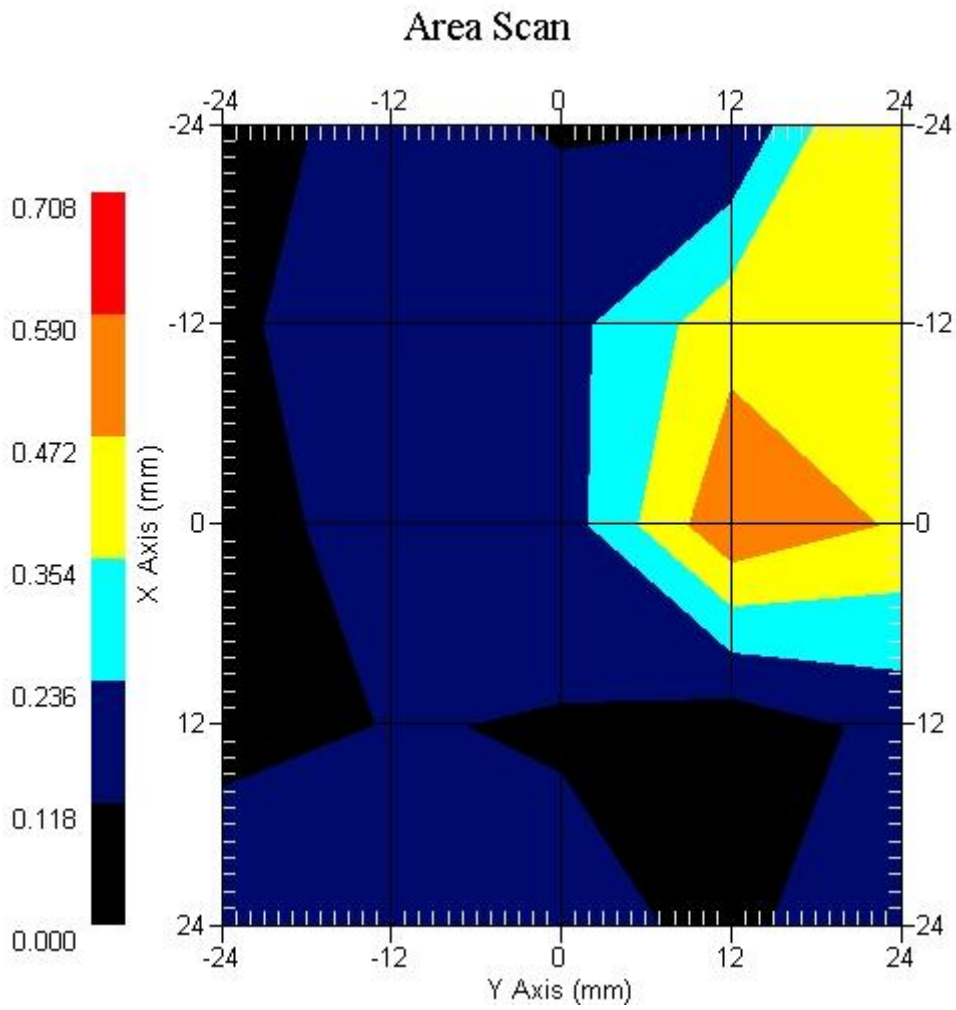

ALSAS-10U VER 2.3.6 APREL Laboratories

SAR Test Report -802.11n(20M), 5800 MHz - Tx1 Antenna

Report Date : 01-Dec-2008
Measurement Date : 01-Dec-2008

Product Data

Device Name : NoteBook PC
Type : Other
Model : 9212XY
Frequency : 5800.00 MHz
Drift Time : 0 min(s)
Length : 296 mm
Width : 210 mm
Depth : 231 mm
Antenna Type : Internal

Phantom Data

Type : Uni-Phantom
Size (mm) : 280 x 280 x 200
Location : Center

Tissue Data

Type : BODY
Serial No. : 327-B
Frequency : 5800.00 MHz
Last Calib. Date : 01-Dec-2008
Temperature : 21.60 °C
Ambient Temp. : 22.50 °C
Humidity : 54.00 RH%
Epsilon : 49.10 F/m
Sigma : 6.14 S/m
Density : 1000.00 kg/cu. m

Probe Data

Name : Probe 265
Model : E020
Type : E-Field Triangle
Serial No. : 265
Last Calib. Date : 09-May-2008
Frequency : 5800.00 MHz
Duty Cycle Factor: 1
Conversion Factor: 3.9
Probe Sensitivity: 1.20 1.20 1.20 $\mu\text{V}/(\text{V}/\text{m})^2$
Compression Point: 95.00 mV
Offset : 1.56 mm

Measurement Data

Crest Factor : 1
 Tissue Temp. : 21.60 °C
 Ambient Temp. : 22.50 °C
 Area Scan : 5x5x1 : Measurement x=12mm, y=12mm, z=4mm
 Zoom Scan : 9x9x7 : Measurement x=4mm, y=4mm, z=5mm
 Power Drift-Start : 0.031 W/kg
 Power Drift-Finish: 0.031 W/kg
 Power Drift (%) : -0.155

DUT Position : Touch
 Channel : 140

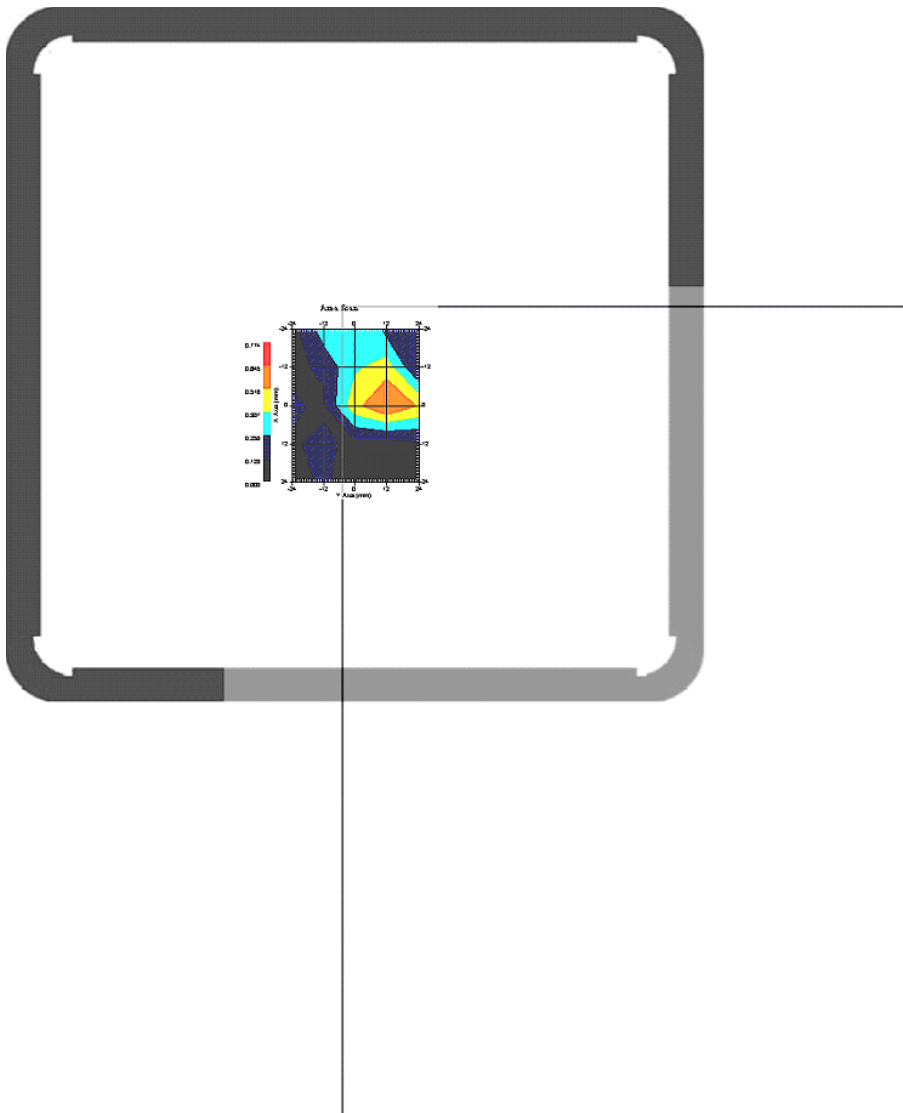

1 gram SAR value : 0.323 W/kg
 10 gram SAR value : 0.282 W/kg
 Area Scan Peak SAR : 0.647 W/kg
 Zoom Scan Peak SAR : 0.570 W/kg

This is previous page plot (zoom in)

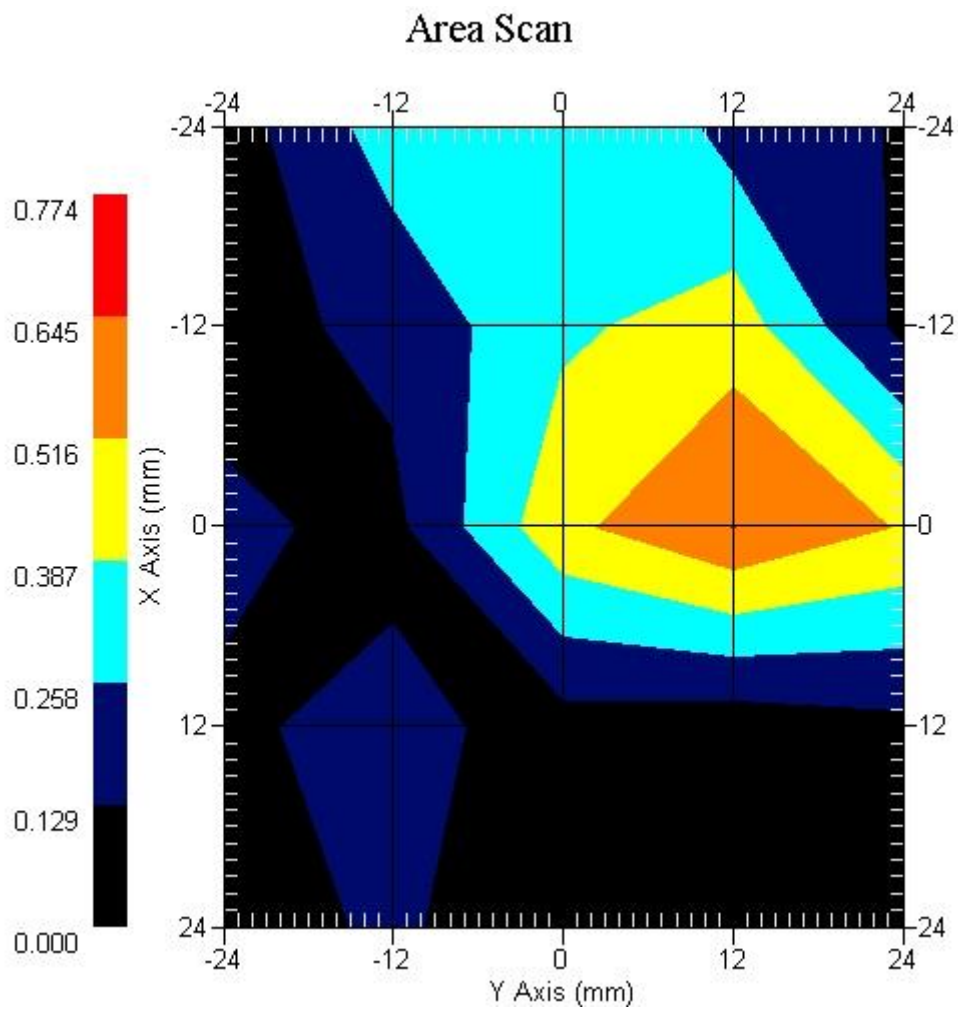

ALSAS-10U VER 2.3.6 APREL Laboratories

SAR Test Report -802.11n(20M), 5800 MHz - Tx2 Antenna

Report Date : 01-Dec-2008
Measurement Date : 01-Dec-2008

Product Data

Device Name : NoteBook PC
Type : Other
Model : 9212XY
Frequency : 5800.00 MHz
Drift Time : 0 min(s)
Length : 296 mm
Width : 210 mm
Depth : 231 mm
Antenna Type : Internal

Phantom Data

Type : Uni-Phantom
Size (mm) : 280 x 280 x 200
Location : Center

Tissue Data

Type : BODY
Serial No. : 327-B
Frequency : 5800.00 MHz
Last Calib. Date : 01-Dec-2008
Temperature : 21.60 °C
Ambient Temp. : 22.50 °C
Humidity : 54.00 RH%
Epsilon : 49.10 F/m
Sigma : 6.14 S/m
Density : 1000.00 kg/cu. m

Probe Data

Name : Probe 265
Model : E020
Type : E-Field Triangle
Serial No. : 265
Last Calib. Date : 09-May-2008
Frequency : 5800.00 MHz
Duty Cycle Factor: 1
Conversion Factor: 3.9
Probe Sensitivity: 1.20 1.20 1.20 $\mu\text{V}/(\text{V}/\text{m})^2$
Compression Point: 95.00 mV
Offset : 1.56 mm

Measurement Data

Crest Factor : 1
 Tissue Temp. : 21.60 °C
 Ambient Temp. : 22.50 °C
 Area Scan : 5x5x1 : Measurement x=12mm, y=12mm, z=4mm
 Zoom Scan : 9x9x7 : Measurement x=4mm, y=4mm, z=5mm
 Power Drift-Start : 0.028 W/kg
 Power Drift-Finish: 0.028 W/kg
 Power Drift (%) : -0.108

DUT Position : Touch
 Channel : 140

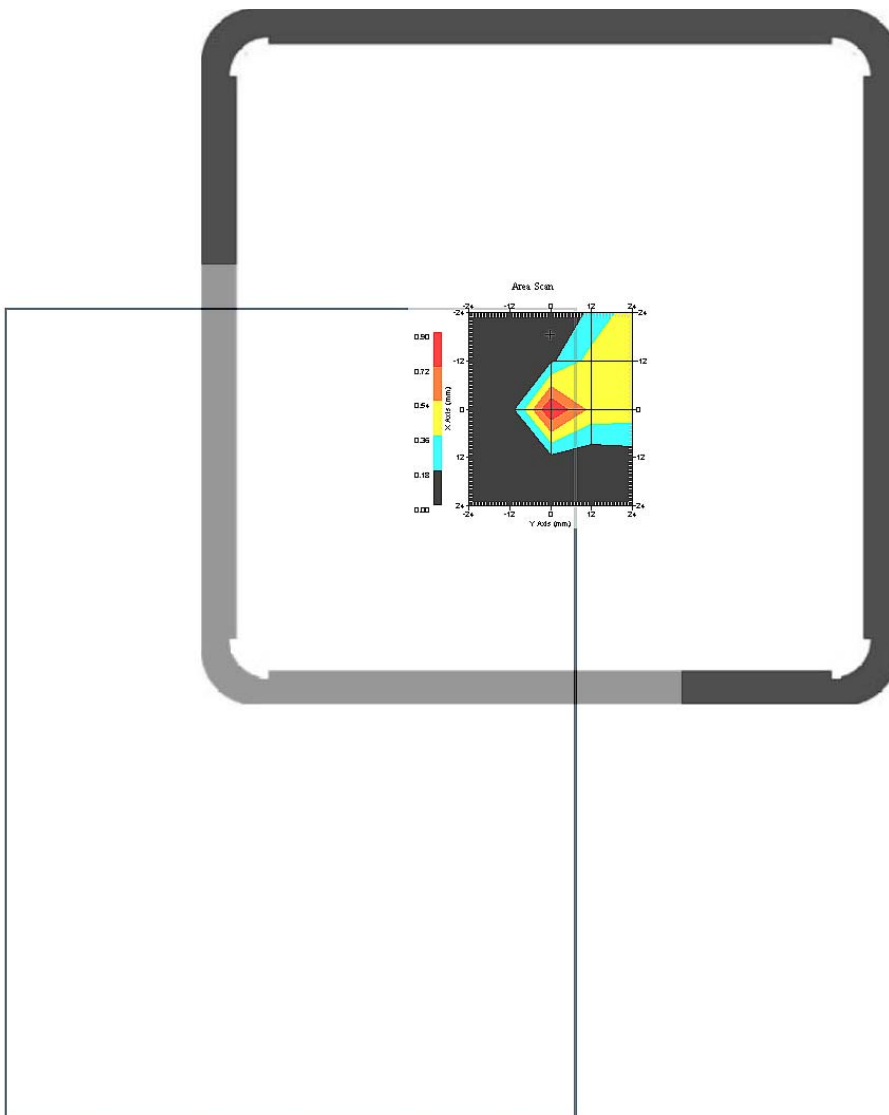

1 gram SAR value : 0.354 W/kg
 10 gram SAR value : 0.206 W/kg
 Area Scan Peak SAR : 0.499 W/kg
 Zoom Scan Peak SAR : 0.540 W/kg

This is previous page plot (zoom in)

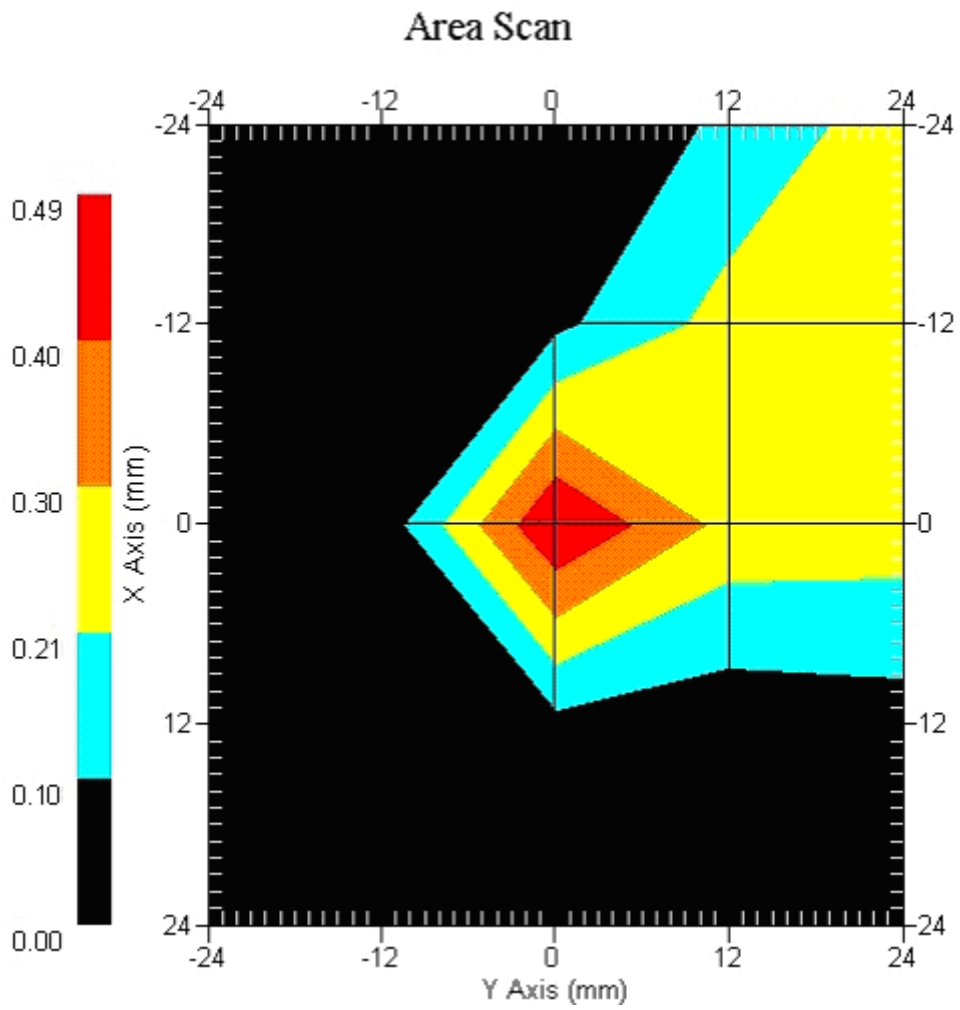

802.11a, 5800 MHz- Tx3 Antenna, Bottom Z-Axis plot
Channel: 140

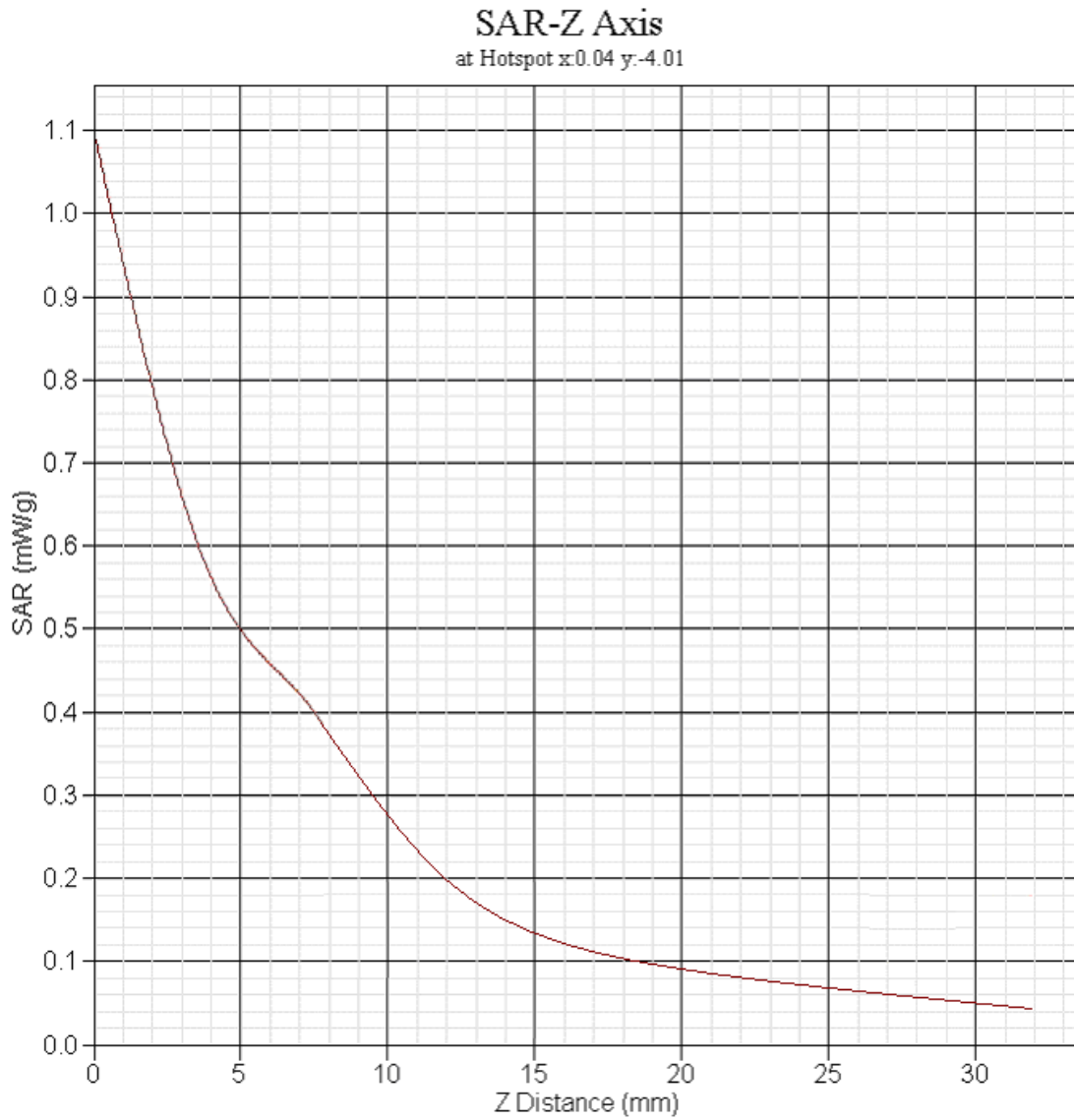

Appendix C. Test Setup Photographs & EUT Photographs
Test Setup Photographs

EUT Bottom-Tx1 Antenna



EUT Bottom-Tx2 Antenna

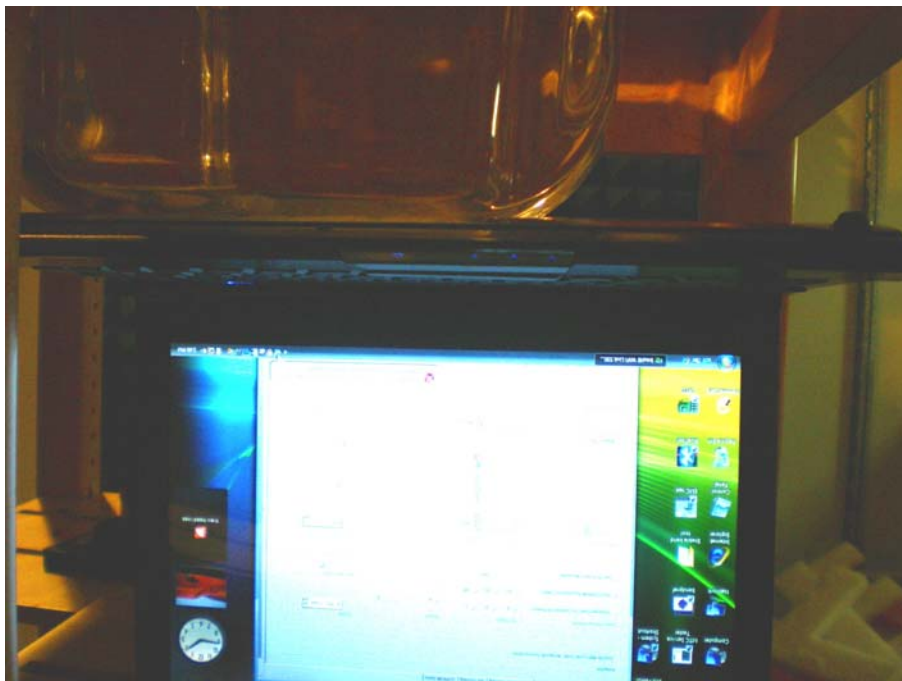

EUT Bottom-Tx3 Antenna

Note: The positions used in the measurements were according to IEEE 1528-2003.

EUT Photographs





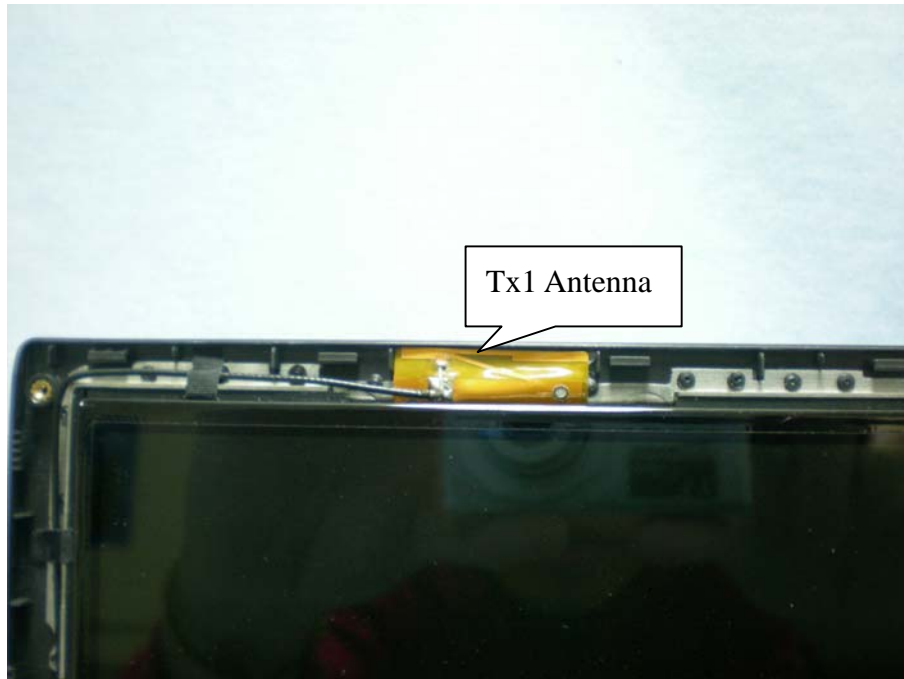

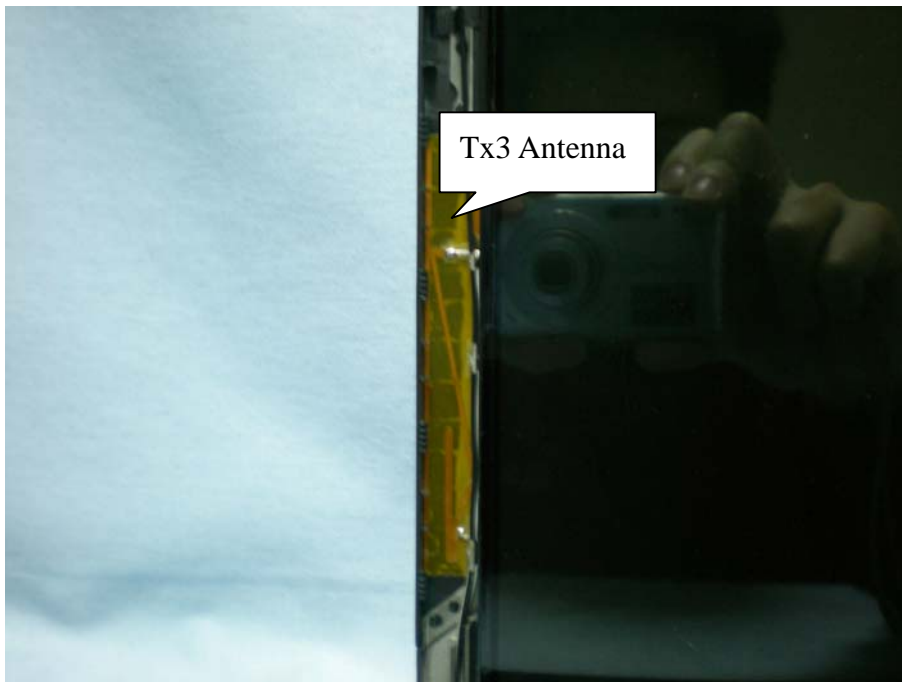
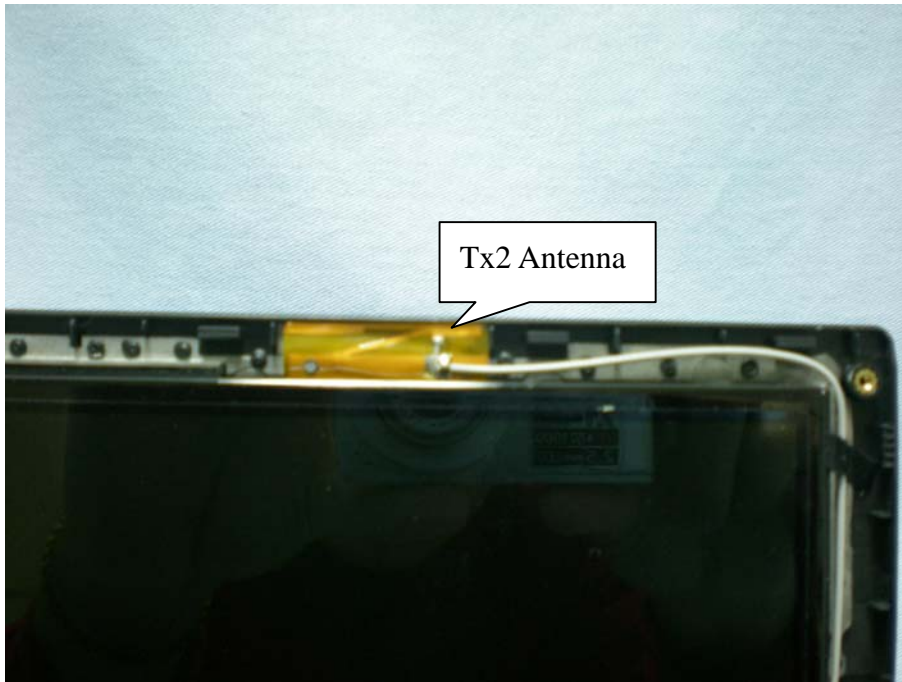



Appendix D. Probe Calibration Data

Miniature Isotropic RF Probe

M/N: ALS-E-020

S/N: 265

2450 MHz Head Calibration

2450 MHz Body Calibration

NCL CALIBRATION LABORATORIES

Calibration File No.: CP-879

Client: QUIETEK

CERTIFICATE OF CALIBRATION

It is certified that the equipment identified below has been calibrated in the **NCL CALIBRATION LABORATORIES** by qualified personnel following recognized procedures and using transfer standards traceable to NRC/NIST.

Equipment: Miniature Isotropic RF Probe 2450 MHz

Manufacturer: APREL Laboratories

Model No.: ALS-E-020

Serial No.: 265

HEAD Calibration

Calibration Procedure: SSI/DRB-TP-D01-032-E020-V2

Project No: QTKB-ALS-E20-CAL-5335

Calibrated: 9th May 2008
Released on: 9th May 2008

This Calibration Certificate is Incomplete Unless Accompanied with the Calibration Results Summary

Released By: _____

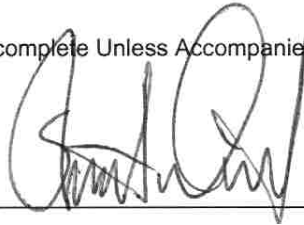

NCL CALIBRATION LABORATORIES

51 SPECTRUM WAY
NEPEAN, ONTARIO
CANADA K2R 1E6

Division of APREL Lab.
TEL: (613) 820-4988
FAX: (613) 820-4161

Introduction

This Calibration Report reproduces the results of the calibration performed in line with the SSI/DRB-TP-D01-032-E020-V2 E-Field Probe Calibration Procedure. The results contained within this report are for APREL E-Field Probe E-020 265.

References

SSI/DRB-TP-D01-032-E020-V2 E-Field Probe Calibration Procedure
IEEE 1528 "Recommended Practice for Determining the Peak Spatial-Average Specific Absorption Rate (SAR) in the Human Head Due to Wireless Communications Devices: Experimental Techniques"
SSI-TP-011 Tissue Calibration Procedure
IEC 62209 "Human exposure to radio frequency fields from hand-held and Head-mounted wireless communication devices – Human models, instrumentation, and procedures –Part 1 & 2: Procedure to determine the Specific Absorption Rate (SAR) for hand-held devices used in close proximity of the ear (frequency range of 300 MHz to 3 GHz)"
IEEE 1309 Draft Standard for Calibration of Electromagnetic Field Sensors and Probes, Excluding Antennas, from 9kHz to 40GHz

Conditions

Probe 265 is a re-calibration.

Ambient Temperature of the Laboratory: 22 °C +/- 0.5°C

Temperature of the Tissue: 21 °C +/- 0.5°C

We the undersigned attest that to the best of our knowledge the calibration of this probe has been accurately conducted and that all information contained within this report has been reviewed for accuracy.

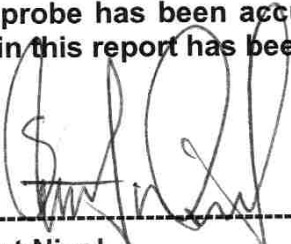

Stuart Nicol

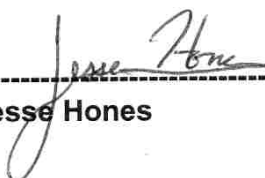

Jesse Hones

Calibration Results Summary

Probe Type:	E-Field Probe E-020
Serial Number:	265
Frequency:	2450 MHz
Sensor Offset:	1.56 mm
Sensor Length:	2.5 mm
Tip Enclosure:	Ertalyte*
Tip Diameter:	<5 mm
Tip Length:	60 mm
Total Length:	290 mm

*Resistive to recommended tissue recipes per IEEE-1528

Sensitivity in Air

Channel X:	1.2 $\mu\text{V}/(\text{V}/\text{m})^2$
Channel Y:	1.2 $\mu\text{V}/(\text{V}/\text{m})^2$
Channel Z:	1.2 $\mu\text{V}/(\text{V}/\text{m})^2$
Diode Compression Point:	95 mV

Sensitivity in Head Tissue

Frequency: 2450 MHz

Epsilon: 39.2 (+/-5%) **Sigma:** 1.80 S/m (+/-5%)

ConvF

Channel X: 3.67

Channel Y: 3.67

Channel Z: 3.67

Tissue sensitivity values were calculated using the load impedance of the APREL Laboratories Daq-Paq.

Boundary Effect:

Uncertainty resulting from the boundary effect is less than 2% for the distance between the tip of the probe and the tissue boundary, when less than 2.44mm.

Spatial Resolution:

The measured probe tip diameter is 5 mm (+/- 0.01 mm) and therefore meets the requirements of SSI/DRB-TP-D01-032 for spatial resolution.

Receiving Pattern 2450 MHz (Air)

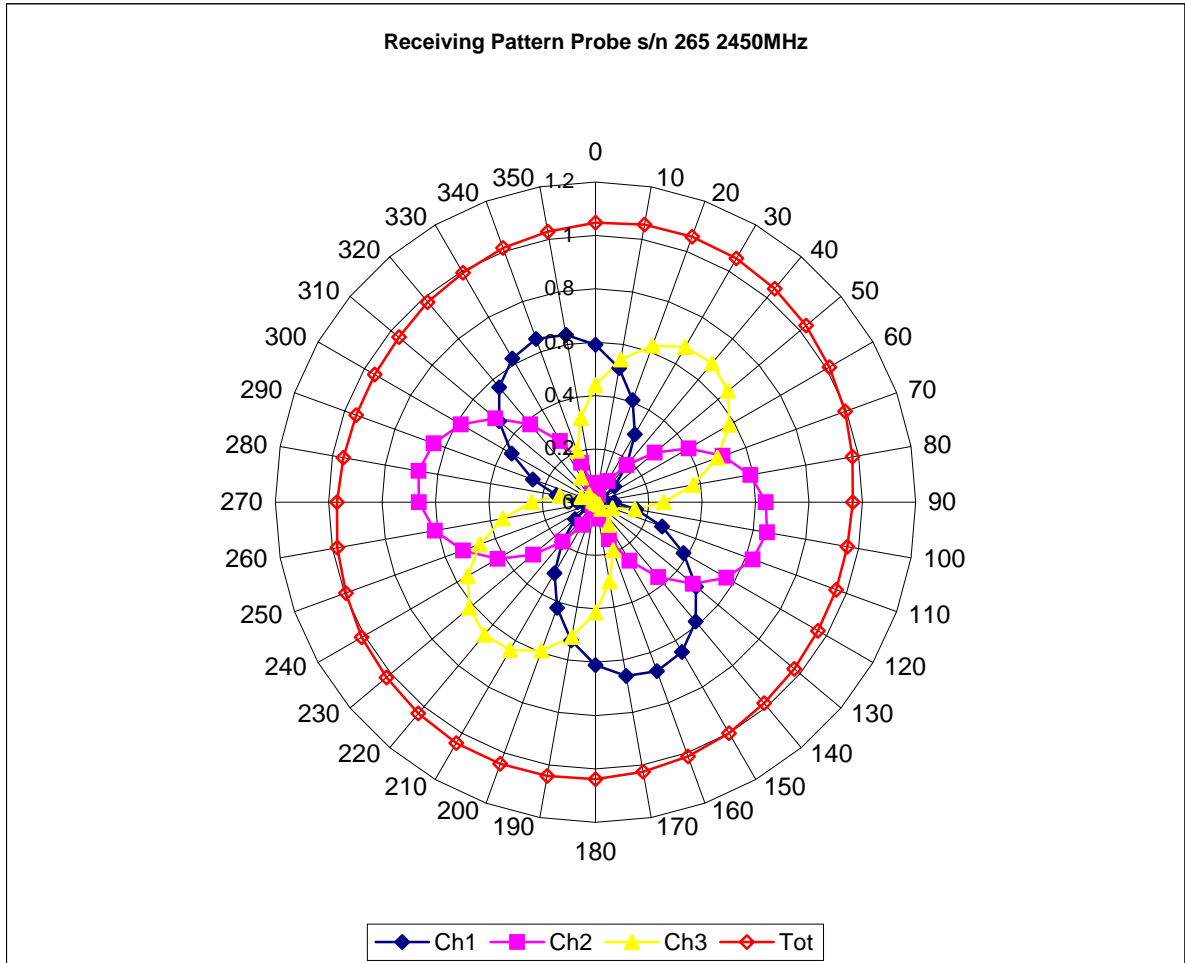

Isotropy Error 2450 MHz (Air)

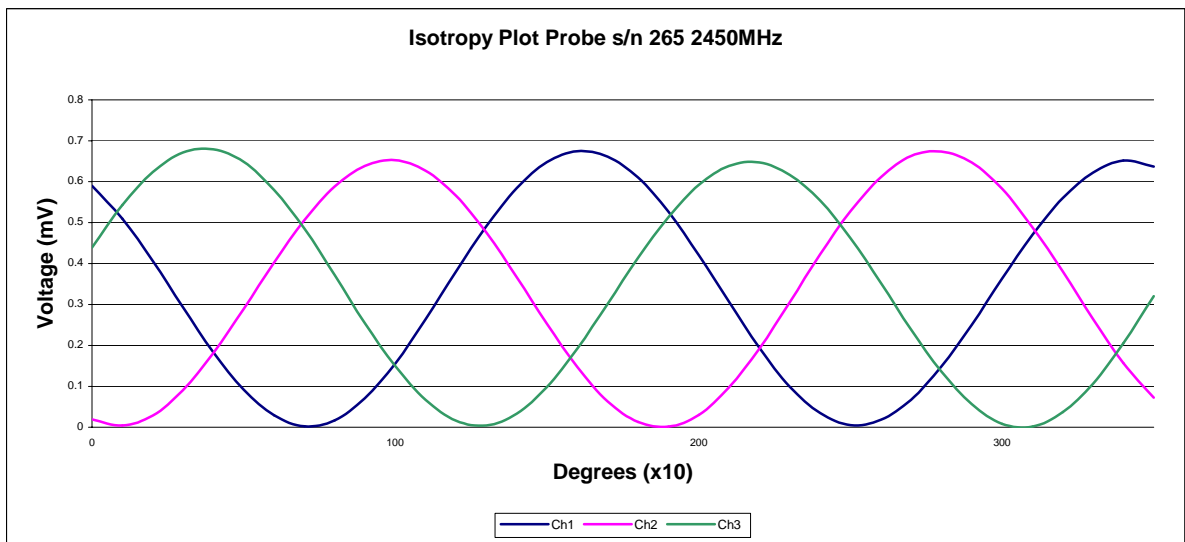
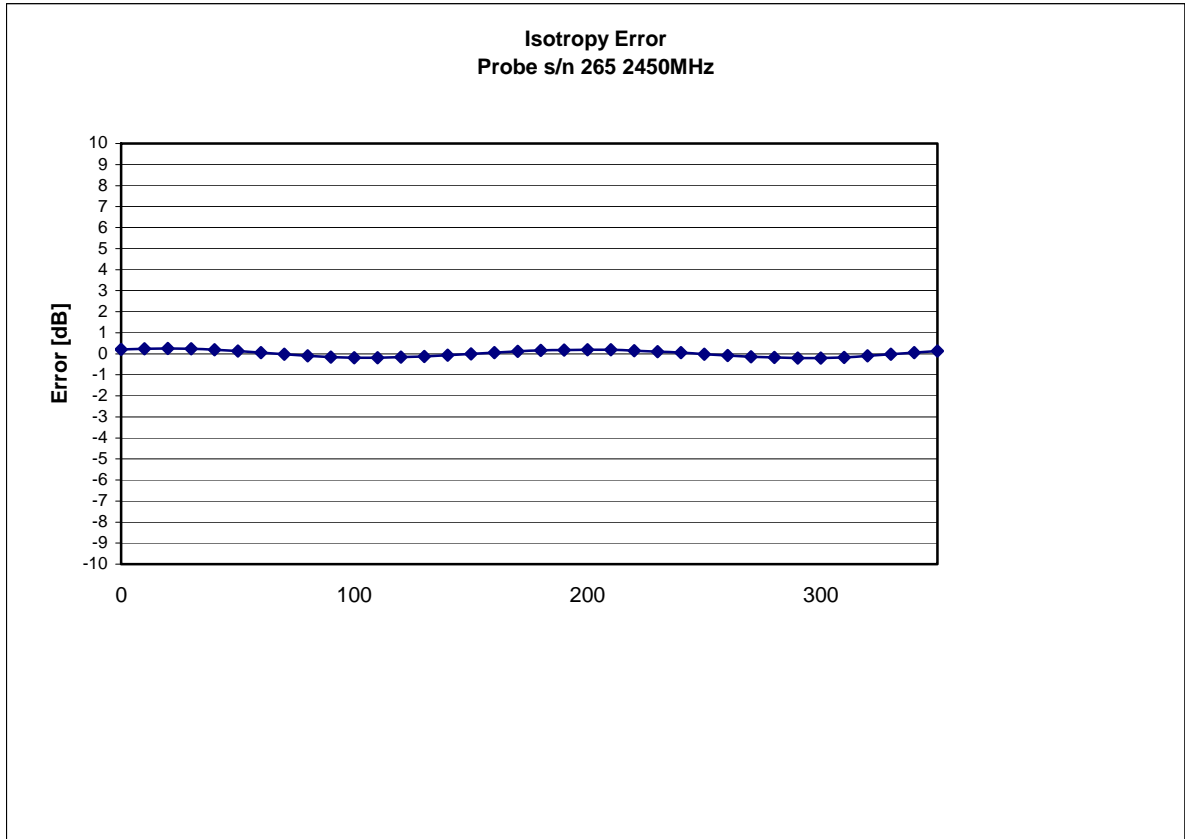

Isotropicity in Tissue:

0.10 dB

Dynamic Range

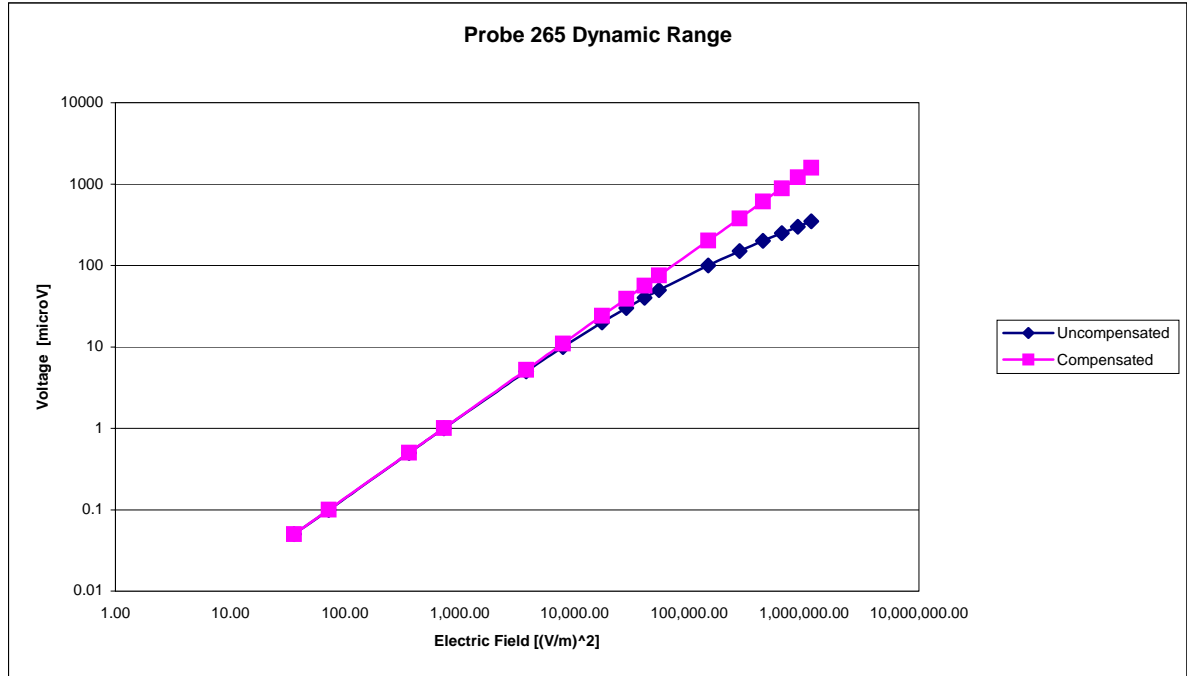

Video Bandwidth

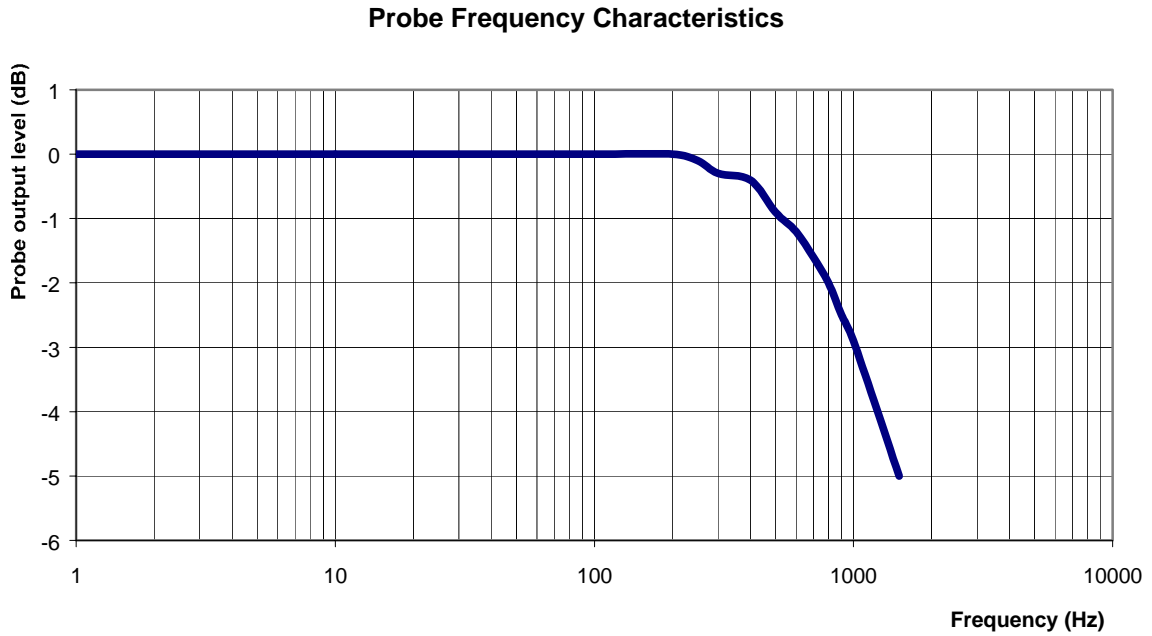

Video Bandwidth at 500 Hz 1 dB
Video Bandwidth at 1000 Hz 3 dB

Conversion Factor Uncertainty Assessment

Frequency: 2450MHz
Epsilon: 39.2 (+/-5%) **Sigma:** 1.80 S/m (+/-5%)

ConvF

Channel X: 3.67 7%(K=2)

Channel Y: 3.67 7%(K=2)

Channel Z: 3.67 7%(K=2)

To minimize the uncertainty calculation all tissue sensitivity values were calculated using a load impedance of 5 MΩ.

Boundary Effect:

For a distance of 2.4mm the evaluated uncertainty (increase in the probe sensitivity) is less than 2%.

Test Equipment

The test equipment used during Probe Calibration, manufacturer, model number and, current calibration status are listed and located on the main APREL server R:\NCL\Calibration Equipment\Instrument List May 2008.

NCL CALIBRATION LABORATORIES

Calibration File No.: CP-880

Client: QUIETEK

CERTIFICATE OF CALIBRATION

It is certified that the equipment identified below has been calibrated in the **NCL CALIBRATION LABORATORIES** by qualified personnel following recognized procedures and using transfer standards traceable to NRC/NIST.

Equipment: Miniature Isotropic RF Probe 2450 MHz

Manufacturer: APREL Laboratories

Model No.: ALS-E-020

Serial No.: 265

BODY Calibration

Calibration Procedure: SSI/DRB-TP-D01-032-E020-V2

Project No: QTKB-ALS-E20-CAL-5335

Calibrated: 9th May 2008
Released on: 9th May 2008

This Calibration Certificate is Incomplete Unless Accompanied with the Calibration Results Summary

Released By: _____

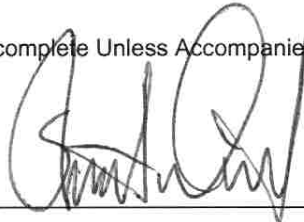

NCL CALIBRATION LABORATORIES

51 SPECTRUM WAY
NEPEAN, ONTARIO
CANADA K2R 1E6

Division of APREL Lab.
TEL: (613) 820-4988
FAX: (613) 820-4161

Introduction

This Calibration Report reproduces the results of the calibration performed in line with the SSI/DRB-TP-D01-032-E020-V2 E-Field Probe Calibration Procedure. The results contained within this report are for APREL E-Field Probe E-020 265.

References

SSI/DRB-TP-D01-032-E020-V2 E-Field Probe Calibration Procedure
IEEE 1528 "Recommended Practice for Determining the Peak Spatial-Average Specific Absorption Rate (SAR) in the Human Head Due to Wireless Communications Devices: Experimental Techniques"
SSI-TP-011 Tissue Calibration Procedure
IEC 62209 "Human exposure to radio frequency fields from hand-held and Head-mounted wireless communication devices – Human models, instrumentation, and procedures –Part 1 & 2: Procedure to determine the Specific Absorption Rate (SAR) for hand-held devices used in close proximity of the ear (frequency range of 300 MHz to 3 GHz)"
IEEE 1309 Draft Standard for Calibration of Electromagnetic Field Sensors and Probes, Excluding Antennas, from 9kHz to 40GHz

Conditions

Probe 265 is a re-calibration.

Ambient Temperature of the Laboratory: 22 °C +/- 0.5°C

Temperature of the Tissue: 21 °C +/- 0.5°C

We the undersigned attest that to the best of our knowledge the calibration of this probe has been accurately conducted and that all information contained within this report has been reviewed for accuracy.

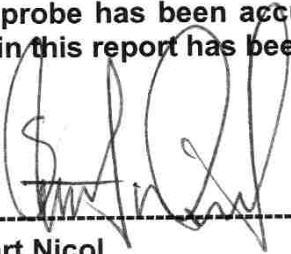

Stuart Nicol

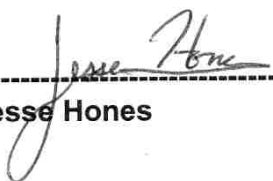

Jesse Hones

Calibration Results Summary

Probe Type:	E-Field Probe E-020
Serial Number:	265
Frequency:	2450 MHz
Sensor Offset:	1.56 mm
Sensor Length:	2.5 mm
Tip Enclosure:	Ertalyte*
Tip Diameter:	<5 mm
Tip Length:	60 mm
Total Length:	290 mm

*Resistive to recommended tissue recipes per IEEE-1528

Sensitivity in Air

Channel X:	1.2 $\mu\text{V}/(\text{V}/\text{m})^2$
Channel Y:	1.2 $\mu\text{V}/(\text{V}/\text{m})^2$
Channel Z:	1.2 $\mu\text{V}/(\text{V}/\text{m})^2$
Diode Compression Point:	95 mV

Sensitivity in Body Tissue

Frequency: 2450 MHz

Epsilon: 52.7 (+/-5%) **Sigma:** 1.95 S/m (+/-5%)

ConvF

Channel X: 3.55

Channel Y: 3.55

Channel Z: 3.55

Tissue sensitivity values were calculated using the load impedance of the APREL Laboratories Daq-Paq.

Boundary Effect:

Uncertainty resulting from the boundary effect is less than 2% for the distance between the tip of the probe and the tissue boundary, when less than 2.44mm.

Spatial Resolution:

The measured probe tip diameter is 5 mm (+/- 0.01 mm) and therefore meets the requirements of SSI/DRB-TP-D01-032 for spatial resolution.

Receiving Pattern 2450 MHz (Air)

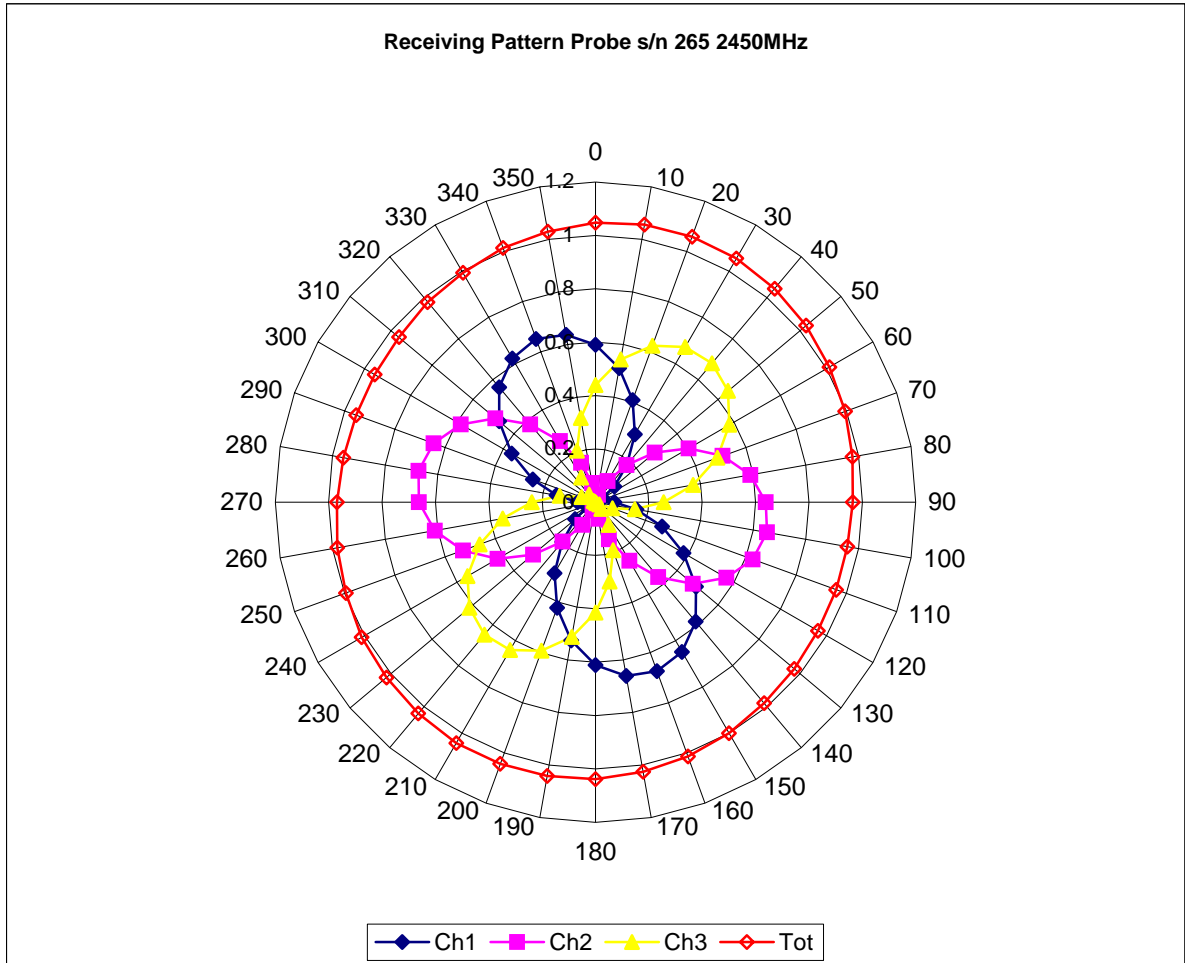

Isotropy Error 2450 MHz (Air)

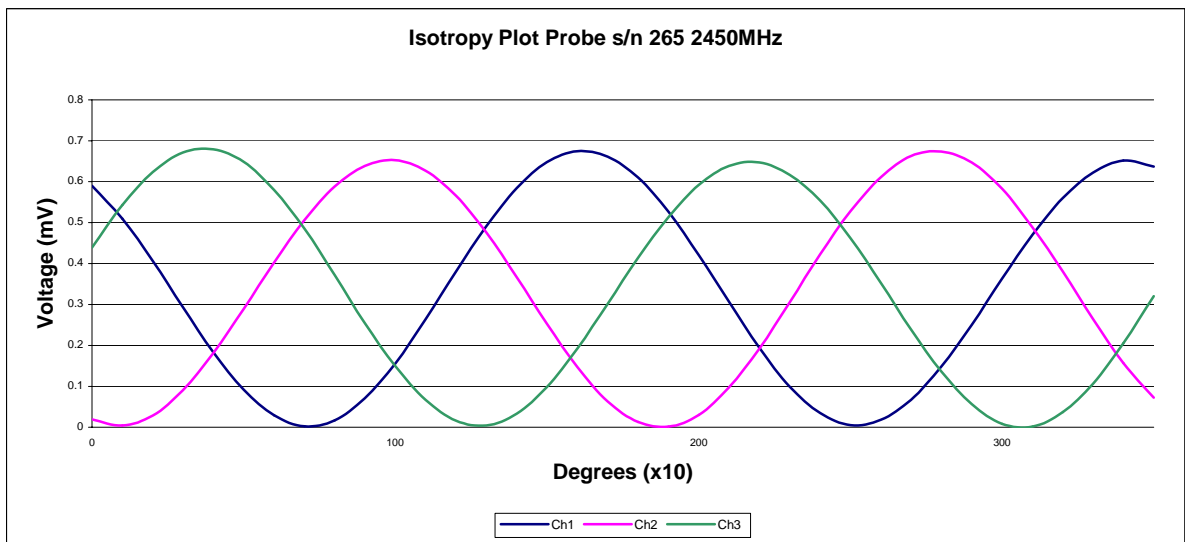
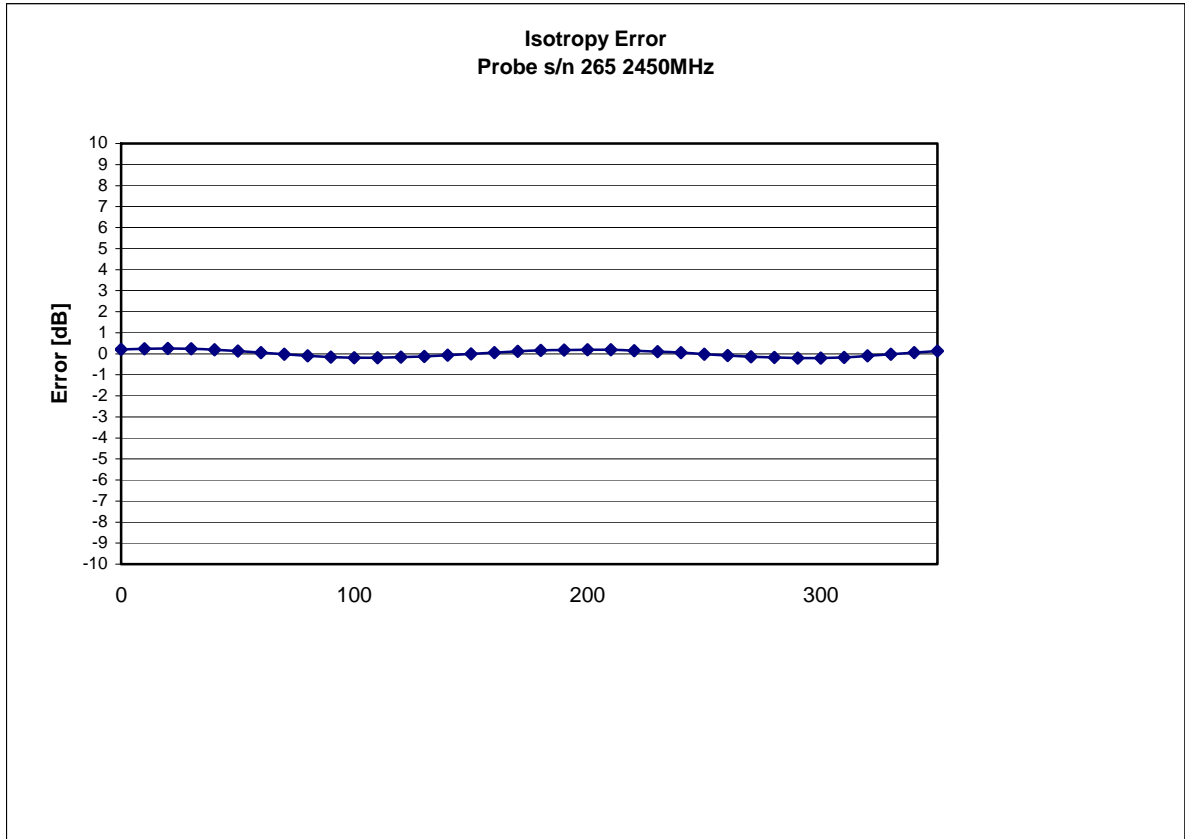

Isotropicity in Tissue:

0.10 dB

Dynamic Range

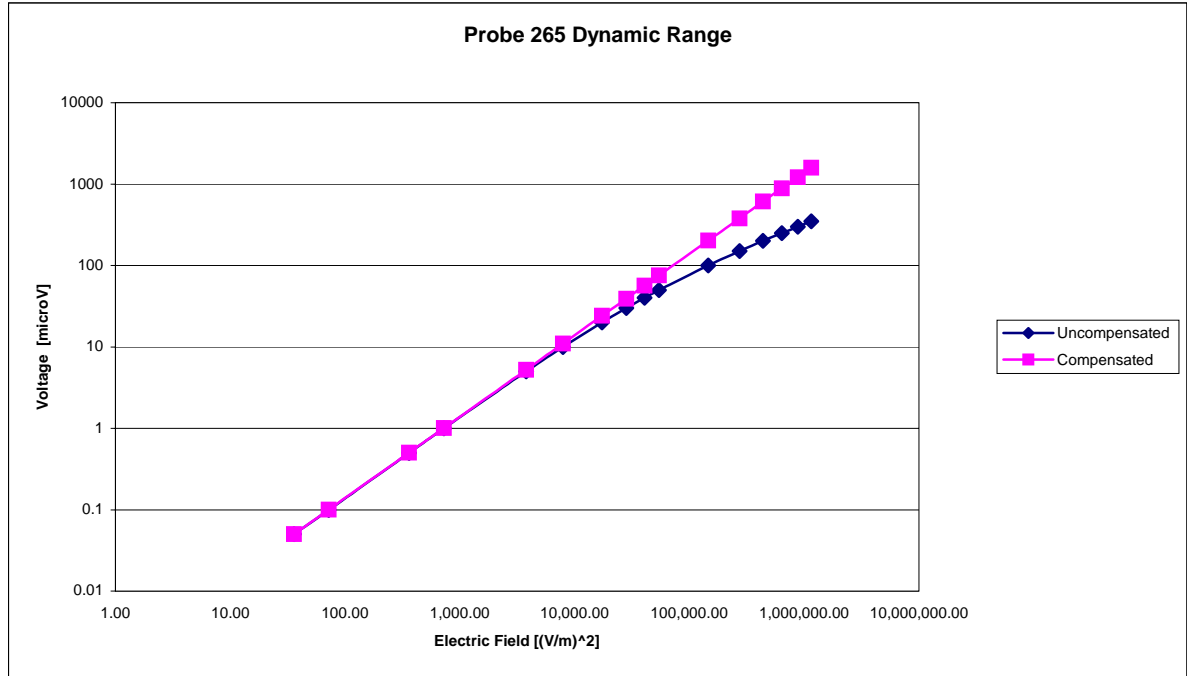

Video Bandwidth

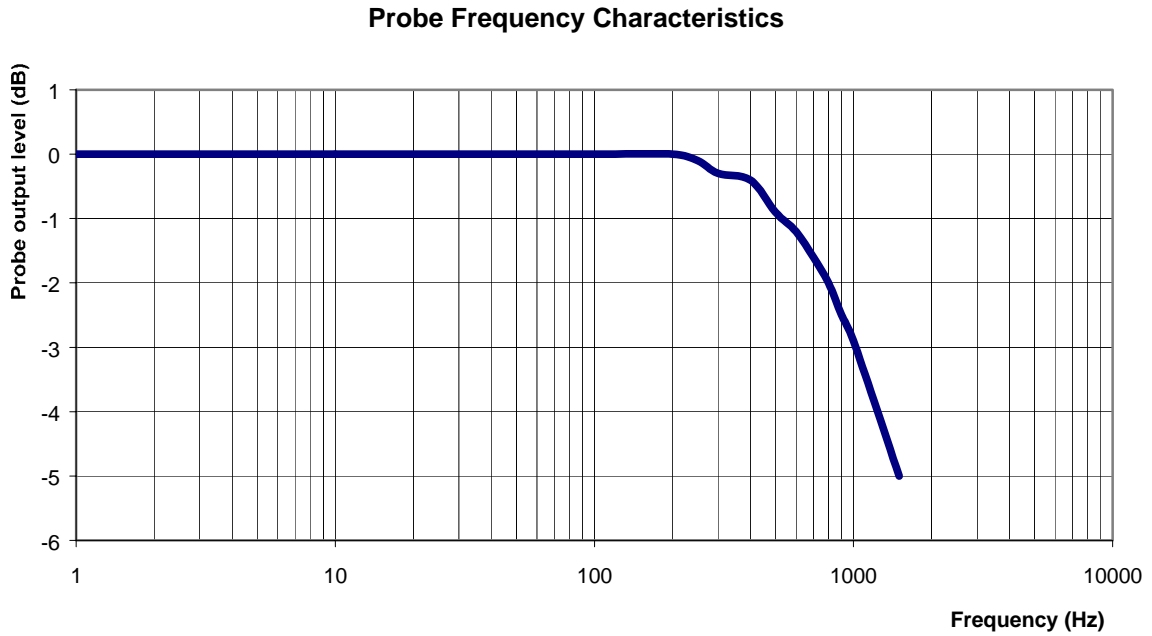

Video Bandwidth at 500 Hz 1 dB
Video Bandwidth at 1000 Hz 3 dB

Conversion Factor Uncertainty Assessment

Frequency: 2450MHz
Epsilon: 52.7 (+/-5%) **Sigma:** 1.95 S/m (+/-5%)

ConvF

Channel X: 3.55 7%(K=2)

Channel Y: 3.55 7%(K=2)

Channel Z: 3.55 7%(K=2)

To minimize the uncertainty calculation all tissue sensitivity values were calculated using a load impedance of 5 MΩ.

Boundary Effect:

For a distance of 2.4mm the evaluated uncertainty (increase in the probe sensitivity) is less than 2%.

Test Equipment

The test equipment used during Probe Calibration, manufacturer, model number and, current calibration status are listed and located on the main APREL server R:\NCL\Calibration Equipment\Instrument List May 2008.



Appendix D. Probe Calibration Data

Miniature Isotropic RF Probe

M/N: ALS-E-020

S/N: 265

5200 MHz Head Calibration

5200 MHz Body Calibration

NCL CALIBRATION LABORATORIES

Calibration File No.: CP-883

Client: QUIETEK

CERTIFICATE OF CALIBRATION

It is certified that the equipment identified below has been calibrated in the **NCL CALIBRATION LABORATORIES** by qualified personnel following recognized procedures and using transfer standards traceable to NRC/NIST.

Equipment: Miniature Isotropic RF Probe 5200 MHz

Manufacturer: APREL Laboratories

Model No.: ALS-E-020

Serial No.: 265

HEAD Calibration

Calibration Procedure: SSI/DRB-TP-D01-032-E020-V2

Project No: QTKB-ALS-E20-CAL-5335

Calibrated: 9th May 2008
Released on: 9th May 2008

This Calibration Certificate is Incomplete Unless Accompanied with the Calibration Results Summary

Released By: _____

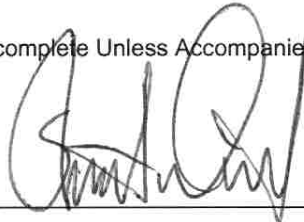

NCL CALIBRATION LABORATORIES

51 SPECTRUM WAY
NEPEAN, ONTARIO
CANADA K2R 1E6

Division of APREL Lab.
TEL: (613) 820-4988
FAX: (613) 820-4161

Introduction

This Calibration Report reproduces the results of the calibration performed in line with the SSI/DRB-TP-D01-032-E020-V2 E-Field Probe Calibration Procedure. The results contained within this report are for APREL E-Field Probe E-020 265.

References

SSI/DRB-TP-D01-032-E020-V2 E-Field Probe Calibration Procedure

IEEE 1528 "Recommended Practice for Determining the Peak Spatial-Average Specific Absorption Rate (SAR) in the Human Head Due to Wireless Communications Devices: Experimental Techniques"

SSI-TP-011 Tissue Calibration Procedure

IEC 62209 "Human exposure to radio frequency fields from hand-held and Head-mounted wireless communication devices – Human models, instrumentation, and procedures –Part 1 & 2: Procedure to determine the Specific Absorption Rate (SAR) for hand-held devices used in close proximity of the ear (frequency range of 300 MHz to 3 GHz)"

IEEE 1309 Draft Standard for Calibration of Electromagnetic Field Sensors and Probes, Excluding Antennas, from 9kHz to 40GHz

Conditions

Probe 265 is a re-calibration.

Ambient Temperature of the Laboratory: 22 °C +/- 0.5°C

Temperature of the Tissue: 21 °C +/- 0.5°C

We the undersigned attest that to the best of our knowledge the calibration of this probe has been accurately conducted and that all information contained within this report has been reviewed for accuracy.

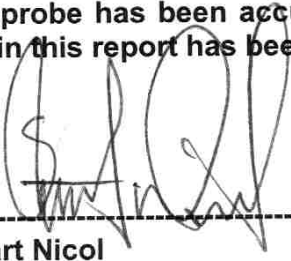

Stuart Nicol

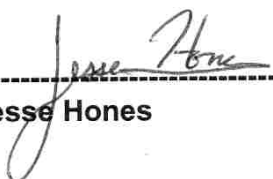

Jesse Hones

Calibration Results Summary

Probe Type:	E-Field Probe E-020
Serial Number:	265
Frequency:	5200 MHz
Sensor Offset:	1.56 mm
Sensor Length:	2.5 mm
Tip Enclosure:	Ertalyte*
Tip Diameter:	<5 mm
Tip Length:	60 mm
Total Length:	290 mm

*Resistive to recommended tissue recipes per IEEE-1528

Sensitivity in Air

Channel X:	1.2 $\mu\text{V}/(\text{V}/\text{m})^2$
Channel Y:	1.2 $\mu\text{V}/(\text{V}/\text{m})^2$
Channel Z:	1.2 $\mu\text{V}/(\text{V}/\text{m})^2$
Diode Compression Point:	95 mV

Sensitivity in Head Tissue

Frequency: 5200 MHz

Epsilon: 35.9 (+/-10%) **Sigma:** 4.7 S/m (+/-5%)

ConvF

Channel X: 3.5

Channel Y: 3.5

Channel Z: 3.5

Tissue sensitivity values were calculated using the load impedance of the APREL Laboratories Daq-Paq.

Boundary Effect:

Uncertainty resulting from the boundary effect is less than 2% for the distance between the tip of the probe and the tissue boundary, when less than 2.44mm.

Spatial Resolution:

The measured probe tip diameter is 5 mm (+/- 0.01 mm) and therefore meets the requirements of SSI/DRB-TP-D01-032 for spatial resolution.

Receiving Pattern 5200 MHz (Air)

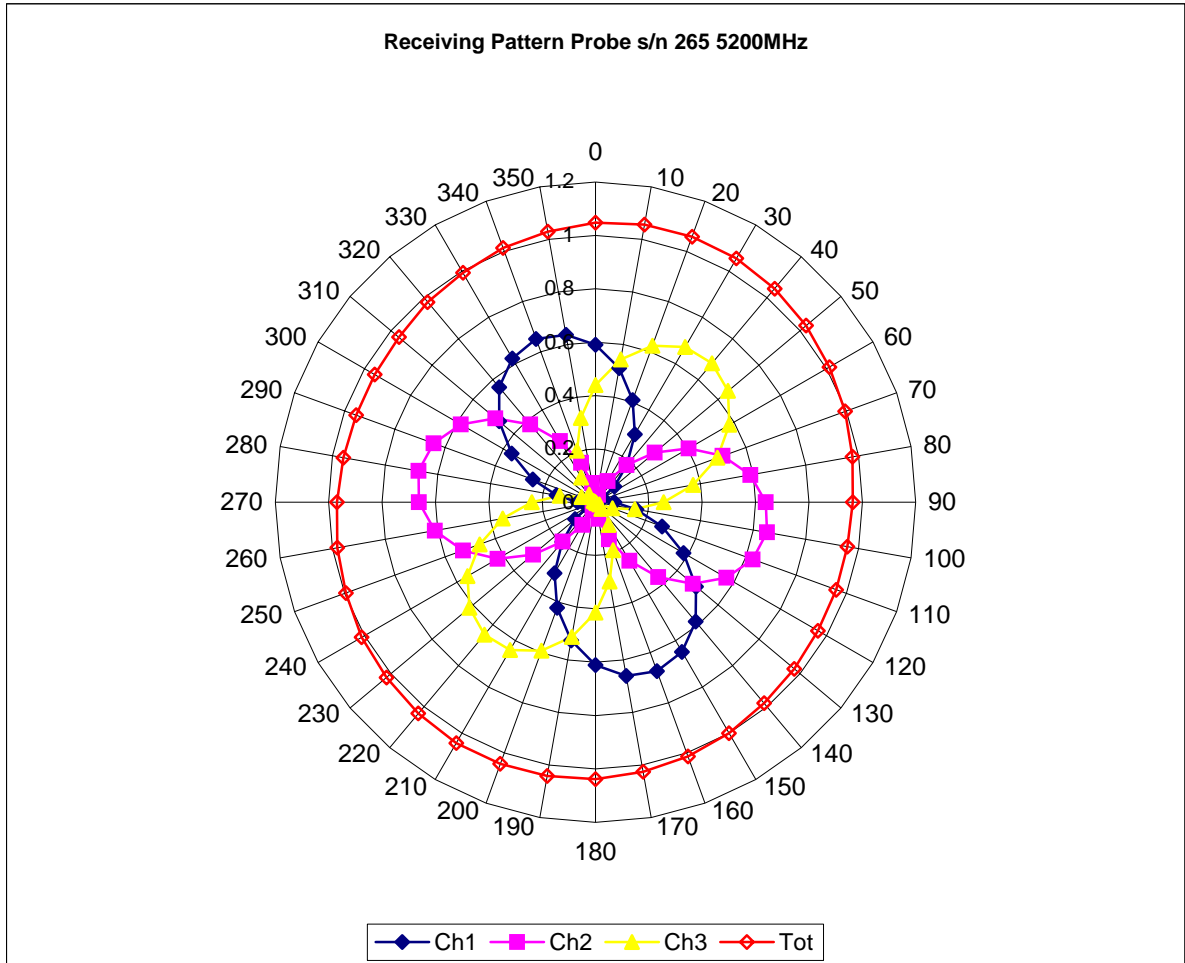

Isotropy Error 5200 MHz (Air)

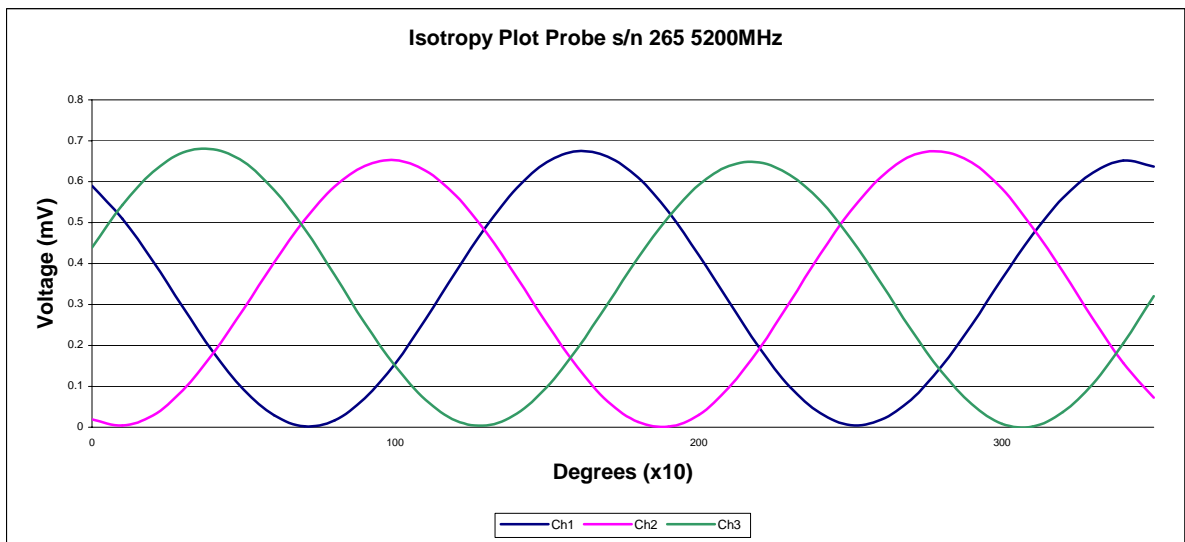
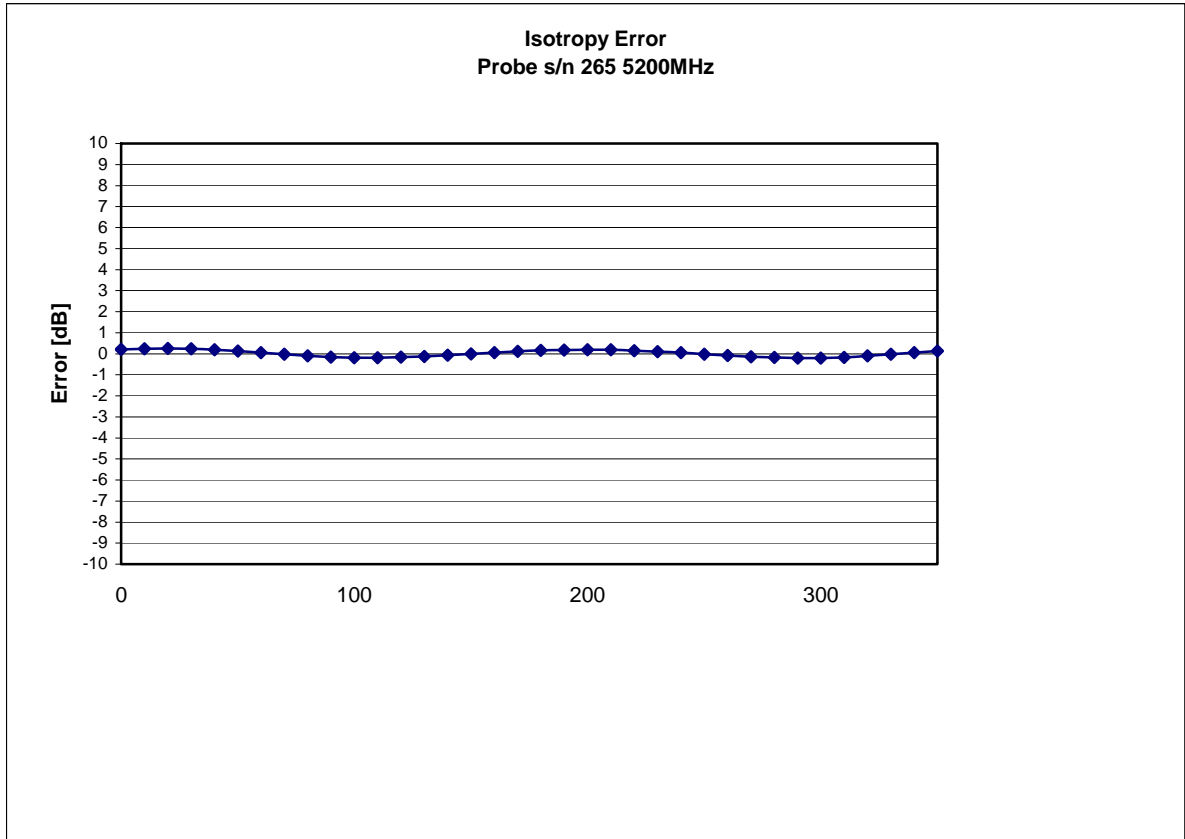

Isotropicity in Tissue:

0.10 dB

Video Bandwidth

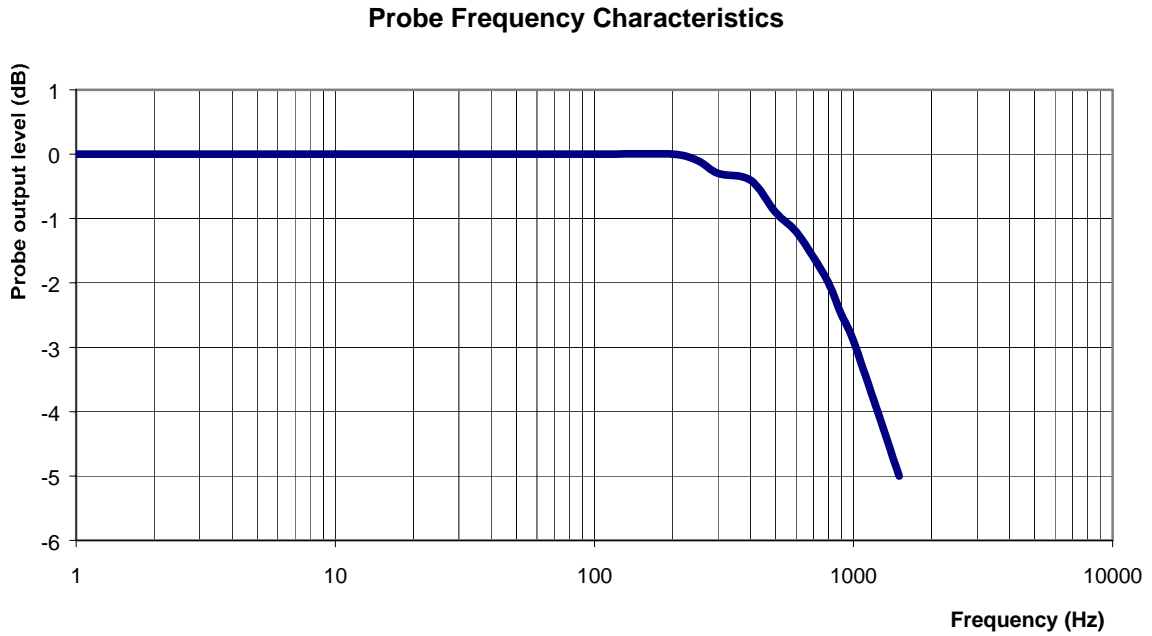

Video Bandwidth at 500 Hz 1 dB
Video Bandwidth at 1000 Hz 3 dB

Conversion Factor Uncertainty Assessment

Frequency: 5200MHz
Epsilon: 35.9 (+/-10%) **Sigma:** 4.7 S/m (+/-5%)

ConvF

Channel X: 3.5 7%(K=2)
Channel Y: 3.5 7%(K=2)
Channel Z: 3.5 7%(K=2)

To minimize the uncertainty calculation all tissue sensitivity values were calculated using a load impedance of 5 MΩ.

Boundary Effect:

For a distance of 2.4mm the evaluated uncertainty (increase in the probe sensitivity) is less than 2%.

Test Equipment

The test equipment used during Probe Calibration, manufacturer, model number and, current calibration status are listed and located on the main APREL server R:\NCL\Calibration Equipment\Instrument List May 2008.

NCL CALIBRATION LABORATORIES

Calibration File No.: CP-884

Client: QUIETEK

CERTIFICATE OF CALIBRATION

It is certified that the equipment identified below has been calibrated in the **NCL CALIBRATION LABORATORIES** by qualified personnel following recognized procedures and using transfer standards traceable to NRC/NIST.

Equipment: Miniature Isotropic RF Probe 5200 MHz

Manufacturer: APREL Laboratories

Model No.: ALS-E-020

Serial No.: 265

BODY Calibration

Calibration Procedure: SSI/DRB-TP-D01-032-E020-V2

Project No: QTKB-ALS-E20-CAL-5335

Calibrated: 9th May 2008
Released on: 9th May 2008

This Calibration Certificate is Incomplete Unless Accompanied with the Calibration Results Summary

Released By: _____

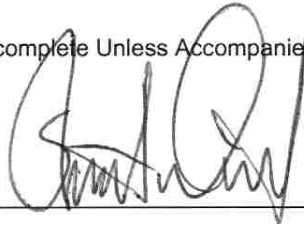

NCL CALIBRATION LABORATORIES

51 SPECTRUM WAY
NEPEAN, ONTARIO
CANADA K2R 1E6

Division of APREL Lab.
TEL: (613) 820-4988
FAX: (613) 820-4161

Introduction

This Calibration Report reproduces the results of the calibration performed in line with the SSI/DRB-TP-D01-032-E020-V2 E-Field Probe Calibration Procedure. The results contained within this report are for APREL E-Field Probe E-020 265.

References

SSI/DRB-TP-D01-032-E020-V2 E-Field Probe Calibration Procedure

IEEE 1528 "Recommended Practice for Determining the Peak Spatial-Average Specific Absorption Rate (SAR) in the Human Head Due to Wireless Communications Devices: Experimental Techniques"

SSI-TP-011 Tissue Calibration Procedure

IEC 62209 "Human exposure to radio frequency fields from hand-held and Head-mounted wireless communication devices – Human models, instrumentation, and procedures –Part 1 & 2: Procedure to determine the Specific Absorption Rate (SAR) for hand-held devices used in close proximity of the ear (frequency range of 300 MHz to 3 GHz)"

IEEE 1309 Draft Standard for Calibration of Electromagnetic Field Sensors and Probes, Excluding Antennas, from 9kHz to 40GHz

Conditions

Probe 265 is a re-calibration.

Ambient Temperature of the Laboratory: 22 °C +/- 0.5°C

Temperature of the Tissue: 21 °C +/- 0.5°C

We the undersigned attest that to the best of our knowledge the calibration of this probe has been accurately conducted and that all information contained within this report has been reviewed for accuracy.

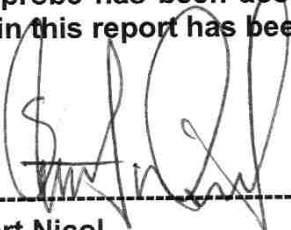

Stuart Nicol

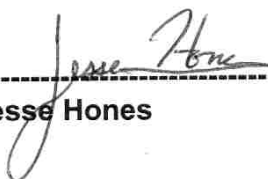

Jesse Hones

Calibration Results Summary

Probe Type:	E-Field Probe E-020
Serial Number:	265
Frequency:	5200 MHz
Sensor Offset:	1.56 mm
Sensor Length:	2.5 mm
Tip Enclosure:	Ertalyte*
Tip Diameter:	<5 mm
Tip Length:	60 mm
Total Length:	290 mm

*Resistive to recommended tissue recipes per IEEE-1528

Sensitivity in Air

Channel X:	1.2 $\mu\text{V}/(\text{V}/\text{m})^2$
Channel Y:	1.2 $\mu\text{V}/(\text{V}/\text{m})^2$
Channel Z:	1.2 $\mu\text{V}/(\text{V}/\text{m})^2$
Diode Compression Point:	95 mV

Sensitivity in Body Tissue

Frequency:

5200 MHz

Epsilon: 48.9 (+/-10%)

Sigma: 5.35 S/m (+/-5%)

ConvF

Channel X: 4.3

Channel Y: 4.3

Channel Z: 4.3

Tissue sensitivity values were calculated using the load impedance of the APREL Laboratories Daq-Paq.

Boundary Effect:

Uncertainty resulting from the boundary effect is less than 2% for the distance between the tip of the probe and the tissue boundary, when less than 2.44mm.

Spatial Resolution:

The measured probe tip diameter is 5 mm (+/- 0.01 mm) and therefore meets the requirements of SSI/DRB-TP-D01-032 for spatial resolution.

Receiving Pattern 5200 MHz (Air)

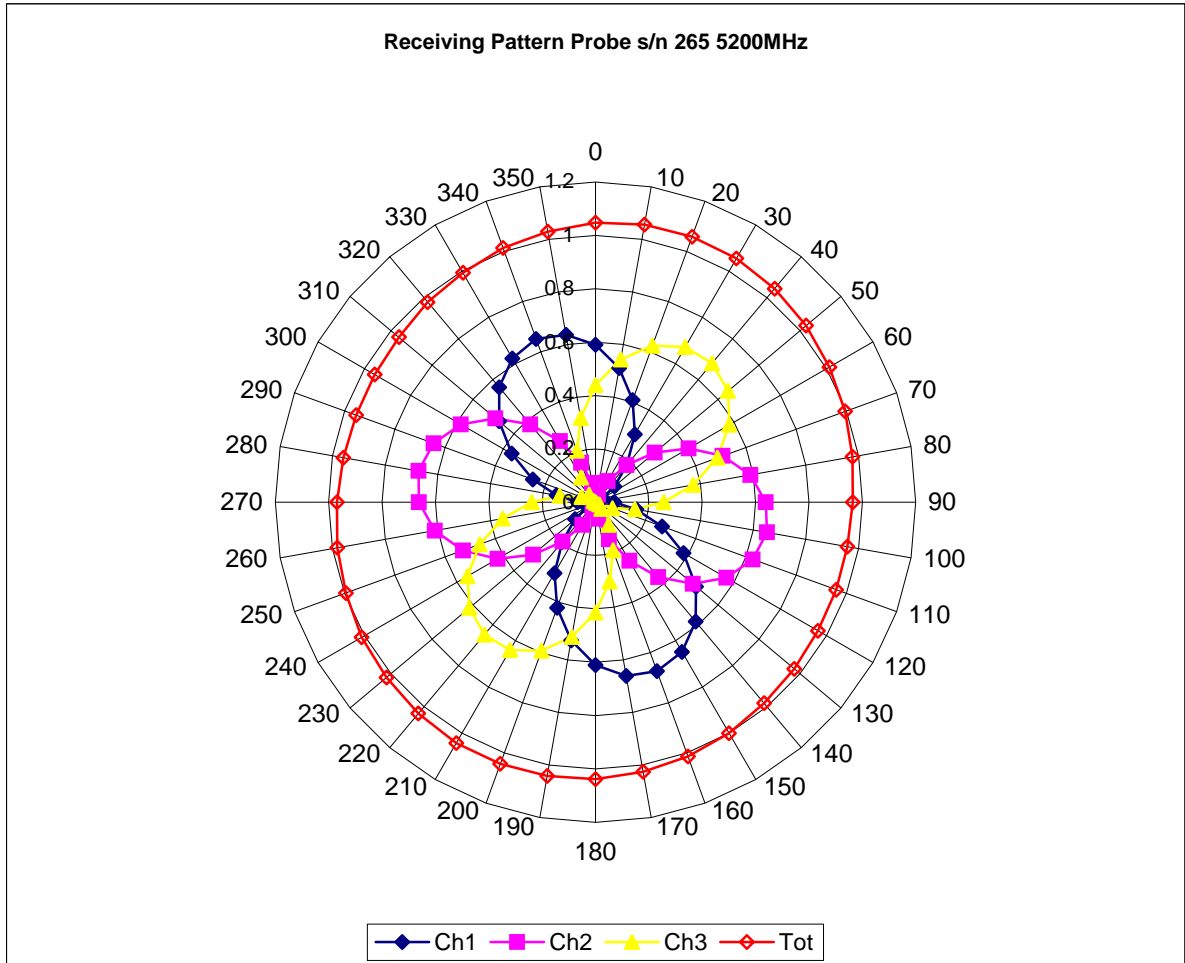

Isotropy Error 5200 MHz (Air)

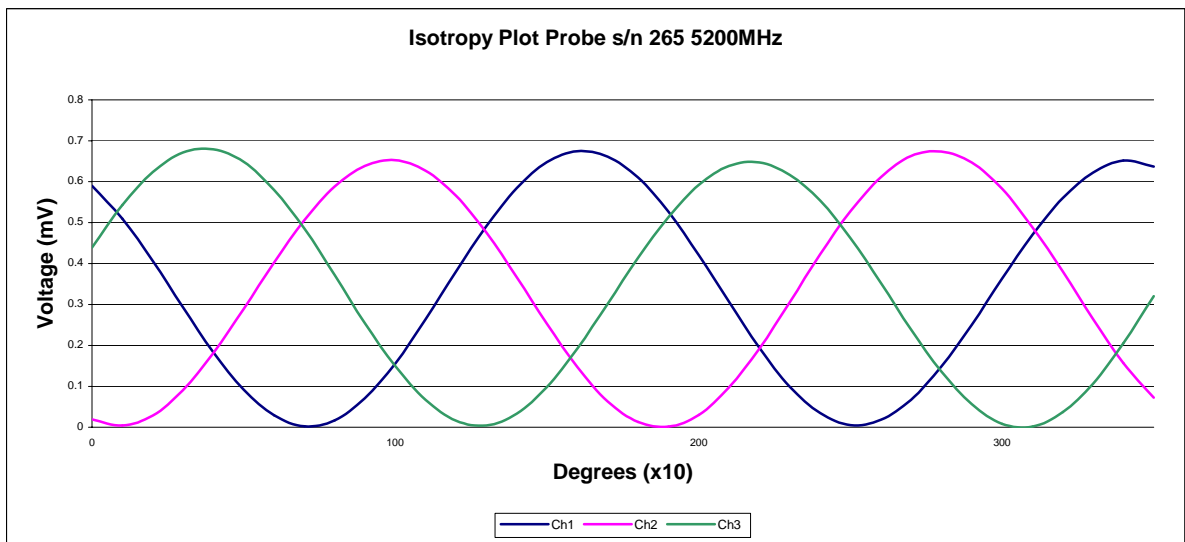
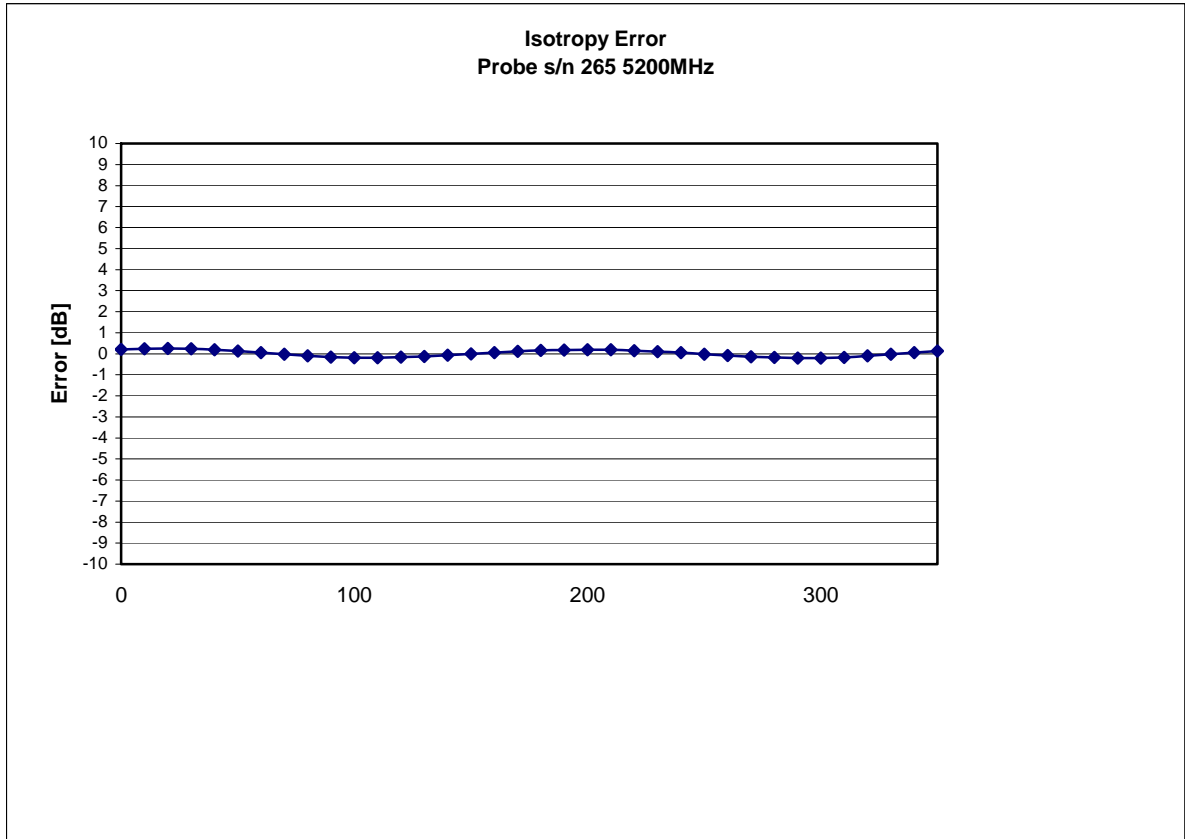

Isotropicity in Tissue:

0.10 dB

Dynamic Range

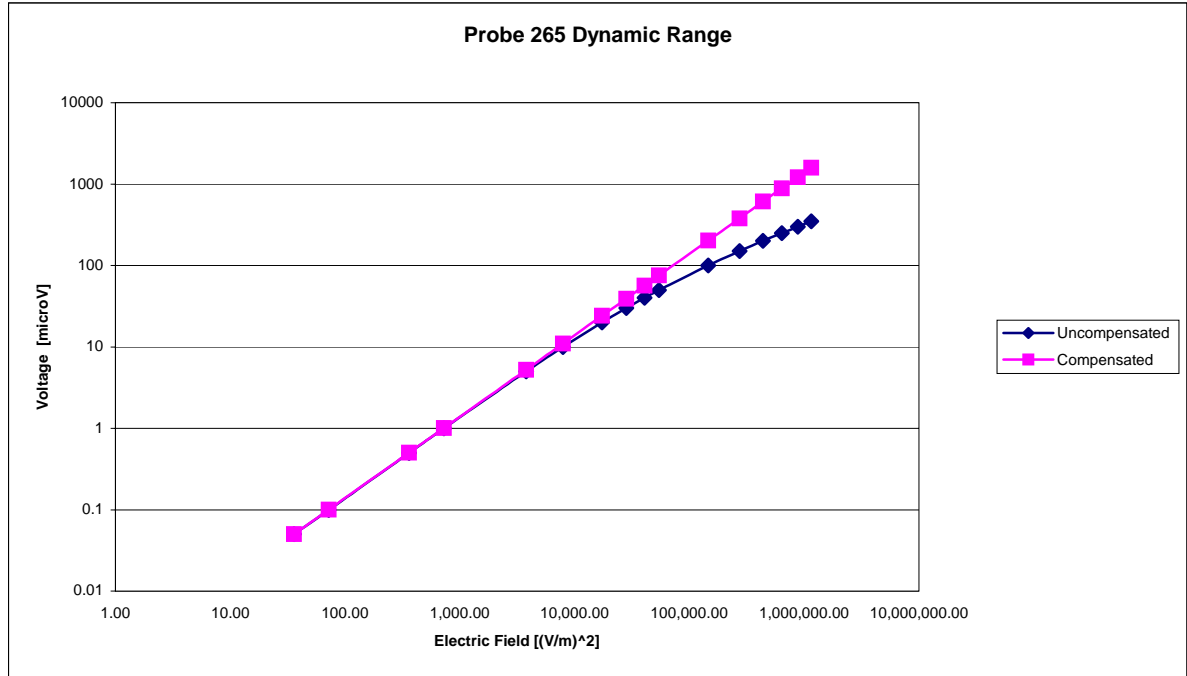

Video Bandwidth

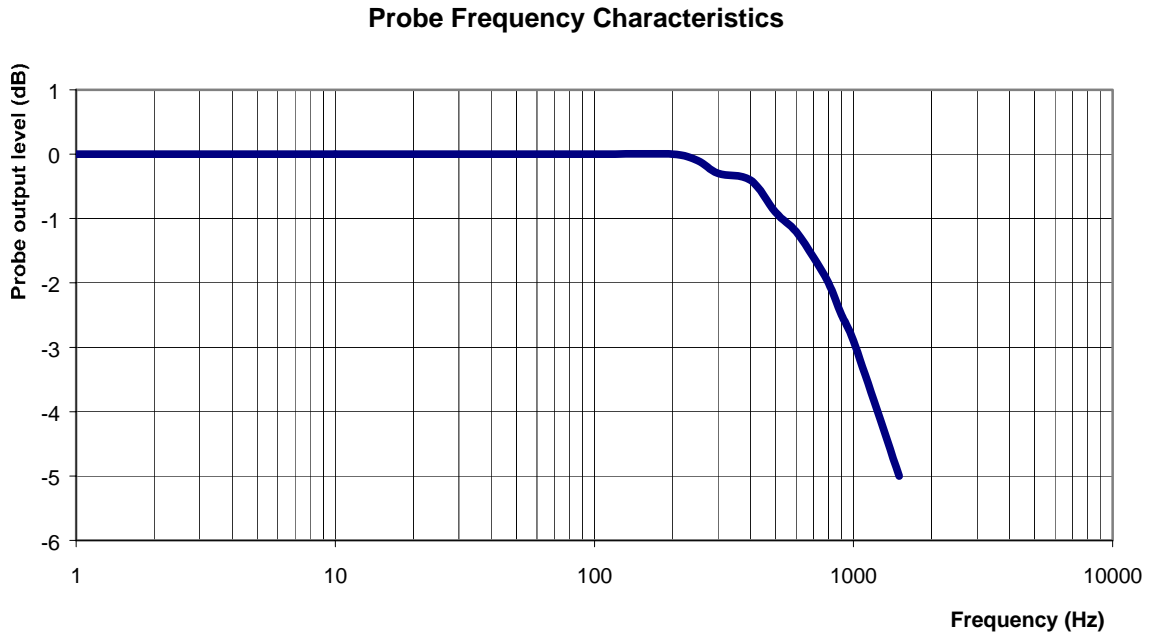

Video Bandwidth at 500 Hz 1 dB
Video Bandwidth at 1000 Hz 3 dB

Conversion Factor Uncertainty Assessment

Frequency: 5200MHz
Epsilon: 48.9 (+/-10%) **Sigma:** 5.35 S/m (+/-5%)

ConvF

Channel X: 4.3 7%(K=2)

Channel Y: 4.3 7%(K=2)

Channel Z: 4.3 7%(K=2)

To minimize the uncertainty calculation all tissue sensitivity values were calculated using a load impedance of 5 M Ω .

Boundary Effect:

For a distance of 2.4mm the evaluated uncertainty (increase in the probe sensitivity) is less than 2%.

Test Equipment

The test equipment used during Probe Calibration, manufacturer, model number and, current calibration status are listed and located on the main APREL server R:\NCL\Calibration Equipment\Instrument List May 2008.



Appendix D. Probe Calibration Data

Miniature Isotropic RF Probe

M/N: ALS-E-020

S/N: 265

5800 MHz Head Calibration

5800 MHz Body Calibration

NCL CALIBRATION LABORATORIES

Calibration File No.: CP-885

Client: QUIETEK

CERTIFICATE OF CALIBRATION

It is certified that the equipment identified below has been calibrated in the **NCL CALIBRATION LABORATORIES** by qualified personnel following recognized procedures and using transfer standards traceable to NRC/NIST.

Equipment: Miniature Isotropic RF Probe 5800 MHz

Manufacturer: APREL Laboratories

Model No.: ALS-E-020

Serial No.: 265

HEAD Calibration

Calibration Procedure: SSI/DRB-TP-D01-032-E020-V2

Project No: QTKB-ALS-E20-CAL-5335

Calibrated: 9th May 2008
Released on: 9th May 2008

This Calibration Certificate is Incomplete Unless Accompanied with the Calibration Results Summary

Released By: _____

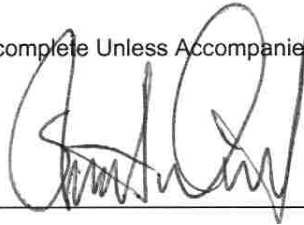

NCL CALIBRATION LABORATORIES

51 SPECTRUM WAY
NEPEAN, ONTARIO
CANADA K2R 1E6

Division of APREL Lab.
TEL: (613) 820-4988
FAX: (613) 820-4161

Introduction

This Calibration Report reproduces the results of the calibration performed in line with the SSI/DRB-TP-D01-032-E020-V2 E-Field Probe Calibration Procedure. The results contained within this report are for APREL E-Field Probe E-020 265.

References

SSI/DRB-TP-D01-032-E020-V2 E-Field Probe Calibration Procedure
IEEE 1528 "Recommended Practice for Determining the Peak Spatial-Average Specific Absorption Rate (SAR) in the Human Head Due to Wireless Communications Devices: Experimental Techniques"
SSI-TP-011 Tissue Calibration Procedure
IEC 62209 "Human exposure to radio frequency fields from hand-held and Head-mounted wireless communication devices – Human models, instrumentation, and procedures –Part 1 & 2: Procedure to determine the Specific Absorption Rate (SAR) for hand-held devices used in close proximity of the ear (frequency range of 300 MHz to 3 GHz)"
IEEE 1309 Draft Standard for Calibration of Electromagnetic Field Sensors and Probes, Excluding Antennas, from 9kHz to 40GHz

Conditions

Probe 265 is a re-calibration.

Ambient Temperature of the Laboratory: 22 °C +/- 0.5°C

Temperature of the Tissue: 21 °C +/- 0.5°C

We the undersigned attest that to the best of our knowledge the calibration of this probe has been accurately conducted and that all information contained within this report has been reviewed for accuracy.

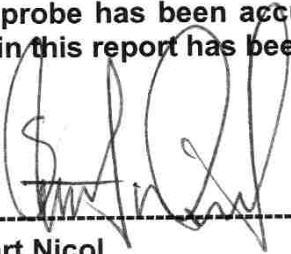

Stuart Nicol

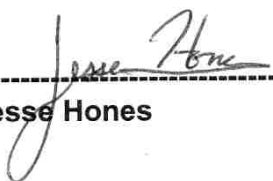

Jesse Hones

Calibration Results Summary

Probe Type:	E-Field Probe E-020
Serial Number:	265
Frequency:	5800 MHz
Sensor Offset:	1.56 mm
Sensor Length:	2.5 mm
Tip Enclosure:	Ertalyte*
Tip Diameter:	<5 mm
Tip Length:	60 mm
Total Length:	290 mm

*Resistive to recommended tissue recipes per IEEE-1528

Sensitivity in Air

Channel X:	1.2 $\mu\text{V}/(\text{V}/\text{m})^2$
Channel Y:	1.2 $\mu\text{V}/(\text{V}/\text{m})^2$
Channel Z:	1.2 $\mu\text{V}/(\text{V}/\text{m})^2$
Diode Compression Point:	95 mV

Sensitivity in Head Tissue

Frequency: 5800 MHz

Epsilon: 35.3 (+/-10%) **Sigma:** 5.27 S/m (+/-5%)

ConvF

Channel X: 3.4

Channel Y: 3.4

Channel Z: 3.4

Tissue sensitivity values were calculated using the load impedance of the APREL Laboratories Daq-Paq.

Boundary Effect:

Uncertainty resulting from the boundary effect is less than 2% for the distance between the tip of the probe and the tissue boundary, when less than 2.44mm.

Spatial Resolution:

The measured probe tip diameter is 5 mm (+/- 0.01 mm) and therefore meets the requirements of SSI/DRB-TP-D01-032 for spatial resolution.

Receiving Pattern 5800 MHz (Air)

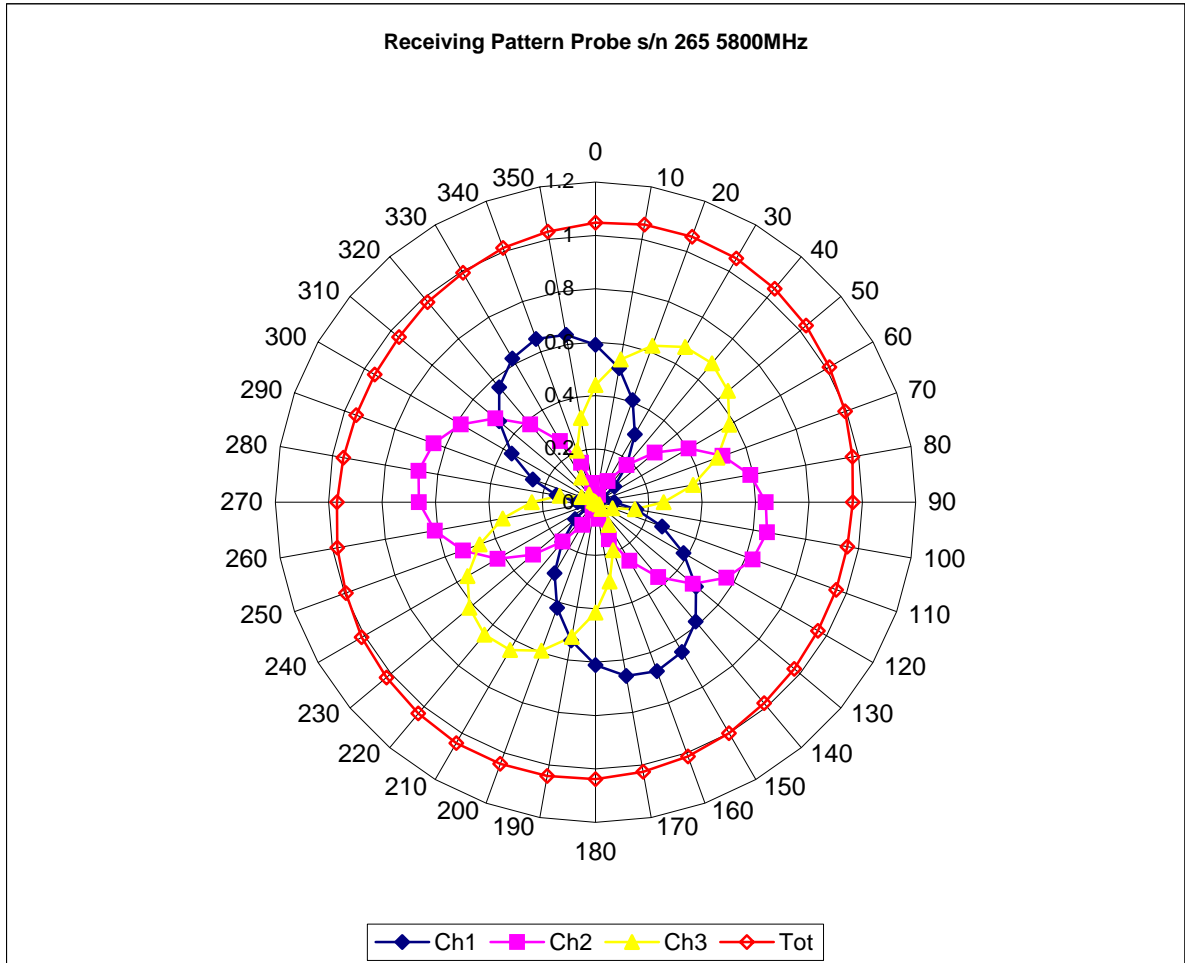

Isotropy Error 5800 MHz (Air)

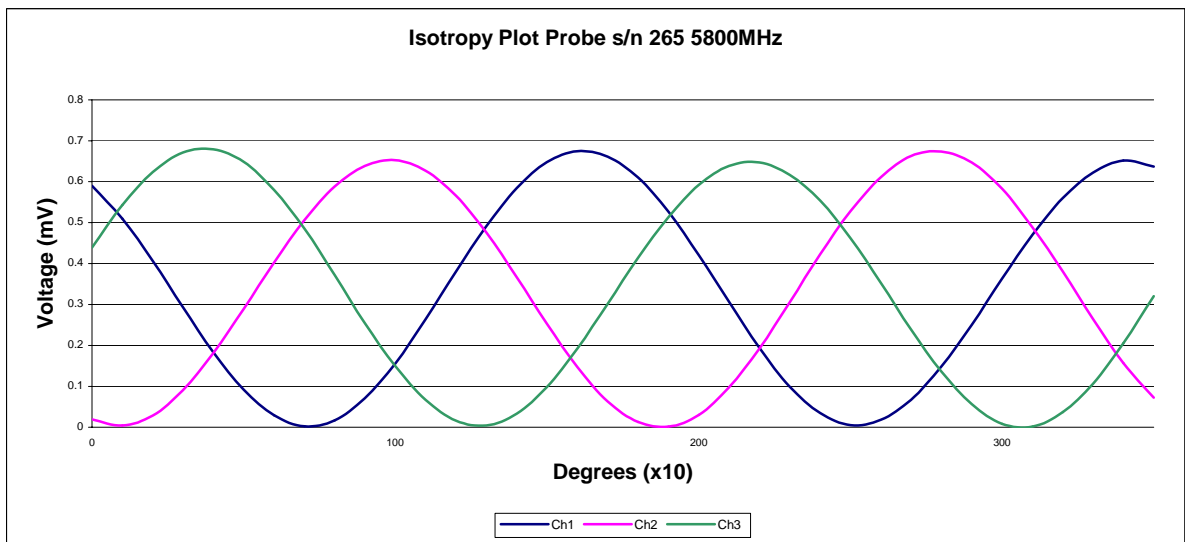
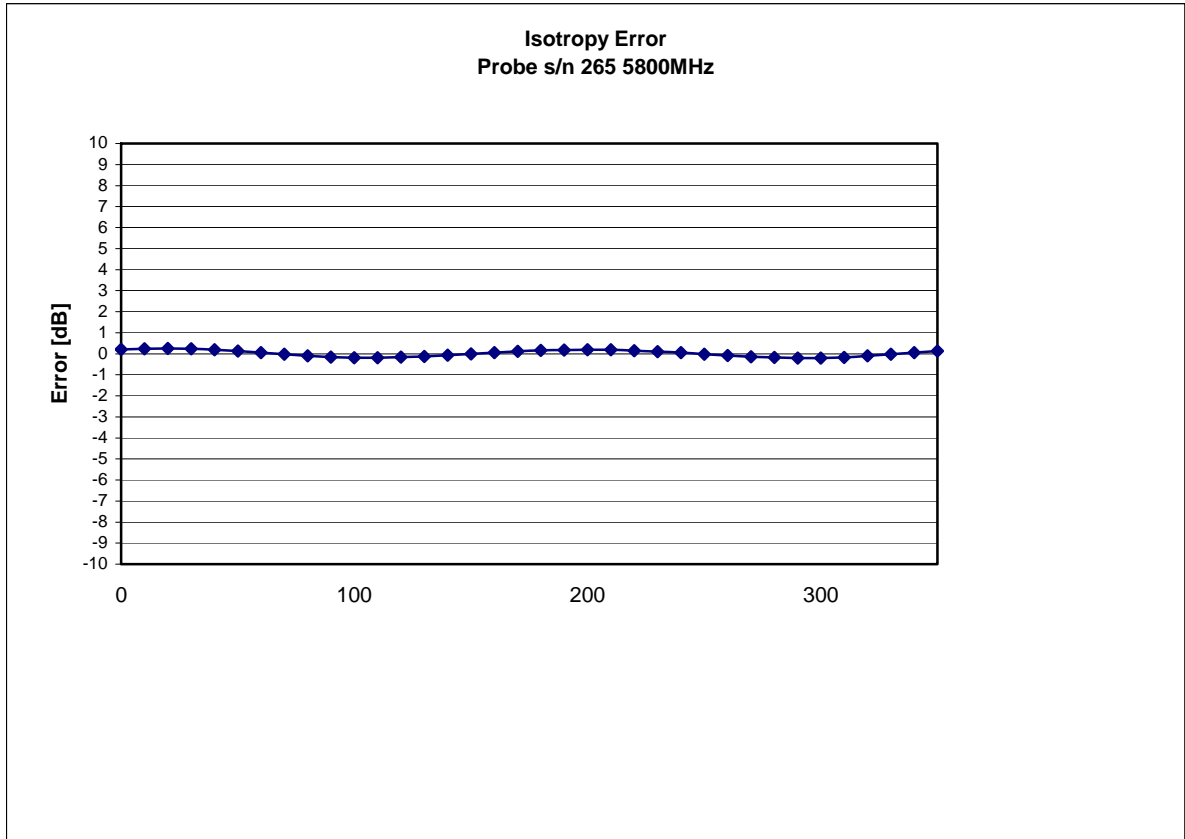

Isotropicity in Tissue:

0.10 dB

Dynamic Range

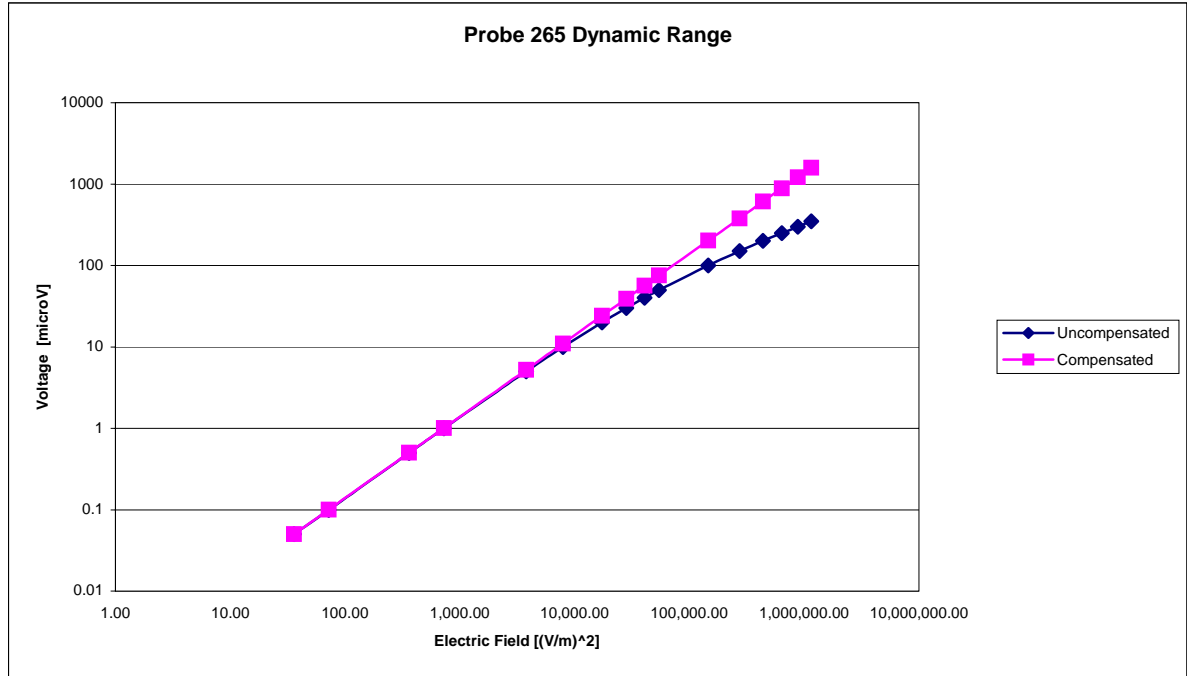

Video Bandwidth

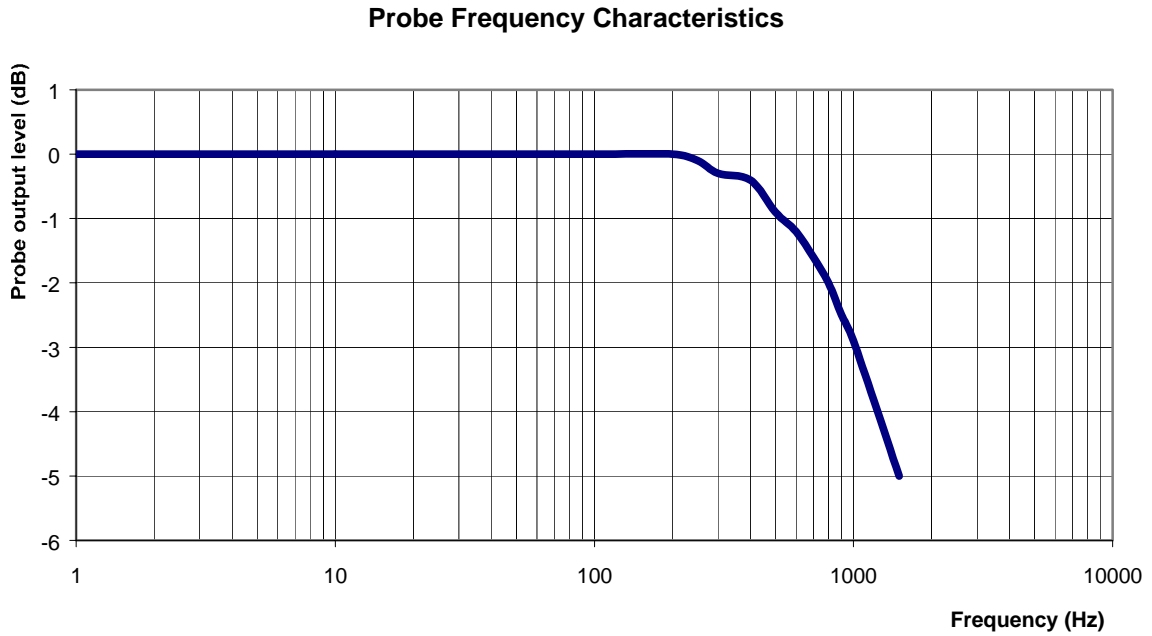

Video Bandwidth at 500 Hz 1 dB
Video Bandwidth at 1000 Hz 3 dB

Conversion Factor Uncertainty Assessment

Frequency: 5800MHz
Epsilon: 35.3 (+/-10%) **Sigma:** 5.27 S/m (+/-5%)

ConvF

Channel X: 3.4 7%(K=2)

Channel Y: 3.4 7%(K=2)

Channel Z: 3.4 7%(K=2)

To minimize the uncertainty calculation all tissue sensitivity values were calculated using a load impedance of 5 MΩ.

Boundary Effect:

For a distance of 2.4mm the evaluated uncertainty (increase in the probe sensitivity) is less than 2%.

Test Equipment

The test equipment used during Probe Calibration, manufacturer, model number and, current calibration status are listed and located on the main APREL server R:\NCL\Calibration Equipment\Instrument List May 2008.

NCL CALIBRATION LABORATORIES

Calibration File No.: CP-886

Client: QUIETEK

CERTIFICATE OF CALIBRATION

It is certified that the equipment identified below has been calibrated in the **NCL CALIBRATION LABORATORIES** by qualified personnel following recognized procedures and using transfer standards traceable to NRC/NIST.

Equipment: Miniature Isotropic RF Probe 5800 MHz

Manufacturer: APREL Laboratories

Model No.: ALS-E-020

Serial No.: 265

BODY Calibration

Calibration Procedure: SSI/DRB-TP-D01-032-E020-V2

Project No: QTKB-ALS-E20-CAL-5335

Calibrated: 9th May 2008
Released on: 9th May 2008

This Calibration Certificate is Incomplete Unless Accompanied with the Calibration Results Summary

Released By: _____

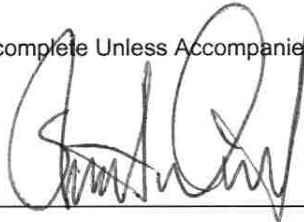

NCL CALIBRATION LABORATORIES

51 SPECTRUM WAY
NEPEAN, ONTARIO
CANADA K2R 1E6

Division of APREL Lab.
TEL: (613) 820-4988
FAX: (613) 820-4161

Introduction

This Calibration Report reproduces the results of the calibration performed in line with the SSI/DRB-TP-D01-032-E020-V2 E-Field Probe Calibration Procedure. The results contained within this report are for APREL E-Field Probe E-020 265.

References

SSI/DRB-TP-D01-032-E020-V2 E-Field Probe Calibration Procedure

IEEE 1528 "Recommended Practice for Determining the Peak Spatial-Average Specific Absorption Rate (SAR) in the Human Head Due to Wireless Communications Devices: Experimental Techniques"

SSI-TP-011 Tissue Calibration Procedure

IEC 62209 "Human exposure to radio frequency fields from hand-held and Head-mounted wireless communication devices – Human models, instrumentation, and procedures –Part 1 & 2: Procedure to determine the Specific Absorption Rate (SAR) for hand-held devices used in close proximity of the ear (frequency range of 300 MHz to 3 GHz)"

IEEE 1309 Draft Standard for Calibration of Electromagnetic Field Sensors and Probes, Excluding Antennas, from 9kHz to 40GHz

Conditions

Probe 265 is a re-calibration.

Ambient Temperature of the Laboratory: 22 °C +/- 0.5°C

Temperature of the Tissue: 21 °C +/- 0.5°C

We the undersigned attest that to the best of our knowledge the calibration of this probe has been accurately conducted and that all information contained within this report has been reviewed for accuracy.

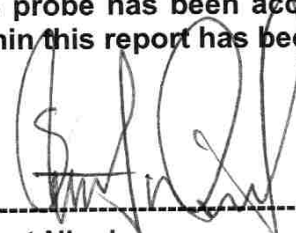

Stuart Nicol



Jesse Hones

Calibration Results Summary

Probe Type:	E-Field Probe E-020
Serial Number:	265
Frequency:	5800 MHz
Sensor Offset:	1.56 mm
Sensor Length:	2.5 mm
Tip Enclosure:	Ertalyte*
Tip Diameter:	<5 mm
Tip Length:	60 mm
Total Length:	290 mm

*Resistive to recommended tissue recipes per IEEE-1528

Sensitivity in Air

Channel X:	$1.2 \mu\text{V}/(\text{V}/\text{m})^2$
Channel Y:	$1.2 \mu\text{V}/(\text{V}/\text{m})^2$
Channel Z:	$1.2 \mu\text{V}/(\text{V}/\text{m})^2$
Diode Compression Point:	95 mV

Sensitivity in Body Tissue

Frequency: 5800 MHz

Epsilon: 48.2 (+/-10%) **Sigma:** 6.0 S/m (+/-5%)

ConvF

Channel X: 3.9

Channel Y: 3.9

Channel Z: 3.9

Tissue sensitivity values were calculated using the load impedance of the APREL Laboratories Daq-Paq.

Boundary Effect:

Uncertainty resulting from the boundary effect is less than 2% for the distance between the tip of the probe and the tissue boundary, when less than 2.44mm.

Spatial Resolution:

The measured probe tip diameter is 5 mm (+/- 0.01 mm) and therefore meets the requirements of SSI/DRB-TP-D01-032 for spatial resolution.

Receiving Pattern 5800 MHz (Air)

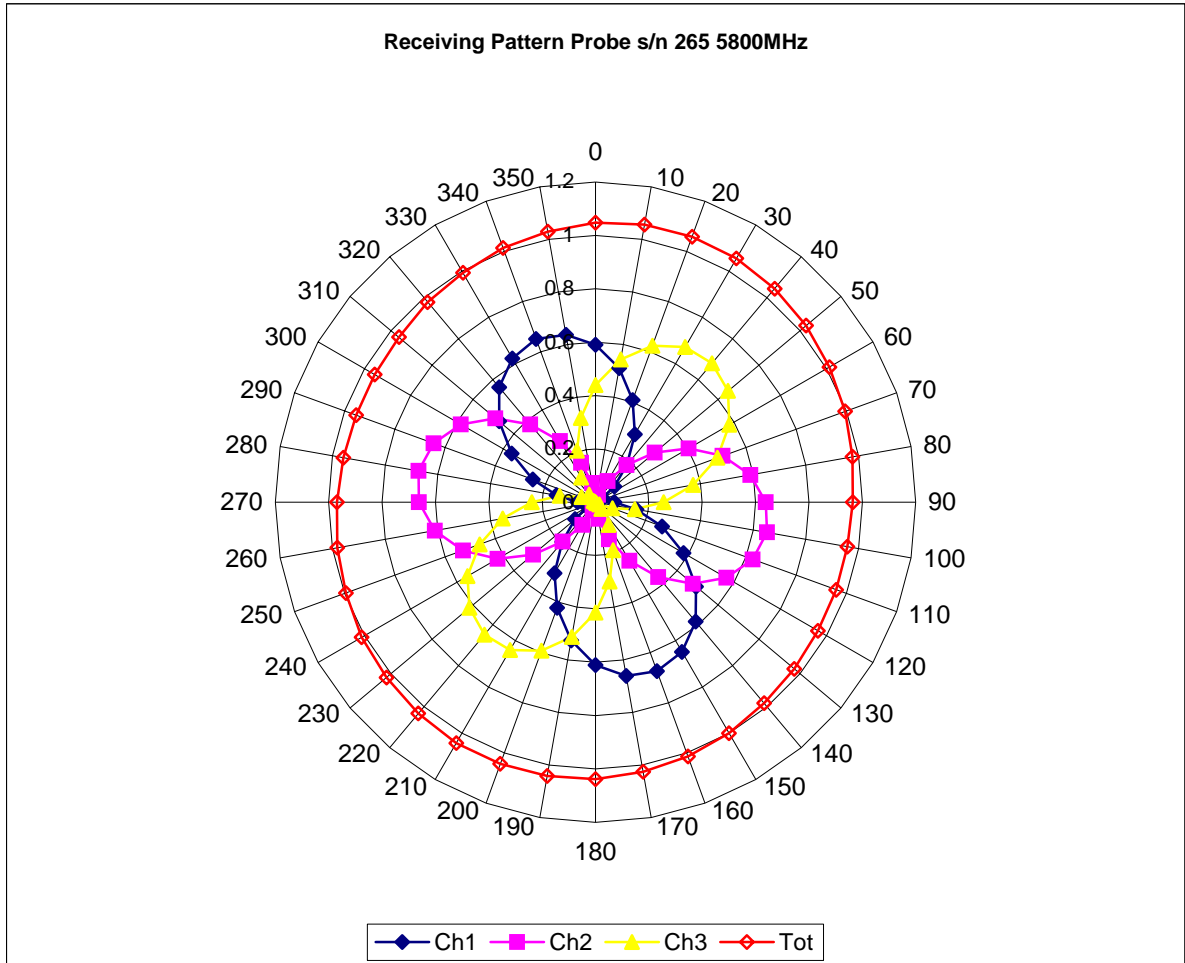

Isotropy Error 5800 MHz (Air)

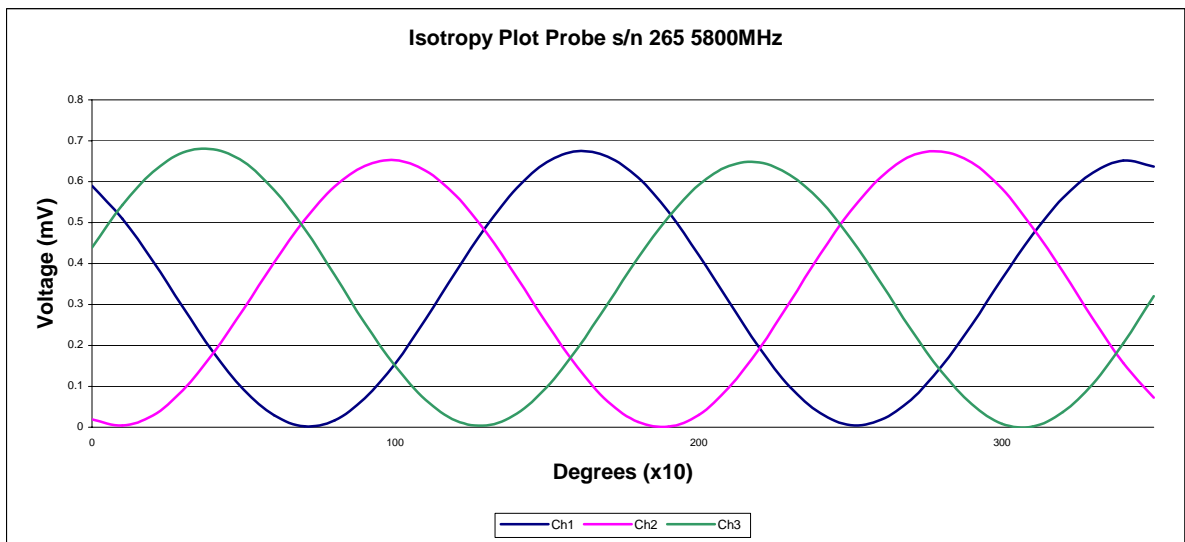
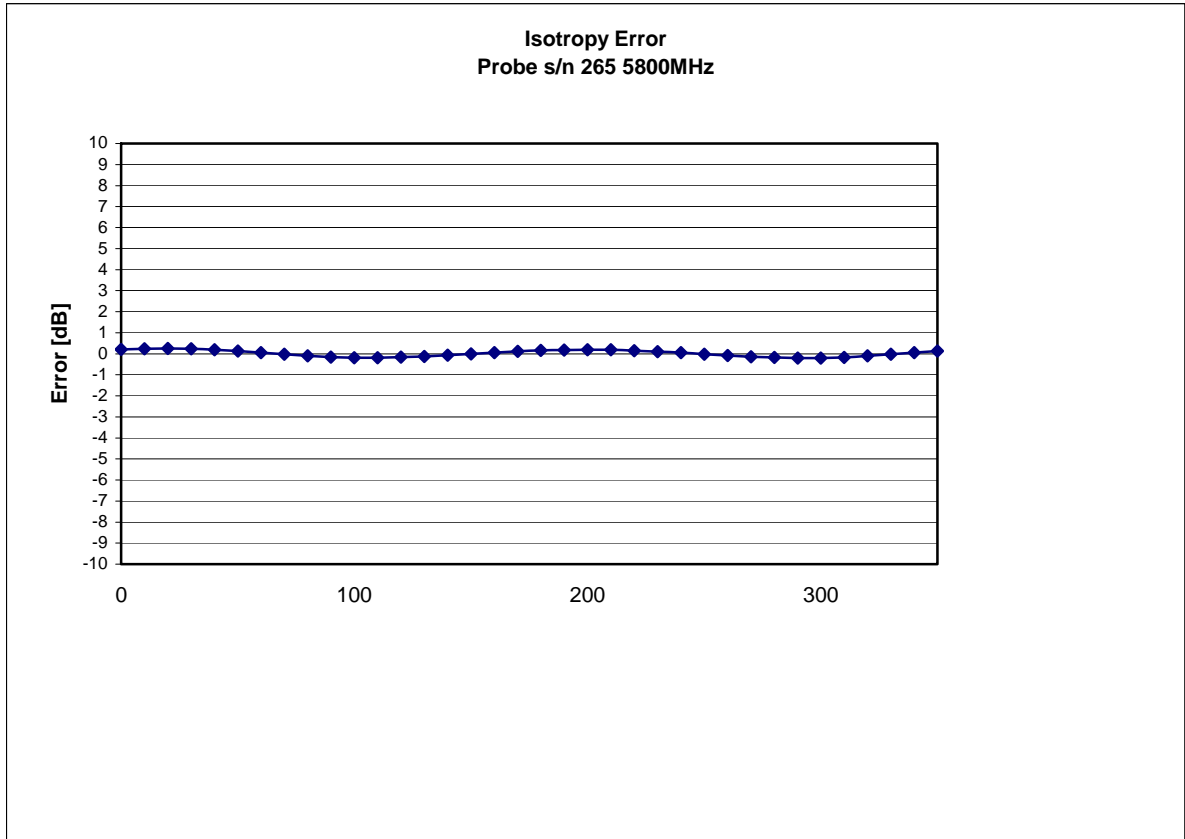

Isotropicity in Tissue:

0.10 dB

Dynamic Range

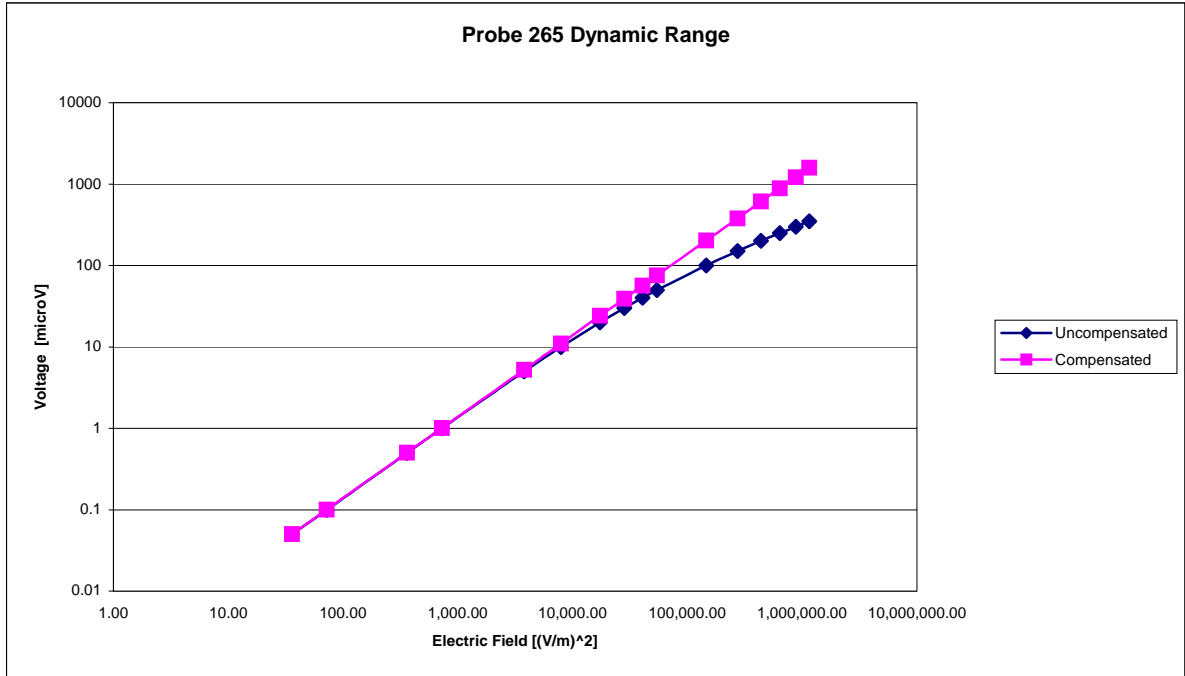

Video Bandwidth

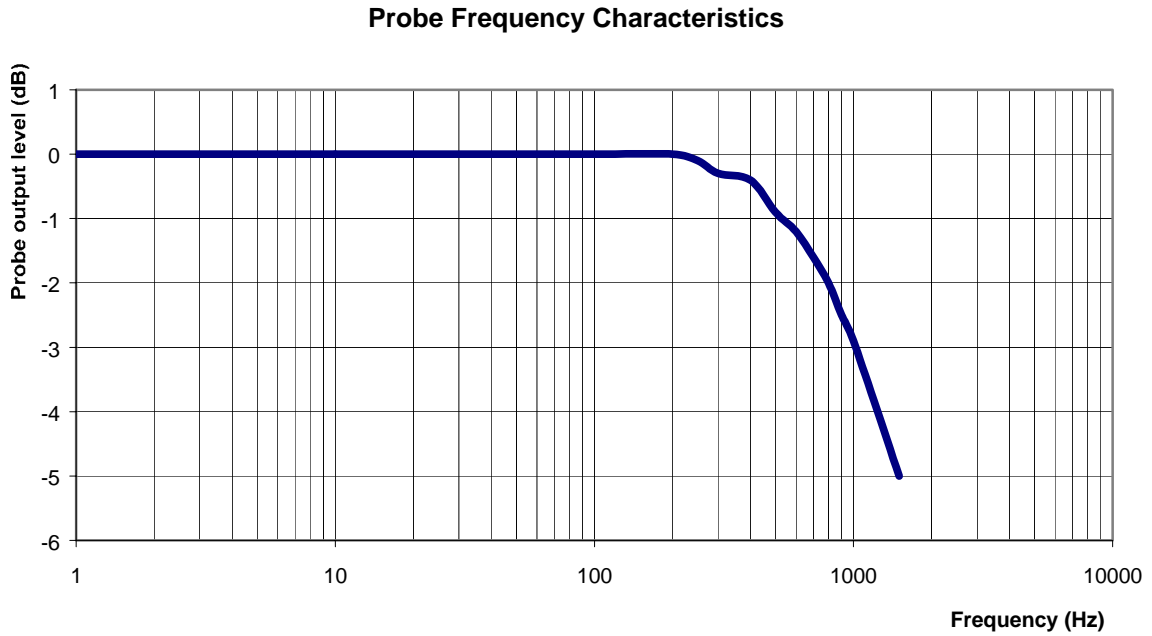

Video Bandwidth at 500 Hz 1 dB
Video Bandwidth at 1000 Hz 3 dB

Conversion Factor Uncertainty Assessment

Frequency: 5800MHz
Epsilon: 48.2 (+/-10%) **Sigma:** 6.0 S/m (+/-5%)

ConvF

Channel X: 3.9 7%(K=2)
Channel Y: 3.9 7%(K=2)
Channel Z: 3.9 7%(K=2)

To minimize the uncertainty calculation all tissue sensitivity values were calculated using a load impedance of 5 M Ω .

Boundary Effect:

For a distance of 2.4mm the evaluated uncertainty (increase in the probe sensitivity) is less than 2%.

Test Equipment

The test equipment used during Probe Calibration, manufacturer, model number and, current calibration status are listed and located on the main APREL server R:\NCL\Calibration Equipment\Instrument List May 2008.



Appendix E. Dipole Calibration

Validation Dipole 2450 MHz

M/N: ALS-D-2450-S-2

S/N: QTK-319

NCL CALIBRATION LABORATORIES

Calibration File No: DC-891

CERTIFICATE OF CALIBRATION

It is certified that the equipment identified below has been calibrated in the **NCL CALIBRATION LABORATORIES** by qualified personnel following recognized procedures and using transfer standards traceable to NRC/NIST.

Quietek Validation Dipole

Manufacturer: APREL Laboratories

Part number: ALS-D-2450-S-2

Frequency: 2.45 GHz

Serial No: QTK-319

Customer: Quietek

Project Number: QTKB-Dipole-CAL-5336

Calibrated: 9th May 2008
Released on: 9th May 2008

This Calibration Certificate is Incomplete Unless Accompanied with the Calibration Results Summary

Released By: _____

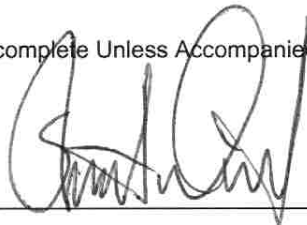

NCL CALIBRATION LABORATORIES

51 SPECTRUM WAY
NEPEAN, ONTARIO
CANADA K2R 1E6

Division of APREL Lab.
TEL: (613) 820-4988
FAX: (613) 820-4161

Calibration Results Summary

The following results relate the Calibrated Dipole and should be used as a quick reference for the user.

Mechanical Dimensions

Length: 53.5 mm
Height: 30.4 mm

Electrical Specification

SWR: 1.19 U
Return Loss: -20.8 dB
Impedance: 49.4 Ω

System Validation Results

Frequency	1 Gram	10 Gram	Peak
2.45 GHz	48.07	25.65	95.6

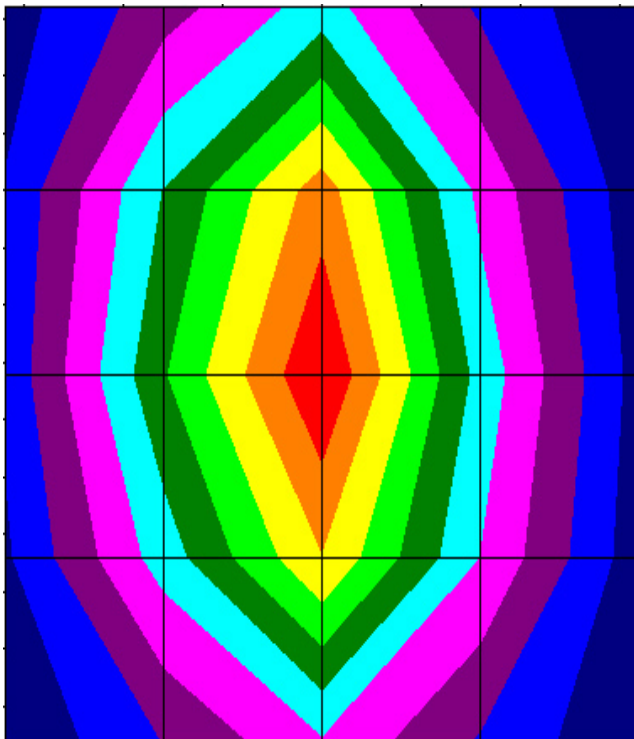

Conditions

Dipole 319 is a recalibration.

Ambient Temperature of the Laboratory: 22 °C +/- 0.5°C
Temperature of the Tissue: 21 °C +/- 0.5°C

References

SSI-TP-018-ALSAS Dipole Calibration Procedure

SSI-TP-016 Tissue Calibration Procedure

IEEE 1528 "Recommended Practice for Determining the Peak Spatial-Average Specific Absorption Rate (SAR) in the Human Body Due to Wireless Communications Devices: Experimental Techniques"

IEC 62209 "Human exposure to radio frequency fields from hand-held and body-mounted wireless communication devices – Human models, instrumentation, and procedures –Part 1 & Part 2: Procedure to determine the specific absorption rate (SAR) for mobile wireless communication devices used in close proximity to the human body (frequency range of 30 MHz to 6 GHz)

We the undersigned attest that to the best of our knowledge the calibration of this device has been accurately conducted and that all information contained within this report has been reviewed for accuracy.



Stuart Nicol



C. Teodorian

Dipole Calibration Results

Mechanical Verification

IEEE Length	IEEE Height	Measured Length	Measured Height
51.5 mm	30.4 mm	53.5 mm	30.4 mm

Tissue Validation

Head Tissue 2450 MHz	Measured
Dielectric constant, ϵ_r	40.1
Conductivity, σ [S/m]	1.78

Electrical Calibration

Test	Result
S11 R/L	-20.8 dB
SWR	1.2 U
Impedance	49.4 Ω

The Following Graphs are the results as displayed on the Vector Network Analyzer.

S11 Parameter Return Loss

S11 FORWARD REFLECTION

LOG MAGNITUDE

REF = -25.000 dB

5.000 dB/DIV

CH 1 - S11
REFERENCE PLANE
0.0000 mm

MARKER 1
2.450046 GHz
-20.796 dB

MARKER TO MAX
▶ MARKER TO MIN

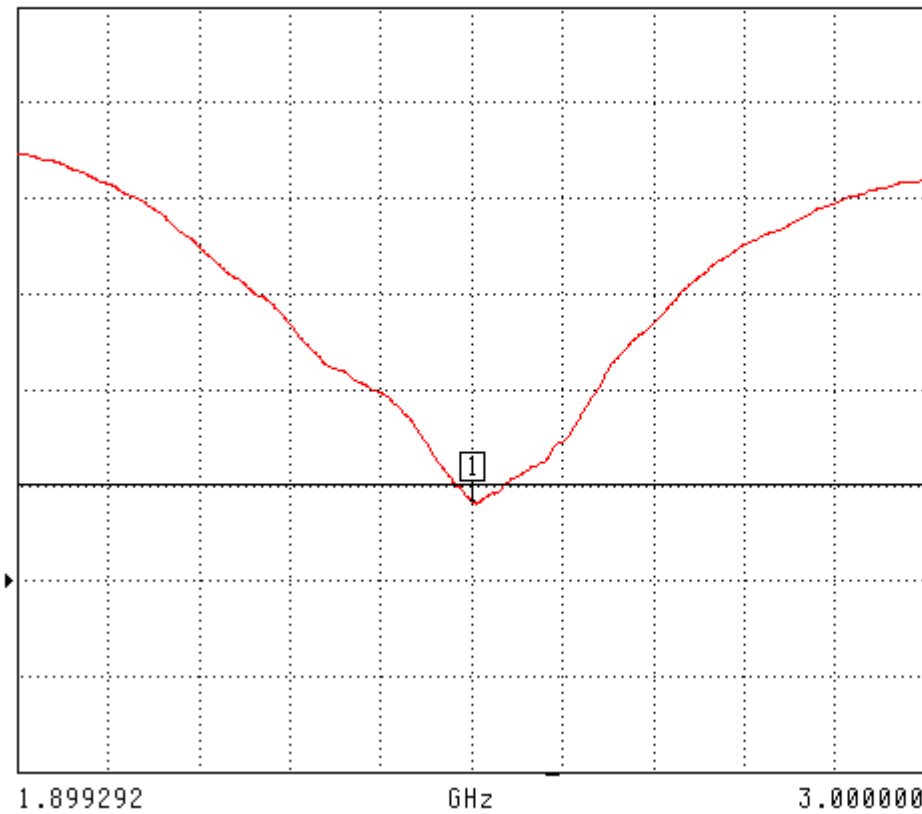

MARKER READOUT
FUNCTIONS

SWR

S11 FORWARD REFLECTION

SWR

REF=500.000 mU

1.000 U/DIV

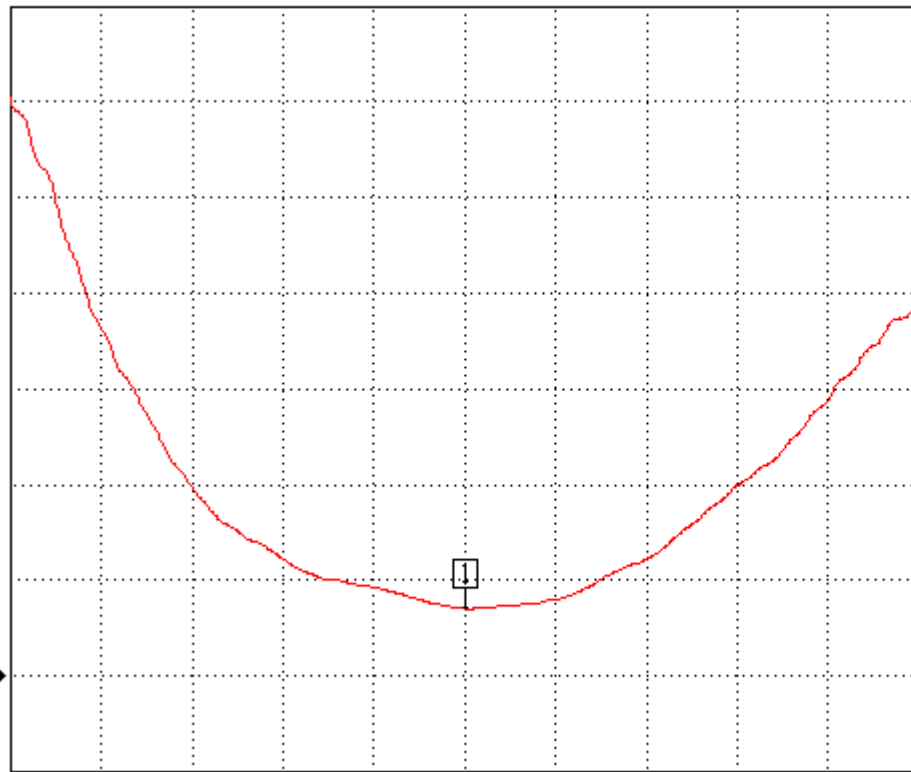

CH 1 - S11
REFERENCE PLANE
0.0000 mm

MARKER 1
2.450046 GHz
1.199 U

MARKER TO MAX
▶ MARKER TO MIN

1.899292

GHz

3.000000

MARKER READOUT
FUNCTIONS

Smith Chart Dipole Impedance

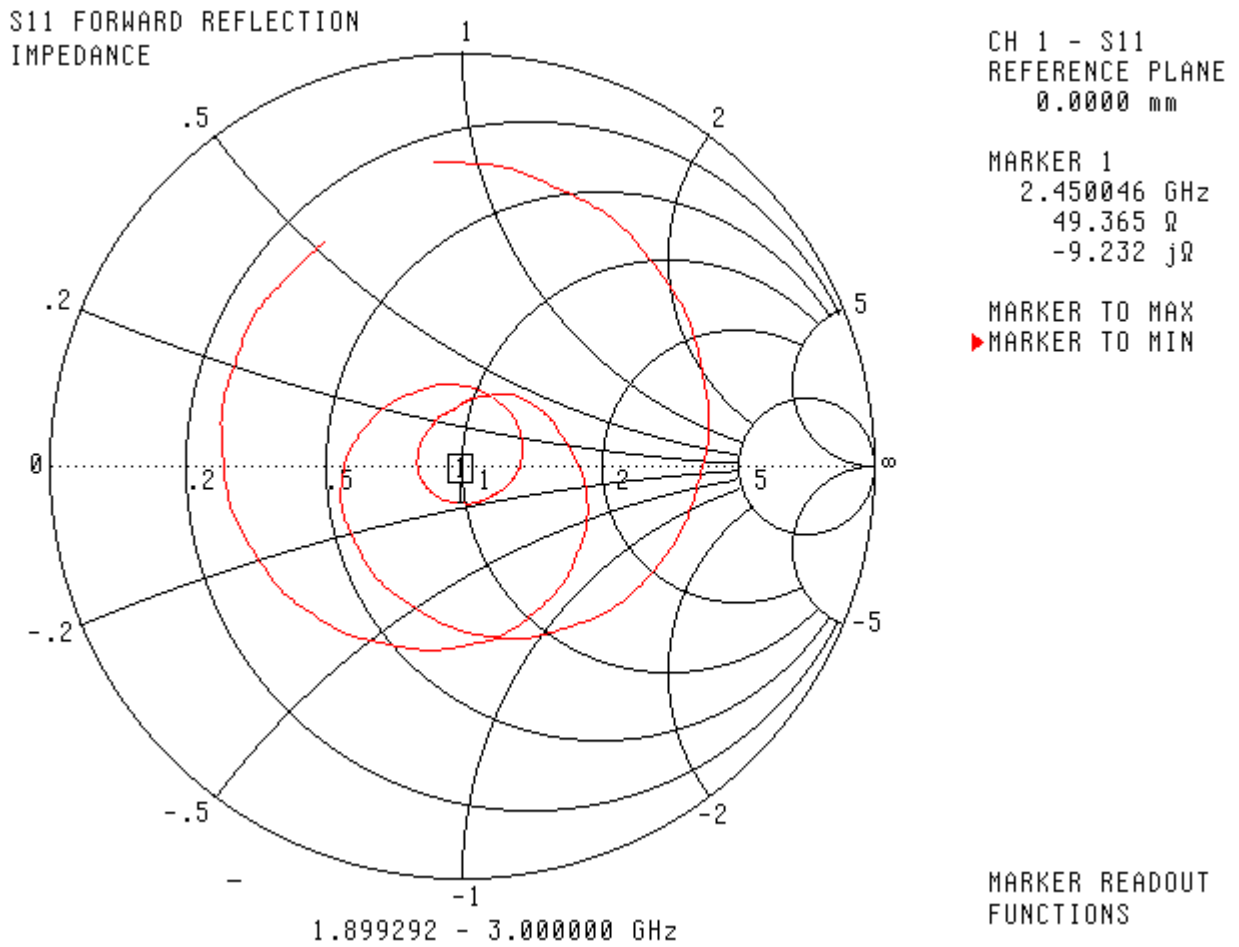

System Validation Results Using the Electrically Calibrated Dipole

Frequency	1 Gram	10 Gram	Peak Above Feed Point
2.45 GHz	48.07	25.65	95.6

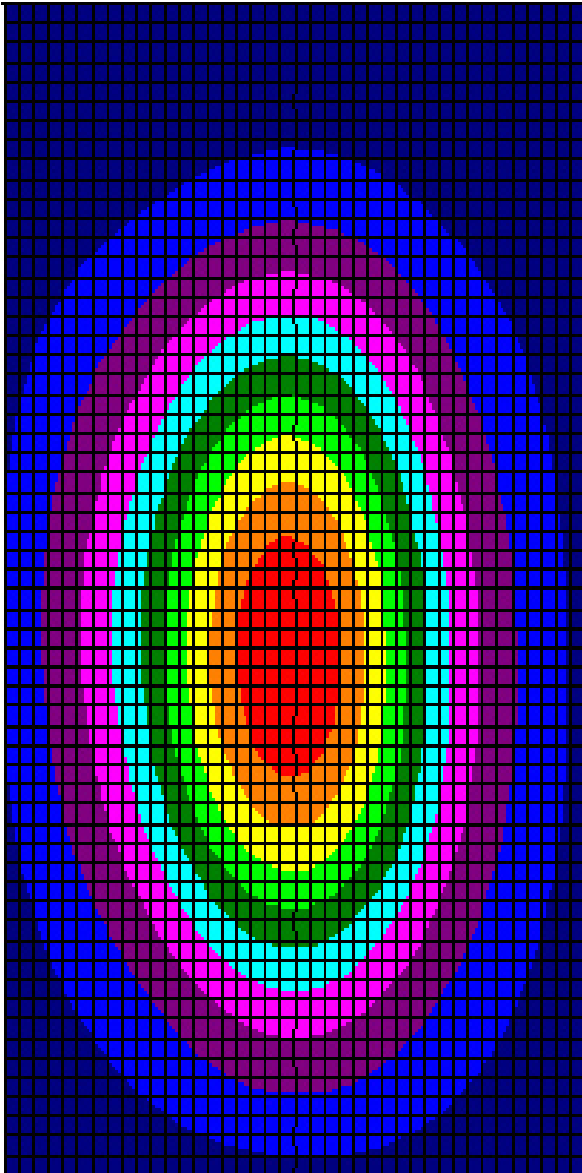

NCL Calibration Laboratories

Division of APREL Laboratories.

Test Equipment

The test equipment used during Probe Calibration, manufacturer, model number and, current calibration status are listed and located on the main APREL server R:\NCL\Calibration Equipment\Instrument List May 2008.



Appendix E. Dipole Calibration

Validation Dipole 5200 MHz

M/N: ALS-D-5200-S-2

S/N: QTK-320

NCL CALIBRATION LABORATORIES

Calibration File No: DC-892

CERTIFICATE OF CALIBRATION

It is certified that the equipment identified below has been calibrated in the **NCL CALIBRATION LABORATORIES** by qualified personnel following recognized procedures and using transfer standards traceable to NRC/NIST.

Quietek Validation Dipole

Manufacturer: APREL Laboratories

Part number: ALS-D-5200-S-2

Frequency: 5.2 GHz

Serial No: QTK-320

Customer: Quietek

Project Number: QTKB-Dipole-CAL-5336

Calibrated: 9th May 2008
Released on: 9th May 2008

This Calibration Certificate is Incomplete Unless Accompanied with the Calibration Results Summary

Released By: _____

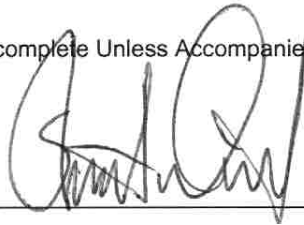

NCL CALIBRATION LABORATORIES

51 SPECTRUM WAY
NEPEAN, ONTARIO
CANADA K2R 1E6

Division of APREL Lab.
TEL: (613) 820-4988
FAX: (613) 820-4161

Calibration Results Summary

The following results relate the Calibrated Dipole and should be used as a quick reference for the user.

Mechanical Dimensions

Length: 23.6 mm
Height: 14.0 mm

Electrical Specification

SWR: 1.57 U
Return Loss: -13.15 dB
Impedance: 78.2 Ω

System Validation Results

Frequency	1 Gram
5200 GHz	58.8

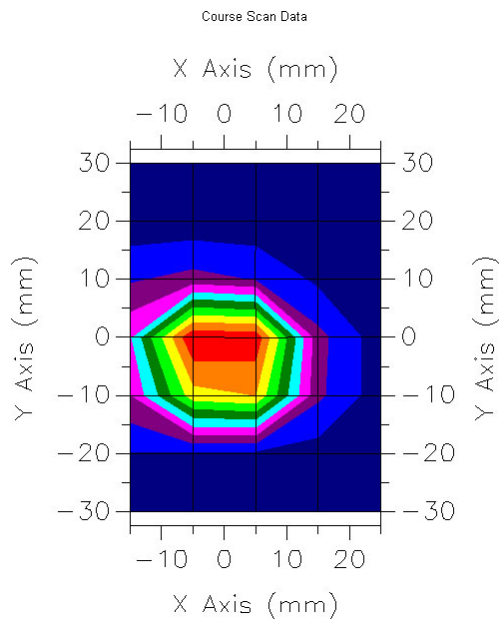

Conditions

Dipole 320 is a recalibration.

Ambient Temperature of the Laboratory: 22 °C +/- 0.5°C

Temperature of the Tissue: 21 °C +/- 0.5°C

References

SSI-TP-018-ALSAS Dipole Calibration Procedure

SSI-TP-016 Tissue Calibration Procedure

IEEE 1528 “Recommended Practice for Determining the Peak Spatial-Average Specific Absorption Rate (SAR) in the Human Body Due to Wireless Communications Devices: Experimental Techniques”

IEC 62209 “Human exposure to radio frequency fields from hand-held and body-mounted wireless communication devices – Human models, instrumentation, and procedures –Part 1 & Part 2: Procedure to determine the specific absorption rate (SAR) for mobile wireless communication devices used in close proximity to the human body (frequency range of 30 MHz to 6 GHz)

We the undersigned attest that to the best of our knowledge the calibration of this device has been accurately conducted and that all information contained within this report has been reviewed for accuracy.

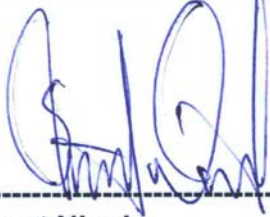

Stuart Nicol



C. Teodorian

Dipole Calibration Results

Mechanical Verification

APREL Length	APREL Height	Measured Length	Measured Height
23.6 mm	14.0 mm	23.1 mm	14.2 mm

Tissue Validation

Head Tissue 5200 MHz	Measured
Dielectric constant, ϵ_r	39.94
Conductivity, σ [S/m]	5.24

Electrical Calibration

Test	Result
S11 R/L	-13.15 dB
SWR	1.57 U
Impedance	78.2 Ω

The Following Graphs are the results as displayed on the Vector Network Analyzer.

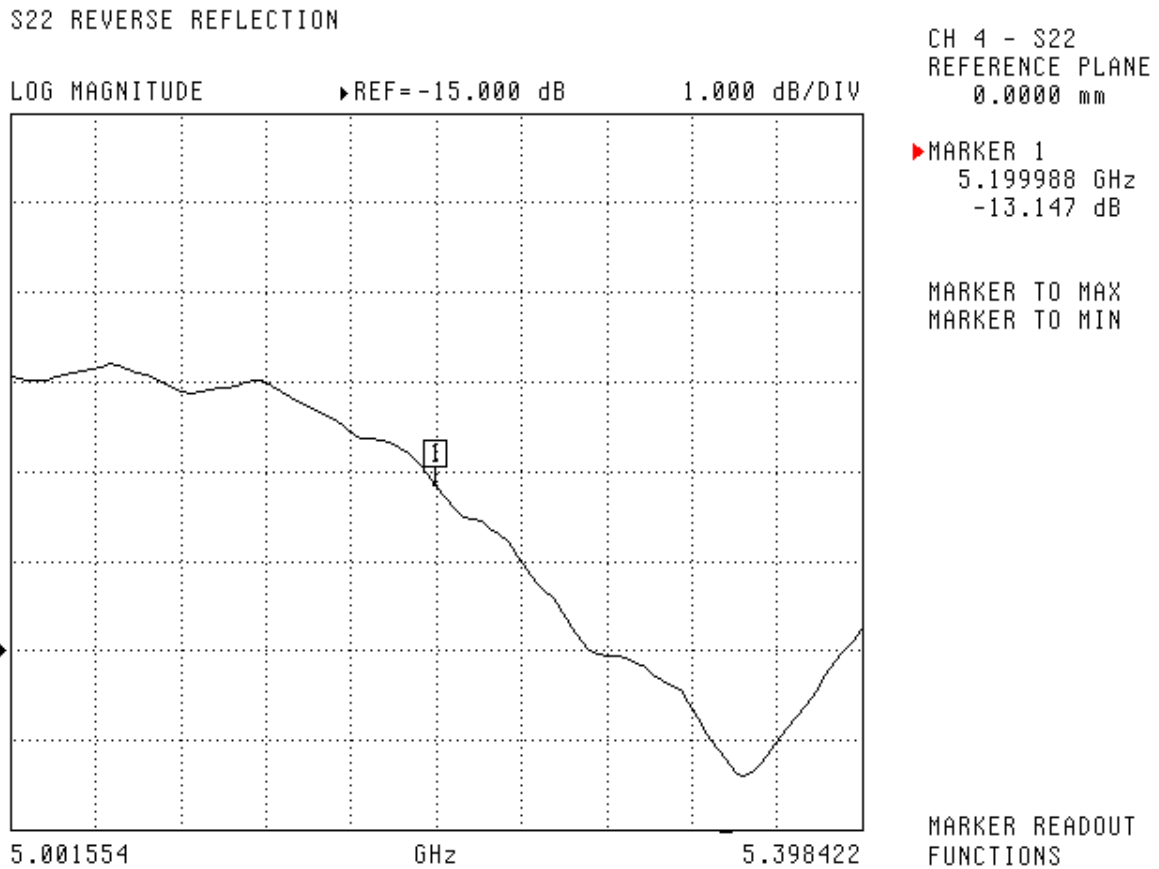

S11 Parameter Return Loss

NCL Calibration Laboratories

Division of APREL Laboratories.

S22 REVERSE REFLECTION

SWR ▶ REF=1.500 U 50.000 mU/DIV

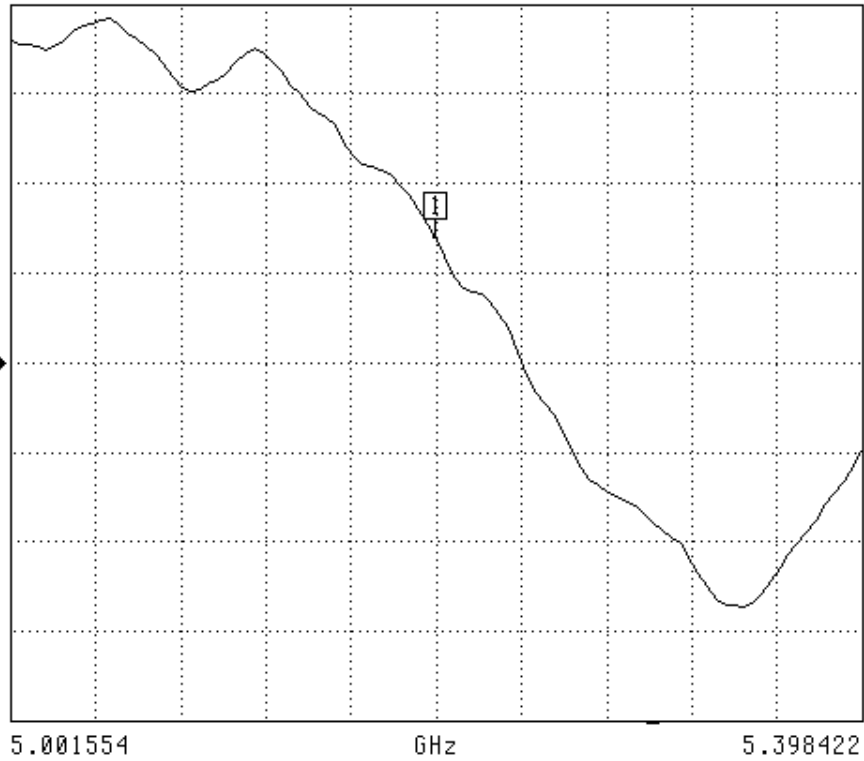

SWR

Smith Chart Dipole Impedance

S22 REVERSE REFLECTION
IMPEDANCE

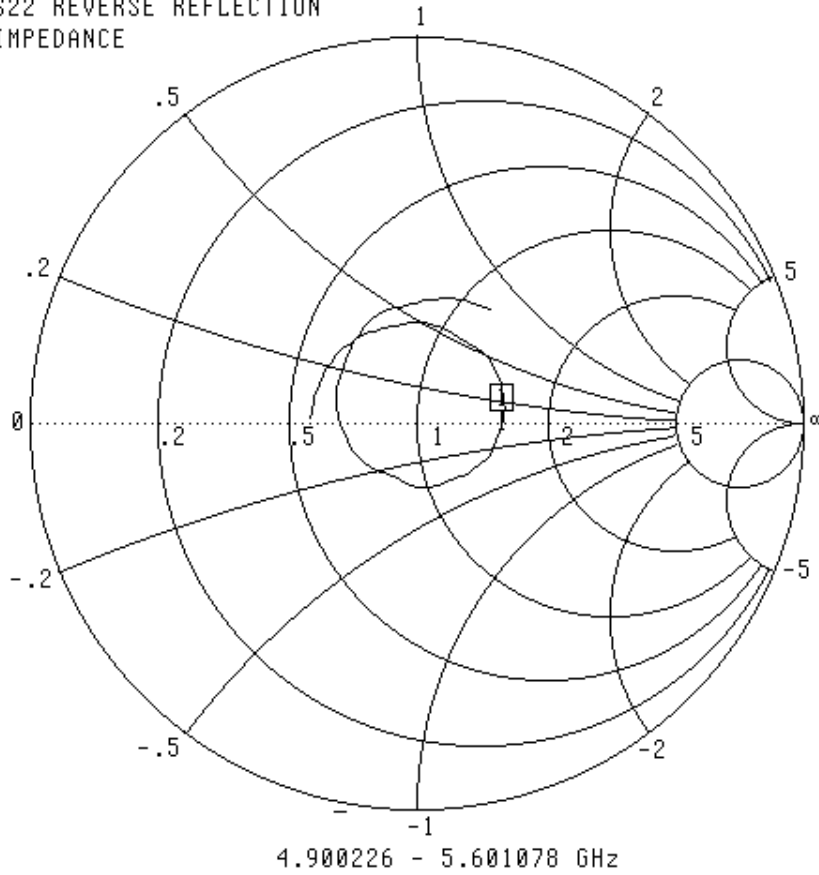

CH 4 - S22
REFERENCE PLANE
0.0000 mm

▶ MARKER 1
5.199988 GHz
78.201 Ω
-3.155 $j\Omega$

MARKER TO MAX
MARKER TO MIN

MARKER READOUT
FUNCTIONS

System Validation Results Using a Complex Dipole Model (FDTD calculations)

Frequency	1 Gram
5.2 GHz	58.8

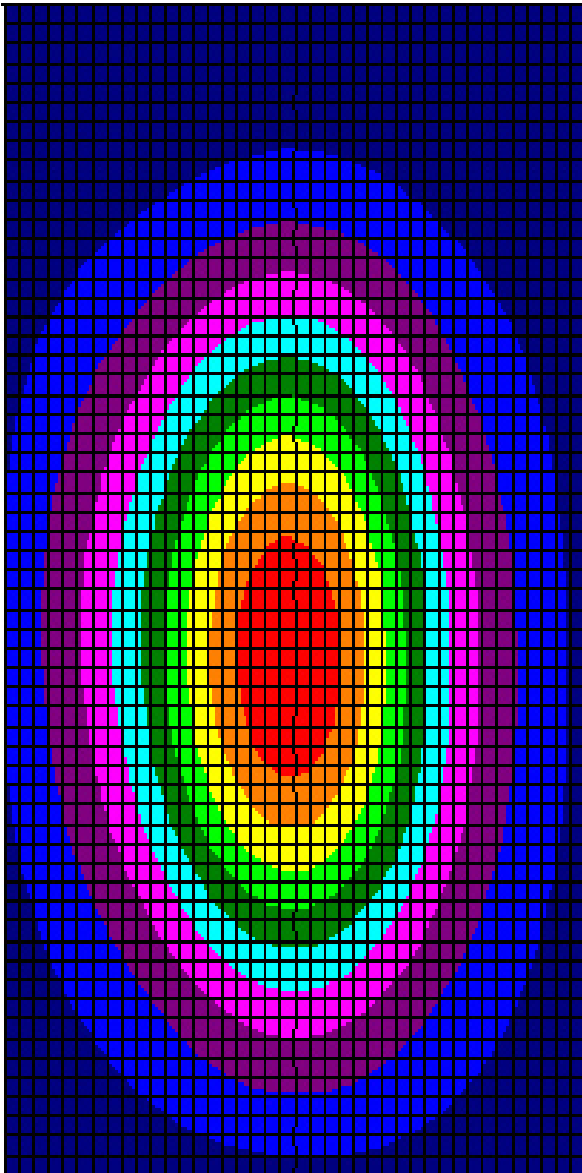

Test Equipment

NCL Calibration Laboratories

Division of APREL Laboratories.

The test equipment used during Probe Calibration, manufacturer, model number and, current calibration status are listed and located on the main APREL server R:\NCL\Calibration List May 2008.



Appendix E. Dipole Calibration

Validation Dipole 5800 MHz

M/N: ALS-D-5800-S-2

S/N: QTK-321

NCL CALIBRATION LABORATORIES

Calibration File No: DC-893

CERTIFICATE OF CALIBRATION

It is certified that the equipment identified below has been calibrated in the **NCL CALIBRATION LABORATORIES** by qualified personnel following recognized procedures and using transfer standards traceable to NRC/NIST.

Quietek Validation Dipole

Manufacturer: APREL Laboratories

Part number: ALS-D-5800-S-2

Frequency: 5.8 GHz

Serial No: QTK-321

Customer: Quietek

Project Number: QTKB-Dipole-CAL-5336

Calibrated: 9th May 2008
Released on: 9th May 2008

This Calibration Certificate is Incomplete Unless Accompanied with the Calibration Results Summary

Released By: _____

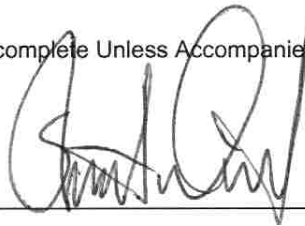

NCL CALIBRATION LABORATORIES

51 SPECTRUM WAY
NEPEAN, ONTARIO
CANADA K2R 1E6

Division of APREL Lab.
TEL: (613) 820-4988
FAX: (613) 820-4161

Calibration Results Summary

The following results relate the Calibrated Dipole and should be used as a quick reference for the user.

Mechanical Dimensions

Length: 21.6 mm
Height: 12.6 mm

Electrical Specification

SWR: 1.74 U
Return Loss: -11.5 dB
Impedance: 68.3 Ω

System Validation Results

Frequency	1 Gram
5800 GHz	57.9

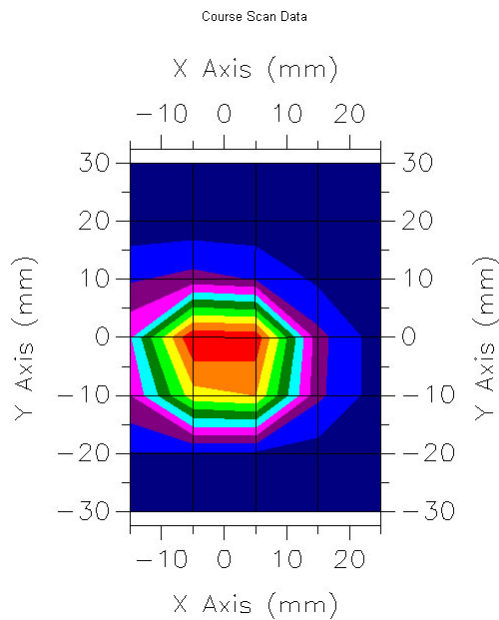

Conditions

Dipole 321 is a recalibration.

Ambient Temperature of the Laboratory: 22 °C +/- 0.5°C

Temperature of the Tissue: 21 °C +/- 0.5°C

References

SSI-TP-018-ALSAS Dipole Calibration Procedure

SSI-TP-016 Tissue Calibration Procedure

IEEE 1528 "Recommended Practice for Determining the Peak Spatial-Average Specific Absorption Rate (SAR) in the Human Body Due to Wireless Communications Devices: Experimental Techniques"

IEC 62209 "Human exposure to radio frequency fields from hand-held and body-mounted wireless communication devices – Human models, instrumentation, and procedures –Part 1 & Part 2: Procedure to determine the specific absorption rate (SAR) for mobile wireless communication devices used in close proximity to the human body (frequency range of 30 MHz to 6 GHz)

We the undersigned attest that to the best of our knowledge the calibration of this device has been accurately conducted and that all information contained within this report has been reviewed for accuracy.

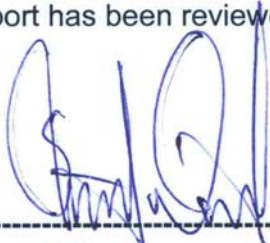

Stuart Nicol



C. Teodorian

Dipole Calibration Results

Mechanical Verification

APREL Length	APREL Height	Measured Length	Measured Height
21.6 mm	12.6 mm	21.2 mm	13.1 mm

Tissue Validation

Head Tissue 5800 MHz	Measured
Dielectric constant, ϵ_r	35.15
Conductivity, σ [S/m]	6.4

Electrical Calibration

Test	Result
S11 R/L	-11.5 dB
SWR	1.74 U
Impedance	68.3 Ω

The Following Graphs are the results as displayed on the Vector Network Analyzer.

S11 Parameter Return Loss

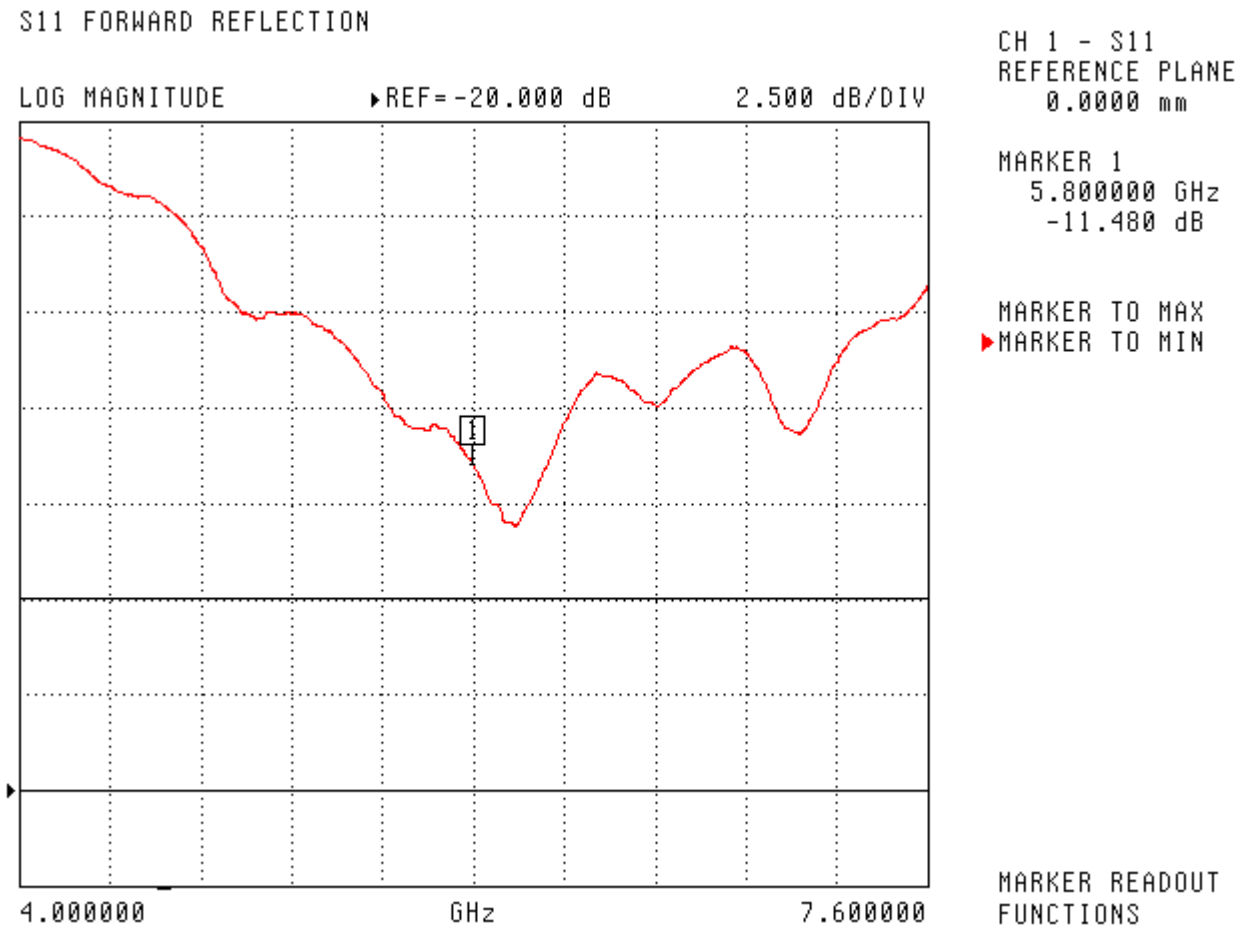

SWR

S11 FORWARD REFLECTION

SWR REF=500.000 mU 1.000 U/DIV

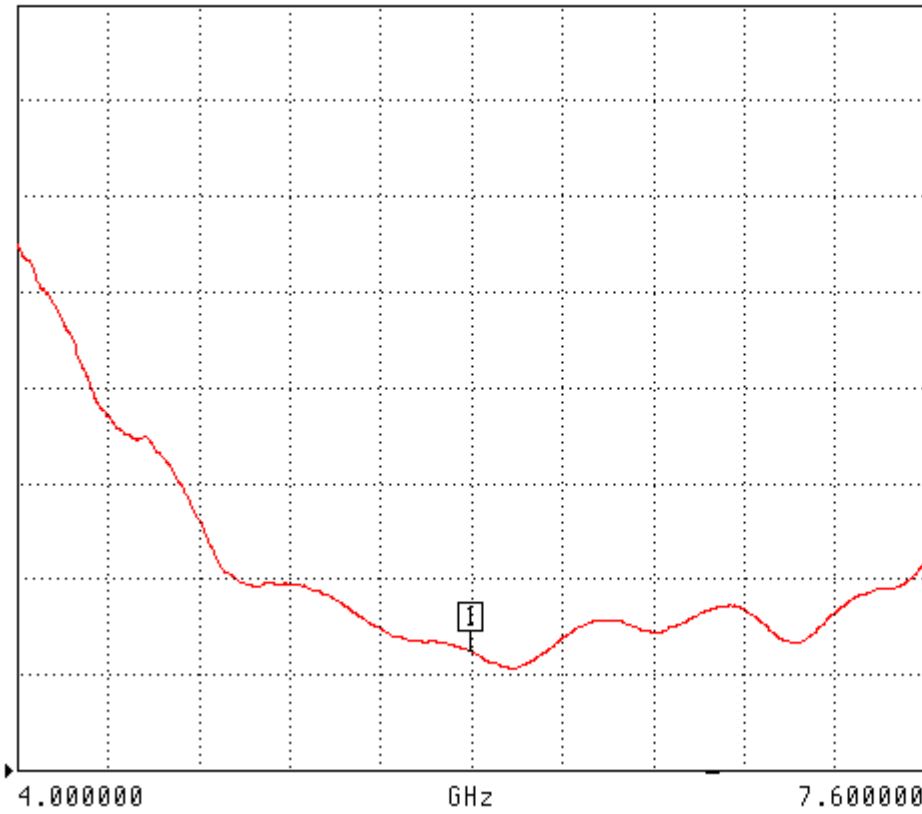

Smith Chart Dipole Impedance

S11 FORWARD REFLECTION
IMPEDANCE

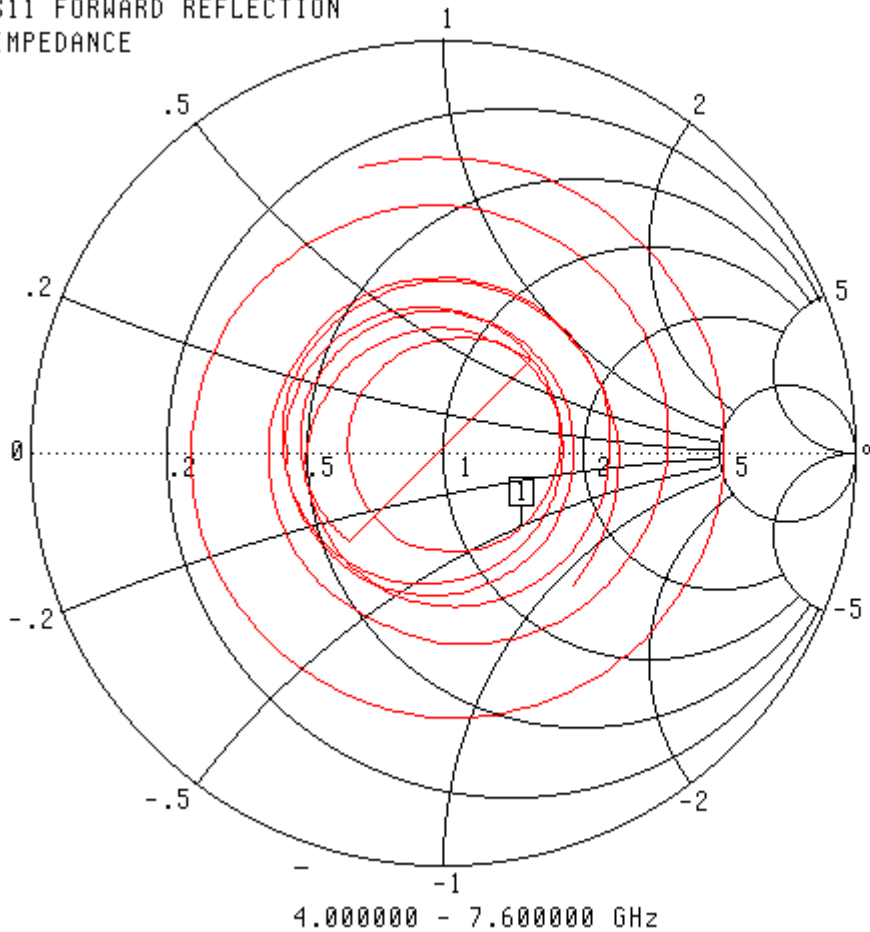

CH 1 - S11
REFERENCE PLANE
0.0000 mm

MARKER 1
5.800000 GHz
68.290 Ω
-26.643 $j\Omega$

MARKER TO MAX
▶ MARKER TO MIN

MARKER READOUT
FUNCTIONS

System Validation Results Using a Complex Dipole Model (FDTD calculations)

Frequency	1 Gram
5.8 GHz	57.9

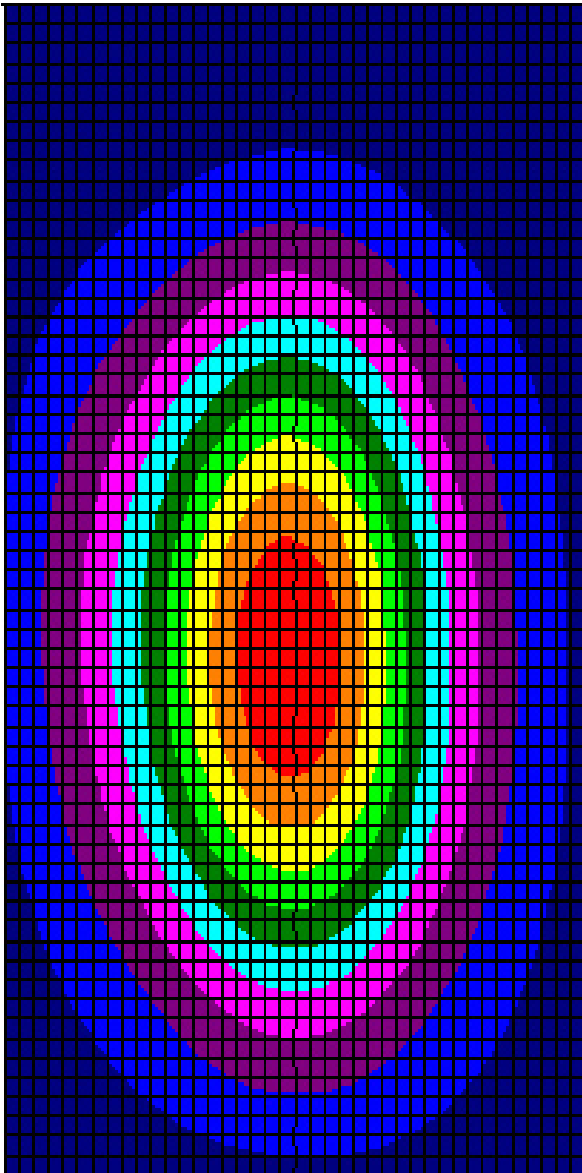

Test Equipment

NCL Calibration Laboratories

Division of APREL Laboratories.

The test equipment used during Probe Calibration, manufacturer, model number and, current calibration status are listed and located on the main APREL server R:\NCL\Calibration List May 2008.