



## **Appendix E. Dipole Calibration Data**

**Validation Dipole 835MHz**

**P/N: ALS-D-835-S-2**

**S/N: QTK-316**

**NCL CALIBRATION LABORATORIES**

Calibration File No: DC-405-1  
Project Number: QTKB-Dipole Cal-5226

**CERTIFICATE OF CALIBRATION**

It is certified that the equipment identified below has been calibrated in the  
**NCL CALIBRATION LABORATORIES** by qualified personnel following recognized  
procedures and using transfer standards traceable to NRC/NIST.

Quietek Validation Dipole

Manufacturer: APREL Laboratories

Part number: ALS-D-835-S-2

Frequency: 835 MHz

Serial No: QTK-315

Customer: Quietek

Calibrated: 15 June 2006  
Released on: 15 June 2006

Released By: \_\_\_\_\_



**NCL CALIBRATION LABORATORIES**

51 SPECTRUM WAY  
NEPEAN, ONTARIO  
CANADA K2R 1E6

Division of APREL Lab.  
TEL: (613) 820-4988  
FAX: (613) 820-4162

### Calibration Results Summary

The following results relate the Calibrated Dipole and should be used as a quick reference for the user.

#### Mechanical Dimensions

**Length:** 165.0 mm  
**Height:** 90.0 mm

#### Electrical Specification

**SWR:** 1.05 U  
**Return Loss:** -31.5 dB  
**Impedance:** 47.6  $\Omega$

#### System Validation Results

Frequency	1 Gram	10 Gram	Peak
835 MHz	9.33	6.42	15.0

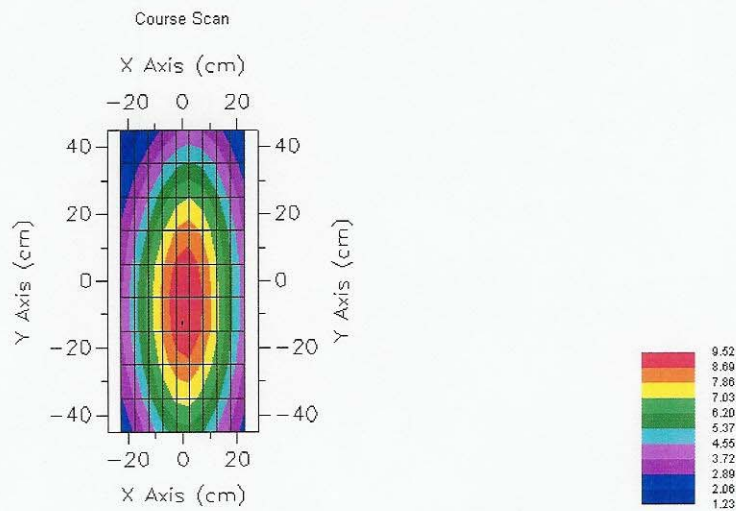

## Introduction

This Calibration Report has been produced in line with the SSI Dipole Calibration Procedure SSI-TP-018-ALSAS. The results contained within this report are for Validation Dipole QTK-315. The calibration routine consisted of a three-step process. Step 1 was a mechanical verification of the dipole to ensure that it meets the IEEE/APREL mechanical specifications. Step 2 was an Electrical Calibration for the Validation Dipole, where the SWR, Impedance, and the Return loss were assessed. Step 3 involved a System Validation using the ALSAS-10U, along with QTK E-020 130 MHz to 26 GHz E-Field Probe Serial Number 212.

## References

SSI-TP-018-ALSAS Dipole Calibration Procedure

SSI-TP-016 Tissue Calibration Procedure

IEEE 1528 "Recommended Practice for Determining the Peak Spatial-Average Specific Absorption Rate (SAR) in the Human Body Due to Wireless Communications Devices: Experimental Techniques"

## Conditions

Dipole QTK-315 was received for calibration.

**Ambient Temperature of the Laboratory:** 22 °C +/- 0.5°C

**Temperature of the Tissue:** 20 °C +/- 0.5°C



## Dipole Calibration Results

### Mechanical Verification

IEEE Length	IEEE Height	Measured Length	Measured Height
161.0 mm	89.8 mm	165.0 mm	90.0 mm

### Tissue Validation

Head Tissue 835 MHz	Measured
Dielectric constant, $\epsilon_r$	42.54
Conductivity, $\sigma$ [S/m]	0.91

**Electrical Calibration**

Test	Result
S11 R/L	-31.5 dB
SWR	1.06 U
Impedance	47.6 $\Omega$

The Following Graphs are the results as displayed on the Vector Network Analyzer.

**S11 Parameter Return Loss**

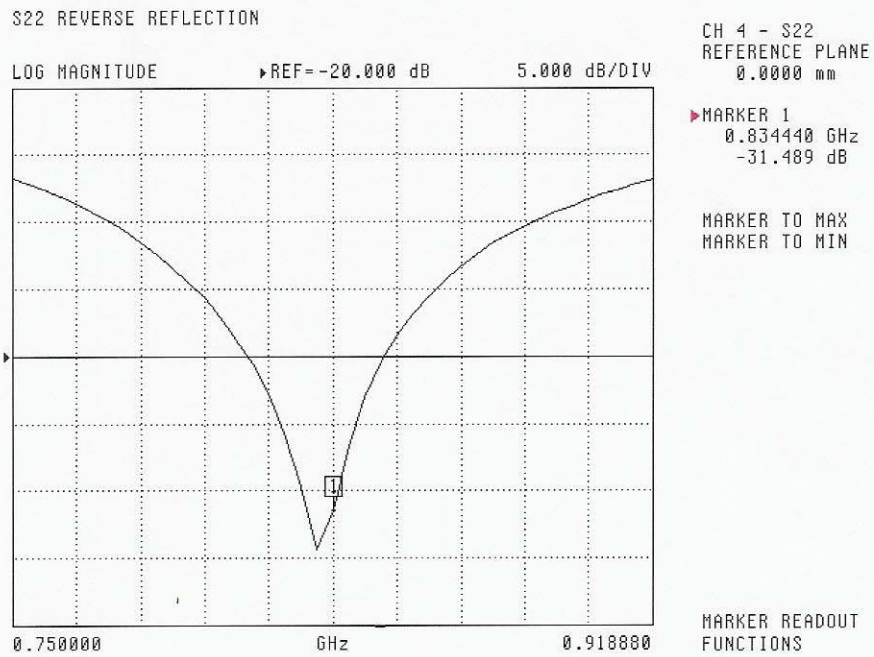

SWR

S22 REVERSE REFLECTION

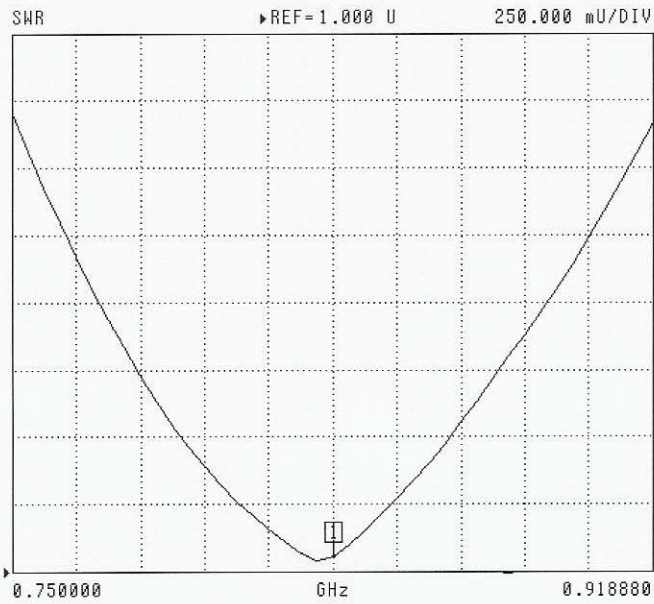

CH 4 - S22  
REFERENCE PLANE  
0.0000 mm

▶ MARKER 1  
0.834440 GHz  
1.055 U

MARKER TO MAX  
MARKER TO MIN

MARKER READOUT  
FUNCTIONS

### Smith Chart Dipole Impedance

S22 REVERSE REFLECTION  
IMPEDANCE

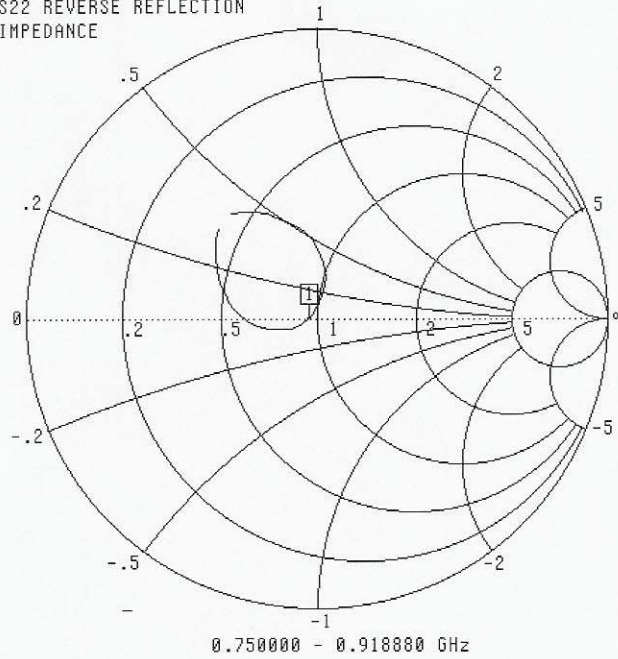

CH 4 - S22  
REFERENCE PLANE  
0.0000 mm

▶ MARKER 1  
0.834440 GHz  
47.585  $\Omega$   
34.845  $j\Omega$

MARKER TO MAX  
MARKER TO MIN

MARKER READOUT  
FUNCTIONS



System Validation Results Using the Electrically Calibrated Dipole

Head Tissue Frequency	1 Gram	10 Gram	Peak Above Feed Point
835 MHz	9.33	6.42	15.0

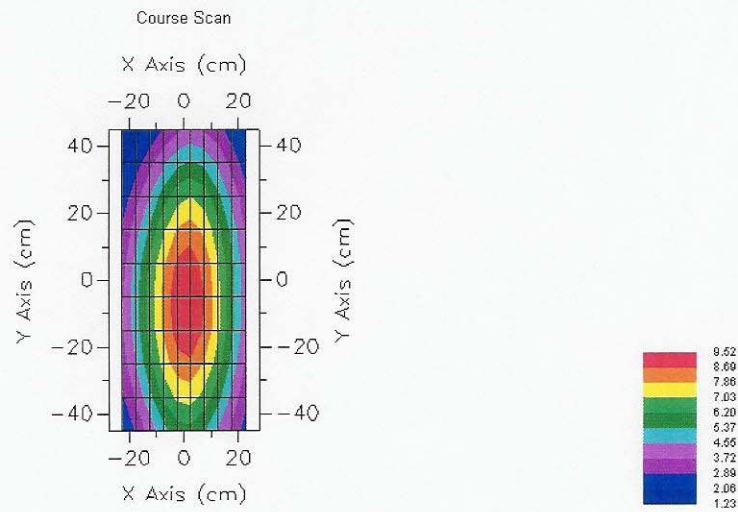

## Test Equipment

The test equipment used during Probe Calibration, manufacturer, model number and, current calibration status are listed and located on the main APREL server R:\NCL\Calibration Equipment\Instrument List



## NCL CALIBRATION LABORATORIES

Calibration File No: DC-408-1  
Project Number: QTKB-Dipole Cal-5230

# CERTIFICATE OF CALIBRATION

It is certified that the equipment identified below has been calibrated in the  
**NCL CALIBRATION LABORATORIES** by qualified personnel following recognized  
procedures and using transfer standards traceable to NRC/NIST.

Quietek Validation Dipole

Manufacturer: APREL Laboratories

Part number: ALS-D-1900-S-2

Frequency: 1.9 GHz

Serial No: QTK-318

Customer: Quietek

Calibrated: 15 June 2006  
Released on: 15 June 2006

Released By: \_\_\_\_\_



## **NCL** CALIBRATION LABORATORIES

51 SPECTRUM WAY  
NEPEAN, ONTARIO  
CANADA K2R 1E6

Division of APREL Lab.  
TEL: (613) 820-4988  
FAX: (613) 820-4161

## NCL Calibration Laboratories

Division of APREL Laboratories.

### Calibration Results Summary

The following results relate the Calibrated Dipole and should be used as a quick reference for the user.

#### Mechanical Dimensions

Length: 70.0 mm  
Height: 39.5 mm

#### Electrical Specification

SWR: 1.1 U  
Return Loss: -25.7 dB  
Impedance: 46.8  $\Omega$

#### System Validation Results

Frequency	1 Gram	10 Gram	Peak
1.9 GHz	36.0	20.78	67.7

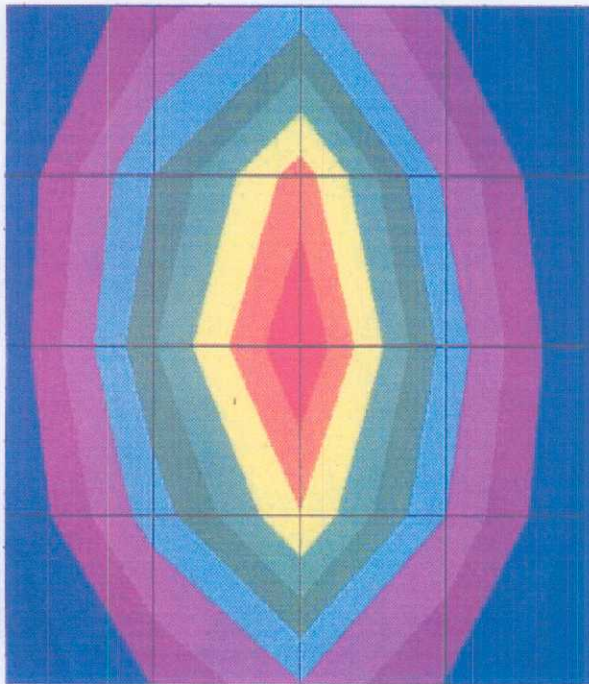

## **NCL Calibration Laboratories**

Division of APREL Laboratories.

---

### **Introduction**

This Calibration Report has been produced in line with the SSI Dipole Calibration Procedure SSI-TP-018-ALSAS. The results contained within this report are for Validation Dipole QTK-318. The calibration routine consisted of a three-step process. Step 1 was a mechanical verification of the dipole to ensure that it meets the IEEE/APREL mechanical specifications. Step 2 was an Electrical Calibration for the Validation Dipole, where the SWR, Impedance, and the Return loss were assessed. Step 3 involved a System Validation using the ALSAS-10U, along with QTK E-020 130 MHz to 26 GHz E-Field Probe Serial Number 212.

### **References**

SSI-TP-018-ALSAS Dipole Calibration Procedure  
SSI-TP-016 Tissue Calibration Procedure  
IEEE 1528 "Recommended Practice for Determining the Peak Spatial-Average Specific Absorption Rate (SAR) in the Human Body Due to Wireless Communications Devices: Experimental Techniques"

### **Conditions**

Dipole QTK-318 was received for calibration.

**Ambient Temperature of the Laboratory:** 22 °C +/- 0.5°C  
**Temperature of the Tissue:** 20 °C +/- 0.5°C

## Dipole Calibration Results

### Mechanical Verification

IEEE Length	IEEE Height	Measured Length	Measured Height
68.0 mm	39.5 mm	70.0 mm	39.5 mm

### Tissue Validation

Head Tissue 1900 MHz	Measured
Dielectric constant, $\epsilon_r$	39.9
Conductivity, $\sigma$ [S/m]	1.42

**NCL Calibration Laboratories**

Division of APREL Laboratories.

**Electrical Calibration**

Test	Result
S11 R/L	-25.7 dB
SWR	1.1 U
Impedance	46.8 $\Omega$

The Following Graphs are the results as displayed on the Vector Network Analyzer.

**S11 Parameter Return Loss**

S22 REVERSE REFLECTION

LOG MAGNITUDE

REF = -20.000 dB

5.000 dB/DIV

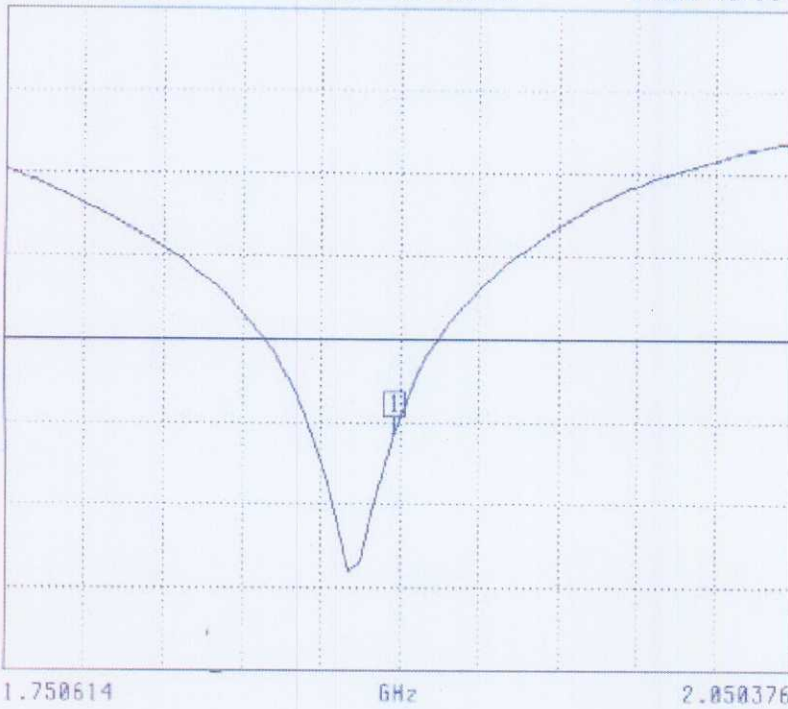

CH 4 - S22  
REFERENCE PLANE  
0.0000 mm

MARKER 1  
1.898384 GHz  
-25.740 dB

MARKER TO MAX  
MARKER TO MIN

MARKER READOUT  
FUNCTIONS

**NCL Calibration Laboratories**

Division of APREL Laboratories.

**SWR**

S22 REVERSE REFLECTION

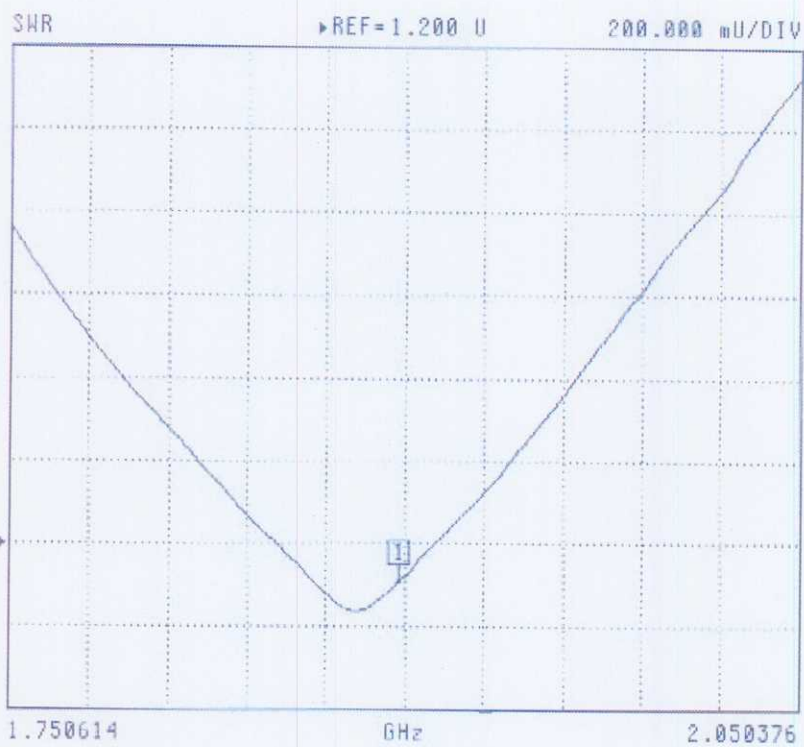

CH 4 - S22  
REFERENCE PLANE  
0.0000 mm

▶MARKER 1  
1.898384 GHz  
1.106 U

MARKER TO MAX  
MARKER TO MIN

MARKER READOUT  
FUNCTIONS



### Smith Chart Dipole Impedance

S22 REVERSE REFLECTION  
IMPEDANCE

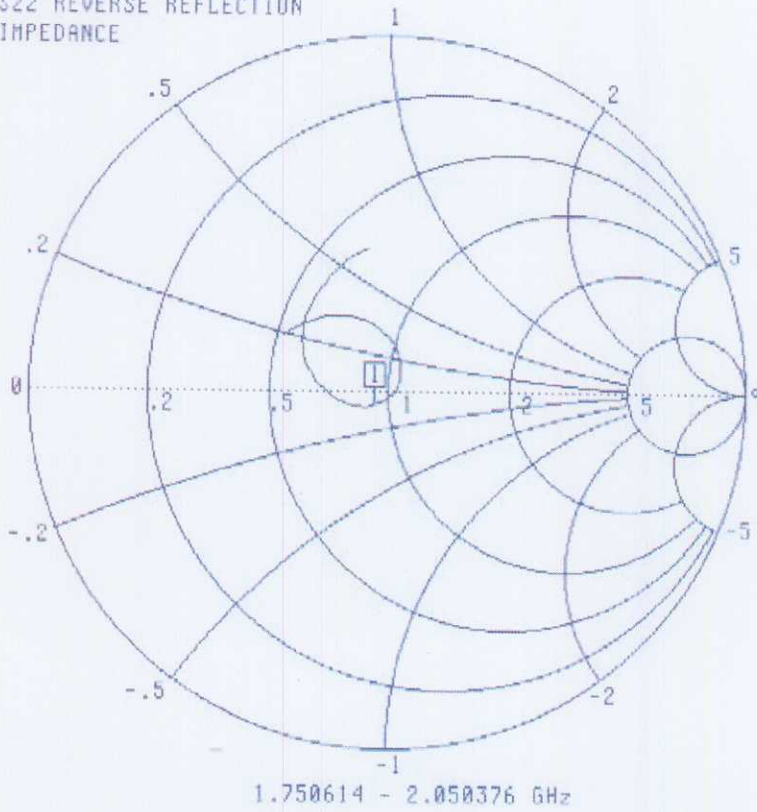

CH 4 - S22  
REFERENCE PLANE  
0.0000 mm

▶ MARKER 1  
1.898384 GHz  
46.767 Ω  
-3.770 jΩ

MARKER TO MAX  
MARKER TO MIN

MARKER READOUT  
FUNCTIONS

**NCL Calibration Laboratories**

Division of APREL Laboratories.

**System Validation Results Using the Electrically Calibrated Dipole**

Frequency	1 Gram	10 Gram	Peak Above Feed Point
1.9 GHz	36.0	20.78	67.7

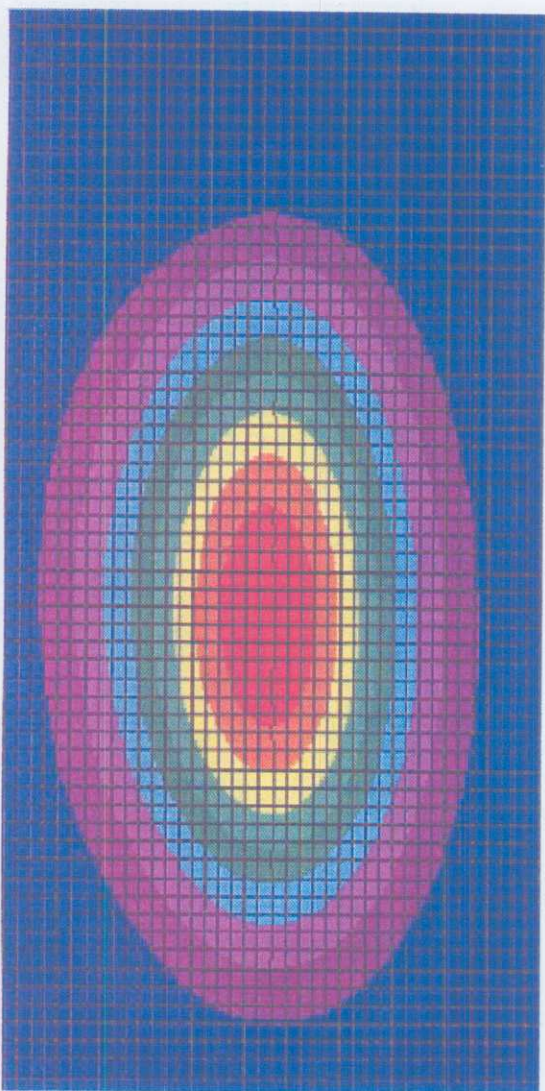

**NCL Calibration Laboratories**

Division of APREL Laboratories.

---

**Test Equipment**

The test equipment used during Probe Calibration, manufacturer, model number and, current calibration status are listed and located on the main APREL server R:\NCL\Calibration Equipment\Instrument List

