



FCC TEST REPORT

for

47 CFR Part 22H, 24E

Equipment : Notebook PC
Trade Name : GETAC; MTC; GTK
Model No. : P470
FCC ID : MAU470
Uplink Frequency Range : CDMA2000 Cellular 850 : 824~849 MHz
CDMA2000 PCS 1900 : 1850~1910 MHz
Downlink Frequency Range : CDMA2000 Cellular 850 : 869~894 MHz
CDMA2000 PCS 1900 : 1930~1990 MHz
Max. ERP/EIRP Power : CDMA2000 Cellular 850 : 0.03 W
CDMA2000 PCS 1900 : 0.18 W
Emission Designator : 1M25F9W
Applicant : **MiTAC Technology Corp.**
9th, FL., No. 75, Ming Sheng E. Rd., Sec. 3, Taipei, Taiwan

- The test result refers exclusively to the test presented test model / sample.
- Without written approval of SPORTON International Inc., the test report shall not be reproduced except in full.
- **Certificate or Test Report must not be used by the applicant to claim the product in this test report endorsement by NVLAP or any agency of U.S. government.**
- The data shown in this test report were carried out on Jul. 05, 2007 at **Sporton International Inc. LAB.**
- Report No.: FG731320, Report Version: Rev. 03.

Roy Wu
Deputy Manager

SPORTON International Inc.

6F, No.106, Sec. 1, Hsin Tai Wu Rd., Hsi Chih, Taipei Hsien, Taiwan, R.O.C.



Table of Contents

History of this test report.....ii

1. General Information 1

 1.1. Applicant1

 1.2. Manufacturer1

 1.3. Basic Description of Equipment under Test.....1

 1.4. Feature of Equipment under Test2

 1.5. Report Date.....2

2 Test Configuration of Equipment under Test3

 2.1 Test Manner3

 2.2 Test Mode3

 2.3 Connection Diagram of Test System3

 2.4 Ancillary Equipment List.....3

3. General Information of Test Site4

 3.1 Test Voltage4

 3.2 Test in Compliance with4

 3.3 Frequency Range Investigated4

 3.4 Test Distance4

4. Test Data and Test Result.....5

 4.1 List of Measurements and Examinations5

 4.2 RF Output Power6

 4.3 ERP / EIRP Measurement8

 4.4 Occupied Bandwidth and Band Edge Measurement12

 4.5 Conducted Emission40

 4.6 Field Strength of Spurious Radiation50

 4.7 Frequency Stability (Temperature Variation)93

 4.8 Frequency Stability (Voltage Variation).....95

5 List of Measurement Equipments96

6 Uncertainty Evaluation.....97

Appendix A – External Photographs

Appendix B – Internal Photographs

Appendix C - Setup Photographs



1. General Information

1.1. Applicant

MiTAC Technology Corp.

9th, FL., No. 75, Ming Sheng E. Rd., Sec. 3, Taipei, Taiwan

1.2 Manufacturer

GeTAC Technology (Kunshan) LTD.

No. 269, 2nd Road, Export Processing Zone, Changjiang South Road, Kunshan, Jiangsu, P.R.C.

1.3 Basic Description of Equipment under Test

Equipment : Notebook PC
Model No. : P470
FCC ID : MAU470
Power Supply Type : Switching
AC Power Cord : AC 120V, Wall-mount, 1.8 meter, 3 pin
DC Power Cable : DC 19V, 1.8 meter, 3 pin

**1.4 Feature of Equipment under Test**

DUT Type :	Notebook PC
Model Name :	P470
FCC ID :	MAU470
Tx Frequency :	CDMA2000 Cellular 850 : 824 ~ 849 MHz CDMA2000 PCS 1900 : 1850 ~1910 MHz
Rx Frequency :	CDMA2000 Cellular 850 : 869 ~ 894 MHz CDMA2000 PCS1900 : 1930 ~ 1990 MHz
Maximum Output Power to Antenna :	CDMA2000 Cellular 850 : 25.10 dBm for 1xRTT 24.86 dBm for 1xEV-DO CDMA2000 PCS1900 : 23.54 dBm for 1xRTT 23.31 dBm for 1xEV-DO
Maximum ERP/EIRP :	CDMA2000 Cellular 850 : 0.03 W (14.55 dBm) for 1xRTT 0.03 W (15.26 dBm) for 1xEV-DO CDMA2000 PCS1900 : 0.18 W (22.54 dBm) for 1xRTT 0.18 W (22.45 dBm) for 1xEV-DO
Antenna Type :	Fixed Internal
Power Rating (DC/AC, Voltage and Current of RF element or PA) :	DC 3.3V
Digital Modulation Emission :	QPSK
Type of Emission :	1M25F9W
Device Power Class :	CDMA2000 Cellular 850 : 3 CDMA2000 PCS1900 : 2
DUT Stage :	Identical Prototype

1.5 Report Date

EUT Received : Apr. 26, 2007

Report Date : Jul. 05, 2007

2 Test Configuration of Equipment under Test

2.1 Test Manner

- a. The spurious emission measurements were carried out in semi-anechoic chamber with 3-meter test range.
- b. During all testings, EUT is in link mode with base station emulator at maximum power level.
- c. Frequency range investigated: radiated emission 30 MHz to 9000 MHz for CDMA2000 Cellular 850; 30MHz to 19000 MHz for CDMA2000 PCS 1900.

2.2 Test Mode

Application	CDMA2000 Cellular 850	CDMA2000 PCS 1900
Radiated Emission	<input checked="" type="checkbox"/> Mode 1: 1xRTT Link Mode <input checked="" type="checkbox"/> Mode 2: 1xEV-DO Link Mode <input checked="" type="checkbox"/> Mode 5: 1xEV-DO Link Mode + BT Link <input checked="" type="checkbox"/> Mode 6: 1xEV-DO Link Mode + WLAN Link	<input checked="" type="checkbox"/> Mode 3: 1xRTT Link Mode_CH600 <input checked="" type="checkbox"/> Mode 4: 1xEV-DO Link Mode_CH600
Conducted Measurement	<input checked="" type="checkbox"/> Mode 1: 1xRTT Link Mode <input checked="" type="checkbox"/> Mode 2: 1xEV-DO Link Mode	<input checked="" type="checkbox"/> Mode 3: 1xRTT Link Mode <input checked="" type="checkbox"/> Mode 4: 1xEV-DO Link Mode

2.3 Connection Diagram of Test System

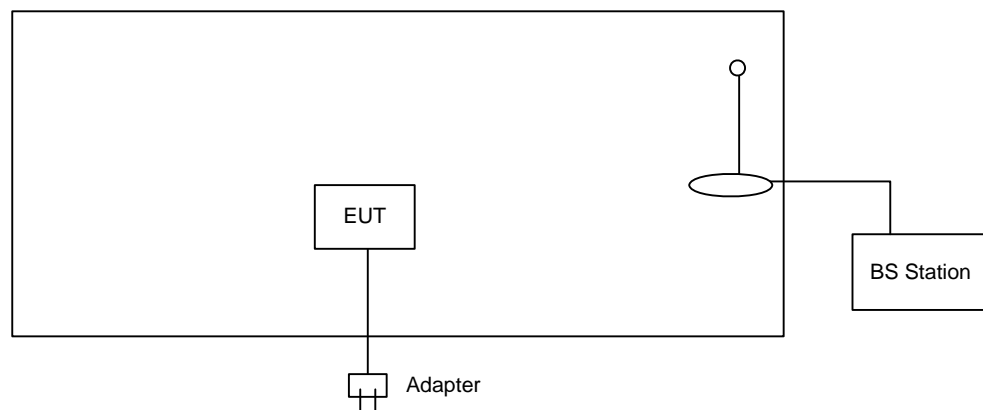

2.4 Ancillary Equipment List

Item	Equipment	Model No.	Serial No.
1.	Base Station(Agilent)	8960	GB463111322



3. General Information of Test Site

Test Site Location : No. 52, Hwa Ya 1st Rd., Hwa Ya Technology Park,
Kwei-Shan Hsiang, Tao Yuan Hsien, Taiwan, R.O.C.
TEL : 886-3-327-3456
FAX : 886-3-318-0055

Test Site No : 03CH06-HY

The chamber meets the characteristics of ANSI C63.4-2003. This site is on file with the FCC. The Industry Canada file number for this site is IC 4088.

3.1 Test Voltage

120V/ 60Hz

3.2 Test in Compliance with

47 CFR Part 22H, 24E, Part 2

3.3 Frequency Range Investigated

- a. Radiation: from 30MHz to 9000MHz for CDMA2000 Cellular 850.
- b. Radiation: from 30 MHz to 19000 MHz for CDMA2000 PCS 1900.

3.4 Test Distance

The test distance of radiated emission from antenna to EUT is 3 m.



4. Test Data and Test Result

4.1 List of Measurements and Examinations

FCC Rule	DESCRIPTION OF TEST	Result	Section
§2.1046	RF Output Power	Passed	4.2
§ 22.913 §24.232	ERP / EIRP	Passed	4.3
§2.1049, § 22.917, § 24.238(b)	Occupied Bandwidth & Band Edge Measurement	Passed	4.4
§2.1051	Conducted Emission	Passed	4.5
§2.1053	Field Strength of Spurious Radiation	Passed	4.6
§2.1055, § 22.355, §24.235	Frequency Stability vs. Temperature	Passed	4.7
§2.1055, §22.355, §24.235	Frequency Stability vs. Voltage	Passed	4.8

4.2 RF Output Power

4.2.1 Measurement Instruments :

As described in chapter 5 of this test report.

4.2.2 Test Procedure :

1. The transmitter output was connected to power meter and base station through power divider.
2. Set EUT maximum power through base station.
3. Select lowest, middle, and highest channels for each band.

4.2.3 Test Setup Layout :

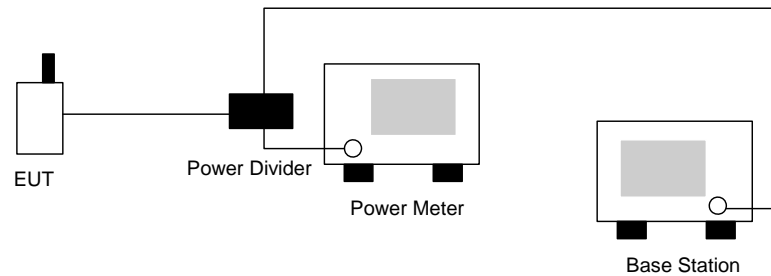



4.2.4 Test Result :

Bands	Test Mode	Test Status	Channel	Frequency (MHz)	Conducted Power (dBm)	Conducted Power (Watts)	
CDMA2000 Cellular 850	CDMA 1xRTT	FCH_RC1	1013	824.70 (Low)	24.96	0.31	
			384	836.52 (Mid)	24.68	0.29	
			777	848.31 (High)	24.72	0.30	
		FCH_RC3	1013	824.70 (Low)	25.10	0.32	
			384	836.52 (Mid)	24.80	0.30	
			777	848.31 (High)	24.72	0.30	
		FCH+SCH_RC3	1013	824.70 (Low)	25.04	0.32	
			384	836.52 (Mid)	24.84	0.30	
			777	848.31 (High)	24.70	0.30	
	CDMA 1xEV-DO	EVDO-UL: 9.6Kbps	1013	824.70 (Low)	24.73	0.30	
			384	836.52 (Mid)	24.53	0.28	
			777	848.31 (High)	24.24	0.27	
		EVDO-UL: 38.4Kbps	1013	824.70 (Low)	24.86	0.31	
			384	836.52 (Mid)	24.35	0.27	
			777	848.31 (High)	24.44	0.28	
		EVDO-UL: 153.6Kbps	1013	824.70 (Low)	24.76	0.30	
			384	836.52 (Mid)	24.58	0.29	
			777	848.31 (High)	24.28	0.27	
	CDMA2000 PCS 1900	CDMA 1xRTT	FCH_RC1	25	1851.25 (Low)	23.23	0.21
				600	1880.00 (Mid)	22.82	0.19
				1177	1908.75 (High)	23.22	0.21
FCH_RC3			25	1851.25 (Low)	23.39	0.22	
			600	1880.00 (Mid)	22.96	0.20	
			1177	1908.75 (High)	23.54	0.23	
FCH+SCH_RC1			25	1851.25 (Low)	23.42	0.22	
			600	1880.00 (Mid)	22.95	0.20	
			1177	1908.75 (High)	23.37	0.22	
CDMA 1xEV-DO		EVDO-UL: 9.6Kbps	25	1851.25 (Low)	23.20	0.21	
			600	1880.00 (Mid)	22.97	0.20	
			1177	1908.75 (High)	23.14	0.21	
		EVDO-UL: 38.4Kbps	25	1851.25 (Low)	23.31	0.21	
			600	1880.00 (Mid)	22.97	0.20	
			1177	1908.75 (High)	23.00	0.20	
		EVDO-UL: 153.6Kbps	25	1851.25 (Low)	23.19	0.21	
			600	1880.00 (Mid)	22.97	0.20	
			1177	1908.75 (High)	23.18	0.21	



4.3 ERP / EIRP Measurement

Equivalent isotropic radiated power measurements by substitution method according to ANSI/TIA/EIA-603-C.

4.3.1 Measurement Instruments

As described in chapter 5 of this test report.

4.3.2 Test Procedure

1. The EUT was placed on a rotatable table with 1.0 meter height in an fully anechoic chamber.
2. The EUT was set 1.2 meters from the receiving antenna which was mounted on the antenna tower.
3. The table was rotated 360 degrees to determine the position of the highest radiated power.
4. The height of the receiving antenna is also kept at 1.0M height.
5. Taking the record of maximum ERP/EIRP.
6. A dipole antenna was substituted in place of the EUT and was driven by a signal generator.
7. The conducted power at the terminal of the dipole antenna is measured.
8. Repeat step 3 to step 5 to get the maximum ERP/EIRP of the substitution antenna.
9. $ERP/EIRP = P_s + E_t - E_s + G_s = P_s + R_t - R_s + G_s$

P_s (dBm) : Input power to substitution antenna.

G_s (dBi or dBd) : Substitution antenna Gain.

$E_t = R_t + AF$

$E_s = R_s + AF$

AF (dB/m) : Receive antenna factor

R_t : The highest received signal in Spectrum Analyzer for EUT.

R_s : The highest received signal in spectrum analyzer for substitution antenna.

4.3.3 Test Setup Layout of ERP/EIRP

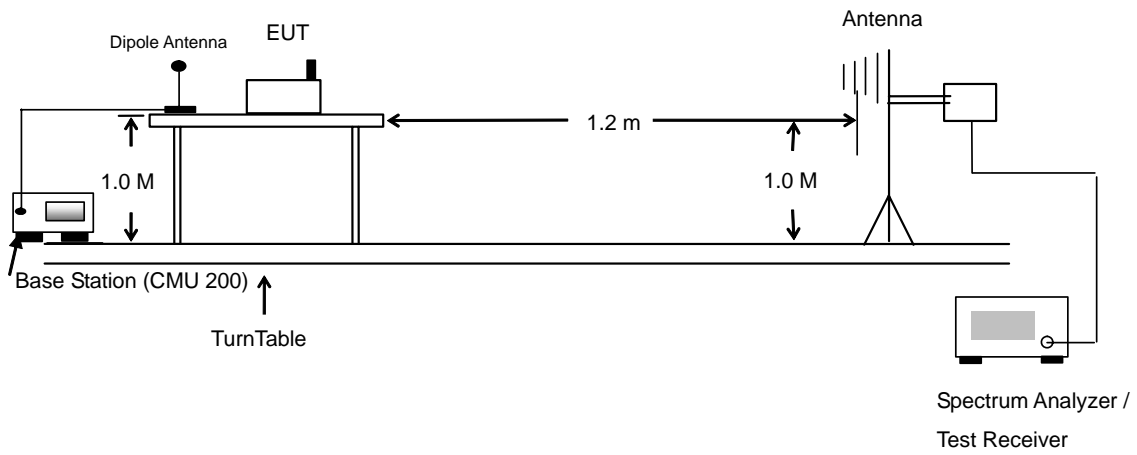



4.3.4 Test Result

CDMA2000 Cellular 850 1xRTT FCH_RC3 Radiated Power ERP						
Horizontal Polarization						
Frequency (MHz)	Rt (dBm)	Rs (dBm)	Ps (dBm)	Gs (dBd)	ERP (dBm)	ERP (W)
824.70	-33.64	-48.12	0.00	-1.08	13.40	0.02
836.52	-33.54	-48.28	0.00	-0.93	13.81	0.02
848.31	-33.04	-48.35	0.00	-0.76	14.55	0.03
Vertical Polarization						
Frequency (MHz)	Rt (dBm)	Rs (dBm)	Ps (dBm)	Gs (dBd)	ERP (dBm)	ERP (W)
824.70	-34.94	-47.97	0.00	-1.08	11.95	0.02
836.52	-34.66	-48.01	0.00	-0.93	12.42	0.02
848.31	-33.52	-48.05	0.00	-0.76	13.77	0.02

CDMA2000 Cellular 850 1xEV-DO 38.4Kbps Radiated Power ERP						
Horizontal Polarization						
Frequency (MHz)	Rt (dBm)	Rs (dBm)	Ps (dBm)	Gs (dBd)	ERP (dBm)	ERP (W)
824.70	-33.46	-48.12	0.00	-1.08	13.58	0.02
836.52	-33.21	-48.28	0.00	-0.93	14.14	0.03
848.31	-32.33	-48.35	0.00	-0.76	15.26	0.03
Vertical Polarization						
Frequency (MHz)	Rt (dBm)	Rs (dBm)	Ps (dBm)	Gs (dBd)	ERP (dBm)	ERP (W)
824.70	-35.21	-47.97	0.00	-1.08	11.68	0.01
836.52	-34.78	-48.01	0.00	-0.93	12.30	0.02
848.31	-33.56	-48.05	0.00	-0.76	13.73	0.02



CDMA2000 PCS1900 1xRTT FCH_RC3 Radiated Power EIRP

Horizontal Polarization						
Frequency (MHz)	Rt (dBm)	Rs (dBm)	Ps (dBm)	Gs (dBi)	EIRP (dBm)	EIRP (W)
1851.25	-31.47	-51.88	0.00	1.96	22.37	0.17
1880.00	-32.84	-52.99	0.00	2.00	22.15	0.16
1908.75	-35.55	-54.28	0.00	1.98	20.71	0.12
Vertical Polarization						
Frequency (MHz)	Rt (dBm)	Rs (dBm)	Ps (dBm)	Gs (dBi)	EIRP (dBm)	EIRP (W)
1851.25	-31.55	-52.13	0.00	1.96	22.54	0.18
1880.00	-32.65	-53.17	0.00	2.00	22.52	0.18
1908.75	-34.21	-54.13	0.00	1.98	21.90	0.15

CDMA2000 PCS1900 1xEV-DO 38.4Kbps Radiated Power EIRP

Horizontal Polarization						
Frequency (MHz)	Rt (dBm)	Rs (dBm)	Ps (dBm)	Gs (dBi)	EIRP (dBm)	EIRP (W)
1851.25	-31.63	-51.88	0.00	1.96	22.21	0.17
1880.00	-32.78	-52.99	0.00	2.00	22.21	0.17
1908.75	-35.60	-54.28	0.00	1.98	20.66	0.12
Vertical Polarization						
Frequency (MHz)	Rt (dBm)	Rs (dBm)	Ps (dBm)	Gs (dBi)	EIRP (dBm)	EIRP (W)
1851.25	-31.91	-52.13	0.00	1.96	22.18	0.17
1880.00	-32.72	-53.17	0.00	2.00	22.45	0.18
1908.75	-34.33	-54.13	0.00	1.98	21.78	0.15

4.4 Occupied Bandwidth and Band Edge Measurement

4.4.1 Measurement Instruments

As described in chapter 5 of this test report.

4.4.2 Test Procedure

1. The EUT was connected to Spectrum Analyzer and Base Station via power divider.
2. The 99% occupied bandwidth of middle channel for the highest and lowest RF powers were measured.
3. The bandedge of low and high channels for the highest RF powers within the transmitting frequency band were measured. Setting RBW as roughly BW/100.
4. The RBW was replaced 30KHz with 10KHz, due to the spectrum analyzer IF-Filter leading to an exceeding of the limit, a worst case correction factor of $10 \log (1\% \text{ Occupy Bandwidth} / \text{Measured RBW})$ was used.

4.4.3 Test Setup Layout

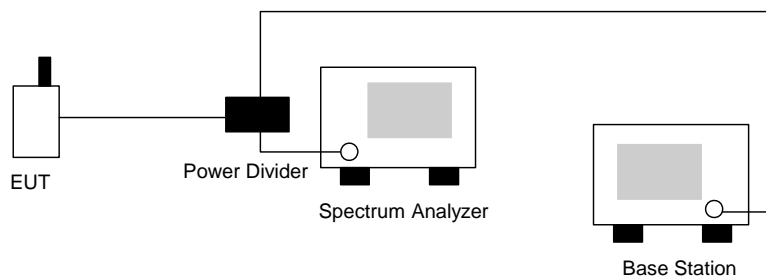



4.4.4 Test Data

Band	Condition		Channel	Measurement Value (dBm)	Correction Factor (dB)	Band Edge (dBm)
CDMA2000 Cellular 850	1xRTT	FCH_RC1	1013	-19.75	1.03	-18.72
			777	-16.73	1.03	-15.70
		FCH_RC3	1013	-20.19	1.03	-19.16
			777	-16.28	1.03	-15.25
		FCH+SCH_RC3	1013	-20.4	1.03	-19.37
			777	-17.27	1.03	-16.24
	1xEV-DO	9.6 Kbps	1013	-22.26	1.03	-21.23
			777	-16.97	1.03	-15.94
		38.4 Kbps	1013	-19.41	1.03	-18.38
			777	-16.79	1.03	-15.76
		153.6 Kbps	1013	-22.06	1.03	-21.03
			777	-16.85	1.03	-15.82
CDMA2000 PCS1900	1xRTT	FCH_RC1	25	-33.51	1.04 dB	-32.47
			1175	-33.42	1.04 dB	-32.38
		FCH_RC3	25	-37.43	1.04 dB	-36.39
			1175	-36.02	1.04 dB	-34.98
		FCH+SCH_RC3	25	-35.46	1.04 dB	-34.42
			1175	-37.88	1.04 dB	-36.84
	1xEV-DO	9.6 Kbps	25	-37.85	1.04 dB	-36.81
			1175	-34.07	1.04 dB	-33.03
		38.4 Kbps	25	-37.15	1.04 dB	-36.11
			1175	-33.72	1.04 dB	-32.68
		153.6 Kbps	25	-37.42	1.04 dB	-36.38
			1175	-33.36	1.04 dB	-32.32



4.4.5 Test Result

- Mode 1
- Test Mode : CDMA2000 Cellular 850 Band CH1013_FCH_RC1 Lower Band Edge for 1xRTT
- Power State : High

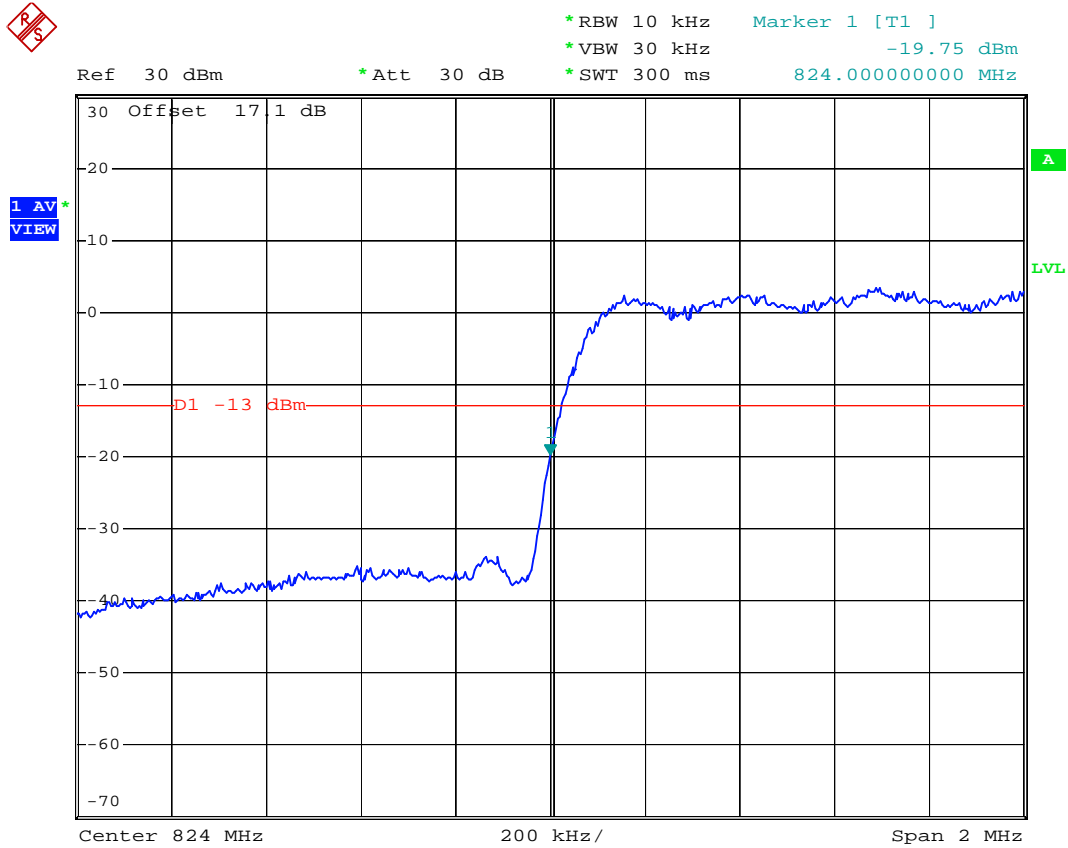

Date: 26.APR.2007 17:28:32



- Test Mode : CDMA2000 Cellular 850 CH777_FCH_RC1 Higher Band Edge for 1xRTT
- Power State : High

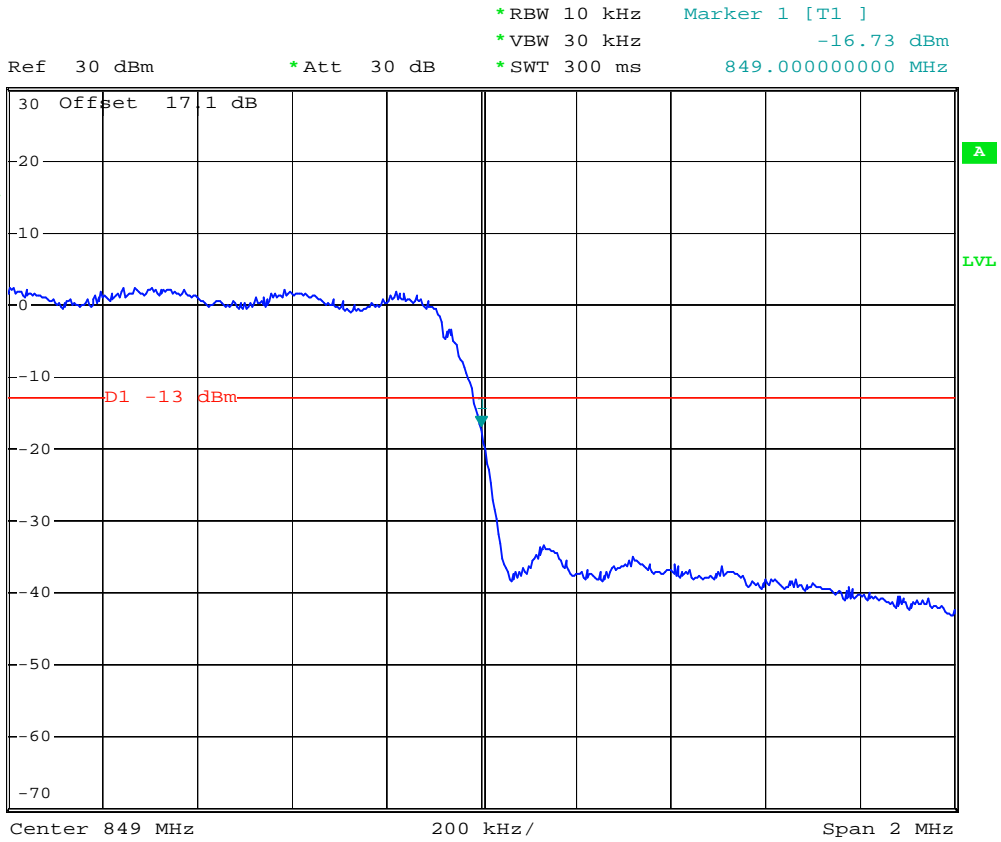

Date: 26.APR.2007 17:26:51



- Test Mode : CDMA2000 Cellular 850 Band CH1013_FCH_RC3 Lower Band Edge for 1xRTT
- Power State : High

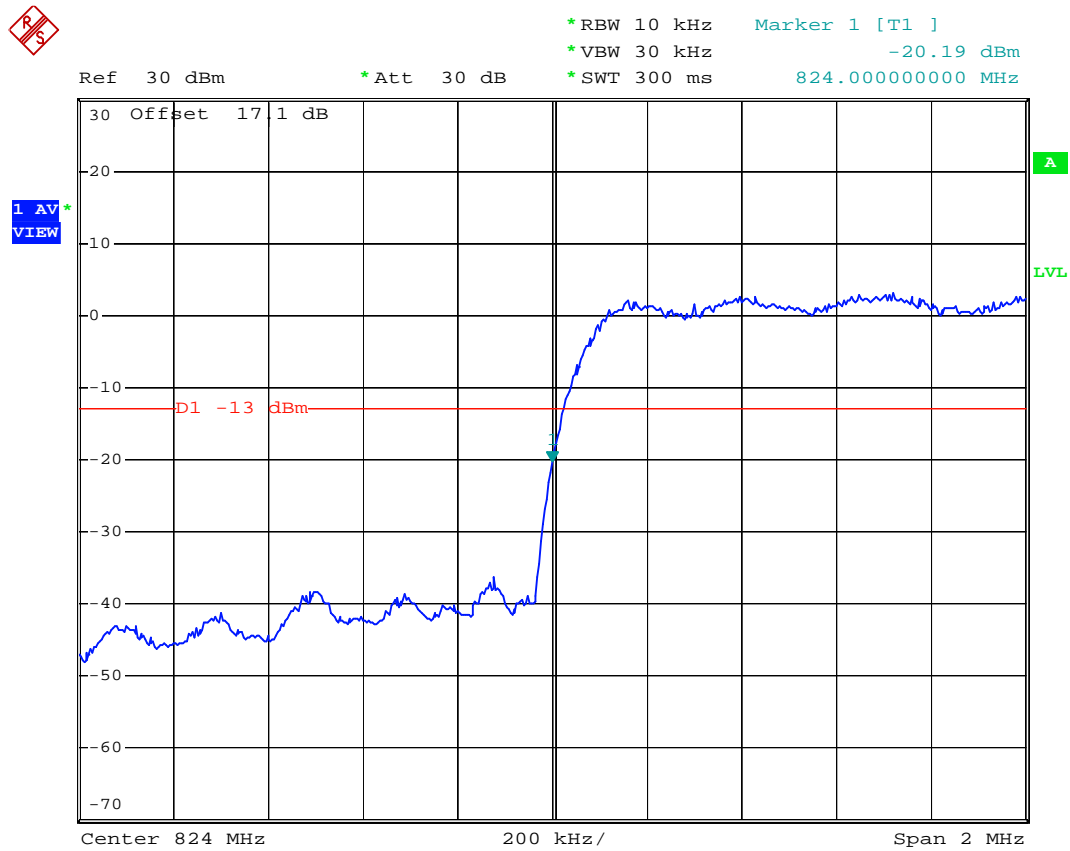

Date: 26.APR.2007 17:31:11



- Test Mode : CDMA2000 Cellular 850 CH384_FCH_RC3 99% Occupied Bandwidth for 1xRTT
- Power State : High

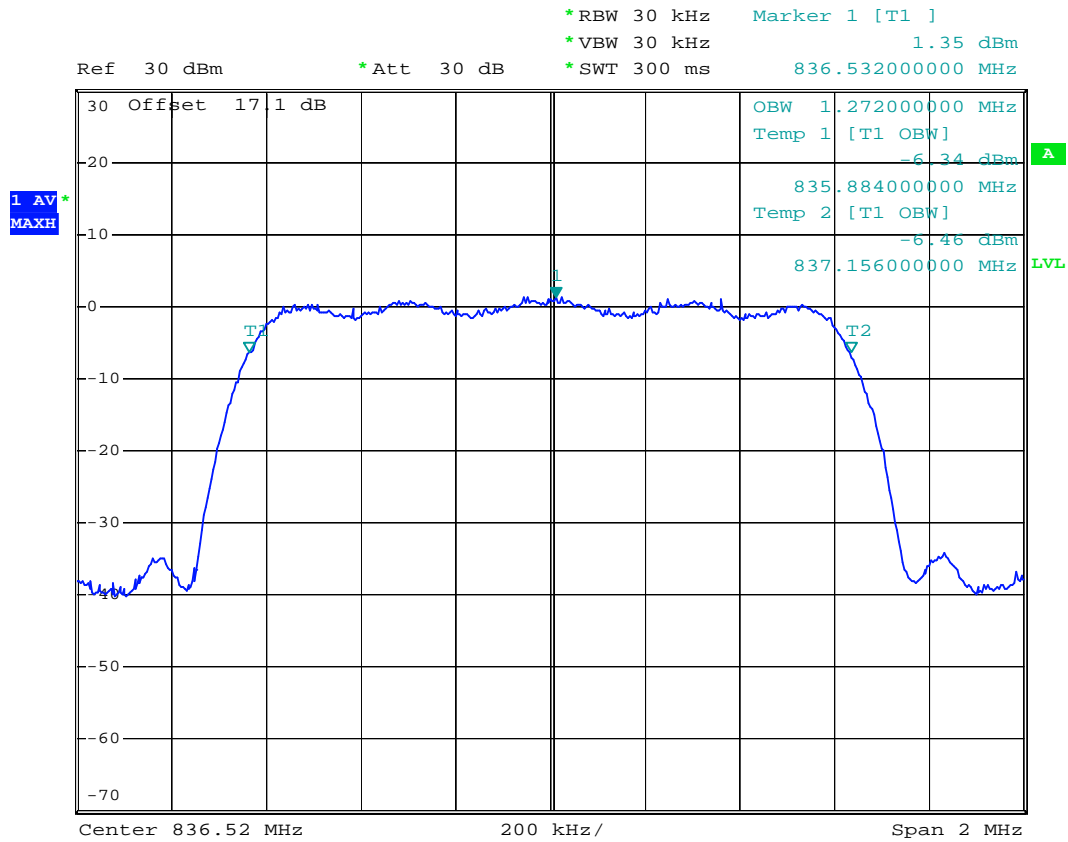

Date: 5.JUL.2007 09:58:45



- Test Mode : CDMA2000 Cellular 850 CH777_FCH_RC3 Higher Band Edge for 1xRTT
- Power State : High

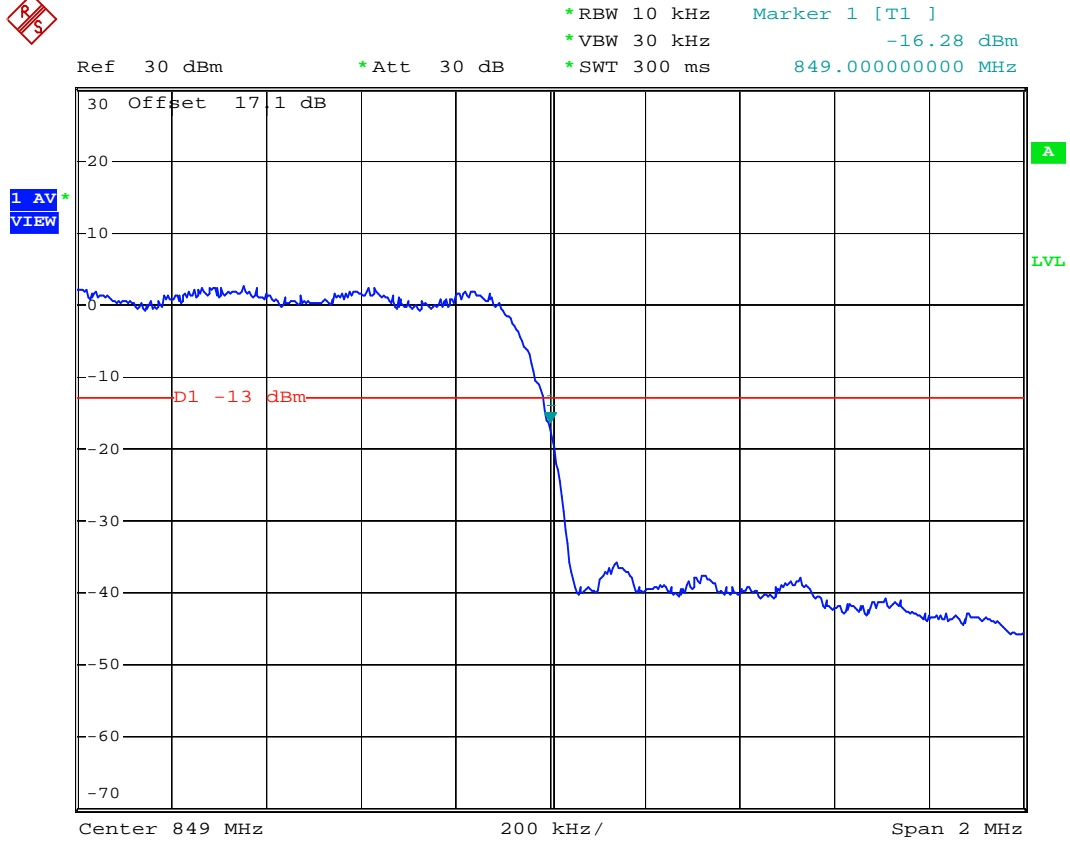

Date: 26.APR.2007 17:32:52



- Test Mode : CDMA2000 Cellular 850 Band CH1013_FCH+SCH_RC3 Lower Band Edge for 1xRTT
- Power State : High

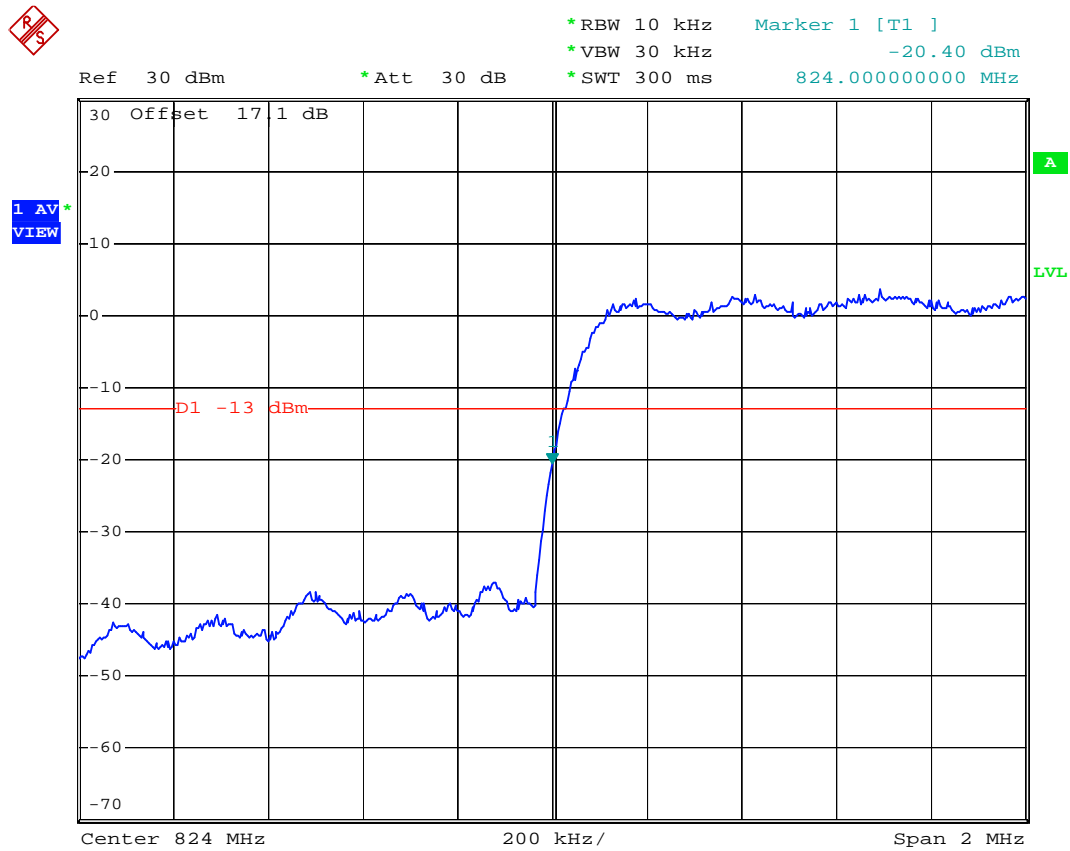

Date: 26.APR.2007 17:22:00



- Test Mode : CDMA2000 Cellular 850 CH777_FCH+SCH_RC3 Higher Band Edge for 1xRTT
- Power State : High

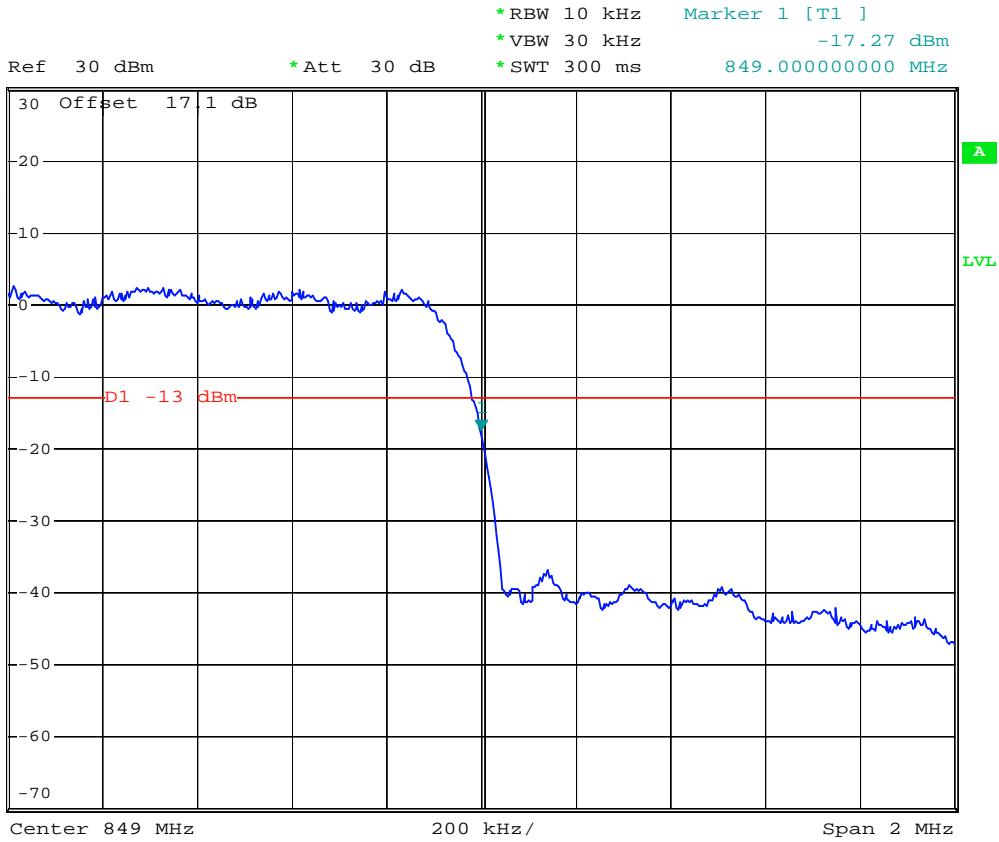

Date: 26.APR.2007 17:19:57



- Mode 2
- Test Mode : CDMA2000 Cellular 850 CH1013_9.6Kbps Lower Band Edge for 1xEV-DO
- Power State : High

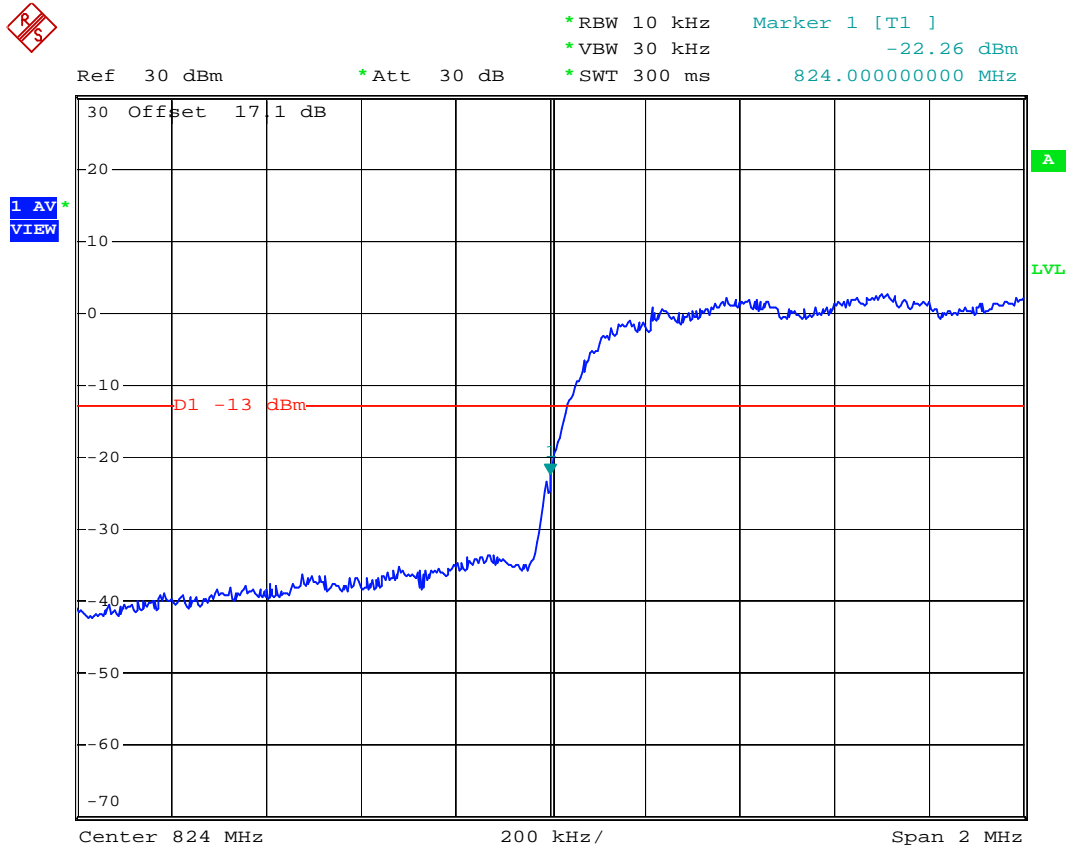

Date: 26.APR.2007 18:52:13



- Test Mode : CDMA2000 Cellular 850 CH777_9.6Kbps Higher Band Edge for 1xEV-DO
- Power State : High

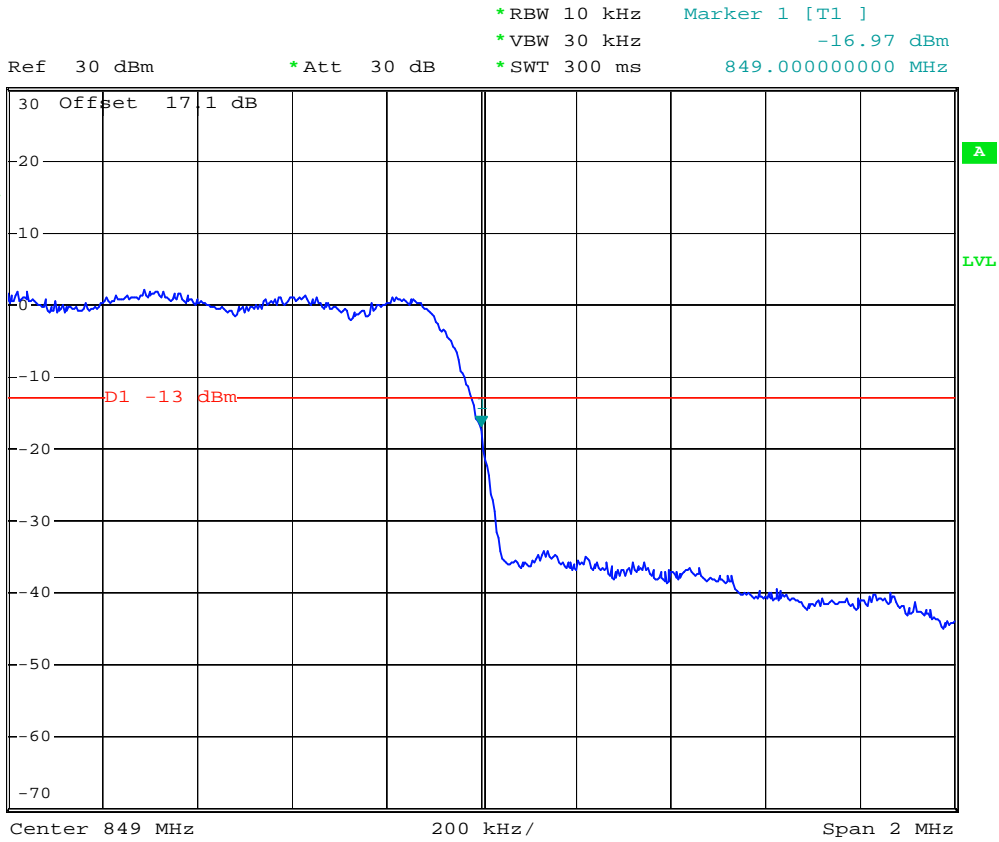

Date: 26.APR.2007 18:53:43



- Test Mode : CDMA2000 Cellular 850 CH1013_38.4Kbps Lower Band Edge for 1xEV-DO
- Power State : High

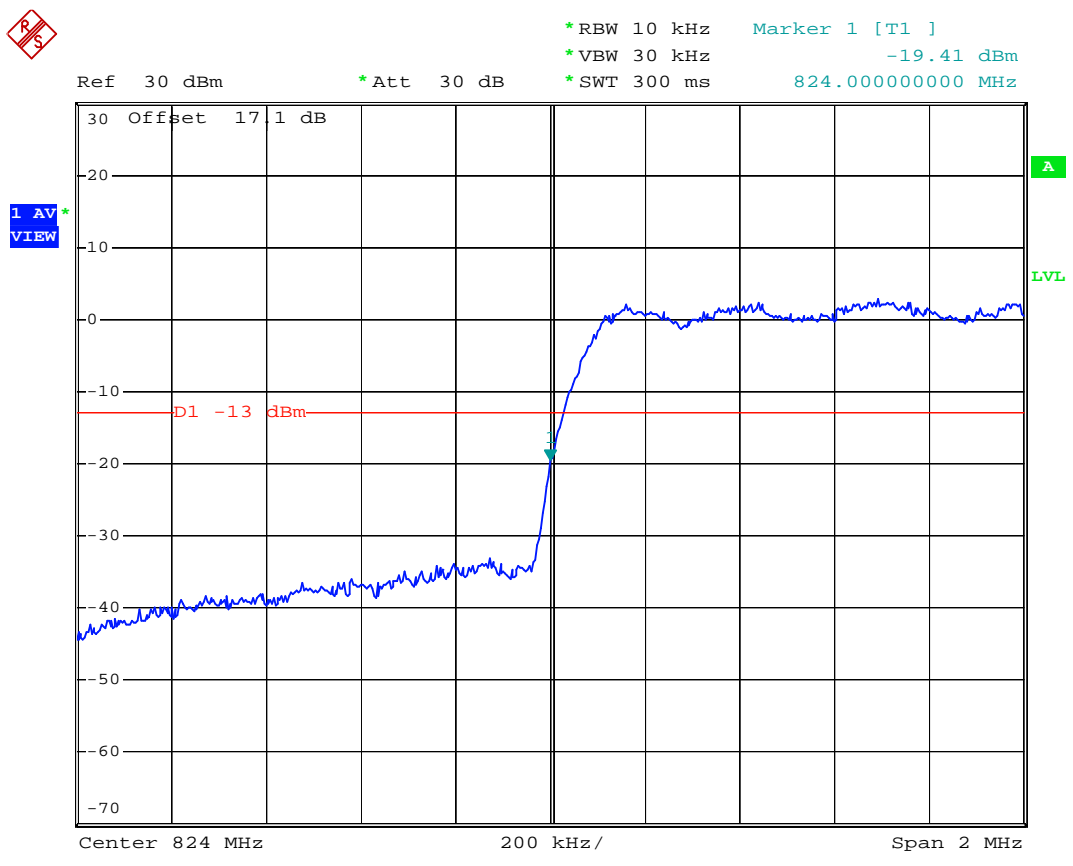

Date: 26.APR.2007 18:51:49



- Test Mode : CDMA2000 Cellular 850 CH777_38.4Kbps Higher Band Edge for 1xEV-DO
- Power State : High

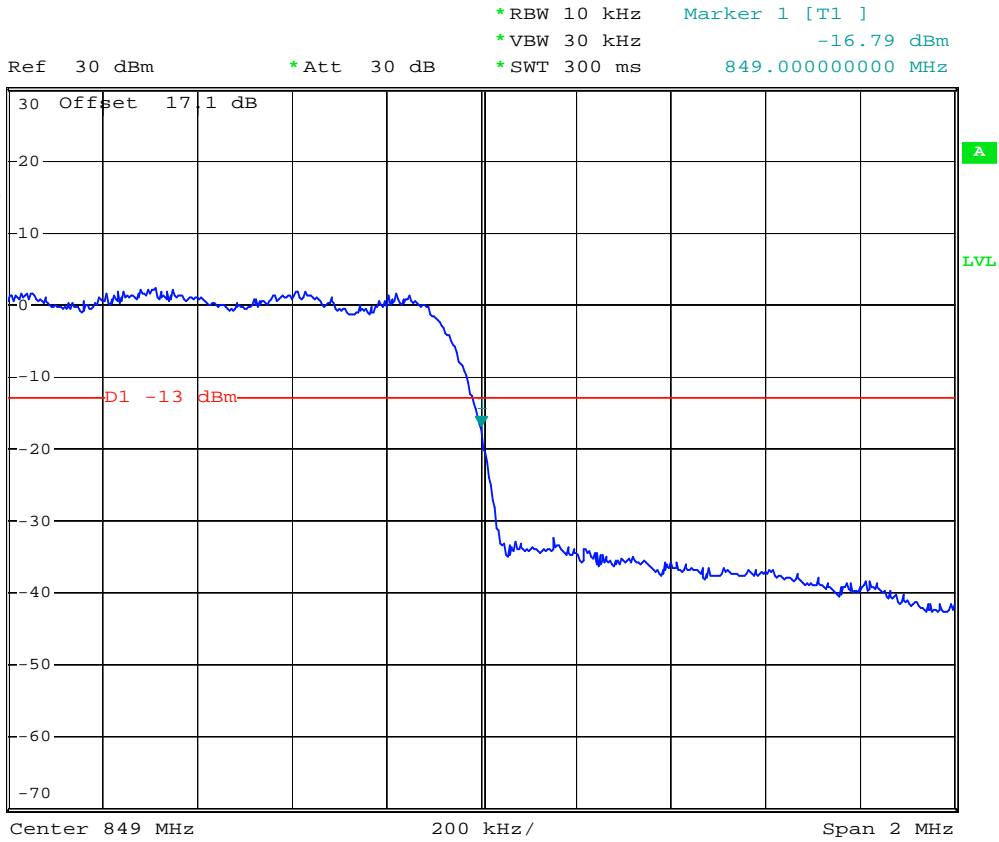

Date: 26.APR.2007 18:50:19



- Test Mode : CDMA2000 Cellular 850 CH1013_153.6Kbps Lower Band Edge for 1xEV-DO
- Power State : High

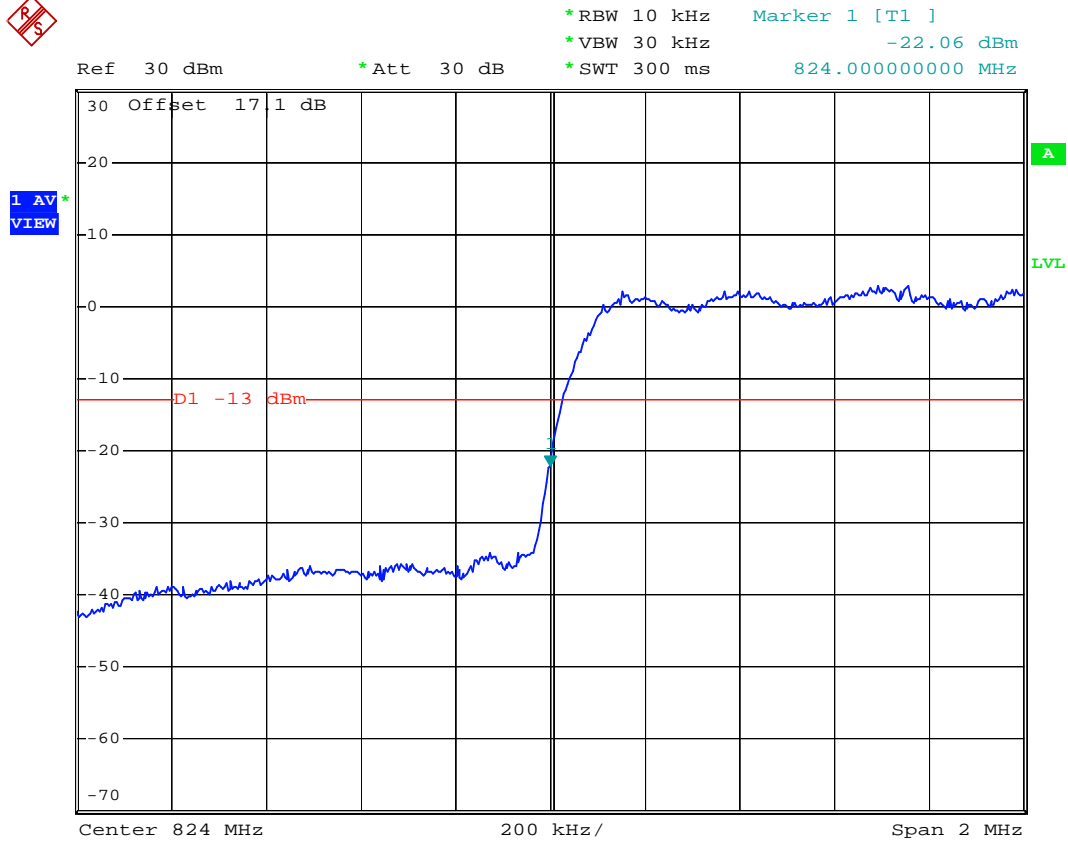

Date: 26.APR.2007 18:45:06



- Test Mode : CDMA2000 Cellular 850 CH777_153.6Kbps Higher Band Edge for 1xEV-DO
- Power State : High

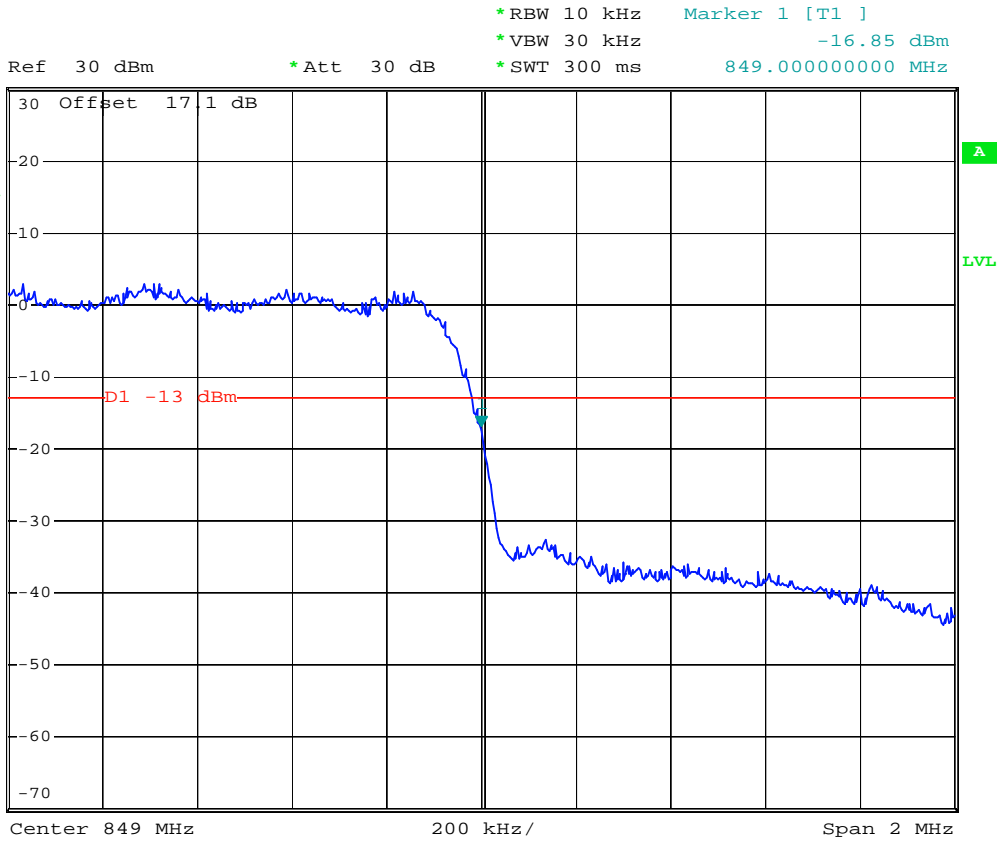

Date: 26.APR.2007 18:43:33



- Mode 3
- Test Mode : CDMA2000 PCS 1900 Band CH25_FCH_RC1 Lower Band Edge for 1xRTT
- Power State : High

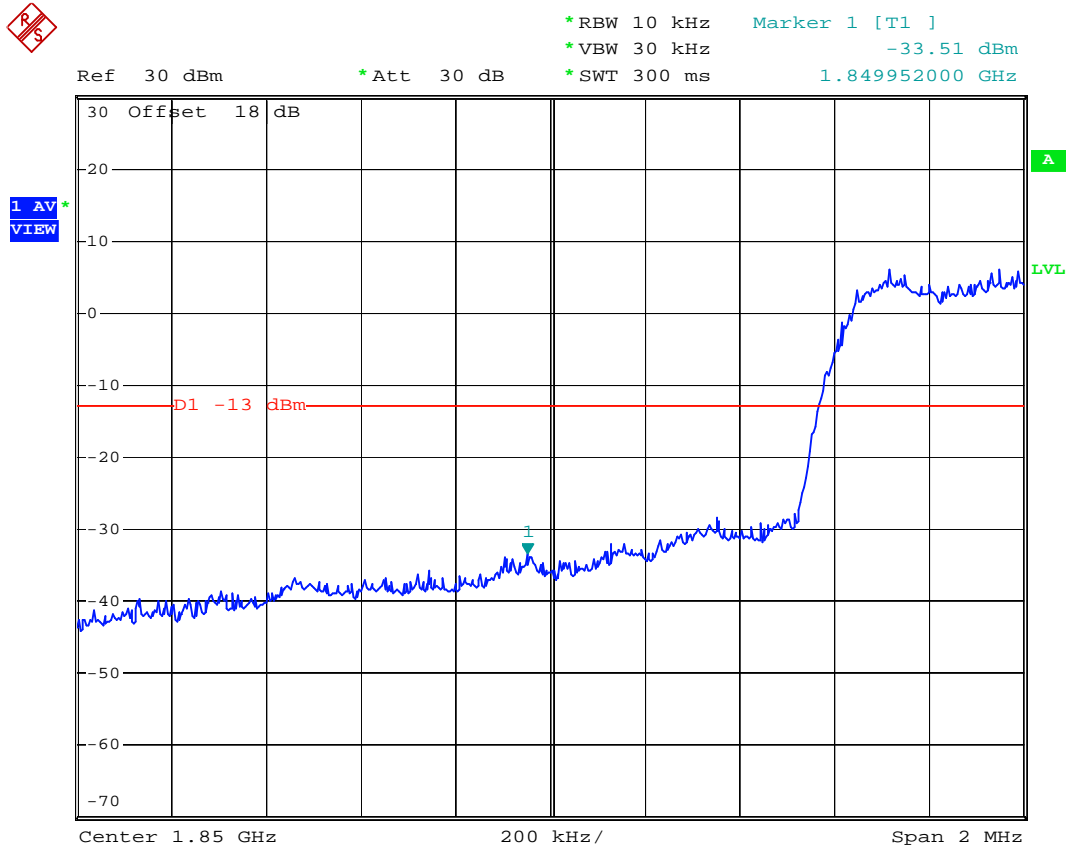

Date: 26.APR.2007 16:11:36



- Test Mode : CDMA2000 PCS 1900 CH1175_FCH_RC1 Higher Band Edge for 1xRTT
- Power State : High

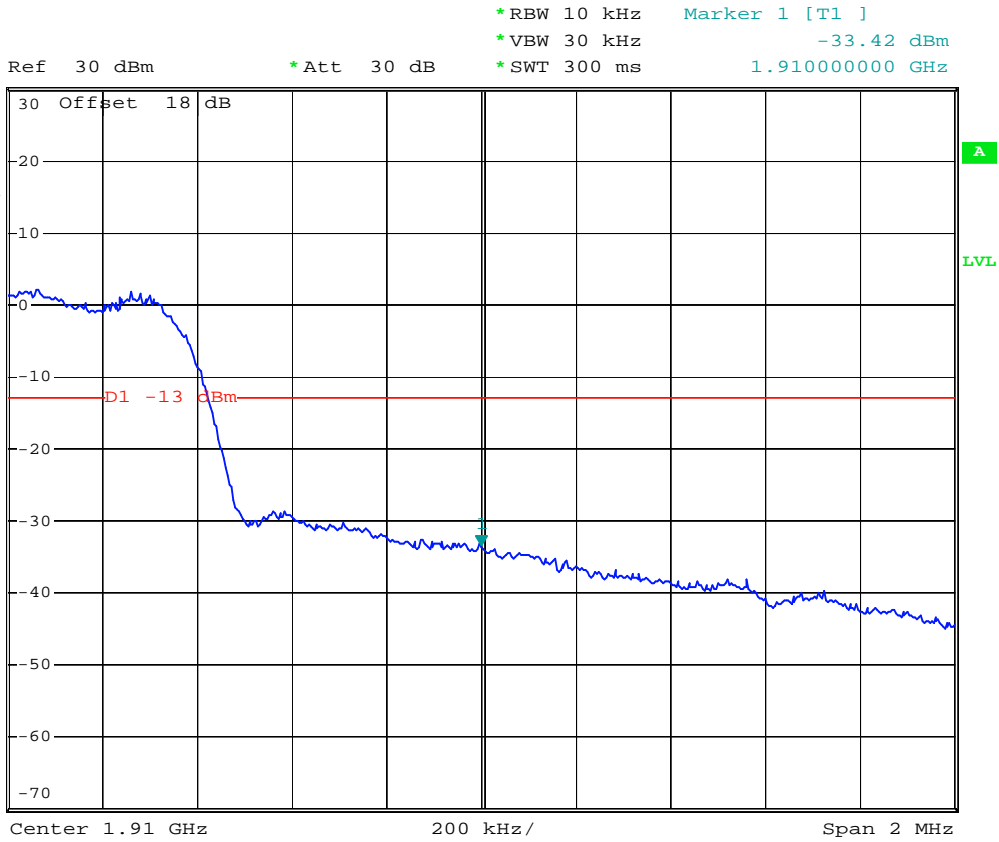

Date: 26.APR.2007 16:17:11



- Test Mode : CDMA2000 PCS 1900 Band CH25_FCH_RC3 Lower Band Edge for 1xRTT
- Power State : High

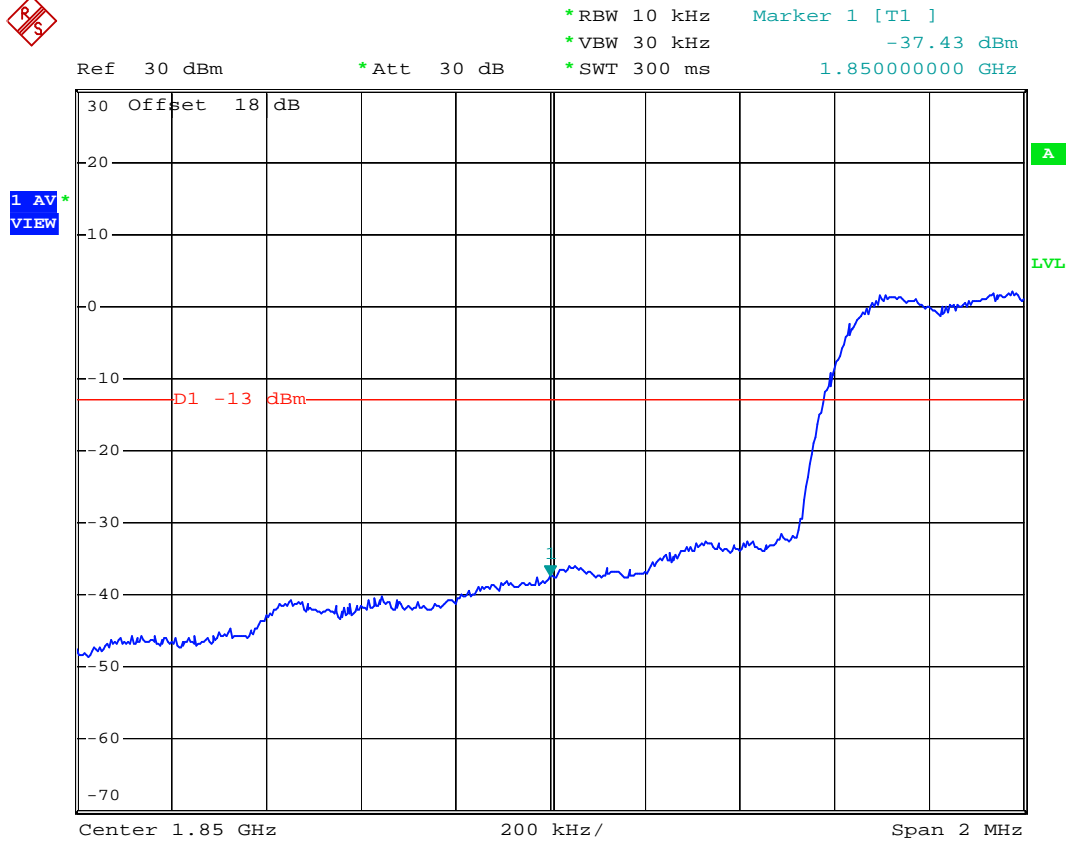

Date: 26.APR.2007 16:27:05



FCC TEST REPORT

Report No. : FG731320

- Test Mode : CDMA2000 PCS 1900 CH600_FCH_RC3 99% Occupid Bandwidth for 1xRTT
- Power State : High

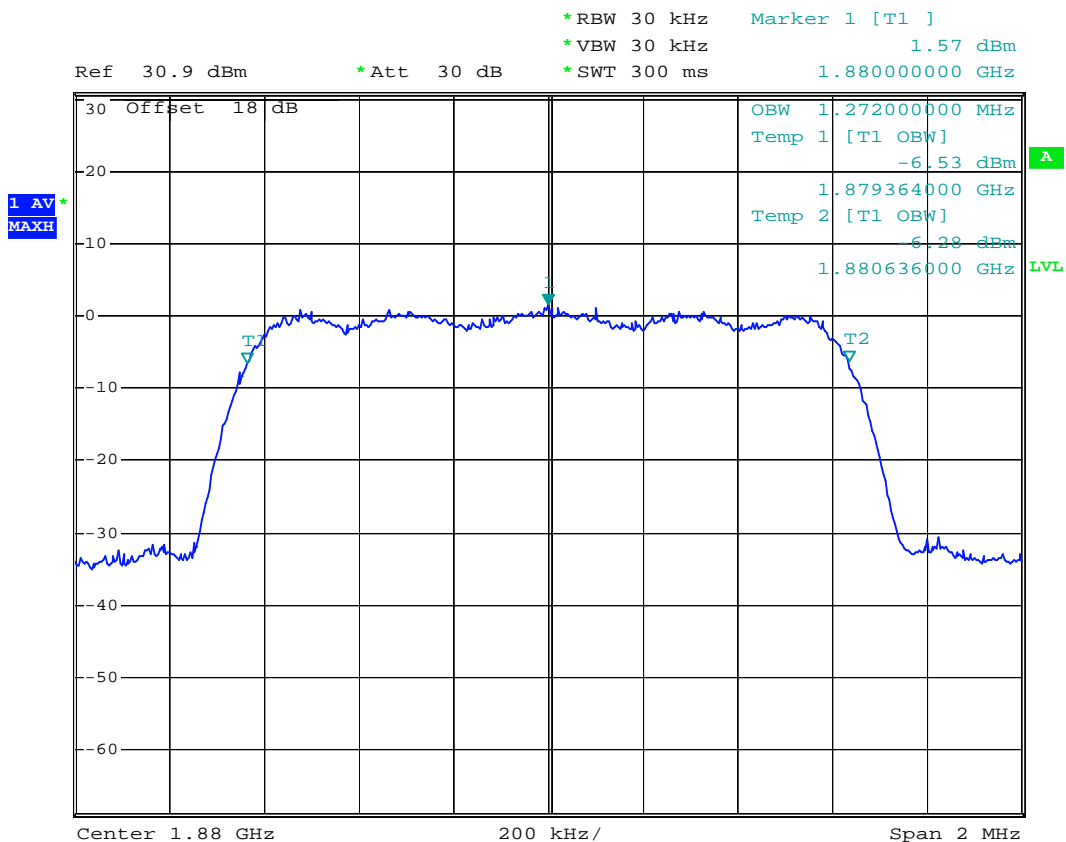

Date: 5.JUL.2007 09:59:48



- Test Mode : CDMA2000 Cellular 850 CH1175_FCH_RC3 Higher Band Edge for 1xRTT
- Power State : High

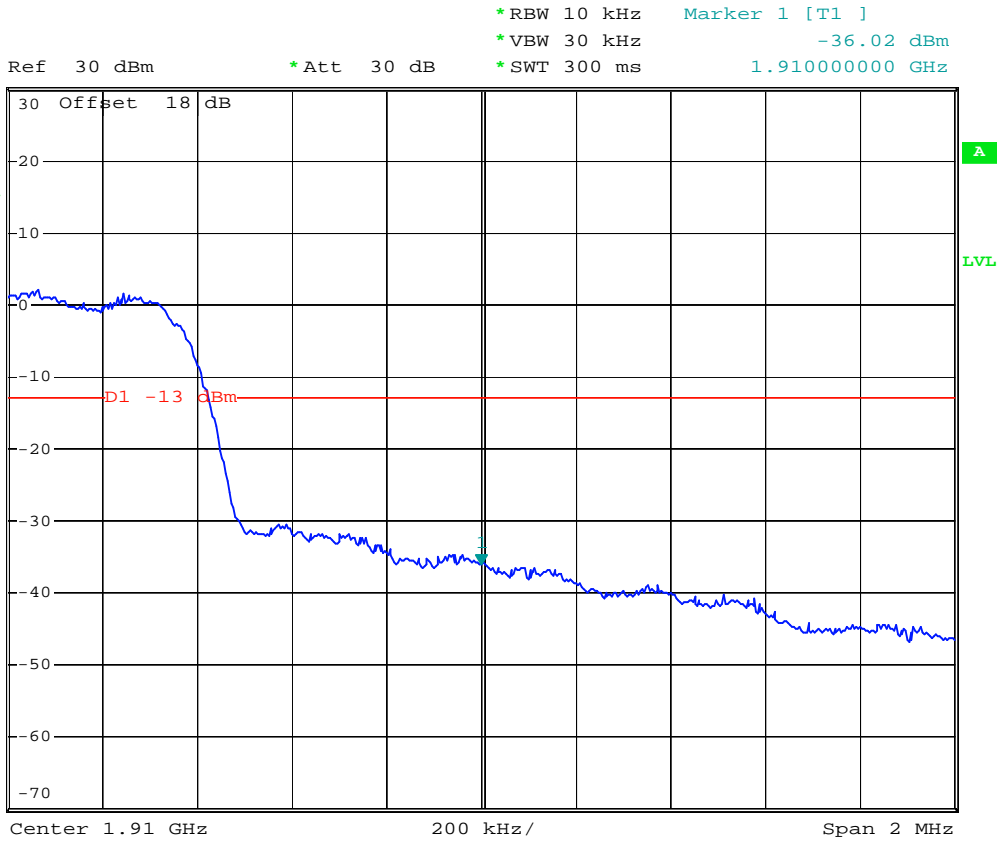

Date: 26.APR.2007 16:30:08



- Test Mode : CDMA2000 PCS 1900 Band CH25_FCH+SCH_RC3 Lower Band Edge for 1xRTT
- Power State : High

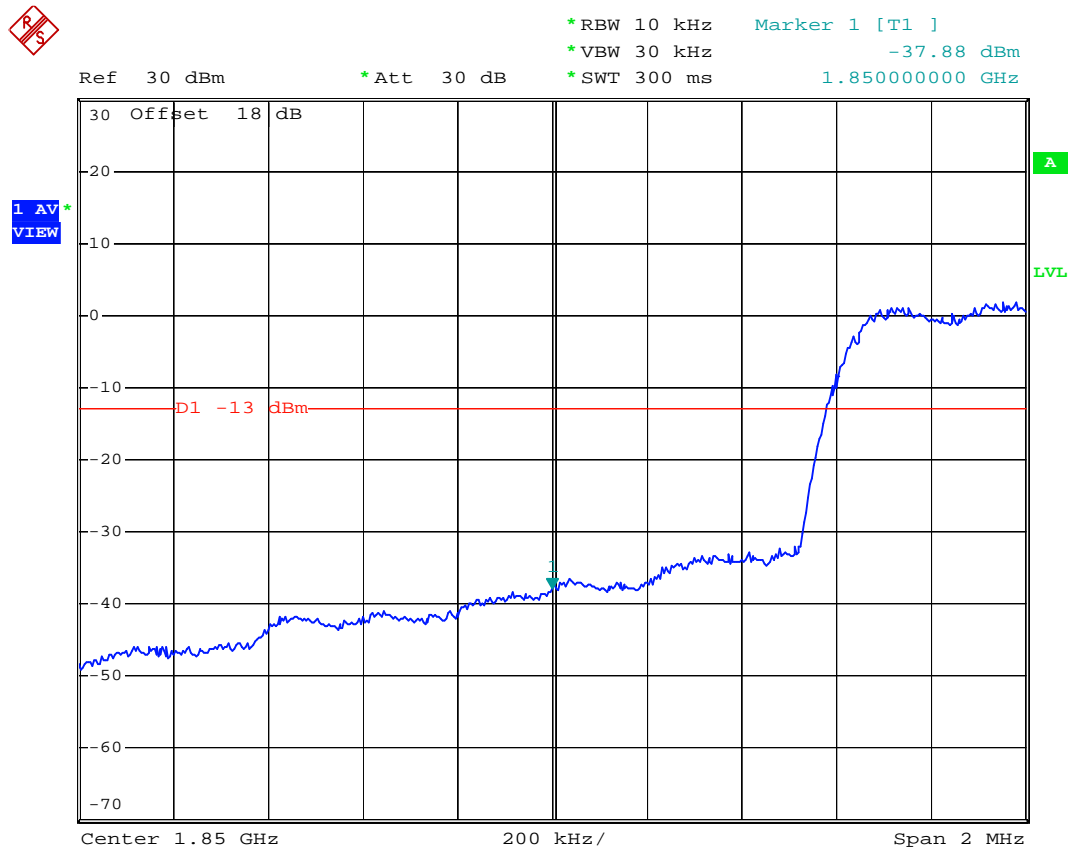

Date: 26.APR.2007 17:06:16



- Test Mode : CDMA2000 PCS 1900 CH1175_FCH+SCH_RC3 Higher Band Edge for 1xRTT
- Power State : High

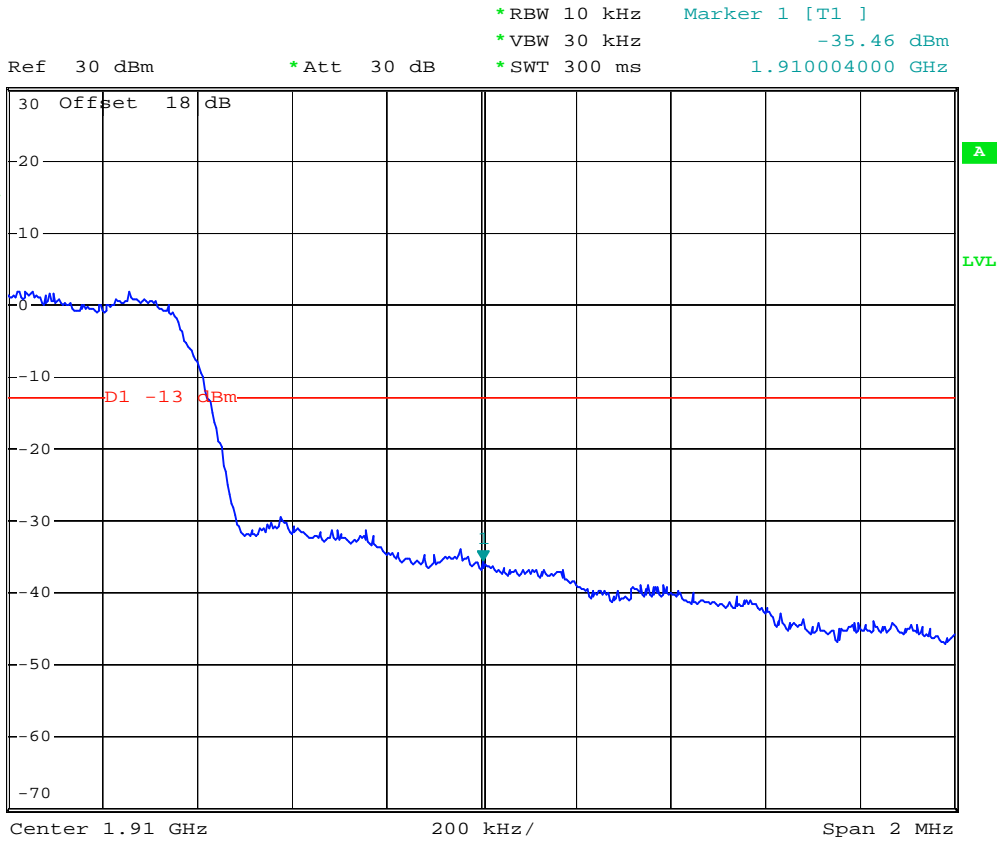

Date: 26.APR.2007 17:08:50



- Mode 4
- Test Mode : CDMA2000 PCS 1900 CH25_9.6Kbps Lower Band Edge for 1xEV-DO
- Power State : High

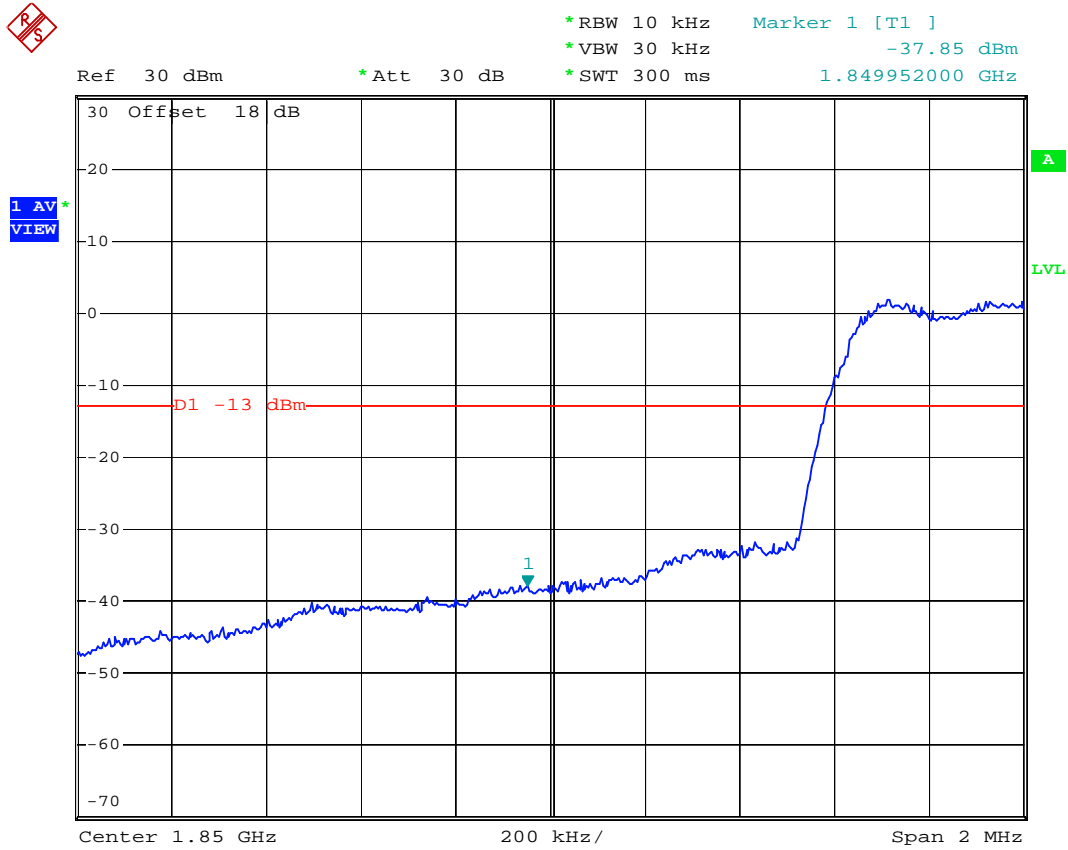

Date: 26.APR.2007 18:18:53



- Test Mode : CDMA2000 PCS 1900 CH1175_9.6Kbps Higher Band Edge for 1xEV-DO
- Power State : High

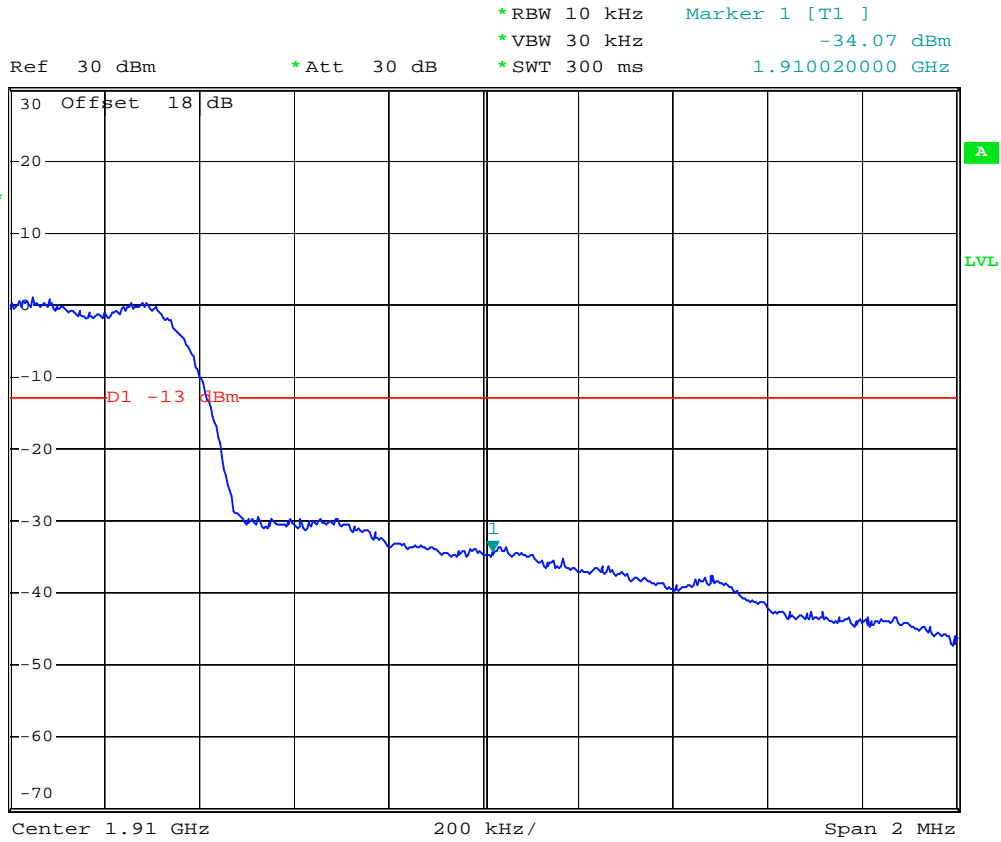

Date: 26.APR.2007 18:21:38



- Test Mode : CDMA2000 PCS 1900 CH25_38.4Kbps Lower Band Edge for 1xEV-DO
- Power State : High

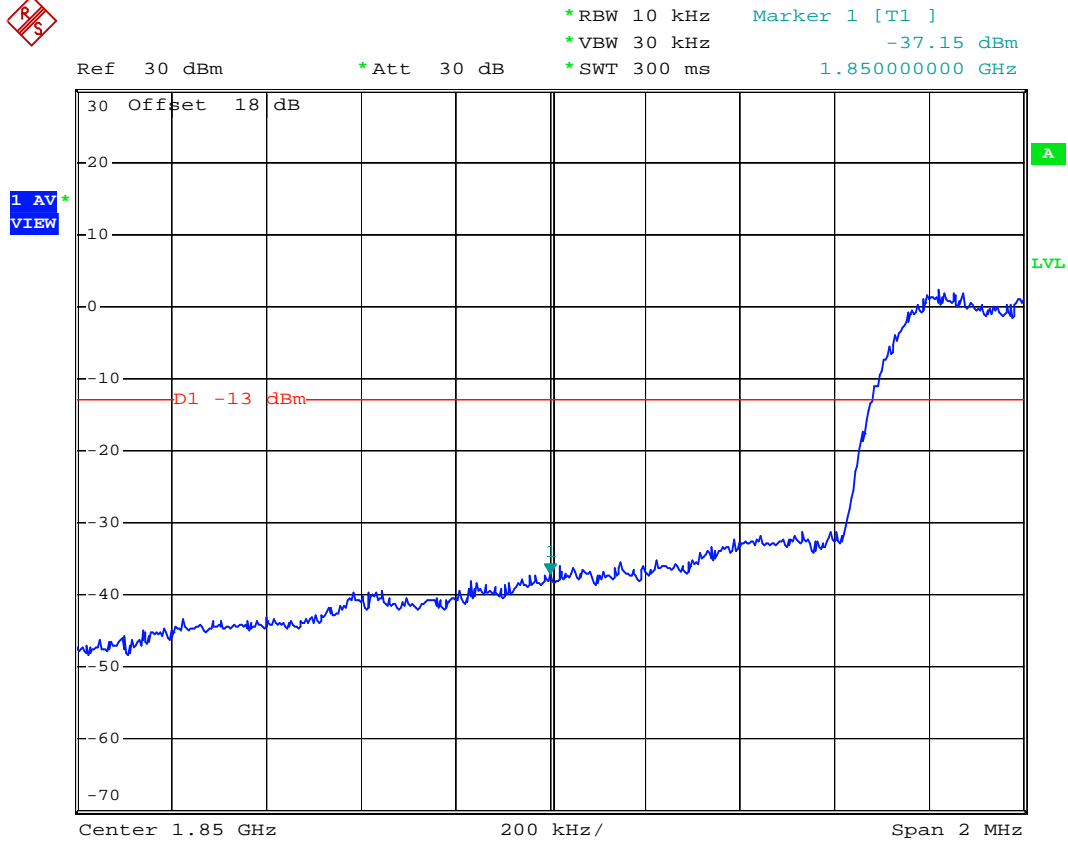

Date: 26.APR.2007 18:28:01



- Test Mode : CDMA2000 PCS 1900 CH1175_38.4Kbps Higher Band Edge for 1xEV-DO
- Power State : High



Date: 26.APR.2007 18:24:42



- Test Mode : CDMA2000 PCS 1900 CH25_153.6Kbps Lower Band Edge for 1xEV-DO
- Power State : High

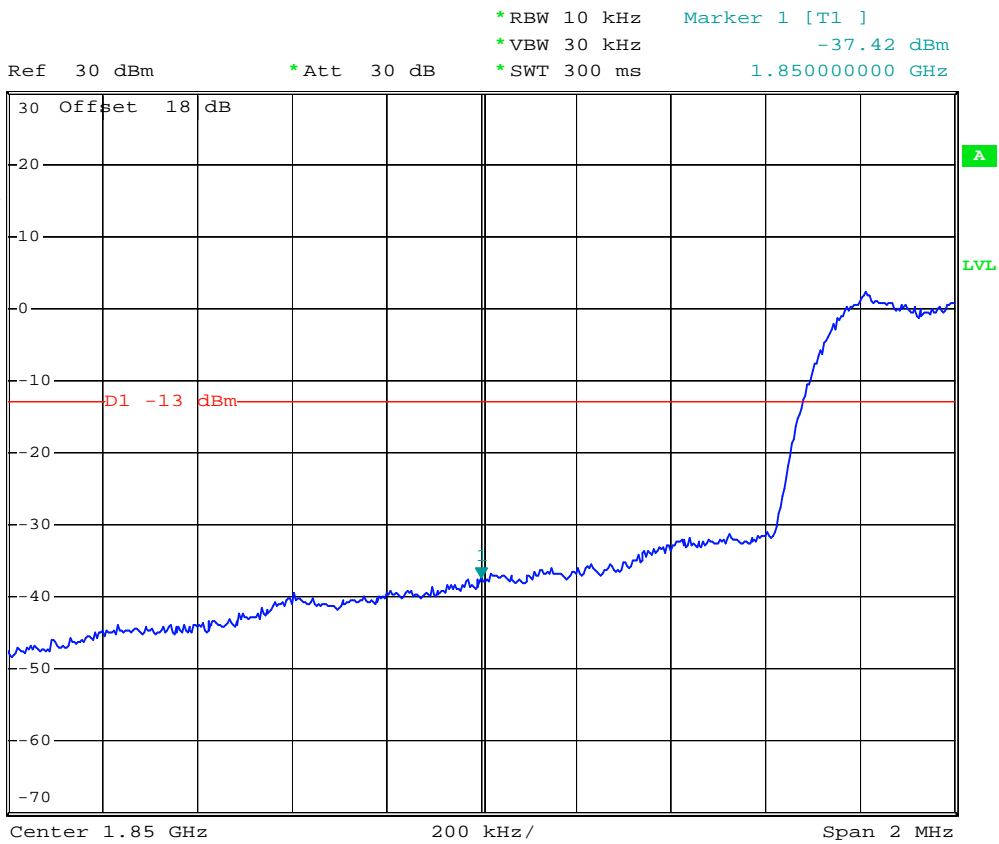

Date: 26.APR.2007 18:31:04



- Test Mode : CDMA2000 PCS 1900 CH1175_153.6Kbps Higher Band Edge for 1xEV-DO
- Power State : High

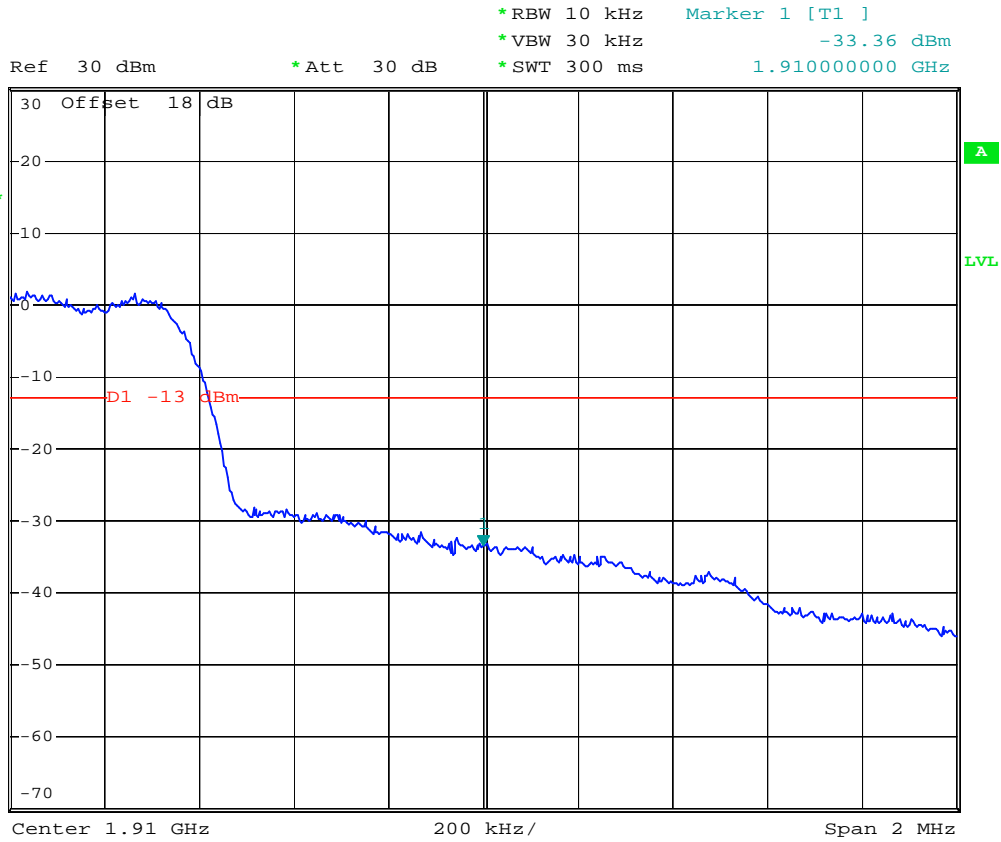

Date: 26.APR.2007 18:33:39

4.5 Conducted Emission

4.5.1 Measurement Instruments

As described in chapter 5 of this test report.

4.5.2 Test Procedure

1. The EUT was connected to Spectrum Analyzer and Base Station via power divider.
2. The middle channel for the highest RF power within the transmitting frequency was measured.
3. The conducted spurious emission for the whole frequency range was taken.

4.5.3 Test Setup Layout

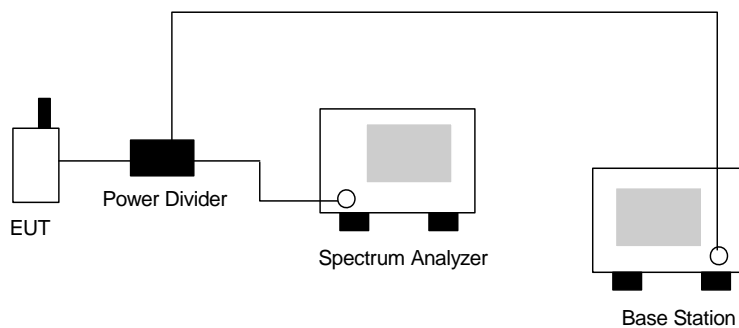



4.5.4 Test Result

- Mode 1
- Test Mode : CDMA2000 Cellular 850 CH384 for 1xRTT
- Frequency Range : 30M-1G

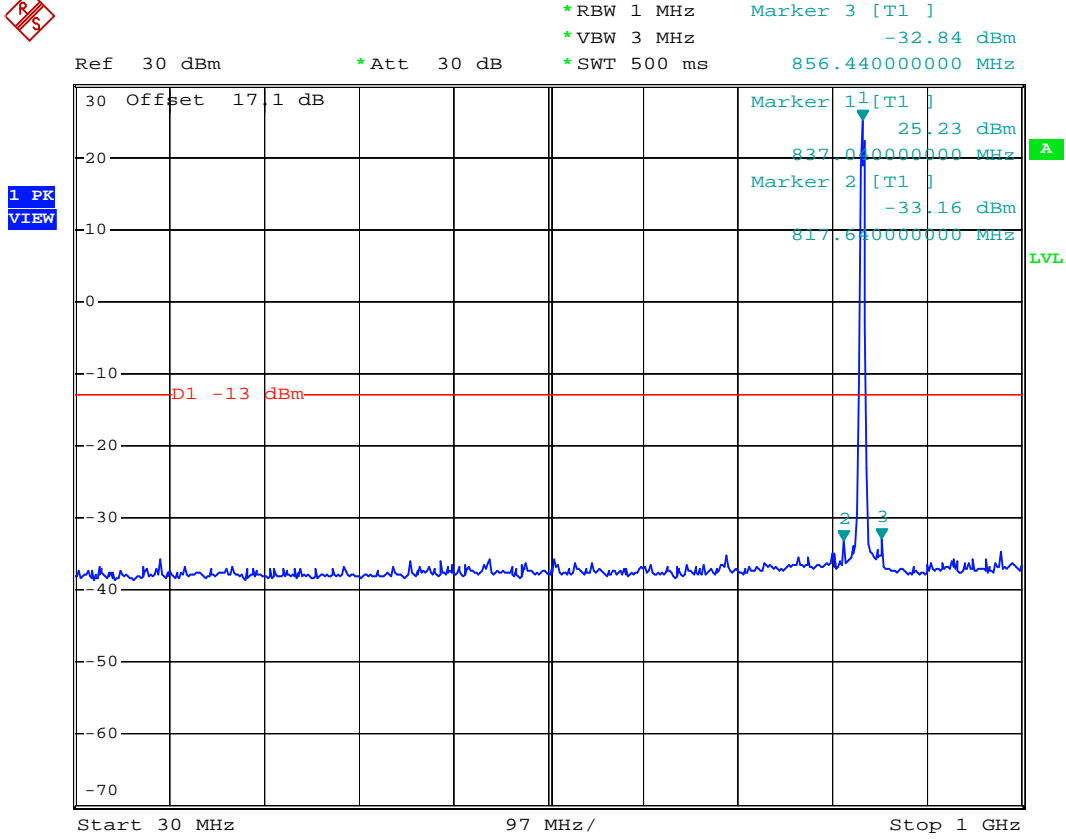

Date: 26.APR.2007 17:44:42



- Test Mode : CDMA2000 Cellular 850 CH384 for 1xRTT
- Frequency Range : 1G-3G

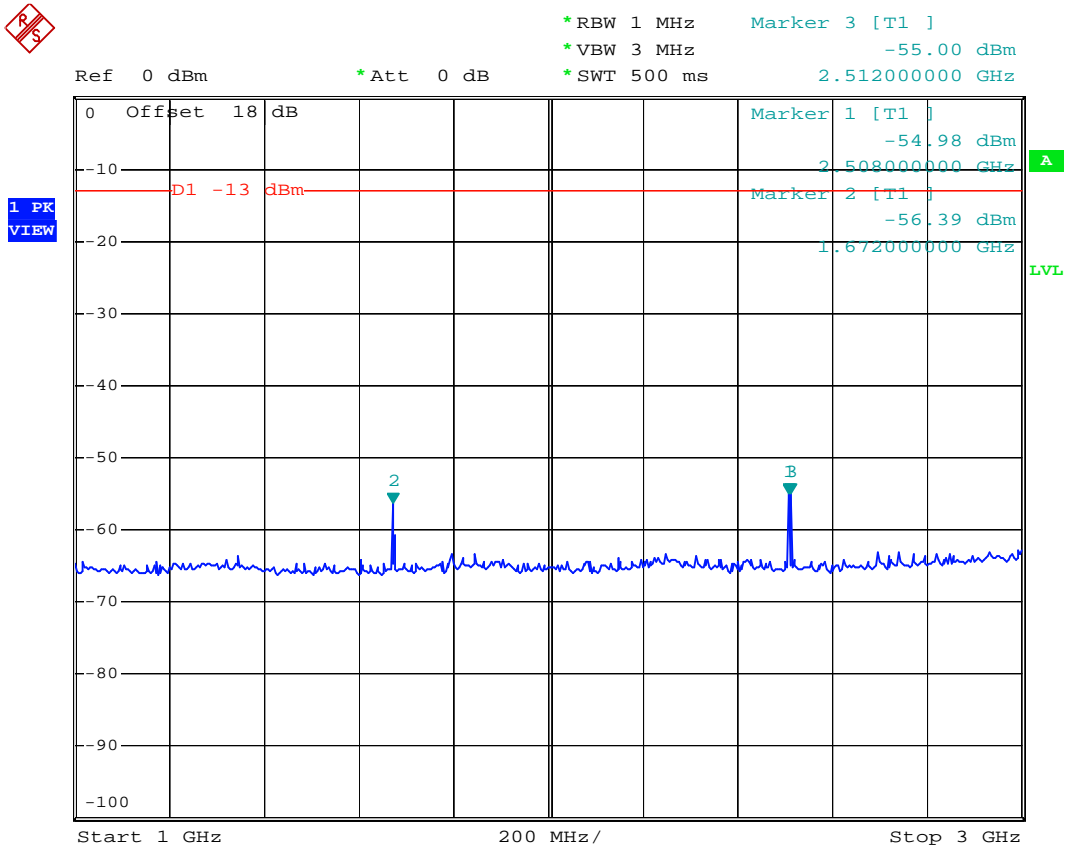

Date: 26.APR.2007 17:46:33



- Test Mode : CDMA2000 Cellular 850 CH384 for 1xRTT
- Frequency Range : 3G-7G

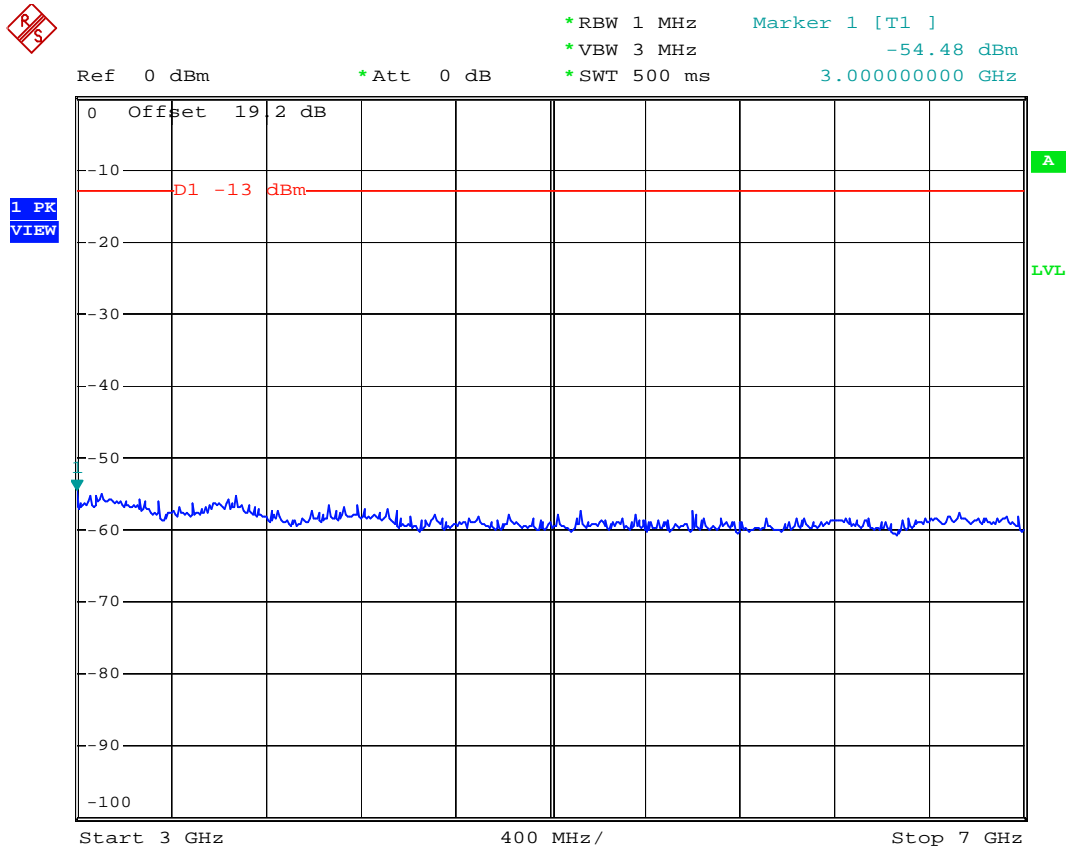

Date: 26.APR.2007 17:47:26



- Test Mode : CDMA2000 Cellular 850 CH384 for 1xRTT
- Frequency Range : 7G-9G

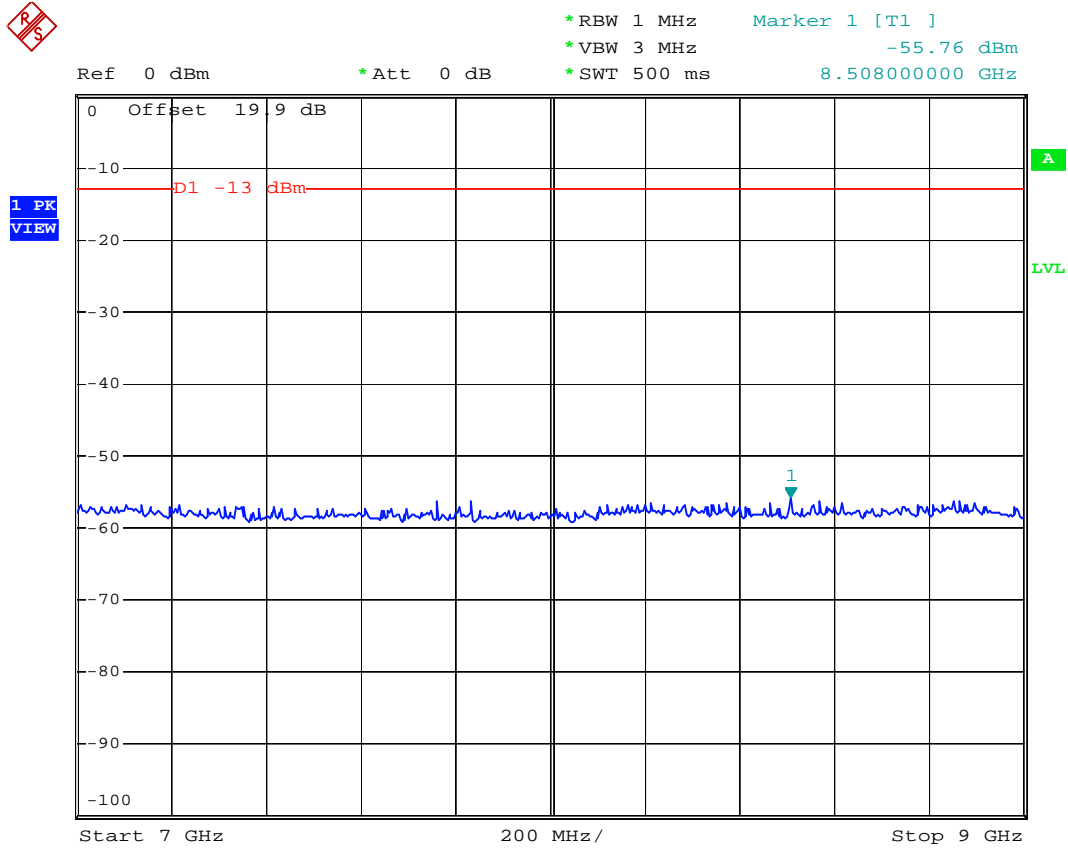

Date: 26.APR.2007 17:48:22



- Mode 2
- Test Mode : CDMA2000 PCS 1900 CH600 for 1xRTT
- Frequency Range : 30M-1G

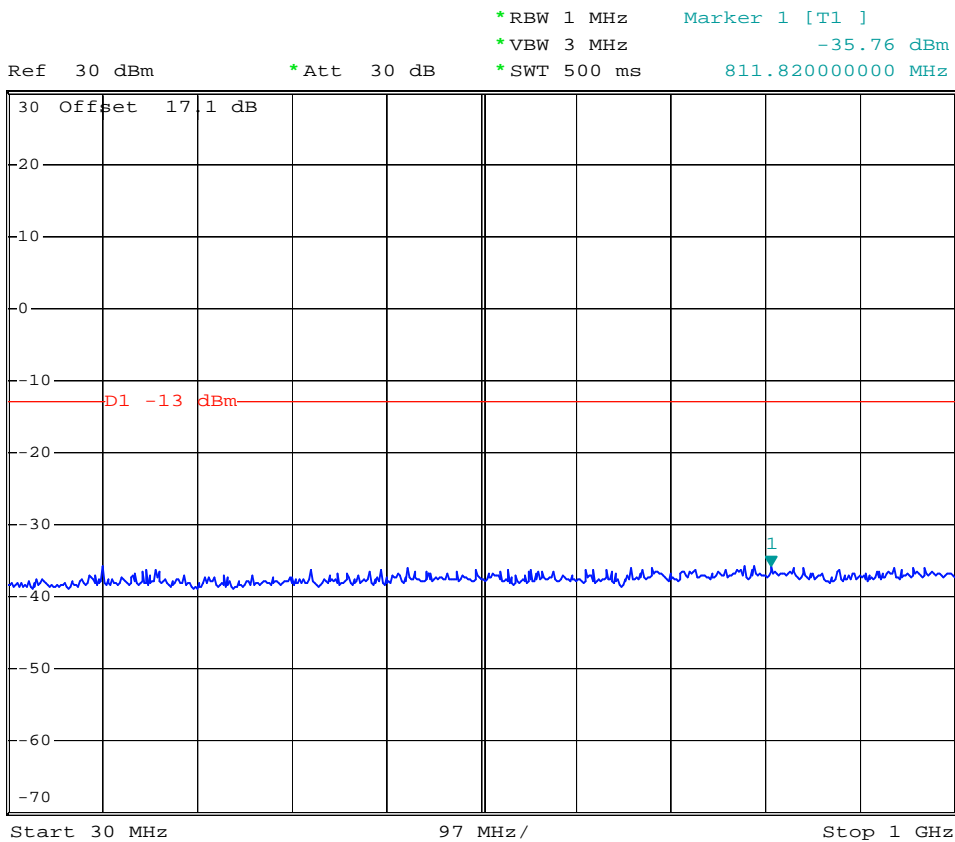

Date: 26.APR.2007 16:54:36



- Test Mode : CDMA2000 PCS 1900 CH600 for 1xRTT
- Frequency Range : 1G-3G

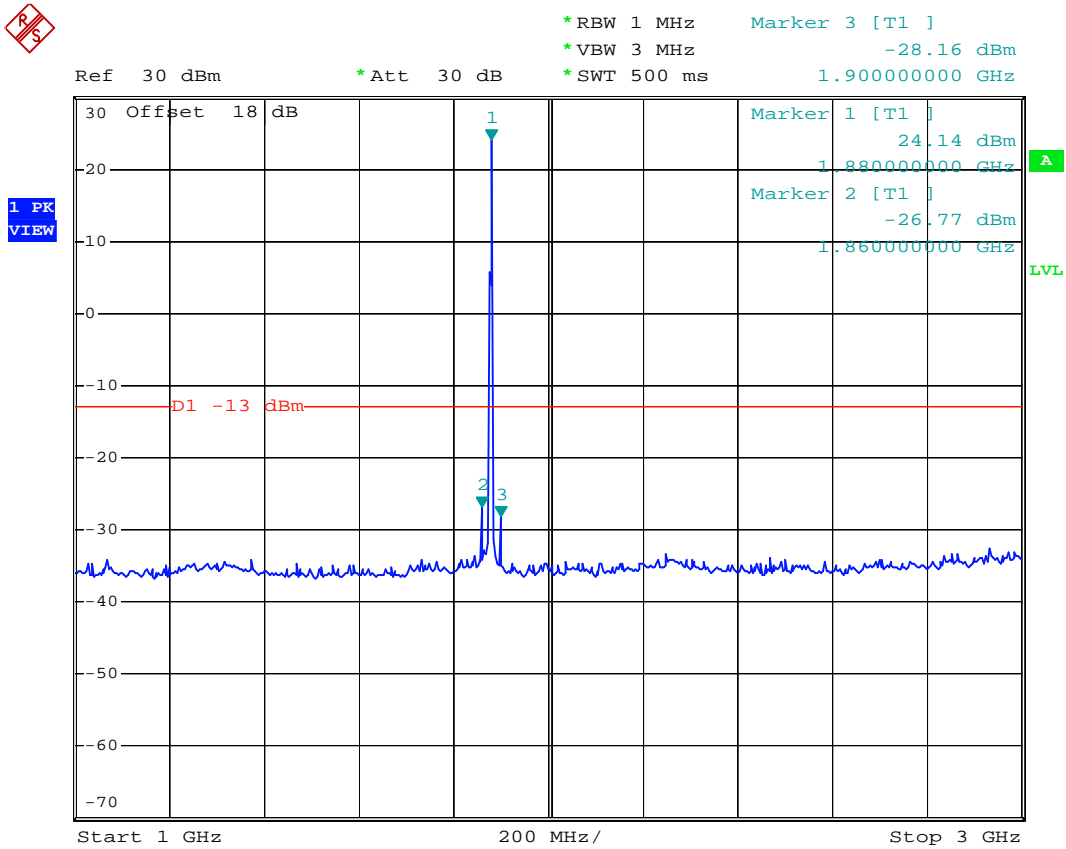

Date: 26.APR.2007 16:56:04



- Test Mode : CDMA2000 PCS 1900 CH600 for 1xRTT
- Frequency Range : 3G-7G

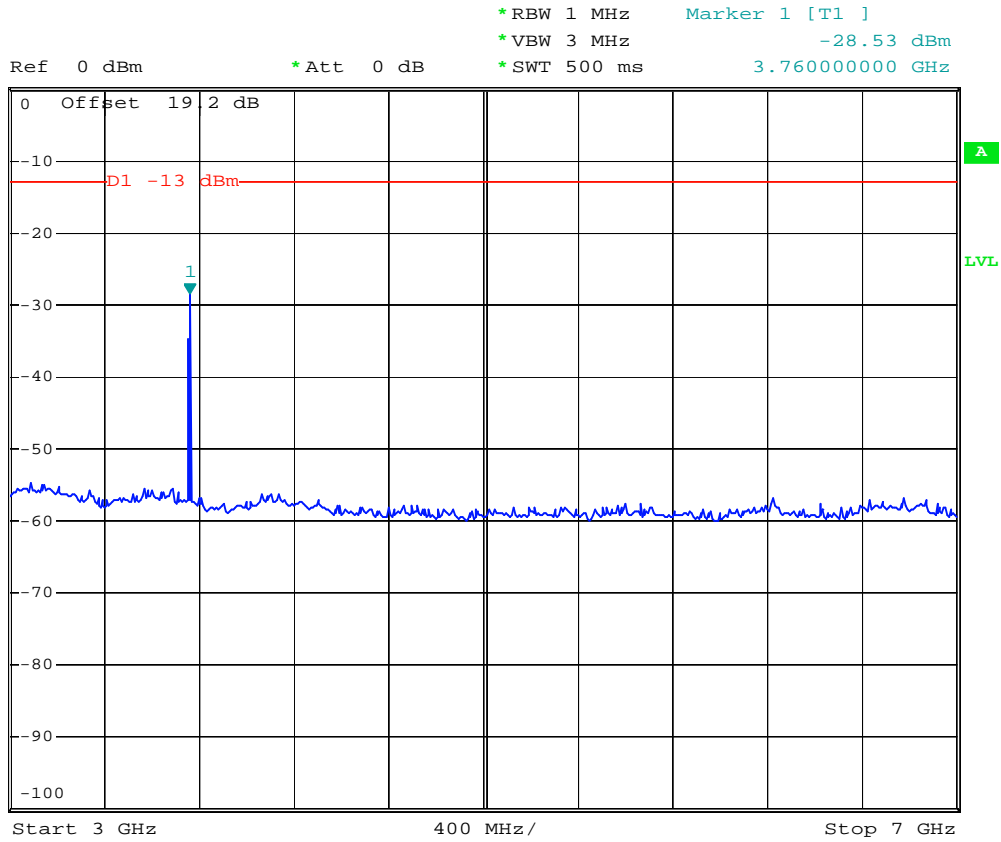

Date: 26.APR.2007 16:56:54



- Test Mode : CDMA2000 PCS 1900 CH600 for 1xRTT
- Frequency Range : 7G-13.6G

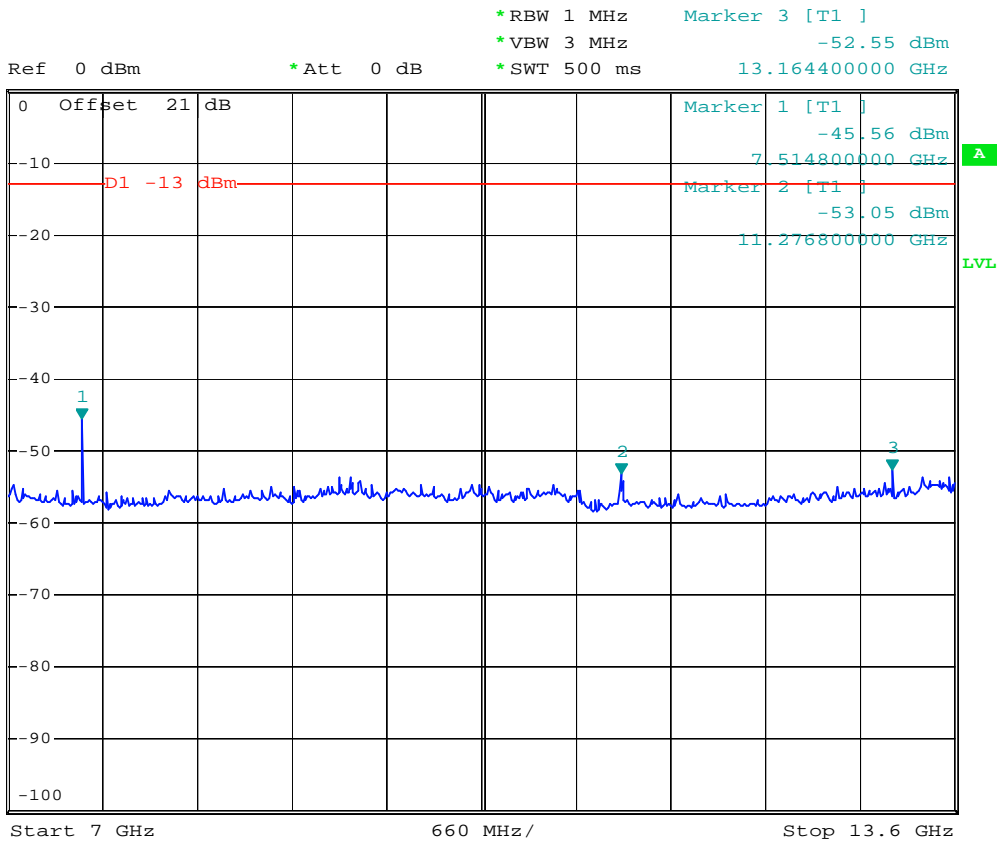

Date: 26.APR.2007 16:58:07



- Test Mode : CDMA2000 PCS 1900 CH600 for 1xRTT
- Frequency Range : 13.6G-19.1G

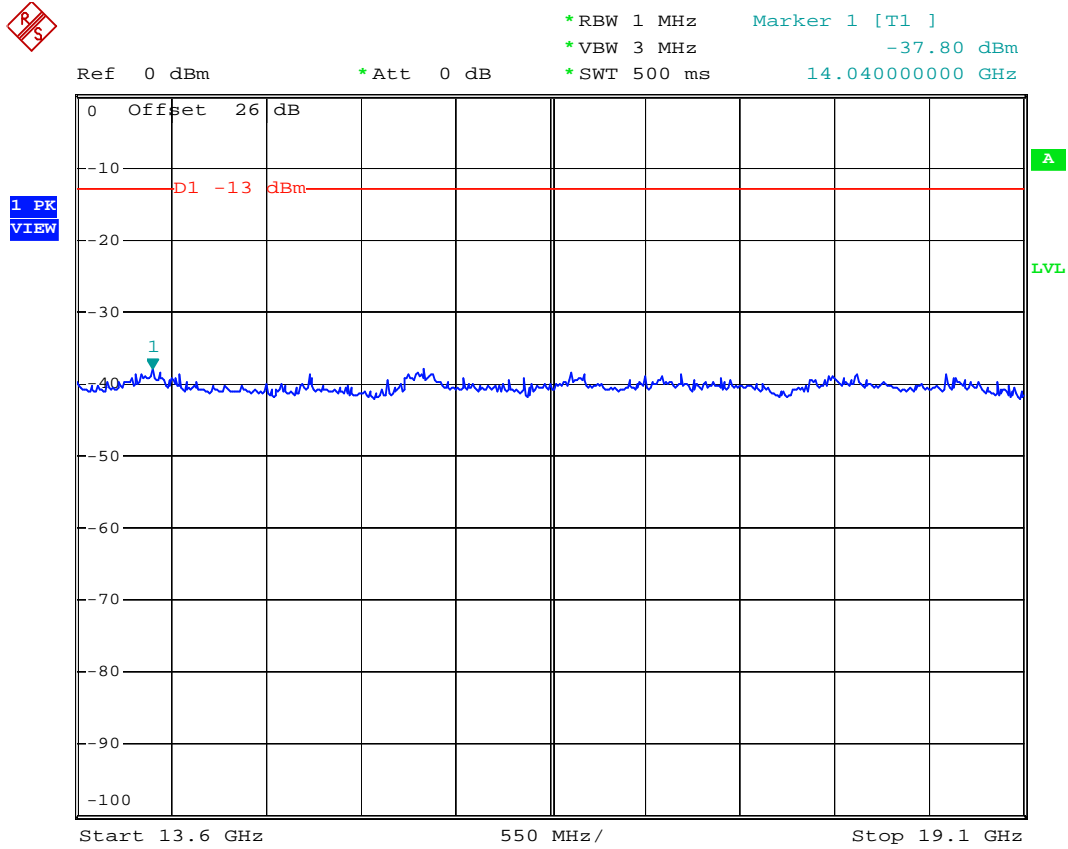

Date: 26.APR.2007 16:58:51

4.6 Field Strength of Spurious Radiation

Equivalent isotropic radiated Power Measurements by substitution method according to ANSI/TIA/EIA-603-C.

4.6.1 Measurement Instruments

As described in chapter 5 of this test report.

4.6.2 Test Procedure

1. The EUT was placed on a rotatable wooden table with 0.8 meter about ground.
2. The EUT was set 3 meters from the receiving antenna which was mounted on the antenna tower.
3. The table was rotated 360 degrees to determine the position of the highest spurious emission.
4. The height of the receiving antenna is varied between one meter and four meters to reach the maximum spurious emission for both horizontal and vertical polarizations.
5. Taking the record of maximum spurious emission.
6. A Horn antenna was substituted in place of the EUT and was driven by a signal generator.
7. Tune the output power of signal generator to the same emission level with EUT maximum spurious emission.
8. Taking the record of output power at antenna port.
9. Repeat step 7 to step 8 for another polarization.
10. Emission level (dBm) = output power + substitution Gain.

4.6.3 Test Setup Layout

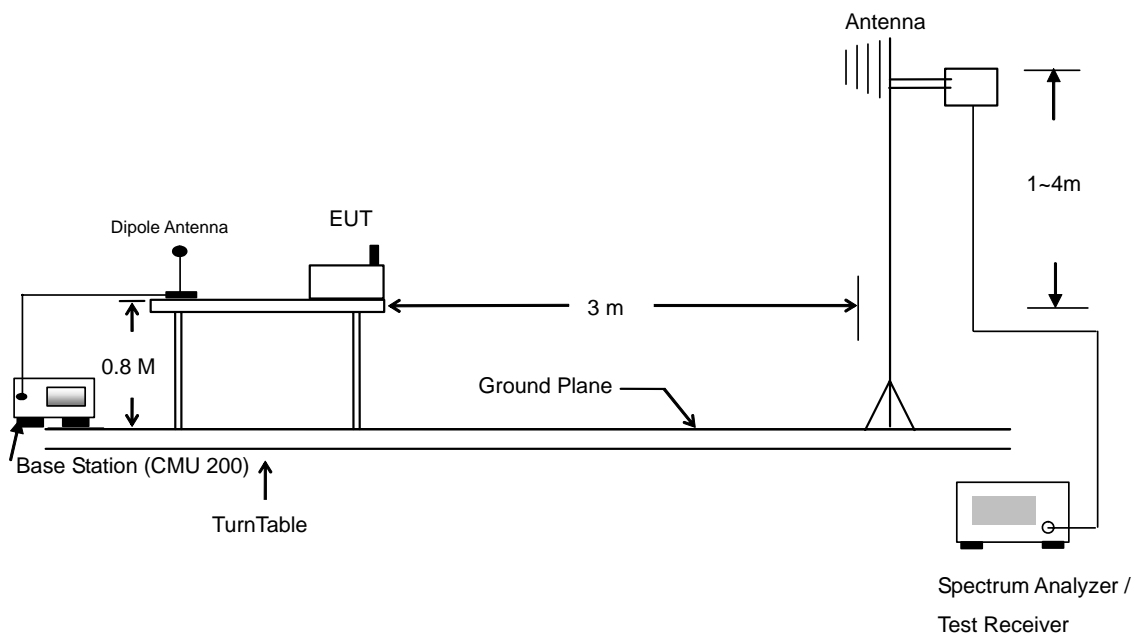



4.6.4 Test Result

- Test Mode : Mode 1

CDMA2000 Cellular 850 1xRTT FCH_RC3 Radiated Spurious ERP							
H Polarization				V Polarization			
Frequency (MHz)	ERP (dBm)	Limit (dBm)	Margin (dB)	Frequency (MHz)	ERP (dBm)	Limit (dBm)	Margin (dB)
98.580	-63.590	-13	-50.59	56.730	-55.990	-13	-42.99
214.140	-59.110	-13	-46.11	106.140	-44.870	-13	-31.87
287.040	-60.670	-13	-47.67	211.980	-54.930	-13	-41.93
397.300	-48.930	-13	-35.93	507.900	-43.570	-13	-30.57
701.800	-49.780	-13	-36.78	682.900	-49.820	-13	-36.82
1000.000	-53.450	-13	-40.45	1000.000	-56.230	-13	-43.23
1358.000	-49.030	-13	-36.03	1184.000	-56.780	-13	-43.78
1674.000	-55.150	-13	-42.15	1328.000	-55.600	-13	-42.60
1898.000	-59.930	-13	-46.93	1398.000	-60.020	-13	-47.02
1994.000	-60.490	-13	-47.49	1498.000	-57.760	-13	-44.76
2508.000	-55.270	-13	-42.27	1674.000	-55.080	-13	-42.08
				1898.000	-55.950	-13	-42.95
				1994.000	-56.930	-13	-43.93
				2098.000	-59.410	-13	-46.41
				2508.000	-49.080	-13	-36.08



- Test Mode : Mode 2

CDMA2000 Cellular 850 1xRTT 38.4Kbps Radiated Spurious ERP							
H Polarization				V Polarization			
Frequency (MHz)	ERP (dBm)	Limit (dBm)	Margin (dB)	Frequency (MHz)	ERP (dBm)	Limit (dBm)	Margin (dB)
98.580	-60.360	-13	-47.36	95.880	-55.890	-13	-42.89
211.980	-58.050	-13	-45.05	142.590	-57.300	-13	-44.30
287.040	-59.530	-13	-46.53	286.230	-55.770	-13	-42.77
423.900	-60.320	-13	-47.32	425.300	-47.020	-13	-34.02
500.900	-44.340	-13	-31.34	498.800	-53.360	-13	-40.36
1000.000	-54.050	-13	-41.05	1000.000	-55.880	-13	-42.88
1208.000	-55.870	-13	-42.87	1214.000	-59.730	-13	-46.73
1328.000	-58.120	-13	-45.12	1328.000	-59.890	-13	-46.89
1674.000	-52.320	-13	-39.32	1398.000	-59.960	-13	-46.96
1814.000	-53.110	-13	-40.11	1498.000	-58.010	-13	-45.01
1898.000	-59.450	-13	-46.45	1674.000	-54.200	-13	-41.20
1998.000	-60.440	-13	-47.44	1898.000	-54.990	-13	-41.99
2508.000	-47.170	-13	-34.17	1994.000	-55.660	-13	-42.66
				2098.000	-60.210	-13	-47.21
				2508.000	-44.750	-13	-31.75



- Test Mode : Mode 3

CDMA2000 PCS 1900 1xRTT FCH_RC3 Radiated Spurious EIRP							
H Polarization				V Polarization			
Frequency (MHz)	EIRP (dBm)	Limit (dBm)	Margin (dB)	Frequency (MHz)	EIRP (dBm)	Limit (dBm)	Margin (dB)
35.130	-56.890	-13	-43.89	58.890	-53.490	-13	-40.49
214.680	-58.030	-13	-45.03	215.490	-53.350	-13	-40.35
287.040	-58.950	-13	-45.95	284.880	-54.530	-13	-41.53
423.900	-45.540	-13	-32.54	421.800	-52.640	-13	-39.64
848.800	-57.190	-13	-44.19	572.300	-38.740	-13	-25.74
997.900	-57.280	-13	-44.28	715.800	-52.380	-13	-39.38
1000.000	-50.950	-13	-37.95	1000.000	-51.270	-13	-38.27
1018.000	-52.320	-13	-39.32	1208.000	-52.170	-13	-39.17
1328.000	-57.030	-13	-44.03	1328.000	-53.050	-13	-40.05
1994.000	-59.530	-13	-46.53	1498.000	-55.330	-13	-42.33
2494.000	-56.650	-13	-43.65	1658.000	-57.090	-13	-44.09
3758.000	-32.310	-13	-19.31	1988.000	-54.590	-13	-41.59
				2488.000	-54.000	-13	-41.00
				2994.000	-53.350	-13	-40.35
				3758.000	-38.130	-13	-25.13



- Test Mode : Mode 4

CDMA2000 PCS 1900 1xEV-DO 38.4Kbps Radiated Spurious EIRP							
H Polarization				V Polarization			
Frequency (MHz)	EIRP (dBm)	Limit (dBm)	Margin (dB)	Frequency (MHz)	EIRP (dBm)	Limit (dBm)	Margin (dB)
133.140	-63.700	-13	-50.70	58.080	-55.770	-13	-42.77
214.680	-59.840	-13	-46.84	98.580	-55.180	-13	-42.18
287.040	-56.500	-13	-43.50	284.880	-54.100	-13	-41.10
423.900	-57.040	-13	-44.04	421.800	-54.330	-13	-41.33
855.800	-57.240	-13	-44.24	568.800	-51.660	-13	-38.66
995.800	-56.750	-13	-43.75	586.300	-36.010	-13	-23.01
1000.000	-49.960	-13	-36.96	1000.000	-51.810	-13	-38.81
1248.000	-55.690	-13	-42.69	1218.000	-56.720	-13	-43.72
1328.000	-54.190	-13	-41.19	1334.000	-57.400	-13	-44.40
1498.000	-57.220	-13	-44.22	1398.000	-56.620	-13	-43.62
1994.000	-59.350	-13	-46.35	1498.000	-55.120	-13	-42.12
2488.000	-57.160	-13	-44.16	1658.000	-57.410	-13	-44.41
3758.000	-30.310	-13	-17.31	1994.000	-53.640	-13	-40.64
				2098.000	-57.500	-13	-44.50
				2498.000	-55.510	-13	-42.51
				2998.000	-53.490	-13	-40.49
				3758.000	-36.470	-13	-23.47



- Test Mode : Mode 5

CDMA2000 Cellular 850 1xRTT FCH_RC3 with BT Co-location Radiated Spurious ERP							
H Polarization				V Polarization			
Frequency (MHz)	ERP (dBm)	Limit (dBm)	Margin (dB)	Frequency (MHz)	ERP (dBm)	Limit (dBm)	Margin (dB)
201.990	-59.120	-13	-46.12	99.390	-57.190	-13	-44.19
243.840	-54.180	-13	-41.18	201.990	-57.500	-13	-44.50
269.490	-63.680	-13	-50.68	232.230	-56.900	-13	-43.90
728.400	-47.040	-13	-34.04	612.900	-39.320	-13	-26.32
897.800	-52.050	-13	-39.05	897.800	-48.800	-13	-35.80
1000.000	-51.410	-13	-38.41	1000.000	-53.510	-13	-40.51
1198.000	-56.110	-13	-43.11	1274.000	-56.200	-13	-43.20
1328.000	-51.380	-13	-38.38	1328.000	-53.150	-13	-40.15
1588.000	-59.690	-13	-46.69	1588.000	-60.410	-13	-47.41
1674.000	-56.820	-13	-43.82	1674.000	-60.400	-13	-47.40
1994.000	-59.390	-13	-46.39	1824.000	-56.360	-13	-43.36
2508.000	-56.990	-13	-43.99	1854.000	-59.470	-13	-46.47
				1998.000	-59.900	-13	-46.90
				2508.000	-53.960	-13	-40.96



- Test Mode : Mode 6

CDMA2000 Cellular 850 1xRTT FCH_RC3 with WLAN Co-location Radiated Spurious ERP							
H Polarization				V Polarization			
Frequency (MHz)	ERP (dBm)	Limit (dBm)	Margin (dB)	Frequency (MHz)	ERP (dBm)	Limit (dBm)	Margin (dB)
133.680	-64.530	-13	-51.53	82.380	-55.470	-13	-42.47
213.330	-63.040	-13	-50.04	96.690	-57.970	-13	-44.97
285.690	-59.630	-13	-46.63	287.040	-55.790	-13	-42.79
427.400	-59.840	-13	-46.84	566.000	-53.310	-13	-40.31
995.800	-47.810	-13	-34.81	997.900	-48.460	-13	-35.46
1000.000	-42.550	-13	-29.55	1000.000	-45.870	-13	-32.87
1264.000	-56.430	-13	-43.43	1184.000	-53.640	-13	-40.64
1328.000	-55.620	-13	-42.62	1208.000	-52.690	-13	-39.69
1674.000	-54.220	-13	-41.22	1334.000	-51.370	-13	-38.37
1898.000	-60.830	-13	-47.83	1498.000	-56.880	-13	-43.88
1994.000	-58.460	-13	-45.46	1674.000	-52.750	-13	-39.75
2508.000	-55.530	-13	-42.53	1898.000	-57.540	-13	-44.54
4824.000	-49.330	-13	-36.33	1988.000	-54.950	-13	-41.95
				2508.000	-53.770	-13	-40.77
				4824.000	-51.330	-13	-38.33



4.6.5 Test Data

4.6.5.1 Mode 1

Horizontal Polarization

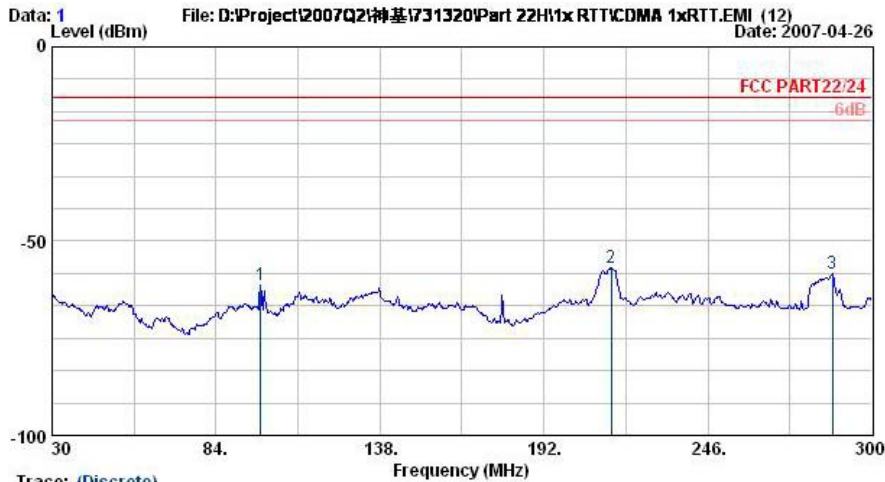

Trace: (Discrete)
 Site : 03CH06-HY
 Condition : LP-SPURIOUS HORIZONTAL
 EUT : Notebook PC
 Power : 120Vac/60Hz
 Model : FG 731320
 Memo : CDMA2000 Cellular Link;CH384+Adaptor

	Freq	Level	Over	Limit	Read	Factor	Remark
	MHz	dBm	dB	dBm	dBm	dB	
1	98.58	-61.44	-48.44	-13.00	-49.20	-12.24	Peak
2 @	214.14	-56.96	-43.96	-13.00	-44.07	-12.89	Peak
3	287.04	-58.52	-45.52	-13.00	-48.14	-10.38	Peak

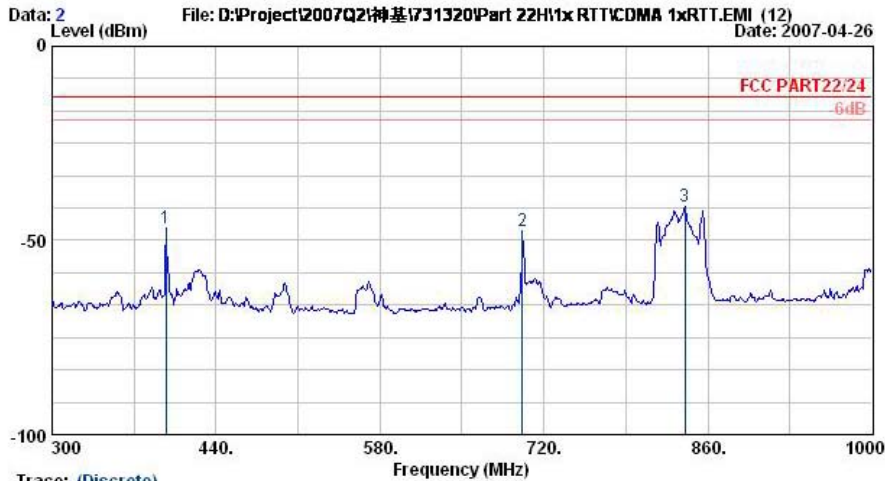

Trace: (Discrete)
 Site : 03CH06-HY
 Condition : LP-SPURIOUS HORIZONTAL
 EUT : Notebook PC
 Power : 120Vac/60Hz
 Model : FG 731320
 Memo : CDMA2000 Cellular Link;CH384+Adaptor

	Freq	Level	Over	Limit	Read	Factor	Remark
	MHz	dBm	dB	dBm	dBm	dB	
1 @	397.30	-46.78	-33.78	-13.00	-40.21	-6.57	Peak
2 @	701.80	-47.63	-34.63	-13.00	-44.93	-2.70	Peak
3 @	840.40	-41.43			-40.13	-1.31	Peak

Remark:
 1. #3: MS Signal



Data: 3 File: D:\Project\2007Q2\#731320\Part 22H1x RTT\CDMA 1xRTT.EMI (12) Date: 2007-04-26

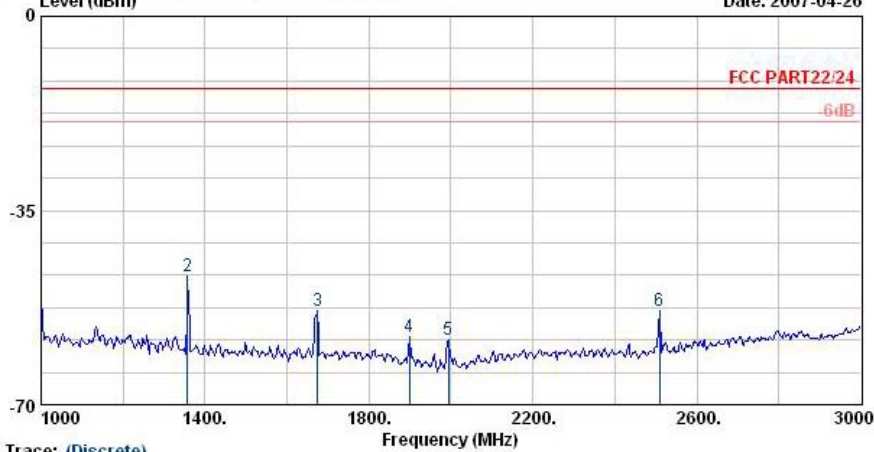

Trace: (Discrete)
Site : 03CH06-HY
Condition : HF-SPURIOUS HORIZONTAL
EUT : Notebook PC
Power : 120Vac/60Hz
Model : FG 731320
Memo : CDMA2000 Cellular Link;CH384+Adaptor

Table with 7 columns: Freq (MHz), Level (dBm), Over Limit (dB), Limit Line (dBm), Read Level (dBm), Factor, Remark. Contains 6 rows of peak data.

Data: 4 File: D:\Project\2007Q2\#731320\Part 22H1x RTT\CDMA 1xRTT.EMI (12) Date: 2007-04-26

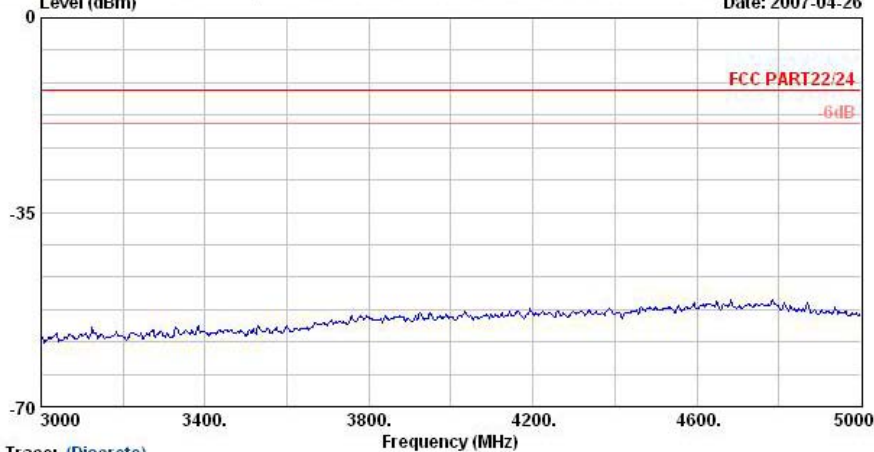

Trace: (Discrete)
Site : 03CH06-HY
Condition : HF-SPURIOUS HORIZONTAL
EUT : Notebook PC
Power : 120Vac/60Hz
Model : FG 731320
Memo : CDMA2000 Cellular Link;CH384+Adaptor



Data: 5 File: D:\Project\2007Q2\诺基亚731320\Part 22H1x RTT\CDMA 1xRTT.EMI (12) Date: 2007-04-26

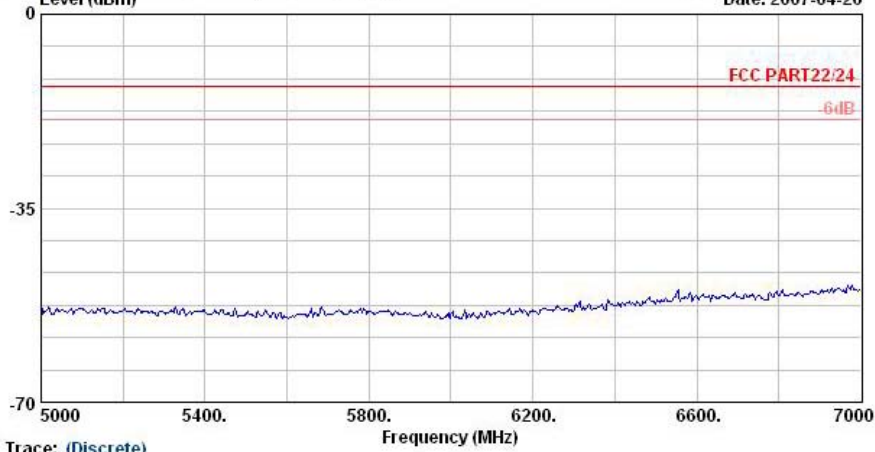

Trace: (Discrete)
Site : 03CH06-HY
Condition : HF-SPURIOUS HORIZONTAL
EUT : Notebook PC
Power : 120Vac/60Hz
Model : FG 731320
Memo : CDMA2000 Cellular Link;CH384+Adaptor

Data: 6 File: D:\Project\2007Q2\诺基亚731320\Part 22H1x RTT\CDMA 1xRTT.EMI (12) Date: 2007-04-26

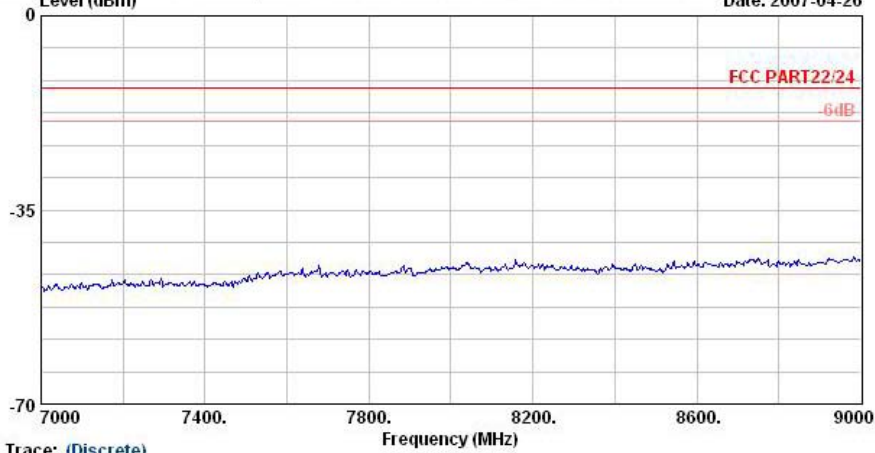

Trace: (Discrete)
Site : 03CH06-HY
Condition : HF-SPURIOUS HORIZONTAL
EUT : Notebook PC
Power : 120Vac/60Hz
Model : FG 731320
Memo : CDMA2000 Cellular Link;CH384+Adaptor

Remark: There's no more obvious spurious emission except the listings above.



Vertical Polarization

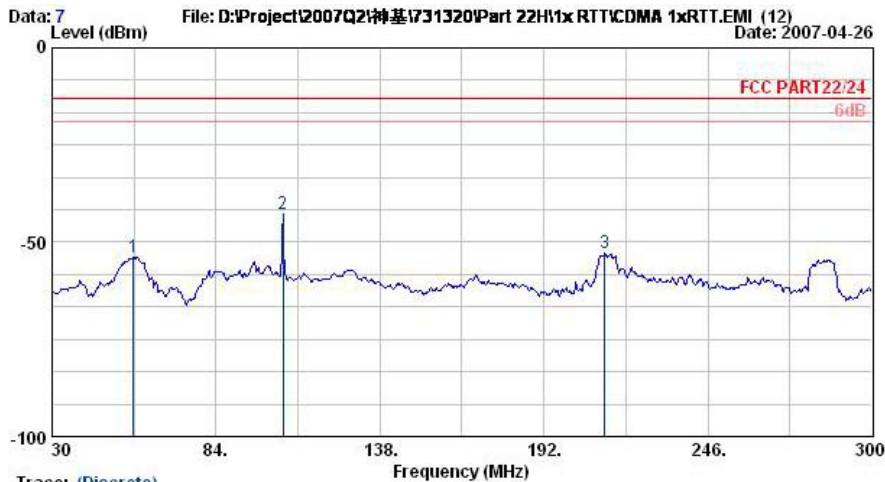

Site : 03CH06-HY
 Condition : LP-SPURIOUS VERTICAL
 EUT : Notebook PC
 Power : 120Vac/60Hz
 Model : FG 731320
 Memo : CDMA2000 Cellular Link;CH384+Adaptor

Trace: (Discrete)

	Over	Limit	Read				
Freq	Level	Limit	Line	Level	Factor		
MHz	dBm	dB	dBm	dBm	dB		
1 @	56.73	-53.84	-40.84	-13.00	-40.00	-13.84	Peak
2 @	106.14	-42.72	-29.72	-13.00	-34.98	-7.74	Peak
3 @	211.98	-52.78	-39.78	-13.00	-44.46	-8.32	Peak

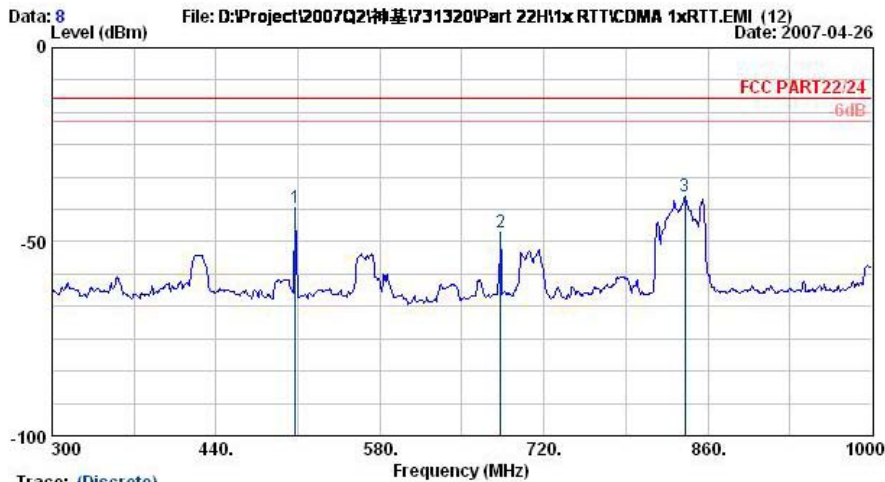

Site : 03CH06-HY
 Condition : LP-SPURIOUS VERTICAL
 EUT : Notebook PC
 Power : 120Vac/60Hz
 Model : FG 731320
 Memo : CDMA2000 Cellular Link;CH384+Adaptor

Trace: (Discrete)

	Over	Limit	Read				
Freq	Level	Limit	Line	Level	Factor		
MHz	dBm	dB	dBm	dBm	dB		
1 @	507.90	-41.42	-28.42	-13.00	-38.39	-3.03	Peak
2 @	682.90	-47.67	-34.67	-13.00	-46.98	-0.69	Peak
3 @	840.40	-38.40			-39.79	1.39	Peak

Remark:

- #3: MS Signal



FCC TEST REPORT

Report No. : FG731320

Data: 9 File: D:\Project\2007Q2\斯基731320\Part 22H1x RTT\CDMA 1xRTT.EMI (12) Date: 2007-04-26

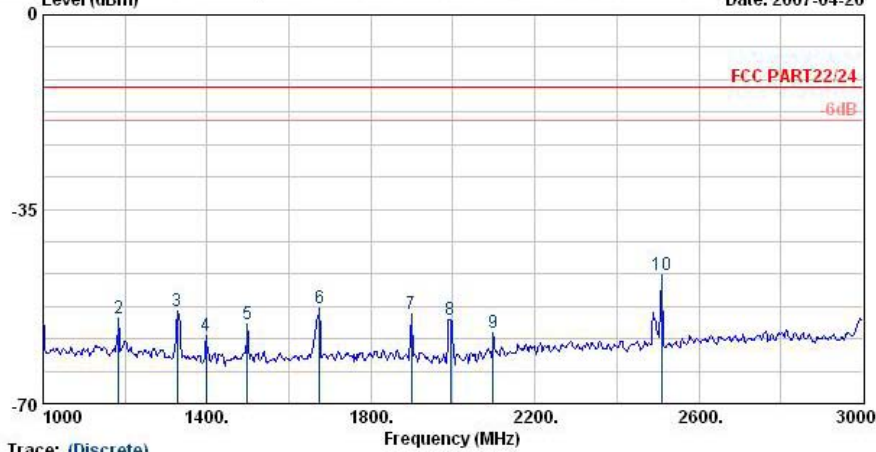

Trace: (Discrete)

Site : 03CH06-HY
 Condition : HF-SPURIOUS VERTICAL
 EUT : Notebook PC
 Power : 120Vac/60Hz
 Model : FG 731320
 Memo : CDMA2000 Cellular Link;CH384+Adaptor

	Freq	Level	Over	Limit	Read	Factor	Remark
	MHz	dBm	Limit	Line	Level	dB	
1 @	1000.00	-54.08	-41.08	-13.00	-53.30	-0.79	Peak
2 @	1184.00	-54.63	-41.63	-13.00	-53.90	-0.73	Peak
3 @	1328.00	-53.45	-40.45	-13.00	-52.65	-0.80	Peak
4 @	1398.00	-57.87	-44.87	-13.00	-56.95	-0.91	Peak
5 @	1498.00	-55.61	-42.61	-13.00	-54.75	-0.86	Peak
6 @	1674.00	-52.93	-39.93	-13.00	-52.45	-0.48	Peak
7 @	1898.00	-53.80	-40.80	-13.00	-53.30	-0.50	Peak
8 @	1994.00	-54.78	-41.78	-13.00	-54.08	-0.69	Peak
9 @	2098.00	-57.26	-44.26	-13.00	-57.68	0.43	Peak
10 @	2508.00	-46.93	-33.93	-13.00	-49.20	2.27	Peak

Data: 10 File: D:\Project\2007Q2\斯基731320\Part 22H1x RTT\CDMA 1xRTT.EMI (12) Date: 2007-04-26

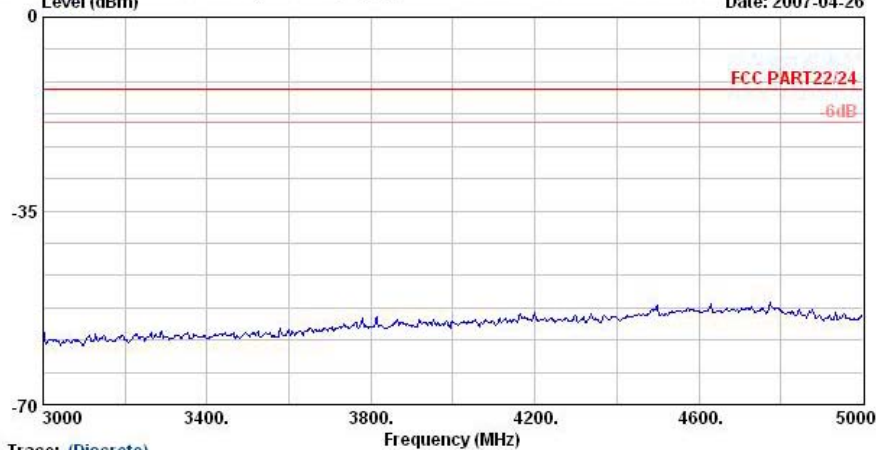

Trace: (Discrete)

Site : 03CH06-HY
 Condition : HF-SPURIOUS VERTICAL
 EUT : Notebook PC
 Power : 120Vac/60Hz
 Model : FG 731320
 Memo : CDMA2000 Cellular Link;CH384+Adaptor

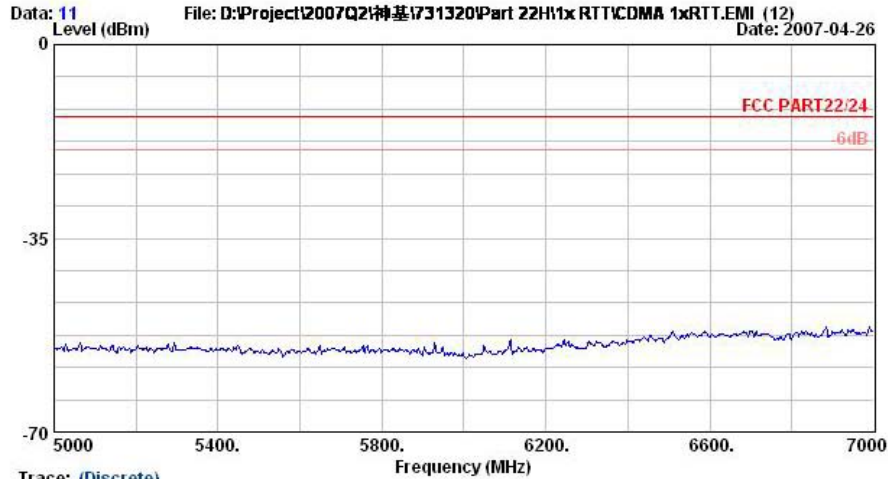

Trace: (Discrete)
Site : 03CH06-HV
Condition : HF-SPURIOUS VERTICAL
EUT : Notebook PC
Power : 120Vac/60Hz
Model : FG 731320
Memo : CDMA2000 Cellular Link;CH384+Adaptor

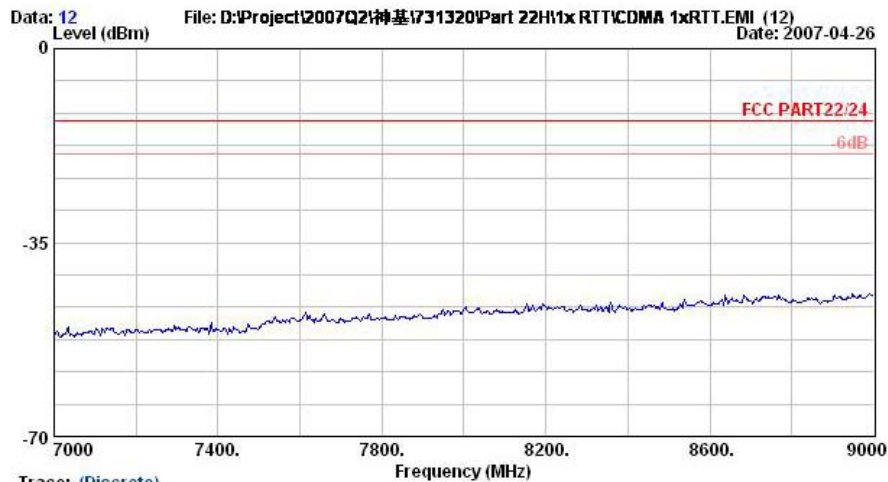

Trace: (Discrete)
Site : 03CH06-HV
Condition : HF-SPURIOUS VERTICAL
EUT : Notebook PC
Power : 120Vac/60Hz
Model : FG 731320
Memo : CDMA2000 Cellular Link;CH384+Adaptor

Remark : There is no more obvious emission except the listings above.



4.6.5.2 Mode 2
Horizontal Polarization

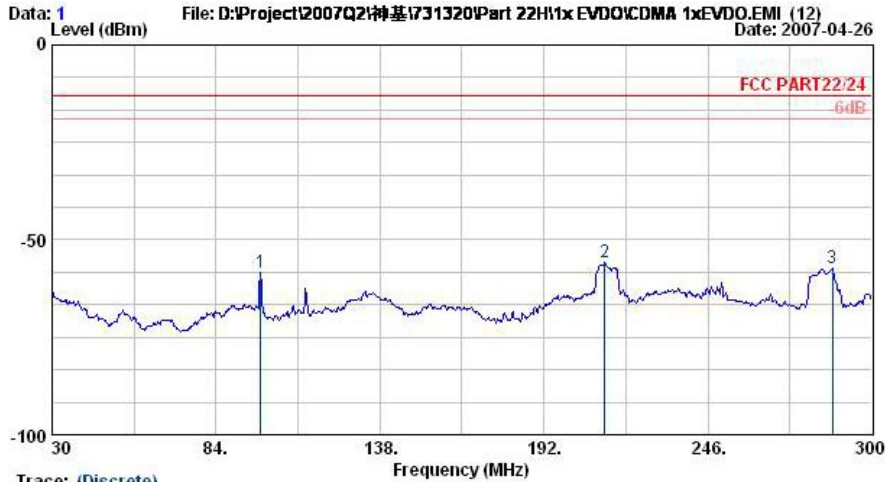

Site : 03CH06-HY
 Condition : LP-SPURIOUS HORIZONTAL
 EUT : Notebook PC
 Power : 120Vac/60Hz
 Model : FC 731320
 Memo : CDMA2000 Cellular Link;CH384+Adaptor

Peak	Freq (MHz)	Level (dBm)	Over Limit (dB)	Limit Line (dBm)	Read Level (dBm)	Factor (dB)	Remark
1	98.58	-58.21	-45.21	-13.00	-45.97	-12.24	Peak
2	211.98	-55.90	-42.90	-13.00	-42.94	-12.96	Peak
3	287.04	-57.38	-44.38	-13.00	-47.00	-10.38	Peak

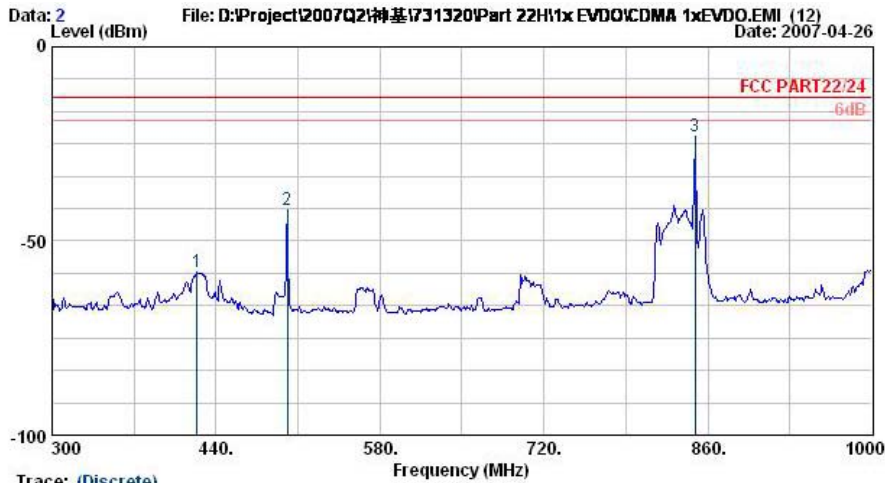

Site : 03CH06-HY
 Condition : LP-SPURIOUS HORIZONTAL
 EUT : Notebook PC
 Power : 120Vac/60Hz
 Model : FC 731320
 Memo : CDMA2000 Cellular Link;CH384+Adaptor

Peak	Freq (MHz)	Level (dBm)	Over Limit (dB)	Limit Line (dBm)	Read Level (dBm)	Factor (dB)	Remark
1	423.90	-58.17	-45.17	-13.00	-52.00	-6.17	Peak
2 @	500.90	-42.19	-29.19	-13.00	-37.08	-5.11	Peak
3 @	848.80	-23.15			-21.93	-1.22	Peak

Remark:
 1. #3: MS Signal



Data: 3 File: D:\Project\2007Q2\斯基731320\Part 22H1x EVD0\CDMA 1xEVDO.EMI (12) Date: 2007-04-26

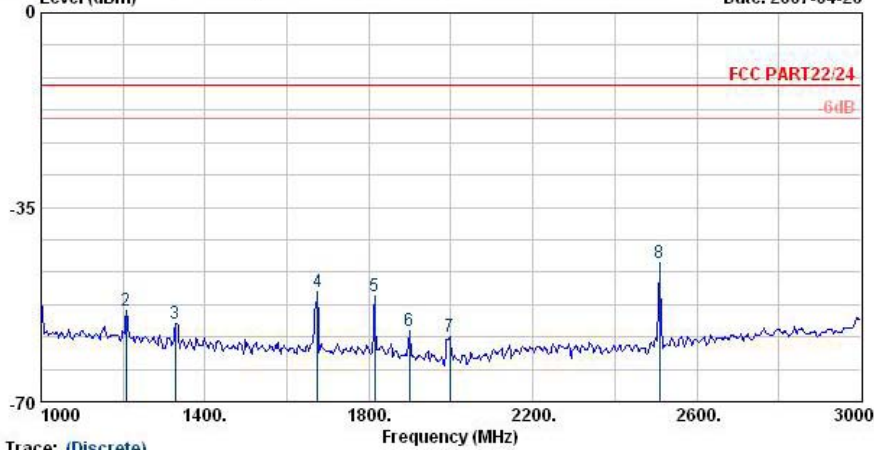

Trace: (Discrete)
 Site : 03CH06-HY
 Condition : HF-SPURIOUS HORIZONTAL
 EUT : Notebook PC
 Power : 120Vac/60Hz
 Model : FG 731320
 Memo : CDMA2000 Cellular Link;CH384+Adaptor

	Freq	Level	Over	Limit	Read		
	MHz	dBm	Limit	Line	Level	Factor	Remark
			dB	dBm	dBm	dB	
1	1000.00	-51.90	-38.90	-13.00	-53.70	1.80	Peak
2	1208.00	-53.72	-40.72	-13.00	-55.09	1.37	Peak
3	1328.00	-55.97	-42.97	-13.00	-56.92	0.96	Peak
4	1674.00	-50.17	-37.17	-13.00	-50.39	0.22	Peak
5	1814.00	-50.96	-37.96	-13.00	-50.75	-0.21	Peak
6	1898.00	-57.30	-44.30	-13.00	-56.63	-0.68	Peak
7	1998.00	-58.29	-45.29	-13.00	-57.01	-1.28	Peak
8	2508.00	-45.02	-32.02	-13.00	-46.22	1.20	Peak

Data: 4 File: D:\Project\2007Q2\斯基731320\Part 22H1x EVD0\CDMA 1xEVDO.EMI (12) Date: 2007-04-26

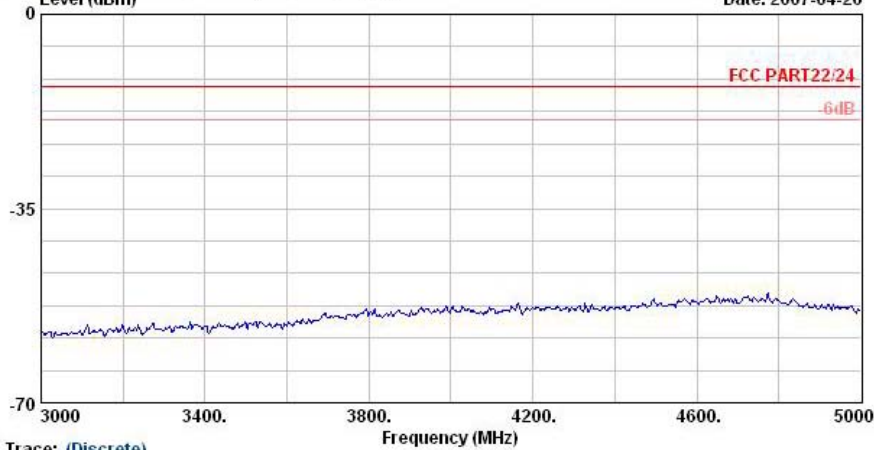

Trace: (Discrete)
 Site : 03CH06-HY
 Condition : HF-SPURIOUS HORIZONTAL
 EUT : Notebook PC
 Power : 120Vac/60Hz
 Model : FG 731320
 Memo : CDMA2000 Cellular Link;CH384+Adaptor



Data: 5 File: D:\Project\2007Q2\斯基731320\Part 22H\1xEVDO\CDMA 1xEVDO.EMI (12) Date: 2007-04-26

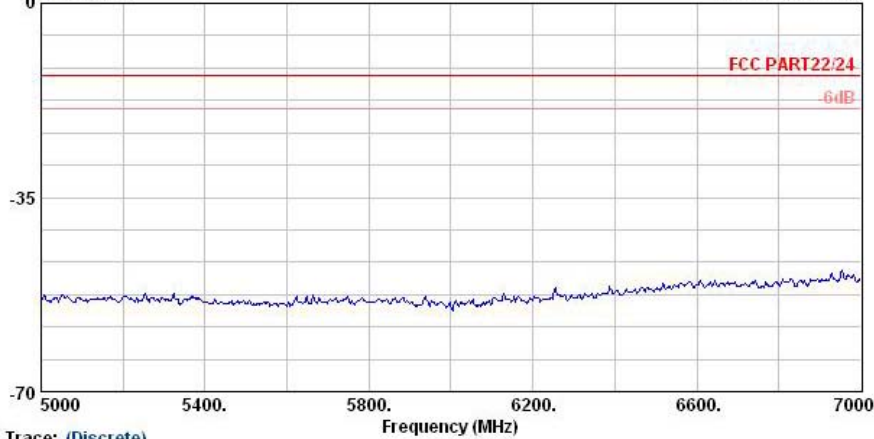

Trace: (Discrete)

Site : 03CH06-HY
Condition : HF-SPURIOUS HORIZONTAL
EUT : Notebook PC
Power : 120Vac/60Hz
Model : FG 731320
Memo : CDMA2000 Cellular Link;CH384+Adaptor

Data: 6 File: D:\Project\2007Q2\斯基731320\Part 22H\1xEVDO\CDMA 1xEVDO.EMI (12) Date: 2007-04-26

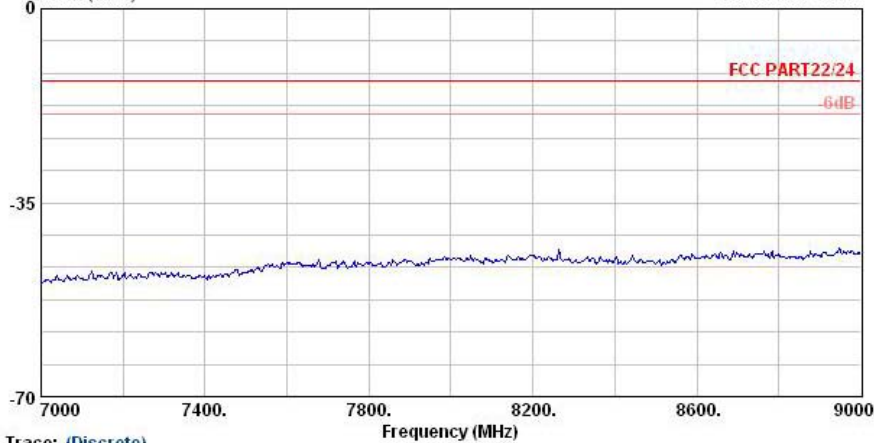

Trace: (Discrete)

Site : 03CH06-HY
Condition : HF-SPURIOUS HORIZONTAL
EUT : Notebook PC
Power : 120Vac/60Hz
Model : FG 731320
Memo : CDMA2000 Cellular Link;CH384+Adaptor

Remark: There's no more obvious spurious emission except the listings above.



Vertical Polarization

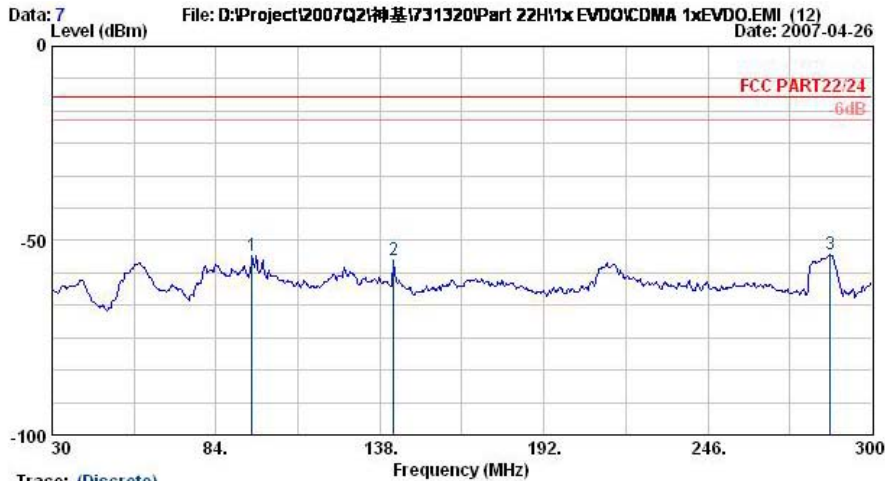

Site : 03CH06-HY
 Condition : LF-SPURIOUS VERTICAL
 EUT : Notebook PC
 Power : 120Vac/60Hz
 Model : FG 731320
 Memo : CDMA2000 Cellular Link;CH364+Adaptor

Trace: (Discrete)

	Freq	Level	Over Limit	Limit Line	Read Level	Factor	Remark
	MHz	dBm	dB	dBm	dBm	dB	
1	95.88	-53.74	-40.74	-13.00	-45.49	-8.25	Peak
2	142.59	-55.15	-42.15	-13.00	-47.08	-8.07	Peak
3	286.23	-53.62	-40.62	-13.00	-46.87	-6.75	Peak

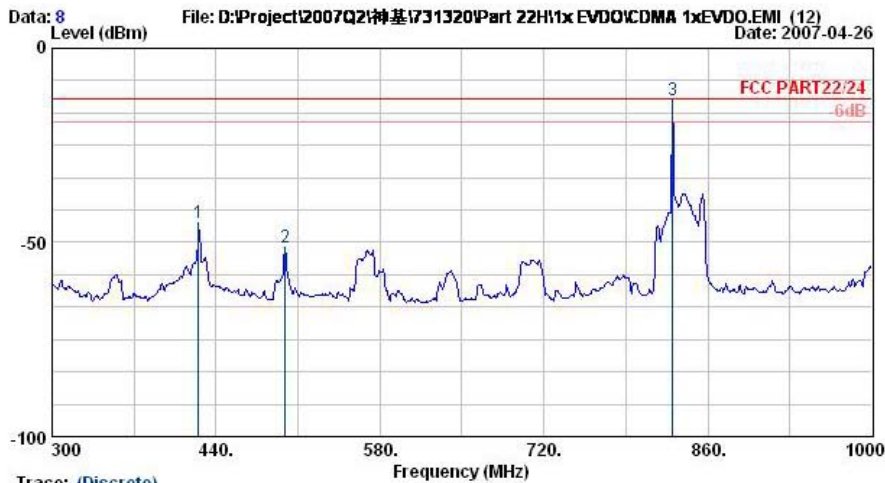

Site : 03CH06-HY
 Condition : LF-SPURIOUS VERTICAL
 EUT : Notebook PC
 Power : 120Vac/60Hz
 Model : FG 731320
 Memo : CDMA2000 Cellular Link;CH364+Adaptor

Trace: (Discrete)

	Freq	Level	Over Limit	Limit Line	Read Level	Factor	Remark
	MHz	dBm	dB	dBm	dBm	dB	
1	425.30	-44.87	-31.87	-13.00	-40.85	-4.02	Peak
2	498.80	-51.21	-38.21	-13.00	-48.06	-3.15	Peak
3 @	829.90	-13.44			-14.75	1.31	Peak

Remark:

- #3: MS Signal



FCC TEST REPORT

Report No. : FG731320

Data: 9 File: D:\Project\2007Q2\诺基亚731320\Part 22H1x EVDO\CDMA 1xEVDO.EMI (12) Date: 2007-04-26

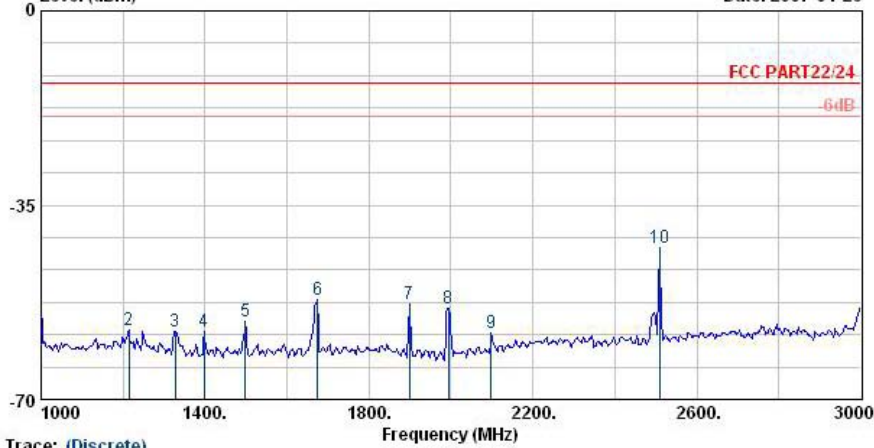

Trace: (Discrete)

Site : 03CH06-HY
 Condition : HF-SPURIOUS VERTICAL
 EUT : Notebook PC
 Power : 120Vac/60Hz
 Model : FG 731320
 Memo : CDMA2000 Cellular Link;CH384+Adaptor

	Freq	Level	Over	Limit	Read	Factor	Remark
	MHz	dBm	Limit	Line	Level	dB	
1	1000.00	-53.73	-40.73	-13.00	-52.94	-0.79	Peak
2	1214.00	-57.58	-44.58	-13.00	-56.86	-0.72	Peak
3	1328.00	-57.74	-44.74	-13.00	-56.94	-0.80	Peak
4	1398.00	-57.81	-44.81	-13.00	-56.90	-0.91	Peak
5	1498.00	-55.86	-42.86	-13.00	-55.01	-0.86	Peak
6	1674.00	-52.05	-39.05	-13.00	-51.57	-0.48	Peak
7	1898.00	-52.84	-39.84	-13.00	-52.34	-0.50	Peak
8	1994.00	-53.51	-40.51	-13.00	-52.82	-0.69	Peak
9	2098.00	-58.06	-45.06	-13.00	-58.49	0.43	Peak
10 @	2508.00	-42.60	-29.60	-13.00	-44.87	2.27	Peak

Data: 10 File: D:\Project\2007Q2\诺基亚731320\Part 22H1x EVDO\CDMA 1xEVDO.EMI (12) Date: 2007-04-26

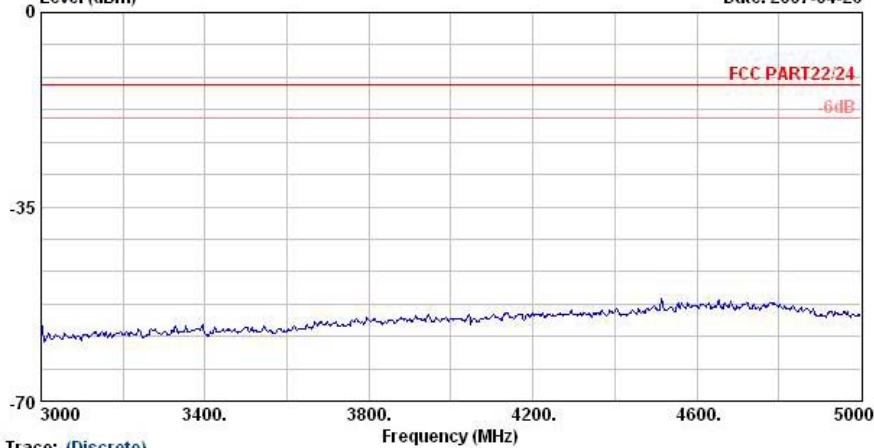

Trace: (Discrete)

Site : 03CH06-HY
 Condition : HF-SPURIOUS VERTICAL
 EUT : Notebook PC
 Power : 120Vac/60Hz
 Model : FG 731320
 Memo : CDMA2000 Cellular Link;CH384+Adaptor

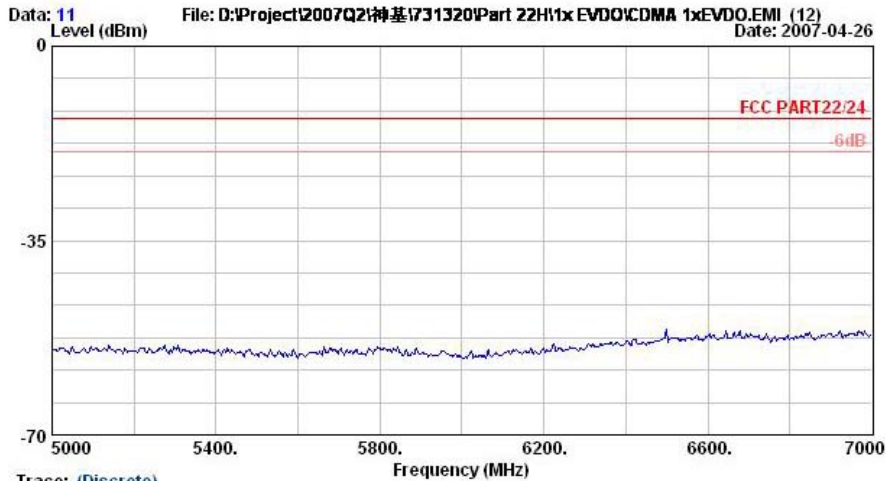

Trace: (Discrete)
Site : 03CH06-HY
Condition : HF-SPURIOUS VERTICAL
EUT : Notebook PC
Power : 120Vac/60Hz
Model : FG 731320
Memo : CDMA2000 Cellular Link;CH384+Adaptor

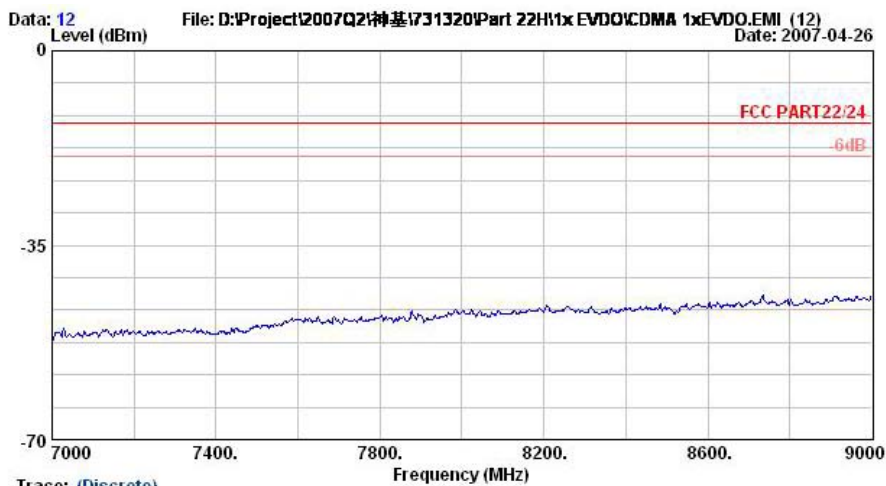

Trace: (Discrete)
Site : 03CH06-HY
Condition : HF-SPURIOUS VERTICAL
EUT : Notebook PC
Power : 120Vac/60Hz
Model : FG 731320
Memo : CDMA2000 Cellular Link;CH384+Adaptor

Remark : There is no more obvious emission except the listings above.



4.6.5.3 Mode 3
Horizontal Polarization



Trace: (Discrete)

Site : 03CH06-HY
 Condition : LF-SPURIOUS HORIZONTAL
 EUT : Notebook PC
 Power : 120Vac/60Hz
 Model : FG 731320
 Memo : CDMA2000 PCS Link;CH600+Adaptor

	Freq	Level	Over	Limit	Read	Factor	Remark
	MHz	dBm	Limit	Line	Level	dB	
1	35.13	-56.89	-43.89	-13.00	-54.20	-2.69	Peak
2	214.68	-58.03	-45.03	-13.00	-45.14	-12.89	Peak
3	287.04	-58.95	-45.95	-13.00	-48.57	-10.38	Peak

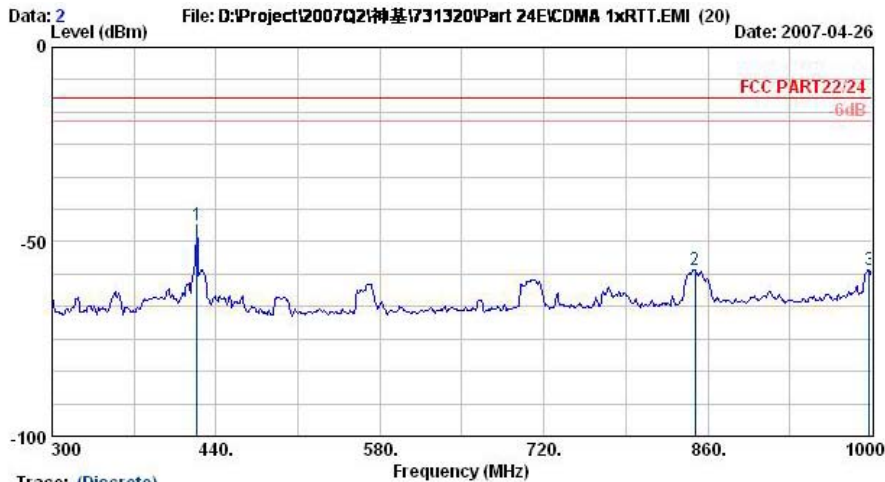

Trace: (Discrete)

Site : 03CH06-HY
 Condition : LF-SPURIOUS HORIZONTAL
 EUT : Notebook PC
 Power : 120Vac/60Hz
 Model : FG 731320
 Memo : CDMA2000 PCS Link;CH600+Adaptor

	Freq	Level	Over	Limit	Read	Factor	Remark
	MHz	dBm	Limit	Line	Level	dB	
1	423.90	-45.54	-32.54	-13.00	-39.38	-6.17	Peak
2	848.80	-57.19	-44.19	-13.00	-55.96	-1.22	Peak
3	997.90	-57.28	-44.28	-13.00	-57.50	0.22	Peak



Data: 3 File: D:\Project\2007Q2\诺基亚731320\Part 24\CDMA 1xRTT.EMI (20) Date: 2007-04-26

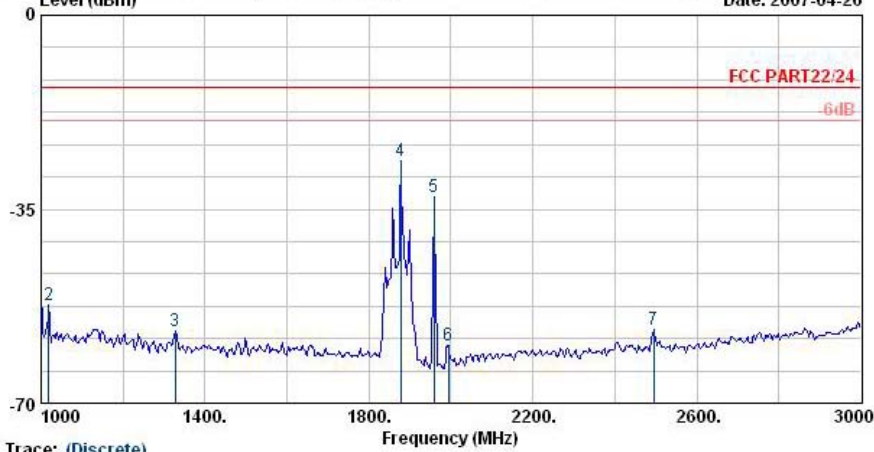

Trace: (Discrete)

Site : 03CH06-HY
 Condition : HF-SPURIOUS HORIZONTAL
 EUT : Notebook PC
 Power : 120Vac/60Hz
 Model : FG 731320
 Memo : CDMA2000 PCS Link;CH600+Adaptor

	Freq	Level	Over	Limit	Read	Factor	Remark
	MHz	dBm	Limit	Line	Level	dB	
			dB	dBm	dBm		
1	1000.00	-50.95	-37.95	-13.00	-52.75	1.80	Peak
2	1018.00	-52.32	-39.32	-13.00	-54.09	1.78	Peak
3	1328.00	-57.03	-44.03	-13.00	-57.99	0.96	Peak
4 @	1878.00	-26.28			-25.76	-0.51	Peak
5 @	1958.00	-32.79			-31.68	-1.11	Peak
6	1994.00	-59.53	-46.53	-13.00	-58.26	-1.28	Peak
7	2494.00	-56.65	-43.65	-13.00	-57.85	1.20	Peak

Remark:

- #4: MS Signal
- #5: BS Signal

Data: 4 File: D:\Project\2007Q2\诺基亚731320\Part 24\CDMA 1xRTT.EMI (20) Date: 2007-04-26

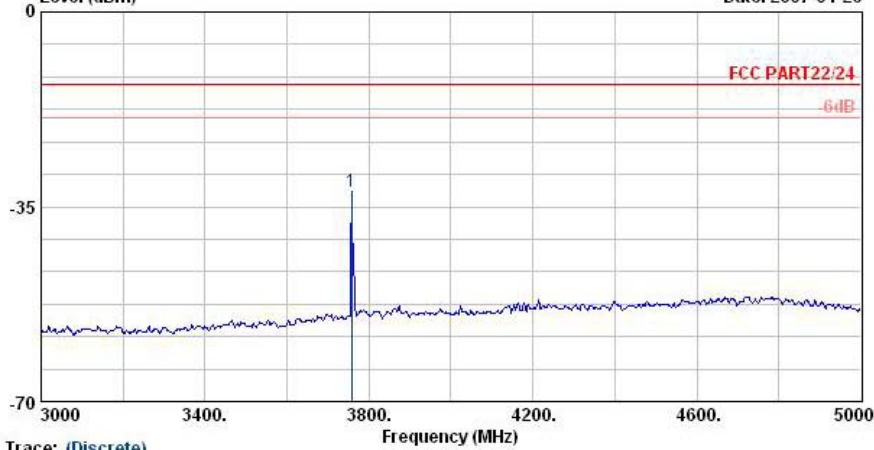

Trace: (Discrete)

Site : 03CH06-HY
 Condition : HF-SPURIOUS HORIZONTAL
 EUT : Notebook PC
 Power : 120Vac/60Hz
 Model : FG 731320
 Memo : CDMA2000 PCS Link;CH600+Adaptor

	Freq	Level	Over	Limit	Read	Factor	Remark
	MHz	dBm	Limit	Line	Level	dB	
			dB	dBm	dBm		
1 @	3758.00	-32.31	-19.31	-13.00	-40.24	7.92	Peak



Data: 5 File: D:\Project\2007Q2\神基\731320\Part 24\ECDMA 1xRTT.EMI (20) Date: 2007-04-26

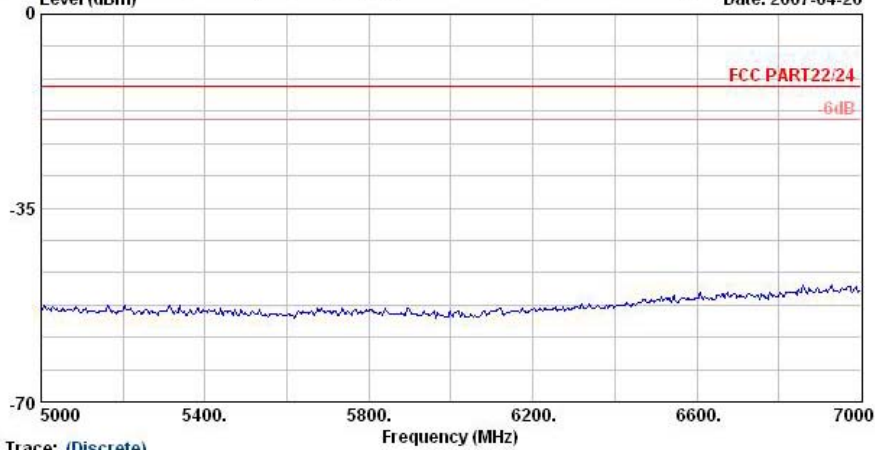

Trace: (Discrete)

Site : 03CH06-HY
Condition : HF-SPURIOUS HORIZONTAL
EUT : Notebook PC
Power : 120Vac/60Hz
Model : FG 731320
Memo : CDMA2000 PCS Link;CH600+Adaptor

Data: 6 File: D:\Project\2007Q2\神基\731320\Part 24\ECDMA 1xRTT.EMI (20) Date: 2007-04-26

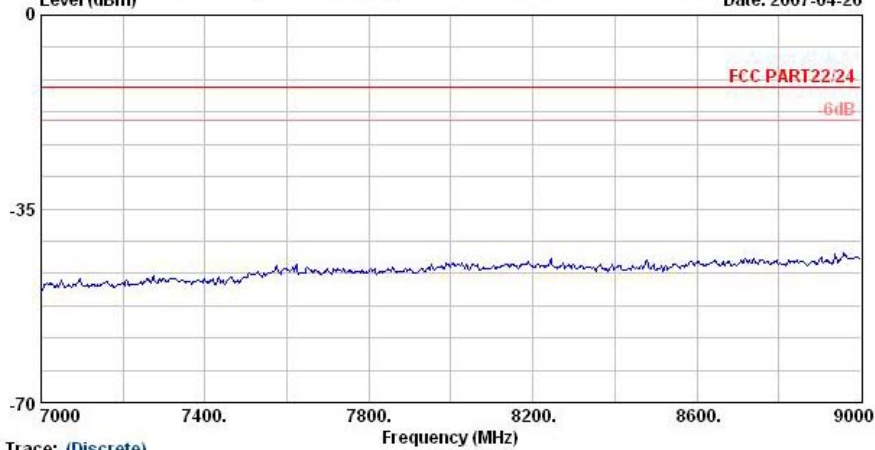

Trace: (Discrete)

Site : 03CH06-HY
Condition : HF-SPURIOUS HORIZONTAL
EUT : Notebook PC
Power : 120Vac/60Hz
Model : FG 731320
Memo : CDMA2000 PCS Link;CH600+Adaptor

Remark: There's no more obvious spurious emission except the listings above.



Vertical Polarization

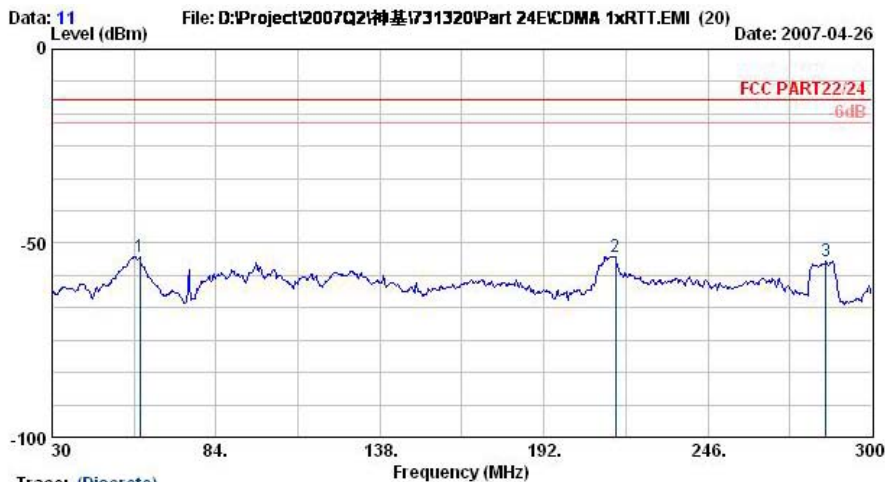

Site : 03CH06-HY
 Condition : LF-SPURIOUS VERTICAL
 EUT : Notebook PC
 Power : 120Vac/60Hz
 Model : FG 731320
 Memo :

Trace: (Discrete)

Site : 03CH06-HY
 Condition : LF-SPURIOUS VERTICAL
 EUT : Notebook PC
 Power : 120Vac/60Hz
 Model : FG 731320
 Memo : CDMA2000 PCS Link;CH600+Adaptor

	Freq	Level	Over Limit	Limit Line	Read Level	Factor	Remark
	MHz	dBm	dB	dBm	dBm	dB	
1	58.89	-53.49	-40.49	-13.00	-39.93	-13.56	Peak
2	215.49	-53.35	-40.35	-13.00	-45.09	-8.26	Peak
3	284.88	-54.53	-41.53	-13.00	-47.76	-6.77	Peak

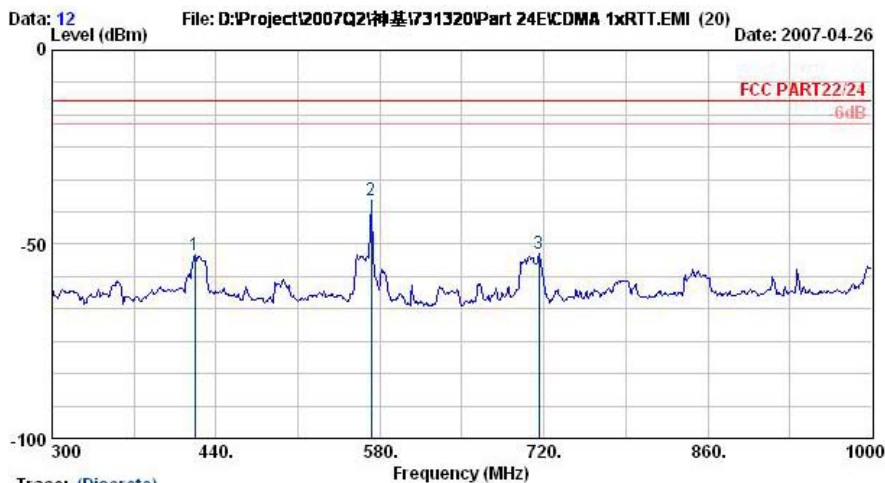

Site : 03CH06-HY
 Condition : LF-SPURIOUS VERTICAL
 EUT : Notebook PC
 Power : 120Vac/60Hz
 Model : FG 731320
 Memo :

Trace: (Discrete)

Site : 03CH06-HY
 Condition : LF-SPURIOUS VERTICAL
 EUT : Notebook PC
 Power : 120Vac/60Hz
 Model : FG 731320
 Memo : CDMA2000 PCS Link;CH600+Adaptor

	Freq	Level	Over Limit	Limit Line	Read Level	Factor	Remark
	MHz	dBm	dB	dBm	dBm	dB	
1	421.80	-52.64	-39.64	-13.00	-48.57	-4.06	Peak
2	572.30	-38.74	-25.74	-13.00	-36.47	-2.27	Peak
3	715.80	-52.38	-39.38	-13.00	-52.18	-0.20	Peak



FCC TEST REPORT

Report No. : FG731320

Data: 13 File: D:\Project\2007Q2\神基\731320\Part 24E\CDMA 1xRTT.EMI (20) Date: 2007-04-26

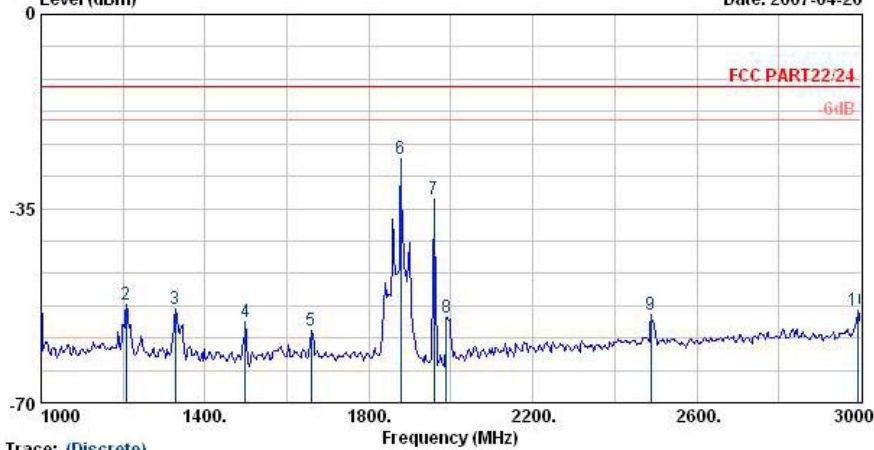

Trace: (Discrete)

Site : 03CH06-HY
 Condition : HF-SPURIOUS VERTICAL
 EUT : Notebook PC
 Power : 120Vac/60Hz
 Model : FG 731320
 Memo : CDMA2000 PCS Link;CH600+Adaptor

	Freq	Level	Over	Limit	Read	Factor	Remark
	MHz	dBm	Limit	Line	Level	dB	
1	1000.00	-51.27	-38.27	-13.00	-50.48	-0.79	Peak
2	1208.00	-52.17	-39.17	-13.00	-51.46	-0.72	Peak
3	1328.00	-53.05	-40.05	-13.00	-52.25	-0.80	Peak
4	1498.00	-55.33	-42.33	-13.00	-54.47	-0.86	Peak
5	1658.00	-57.09	-44.09	-13.00	-56.61	-0.48	Peak
6 @	1878.00	-26.11			-25.71	-0.40	Peak
7 @	1958.00	-33.27			-32.68	-0.60	Peak
8	1988.00	-54.59	-41.59	-13.00	-53.90	-0.69	Peak
9	2488.00	-54.00	-41.00	-13.00	-56.22	2.21	Peak
10	2994.00	-53.35	-40.35	-13.00	-56.74	3.39	Peak

Remark:

1. #6: MS Signal
2. #7: BS Signal

Data: 14 File: D:\Project\2007Q2\神基\731320\Part 24E\CDMA 1xRTT.EMI (20) Date: 2007-04-26

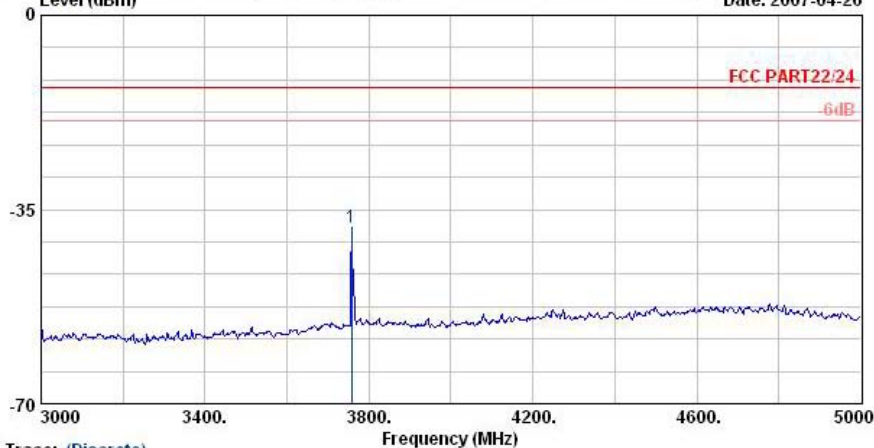

Trace: (Discrete)

Site : 03CH06-HY
 Condition : HF-SPURIOUS VERTICAL
 EUT : Notebook PC
 Power : 120Vac/60Hz
 Model : FG 731320
 Memo : CDMA2000 PCS Link;CH600+Adaptor

	Freq	Level	Over	Limit	Read	Factor	Remark
	MHz	dBm	Limit	Line	Level	dB	
1 @	3758.00	-38.13	-25.13	-13.00	-44.77	6.64	Peak

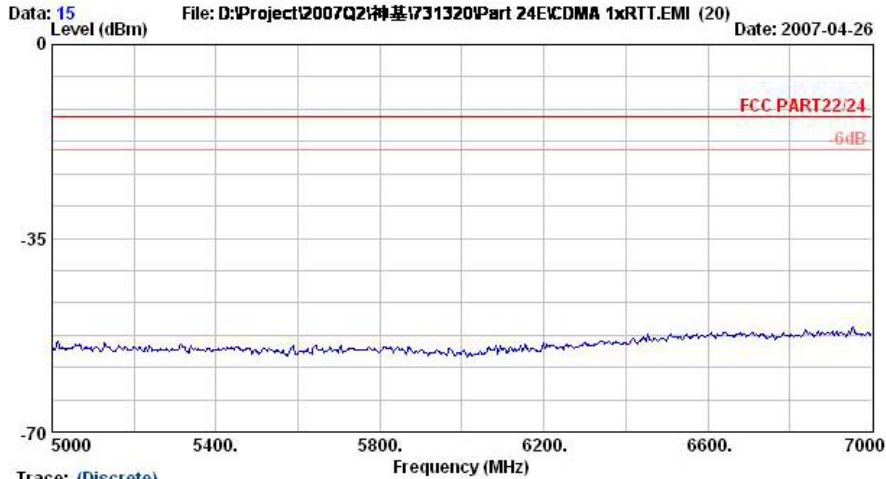

Trace: (Discrete)
Site : 03CH06-HV
Condition : HF-SPURIOUS VERTICAL
EUT : Notebook PC
Power : 120Vac/60Hz
Model : FG 731320
Memo : CDMA2000 PCS Link;CH600+Adaptor

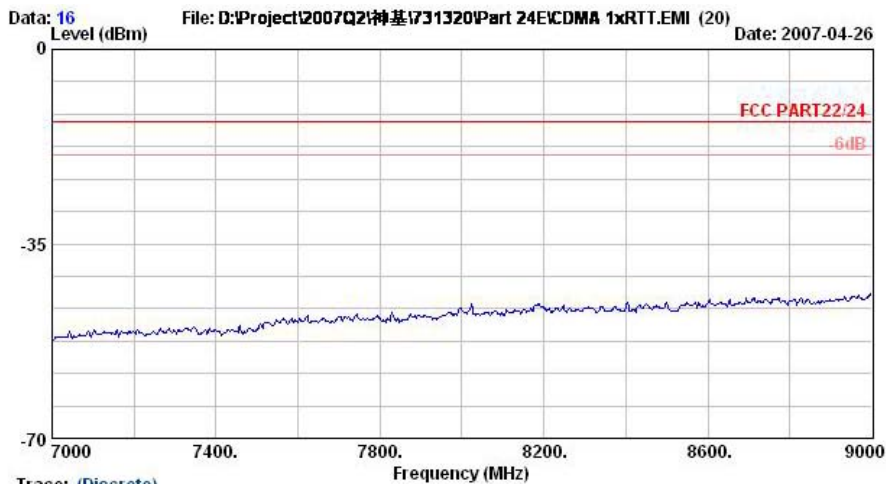

Trace: (Discrete)
Site : 03CH06-HV
Condition : HF-SPURIOUS VERTICAL
EUT : Notebook PC
Power : 120Vac/60Hz
Model : FG 731320
Memo : CDMA2000 PCS Link;CH600+Adaptor

Remark : There is no more obvious emission except the listings above.



4.6.5.4 Mode 4
Horizontal Polarization

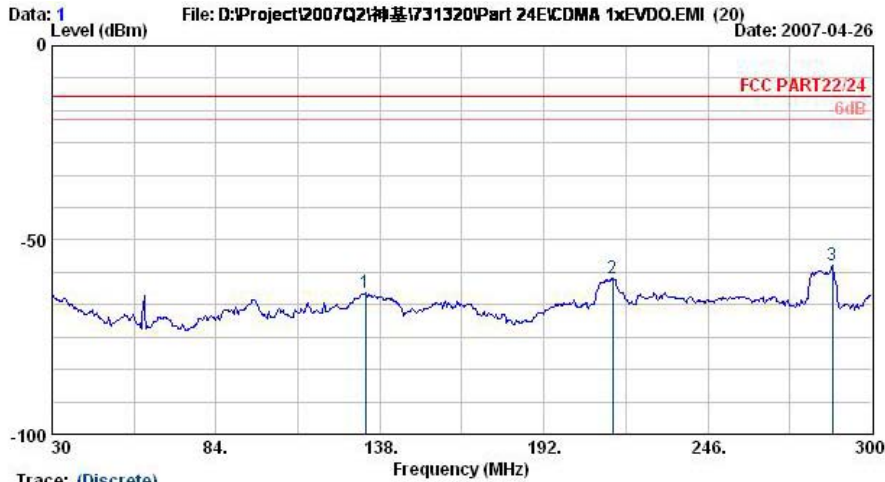

Site : 03CH06-HY
 Condition : LP-SPURIOUS HORIZONTAL
 EUT : Notebook PC
 Power : 120Vac/60Hz
 Model : FG 731320
 Memo :

Trace: (Discrete)

	Freq	Level	Over	Limit	Read	
	MHz	dBm	Limit	Line	Level	Factor Remark
			dB	dBm	dBm	dB
1 @	133.14	-63.70	-50.70	-13.00	-51.08	-12.62 Peak
2 @	214.68	-59.84	-46.84	-13.00	-46.95	-12.89 Peak
3 @	287.04	-56.50	-43.50	-13.00	-46.12	-10.38 Peak

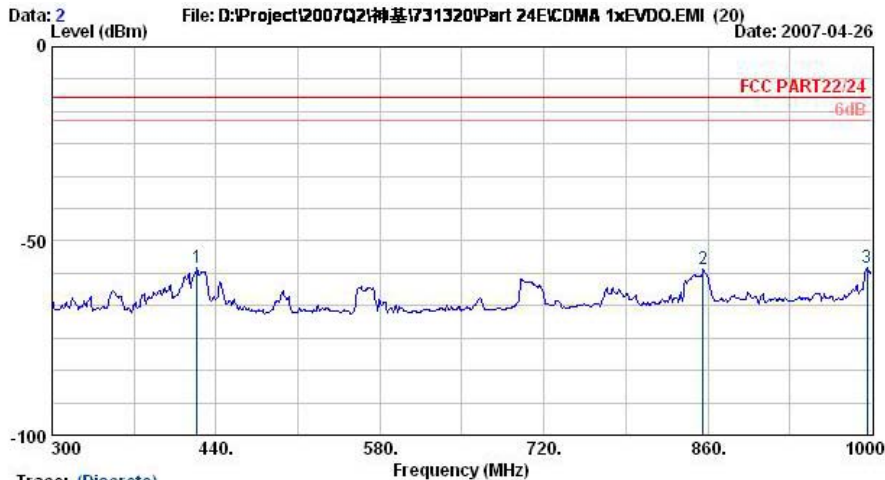

Site : 03CH06-HY
 Condition : LP-SPURIOUS HORIZONTAL
 EUT : Notebook PC
 Power : 120Vac/60Hz
 Model : FG 731320
 Memo :

Trace: (Discrete)

	Freq	Level	Over	Limit	Read	
	MHz	dBm	Limit	Line	Level	Factor Remark
			dB	dBm	dBm	dB
1 @	423.90	-57.04	-44.04	-13.00	-50.88	-6.17 Peak
2 @	855.80	-57.24	-44.24	-13.00	-56.09	-1.16 Peak
3 @	995.80	-56.75	-43.75	-13.00	-56.96	0.20 Peak



Data: 3 File: D:\Project\2007Q2\#基731320\Part 24\CDMA 1xEVDO.EMI (20) Date: 2007-04-26

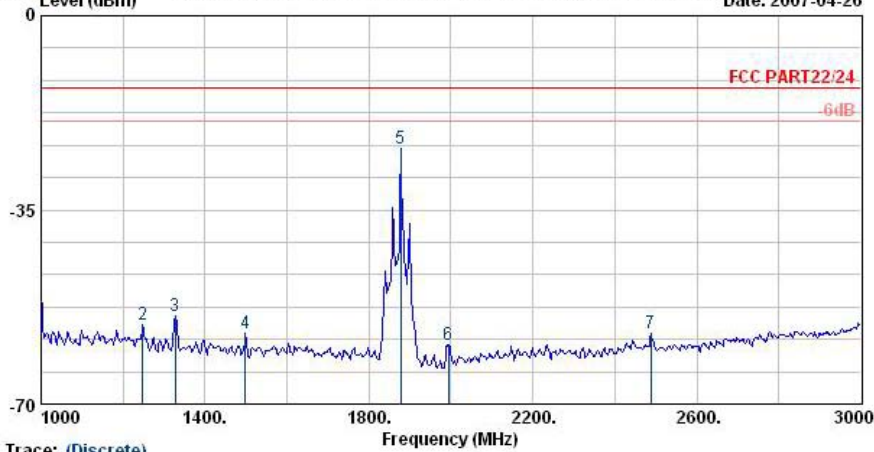

Trace: (Discrete)

Site : 03CH06-HY
 Condition : HF-SPURIOUS HORIZONTAL
 EUT : Notebook PC
 Power : 120Vac/60Hz
 Model : FG 731320
 Memo : CDMA2000 PCS Link;CH600+Adaptor

	Freq	Level	Over	Limit	Read	Factor	Remark
	MHz	dBm	Limit	Line	Level	dB	
1 @	1000.00	-49.96	-36.96	-13.00	-51.77	1.80	Peak
2 @	1248.00	-55.69	-42.69	-13.00	-56.89	1.20	Peak
3 @	1328.00	-54.19	-41.19	-13.00	-55.15	0.96	Peak
4 @	1498.00	-57.22	-44.22	-13.00	-57.67	0.45	Peak
5 @	1878.00	-23.93			-23.42	-0.51	Peak
6 @	1994.00	-59.35			-58.07	-1.28	Peak
7 @	2488.00	-57.16	-44.16	-13.00	-58.32	1.16	Peak

Remark:

- #5: MS Signal
- #6: BS Signal

Data: 4 File: D:\Project\2007Q2\#基731320\Part 24\CDMA 1xEVDO.EMI (20) Date: 2007-04-26

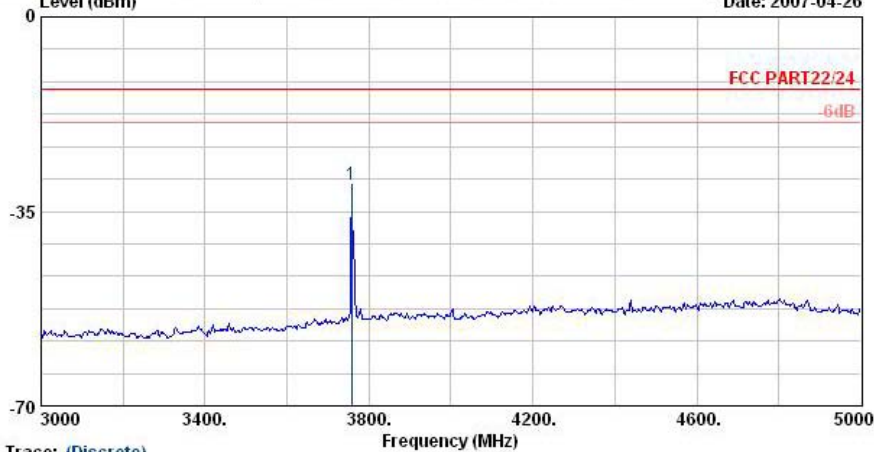

Trace: (Discrete)

Site : 03CH06-HY
 Condition : HF-SPURIOUS HORIZONTAL
 EUT : Notebook PC
 Power : 120Vac/60Hz
 Model : FG 731320
 Memo : CDMA2000 PCS Link;CH600+Adaptor

	Freq	Level	Over	Limit	Read	Factor	Remark
	MHz	dBm	Limit	Line	Level	dB	
1 @	3758.00	-30.31	-17.31	-13.00	-38.23	7.92	Peak



Data: 5 File: D:\Project\2007Q2\诺基亚731320\Part 24E\CDMA 1xEVDO.EMI (20) Date: 2007-04-26

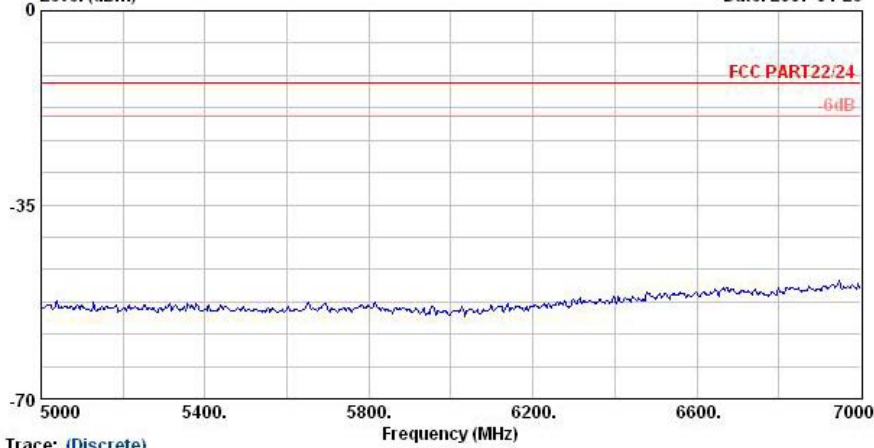

Trace: (Discrete)
Site : 03CH06-HY
Condition : HF-SPURIOUS HORIZONTAL
EUT : Notebook PC
Power : 120Vac/60Hz
Model : FG 731320
Memo : CDMA2000 PCS Link;CH600+Adaptor

Data: 6 File: D:\Project\2007Q2\诺基亚731320\Part 24E\CDMA 1xEVDO.EMI (20) Date: 2007-04-26

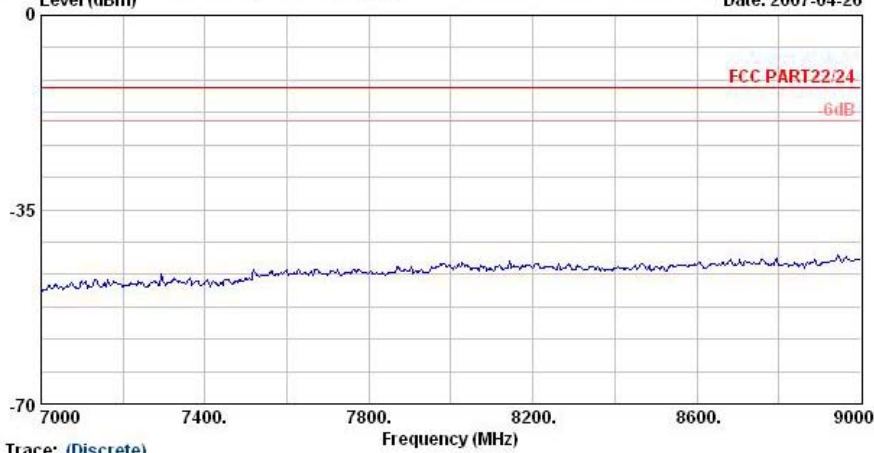

Trace: (Discrete)
Site : 03CH06-HY
Condition : HF-SPURIOUS HORIZONTAL
EUT : Notebook PC
Power : 120Vac/60Hz
Model : FG 731320
Memo : CDMA2000 PCS Link;CH600+Adaptor

Remark: There's no more obvious spurious emission except the listings above.