

# MODEL : IP52 Keyboard Revision 01

## Contexts

| Title                       | Page |
|-----------------------------|------|
| Cover Sheet                 | 1    |
| IP52 Keyboard Block Diagram | 2    |
| Charger Ckt                 | 3    |
| Power Ckt                   | 4    |
| FSR Ckt                     | 5    |
| KEYBOARD CKT                | 6 7  |

## History of Schematics Revision 00 (EVT)

### Charger Ckt

PCB:PWA-CA25,IP52 KB FNKEY BD 316-1200-0026  
PWA:PWA-CA25,IP52 KB FNKEY BD 411-1200-0066

### Power Ckt

PCB:PWA-CA25,IP52 KB POWER BD 316-1200-0035  
PWA:PWA-CA25,IP52 KB POWER BD 411-1200-00163

### FSR Ckt

PCB:PWA-CA25,IP52 KB FSR BD 316-1200-0036  
PCB:PWA-CA25,IP52 KB FSR BD 411-1200-00160

### KEYBOARD CKT

PCB:PWA-CA25,IP52 KEYBOARD  
SD 31612000025  
PWB:PWA-CA25,IP52 KEYBOARD  
SD:41112000064

| DRAW | DESIGN | CHECK | ISSUED |
|------|--------|-------|--------|
|      |        |       |        |

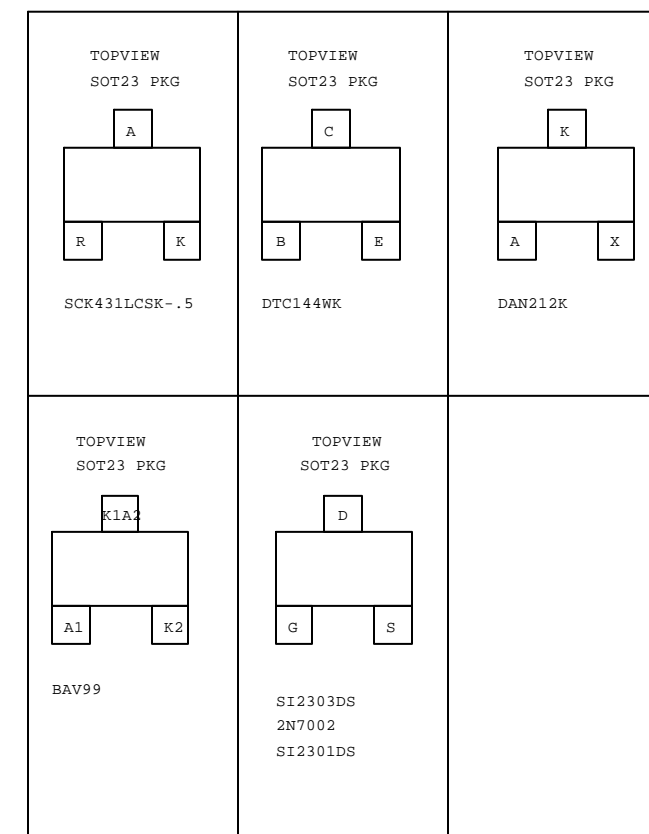

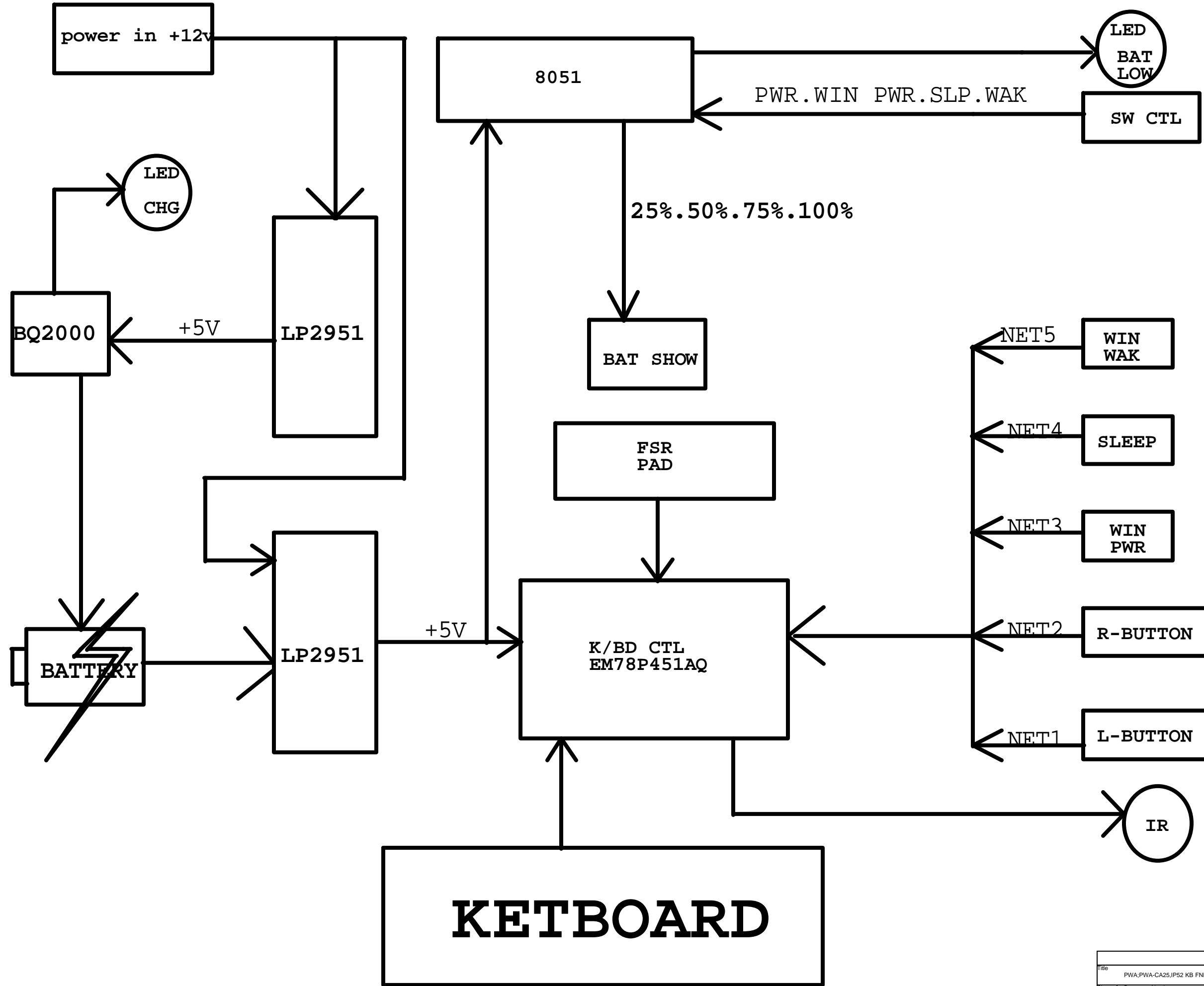

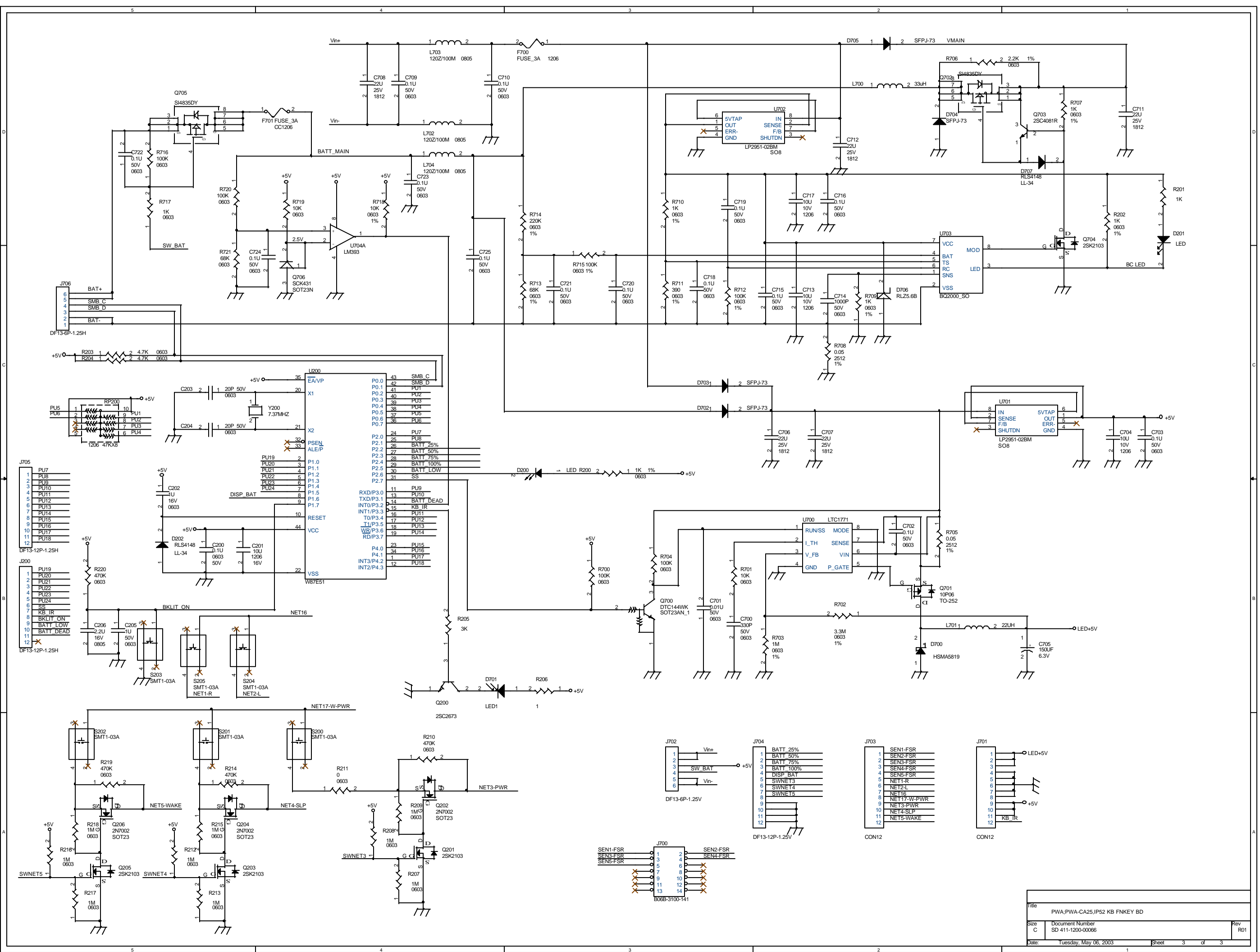

|       |                       |       |                               |
|-------|-----------------------|-------|-------------------------------|
| Title |                       |       | PWA-PWA-CA25.IP52 KB FNKEY BD |
| Size  | Document Number       | Rev   |                               |
| C     | SD 411-1200-00066     | R01   |                               |
| Date: | Tuesday, May 06, 2003 | Sheet | 3 of 3                        |

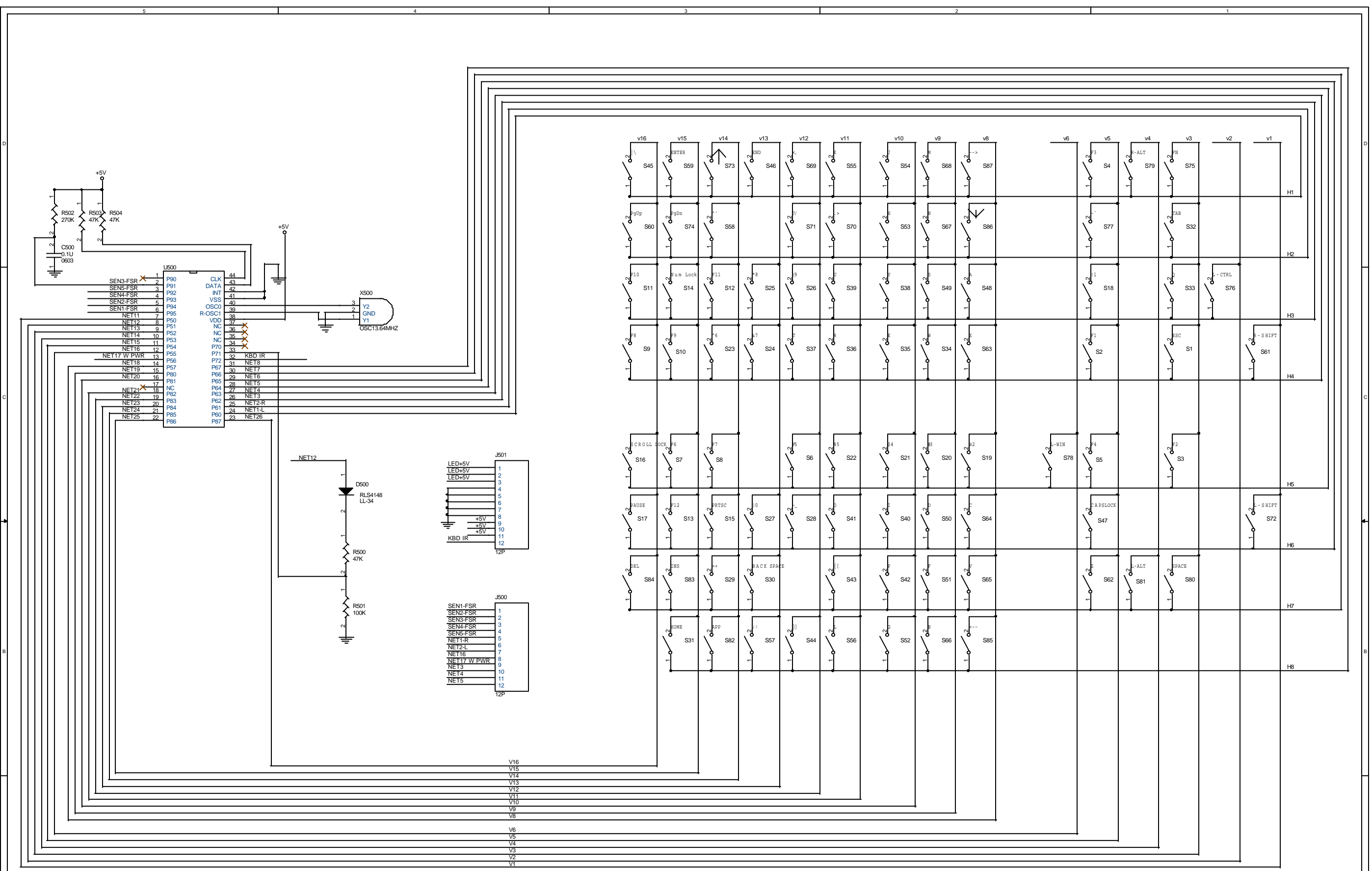

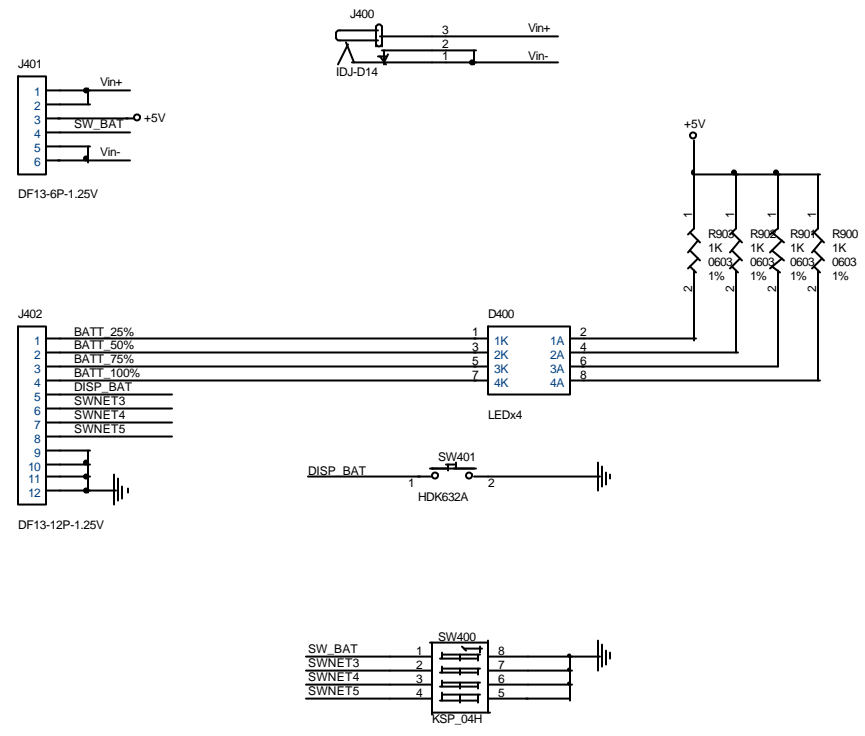

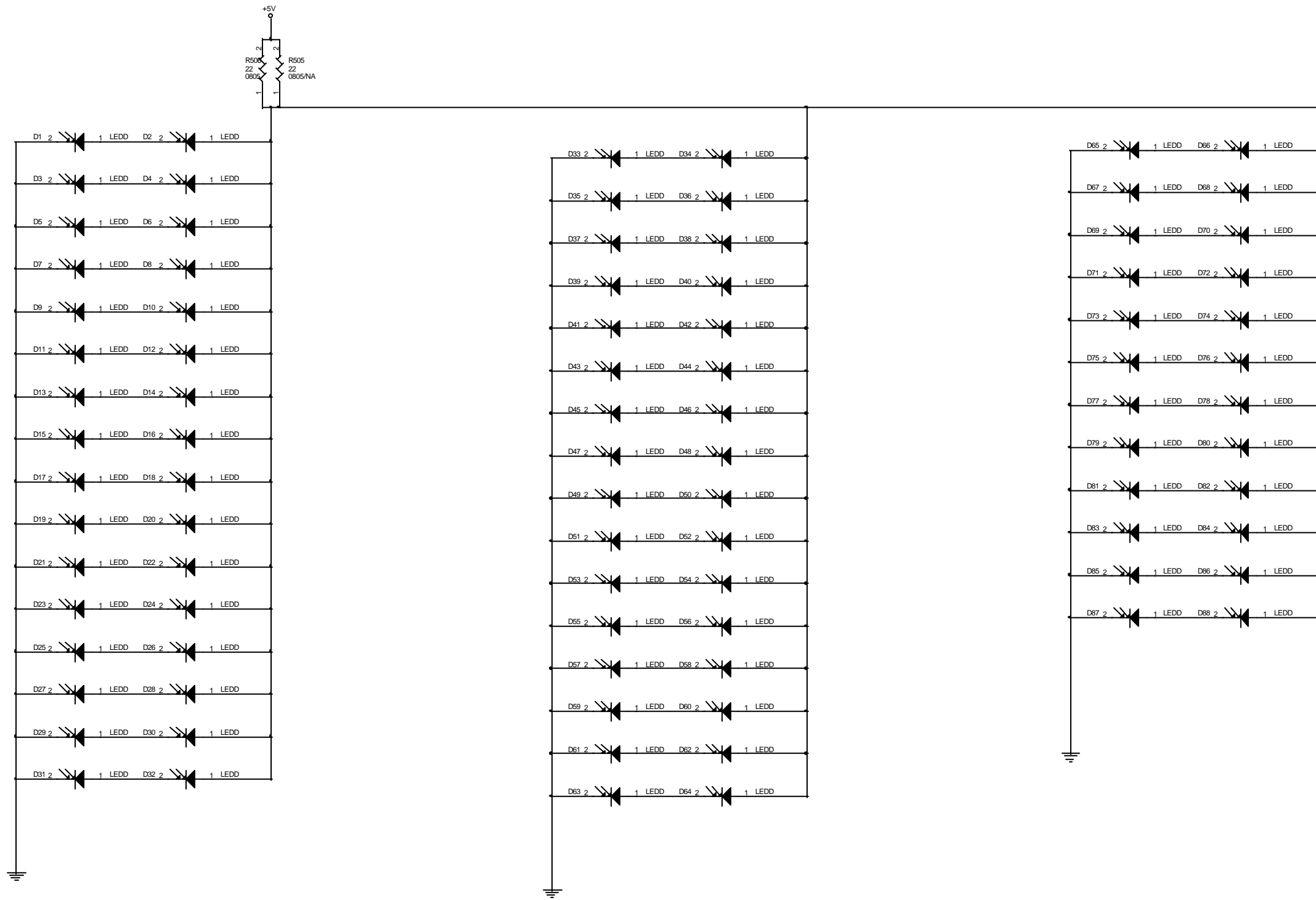

|                            |                 |              |
|----------------------------|-----------------|--------------|
| Title                      |                 |              |
| PWA:PWA-CA25.JP52 KEYBOARD |                 |              |
| Size                       | Document Number | Rev          |
| C                          | SD:411120000064 | R01          |
| Date:                      | 2003/03/31      | Sheet 4 of 4 |

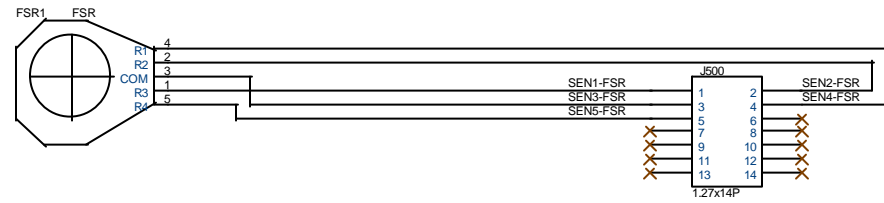

|                             |                       |              |
|-----------------------------|-----------------------|--------------|
| Title                       |                       |              |
| PWA-PWA-CA25.IP52 KB FSR BD |                       |              |
| Size                        | Document Number       | Rev          |
| C                           | SD 411-1200-00160     | R01          |
| Date:                       | Tuesday, May 06, 2003 | Sheet 5 of 5 |