



*Getac*



V100  
USER'S MANUAL

Aug. 2012

**TRADEMARKS**

All brand and product names are trademarks or registered trademarks of their respective companies.



**NOTE**

The information in this manual is subject to change without notice.

For the latest version of the manual, please visit the Getac website at [www.getac.com](http://www.getac.com).



ENERGY STAR® is a government program that offers businesses and consumers energy-efficient solutions, making it easy to save money while protecting the environment for future generations.

Please reference ENERGY STAR® related information from [www.energystar.gov](http://www.energystar.gov).

As an ENERGY STAR® Partner, Getac Technology Corporation has determined that this product meets the ENERGY STAR® guidelines for energy efficiency.

An ENERGY STAR® qualified computer uses 70 % less electricity than computers without enabled power management features.

**Earning the ENERGY STAR®**

- When every home office is powered by equipment that has earned the ENERGY STAR®, the change will keep over 289 billion pounds of greenhouse gases out of the air.
- If left inactive, ENERGY STAR® qualified computers enter a low-power mode and may use 15 watts or less. New chip technologies make power management features more reliable, dependable, and user-friendly than even just a few years ago.

- Spending a large portion of time in low-power mode not only saves energy, but helps equipment run cooler and last longer.
- Businesses that use ENERGY STAR® enabled office equipment may realize additional savings on air conditioning and maintenance.
- Over its lifetime, ENERGY STAR® qualified equipment in a single home office (e.g., computer, monitor, printer, and fax) can save enough electricity to light an entire home for more than 4 years.
- Power management (“sleep settings”) on computers and monitors can result in much savings annually.

### **Remember, saving energy prevents pollution**

Because most computer equipment is left on 24 hours a day, power management features are important for saving energy and are an easy way to reduce air pollution. By using less energy, these products help lower consumers’ utility bills, and prevent greenhouse gas emissions.



# Table of Contents

<b>Chapter 1 Getting Started .....</b>	<b>1-1</b>
Getting the Computer Running .....	1-2
Unpacking .....	1-2
Connecting to AC Power.....	1-3
Opening and Closing the Cover .....	1-4
Operating in Tablet Mode.....	1-6
Turning On and Off the Computer.....	1-8
Taking a Look at the Computer.....	1-10
Front Components .....	1-10
Rear Components .....	1-12
Right-Side Components.....	1-13
Left-Side Components .....	1-14
Top-open Components.....	1-15
Bottom Components.....	1-17
Using Accessories .....	1-19
Using the Tether .....	1-19
Attaching the Handgrip Strap .....	1-20
Attaching the Shoulder Strap.....	1-20
<b>Chapter 2 Operating Your Computer.....</b>	<b>2-1</b>
Using the Internal Keyboard .....	2-2
Typewriter Keys.....	2-2

Cursor-Control Keys.....	2-2
Numeric Keypad.....	2-3
Function Keys.....	2-4
Fn Key.....	2-4
Hot Keys.....	2-4
Using the Touchpad.....	2-6
Configuring the Touchpad.....	2-8
Navigating on the Screen.....	2-9
Using the Touchscreen.....	2-9
Using Multi-touch Gestures.....	2-10
Using the Dual Mode Display (Optional).....	2-12
Using Landscape or Portrait View.....	2-14
Using the Input Panel.....	2-16
Using the Network Features.....	2-17
Using the Modem.....	2-17
Using the LAN.....	2-18
Using the Wireless LAN.....	2-18
Using the Bluetooth Feature.....	2-21
Turning Off/On the Bluetooth Radio.....	2-21
Connecting to another Bluetooth Device.....	2-21
Using the WWAN Feature (Optional).....	2-23
Installing a SIM Card.....	2-23
Turning Off/On the WWAN Radio.....	2-24
Connecting to WWAN Network.....	2-25
Using the Fingerprint Scanner (Optional).....	2-27
<b>Chapter 3 Managing Power.....</b>	<b>3-1</b>
AC Adapter.....	3-2
Battery Pack.....	3-3
Charging the Battery Pack.....	3-3



Initializing the Battery Pack.....	3-4
Checking the Battery Level.....	3-4
Replacing the Battery Pack .....	3-5
Battery Low Signals and Actions .....	3-7
Power Management.....	3-9
Hibernation .....	3-10
Power-Saving Tips .....	3-11

## **Chapter 4 Expanding Your Computer ..... 4-1**

Connecting an External Monitor.....	4-2
Connecting a Serial Device .....	4-3
Connecting a USB Device .....	4-4
Connecting an IEEE 1394 Device .....	4-5
Connecting Audio Devices.....	4-6
Using ExpressCards.....	4-7
Using PC Cards .....	4-9
Using Smart Cards (Optional) .....	4-11
Using SD Cards .....	4-12
System Memory Upgrade .....	4-13

## **Chapter 5 Using BIOS Setup and System Recovery... 5-1**

BIOS Setup.....	5-2
When and How to Use.....	5-2
Information Menu .....	5-3
Main Menu.....	5-4
Advanced Menu.....	5-5
Security Menu.....	5-12
Boot Menu .....	5-14
Exit Menu .....	5-16
System Recovery.....	5-17

**Chapter 6 Using Getac Software ..... 6-1**

Using the OSD Control Panel ..... 6-2

- Quick Button Setup ..... 6-6

Using Button Manager ..... 6-8

Using G-Manager ..... 6-10

- Starting G-Manager ..... 6-10
- System Tab ..... 6-11
- Battery Tab ..... 6-12
- ECO Tab ..... 6-14
- ECO Information ..... 6-15
- Light Sensor Tab ..... 6-16
- Antenna Tab ..... 6-18
- Ignition Tab ..... 6-18
- Monitoring Tab ..... 6-19
- GPS Status Tab ..... 6-21

Using Getac Camera ..... 6-23

- Taking Pictures ..... 6-25
- Shooting Videos ..... 6-27
- Using View Mode ..... 6-29
- Camera Settings ..... 6-33

**Chapter 7 Caring for the Computer ..... 7-1**

Protecting the Computer ..... 7-2

- Using an Anti-Virus Strategy ..... 7-2
- Using Action Center (for Windows 7) ..... 7-2
- Using the Cable Lock ..... 7-3

Taking Care of the Computer ..... 7-4

- Location Guidelines ..... 7-4
- General Guidelines ..... 7-5
- Cleaning Guidelines ..... 7-5



Battery Pack Guidelines .....	7-6
Touchscreen Guidelines.....	7-7
When Traveling.....	7-9
<b>Chapter 8 Troubleshooting.....</b>	<b>8-1</b>
Preliminary Checklist .....	8-2
Solving Common Problems.....	8-3
Battery Problems .....	8-3
Bluetooth Problems.....	8-3
Display Problems.....	8-4
Hardware Device Problems.....	8-5
Hard Disk Drive Problems.....	8-5
Keyboard, Mouse, and Touchpad Problems .....	8-6
LAN Problems.....	8-6
Power Management Problems.....	8-7
Software Problems .....	8-7
Sound Problems .....	8-8
Startup Problems .....	8-8
WLAN Problems .....	8-9
Other Problems .....	8-11
Resetting the Computer .....	8-12
<b>Appendix A Specifications.....</b>	<b>A-1</b>
<b>Appendix B Regulatory Information.....</b>	<b>B-1</b>
On the Use of the System.....	B-2
Class B Regulations.....	B-2
Safety Notices.....	B-3
On the Use of the RF Device .....	B-7
USA and Canada Safety Requirements and Notices .....	B-7
European Union CE Marking and Compliance Notices ...	B-10



## Chapter 1

# Getting Started

Congratulations on purchasing this rugged computer.

This chapter first tells you step by step how to get the computer up and running. Then, you will find a section briefly introducing the external components of the computer.

# Getting the Computer Running

This section guides you through the procedures for getting the computer ready for operation.

## Unpacking

After unpacking the shipping carton, you should find these standard items:

- Notebook computer
- Accessories:
  - AC adapter
  - AC power cord
  - Shoulder strap
  - Handgrip strap
  - Stylus and tether
  - Digitizer pen (option)
  - Driver disc
  - Documents

Inspect all the items. If any item is damaged or missing, notify your dealer immediately.

Keep the shipping carton and packing materials in case you need to ship or store the computer in the future.

## Connecting to AC Power

The computer operates either on the external AC power or internal battery power. It is suggested that you use AC power when you start up the computer for the very first time.

**CAUTION:** Use only the AC adapter included with your computer. Using other AC adapters may damage the computer.

1. Plug the DC cord of the AC adapter to the power connector of the computer (❶).
2. Plug the female end of the AC power cord to the AC adapter and the male end to an electrical outlet (❷).

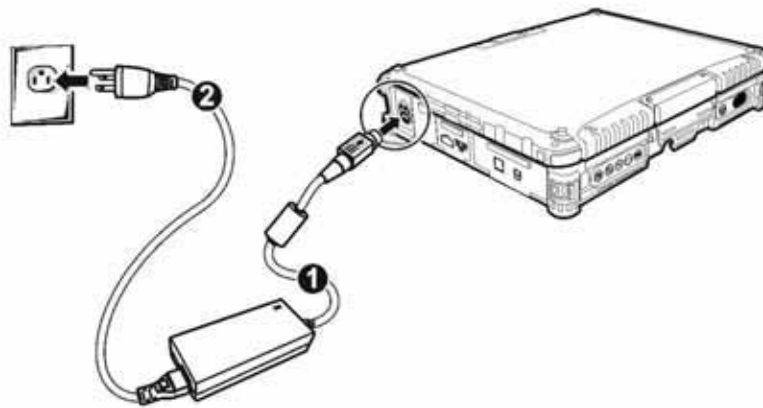

3. When the AC adapter is connected, power is being supplied from the electrical outlet to the AC adapter and onto your computer. Now, you are ready to turn on the computer.

**CAUTION:**

- When you disconnect the AC adapter, disconnect from the electrical outlet first and then from the computer. A reverse procedure may damage the AC adapter or the computer.
- When unplugging the connector, always hold the plug head. Never pull on the cord.

**NOTE:** When the AC adapter is connected, it also charges the battery pack. For information on using battery power, see Chapter 3.

## Opening and Closing the Cover

Open the top cover by pulling up on latch A and releasing latch B (❶) and lifting up the cover (❷). You can tilt the cover forward or backward for optimal viewing clarity.

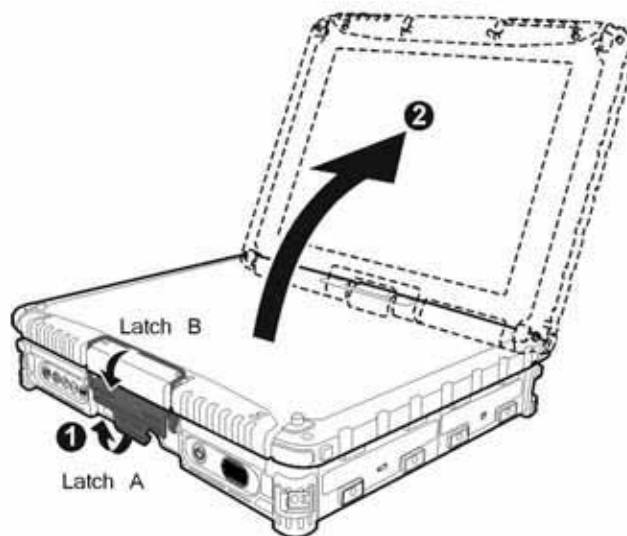

Close the top cover by closing the display (1). Then position latch B on the display side and bring latch A down (2) to fix the display in place.

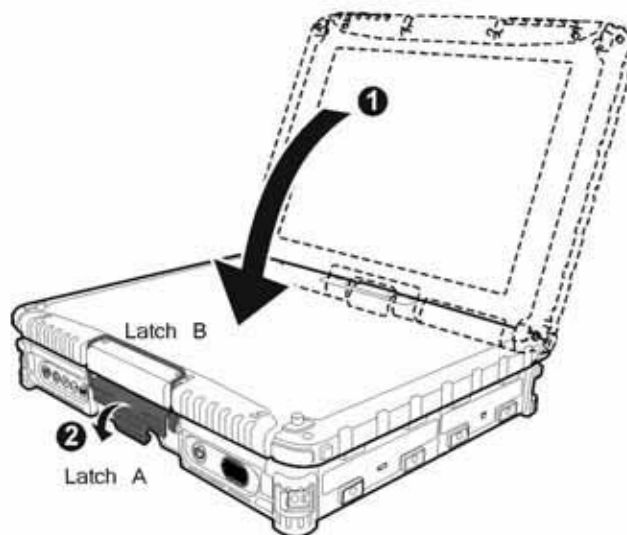

## Operating in Tablet Mode

In addition to being used as a regular notebook computer (Laptop mode), your computer can also be operated in Tablet mode. In Tablet mode, you operate the computer with a stylus or digitizer pen, or a fingertip, instead of a keyboard or mouse.

1. Open the top cover so that it is almost perpendicular with the keyboard of the computer.
2. Turn the display counter-clockwise by 165°.





**CAUTION:** Do not rotate the display more than 165°, or attempt to rotate the display clockwise.

3. Close the computer with the display facing up (❶). Then pull up on the latch A.
4. Position the latch B on the display side, then bring latch A down (❷) to fix the display in place.

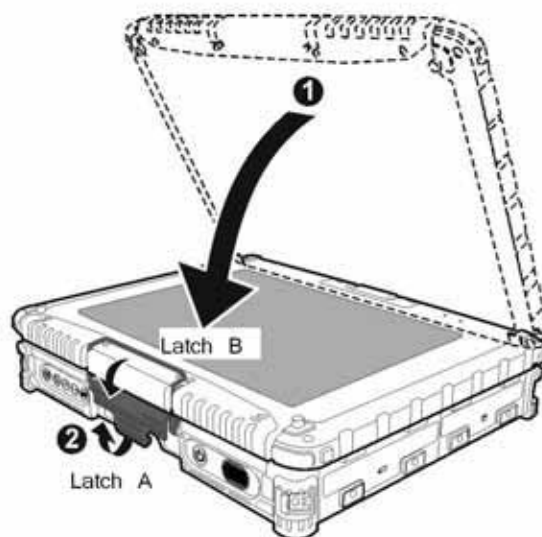

In Tablet mode, the computer can be operated while holding it as shown. A handgrip strap is supplied to help you hold the computer. (See “Attaching the Handgrip Strap” in this chapter for installation instructions.)



## Turning On and Off the Computer

### Turning On

Press the power button (  ). Each time the computer is turned on, it performs a Power-On Self Test (POST), and the operating system such as Windows should start.

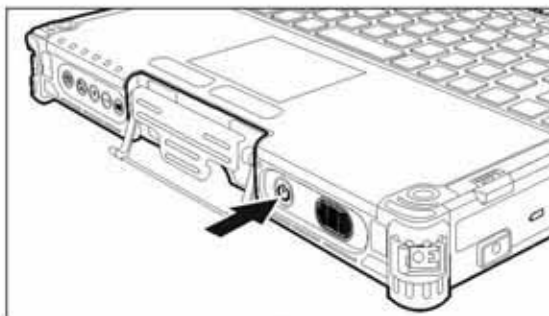

### Turning Off

When you finish a working session, you can stop the system by turning off the power or leaving it in Sleep or Hibernation mode:

To...	Do this...
Power off (Shutdown)	Use the Windows Start menu in the lower left and follow the shutdown procedure.
Sleep	Press the power button*. —or— Use the Windows Start menu to put the computer in Sleep mode.
Hibernate	Use the Windows Start menu to put the computer in Hibernation mode. (See “Hibernation” in Chapter 3 for more information.)

\* “Sleep” is the default setting of the power button. You may change what the power button does in Windows Control Panel.



## Taking a Look at the Computer



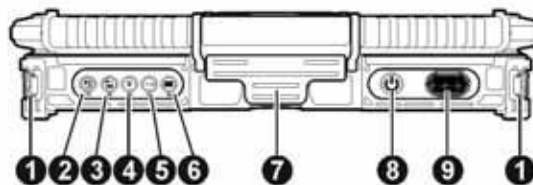

**NOTE:** Depending on the model you purchased, the appearance of your computer may not be exactly the same as those shown in this manual.

**CAUTION:** You need to open the protective covers to access the connectors or devices inside. When not accessing a connector or device, make sure to close the cover completely for water-, dust-, and fire-proof integrity of your computer. (Engage the locking mechanism if existing.)

### Front Components





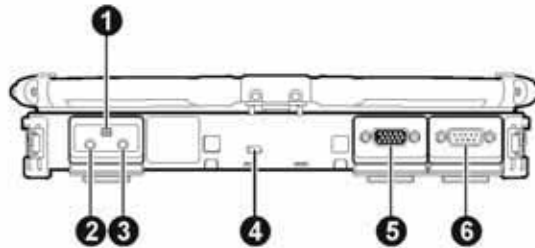

Ref	Component	Description	See Also
❶	<b>Strap Holder</b>	Two buckles hold the shoulder strap.	P. 1-20
❷	<b>OSD Control Button</b> 	Opens or closes the OSD (On Screen Display) control panel.	P. 6-2
	<b>P1 Button</b>	Can be re-defined using the Button Manager utility.	P. 6-8
❸	<b>Sunlight-readable Button</b> 	Toggles the sunlight-readable mode on or off. In sunlight-readable mode, the display brightness is increased to the highest level.	

Ref	Component	Description	See Also
		<b>CAUTION:</b> To prevent burns to your fingers if using the computer (especially in Tablet Mode) with sunlight-readable mode turned on, do wear gloves when touching the top portion of the LCD display as it may be hot to the touch.	
	<b>P2 Button</b>	Can be re-defined using the Button Manager utility.	P. 6-8
<b>4</b>	<b>RF Button</b> 	Serves as the master on/off control of the RF radio.	
	<b>P3 Button</b>	Can be re-defined using the Button Manager utility.	P. 6-8
<b>5</b>	<b>Reset Button</b> 	Serves as the <b>Ctrl+Alt+Del</b> keyboard keys.	P. 8-12
	<b>P4 Button</b>	Can be re-defined using the Button Manager utility.	P. 6-8
<b>6</b>	<b>Software Keyboard Button</b> 	Opens or closes the software keyboard on your screen.	P. 2-16
	<b>P5 Button</b>	Can be re-defined using the Button Manager utility.	P. 6-8
<b>7</b>	<b>Top Cover Latch</b>	Locks the top cover.	P. 1-4
<b>8</b>	<b>Power Button</b> 	Turns the power on or off (Sleep mode by default).	P. 1-8
<b>9</b>	<b>Speaker</b>	Sends out sound and voice from your computer.	



## Rear Components



Ref	Component	Description	See Also
❶	<b>Mini IEEE 1394 Port</b>	Connects an IEEE 1394 device such as a scanner, printer, DVCAM, and VCR.	P. 4-5
❷	<b>Audio Output Connector</b> 	Connects a set of headphones, external speakers with amplifier, or an audio recording device.	P. 4-6
❸	<b>Microphone Connector</b> 	Connects an external microphone.	P. 4-6
❹	<b>Kensington Lock</b>	Locks the computer to a stationary object for security.	P. 7-3
❺	<b>VGA Connector</b> 	Connects an external display monitor. (Depending on your model, this port could be a serial connector.)	P. 4-2
❻	<b>Serial Connector</b> 	Connects a serial mouse or serial communication device.	P. 4-3

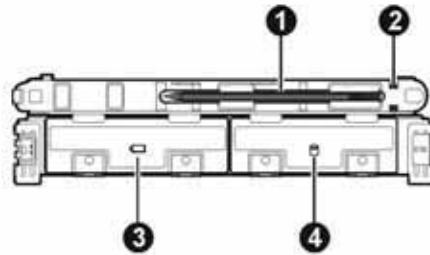



## Right-Side Components

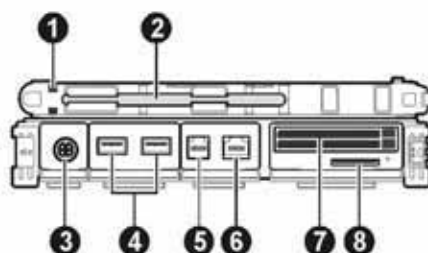

Ref	Component	Description	See Also
❶	<b>Stylus</b>	Serves as the input device by tapping on the touchscreen to make selections and enter information. <b>NOTE:</b> Some models do not have the stylus slot on the right side, so you can only use the slot on the left side for storing the stylus.	P. 2-9
❷	<b>Tether Hole</b>	Stylus can be tethered to this hole. <b>NOTE:</b> Depending on your model, this is on both sides of the computer or on the left side only.	P. 1-17
❸	<b>Battery Pack Compartment</b> 	Inside is the battery pack that supplies power to your computer when external power is not connected.	P. 3-3
❹	<b>Hard Disk Drive Compartment</b> 	Inside is the hard disk drive.	

## Left-Side Components



Ref	Component	Description	See Also
❶	<b>Tether Hole</b>	Stylus can be tethered to this hole.	P. 1-17
❷	<b>Stylus Slot</b>	Stylus can be stored in this slot.	
❸	<b>Power Connector</b> 	Connects the AC adapter.	P. 1-3
❹	<b>USB Port</b> 	Connects a USB device, such as a flash disk, printer, digital camera, joystick, and more.	P. 4-4
❺	<b>RJ-11 Connector</b> 	Connects the telephone line.	P. 2-17
❻	<b>RJ-45 Connector</b> 	Connects the LAN cable.	P. 2-18
❼	<b>ExpressCard Slot</b> (upper)	Accepts an ExpressCard for additional functions.	P. 4-7
	<b>PC Card Slot</b> (lower)	Accepts a PC card for additional functions.	P. 4-9
Depending on your model, the two slots could be a different combination (as below).			
	<b>Smart Card Reader</b> (upper)	Accepts a smart card for additional security feature.	P. 4-11



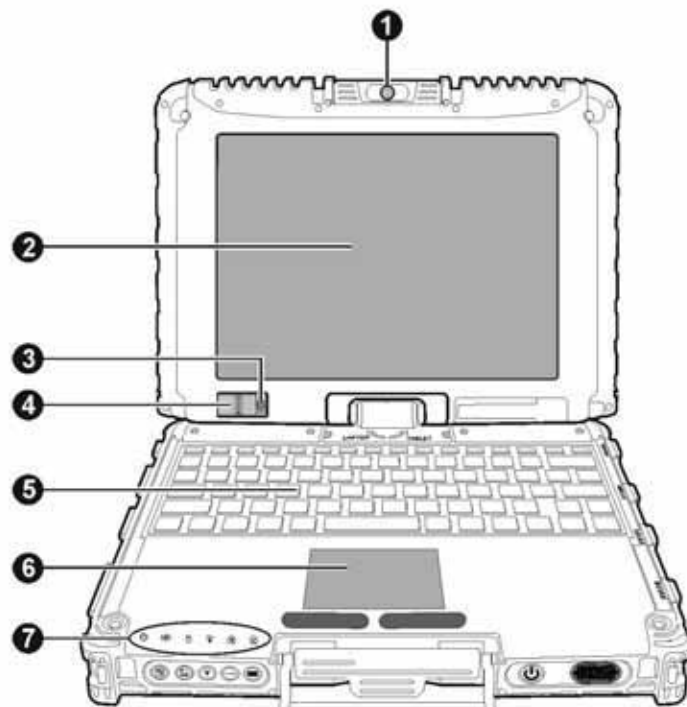

	<b>ExpressCard Slot</b> (lower)	Accepts an ExpressCard for additional functions.	P. 4-7
Ref	Component	Description	See Also
⑧	<b>SD Card Reader</b> 	Accepts an SD/SDHC/SDXC card for removable storage media.	P. 4-12

## Top-open Components



Ref	Component	Description	See Also
①	<b>Camera Lens</b>	Allows you to use your computer's camera function. The lens supports 2 MP (mega pixel).	P. 6-23

Ref	Component	Description	See Also
		It can be rotated.	
②	<b>Touchscreen</b>	Displays and receives information for the computer.	P. 2-9
③	<b>Light Sensor</b>	Detects the surrounding lighting condition for automatic adjustment of the LCD brightness and optional keyboard backlight.	
④	<b>Fingerprint Scanner</b> (optional)	Uses fingerprint verification to protect your computer against unauthorized access.	P. 2-27
⑤	<b>Keyboard</b>	Serves as the data input device.	P. 2-2
⑥	<b>Touchpad</b>	Serves as the pointing device.	P. 2-6
⑦	<b>Indicators</b>	Show the current status of the computer's devices.	
	 <b>AC Power</b>	Lights green when the computer is turned on and using AC power.	
	 <b>Battery Charge</b>	Lights green when the battery is fully charged.	P. 3-3
		Lights amber when the battery is being charged.	
		Blinks amber when the battery's capacity is below 10%.	P. 3-7
		Blinks green and amber by turns to indicate charging is suspended because the battery's temperature is either too high or too low.	
	 <b>Hard Disk Drive In-Use</b>	Lights green when the computer is accessing the hard disk drive.	
		Blinks red when the optional hard disk drive	P. 8-8

Ref	Component	Description	See Also
		heater is on for low temperature operation.	
📶	<b>RF</b>	Lights when the radio frequency is on.	
🔒	<b>Num Lock</b>	Lights when Num Lock is on.	P. 2-3
🔒	<b>Caps Lock</b>	Lights when Caps Lock is on.	P. 2-2

## Bottom Components

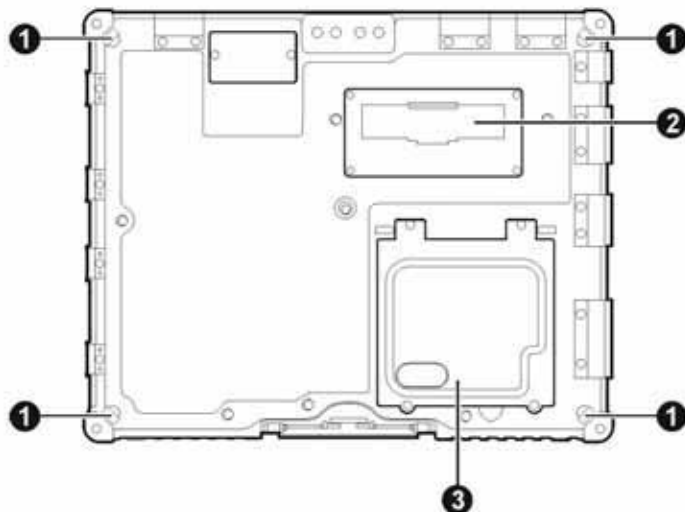

Ref	Component	Description	See Also
❶	<b>Strap Holder</b>	Four bottom hooks hold the handgrip strap.	P. 1-20
❷	<b>Docking Connector</b>	Inside is the docking connector for connecting an office dock or vehicle dock (purchased separately).	
❸	<b>Memory Slots</b>	Inside are the memory slots for expanding the memory size of your computer.	P. 4-13

<b>SIM Card Slot</b> ( optional )	Inside is the SIM card slot.	P. 2-23
--------------------------------------	------------------------------	---------



# Using Accessories

## Using the Tether

A tether is provided for attaching the stylus to your computer.

1. Insert one of the tether's loop ends through the hole of the stylus (as indicated by **1** below). Then, insert the other end through the first loop (as indicated by **2** below) and pull it tight.



2. Insert the other loop end to the tether hole on the computer (as indicated by **1** below). Then, insert the stylus end through the loop (as indicated by **2** below) and pull it tight.

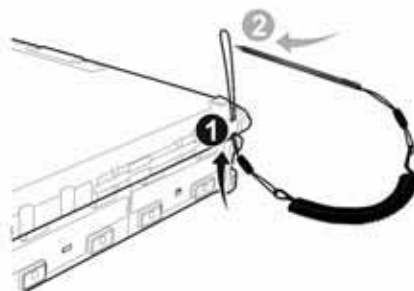

## Attaching the Handgrip Strap

To use the handgrip strap, attach its four loops to the four bottom hooks on your computer. Make sure the loops are securely hooked.

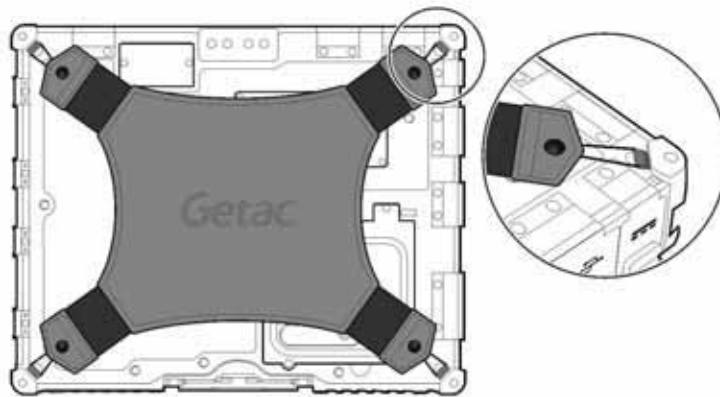

When you need to operate and hold your computer at the same time, insert your hand through the strap for a firm grip.

## Attaching the Shoulder Strap

To use the shoulder strap, secure the snap hooks to the two buckles on your computer.

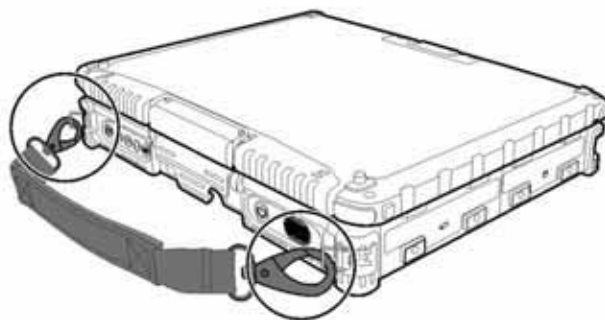

**CAUTION:**

- The strap has been designed to carry only the weight of the computer. Therefore, be sure that the strap does not carry a weight that exceeds the weight of the computer. The strap may accidentally come loose from the computer.
- Do not use a strap that is damaged or about to tear.





## Chapter 2

# Operating Your Computer

This chapter provides information about the use of the computer.

If you are new to computers, reading this chapter will help you learn the operating basics. If you are already a computer user, you may choose to read only the parts containing information unique to your computer.

### CAUTION:

- Do not expose your skin to the computer when operating it in a very hot or cold environment.
- The computer can get uncomfortably warm when you use it in high temperatures. As a safety precaution in such a circumstance, do not place the computer on your lap or touch it with your bare hands for extended periods of time. Prolonged body contact can cause discomfort and potentially a burn.

## Using the Internal Keyboard

Your keyboard has all the standard functions of a full-sized computer keyboard plus an **Fn** key added for specific functions.

The standard functions of the keyboard can be further divided into four major categories:

- Typewriter keys
- Cursor-control keys
- Numeric keys
- Function keys

### Typewriter Keys

Typewriter keys are similar to the keys on a typewriter. Several keys are added such as the **Ctrl**, **Alt**, **Esc**, and lock keys for special purposes. When the lock keys (**Caps Lock** and **Num Lk**) are pressed, their corresponding indicators light up.

The Control (**Ctrl**) / Alternate (**Alt**) key is normally used in combination with other keys for program-specific functions. The Escape (**Esc**) key is usually used for stopping a process. Examples are exiting a program and canceling a command. The function depends on the program you are using.

### Cursor-Control Keys

Cursor-control keys are generally used for moving and editing purposes. They are Home, End, Page Up, and Page Down. When used with **Fn** key, they become Left, Right, Up, and Down arrow keys.

**NOTE:** The word "cursor" refers to the indicator on the screen that lets you know exactly where on your screen anything you type will appear. It can take the form of a vertical or horizontal line, a block, or one of many other shapes.



## Numeric Keypad

A 15-key numeric keypad is embedded in the typewriter keys as shown next:



Numeric keys facilitate entering of numbers and calculations. When Num Lock is on, the numeric keys are activated; meaning you can use these keys to enter numerals.

### NOTE:

- When the numeric keypad is activated and you need to type the English letter in the keypad area, you can turn Num Lock off or you can press **Fn** and then the letter without turning Num Lock off.

- Some software may not be able to use the numeric keypad on the computer. If so, use the numeric keypad on an external keyboard instead.

## Function Keys

On the top row of the keys are the function keys: **F1** to **F12**. Function keys are multi-purpose keys that perform functions defined by individual programs.







### Fn Key















The **Fn** key, at the lower left corner of the keyboard, is used with another key to perform the alternative function of a key. The letter “Fn” and the alternative functions are identified by the color of blue on the keytop. To perform a desired function, first press and hold **Fn**, then press the other key.

### Hot Keys



Hot keys refer to a combination of keys that can be pressed any time to activate special functions of the computer. Most hot keys operate in a cyclic way. Each time a hot key combination is pressed, it shifts the corresponding function to the other or next choice.



You can easily identify the hot keys with the icons imprinted on the keytop. The hot keys are described next.

Key	Description
 	Switches the keyboard backlight on and off (optional).
 	Switches the wireless LAN radio on and off.
 	Decreases the sound volume.

Key	Description
 	Increases the sound volume.
 	Decreases the LCD brightness (20 levels).
 	Increases the LCD brightness (20 levels).
 	Switches the system sound output off (mute) and on.
 	Switches LCD backlight on and off.
 	Switches the display output when external devices are connected.
 	Serves as the sleep button that you can define with Windows' <b>Power Options</b> . (See the "Power Management" in Chapter 3.)

## Windows Keys

The keyboard has two keys that perform Windows-specific functions:  Windows Logo key and  Application key.

The  Windows Logo key opens the **Start** menu and performs software-specific functions when used in combination with other keys. The  Application key usually has the same effect as a right mouse click. (See your Windows manual for more information.)

## Using the Touchpad

**CAUTION:** Do not use a sharp object such as a pen on the touchpad. Doing so may damage the touchpad surface.

**NOTE:** For optimal performance of the touchpad, keep your fingers and the pads clean and dry. When tapping on the pad, tap lightly. Do not use excessive force.

The touchpad is a pointing device that allows you to communicate with the computer by controlling the location of the pointer on the screen and making selection with the buttons.

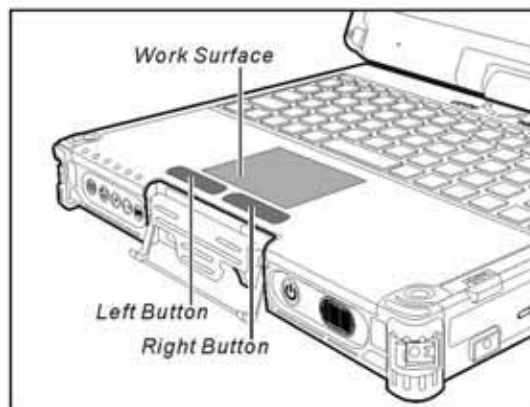

The touchpad consists of a rectangular pad (work surface) and a left and right buttons. To use the touchpad, place your forefinger or thumb on the pad. The rectangular pad acts like a miniature duplicate of your display. As you slide your fingertip across the pad, the pointer (also called cursor) on the screen moves accordingly. When your finger reaches the edge of the pad, simply relocate yourself by lifting the finger and placing it on the other side of the pad.

Here are some common terms that you should know when using the touchpad:

Term	Action
Point	Move your finger on the pad until the cursor points to the selection on the screen.
Click	Press and release the left button. —or— Tap gently anywhere on the pad.
Double-click	Press and release the left button twice in quick succession. —or— Tap twice on the pad rapidly.
Drag and drop	Press and hold the left button, then move your finger until you reach your destination (drag). Finally, release the button (drop) when you finish dragging your selection to the destination. The object will drop into the new location. —or— Gently tap twice on the pad and on the second tap, keep your finger in contact with the pad. Then, move your finger across the pad to drag the selected object to your destination. When you lift your finger from the pad, the selected object will drop into place.
Scroll	To scroll is to move up and down or left and right in the working area on the screen.  To move vertically, place your finger on the right or left edge of the pad and slide your finger up and down along the edge. To move horizontally, place your finger on the top or bottom edge of the pad and slide your finger left and right.  This function works only after you install the touchpad driver supplied with the computer and it may not work for all applications.

**TABLE NOTE:** If you swap the left and right buttons, “tapping” on the touchpad as an alternative method of pressing the left button will no longer be valid.

## Configuring the Touchpad

You may want to configure the touchpad to suit your needs. For example, if you are a left-handed user, you can swap the two buttons so that you can use the right button as the left button and vice versa. You can also change the size of the on-screen pointer, the speed of the pointer, and so on.

To configure the touchpad, go to **Control Panel** → **Mouse Properties**.



## Navigating on the Screen

The screen of your computer is touch-sensitive. You can control the location of the cursor/pointer on the screen using your finger or the included stylus or digitizer pen to communicate with the computer.

**CAUTION:** Do not use sharp objects on the LCD display. Doing so may damage the display surface. Use your finger or the included stylus or digitizer pen.

## Using the Touchscreen

If your computer is equipped with the touchscreen feature, you can use your finger or the included stylus to navigate and select objects on the screen.



The following table shows how you use the touchscreen to obtain equivalent mouse functions.





Term/Action	Equivalent Mouse Function
<b>Tap:</b> Touch the screen once.	Click/Point
<b>Double-tap:</b> Touch the screen twice rapidly.	Double-click



Term/Action	Equivalent Mouse Function
<b>Tap and hold:</b> Tap and hold until a popup menu appears.	Right-click
<b>Drag:</b> Hold the stylus (or finger) on the screen and drag across the screen until reaching your destination.	Drag

## Using Multi-touch Gestures

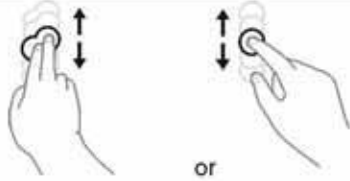
If your computer model comes with multi-touch-capable screen and Windows 7, you can interact with your computer by placing two fingers on the screen. The movement of the fingers across the screen creates “gestures,” which send commands to the computer.

Here are the multi-touch gestures that you can use:

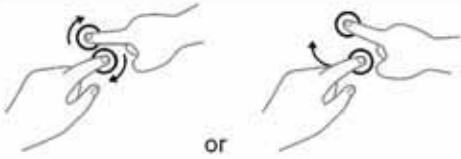
Gestures	Actions  = finger down;  = finger up]	Descriptions
Pan (Scroll)	 or Drag 1 or 2 fingers up or down.	Use panning to see another part of a page that has scroll bars.
Zoom (Pinch)	 Move two fingers apart/toward each other.	Use zooming to make an item (a photo for example) on the screen larger or smaller. The gesture works in applications that support mouse wheel zooming.

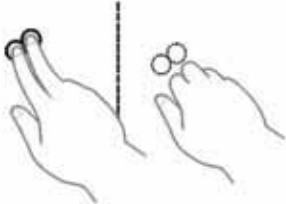
Gestures	Actions ⌚ = finger down; ⌚ = finger up)	Descriptions
Rotate	 <p>or</p> <p>Move two fingers in opposing directions. -or- Use one finger to pivot around another.</p>	Use rotating to move a picture or other item on the screen in a circular direction (clockwise or counter-clockwise). The gesture works in applications that support the specific gesture.
Press and Tap	 <p>Press on target and tap using a second finger.</p>	Use press and tap to access the shortcut menu.
Two-finger Tap	 <p>Tap two fingers at the same time (where the target is in the midpoint between the fingers).</p>	The function is defined by applications that support the specific gesture.

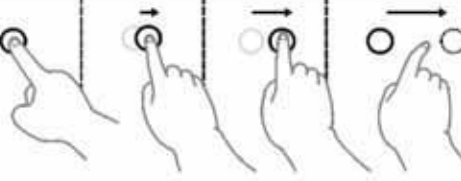
Gestures	Actions ☐ = (finger down; ☐ = (finger up)	Descriptions
Flicks	 <p data-bbox="486 779 949 840">Make quick drag gestures in the desired direction.</p>	Flick left or right to navigate back and forward in a browser and other applications. The gesture works in most applications that support back and forward.





## Using the Dual Mode Display (Optional)

Dual mode display incorporates both touchscreen and digitizer functions.

The display is set to Touchscreen mode by default. Touchscreen mode provides all the functionalities that an ordinary touchscreen has. When the computer receives signals from the digitizer pen, the display automatically switches to Digitizer mode.

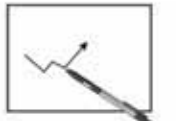

Here are some common terms that you should know when using the digitizer pen:

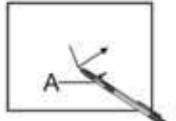
Term		Action
Move		Move the cursor pointed by the digitizer pen.
Click/Point		Tap gently on the display.
Double-click		Tap twice on the display rapidly.
Drag and drop		Tap lightly on the display and move your digitizer pen until you reach your destination (drag). Finally, release your digitizer pen (drop) when you finish dragging your selection to the destination. The object will drop into the new location.
Right-click		Press and hold down the digitizer pen button (A), then tap gently the object.



**CAUTION:**

- When the LCD display is used alone or with an external display simultaneously, the digitizer function cannot be used when the area of either display is set larger than the default setting of the display resolution.
- Even when only an external display is in use, the cursor will move on the external display if you touch the surface of the LCD display with the pen or bring the pen close to the surface of the LCD display when the digitizer driver is active. Therefore, do not touch the LCD display when only an external display is in use.
- The active digitizer feature cannot be used in the BIOS Setup program or when using the full screen in DOS mode.

**NOTE:**

- You can move the cursor by bringing the digitizer pen close to the screen, without actually touching the screen's surface.
- Do not move the digitizer pen too quickly. If the pen moves too quickly, the cursor may be unable to follow its movement.
- If you cannot click on the edge of the screen, hold the digitizer pen perpendicular to the display and try clicking again.

## Using Landscape or Portrait View

To rotate the display, press the button  located on the front of your computer to open the OSD Control Panel and click . Each time this Rotate button is clicked, the screen display rotates counter-clockwise by 90°.

### For a Model without WWAN Module

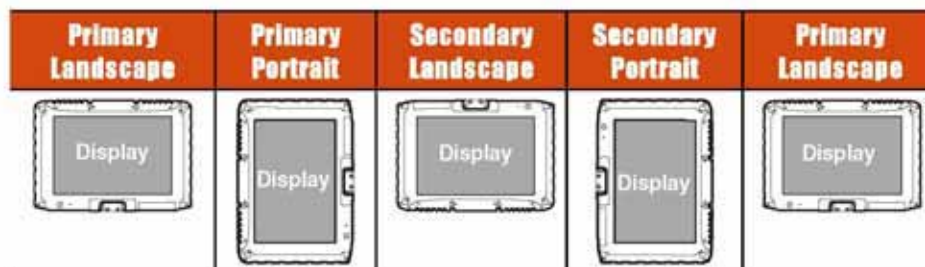

### For a Model with WWAN Module



**NOTE:**

- If the screen display resolution has been set to 800×600 pixels, you can rotate the display to Primary Landscape and Secondary Landscape only.
- While the display is rotated:
  - Do not set the display resolution larger than the resolution of the LCD display.
  - If you exit Windows, the next time Windows is started up, the operation of the touchpad will not match the display angle for a few seconds.
  - The computer's performance will decrease slightly.
  - If a video is played, the picture may not be displayed properly or the sound may be broken up. This problem can be corrected by rotating the display to Primary Landscape.
  - The touchpad's scroll function does not work.
- The display cannot be rotated when DOS mode is set to "Full Screen."

## Using the Input Panel



You can use the Input Panel to enter text and perform various keyboard functions. There are two types of Input Panels for you to use in Windows 7:

- **Touch Keyboard** allows you to enter text by tapping the keys with your stylus, like pressing the keys on a standard keyboard.



- **Writing Pad** allows you to write on the writing pad, like writing on a piece of paper. Your handwriting will be converted into typed text.



To open the Input Panel, tap the Input Panel tab, which appears by default on the left edge of the screen. To switch between the two types, tap  or  at the upper left corner of the Input Panel.

**NOTE:** For more information on using the Input Panel, see [Windows' online help](#).



# Using the Network Features

## Using the Modem

The internal 56 K fax/data modem allows you to use the telephone line to communicate with others by fax, email, or connect to an online service or bulletin board.

To connect the telephone line to the modem, connect one end of the modem cable to the RJ-11 connector on the computer and the other end to the phone line.

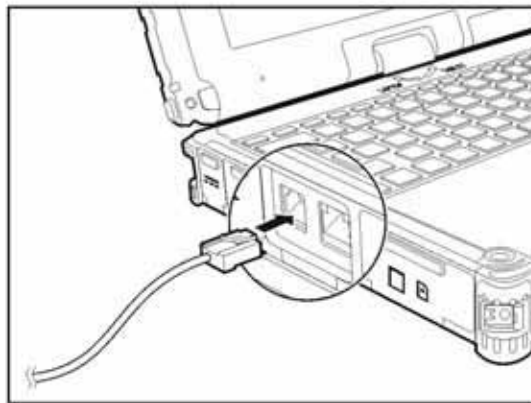

### NOTE:

- When using the communication software, you may have to disable power management. Do not enter the Sleep mode when using the communication software.
- Set parameters such as modem speed (baud rate) and line type (pulse dialing or tone dialing).

## Using the LAN

The internal 10/100/1000Base-T LAN (Local Area Network) module allows you to connect your computer to a network. It supports data transfer rate up to 1000 Mbps.

To connect the network cable to the LAN module, connect one end of the LAN cable to the RJ-45 connector on the computer and the other end to the network hub.

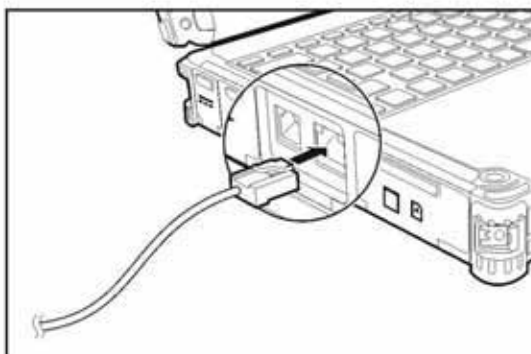

## Using the Wireless LAN

The WLAN module of your computer supports IEEE 802.11a/g/n.

### Turning Off/On the WLAN Radio

**NOTE:** The FAA (Federal Aviation Agency) has deemed it unsafe to operate wireless devices in aircraft as this may interfere with flight safety. Remember to turn off wireless LAN when using your computer in the airplane.



**FOR WIFI 5G BAND STATEMENT:** The device for operation in the band 5150–5250 MHz is only for indoor use to reduce the potential for harmful interference to co-channel mobile satellite systems.

Your computer has a built-in **Fn+F2** WLAN hot key to switch the WLAN on/off. If you need to temporarily turn off the radio, press **Fn+F2**. To resume network connection, press **Fn+F2** again.

**NOTE:** **Fn+F2** hot key works only when **RF** is set to **ON** in the OSD Control Panel. (See "Using the OSD Control Panel" in Chapter 6.)

## Connecting to a Wireless Network

To connect to a wireless network:

1. Make sure that the WLAN function is enabled (as described above). The Wireless Network icon  on the taskbar should appear without a red X.
2. Tap the Wireless Network icon  on the taskbar. (An orange light in the icon  indicates connections are available.)
3. In the list of available wireless networks, tap a network, and then tap **Connect**.



4. Some networks require a network security key or passphrase. To connect to one of those networks, ask your network administrator or Internet service provider (ISP) for the security key or passphrase.

For more information on setting a wireless network connection, refer to Windows online help.

**NOTE:** You can use Intel® PROSet Wireless to take full advantage of the WiFi capabilities of your computer. See the Help of the utility for instructions.

## Using the Bluetooth Feature

Depending on your model, your computer may incorporate the Bluetooth 4.0 capability for short-range (about 50 meters) wireless communications between devices without requiring a cable connection. With Bluetooth, data can be transmitted through walls, pockets and briefcases as long as two devices are within range.

### Turning Off/On the Bluetooth Radio

To turn on or off the wireless radio (including the Bluetooth radio), press the button  located on the front of your computer. A small window pops up on the screen to indicate the status.

When the Bluetooth radio is on, the Bluetooth icon  appears on the Windows taskbar.

### Connecting to another Bluetooth Device

1. Make sure that the Bluetooth function is enabled (as described above).
2. Make sure that the target Bluetooth device is turned on, discoverable and within close range. (See the documentation that came with the Bluetooth device.)
3. To search for Bluetooth devices, right click the Bluetooth icon  and select **Add a Device**.



4. Select the device you want to connect from the search results.

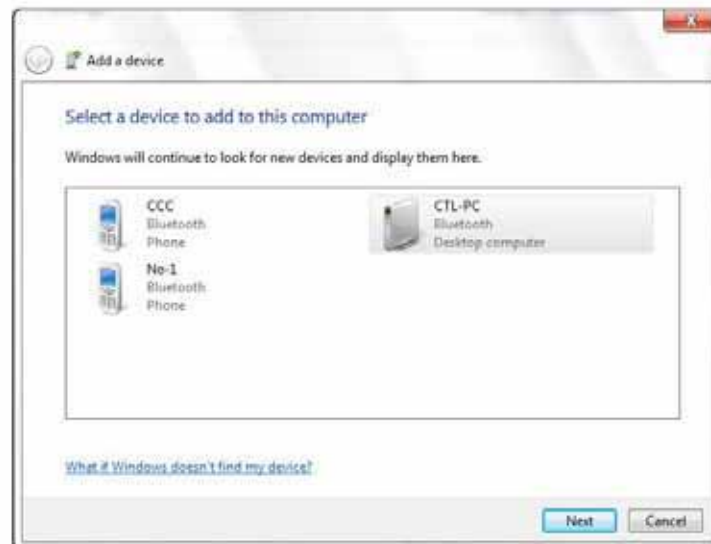

5. Depending on the type of Bluetooth device that you want to connect to, you will need to enter the pertinent information.

For detailed information on using the Bluetooth feature, see Windows' online Help.

## Using the WWAN Feature (Optional)

A WWAN (Wireless Wide Area Network) uses mobile telecommunication cellular network technologies to transfer data. The WWAN module of your computer supports 3G or 4G LTE depending on your model.

**NOTE:** Your computer only supports data transmission; voice transmission is not supported.

### Installing a SIM Card

To use the WWAN feature to connect to the Internet, you need to subscribe to the service and acquire a SIM card from a mobile phone network service provider.

To install the SIM card, follow these steps:

1. Turn off the computer and disconnect the AC adapter.
2. Carefully place the computer upside down.
3. Remove the four screws to open the compartment cover.

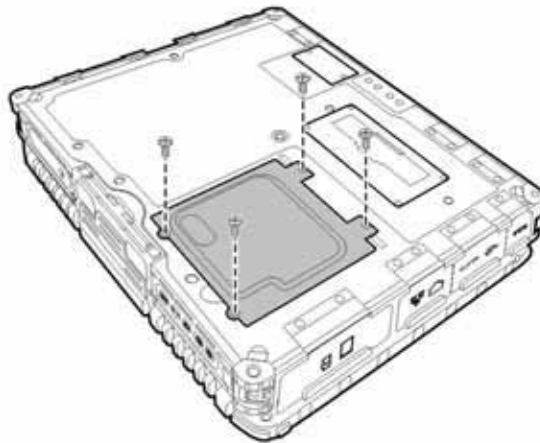

4. Locate the SIM card slot. Slide the locking tab inward to unlock.

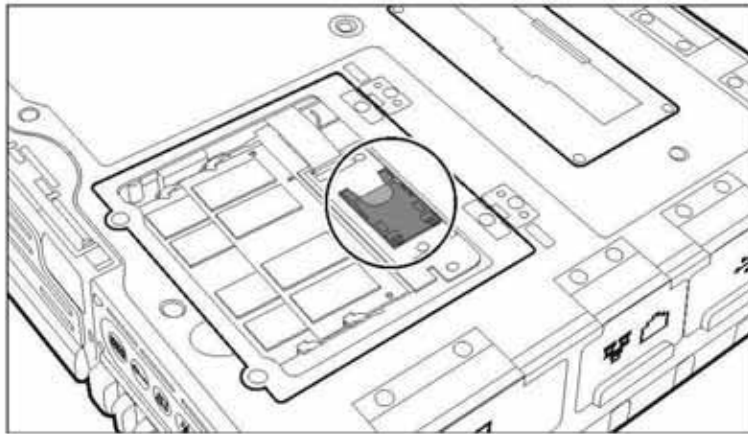

5. Lift the slot up and, noting the orientation, insert the SIM card into the slot.



6. Slide the locking tab outward to secure the SIM card in place.
7. Close the compartment cover and secure with four screws.

## Turning Off/On the WWAN Radio

### CAUTION:

#### For SAR STATEMENT FCC RF Radiation Exposure Statement

For body worn operation, this device has been tested and meets FCC RF exposure guidelines that positions the EUT a minimum of 0 cm from the body SAR information:

1. DTS Band : 0.910 W/kg
2. UNII Band : 0.537 W/kg



To turn on or off the wireless radio (including the WWAN radio), press the button  located on the front of your computer. A small window pops up on the screen to indicate the status.

## Connecting to WWAN Network

1. Make sure that the SIM card is inserted and WWAN function is enabled (as described above).
2. On Windows desktop, double-click the **AirCard Watcher** shortcut. The screen as below appears.



3. If the radio is currently off, click **Turn Radio On** to turn on the radio.
4. Use AirCard Watcher to manage your broadband wireless network connections such as:
  - Connect to the Internet
  - Configure user options
  - Send and receive SMS messages

- Manage profiles
- Use GPS to track your position (for models having the GPS module)

**NOTE:** For detailed information on using **AirCard Watcher**, see the program's online help.

## Using the Fingerprint Scanner (Optional)

### CAUTION:

- We shall not be liable for any loss or damage whatsoever resulting from your use of the fingerprint scanner or neglect of fingerprint scanner use, or any data loss resulting from such developments as fingerprint authentication malfunctioning.
- It is not recommended that you use the fingerprint scanner in a below-freezing temperature. The moisture on your finger can freeze to the scanner's metal surface when you touch it, resulting in a failed operation.

The fingerprint scanner provides a strong authentication mechanism based on fingerprint recognition. It features:

- **Website Log On**  
Logon to your web accounts like banks, webmail, and more with a simple swipe of your finger.
- **Windows Log On**  
Logon to Microsoft® Windows® with a simple swipe of your finger every time you turn on your computer or log onto your desktop.
- **QuickLaunch**  
Quickly launch all your favorite websites, open files and folders, and log in to your accounts with a simple swipe of your finger.
- **KeepSafe**  
Protect your pictures, personal files, and folders using your fingerprint so only you can access them.

**NOTE:** You can register a fingerprint only after creating a password for the Windows user account.

To register your fingerprint, click **Start → All Programs → AuthenTec TrueSight → AuthenTec TrueSight**. Click the finger you want to register and follow the onscreen instructions to complete.



You can then use the Fingerprint Software to set up how the fingerprint authentication works.



For detailed information, click the Help button of the software.



## Chapter 3

# Managing Power

Your computer operates either on external AC power or on internal battery power.

This chapter tells you how you can effectively manage power. To maintain optimal battery performance, it is important that you use the battery in the proper way.

## AC Adapter

### CAUTION:

- The AC adapter is designed for use with your computer only. Connecting the AC adapter to another device can damage the adapter.
- The AC power cord supplied with your computer is for use in the country where you purchased your computer. If you plan to go overseas with the computer, consult your dealer for the appropriate power cord.
- When you disconnect the AC adapter, disconnect from the electrical outlet first and then from the computer. A reverse procedure may damage the AC adapter or computer.
- When unplugging the connector, always hold the plug head. Never pull on the cord.

The AC adapter serves as a converter from AC (Alternating Current) to DC (Direct Current) power because your computer runs on DC power, but an electrical outlet usually provides AC power. It also charges the battery pack when connected to AC power.

The adapter operates on any voltage in the range of 100~240 V AC.



## Battery Pack

The battery pack is the internal power source for the computer. It is rechargeable using the AC adapter.

The operating time of a fully charged battery pack depends on how you are using the computer. When your applications often access peripherals, you will experience a shorter operating time.

**NOTE:** Care and maintenance information for the battery is provided in the "Battery Pack Guidelines" section in Chapter 7.

## Charging the Battery Pack

### NOTE:

- Charging will not start if the battery's temperature is below 0 °C (32 °F) or above 40 °C (104 °F); the charging process will stop if the battery's temperature gets above 60 °C (140 °F). To avoid damaging the battery under this situation, disconnect the AC adapter and wait for the battery to return to room temperature before charging again.
- During charging, do not disconnect the AC adapter before the battery has been fully charged; otherwise you will get a prematurely charged battery.

To charge the battery pack, connect the AC adapter to the computer and an electrical outlet. The Battery Charge Indicator (  ) on the computer glows amber to indicate that charging is in progress. You are advised to keep the computer power off while the battery is being charged. When the battery is fully charged, the Battery Charge Indicator lights green.

It takes approximately 3 hours to fully charge the Li-Ion battery pack when the computer is off, and approximately 6 hours to fully charge the Li-Ion battery pack when the computer is on.

**CAUTION:** After the computer has been fully recharged, do not immediately disconnect and reconnect the AC adapter to charge it again. Doing so may damage the battery.

**NOTE:** The battery level may automatically lessen due to the self-discharge process (0.21 % per day), even when the battery pack is fully charged (100 %). This happens no matter if the battery pack is installed in the computer.

## Initializing the Battery Pack

You need to initialize a new battery pack before using it for the first time or when the actual operating time of a battery pack is much less than expected. Initializing is the process of fully charging, discharging, and then charging. It can take several hours.

A tool called “Gauge Reset” is provided for the purpose. See “Gauge Reset” in Chapter 6 for information on using the tool.

## Checking the Battery Level

**NOTE:** Any battery level indication is an estimated result. The actual operating time can be different from the estimated time, depending on how you are using the computer.

### By Operating System

You can check the approximate battery level using the battery meter function of the operating system. To read the battery level in Windows, click the battery icon on the taskbar.

### By Gas Gauge

On the exterior side of the battery pack is a gas gauge for displaying the estimated battery charge. When the battery pack is not installed in the computer and you want to know the battery charge, you can press the switch with a pointed device to see the corresponding value of indicator segment that light green.

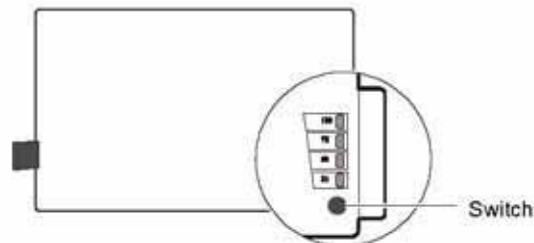

The value of the corresponding green segment indicates the relative percentage of the battery charge. The battery pack is fully discharged when you see no segment glowing green.

## Replacing the Battery Pack

### CAUTION:

- There is danger of explosion if the battery is incorrectly replaced. Replace the battery only with the computer manufacturer's optional battery packs. Discard used batteries according to the dealer's instructions.
- Do not attempt to disassemble the battery pack.

If you often rely on battery power for a long period of time while traveling, you may consider the purchase of an additional battery pack from your dealer and keep it with you in a fully charged state as a backup.

To replace the battery pack, follow these steps:

1. Make sure that the computer is not turned on or connected to AC power.
2. Locate the battery compartment on the right side of the computer.
3. Press the two latches toward each other to open the protection cover.

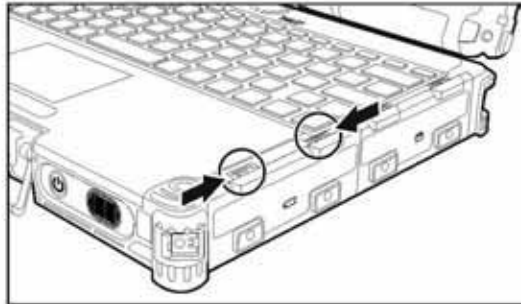

4. Pull the ribbon strip to remove the battery pack.

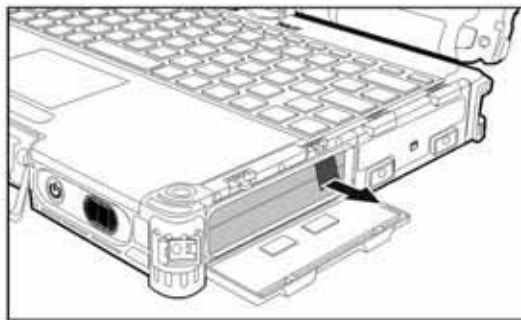



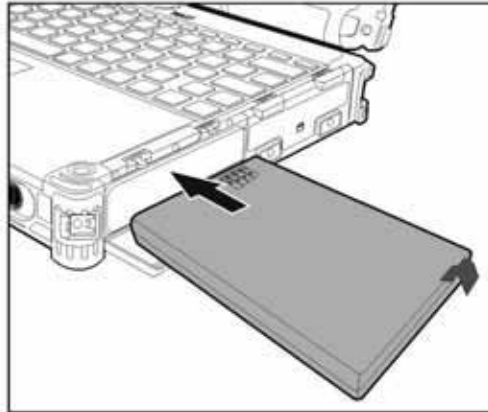

5. With the strip facing outward, insert the new battery pack all the way into the slot.



6. Close the cover. Make sure the latches are engaged.

## Battery Low Signals and Actions

The battery icon  changes appearance to display the current state of the battery.

Battery Icon	Battery Level	Description
	Discharging	The icon shows the charge remaining in 10-percent increments until the charge reaches the low-battery level.
	Low	The battery charge has reached the low-battery level (10% by default).
	Critically low	The battery charge has reached the critical battery level (5% by default). By default, Windows will display a notification and put your computer into Hibernation.

When the battery is low, the computer's Battery Charge Indicator (  ) also blinks red to alert you to take actions.

Always respond to low-battery by connecting the AC adapter, placing your computer in Hibernation mode, or turning off the computer.



## Power Management

Your computer supports ACPI (Advanced Configuration and Power Interface) for power management. The power management feature allows you to reduce the power consumption for energy saving.

With an ACPI-compliant operating system such as Windows, power supply to different computer components is controlled on an as-needed basis. This allows maximum power conservation and performance at the same time.

In general, Windows' power management works in this way:

What..	When..
Power to the hard disk is turned off	When the hard disk has been idle for a set period.
Power to the display is turned off	When the display has been idle for a set period.
The computer enters the Sleep mode. The hard disk and display are turned off and the entire system consumes less power.	When the entire system has been idle for a set period.
	When you manually activate the mode.
The computer enters the Hibernation mode. (See the next subsection for more information.)	When the entire system has been idle for a set period.
	When you manually activate the mode.

For detailed information on power management, see Windows' Help.

## **Hibernation**

Hibernation is a very useful feature. People frequently open many applications when they use computers. It takes some time to get all these applications open and running, and normally they all have to be closed before the computer can be turned off.

When you use the hibernation feature, you do not have to close the applications. The computer stores the state of your computer to a file on the hard disk and then shuts down. The next time you turn on your computer, you return to exactly where you left off.



## Power-Saving Tips

Aside from enabling your computer's power saving mode (see previous section), you can do your part to maximize the battery's operating time by following these suggestions.

- Enter power saving mode when using battery power.
- Do not disable automatic power management features.
- Decrease the LCD brightness to the lowest comfortable level.
- Shorten the length of time before Windows turn off the display.
- Many USB devices use power just by being connected. If you use a USB mouse, you can save power by disconnecting the mouse and using the touchpad. If you use a USB flash drive, unplug it when you are not using it.
- Remove the card (such as PC card, ExpressCard, and Smart Card) if not using it.
- Turn off the wireless radio if you are not using the wireless module (such as WLAN, Bluetooth, or WWAN).
- Turn off the computer when you are not using it.



## **Chapter 4**

# **Expanding Your Computer**

You can expand the capabilities of your computer by connecting other peripheral devices.

When using a device, be sure to read the instructions accompanying the device together with the relevant section in this chapter.

## Connecting an External Monitor

If you want the benefits of a larger display screen with higher resolution, you can connect an external display monitor to your computer. Follow this procedure to connect an external monitor:

1. Make sure that the computer is not turned on.
2. Plug the monitor's D-type signal connector to the computer's VGA connector.

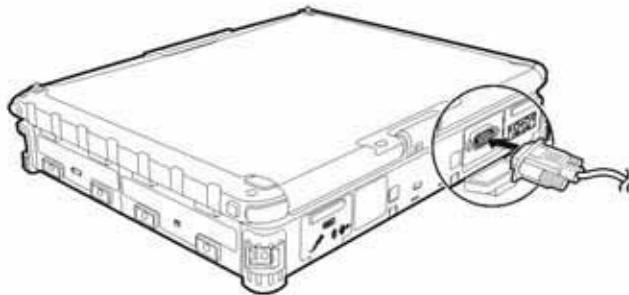

3. Plug one end of the monitor's power cord into the power socket on the monitor and the other end to an electrical outlet.
4. To use the monitor, turn on the monitor before turning on the computer.
5. The monitor should respond by default. If not, you can switch the display to the monitor or to both (simultaneous display), or to multi-display by pressing the **Fn+F9** hot key. In Windows, you can also change the display through the settings in **Display** Properties.
6. You can change display settings through your operating system. See your operating system documentation or online help for specific information.

**CAUTION:** Do not disconnect the external monitor while the computer is in the Sleep mode or Hibernation mode. If no external monitor is connected when the computer resumes, the LCD might not display properly.

## Connecting a Serial Device

Your computer has one or two serial ports (depending on model) for connecting a serial device such as a serial mouse or serial communication device (modem).

Follow this procedure to connect a serial device:

1. Make sure the computer is not turned on
2. Plug the device cable to the serial port on the rear of the computer.

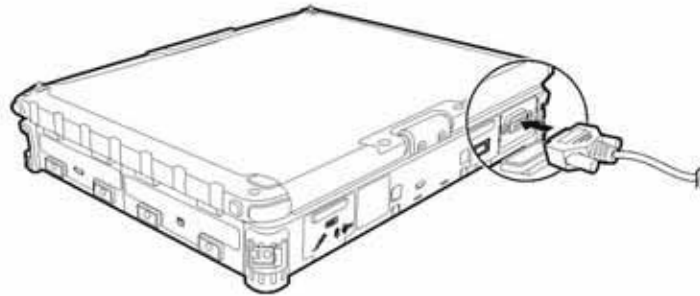

3. Turn on the computer.

**NOTE:** Portable modems that derive power through the serial port cannot be used with the computer. Instead, use a modem that is powered by its own internal battery or external AC power.

## Connecting a USB Device

Your computer has two USB 3.0 ports for connecting USB devices, such as a digital camera, scanner, printer, modem, and mouse. The USB 3.0 port supports a transfer rate up to 5 Gbit/s.

To connect a USB device, simply plug the device cable to one of the USB ports.

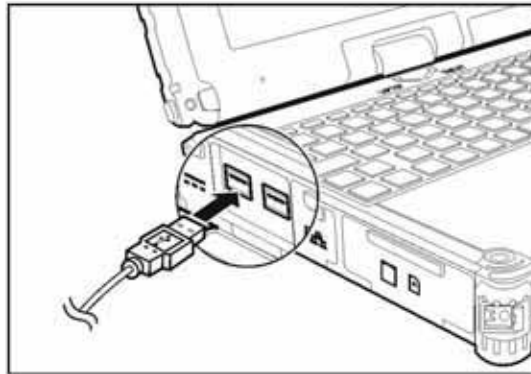

## Connecting an IEEE 1394 Device

Your computer has a mini IEEE 1394a port for connecting IEEE 1394 devices that include not only computer peripheral devices such as scanner, printer and high-quality CCD, but also consumer electronic equipment such as DVCAM and VCR.

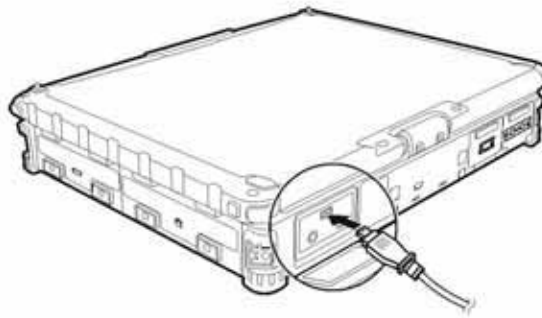

To connect an IEEE 1394 device, prepare an IEEE 1394 cable. Plug the appropriate end of the cable to the computer's mini IEEE 1394 connector and the other end to the device's corresponding connector.

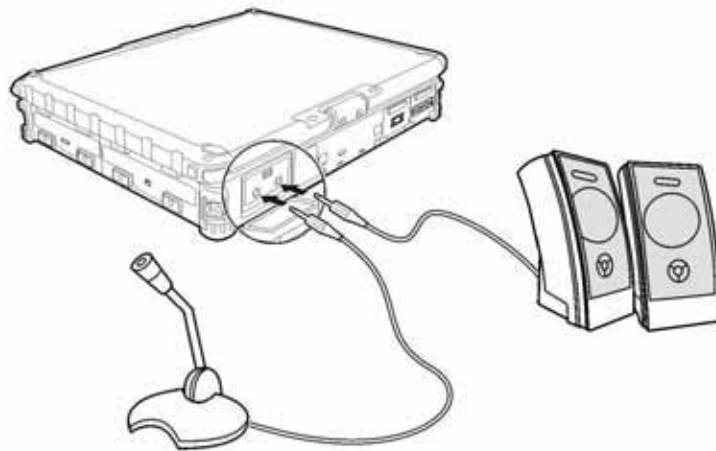

## Connecting Audio Devices

For higher audio quality, you can send or receive sound through external audio devices.



- **Audio Output Connector** (  ) can be connected to speakers, headphones, or earphone set.
- **Microphone Connector** (  ) can be connected to an external microphone for recording voice or sound.

### NOTE:

- After connecting an external audio device, make sure that you specify the use of the correct audio device in Windows.
- When using the external speakers/headphones or microphone, you cannot use the internal one.



## Using ExpressCards

Your computer may have an ExpressCard slot.

The ExpressCard slot can accommodate a 54 mm (ExpressCard/54) or 34 mm (ExpressCard/34) wide ExpressCard. Typical ExpressCards support a very extensive range of applications including memory, wired and wireless communication cards, and security devices.

Shown next are the appearances of ExpressCards for your reference.



**ExpressCard/54**



**ExpressCard/34**

To insert an ExpressCard:

1. Locate the ExpressCard slot on the left side of the computer. It can be the upper slot (standard configuration) or lower slot depending on your model.
2. Slide the ExpressCard, with its label facing up, all the way into the slot until the rear connectors click into place.

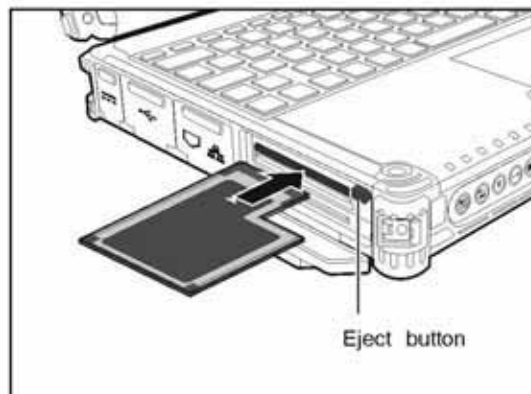

3. When a new card is seated, the computer will detect it and try to install the appropriate driver. Follow the on-screen instructions to complete the process.

To remove an ExpressCard:

1. Double-click the **Safely Remove Hardware**  icon found on the Windows taskbar and the **Safely Remove Hardware** window appears on screen.
2. Select (highlight) the ExpressCard from the list to disable the card.
3. Push the eject button and the card will slide out slightly.
4. Pull the card out of the slot.

## Using PC Cards

### NOTE:

- Some PC cards require additional system resources. Before using such PC card, you may have to free other system resources for the PC card.
- Although some PC cards can be inserted and removed without turning off the computer, you cannot remove or install PC cards during Sleep mode.

Your computer may have a PC card slot. The slot supports CardBus specifications. The slots can accommodate a type II card. Typical type II cards are flash memory, SRAM, modem, LAN, and SCSI cards.

To insert a PC card:

1. Locate the PC card slot (the lower slot) on the left side of the computer.
2. Slide the PC card, with its label facing up, into the slot until the eject button pops out.

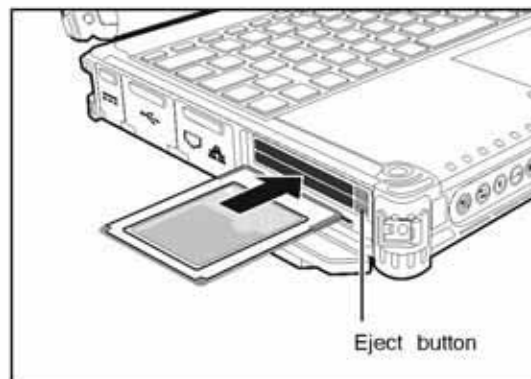

3. When a new card is seated, the computer will detect it and try to install the appropriate driver. Follow the on-screen instructions to complete the process.

To remove a PC card:

1. Double-click the **Safely Remove Hardware**  icon found on the Windows taskbar and the **Safely Remove Hardware** window appears on screen.
2. Select (highlight) the PC card from the list to disable the card.
3. Push the eject button and the card will slide out slightly.
4. Pull the card out of the slot.

## Using Smart Cards (Optional)

Your computer may have a smart card reader.

With an embedded microcontroller, smart cards have the unique ability to store large amounts of data, carry out their own on-card functions (e.g., encryption and mutual authentication), and interact intelligently with a smart card reader.

To insert a smart card:

1. Locate the smart card slot.
2. Slide the smart card, with its label and embedded computer chip facing up into the slot.



3. When a new card is seated, use the third-party smart card software to allow your computer to read it.

To remove a smart card:

1. Make sure that the third-party smart card software is not accessing the smart card.
2. Pull the card out of the slot.

## Using SD Cards

**NOTE:** You can use only storage cards. Your SD card reader does not support cards with I/O (input/output) functions such as a wireless network card or Bluetooth card.

Your computer has an SD card reader. The card reader is a small drive for reading from and writing to removable storage cards (or called memory cards). The card reader supports SD (Secure Digital), SDHC (Secure Digital High Capacity), and SDXC (Secure Digital eXtended Capacity) cards.

To insert a storage card:

1. Locate the SD card reader slot on the left side of the computer.
2. Align the card with its connector pointing to the slot and its label facing up. Slide the card into the slot until it reaches the end.

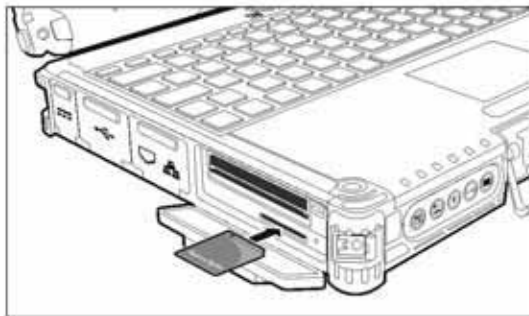

3. Windows will detect the card and assign it a drive name.

To remove a storage card:

1. Double-click **My Computer**.
2. Right-click the drive with the card and select **Eject**.
3. Pull the card out of the slot.

## System Memory Upgrade

You can upgrade your computer by expanding system memory.

### CAUTION:

- It is not recommended that you buy and install RAM modules by yourself. If you want to expand system memory, please ask Getac service center to install DRAM modules for you so that full compatibility can be guaranteed.
- RAM modules are extremely sensitive to static electricity. There are cases where static electricity generated by the human body has adversely affected such modules. When inserting or removing a RAM module, do not touch the terminals or internal components, insert objects other than the module, or allow foreign particles to enter. Doing so has been known to cause damage, fire, or electrical shock.

To install the RAM module:

1. Remove the battery pack (see chapter 3) and make sure that the computer is not connected to AC power.
2. Carefully place the computer upside down.
3. Remove the four screws to open the compartment cover.

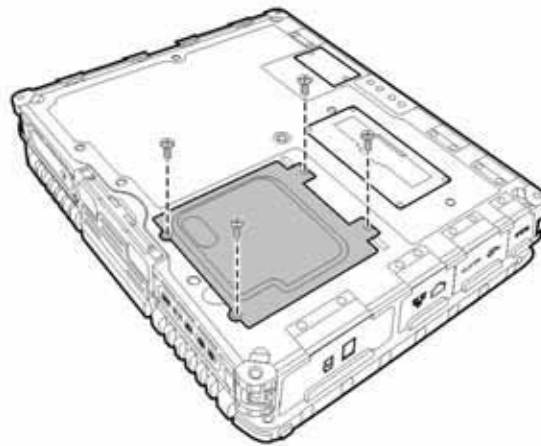

4. To install the RAM module, match the module's notched part with the socket's projected part and firmly insert the module into the socket at a 20-degree angle. Then push down until the retaining clips lock the module into position.

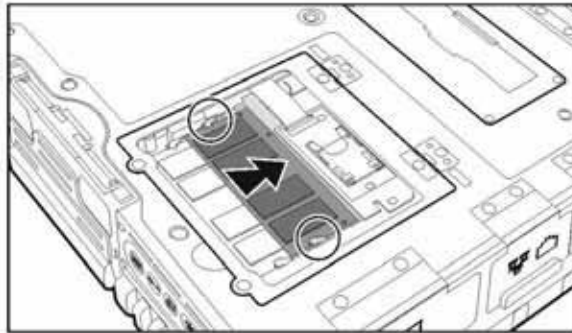

**CAUTION:** If the RAM module is difficult to insert or difficult to push down, do not force it. Check once more to ensure that the module is positioned correctly.

5. Close the compartment cover and secure with four screws.



## Chapter 5

# Using BIOS Setup and System Recovery

BIOS Setup Utility is a program for configuring the BIOS (Basic Input/ Output System) settings of the computer. BIOS is a layer of software, called firmware, that translates instructions from other layers of software into instructions that the computer hardware can understand. The BIOS settings are needed by your computer to identify the types of installed devices and establish special features.

System Recovery reinstalls Windows to your computer and restores it to the factory default status.

This chapter tells you how to use the BIOS Setup and System Recovery.

# BIOS Setup

## When and How to Use

You need to run BIOS Setup Utility when:

- You see an error message on the screen requesting you to run BIOS Setup Utility.
- You want to restore the factory default BIOS settings.
- You want to modify some specific settings according to the hardware.
- You want to modify some specific settings to optimize the system performance.

To run BIOS Setup Utility, press the **F2** key when the prompt appears on the screen during system startup. The prompt shows up on the screen for only a few seconds. You must press **F2** quickly. The BIOS Setup Utility main screen appears as shown next.

