



**FCC 47 CFR PART 15 SUBPART C**

**TEST REPORT**

**For**

**Notebook Computer**

**Model: V100**

**Trade Name: Getac**

*Issued to*

**Getac Technology Corp.  
4F, No.1, R&D 2nd Road, Hsin-Chu Science-Based Industrial Park,  
Hsin-Chu Hsien, Taiwan, R.O.C.**

*Issued by*

**Compliance Certification Services Inc.  
No.11, Wu-Gong 6th Rd., Wugu Industrial Park,  
New Taipei City 248, Taiwan (R.O.C.)  
<http://www.ccsrf.com>  
[service@ccsrf.com](mailto:service@ccsrf.com)  
**Issued Date: October 12, 2012****



---

*Note: This report shall not be reproduced except in full, without the written approval of Compliance Certification Services Inc. This document may be altered or revised by Compliance Certification Services Inc. personnel only, and shall be noted in the revision section of the document.*



**Revision History**

Rev.	Issue Date	Revisions	Effect Page	Revised By
00	October 12, 2012	Initial Issue	ALL	Eunice Shen



## TABLE OF CONTENTS

<b>1. TEST RESULT CERTIFICATION.....</b>	<b>4</b>
<b>2. EUT DESCRIPTION .....</b>	<b>5</b>
<b>3. TEST METHODOLOGY .....</b>	<b>7</b>
3.1 EUT CONFIGURATION .....	7
3.2 EUT EXERCISE.....	7
3.3 GENERAL TEST PROCEDURES.....	7
3.4 FCC PART 15.205 RESTRICTED BANDS OF OPERATIONS.....	8
3.5 DESCRIPTION OF TEST MODES .....	9
<b>4. INSTRUMENT CALIBRATION.....</b>	<b>10</b>
4.1 MEASURING INSTRUMENT CALIBRATION .....	10
4.2 MEASUREMENT EQUIPMENT USED .....	10
4.3 MEASUREMENT UNCERTAINTY .....	11
<b>5. FACILITIES AND ACCREDITATIONS .....</b>	<b>12</b>
5.1 FACILITIES .....	12
5.2 EQUIPMENT.....	12
5.3 TABLE OF ACCREDITATIONS AND LISTINGS.....	13
<b>6. SETUP OF EQUIPMENT UNDER TEST .....</b>	<b>14</b>
6.1 SETUP CONFIGURATION OF EUT.....	14
6.2 SUPPORT EQUIPMENT .....	14
<b>7. FCC PART 15.247 REQUIREMENTS.....</b>	<b>15</b>
7.1 DUTY CYCLE .....	15
7.2 6DB BANDWIDTH .....	18
7.3 PEAK POWER.....	47
7.4 AVERAGE POWER .....	63
7.5 BAND EDGES MEASUREMENT .....	79
7.6 PEAK POWER SPECTRAL DENSITY.....	105
7.7 SPURIOUS EMISSIONS.....	134
7.8 POWERLINE CONDUCTED EMISSIONS.....	186
<b>8. APPENDIX I RADIO FREQUENCY EXPOSURE .....</b>	<b>189</b>
<b>9. APPENDIX II PHOTOGRAPHS OF TEST SETUP .....</b>	<b>191</b>
<b>APPENDIX 1 - PHOTOGRAPHS OF EUT</b>	



# 1. TEST RESULT CERTIFICATION

**Applicant:** Getac Technology Corp.  
 4F, No.1, R&D 2nd Road, Hsin-Chu Science-Based Industrial  
 Park, Hsin-Chu Hsien, Taiwan, R.O.C.

**Equipment Under Test:** Notebook Computer

**Trade Name:** Getac

**Model:** V100

**Date of Test:** June 16 ~ October 12, 2012

APPLICABLE STANDARDS	
STANDARD	TEST RESULT
FCC 47 CFR Part 15 Subpart C	No non-compliance noted

## We hereby certify that:

The above equipment was tested by Compliance Certification Services Inc. The test data, data evaluation, test procedures, and equipment configurations shown in this report were made in accordance with the procedures given in ANSI C63.4: 2009 and the energy emitted by the sample EUT tested as described in this report is in compliance with the requirements of FCC Rules Part 15.207, 15.209, 15.247.

The test results of this report relate only to the tested sample EUT identified in this report.

Approved by:

Reviewed by:

---

Miller Lee  
 Section Manager  
 Compliance Certification Services Inc.

---

Gina Lo  
 Section Manager  
 Compliance Certification Services Inc.



## 2. EUT DESCRIPTION

<b>Product</b>	Notebook Computer
<b>Trade Name</b>	Getac
<b>Model Number</b>	V100
<b>Received Date</b>	August 23, 2012
<b>Power Supply</b>	<p>1. Powered from Power Adapter</p> <p>A) Brand: Getac / Model: ADM-6019M I/P: 100-240V, 50-60Hz, 1.5A O/P: 19V, 3.16A</p> <p>B) Brand: Getac / Model: ADM-9019M-GTK I/P: 100-240V, 50-60Hz, 1.5A O/P: 19V, 4.74A</p> <p>C) Brand: FSP / Model: FSP090-DMBB1 I/P: 100-240V, 50-60Hz, 1.5A O/P: 19V, 4.74A</p> <p>2. Powered from Battery Model: BP-LC3100/32-01P1 Rating: DC10.8V, 6100mAh, 65Wh</p>
<b>Frequency Range</b>	<p>IEEE 802.11a/ IEEE 802.11n HT 20 MHz: 5.725~5.850 GHz</p> <p>IEEE 802.11n HT 40 MHz: 5.755~5.795 GHz</p> <p>IEEE 802.11b/g/ IEEE 802.11n HT 20 MHz: 2.412~2.462 GHz</p> <p>IEEE 802.11n HT 40 MHz: 2.422~2.452 GHz</p>
<b>Transmit Power</b>	<p>IEEE 802.11a mode: 20.10 dBm</p> <p>IEEE 802.11n HT 20 MHz mode: 17.86 dBm</p> <p>IEEE 802.11n HT 40 MHz mode: 16.72 dBm</p> <p>IEEE 802.11b mode: 22.10 dBm</p> <p>IEEE 802.11g mode: 25.65 dBm</p> <p>IEEE 802.11n HT 20 MHz mode: 24.60 dBm</p> <p>IEEE 802.11n HT 40 MHz mode: 25.03 dBm</p>
<b>Modulation Technique &amp; Transmit Data Rate</b>	<p>IEEE 802.11a: OFDM (54, 48, 36, 24, 18, 12, 9, 6 Mbps)</p> <p>IEEE 802.11n HT 20 MHz mode: OFDM (6.5, 7.2, 13, 14.4, 14.44, 19.5, 21.7, 26, 28.89, 28.9, 39, 43.3, 43.33 52, 57.78, 57.8, 58.5, 65.0, 72.2, 78, 86.67, 104, 115.56, 117, 130, 144.44 Mbps)</p> <p>IEEE 802.11n HT 40 MHz mode: OFDM (13.5, 15, 27, 30, 40.5, 45, 54, 60, 81, 90, 108, 120, 121.5, 135, 150, 162, 180, 216, 240, 243, 270, 300 Mbps)</p> <p>IEEE 802.11b mode: DSSS (1, 2, 5.5 and 11 Mbps)</p> <p>IEEE 802.11g mode: OFDM (6, 9, 12, 18, 24, 36, 48 and 54 Mbps)</p> <p>IEEE 802.11n HT 20 MHz mode: OFDM (6.5, 7.2, 13, 14.4, 14.44, 19.5, 21.7, 26, 28.89, 28.9, 39, 43.3, 43.33 52, 57.78, 57.8, 58.5, 65.0, 72.2, 78, 86.67, 104, 115.56, 117, 130, 144.44 Mbps)</p> <p>IEEE 802.11n HT 40 MHz mode: OFDM (13.5, 15, 27, 30, 40.5, 45, 54, 60, 81, 90, 108, 120, 121.5, 135, 150, 162, 180, 216, 240, 243, 270, 300 Mbps)</p>



<b>Number of Channels</b>	IEEE 802.11a mode: 5 Channels IEEE 802.11n HT 20 MHz mode: 5 Channels IEEE 802.11n HT 40 MHz mode: 2 Channels IEEE 802.11b/g mode: 11 Channels IEEE 802.11n HT 20 MHz mode: 11 Channels IEEE 802.11n HT 40 MHz mode: 7 Channels
<b>Antenna Designation</b>	PIFA Antenna
<b>Antenna Specification</b>	<b>For 2.4G :</b> Main Antenna Gain: 2.60 dBi Aux Antenna Gain: 1.61 dBi MIMO: $2.60 \text{ dBi} + 10 \log (2) = 5.60 \text{ dBi}$ (Numeric gain: 3.63) <b>For 5G :</b> Main Antenna Gain: 3.97 dBi Aux Antenna Gain: 2.45 dBi

**Remark:**

1. *The sample selected for test was production product and was provided by manufacturer.*
2. *This submittal(s) (test report) is intended for FCC ID: **MAU049** filing to comply with Section 15.207, 15.209 and 15.247 of the FCC Part 15, Subpart C Rules.*



### **3. TEST METHODOLOGY**

The tests documented in this report were performed in accordance with ANSI C63.4 and FCC CFR 47 2.1046, 2.1047, 2.1049, 2.1051, 2.1053, 2.1055, 2.1057, 15.207, 15.209 and 15.247.

#### **3.1 EUT CONFIGURATION**

The EUT configuration for testing is installed on RF field strength measurement to meet the Commissions requirement and operating in a manner that intends to maximize its emission characteristics in a continuous normal application.

#### **3.2 EUT EXERCISE**

The EUT was operated in the engineering mode to fix the TX frequency that was for the purpose of the measurements.

According to its specifications, the EUT must comply with the requirements of the Section 15.207, 15.209 and 15.247 under the FCC Rules Part 15 Subpart C.

#### **3.3 GENERAL TEST PROCEDURES**

##### **Conducted Emissions**

The EUT is placed on the turntable, which is 0.8 m above ground plane. According to the requirements in Section 13.1.4.1 of ANSI C63.4 Conducted emissions from the EUT measured in the frequency range between 0.15 MHz and 30MHz using CISPR Quasi-peak and average detector modes.

##### **Radiated Emissions**

The EUT is placed on a turn table, which is 0.8 m above ground plane. The turntable shall rotate 360 degrees to determine the position of maximum emission level. EUT is set 3m away from the receiving antenna, which varied from 1m to 4m to find out the highest emission. And also, each emission was to be maximized by changing the polarization of receiving antenna both horizontal and vertical. In order to find out the maximum emissions, exploratory radiated emission measurements were made according to the requirements in Section 13.1.4.1 of ANSI C63.4.



### 3.4 FCC PART 15.205 RESTRICTED BANDS OF OPERATIONS

(a) Except as shown in paragraph (d) of this section, only spurious emissions are permitted in any of the frequency bands listed below:

MHz	MHz	MHz	GHz
0.090 - 0.110	16.42 - 16.423	399.9 - 410	4.5 - 5.15
<sup>1</sup> 0.495 - 0.505	16.69475 - 16.69525	608 - 614	5.35 - 5.46
2.1735 - 2.1905	16.80425 - 16.80475	960 - 1240	7.25 - 7.75
4.125 - 4.128	25.5 - 25.67	1300 - 1427	8.025 - 8.5
4.17725 - 4.17775	37.5 - 38.25	1435 - 1626.5	9.0 - 9.2
4.20725 - 4.20775	73 - 74.6	1645.5 - 1646.5	9.3 - 9.5
6.215 - 6.218	74.8 - 75.2	1660 - 1710	10.6 - 12.7
6.26775 - 6.26825	108 - 121.94	1718.8 - 1722.2	13.25 - 13.4
6.31175 - 6.31225	123 - 138	2200 - 2300	14.47 - 14.5
8.291 - 8.294	149.9 - 150.05	2310 - 2390	15.35 - 16.2
8.362 - 8.366	156.52475 - 156.52525	2483.5 - 2500	17.7 - 21.4
8.37625 - 8.38675	156.7 - 156.9	2655 - 2900	22.01 - 23.12
8.41425 - 8.41475	162.0125 - 167.17	3260 - 3267	23.6 - 24.0
12.29 - 12.293	167.72 - 173.2	3332 - 3339	31.2 - 31.8
12.51975 - 12.52025	240 - 285	3345.8 - 3358	36.43 - 36.5
12.57675 - 12.57725	322 - 335.4	3600 - 4400	( <sup>2</sup> )
13.36 - 13.41			

<sup>1</sup> Until February 1, 1999, this restricted band shall be 0.490-0.510 MHz.

<sup>2</sup> Above 38.6

(b) Except as provided in paragraphs (d) and (e), the field strength of emissions appearing within these frequency bands shall not exceed the limits shown in Section 15.209. At frequencies equal to or less than 1000 MHz, compliance with the limits in Section 15.209 shall be demonstrated using measurement instrumentation employing a CISPR quasi-peak detector. Above 1000 MHz, compliance with the emission limits in Section 15.209 shall be demonstrated based on the average value of the measured emissions. The provisions in Section 15.35 apply to these measurements.





### 3.5 DESCRIPTION OF TEST MODES

The EUT (model: V100) comes with three types of power adapter for sale. After the preliminary test, the EUT with adapter (Model: ADM-9019M-GTK) was found to emit the worst emissions and therefore had been tested under operating condition.

For 2.4GHz

The EUT is a 2x2 configuration spatial MIMO (2Tx & 2Rx) without beam forming function that operate in double TX chains and double RX chains. The 2x2 configuration is implemented with two outside TX & RX chains (Main Antenna and Aux Antenna).

For 5GHz

The EUT is a 1x1 configuration spatial MIMO (1Tx & 1Rx) without beam forming function that operate in one TX chain and one RX chain. The 1x1 configuration is implemented with one outside TX & RX chains (Aux Antenna).

Software used to control the EUT for staying in continuous transmitting mode was programmed. The worst case data rate is determined as the data rate with highest output power.

After verification, all tests were carried out with the worst case test modes as shown below except radiated spurious emission below 1GHz and power line conducted emissions below 30MHz, which worst case was in normal link mode only.

**IEEE 802.11b mode:**

Channel Low (2412MHz), Channel Mid (2437 MHz) and Channel High (2462MHz) with 1Mbps data rate were chosen for full testing.

**IEEE 802.11g mode:**

Channel Low (2412MHz), Channel Mid (2437 MHz) and Channel High (2462MHz) with 6Mbps data rate were chosen for full testing.

**IEEE 802.11n HT 20 MHz mode:**

Channel Low (2412MHz), Channel Mid (2437 MHz) and Channel High (2462MHz) with 6.5Mbps data rate were chosen for full testing.

**IEEE 802.11n HT 40 MHz mode:**

Channel Low (2422MHz), Channel Mid (2437 MHz) and Channel High (2452MHz) with 13.5Mbps data rate were chosen for full testing.

**IEEE 802.11a mode:**

Channel Low (5745MHz), Channel Mid (5785MHz) and Channel High (5825MHz) with 6Mbps data rate were chosen for full testing.

**IEEE 802.11n HT 20 MHz mode:**

Channel Low(5745MHz), Channel Mid(5785MHz) and Channel High(5825MHz) with 6.5Mbps data rate were chosen for full testing.

**IEEE 802.11n HT 40 MHz mode:**

Channel Low(5755MHz) and Channel High(5795MHz) with 13.5Mbps data rate were chosen for full testing.



## 4. INSTRUMENT CALIBRATION

### 4.1 MEASURING INSTRUMENT CALIBRATION

The measuring equipment, which was utilized in performing the tests documented herein, has been calibrated in accordance with the manufacturer's recommendations for utilizing calibration equipment, which is traceable to recognized national standards.

### 4.2 MEASUREMENT EQUIPMENT USED

#### Equipment Used for Emissions Measurement

*Remark: Each piece of equipment is scheduled for calibration once a year and Loop Antenna is scheduled for calibration once three years.*

Conducted Emissions Test Site				
Name of Equipment	Manufacturer	Model	Serial Number	Calibration Due
Spectrum Analyzer	Agilent	E4446A	MY43360131	03/16/2013
Power Meter	Anritsu	ML2495A	1012009	04/26/2013
Power Sensor	Anritsu	MA2411B	0917072	04/26/2013

966Chamber B				
Name of Equipment	Manufacturer	Model	Serial Number	Calibration Due
Spectrum Analyzer	Agilent	E4446A	MY46180323	04/22/2013
EMI Receiver	ROHDE & SCHWARZ	ESCS 30	826547/004	10/27/2012
Broadband Hybrid Bi-Log Antenna	Sunol Sciences	JB1	A100209-4	10/01/2013
Double-Ridged Waveguide Horn	ETS-LINDGREN	3117	00078733	12/06/2012
Horn Antenna	COM-POWER	AH-840	03077	12/06/2012
Pre-Amplifier	Agilent	8447D	2944A10052	07/17/2013
Pre-Amplifier	Agilent	8449B	3008A01916	07/17/2013
Notch Filters Band Reject	Micro-Tronics	BRM05702-01	026	N.C.R.
Band Reject Filter	Micro-Tronics	BRC50703-01	004	N.C.R.
Band Reject Filter	Micro-Tronics	BRC50704-01	004	N.C.R.
Band Reject Filter	Micro-Tronics	BRC50705-01	007	N.C.R.
LOOP Antenna	EMCO	6502	8905-2356	06/10/2013

Conducted Emission room				
Name of Equipment	Manufacturer	Model	Serial Number	Calibration Due
L.I.S.N	SCHWARZBECK	NSLK 8127	8127-465	08/07/2013
L.I.S.N	SCHWARZBECK	NSLK 8127	8127-473	03/12/2013
EMI Receiver	ROHDE & SCHWARZ	ESCS 30	835418/008	10/20/2012
Pulse Limiter	ROHDE & SCHWARZ	ESH3-Z2	100117	07/03/2013



### 4.3 MEASUREMENT UNCERTAINTY

PARAMETER	UNCERTAINTY
Conducted Emission (Mains Terminals), 9kHz to 30MHz	+/- 2.48
Conducted Emission (Telecommunication Port), 150kHz to 30MHz	+/- 3.09
3M Semi Anechoic Chamber / 30M~1000M	+/- 3.97
3M Semi Anechoic Chamber / 1G~18G	+/- 3.58
3M Semi Anechoic Chamber / 18G~26G	+/- 3.59
3M Semi Anechoic Chamber / 26G~40G	+/- 3.81

**Remark:** This uncertainty represents an expanded uncertainty expressed at approximately the 95% confidence level using a coverage factor of  $k=2$ .



## 5. FACILITIES AND ACCREDITATIONS

### 5.1 FACILITIES

All measurement facilities used to collect the measurement data are located at

NO. 989-1 Wen Shan Rd., Shang Shan Village, Qionglin Shiang Hsinchu County 30741,  
Taiwan, R.O.C

No.11, Wu-Gong 6th Rd., Wugu Industrial Park, New Taipei City 248, Taiwan (R.O.C.)  
Tel: 886-2-2299-9720 / Fax: 886-2-2298-4045

No.81-1, Lane 210, Bade 2nd Rd., Lujhu Township, Taoyuan County 33841, TAIWAN, R.O.C.  
Tel: 886-3-324-0332 / Fax: 886-3-324-5235

The sites are constructed in conformance with the requirements of ANSI C63.7, ANSI C63.4 and CISPR Publication 22.

### 5.2 EQUIPMENT

Radiated emissions are measured with one or more of the following types of linearly polarized antennas: tuned dipole, biconical, log periodic, bi-log, and/or ridged waveguide, horn. Spectrum analyzers with pre-selectors and quasi-peak detectors are used to perform radiated measurements.



Conducted emissions are measured with Line Impedance Stabilization Networks and EMI Test Receivers.

Calibrated wideband preamplifiers, coaxial cables, and coaxial attenuators are also used for making measurements.

All receiving equipment conforms to CISPR Publication 16-1, "Radio Interference Measuring Apparatus and Measurement Methods."



### 5.3 TABLE OF ACCREDITATIONS AND LISTINGS

Country	Agency	Scope of Accreditation	Logo
USA	FCC	3M Semi Anechoic Chamber (FCC MRA: TW1039) to perform FCC Part 15 measurements	 FCC MRA: TW1039
Taiwan	TAF	LP0002, RTTE01, FCC Method-47 CFR Part 15 Subpart C, D, E, RSS-210, RSS-310 IDA TS SRD, AS/NZS 4268, AS/NZS 4771, TS 12.1 & 12.2, ETSI EN 300 440-1, ETSI EN 300 440-2, ETSI EN 300 328, ETSI EN 300 220-1, ETSI EN 300 220-2, ETSI EN 301 893, ETSI EN 301 489-1/3/7/17 FCC OET Bulletin 65 + Supplement C, EN 50360, EN 50361, EN 50371, RSS 102, EN 50383, EN 50385, EN 50392, IEC 62209, CNS 14958-1, CNS 14959 FCC Method -47 CFR Part 15 Subpart B IEC / EN 61000-3-2, IEC / EN 61000-3-3, IEC / EN 61000-4-2/3/4/5/6/8/11	 Testing Laboratory 1309
Canada	Industry Canada	3M Semi Anechoic Chamber (IC 2324G-1 / IC 2324G-2) to perform	 IC 2324G-1 IC 2324G-2

\* No part of this report may be used to claim or imply product endorsement by A2LA or any agency of the US Government.



## 6. SETUP OF EQUIPMENT UNDER TEST

### 6.1 SETUP CONFIGURATION OF EUT

See test photographs attached in Appendix 1 for the actual connections between EUT and support equipment.

### 6.2 SUPPORT EQUIPMENT

No.	Product	Manufacturer	Model No.	Serial No.	FCC ID
1	Notebook PC	HP	ProBook 4421s	CNF03242PJ	DoC
2	LCD Monitor	ViewSonic	VA1918wm	R18082200388	DoC
3	Micro SD	SanDisk	SDSDM-1024	BB07251CTE	---
4	External hard drive	TeraSys	F12-U	4912A002	---
5	Modem	ZyXEL	Omni 56K	S1Z4107727	1880MNI56K
6	USB 3.0	ADATA	C103/16GB	---	---
7	CF Adaptor	iEI	1211004-0040	00082900065	---
8	USB 2.0	---	---	---	---

**Remark:**

1. All the equipment/cables were placed in the worst-case configuration to maximize the emission during the test.
2. Grounding was established in accordance with the manufacturer's requirements and conditions for the intended use.



## 7. FCC PART 15.247 REQUIREMENTS

### 7.1 DUTY CYCLE

#### Limit

KDB 789033

#### Test procedure

The transmitter output is connected to a spectrum analyzer or radiated field strength. The RBW is set to 1 MHz and the VBW is set to 1 MHz. The sweep time is coupled and the span is set to 0 Hz.

#### Test results

Mode	ON Time (msec)	Period (msec)	Duty Cycle (%)
IEEE 802.11b mode	2.343	2.359	99
IEEE 802.11g mode	2.057	2.057	100
IEEE 802.11n HT 20 MHz mode	0.9744	0.9899	98
IEEE 802.11n HT 40 MHz mode	0.4253	0.4563	93

Mode	ON Time (msec)	Period (msec)	Duty Cycle (%)
IEEE 802.11b mode	2.343	2.359	99
IEEE 802.11g mode	2.057	2.057	100
IEEE 802.11n HT 20 MHz mode	0.9744	0.9899	98
IEEE 802.11n HT 40 MHz mode	0.4253	0.4563	93



**Test Plot**

**IEEE 802.11b mode**

Agilent 15:42:30 Oct 9, 2012

R T

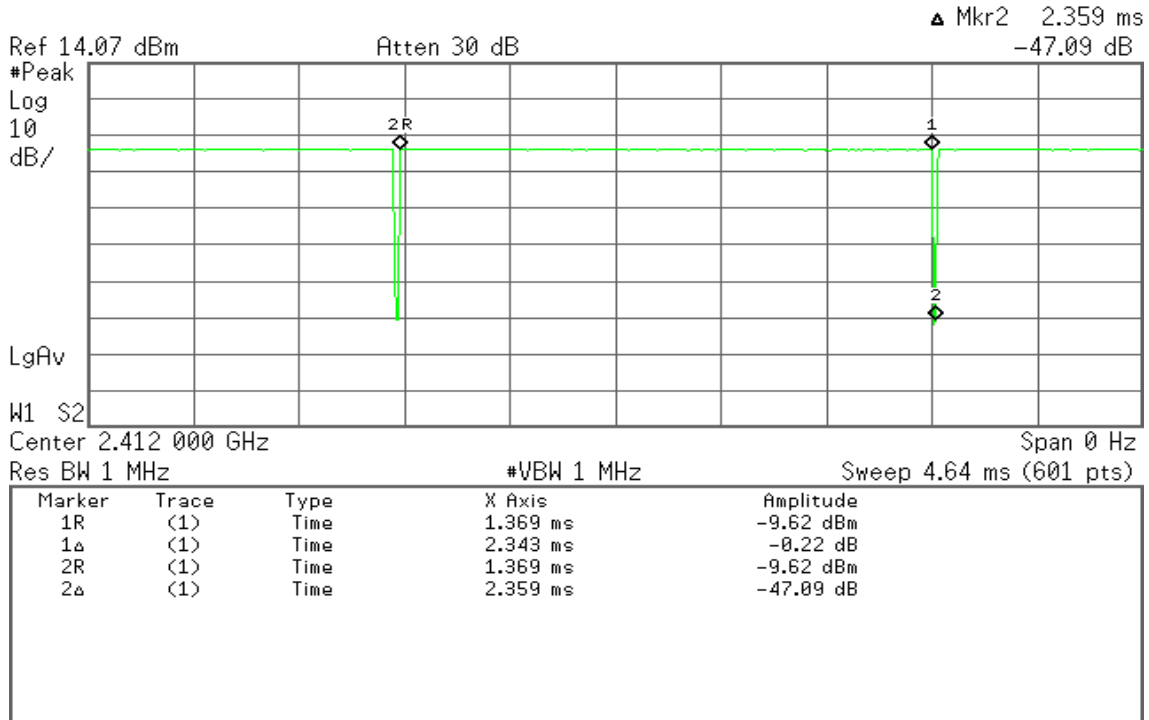

**IEEE 802.11g mode**

Agilent 15:44:30 Oct 9, 2012

R T

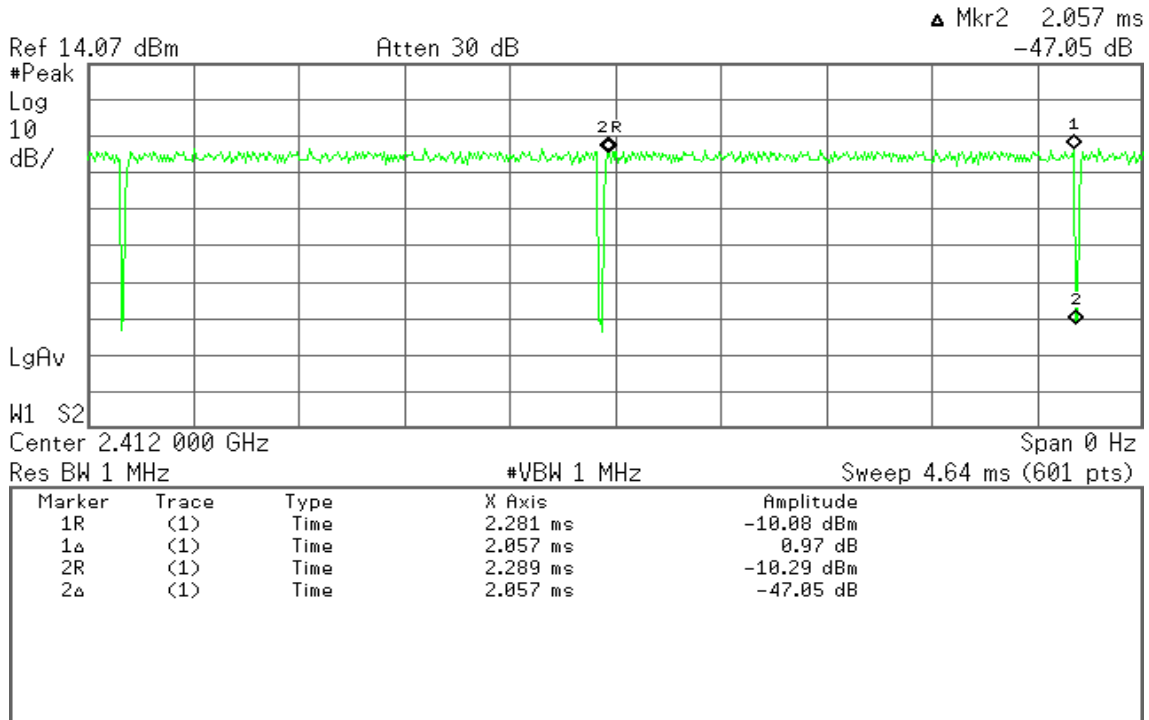





### IEEE 802.11n HT 20 MHz mode

Agilent 15:47:02 Oct 9, 2012

R T

Mkr2 989.9  $\mu$ s  
-46.27 dB

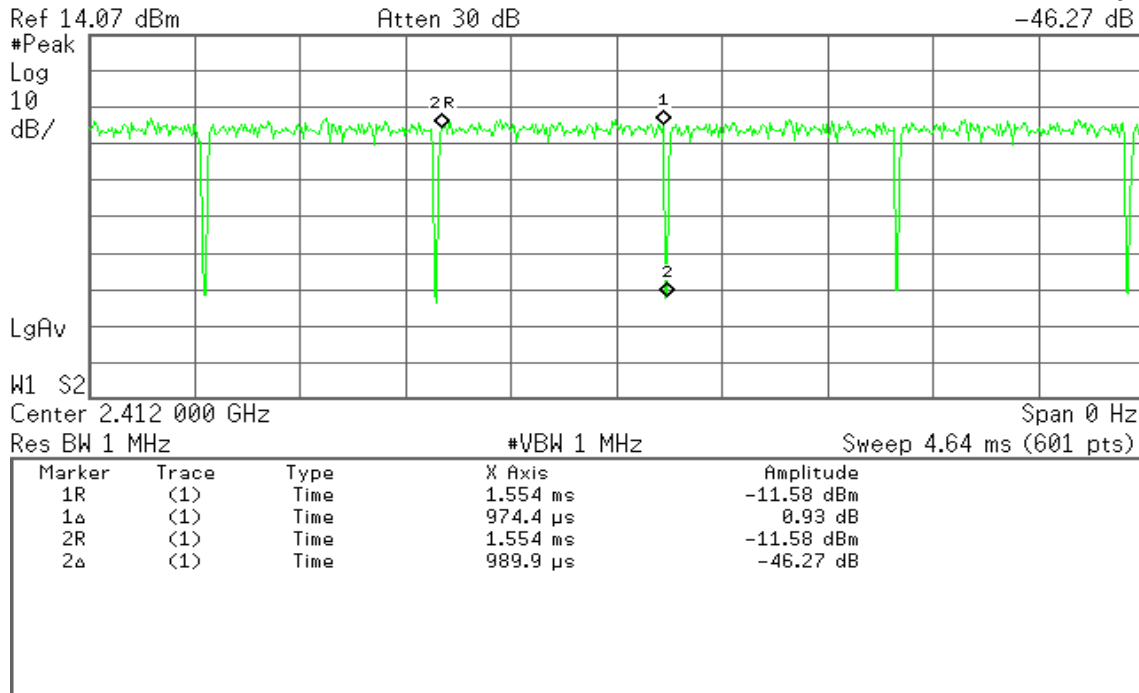

### IEEE 802.11n HT 40 MHz mode

Agilent 15:51:08 Oct 9, 2012

R T

Mkr2 456.3  $\mu$ s  
-41.96 dB

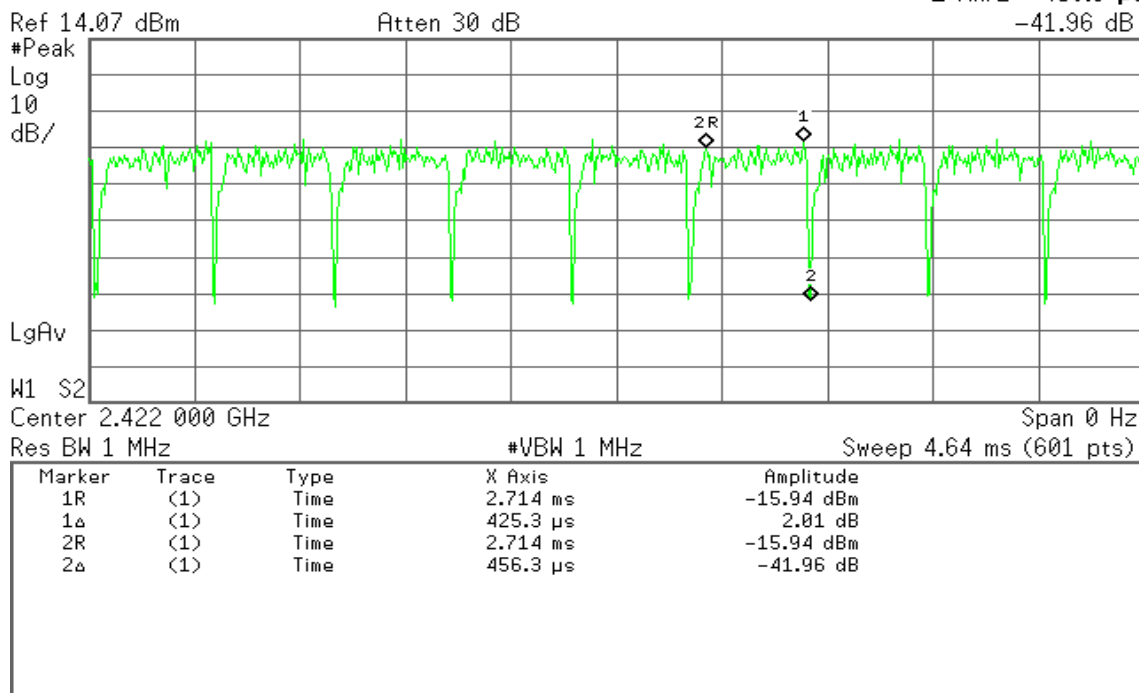



## 7.2 6dB BANDWIDTH

### LIMIT

According to §15.247(a)(2), systems using digital modulation techniques may operate in the 902 - 928 MHz, 2400 - 2483.5 MHz, and 5725 - 5850 MHz bands. The minimum 6dB bandwidth shall be at least 500 kHz.

### Test Configuration

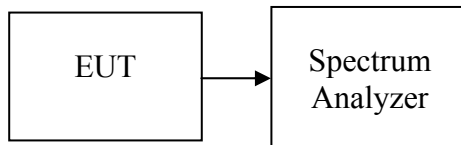

### TEST PROCEDURE

The transmitter output is connected to the spectrum analyzer. Set the RBW = 1%-5% of the emission bandwidth, VBW  $\geq 3 \times$  RBW, Detector = Peak, Trace mode = max hold, Sweep = auto couple. Measure the maximum width of the emission that is constrained by the frequencies associated with the two amplitude points (upper and lower) that are attenuated by 6dB relative to the maximum level measured in the fundamental emission.

### TEST RESULTS

*No non-compliance noted*



**Test Data**

**Test mode: IEEE 802.11b mode**

Channel	Frequency (MHz)	6dB Bandwidth (MHz)	Limit (kHz)	Result
Low	2412	10.4167	>500	PASS
Mid	2437	10.3334		PASS
High	2462	10.3334		PASS

**Test mode: IEEE 802.11g mode**

Channel	Frequency (MHz)	6dB Bandwidth (MHz)	Limit (kHz)	Result
Low	2412	16.1666	>500	PASS
Mid	2437	16.1666		PASS
High	2462	16.1666		PASS

**Test mode: IEEE 802.11n HT 20 MHz mode / Main Antenna**

Channel	Frequency (MHz)	6dB Bandwidth (MHz)	Limit (kHz)	Result
Low	2412	16.1667	>500	PASS
Mid	2437	16.5833		PASS
High	2462	17.5833		PASS

**Test mode: IEEE 802.11n HT 20 MHz mode / Aux Antenna**

Channel	Frequency (MHz)	6dB Bandwidth (MHz)	Limit (kHz)	Result
Low	2412	17.6666	>500	PASS
Mid	2437	17.5833		PASS
High	2462	17.6666		PASS

**Test mode: IEEE 802.11n HT 40 MHz mode / Main Antenna**

Channel	Frequency (MHz)	6dB Bandwidth (MHz)	Limit (kHz)	Result
Low	2422	36.1667	>500	PASS
Mid	2437	36.3334		PASS
High	2452	35.6666		PASS

**Test mode: IEEE 802.11n HT 40 MHz mode / Aux Antenna**

Channel	Frequency (MHz)	6dB Bandwidth (MHz)	Limit (kHz)	Result
Low	2422	34	>500	PASS
Mid	2437	36.3334		PASS
High	2452	34.9166		PASS



**Test mode: IEEE 802.11a mode**

Channel	Frequency (MHz)	6dB Bandwidth (MHz)	Limit (kHz)	Result
Low	5745	16.5833	>500	PASS
Mid	5785	16.5		PASS
High	5825	16.5833		PASS

**Test mode: IEEE 802.11n HT 20 MHz mode**

Channel	Frequency (MHz)	6dB Bandwidth (MHz)	Limit (kHz)	Result
Low	5745	17.8334	>500	PASS
Mid	5785	17.9167		PASS
High	5825	17.75		PASS

**Test mode: IEEE 802.11n HT 40 MHz mode**

Channel	Frequency (MHz)	6dB Bandwidth (MHz)	Limit (kHz)	Result
Low	5755	26.6	>500	PASS
High	5795	34.8		PASS



**Test Plot**

**IEEE 802.11b mode**

**6dB Bandwidth (CH Low)**

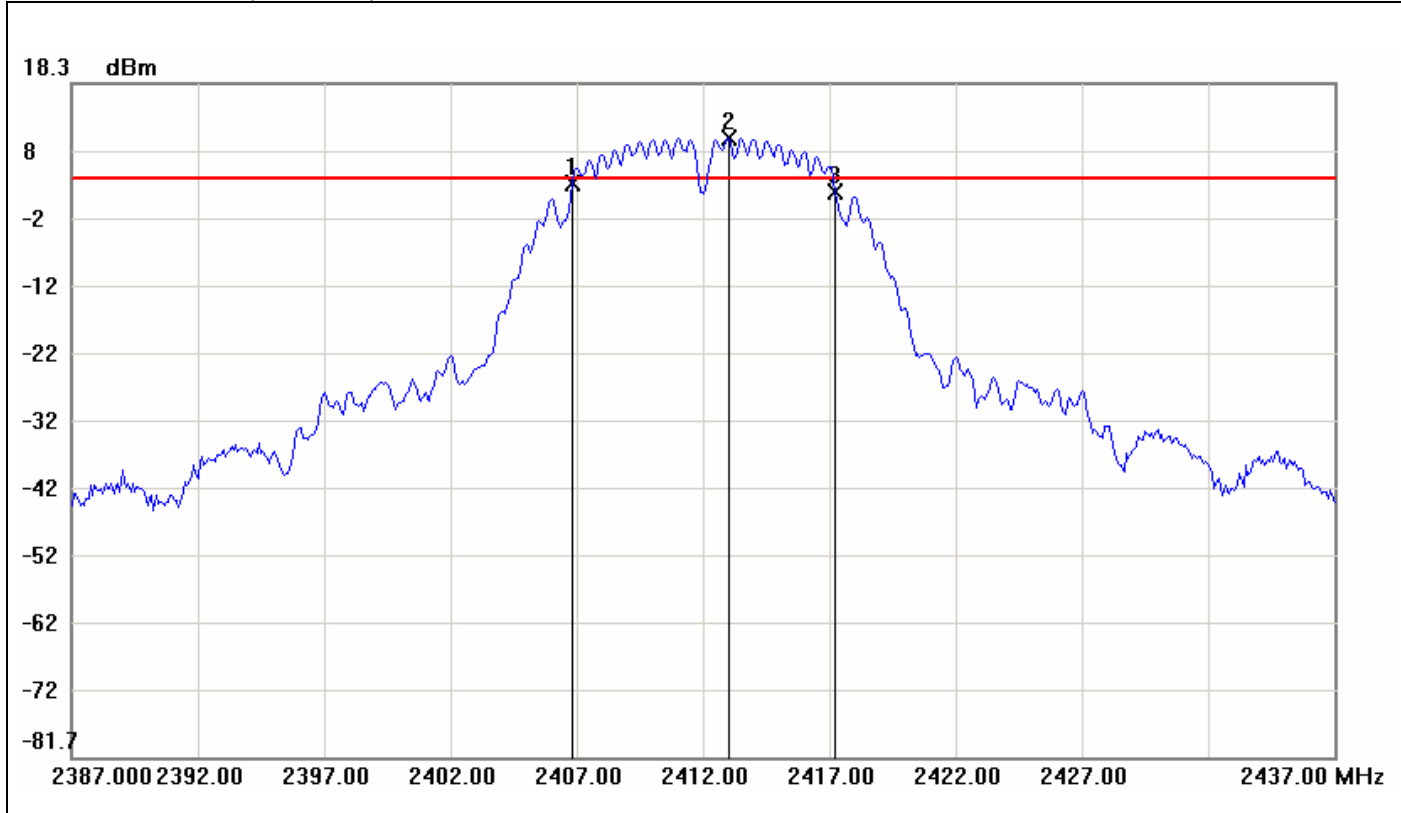

No.	Frequency(MHz)	Result(dBm)	Limit(dBm)	Margin(dBm)
1	2406.8333	3.44	4.12	-0.68
2	2413.0000	10.12	4.12	6.00
3	2417.2500	2.25	4.12	-1.87

No.		$\Delta$ Frequency(MHz)	$\Delta$ Level(dB)
1	mk3-mk1	10.4167	-1.19



**6dB Bandwidth (CH Mid)**

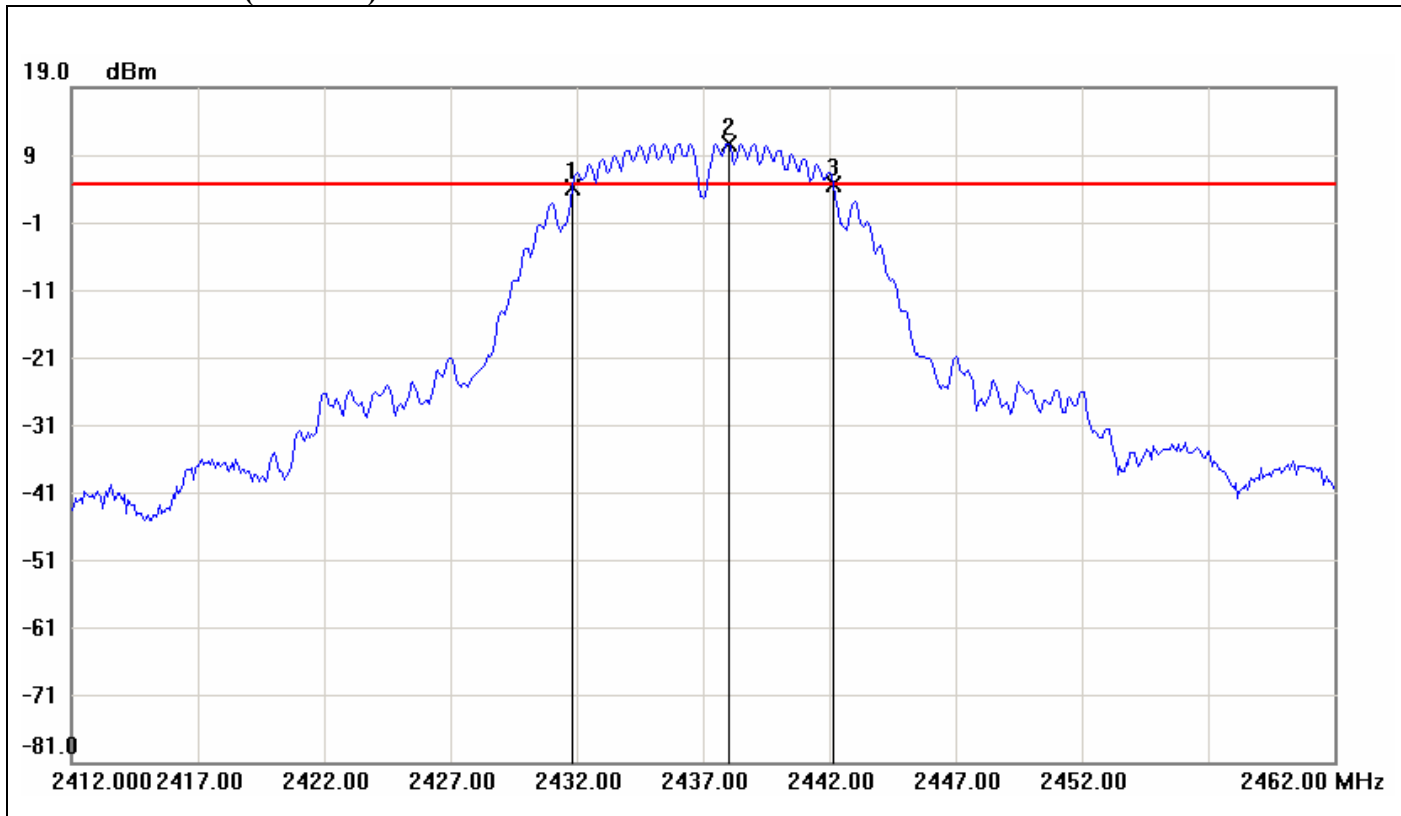

No.	Frequency(MHz)	Result(dBm)	Limit(dBm)	Margin(dBm)
1	2431.8333	4.10	4.72	-0.62
2	2438.0000	10.72	4.72	6.00
3	2437.1667	4.67	4.72	-0.05

No.		$\Delta$ Frequency(MHz)	$\Delta$ Level(dB)
1	mk3-mk1	10.3334	0.57



**6dB Bandwidth (CH High)**

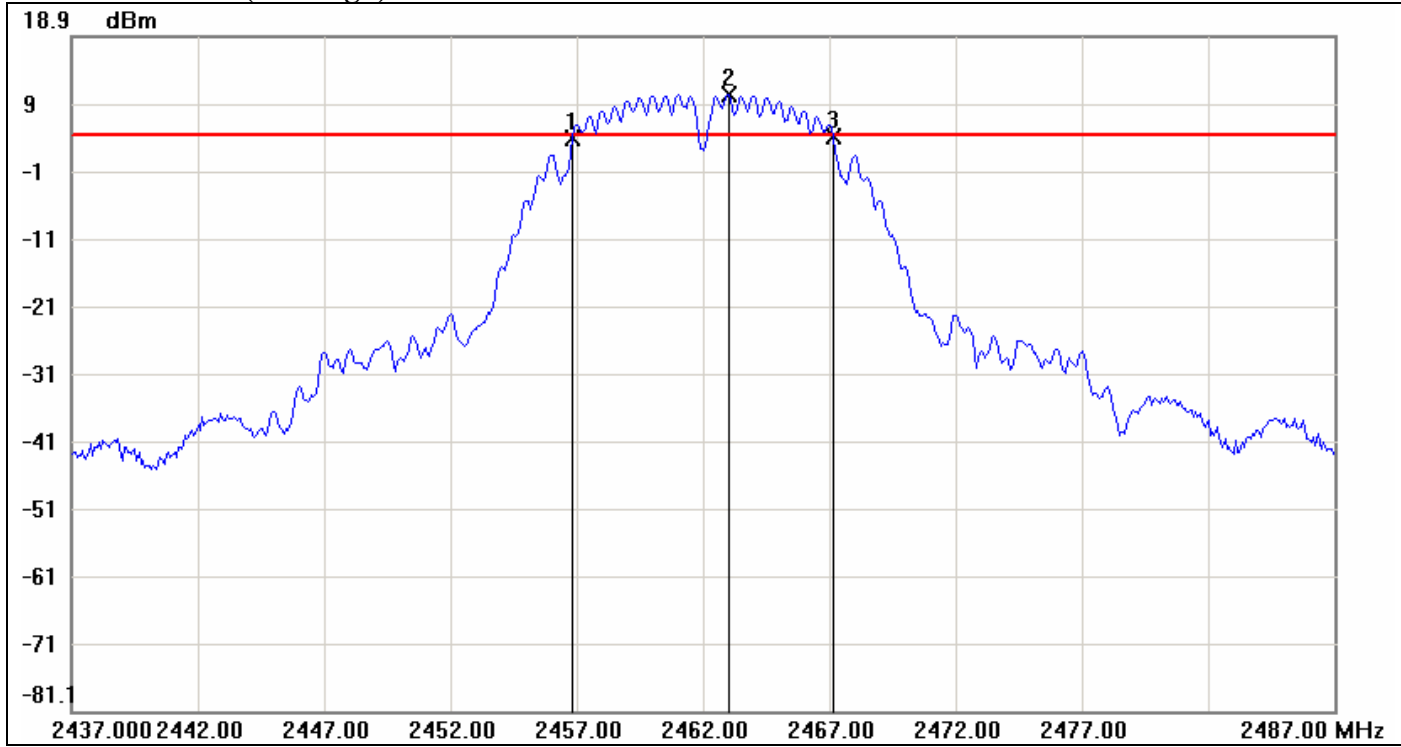

No.	Frequency(MHz)	Result(dBm)	Limit(dBm)	Margin(dBm)
1	2456.8333	3.72	4.22	-0.50
2	2463.0000	10.22	4.22	6.00
3	2467.1667	3.95	4.22	-0.27

No.		$\Delta$ Frequency(MHz)	$\Delta$ Level(dB)
1	mk3-mk1	10.3334	0.23



IEEE 802.11g mode

6dB Bandwidth (CH Low)

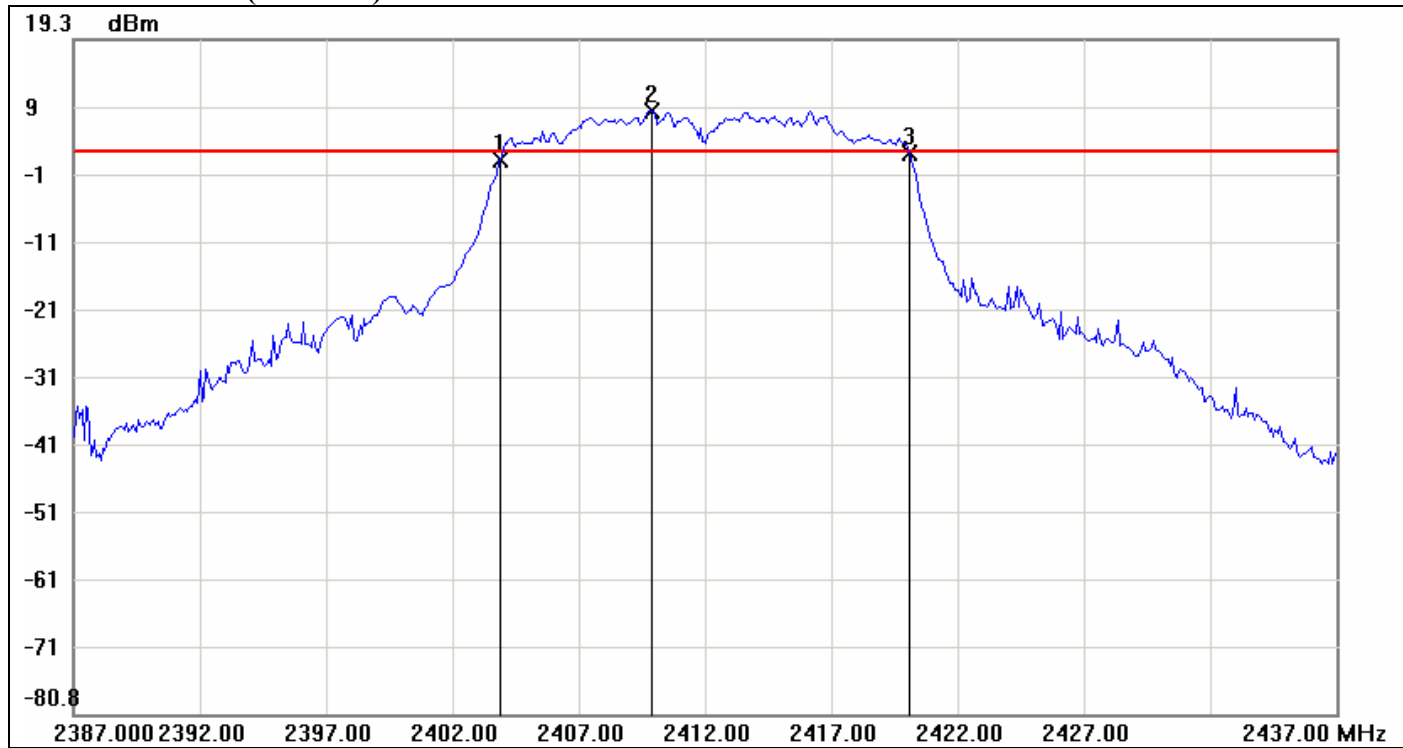

No.	Frequency(MHz)	Result(dBm)	Limit(dBm)	Margin(dBm)
1	2403.9167	1.44	2.74	-1.30
2	2409.9167	8.74	2.74	6.00
3	2420.0833	2.37	2.74	-0.37

No.		$\Delta$ Frequency(MHz)	$\Delta$ Level(dB)
1	mk3-mk1	16.1666	0.93





**6dB Bandwidth (CH Mid)**

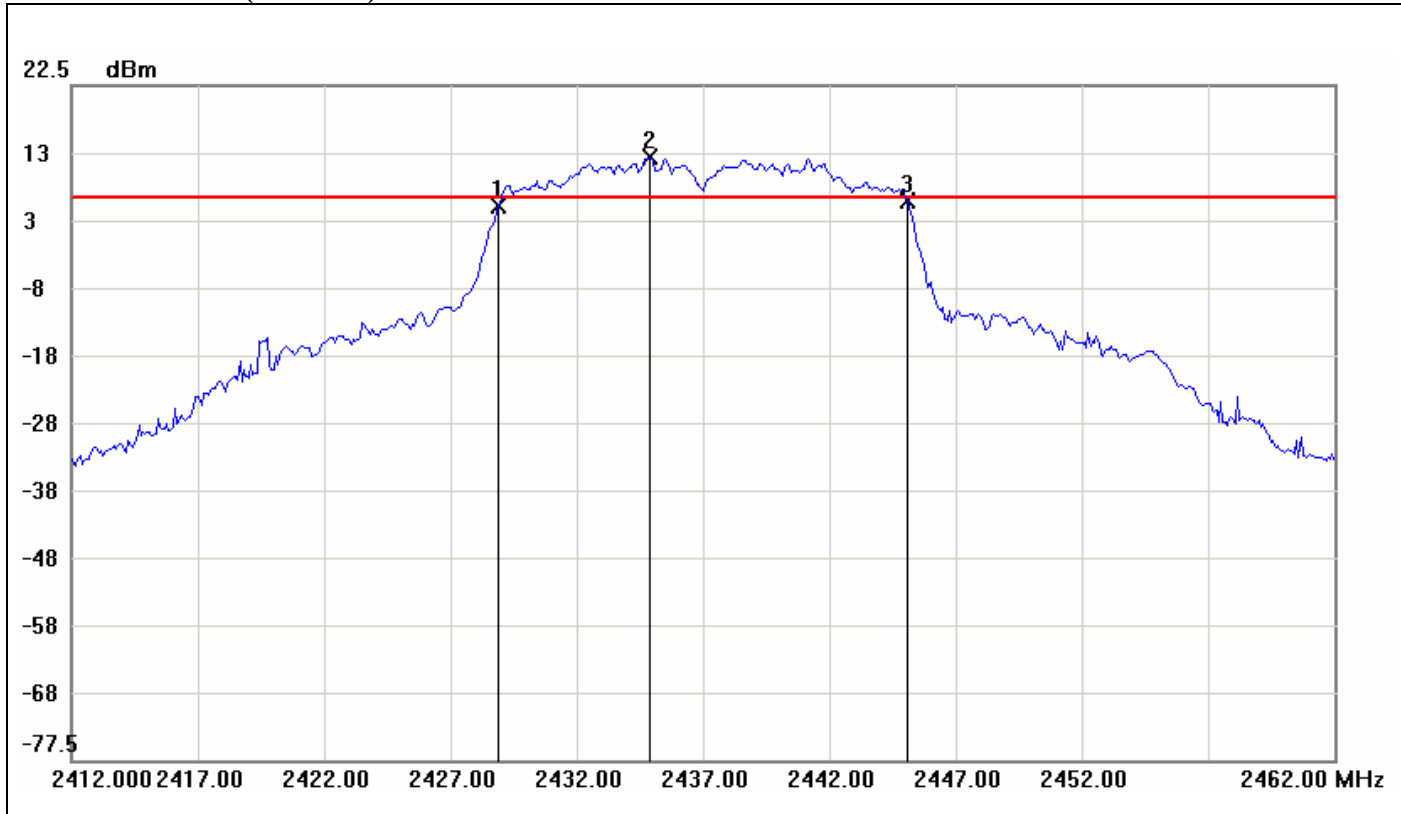

No.	Frequency(MHz)	Result(dBm)	Limit(dBm)	Margin(dBm)
1	2428.9167	4.68	5.83	-1.15
2	2434.9167	11.83	5.83	6.00
3	2445.0833	5.36	5.83	-0.47

No.		$\Delta$ Frequency(MHz)	$\Delta$ Level(dB)
1	mk3-mk1	16.1666	0.68



**6dB Bandwidth (CH High)**

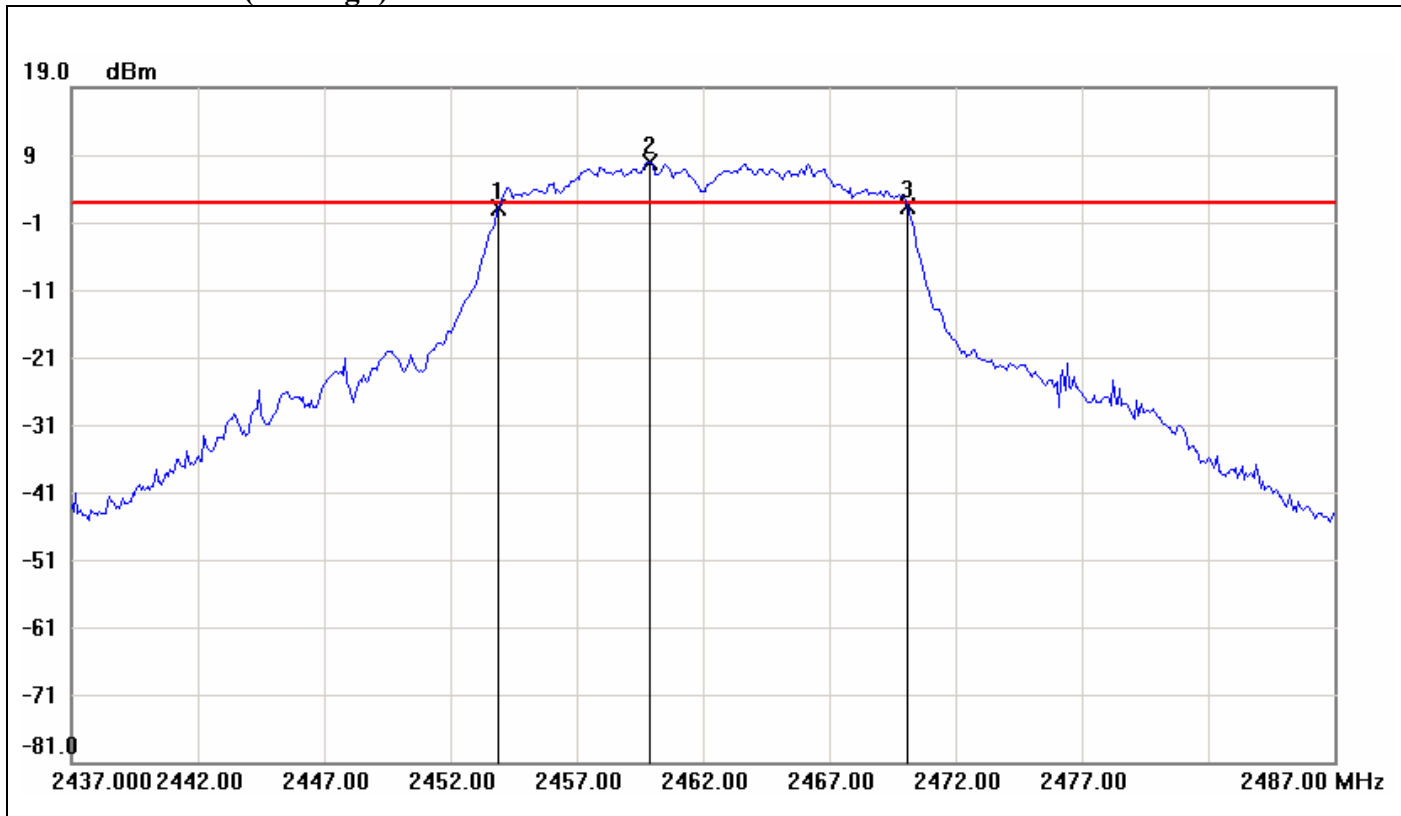

No.	Frequency(MHz)	Result(dBm)	Limit(dBm)	Margin(dBm)
1	2453.9167	1.03	1.96	-0.93
2	2459.9167	7.96	1.96	6.00
3	2470.0833	1.35	1.96	-0.61

No.		$\Delta$ Frequency(MHz)	$\Delta$ Level(dB)
1	mk3-mk1	16.1666	0.32



IEEE 802.11n HT 20 MHz mode / Main Antenna

6dB Bandwidth (CH Low)

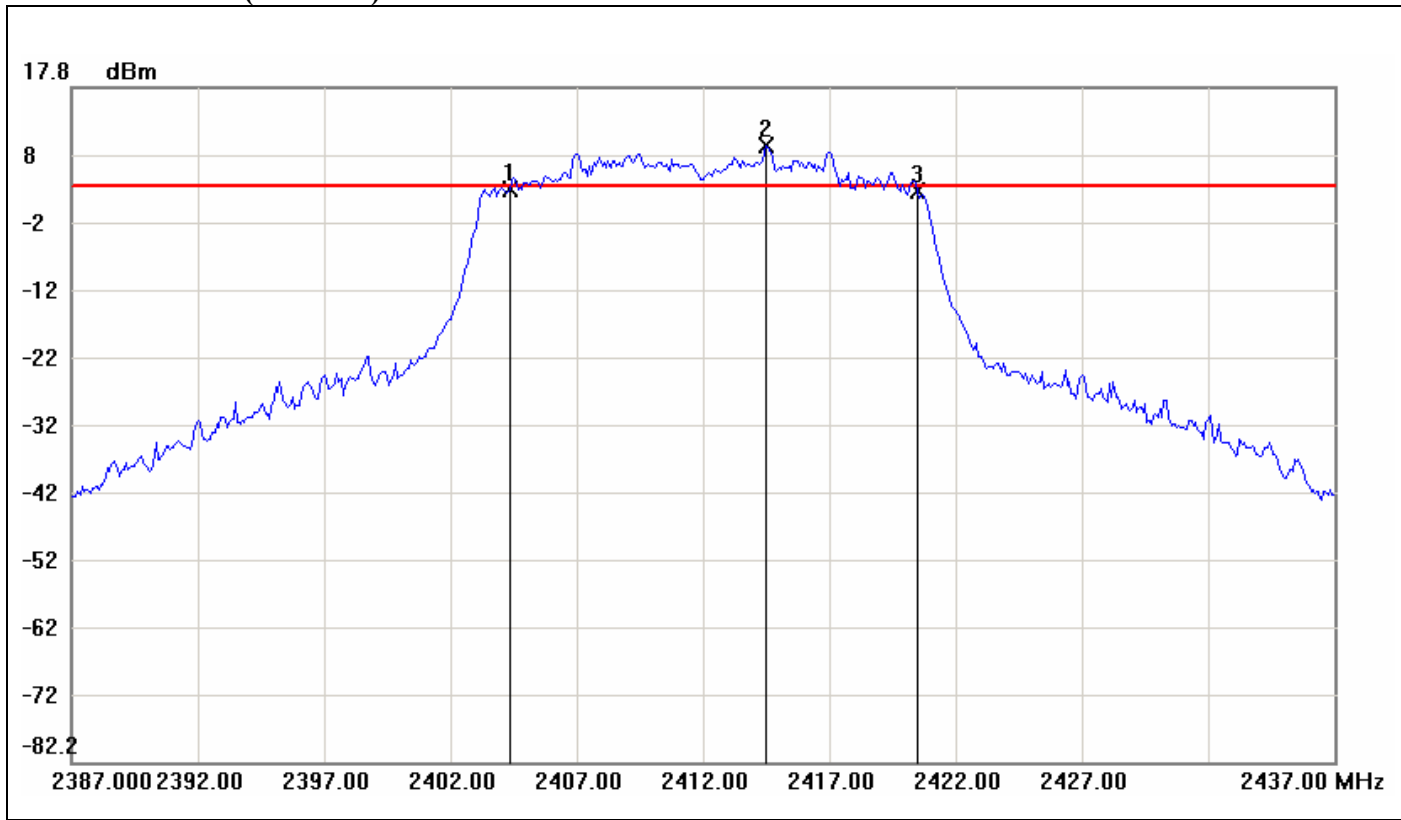

No.	Frequency(MHz)	Result(dBm)	Limit(dBm)	Margin(dBm)
1	2404.3333	2.60	3.15	-0.55
2	2414.5000	9.15	3.15	6.00
3	2420.5000	2.41	3.15	-0.74

No.		$\Delta$ Frequency(MHz)	$\Delta$ Level(dB)
1	mk3-mk1	16.1667	-0.19



**6dB Bandwidth (CH Mid)**

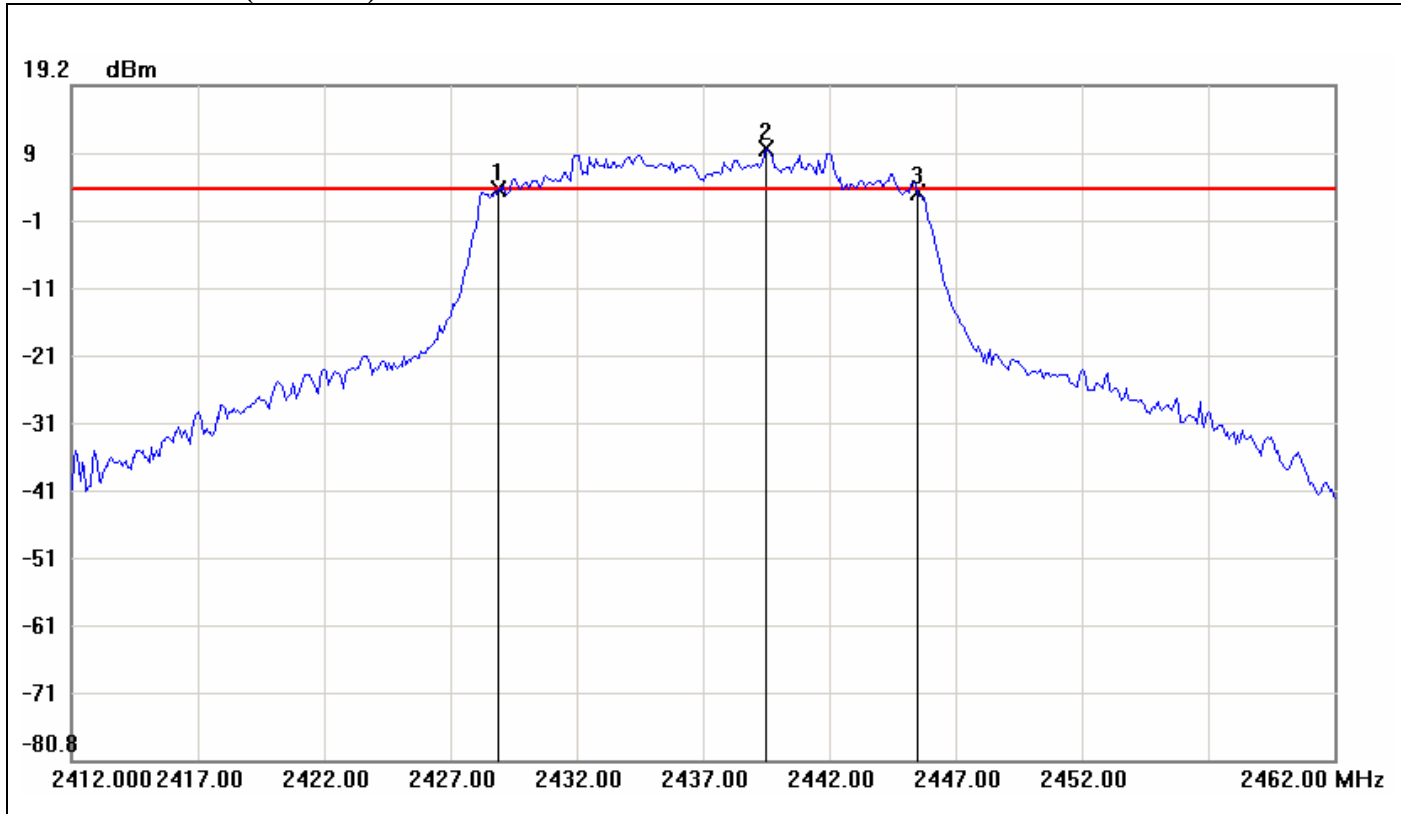

No.	Frequency(MHz)	Result(dBm)	Limit(dBm)	Margin(dBm)
1	2428.9167	3.68	3.69	-0.01
2	2439.5000	9.69	3.69	6.00
3	2445.5000	3.34	3.69	-0.35

No.		$\Delta$ Frequency(MHz)	$\Delta$ Level(dB)
1	mk3-mk1	16.5833	-0.34



**6dB Bandwidth (CH High)**

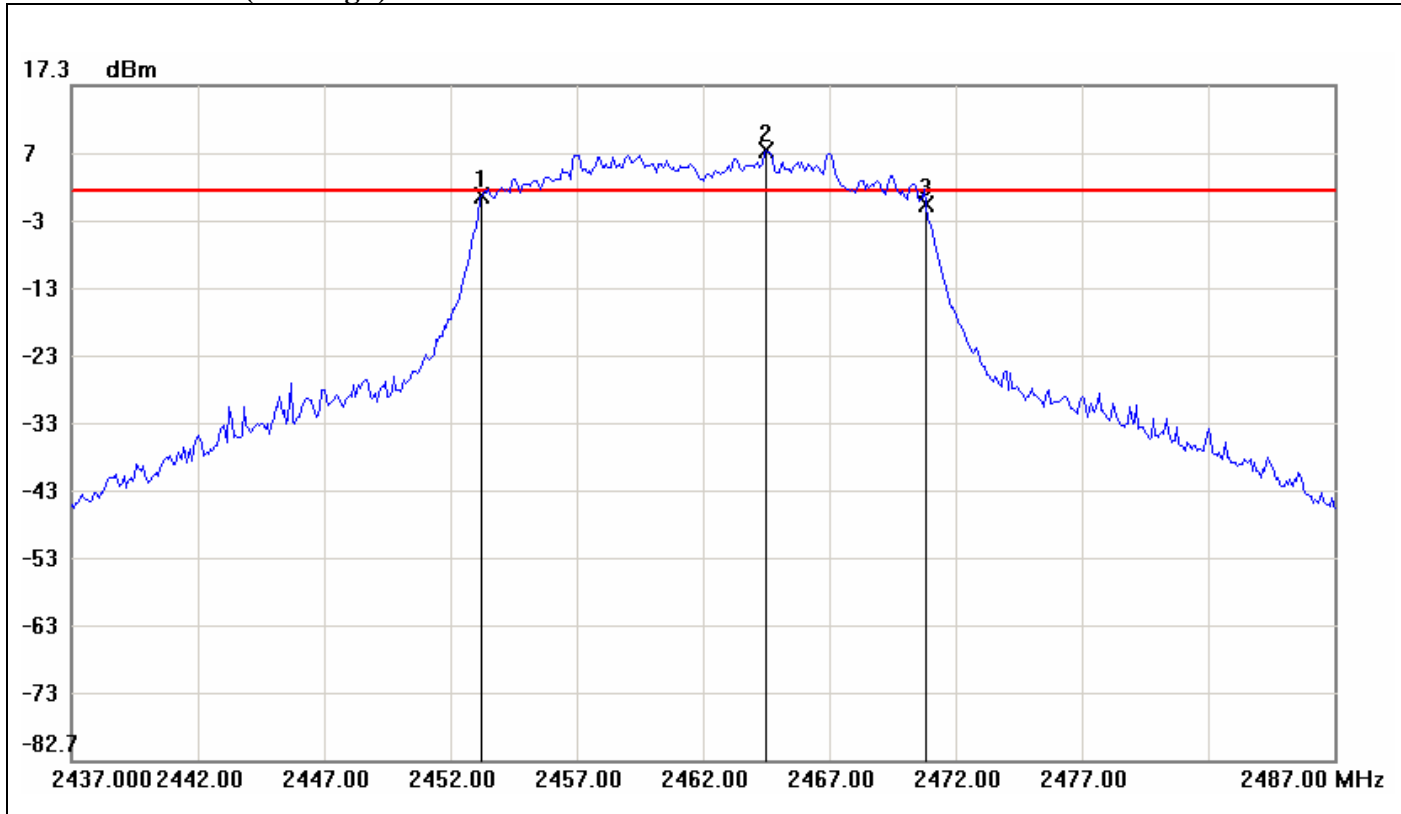

No.	Frequency(MHz)	Result(dBm)	Limit(dBm)	Margin(dBm)
1	2453.2500	1.08	1.60	-0.52
2	2464.5000	7.60	1.60	6.00
3	2470.8333	-0.29	1.60	-1.89

No.		$\Delta$ Frequency(MHz)	$\Delta$ Level(dB)
1	mk3-mk1	17.5833	-1.37



IEEE 802.11n HT 20 MHz mode / Aux Antenna

6dB Bandwidth (CH Low)

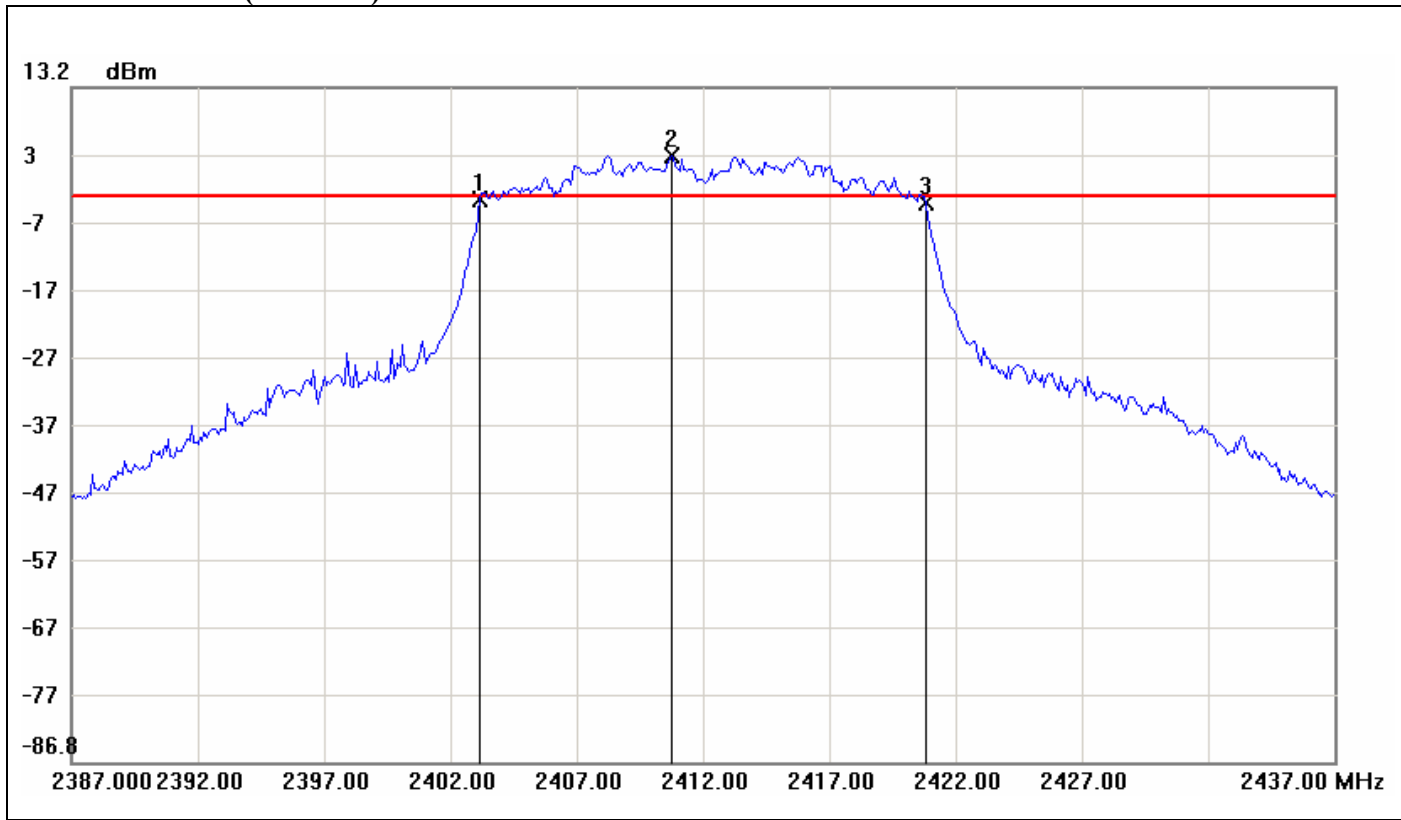

No.	Frequency(MHz)	Result(dBm)	Limit(dBm)	Margin(dBm)
1	2403.1667	-3.43	-2.89	-0.54
2	2410.7500	3.11	-2.89	6.00
3	2420.8333	-3.89	-2.89	-1.00

No.		$\Delta$ Frequency(MHz)	$\Delta$ Level(dB)
1	mk3-mk1	17.6666	-0.46



**6dB Bandwidth (CH Mid)**

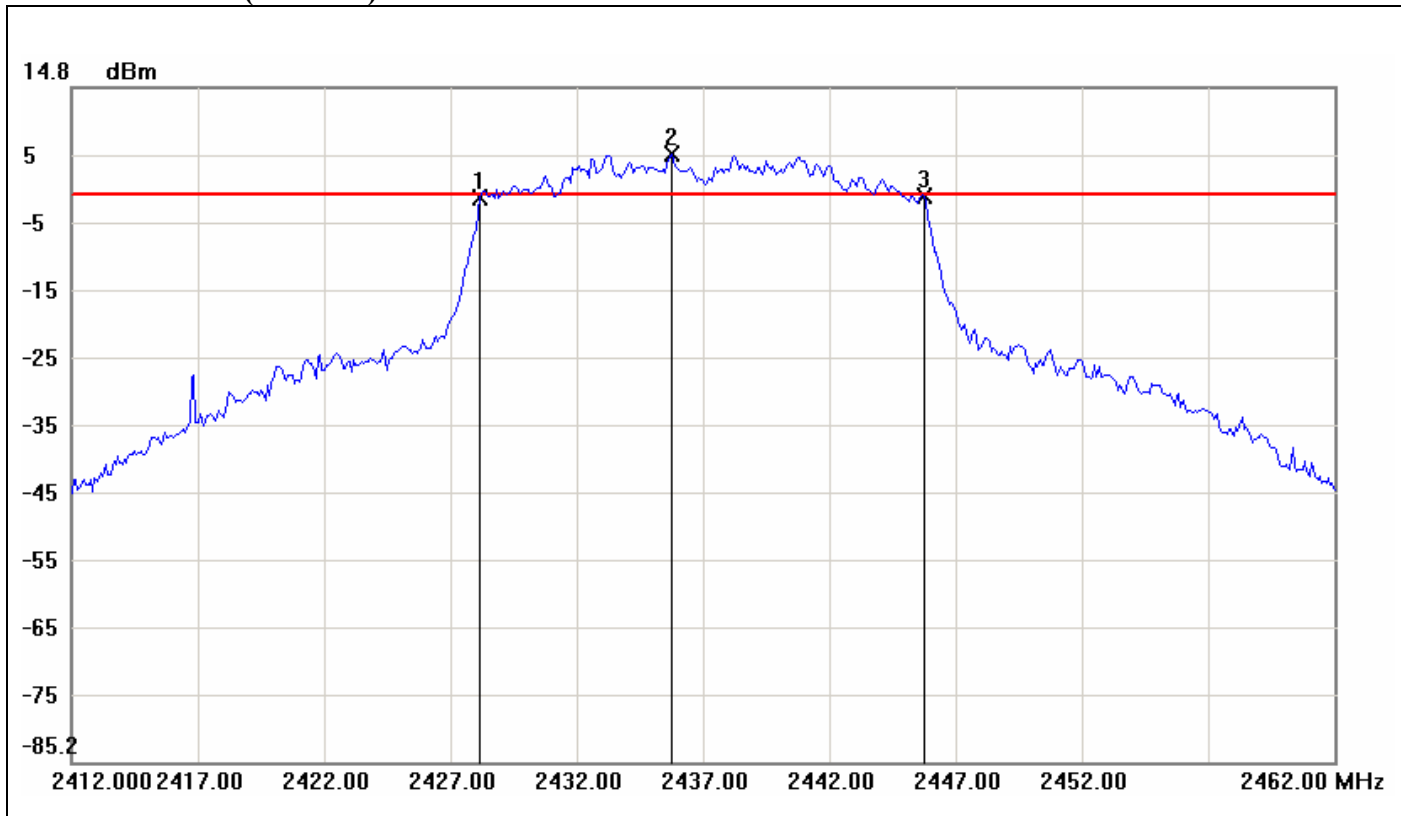

No.	Frequency(MHz)	Result(dBm)	Limit(dBm)	Margin(dBm)
1	2428.1667	-1.46	-1.17	-0.29
2	2435.7500	4.83	-1.17	6.00
3	2445.7500	-1.34	-1.17	-0.17

No.		$\Delta$ Frequency(MHz)	$\Delta$ Level(dB)
1	mk3-mk1	17.5833	0.12



**6dB Bandwidth (CH High)**

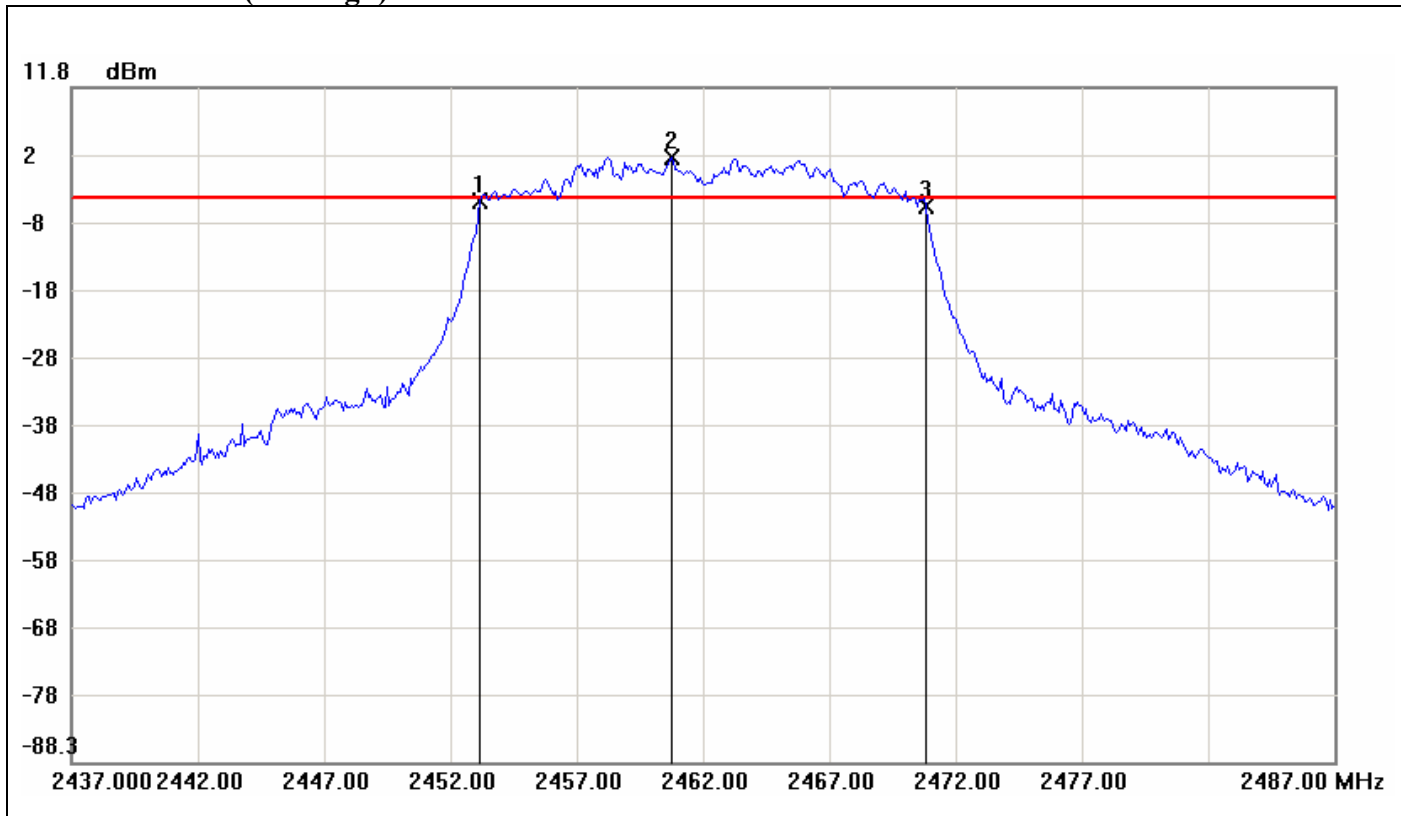

No.	Frequency(MHz)	Result(dBm)	Limit(dBm)	Margin(dBm)
1	2453.1667	-5.11	-4.64	-0.47
2	2460.7500	1.36	-4.64	6.00
3	2470.8333	-5.81	-4.64	-1.17

No.		$\Delta$ Frequency(MHz)	$\Delta$ Level(dB)
1	mk3-mk1	17.6666	-0.7





IEEE 802.11n HT 40 MHz mode / Main Antenna

6dB Bandwidth (CH Low)

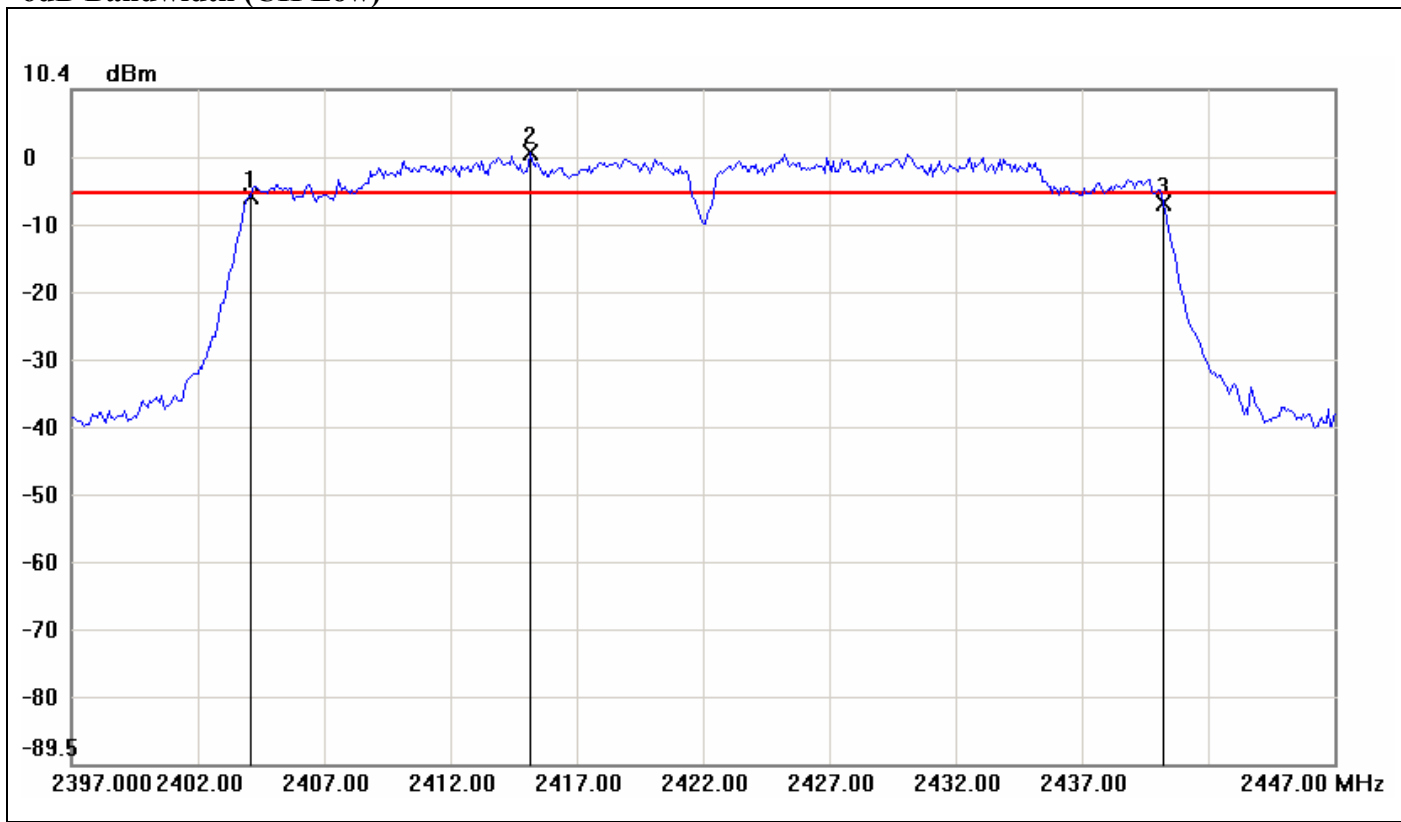

No.	Frequency(MHz)	Result(dBm)	Limit(dBm)	Margin(dBm)
1	2404.0833	-5.41	-5.01	-0.40
2	2415.1667	0.99	-5.01	6.00
3	2440.2500	-6.33	-5.01	-1.32

No.		$\Delta$ Frequency(MHz)	$\Delta$ Level(dB)
1	mk3-mk1	36.1667	-0.92



**6dB Bandwidth (CH Mid)**

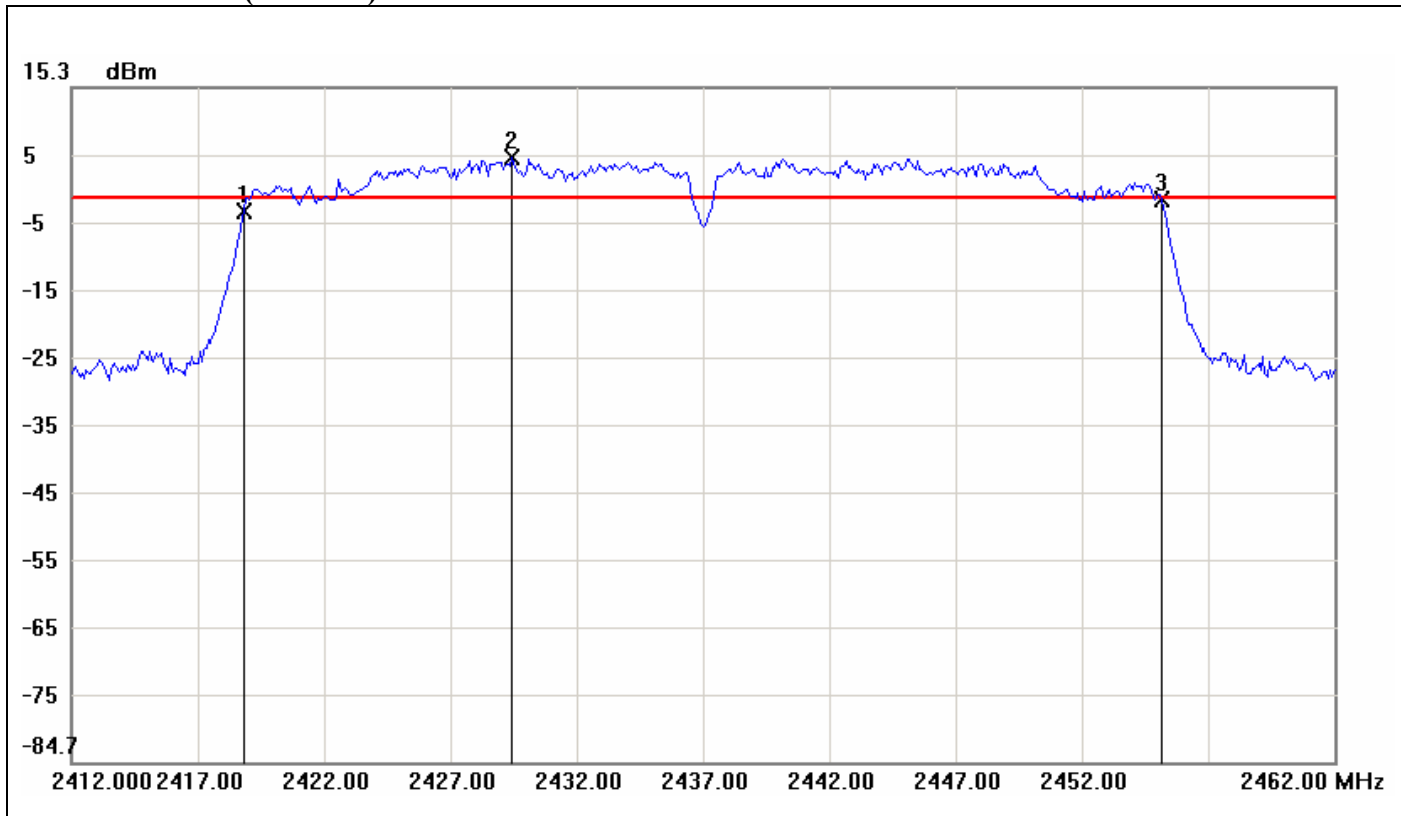

No.	Frequency(MHz)	Result(dBm)	Limit(dBm)	Margin(dBm)
1	2418.8333	-3.12	-1.15	-1.97
2	2429.4167	4.85	-1.15	6.00
3	2455.1667	-1.22	-1.15	-0.07

No.		$\Delta$ Frequency(MHz)	$\Delta$ Level(dB)
1	mk3-mk1	36.3334	1.9



### 6dB Bandwidth (CH High)

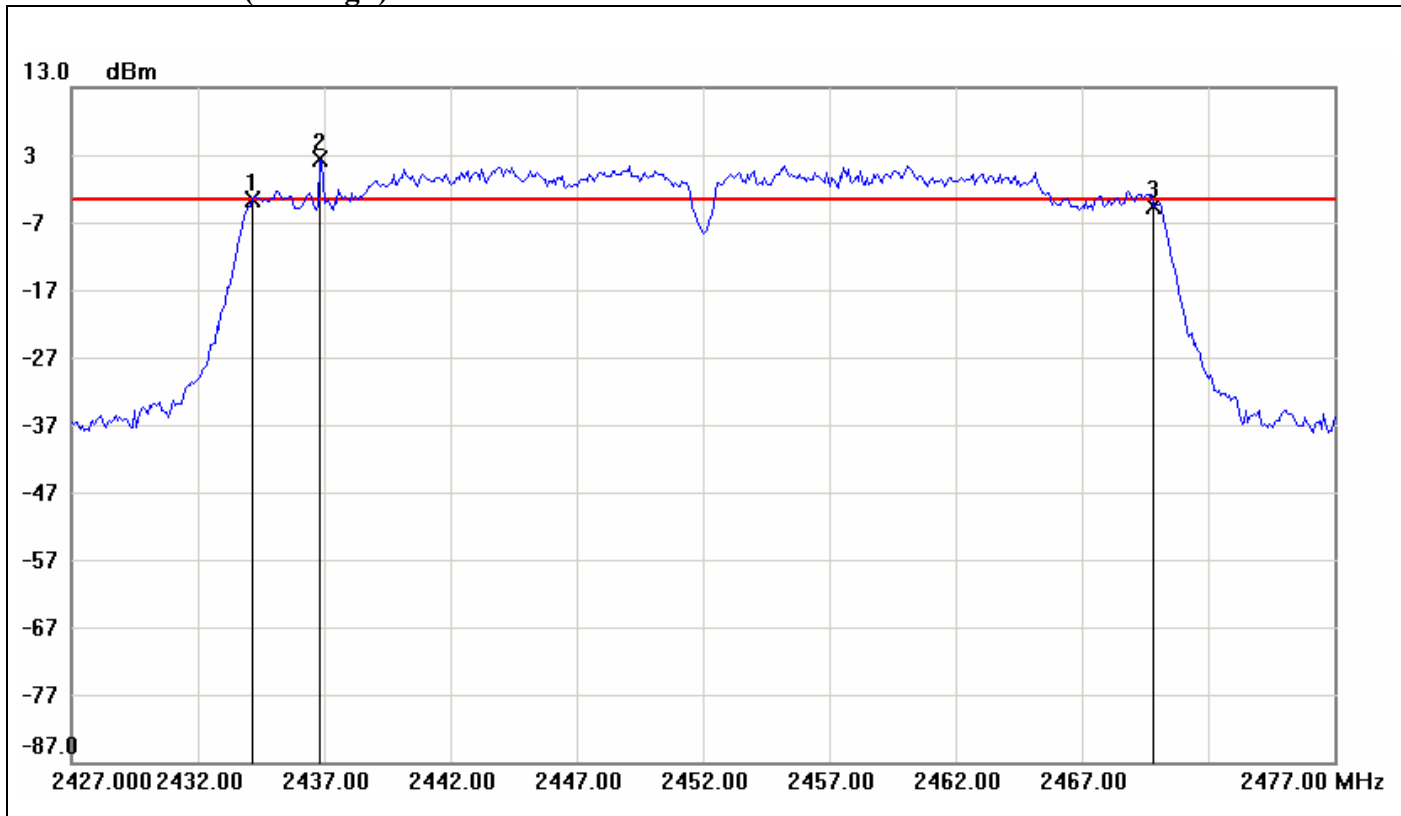

No.	Frequency(MHz)	Result(dBm)	Limit(dBm)	Margin(dBm)
1	2434.1667	-3.55	-3.53	-0.02
2	2436.8333	2.47	-3.53	6.00
3	2469.8333	-4.54	-3.53	-1.01

No.		$\Delta$ Frequency(MHz)	$\Delta$ Level(dB)
1	mk3-mk1	35.6666	-0.99



IEEE 802.11n HT 40 MHz mode / Aux Antenna

6dB Bandwidth (CH Low)

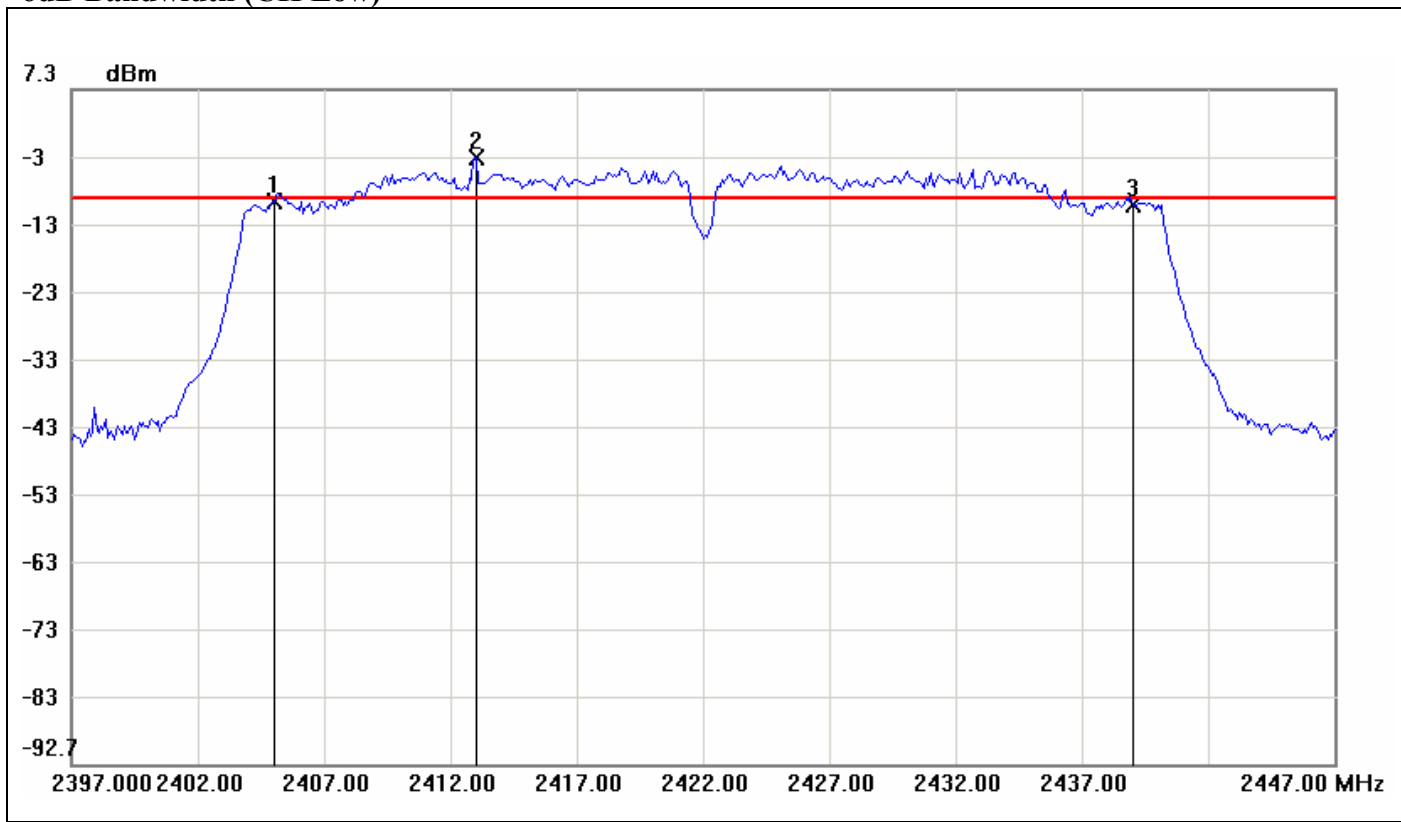

No.	Frequency(MHz)	Result(dBm)	Limit(dBm)	Margin(dBm)
1	2405.0000	-9.36	-8.79	-0.57
2	2413.0000	-2.79	-8.79	6.00
3	2439.0000	-9.83	-8.79	-1.04

No.		$\Delta$ Frequency(MHz)	$\Delta$ Level(dB)
1	mk3-mk1	34	-0.47



**6dB Bandwidth (CH Mid)**

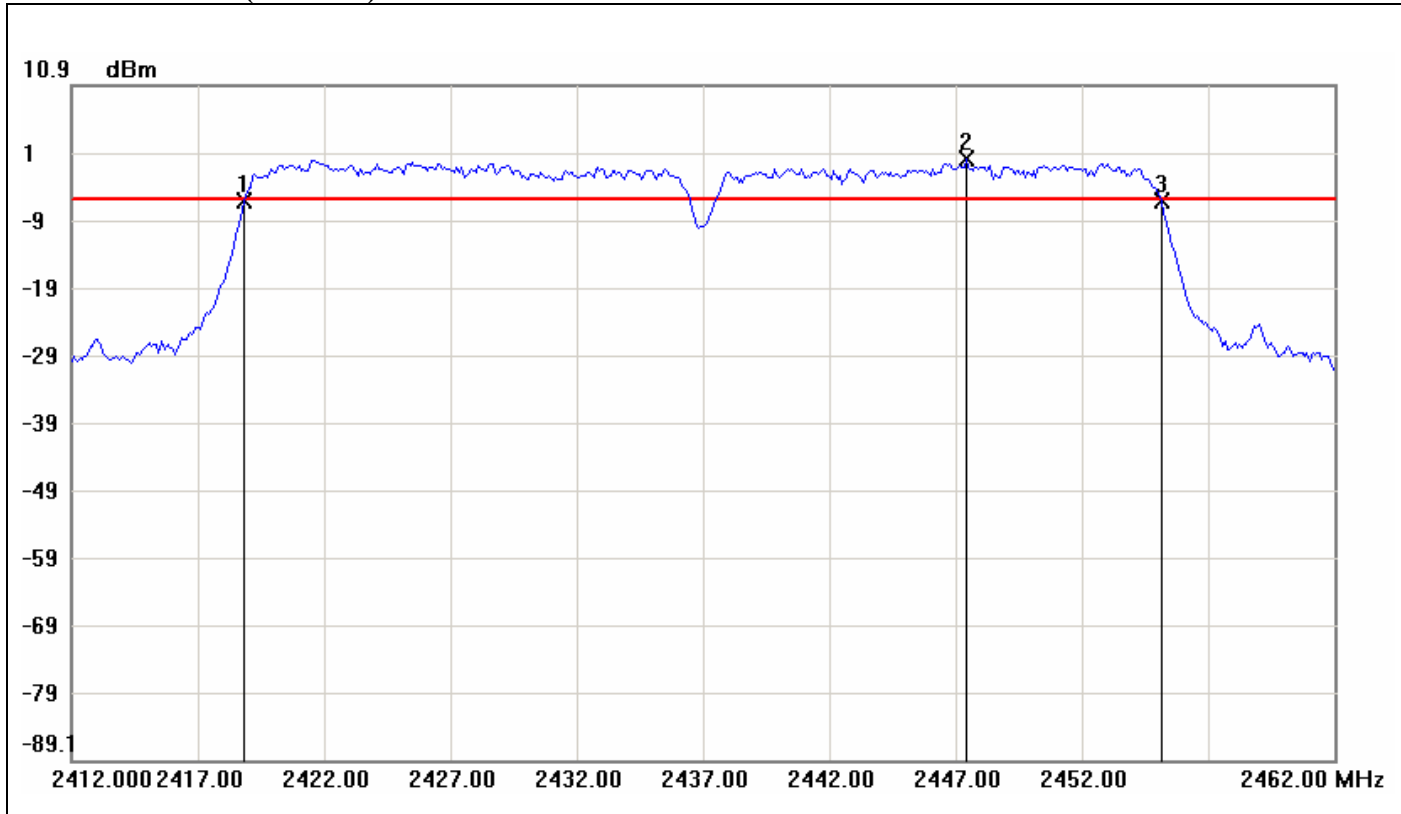

No.	Frequency(MHz)	Result(dBm)	Limit(dBm)	Margin(dBm)
1	2418.8333	-6.20	-6.10	-0.10
2	2447.4167	-0.10	-6.10	6.00
3	2455.1667	-6.28	-6.10	-0.18

No.		$\Delta$ Frequency(MHz)	$\Delta$ Level(dB)
1	mk3-mk1	36.3334	-0.08



**6dB Bandwidth (CH High)**

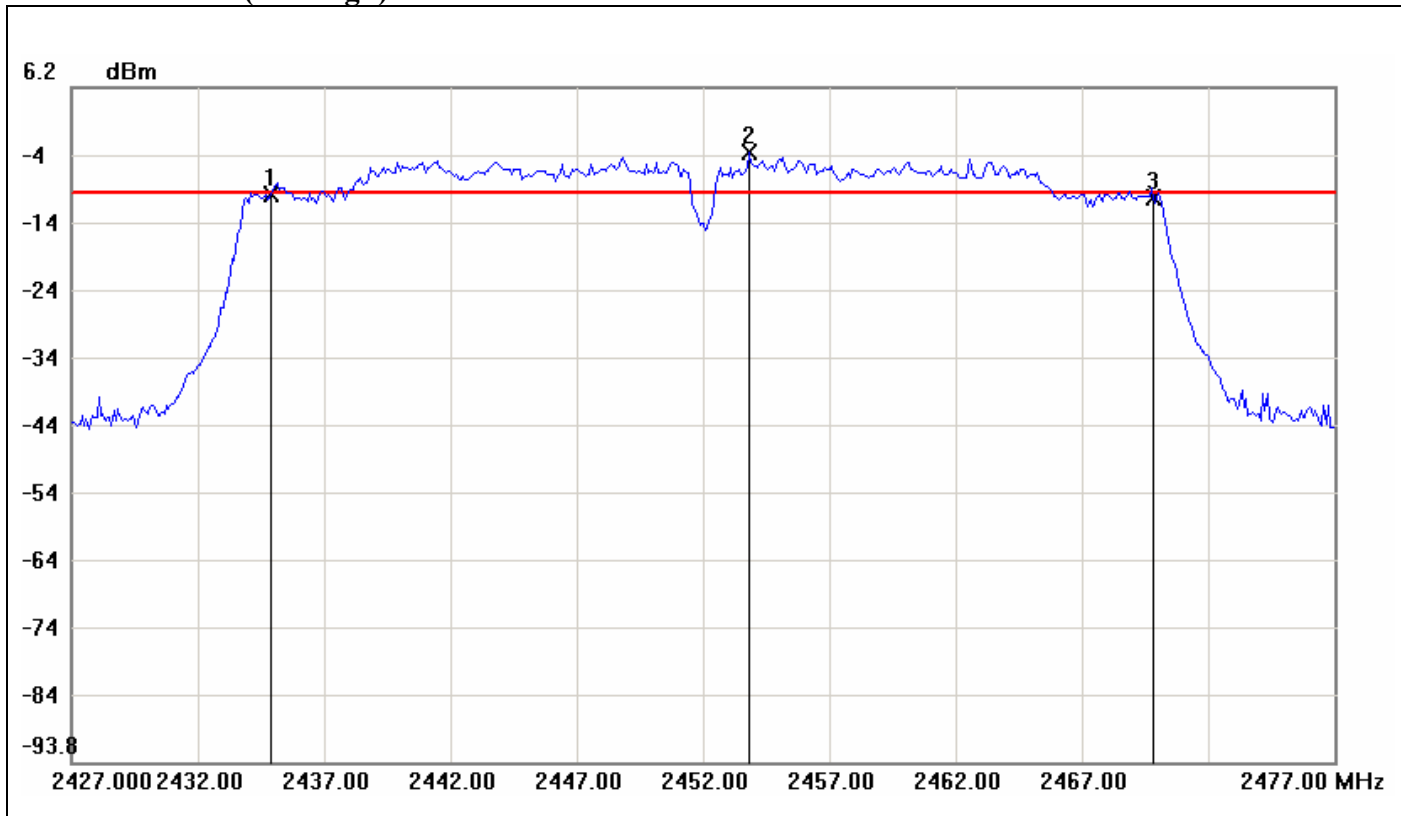

No.	Frequency(MHz)	Result(dBm)	Limit(dBm)	Margin(dBm)
1	2434.9167	-9.71	-9.45	-0.26
2	2453.8333	-3.45	-9.45	6.00
3	2469.8333	-10.18	-9.45	-0.73

No.		$\Delta$ Frequency(MHz)	$\Delta$ Level(dB)
1	mk3-mk1	34.9166	-0.47



IEEE 802.11a mode

6dB Bandwidth (CH Low)

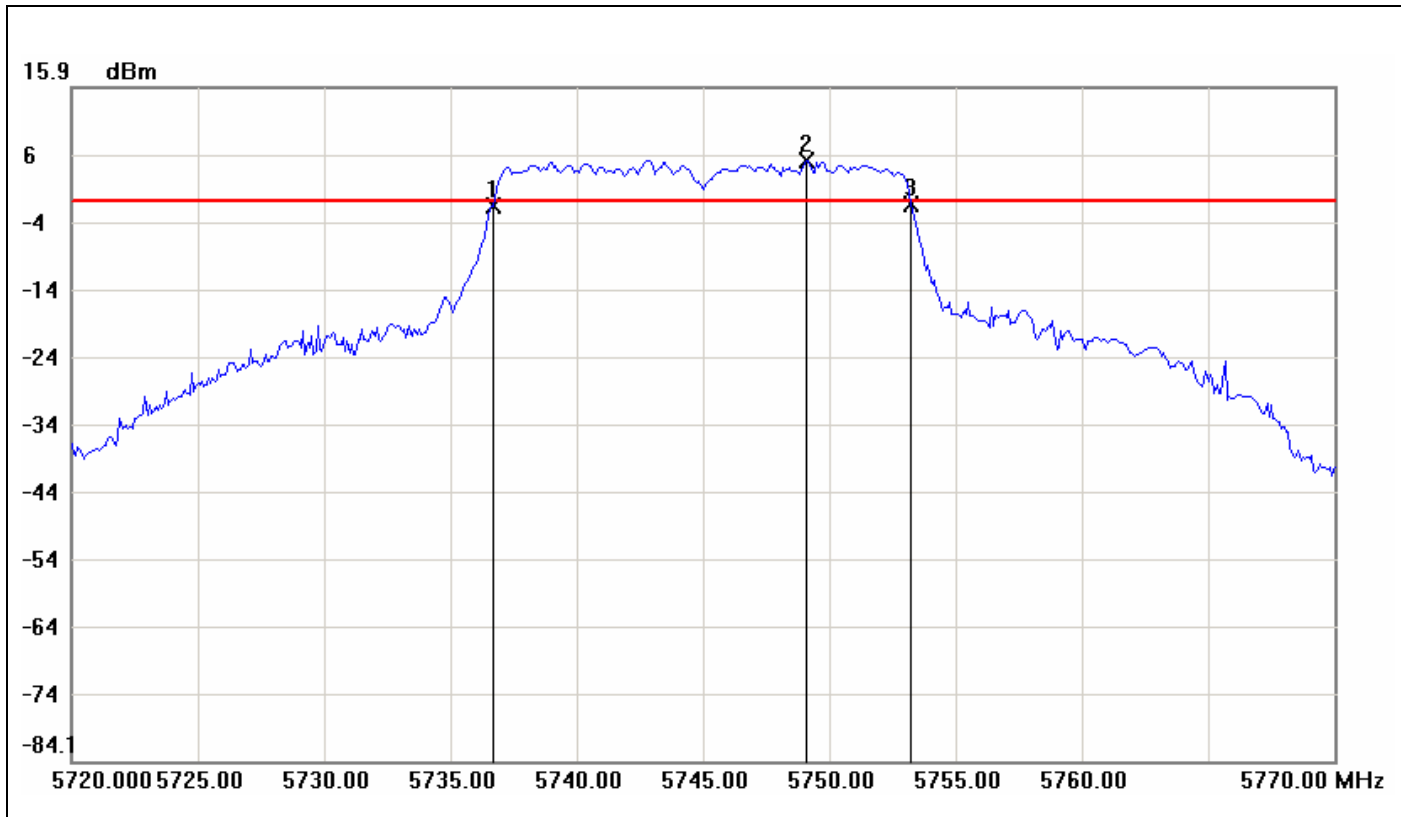

No.	Frequency(MHz)	Result(dBm)	Limit(dBm)	Margin(dBm)
1	5736.6667	-1.76	-0.85	-0.91
2	5749.0833	5.15	-0.85	6.00
3	5753.2500	-1.38	-0.85	-0.53

No.		$\Delta$ Frequency(MHz)	$\Delta$ Level(dB)
1	mk3-mk1	16.5833	0.38



6dB Bandwidth (CH Mid)

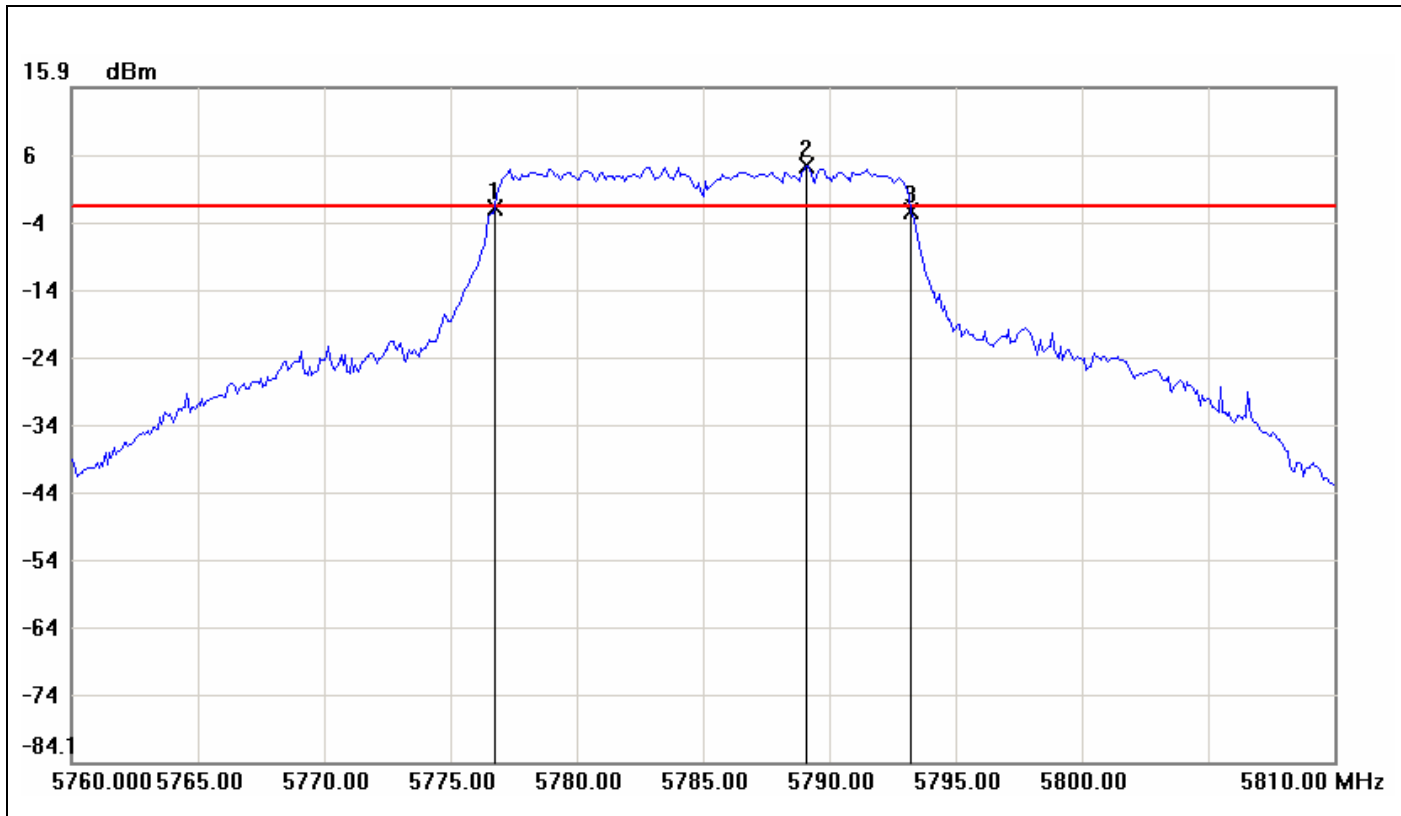

No.	Frequency(MHz)	Result(dBm)	Limit(dBm)	Margin(dBm)
1	5776.7500	-1.99	-1.64	-0.35
2	5789.0833	4.36	-1.64	6.00
3	5793.2500	-2.42	-1.64	-0.78

No.		$\Delta$ Frequency(MHz)	$\Delta$ Level(dB)
1	mk3-mk1	16.5	-0.43





### 6dB Bandwidth (CH High)

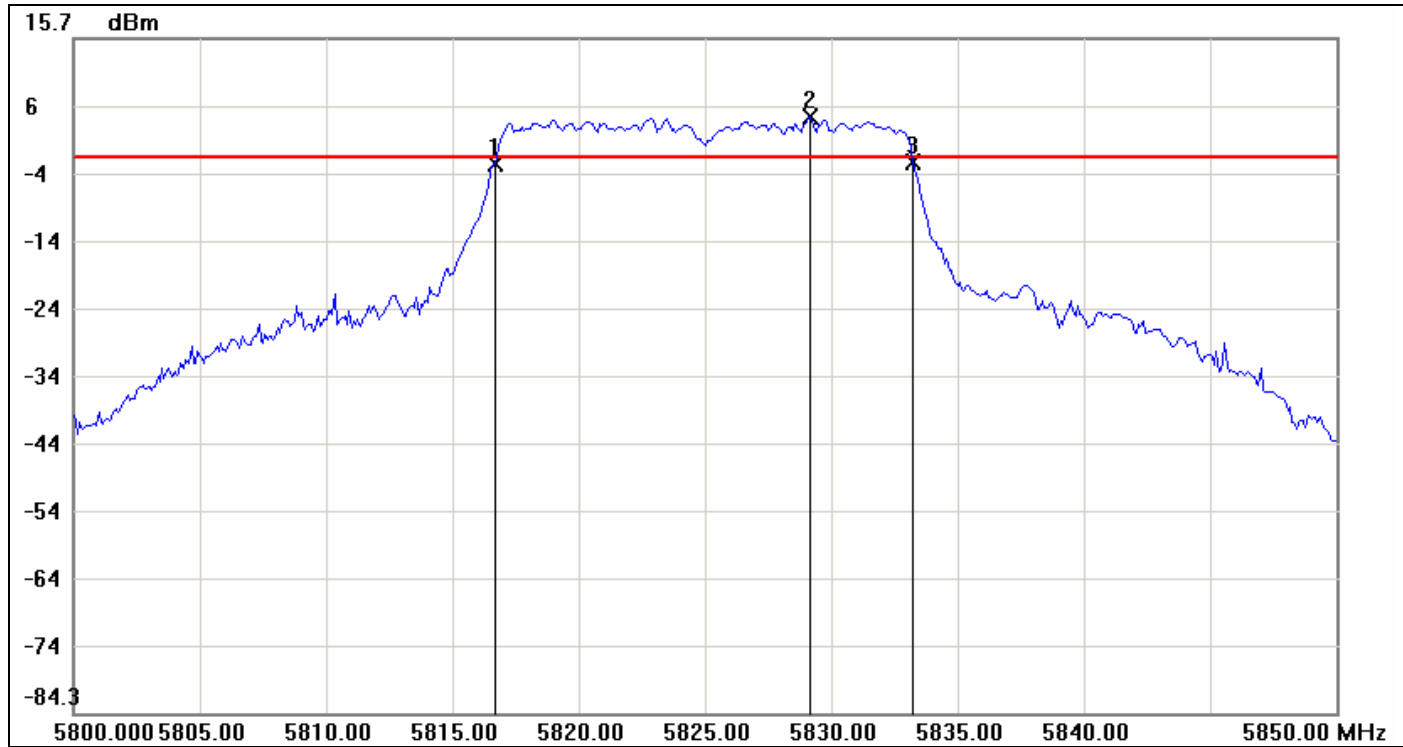

No.	Frequency(MHz)	Result(dBm)	Limit(dBm)	Margin(dBm)
1	5816.6667	-2.84	-2.01	-0.83
2	5829.1667	3.99	-2.01	6.00
3	5833.2500	-2.69	-2.01	-0.68

No.		$\Delta$ Frequency(MHz)	$\Delta$ Level(dB)
1	mk3-mk1	16.5833	0.15



IEEE 802.11n HT 20 MHz mode

6dB Bandwidth (CH Low)

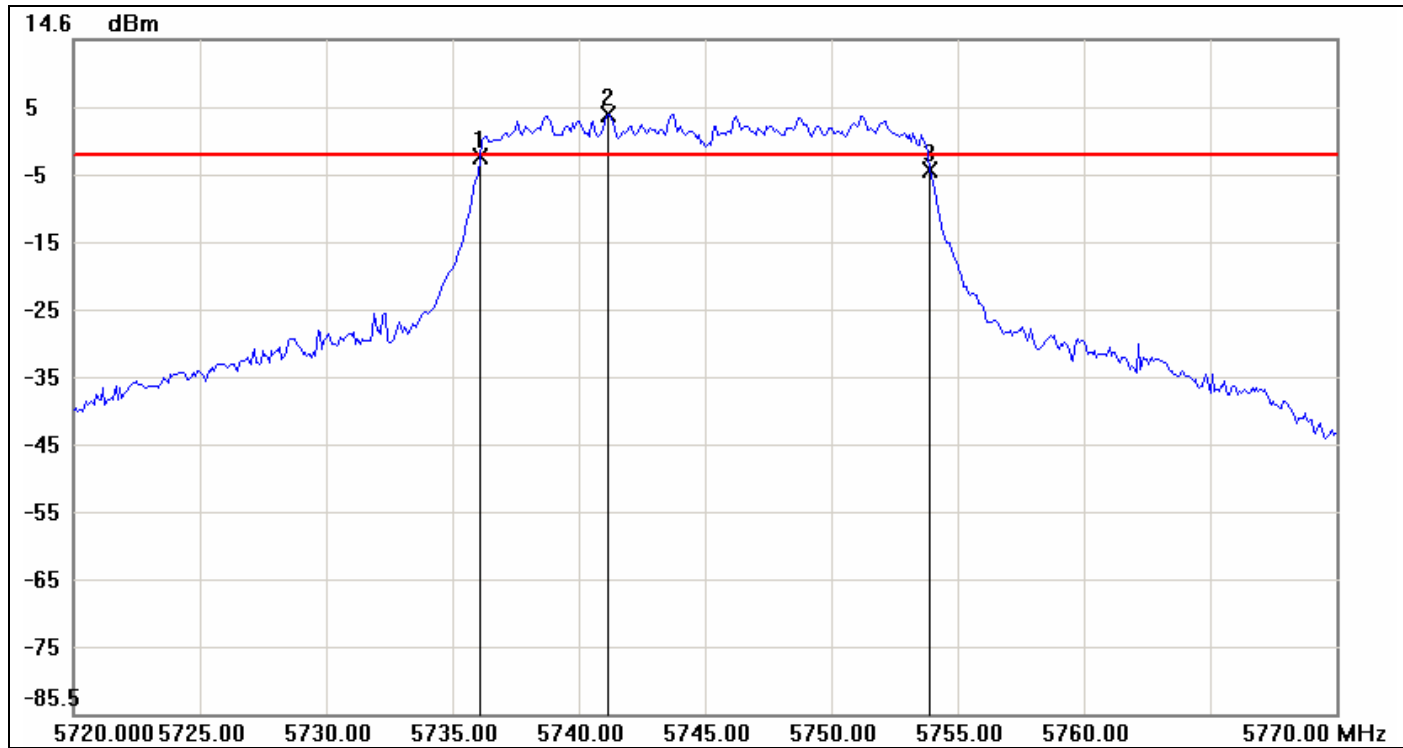

No.	Frequency(MHz)	Result(dBm)	Limit(dBm)	Margin(dBm)
1	5736.0833	-2.71	-2.55	-0.16
2	5741.1667	3.45	-2.55	6.00
3	5753.9167	-4.83	-2.55	-2.28

No.		$\Delta$ Frequency(MHz)	$\Delta$ Level(dB)
1	mk3-mk1	17.8334	-2.12



6dB Bandwidth (CH Mid)

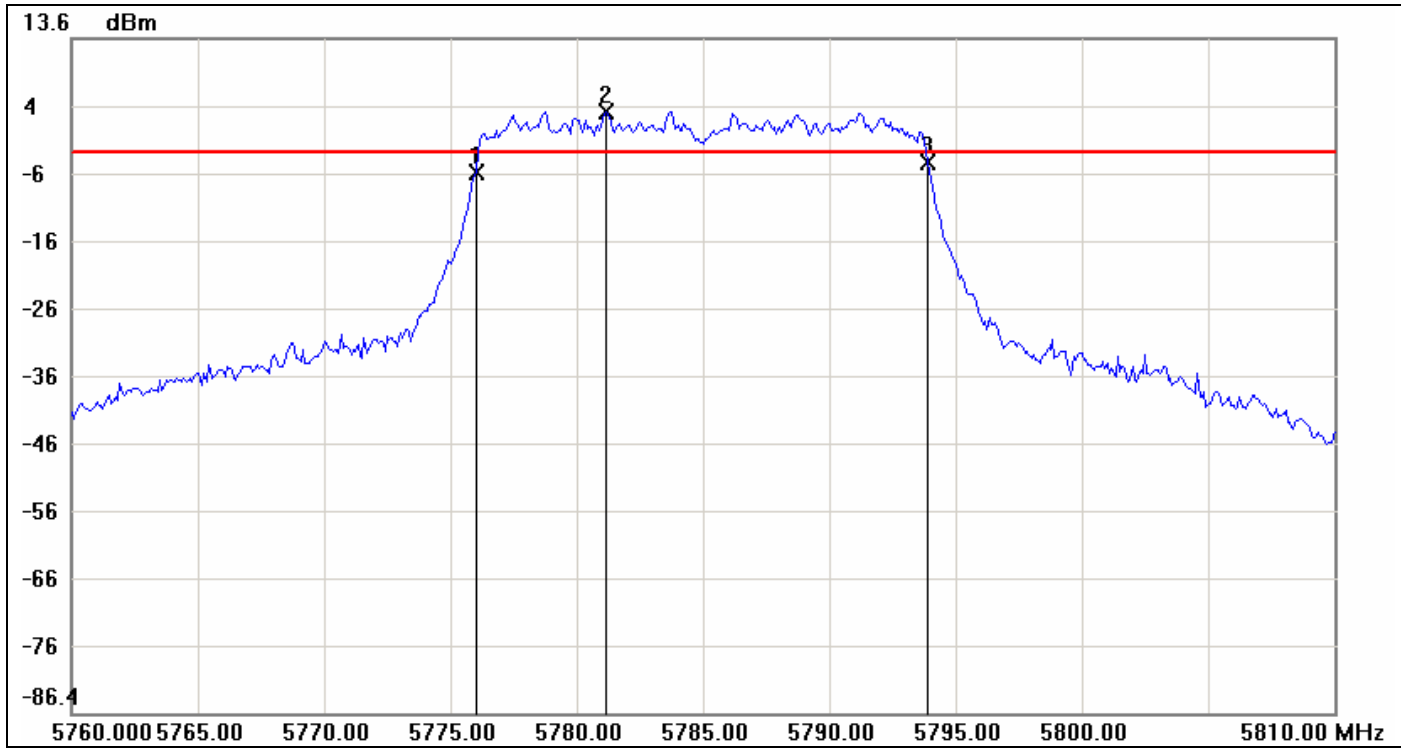

No.	Frequency(MHz)	Result(dBm)	Limit(dBm)	Margin(dBm)
1	5776.0000	-6.25	-3.31	-2.94
2	5781.1667	2.69	-3.31	6.00
3	5793.9167	-4.64	-3.31	-1.33

No.		$\Delta$ Frequency(MHz)	$\Delta$ Level(dB)
1	mk3-mk1	17.9167	1.61



6dB Bandwidth (CH High)

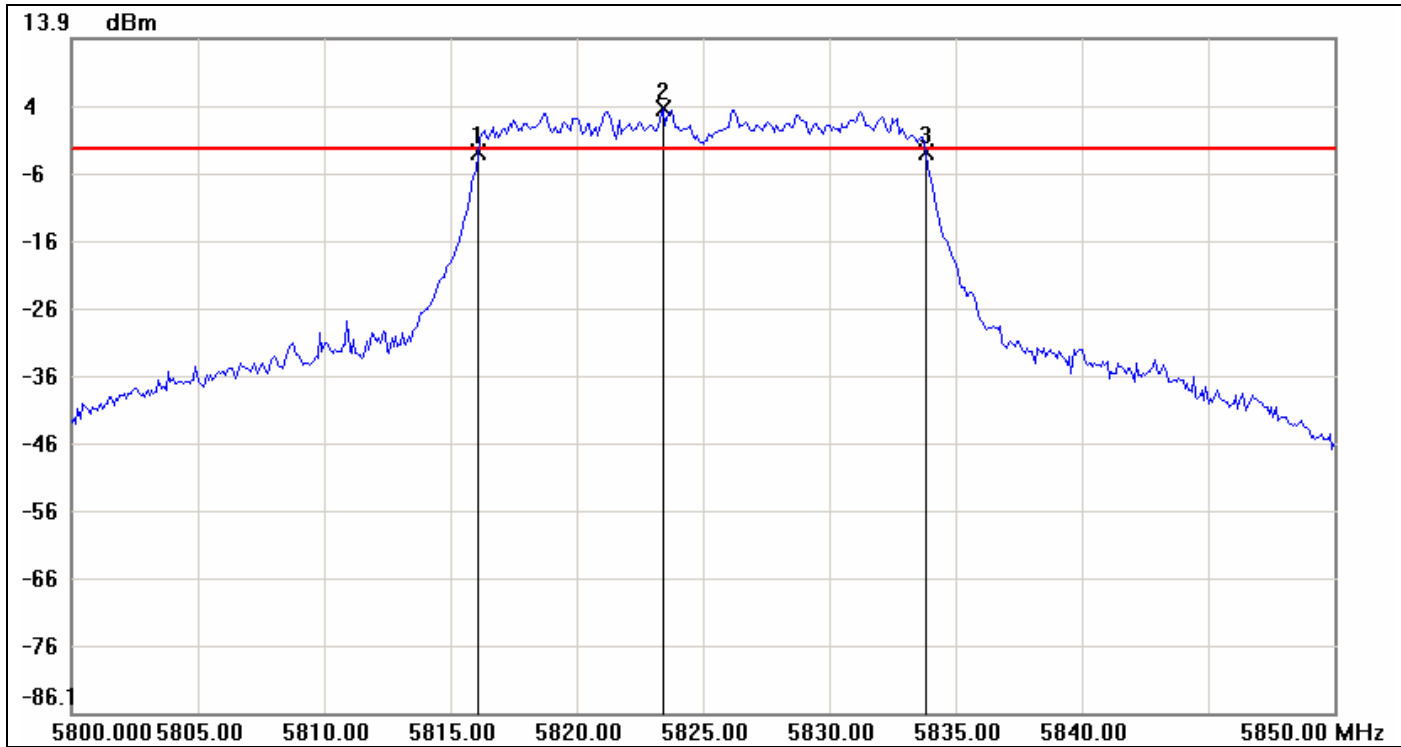

No.	Frequency(MHz)	Result(dBm)	Limit(dBm)	Margin(dBm)
1	5816.0833	-3.05	-2.54	-0.51
2	5823.4167	3.46	-2.54	6.00
3	5833.8333	-3.03	-2.54	-0.49

No.		$\Delta$ Frequency(MHz)	$\Delta$ Level(dB)
1	mk3-mk1	17.75	0.02



IEEE 802.11n HT 40 MHz mode

6dB Bandwidth (CH Low)

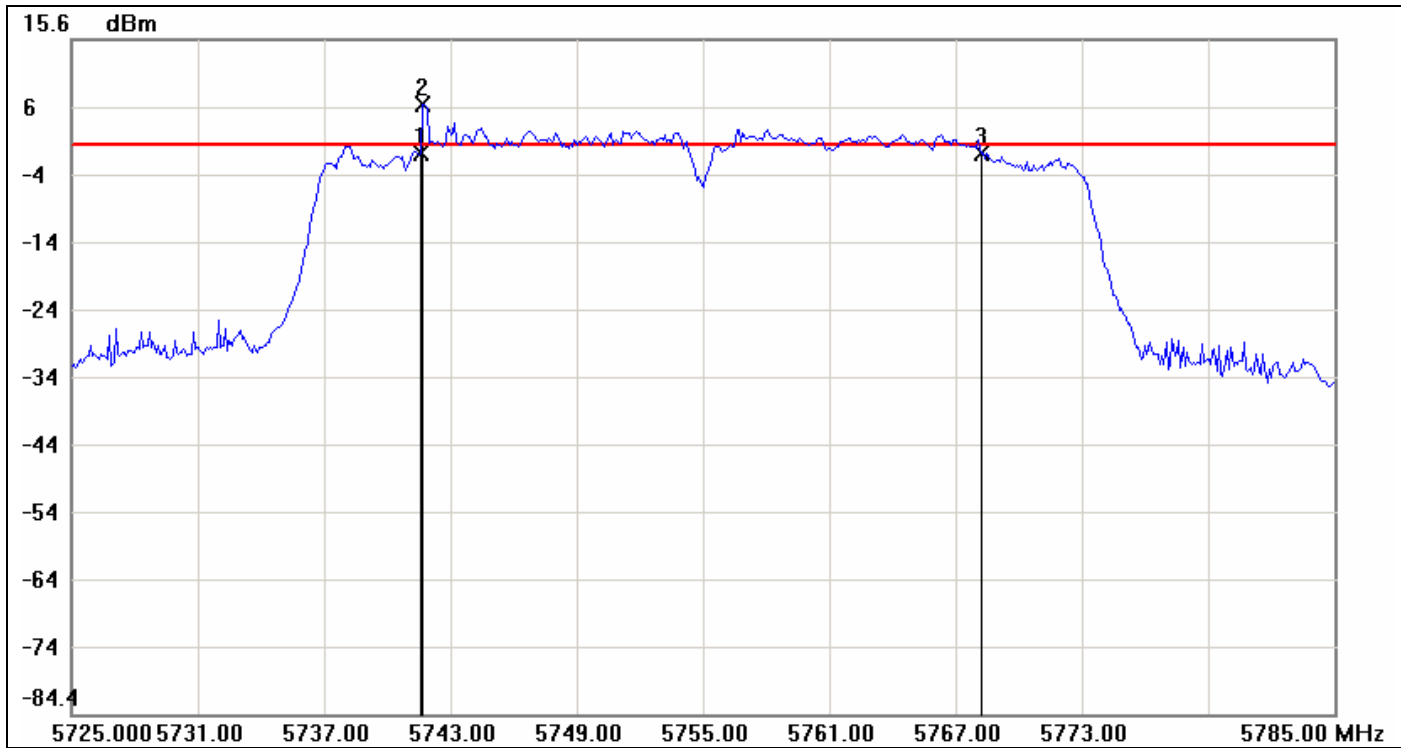

No.	Frequency(MHz)	Result(dBm)	Limit(dBm)	Margin(dBm)
1	5741.6000	-1.29	-0.18	-1.11
2	5741.7000	5.82	-0.18	6.00
3	5768.2000	-1.28	-0.18	-1.10

No.		$\Delta$ Frequency(MHz)	$\Delta$ Level(dB)
1	mk3-mk1	26.6	0.01



**6dB Bandwidth (CH High)**

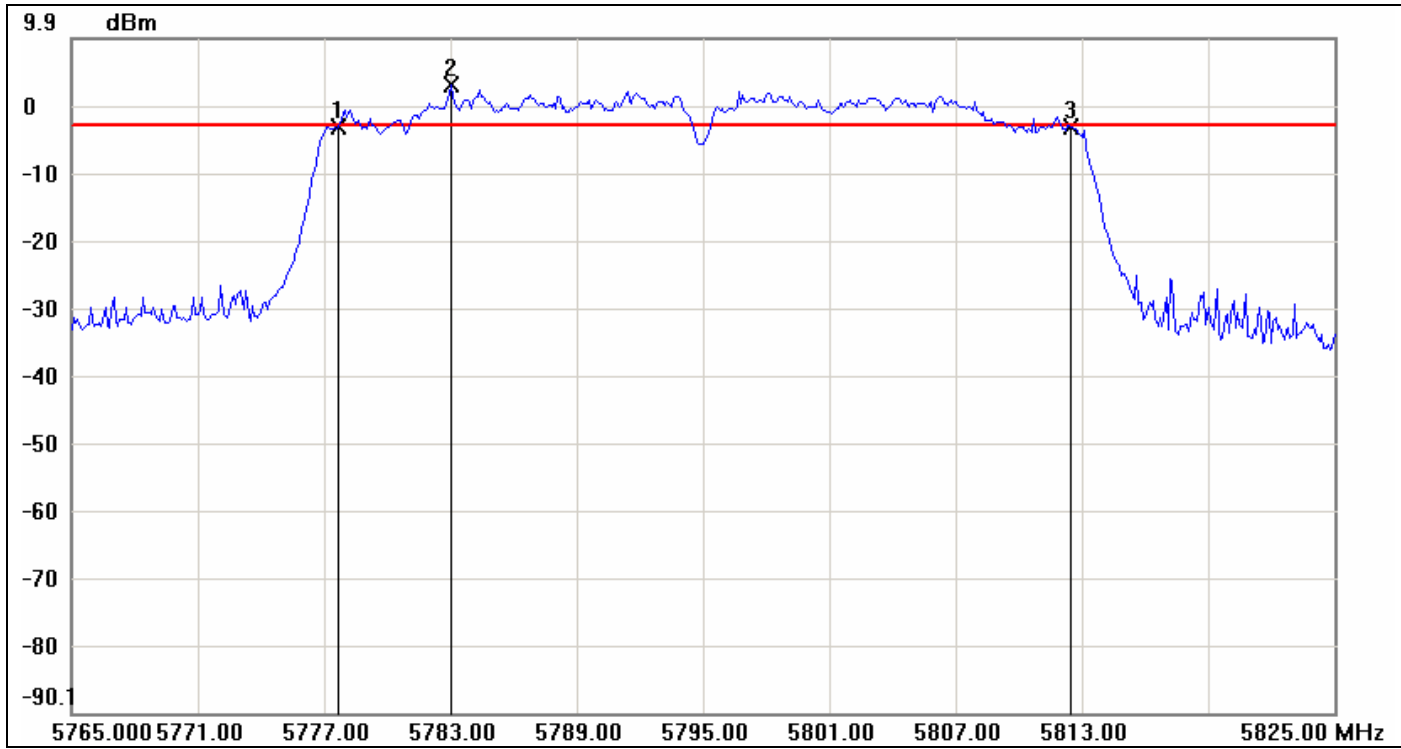

No.	Frequency(MHz)	Result(dBm)	Limit(dBm)	Margin(dBm)
1	5777.7000	-3.32	-3.01	-0.31
2	5783.0000	2.99	-3.01	6.00
3	5812.5000	-3.32	-3.01	-0.31

No.		$\Delta$ Frequency(MHz)	$\Delta$ Level(dB)
1	mk3-mk1	34.8	0



## 7.3 PEAK POWER

### LIMIT

The maximum peak output power of the intentional radiator shall not exceed the following:

1. According to §15.247(b)(3), for systems using digital modulation in the bands of 902-928 MHz, 2400-2483.5 MHz, and 5725-5850 MHz: 1 Watt.
2. According to §15.247(b)(4), the conducted output power limit specified in paragraph (b) of this section is based on the use of antennas with directional gains that do not exceed 6 dBi. Except as shown in paragraph (c) of this section, if transmitting antennas of directional gain greater than 6 dBi are used, the conducted output power from the intentional radiator shall be reduced below the stated values in paragraphs (b)(1), (b)(2), and (b)(3) of this section, as appropriate, by the amount in dB that the directional gain of the antenna exceeds 6 dBi.

### Test Configuration

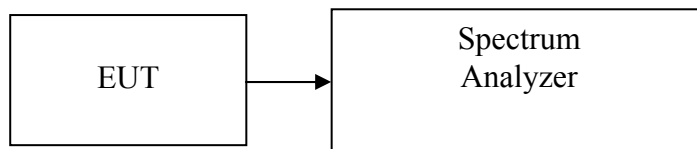

### TEST PROCEDURE

The transmitter output is connected to the spectrum analyzer. Set the RBW = 1MHz, VBW = 3MHz, Detector = Peak, Trace mode = max hold, Allow trace to fully stabilize. Sweep = auto couple. Use the spectrum analyzer's integrated band power measurement function with band limits set equal to the EBW band edges record the max reading. Repeat the above procedure until the measurements for all frequencies are completed.

### TEST RESULTS

*No non-compliance noted.*

**Test Data****Test mode: IEEE 802.11b mode**

Channel	Frequency (MHz)	Output Power (dBm)	Output Power (W)	Limit (W)	Result
Low	2412	22.10	0.1622	1.00	PASS
Mid	2437	21.65	0.1462		PASS
High	2462	21.48	0.1406		PASS

**Test mode: IEEE 802.11g mode**

Channel	Frequency (MHz)	Output Power (dBm)	Output Power (W)	Limit (W)	Result
Low	2412	24.22	0.2642	1.00	PASS
Mid	2437	25.65	0.3673		PASS
High	2462	23.65	0.2317		PASS

**Test mode: IEEE 802.11n HT 20 MHz mode**

Channel	Frequency (MHz)	Main Antenna Output Power (dBm)	Aux Antenna Output Power (dBm)	Total Output Power (dBm)	Output Power (W)	Limit (W)	Result
Low	2412	22.83	18.06	24.08	0.2558	1.00	PASS
Mid	2437	23.49	18.12	24.60	0.2882		PASS
High	2462	22.51	17.07	23.60	0.2292		PASS

**Test mode: IEEE 802.11n HT 40 MHz mode**

Channel	Frequency (MHz)	Main Antenna Output Power (dBm)	Aux Antenna Output Power (dBm)	Total Output Power (dBm)	Output Power (W)	Limit (W)	Result
Low	2422	21.31	14.63	22.15	0.1642	1.00	PASS
Mid	2437	24.02	18.21	25.03	0.3186		PASS
High	2452	21.74	15.48	22.66	0.1846		PASS

**Remark:** Total Output Power (w) = Main Antenna( $10^{(Output Power / 10) / 1000}$ ) + Aux Antenna ( $10^{(Output Power / 10) / 1000}$ )





**Test mode: IEEE 802.11a mode**

Channel	Frequency (MHz)	Output Power (dBm)	Output Power (W)	Limit (W)	Result
Low	5745	20.10	0.1023	1.00	PASS
Mid	5785	19.92	0.0982		PASS
High	5825	19.56	0.0904		PASS

**Test mode: IEEE 802.11n HT 20 MHz mode**

Channel	Frequency (MHz)	Output Power (dBm)	Output Power (W)	Limit (W)	Result
Low	5745	17.86	0.0611	1.00	PASS
Mid	5785	17.27	0.0533		PASS
High	5825	16.46	0.0443		PASS

**Test mode: IEEE 802.11n HT 40 MHz mode**

Channel	Frequency (MHz)	Output Power (dBm)	Output Power (W)	Limit (W)	Result
Low	5755	16.72	0.0470	1.00	PASS
High	5795	16.69	0.0467		PASS



### IEEE 802.11b mode

#### Peak power (CH Low)

Agilent 15:27:22 Oct 12, 2012

R T

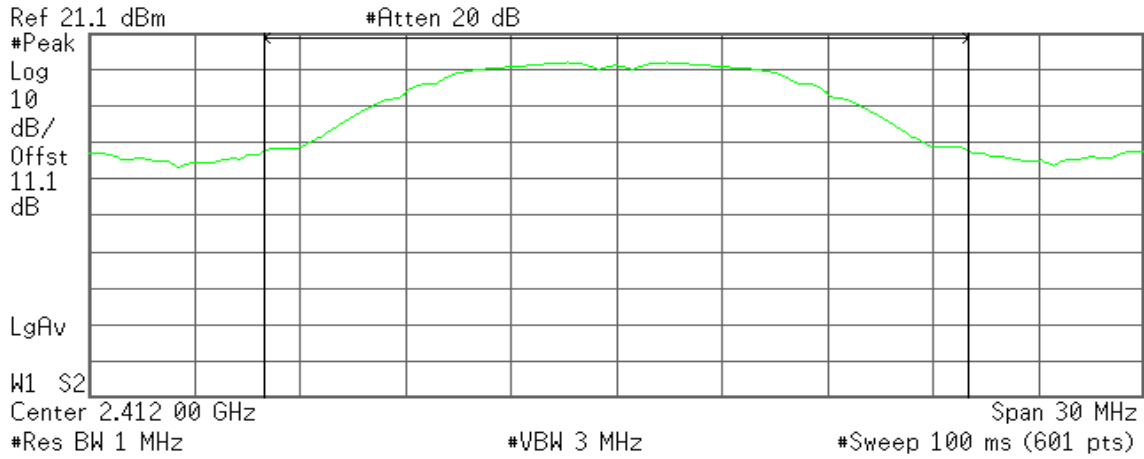

**Channel Power**

22.10 dBm /20.0000 MHz

**Power Spectral Density**

-50.92 dBm/Hz

#### Peak power (CH Mid)

Agilent 15:26:51 Oct 12, 2012

R T

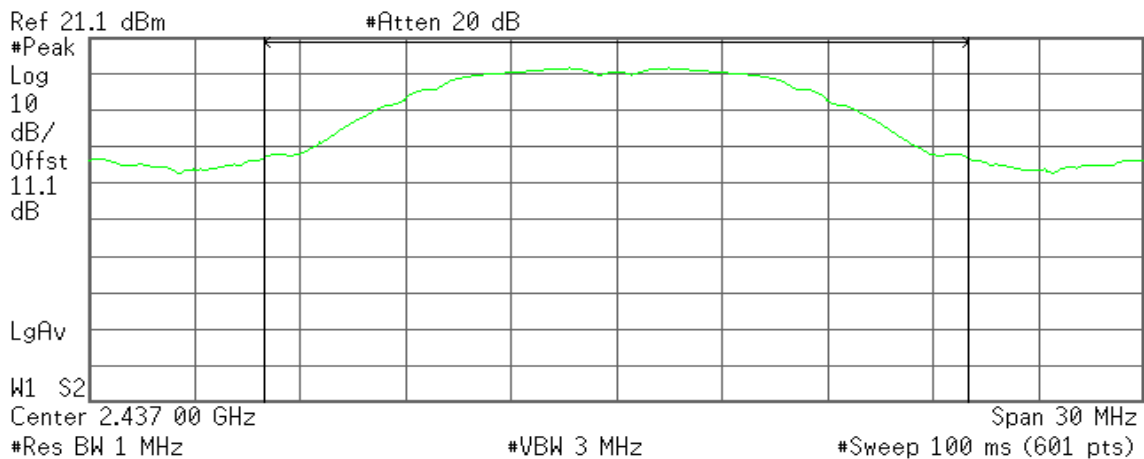

**Channel Power**

21.65 dBm /20.0000 MHz

**Power Spectral Density**

-51.36 dBm/Hz



### Peak power (CH High)

Agilent 15:25:14 Oct 12, 2012

R T

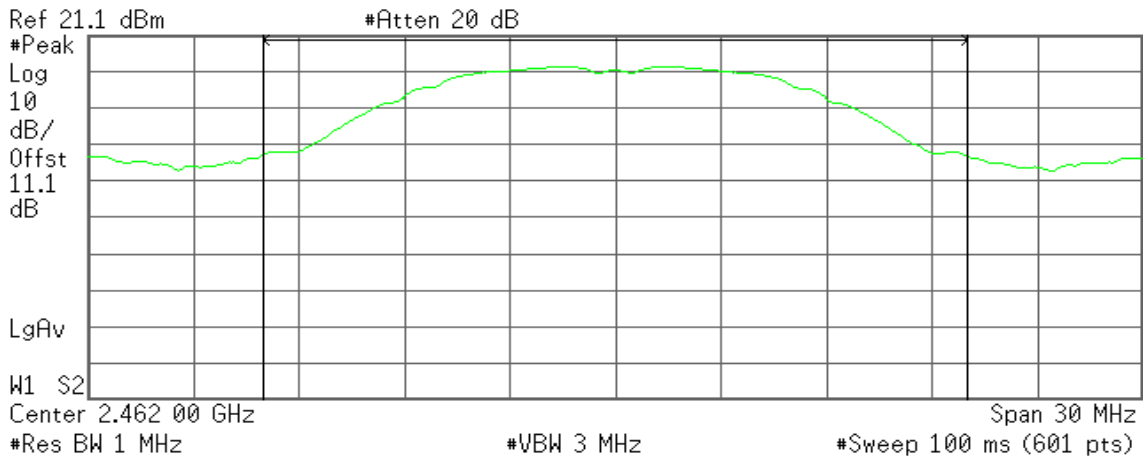

**Channel Power**

21.48 dBm /20.0000 MHz

**Power Spectral Density**

-51.53 dBm/Hz

### IEEE 802.11g mode

#### Peak power (CH Low)

Agilent 15:58:23 Oct 12, 2012

R T

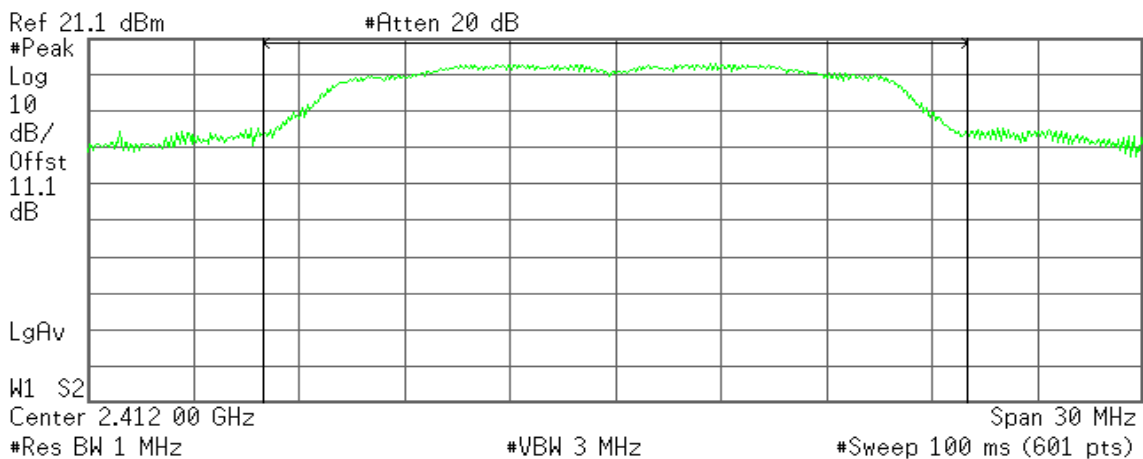

**Channel Power**

24.22 dBm /20.0000 MHz

**Power Spectral Density**

-48.79 dBm/Hz



### Peak power (CH Mid)

Agilent 15:56:53 Oct 12, 2012

R T

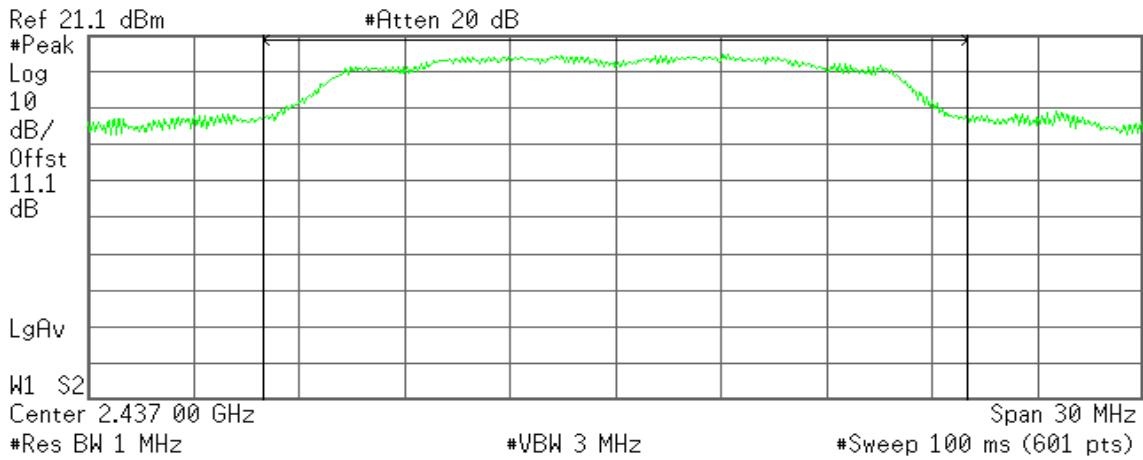

**Channel Power**

25.65 dBm /20.0000 MHz

**Power Spectral Density**

-47.36 dBm/Hz

### Peak power (CH High)

Agilent 15:54:58 Oct 12, 2012

R T

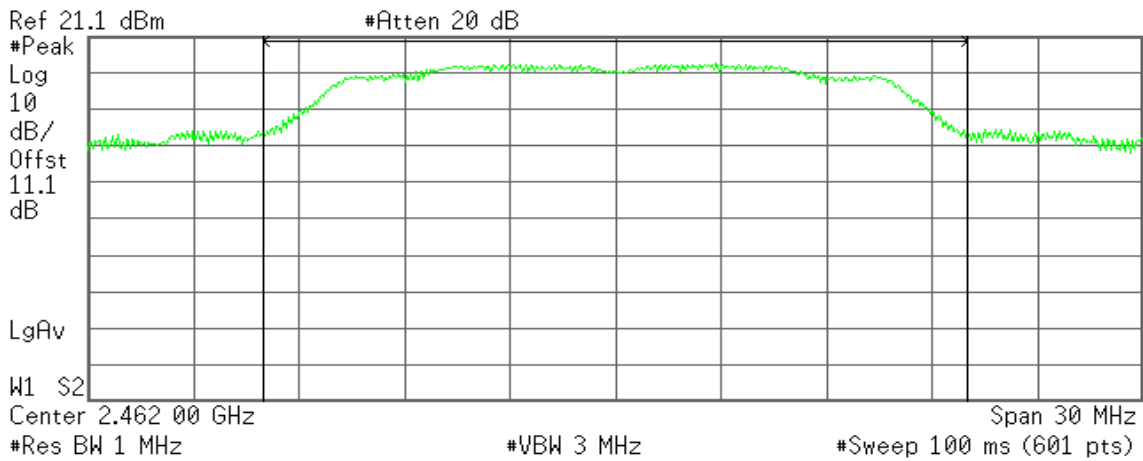

**Channel Power**

23.65 dBm /20.0000 MHz

**Power Spectral Density**

-49.36 dBm/Hz



### IEEE 802.11n HT20 MHz mode / Main Antenna

#### Peak power (CH Low)

Agilent 16:41:11 Oct 12, 2012

R T

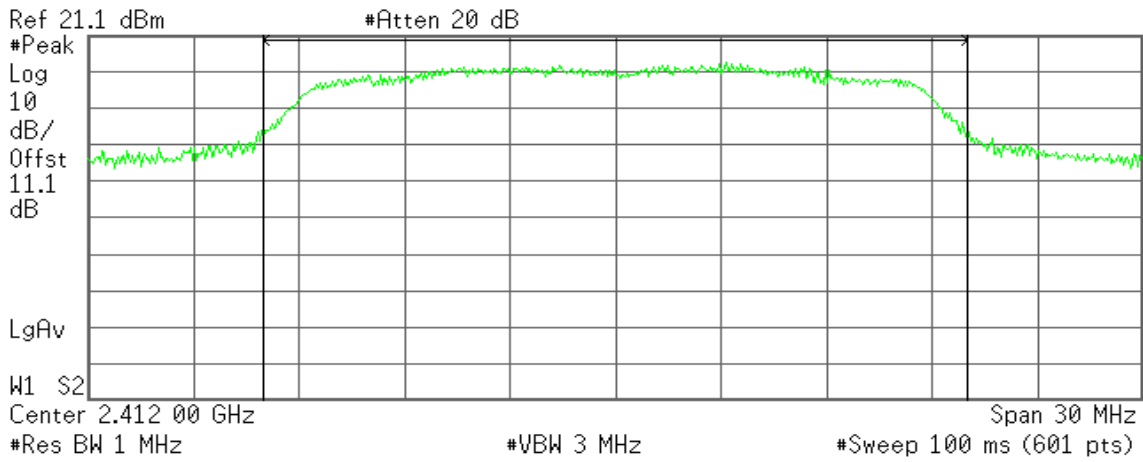

Channel Power

22.83 dBm /20.0000 MHz

Power Spectral Density

-50.18 dBm/Hz

#### Peak power (CH Mid)

Agilent 16:40:00 Oct 12, 2012

R T

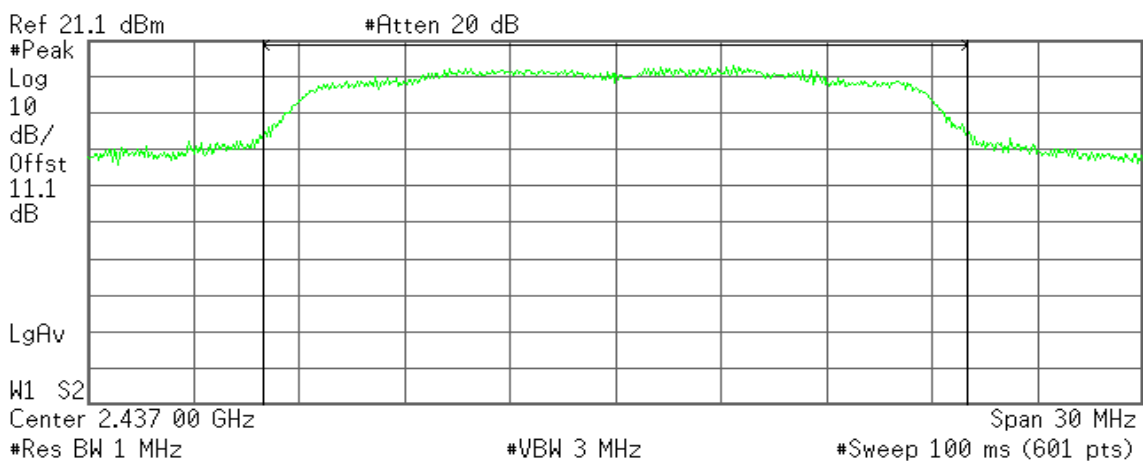

Channel Power

23.49 dBm /20.0000 MHz

Power Spectral Density

-49.52 dBm/Hz



### Peak power (CH High)

Agilent 16:34:04 Oct 12, 2012

R T

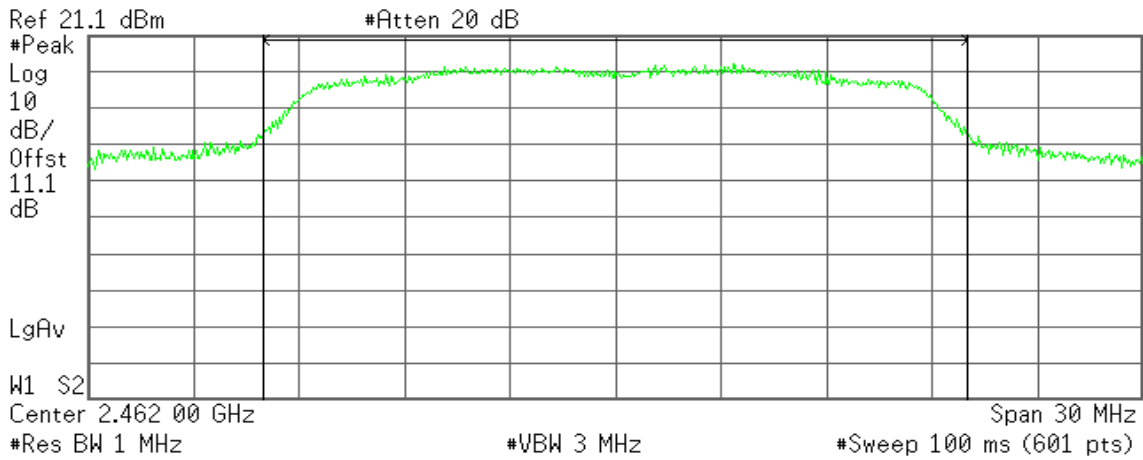

**Channel Power**

22.51 dBm /20.0000 MHz

**Power Spectral Density**

-50.50 dBm/Hz

### IEEE 802.11n HT20 MHz mode / Aux Antenna

#### Peak power (CH Low)

Agilent 19:30:30 Oct 12, 2012

R T

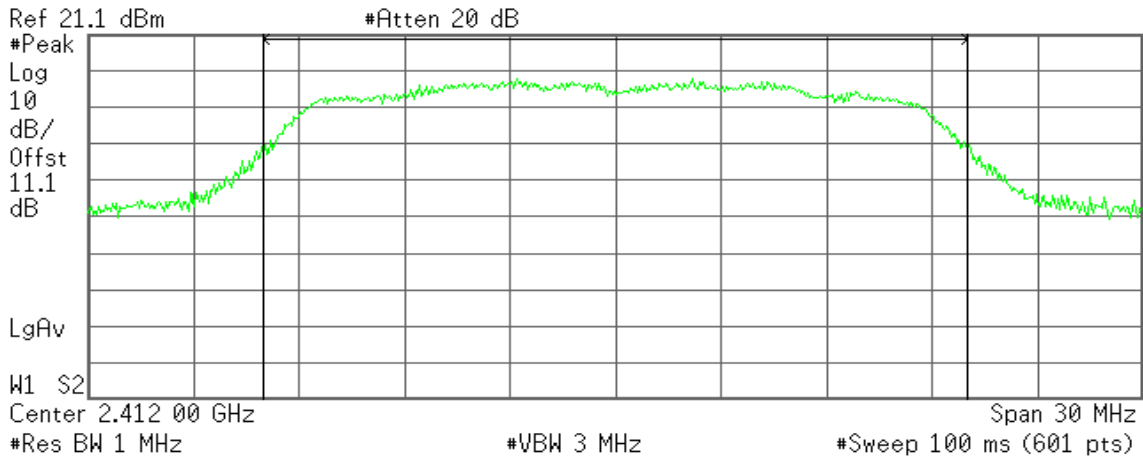

**Channel Power**

18.06 dBm /20.0000 MHz

**Power Spectral Density**

-54.95 dBm/Hz



### Peak power (CH Mid)

Agilent 19:29:46 Oct 12, 2012

R T

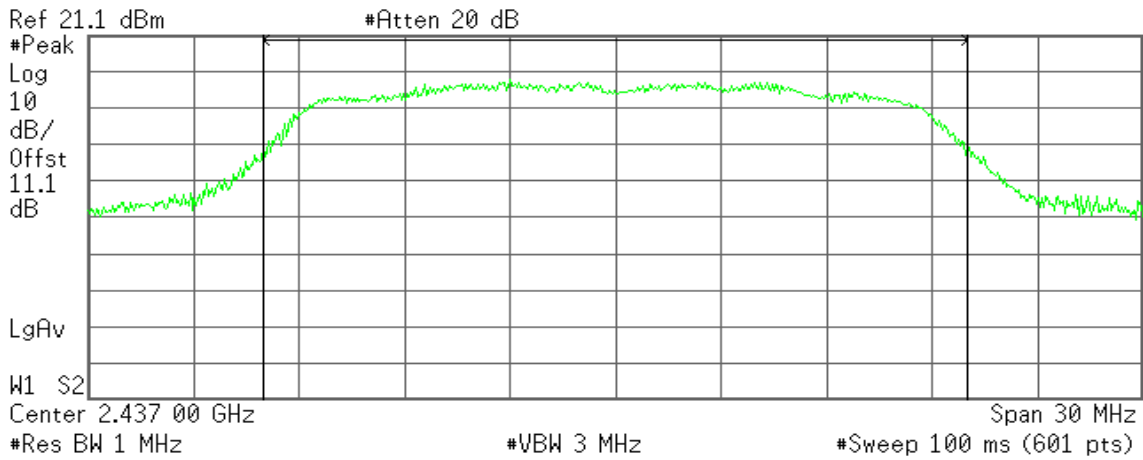

**Channel Power**

18.12 dBm /20.0000 MHz

**Power Spectral Density**

-54.89 dBm/Hz

### Peak power (CH High)

Agilent 19:28:06 Oct 12, 2012

R T

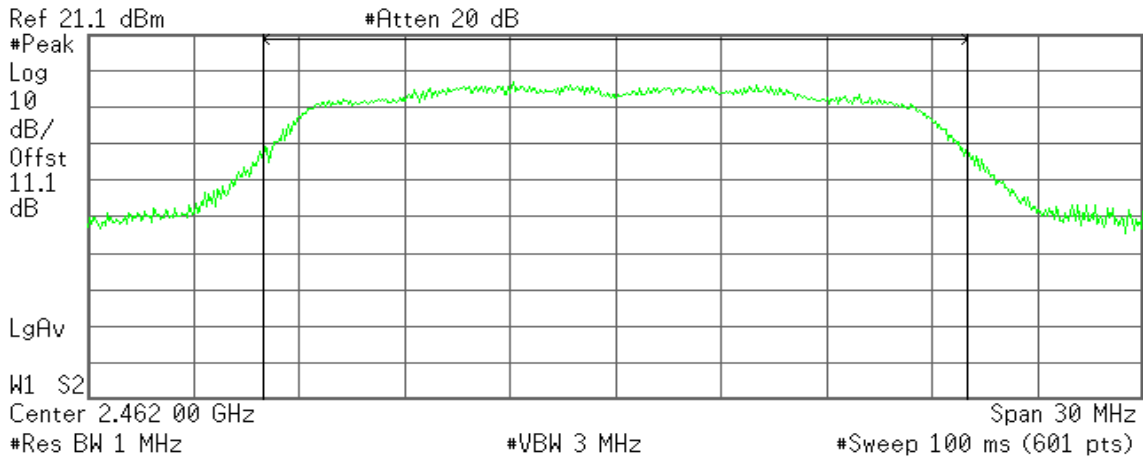

**Channel Power**

17.07 dBm /20.0000 MHz

**Power Spectral Density**

-55.94 dBm/Hz



### IEEE 802.11n HT40 MHz mode / Main Antenna

#### Peak power (CH Low)

Agilent 19:59:50 Oct 12, 2012

R T

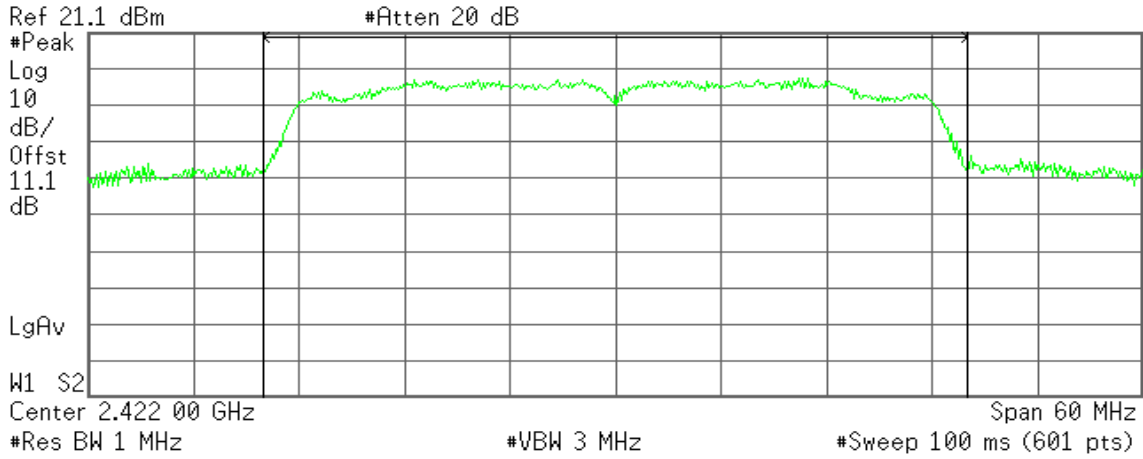

Channel Power

21.31 dBm /40.0000 MHz

Power Spectral Density

-54.71 dBm/Hz

#### Peak power (CH Mid)

Agilent 19:57:36 Oct 12, 2012

R T

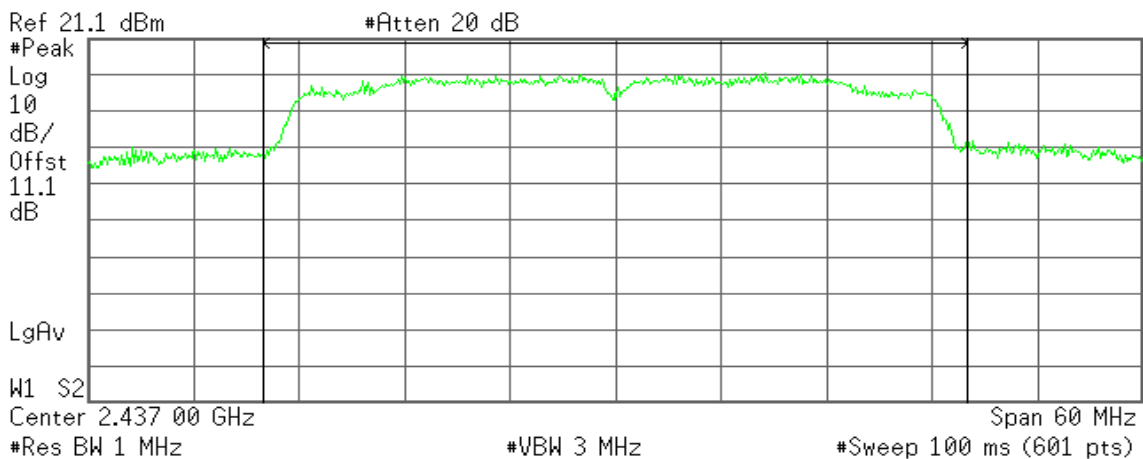

Channel Power

24.02 dBm /40.0000 MHz

Power Spectral Density

-52.00 dBm/Hz





### Peak power (CH High)

Agilent 19:54:07 Oct 12, 2012

R T

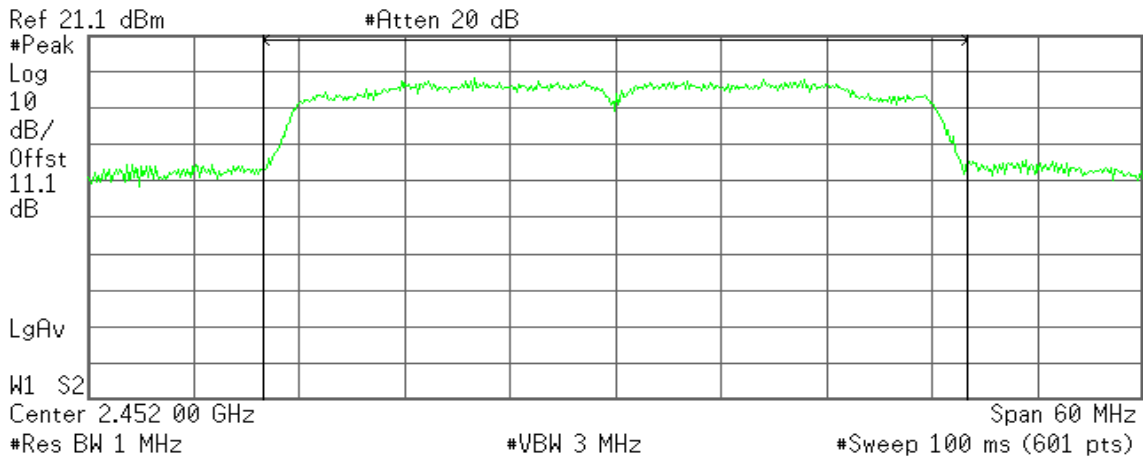

Channel Power

21.74 dBm /40.0000 MHz

Power Spectral Density

-54.28 dBm/Hz

### IEEE 802.11n HT40 MHz mode / Aux Antenna

#### Peak power (CH Low)

Agilent 19:42:35 Oct 12, 2012

R T

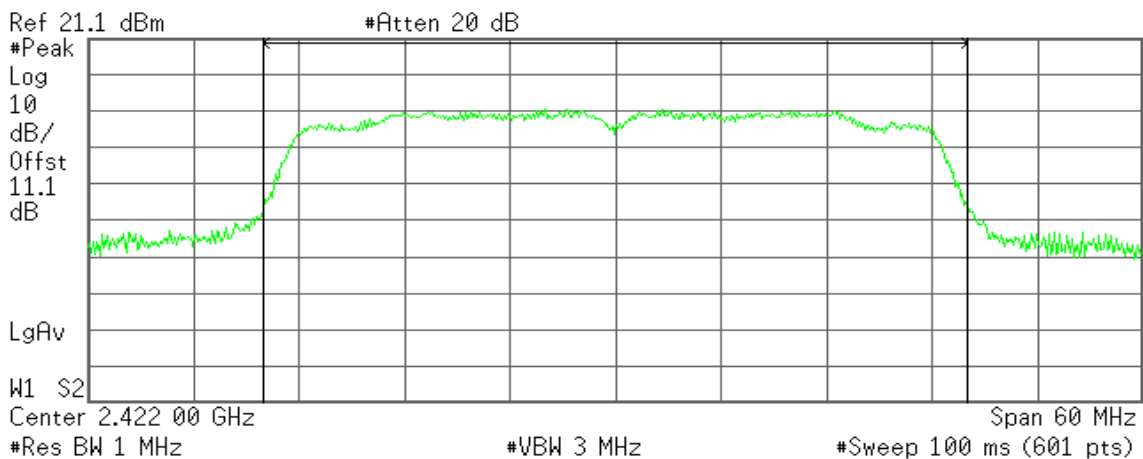

Channel Power

14.63 dBm /40.0000 MHz

Power Spectral Density

-61.39 dBm/Hz



### Peak power (CH Mid)

Agilent 19:44:22 Oct 12, 2012

R T

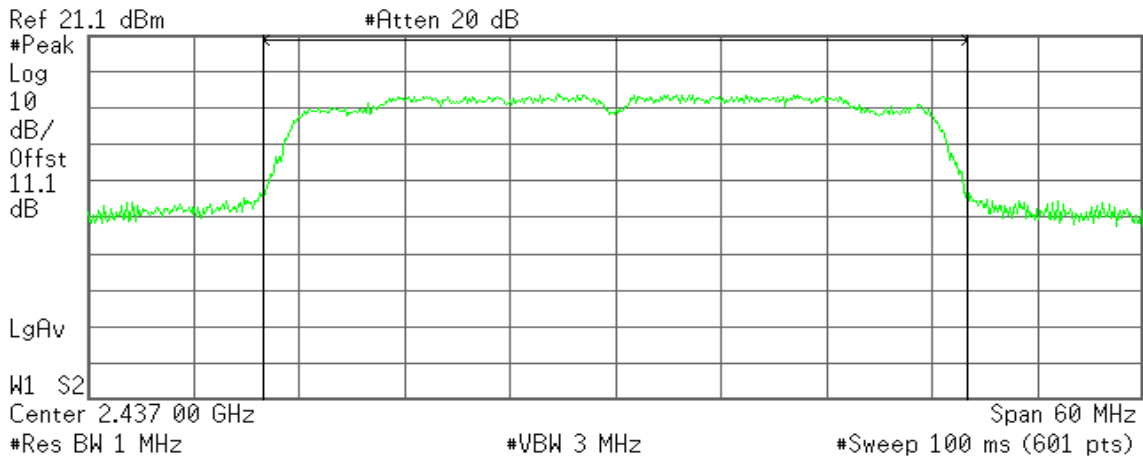

**Channel Power**

18.21 dBm /40.0000 MHz

**Power Spectral Density**

-57.81 dBm/Hz

### Peak power (CH High)

Agilent 19:50:20 Oct 12, 2012

R T

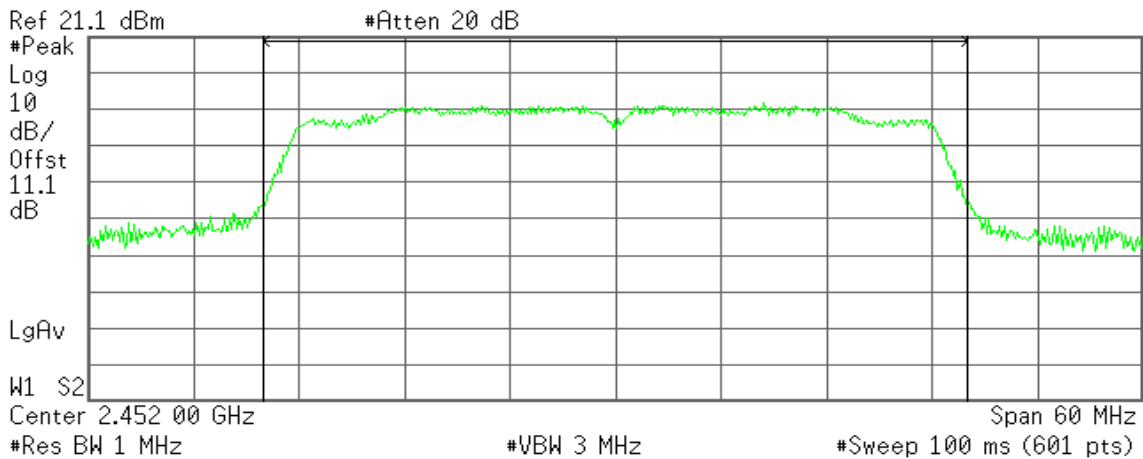

**Channel Power**

15.48 dBm /40.0000 MHz

**Power Spectral Density**

-60.54 dBm/Hz



**IEEE 802.11a mode**

**Peak power (CH Low)**

Agilent

R T

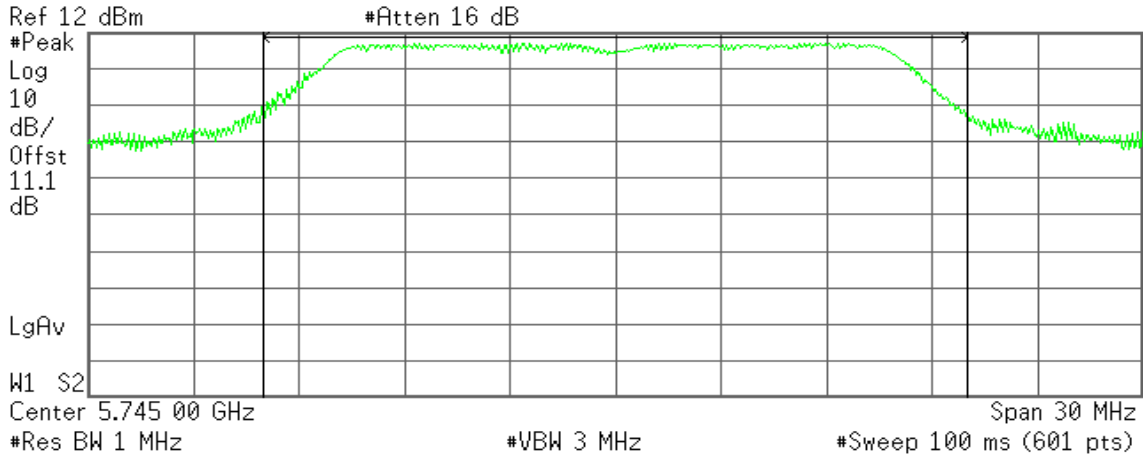

**Channel Power**

**20.01 dBm /20.0000 MHz**

**Power Spectral Density**

**-53.00 dBm/Hz**

**Peak power (CH Mid)**

Agilent

R T

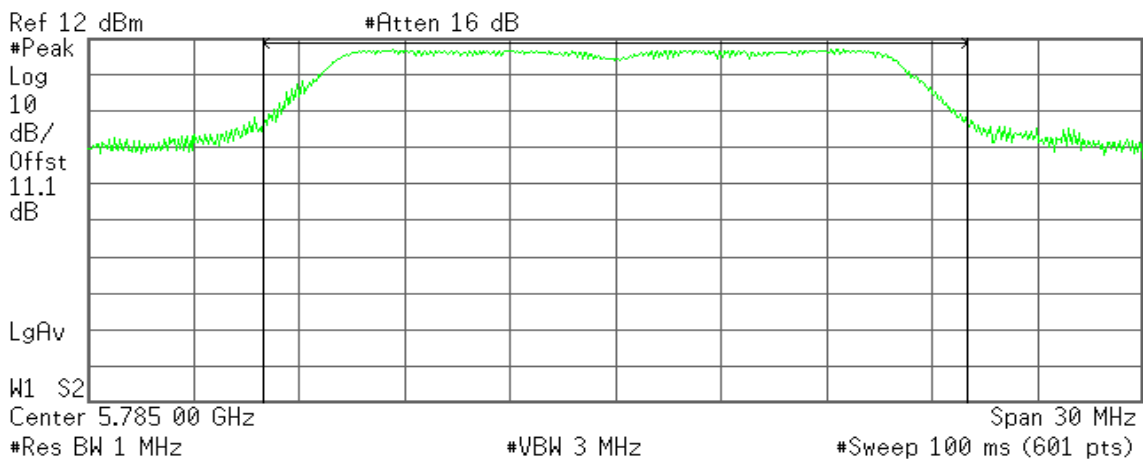

**Channel Power**

**19.92 dBm /20.0000 MHz**

**Power Spectral Density**

**-53.09 dBm/Hz**



### Peak power (CH High)

Agilent

R T

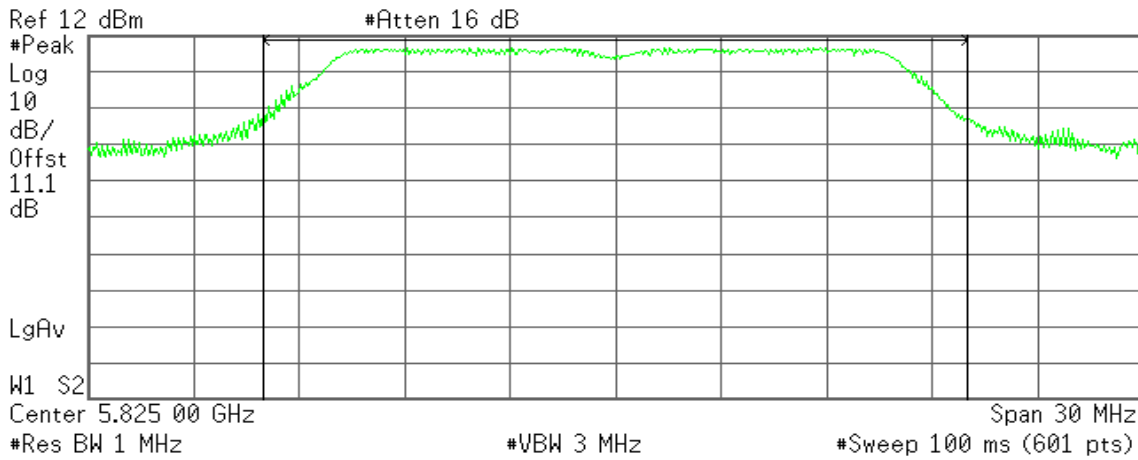

Channel Power

19.56 dBm /20.0000 MHz

Power Spectral Density

-53.45 dBm/Hz

### IEEE 802.11n HT 20 MHz mode

#### Peak power (CH Low)

Agilent

R T

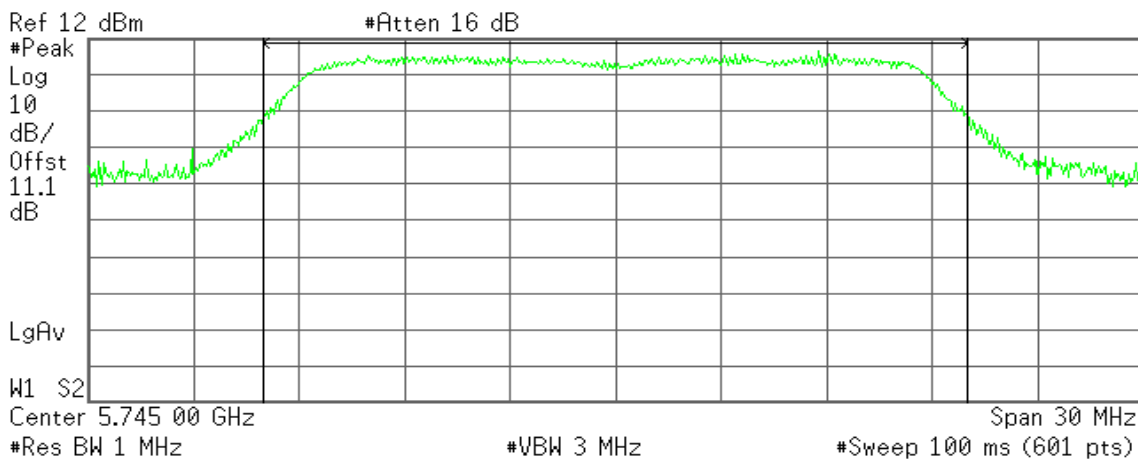

Channel Power

17.86 dBm /20.0000 MHz

Power Spectral Density

-55.15 dBm/Hz



### Peak power (CH Mid)

Agilent

R T

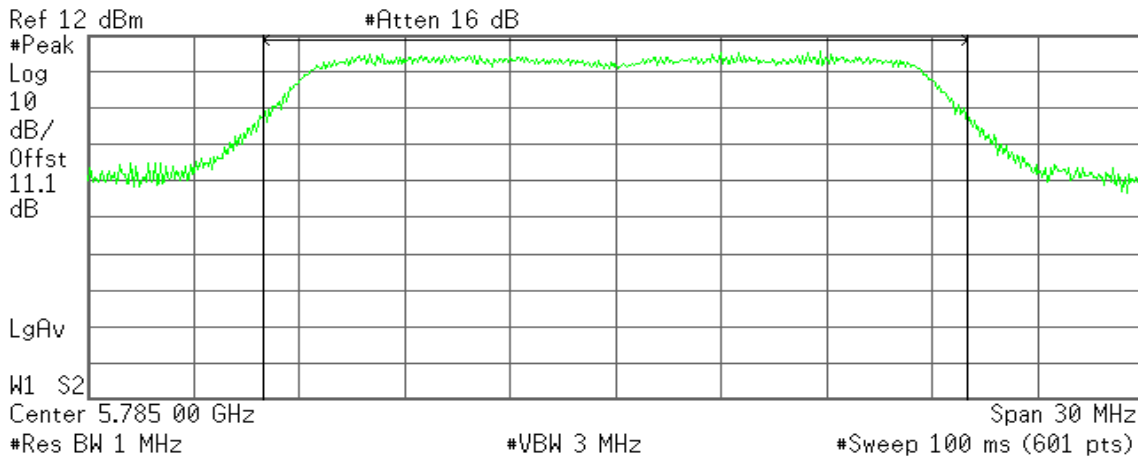

Channel Power

17.27 dBm /20.0000 MHz

Power Spectral Density

-55.74 dBm/Hz

### Peak power (CH High)

Agilent

R T

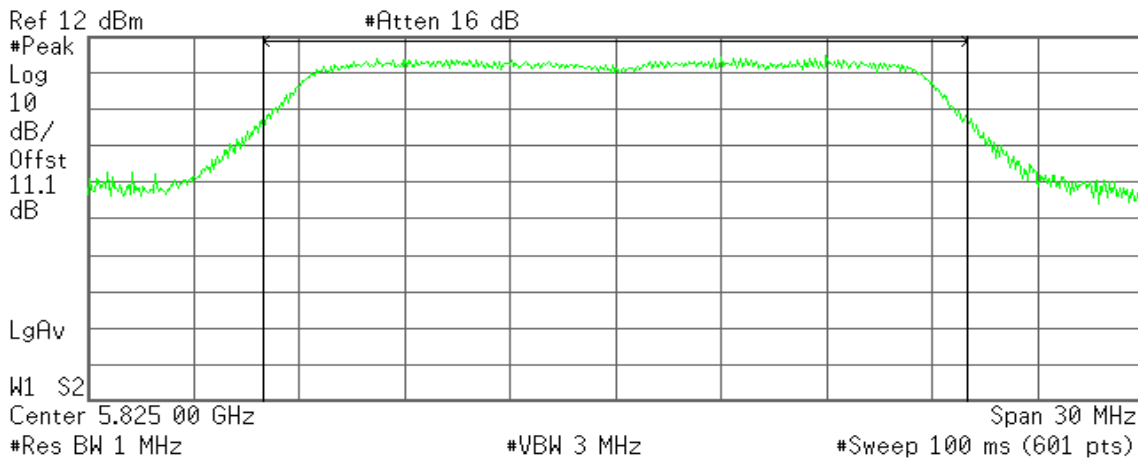

Channel Power

16.46 dBm /20.0000 MHz

Power Spectral Density

-56.55 dBm/Hz



### IEEE 802.11n HT 40 MHz mode

#### Peak power (CH Low)

Agilent

R T

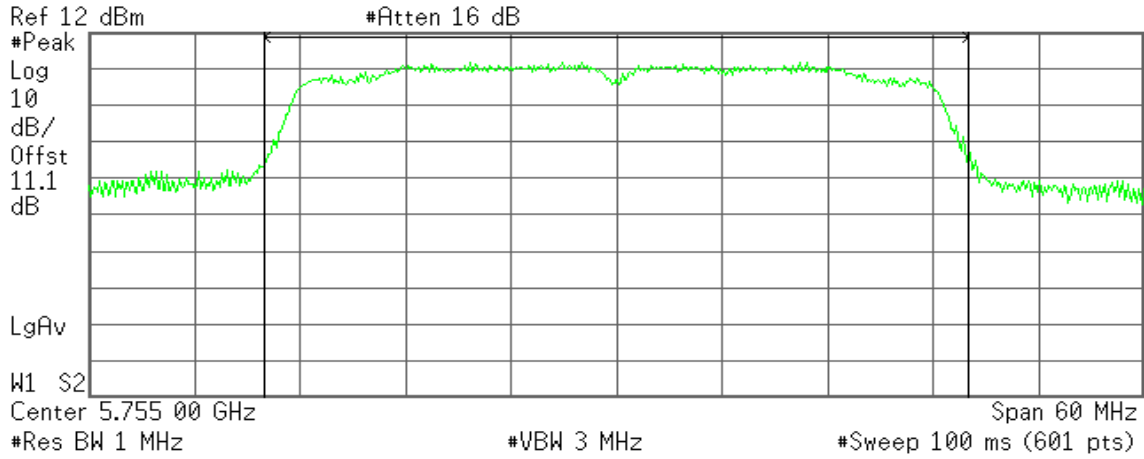

Channel Power

16.72 dBm /40.0000 MHz

Power Spectral Density

-59.30 dBm/Hz

#### Peak power (CH High)

Agilent

R T

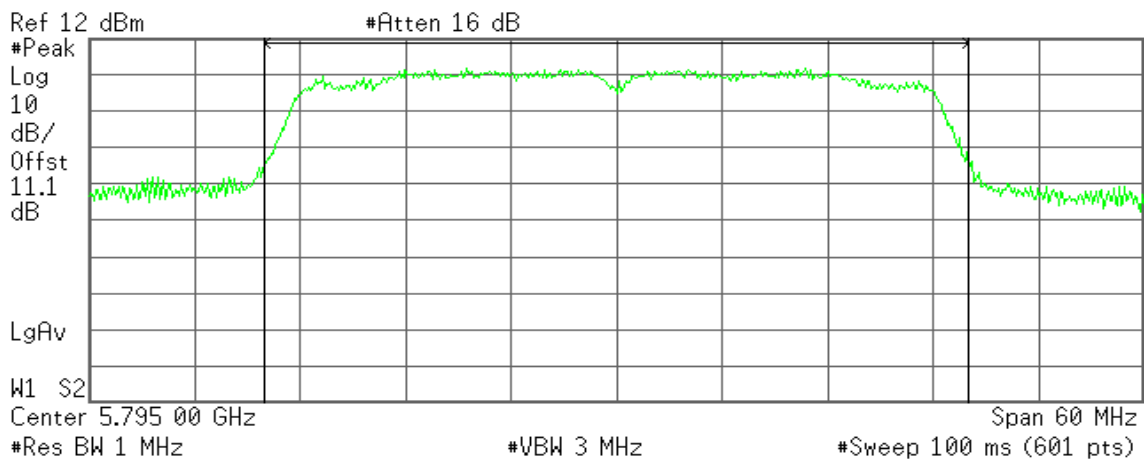

Channel Power

16.69 dBm /40.0000 MHz

Power Spectral Density

-59.33 dBm/Hz



## 7.4 AVERAGE POWER

### LIMIT

None; for reporting purposes only.

### Test Configuration

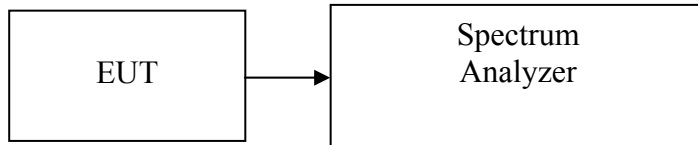

### TEST PROCEDURE

The transmitter output is connected to the spectrum analyzer. Set the RBW = 1MHz, VBW = 3MHz, Detector = Peak, Trace mode = max hold, Allow trace to fully stabilize. Sweep = auto couple. Use the spectrum analyzer's integrated band power measurement function with band limits set equal to the EBW band edges record the max reading. Repeat the above procedure until the measurements for all frequencies are completed.

### TEST RESULTS

*No non-compliance noted.*

**Test Data****Test mode: IEEE 802.11b mode**

Channel	Frequency (MHz)	Output Power (dBm)	Output Power (W)	Limit (W)	Result
Low	2412	19.16	0.0824	1.00	PASS
Mid	2437	19.03	0.0800		PASS
High	2462	18.18	0.0658		PASS

**Test mode: IEEE 802.11g mode**

Channel	Frequency (MHz)	Output Power (dBm)	Output Power (W)	Limit (W)	Result
Low	2412	16.10	0.0407	1.00	PASS
Mid	2437	19.46	0.0883		PASS
High	2462	15.90	0.0389		PASS

**Test mode: IEEE 802.11n HT 20 MHz mode**

Channel	Frequency (MHz)	Main Antenna Output Power (dBm)	Aux Antenna Output Power (dBm)	Total Output Power (dBm)	Output Power (W)	Limit (W)	Result
Low	2412	15.35	9.41	16.34	0.0430	1.00	PASS
Mid	2437	15.84	10.45	16.94	0.0495		PASS
High	2462	14.87	7.37	15.58	0.0361		PASS

**Test mode: IEEE 802.11n HT 40 MHz mode**

Channel	Frequency (MHz)	Main Antenna Output Power (dBm)	Aux Antenna Output Power (dBm)	Total Output Power (dBm)	Output Power (W)	Limit (W)	Result
Low	2422	11.41	5.18	12.34	0.0171	1.00	PASS
Mid	2437	15.03	10.61	16.37	0.0433		PASS
High	2452	12.30	5.50	13.12	0.0205		PASS

**Remark:** Total Output Power (w) = Main Antenna( $10^{(Output Power / 10) / 1000}$ ) + Aux Antenna ( $10^{(Output Power / 10) / 1000}$ )





**Test mode: IEEE 802.11a mode**

Channel	Frequency (MHz)	Output Power (dBm)	Output Power (W)	Limit (W)	Result
Low	5745	13.08	0.0203	1.00	PASS
Mid	5785	12.63	0.0183		PASS
High	5825	11.91	0.0155		PASS

**Test mode: IEEE 802.11n HT 20 MHz mode**

Channel	Frequency (MHz)	Output Power (dBm)	Output Power (W)	Limit (W)	Result
Low	5745	9.69	0.0093	1.00	PASS
Mid	5785	8.81	0.0076		PASS
High	5825	8.44	0.0070		PASS

**Test mode: IEEE 802.11n HT 40 MHz mode**

Channel	Frequency (MHz)	Output Power (dBm)	Output Power (W)	Limit (W)	Result
Low	5755	8.53	0.0071	1.00	PASS
High	5795	7.79	0.0060		PASS



### IEEE 802.11b mode

#### Average power (CH Low)

Agilent 15:20:27 Oct 12, 2012

R T

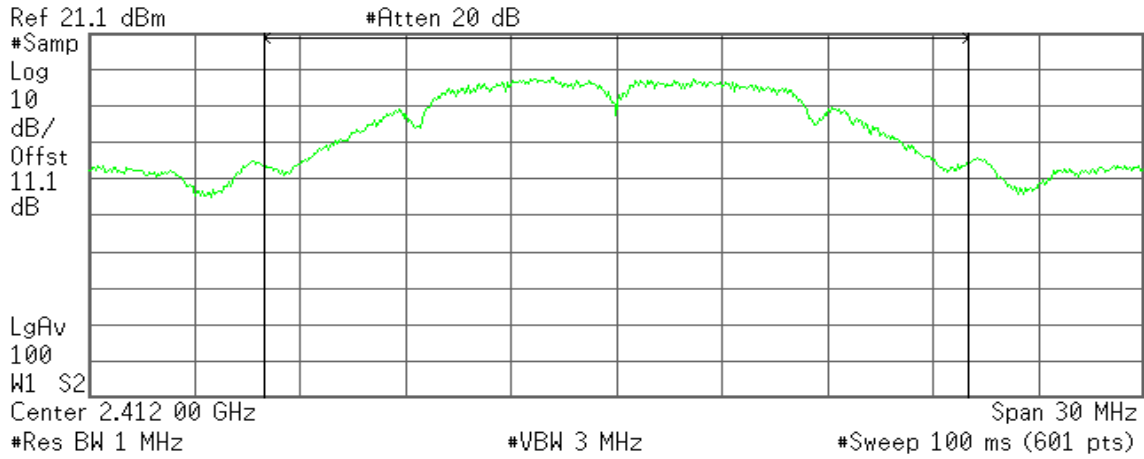

Channel Power

19.16 dBm /20.0000 MHz

Power Spectral Density

-53.85 dBm/Hz

#### Average power (CH Mid)

Agilent 15:21:42 Oct 12, 2012

R T

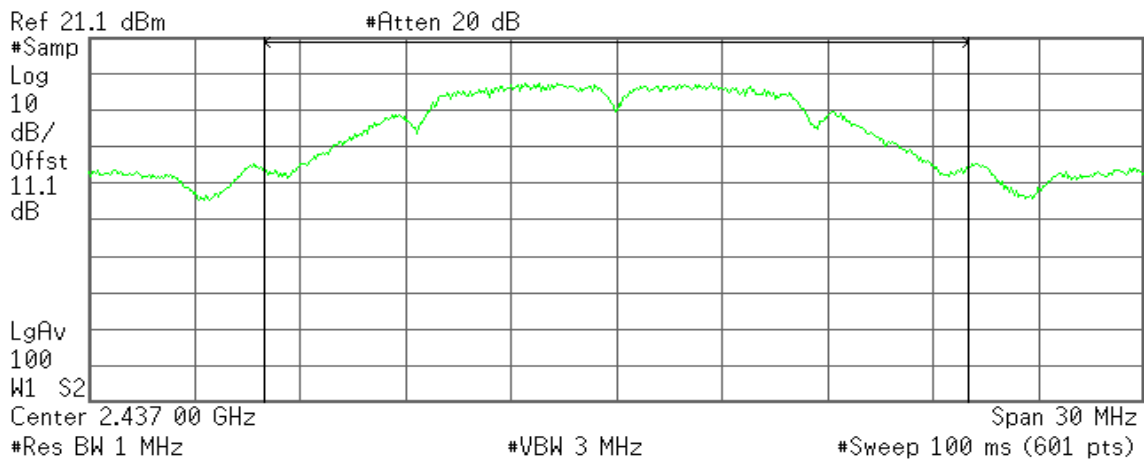

Channel Power

19.03 dBm /20.0000 MHz

Power Spectral Density

-53.98 dBm/Hz



### Average power (CH High)

Agilent 15:22:50 Oct 12, 2012

R T

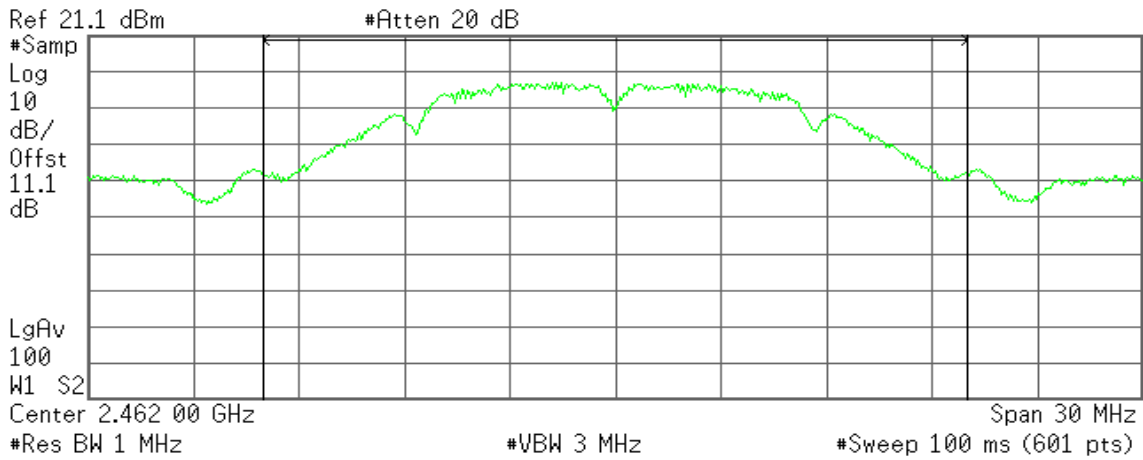

Channel Power

18.18 dBm /20.0000 MHz

Power Spectral Density

-54.83 dBm/Hz

### IEEE 802.11g mode

#### Average power (CH Low)

Agilent 16:21:48 Oct 12, 2012

R T

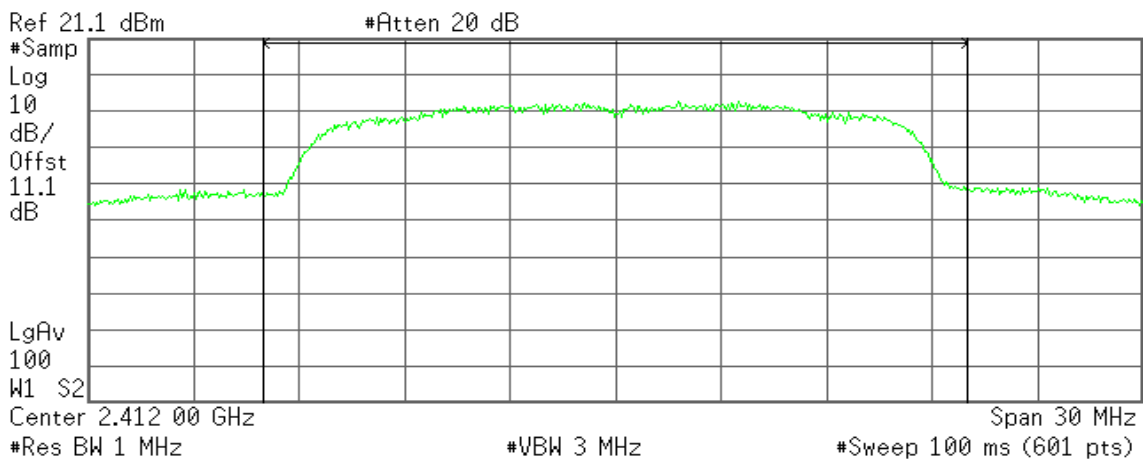

Channel Power

16.10 dBm /20.0000 MHz

Power Spectral Density

-56.91 dBm/Hz



### Average power (CH Mid)

Agilent 15:52:11 Oct 12, 2012

R T

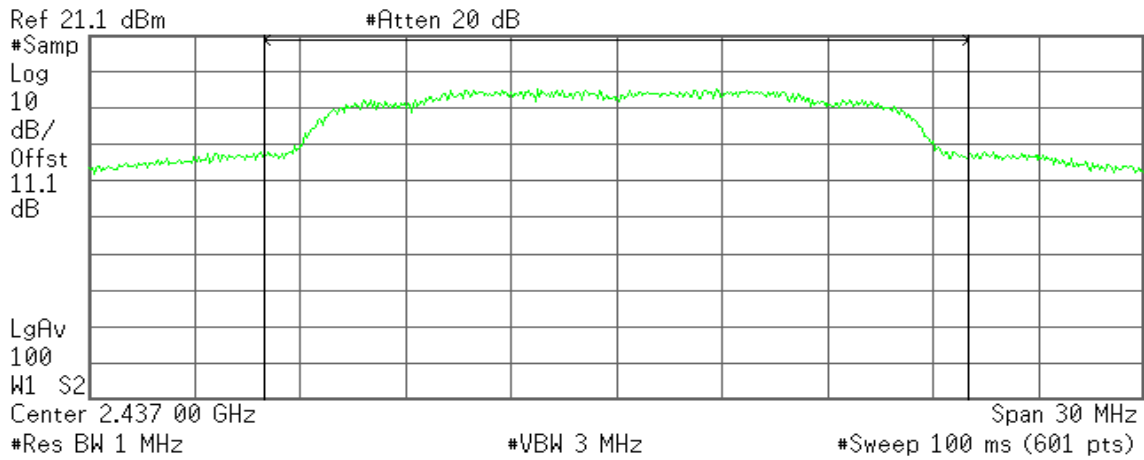

**Channel Power**

19.46 dBm /20.0000 MHz

**Power Spectral Density**

-53.55 dBm/Hz

### Average power (CH High)

Agilent 15:53:48 Oct 12, 2012

R T

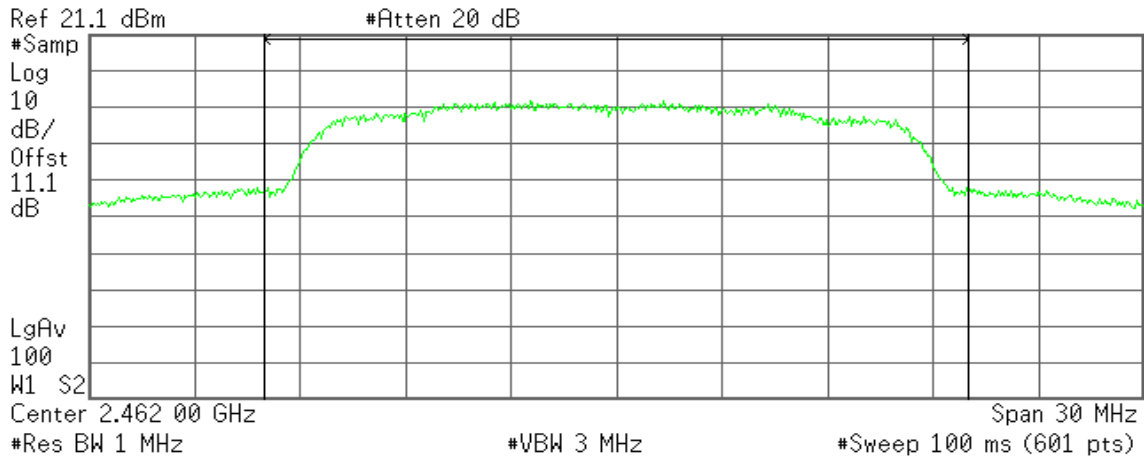

**Channel Power**

15.90 dBm /20.0000 MHz

**Power Spectral Density**

-57.11 dBm/Hz



### IEEE 802.11n HT20 MHz mode / Main Antenna

#### Average power (CH Low)

Agilent 16:27:37 Oct 12, 2012

R T

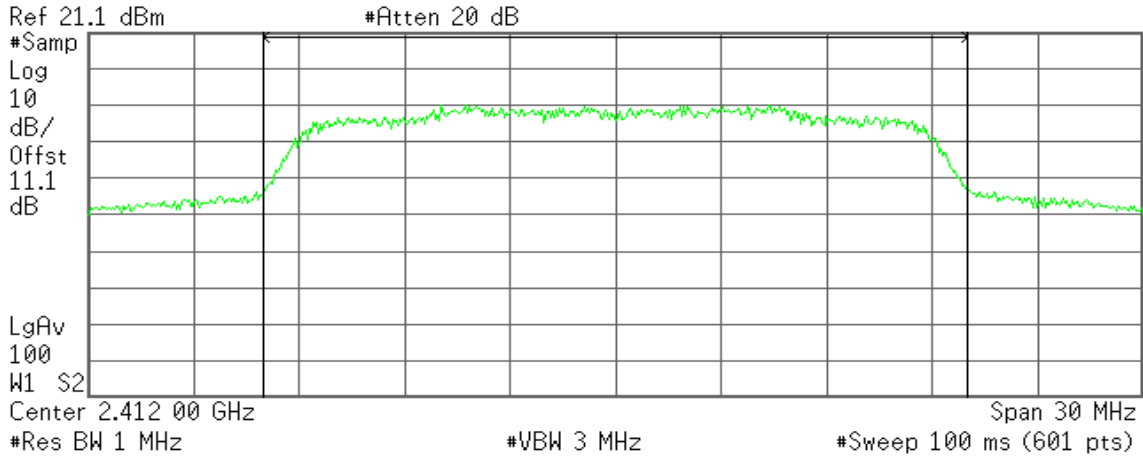

Channel Power

15.35 dBm /20.0000 MHz

Power Spectral Density

-57.66 dBm/Hz

#### Average power (CH Mid)

Agilent 16:15:03 Oct 12, 2012

R T

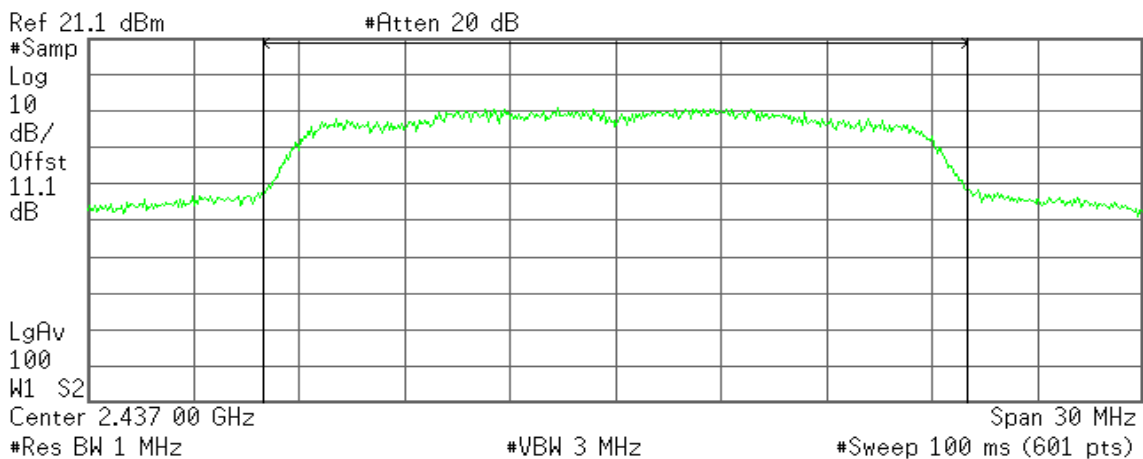

Channel Power

15.84 dBm /20.0000 MHz

Power Spectral Density

-57.17 dBm/Hz



### Average power (CH High)

Agilent 16:32:27 Oct 12, 2012

R T

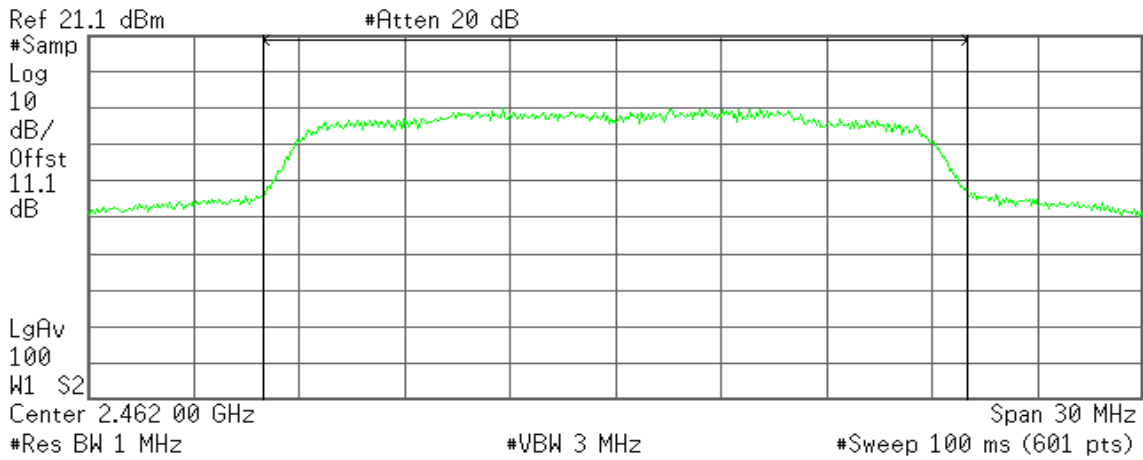

**Channel Power**

14.87 dBm /20.0000 MHz

**Power Spectral Density**

-58.14 dBm/Hz

### IEEE 802.11n HT20 MHz mode / Aux Antenna

#### Average power (CH Low)

Agilent 17:57:03 Oct 12, 2012

R T

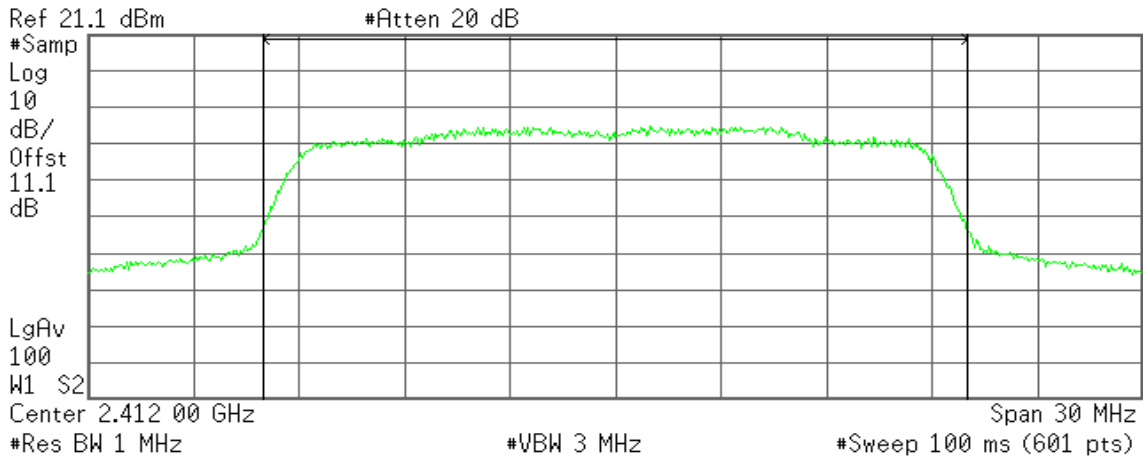

**Channel Power**

9.41 dBm /20.0000 MHz

**Power Spectral Density**

-63.60 dBm/Hz



### Average power (CH Mid)

Agilent 17:58:15 Oct 12, 2012

R T

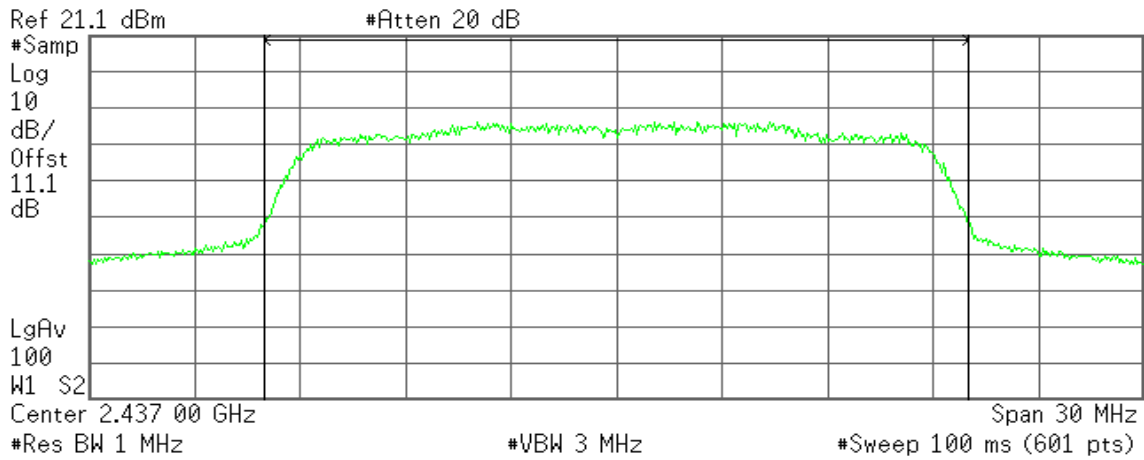

**Channel Power**

10.45 dBm /20.0000 MHz

**Power Spectral Density**

-62.56 dBm/Hz

### Average power (CH High)

Agilent 17:59:43 Oct 12, 2012

R T

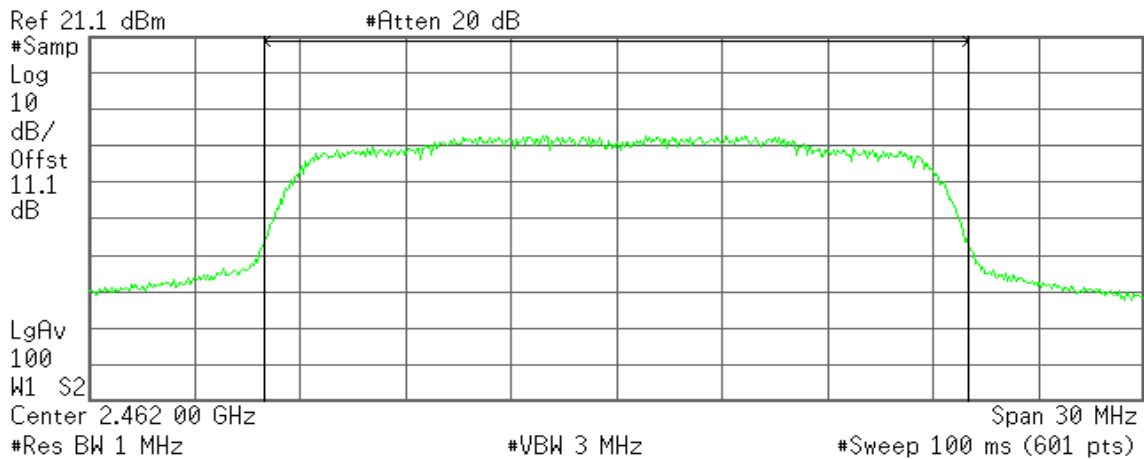

**Channel Power**

7.37 dBm /20.0000 MHz

**Power Spectral Density**

-65.64 dBm/Hz



### IEEE 802.11n HT40 MHz mode / Main Antenna

#### Average power (CH Low)

Agilent 20:01:42 Oct 12, 2012

R T

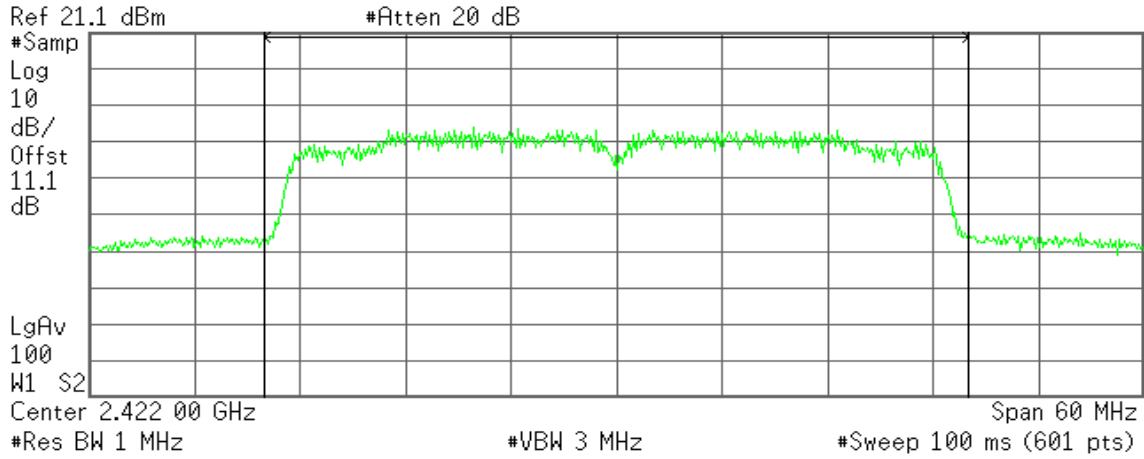

Channel Power

11.41 dBm /40.0000 MHz

Power Spectral Density

-64.61 dBm/Hz

#### Average power (CH Mid)

Agilent 20:03:42 Oct 12, 2012

R T

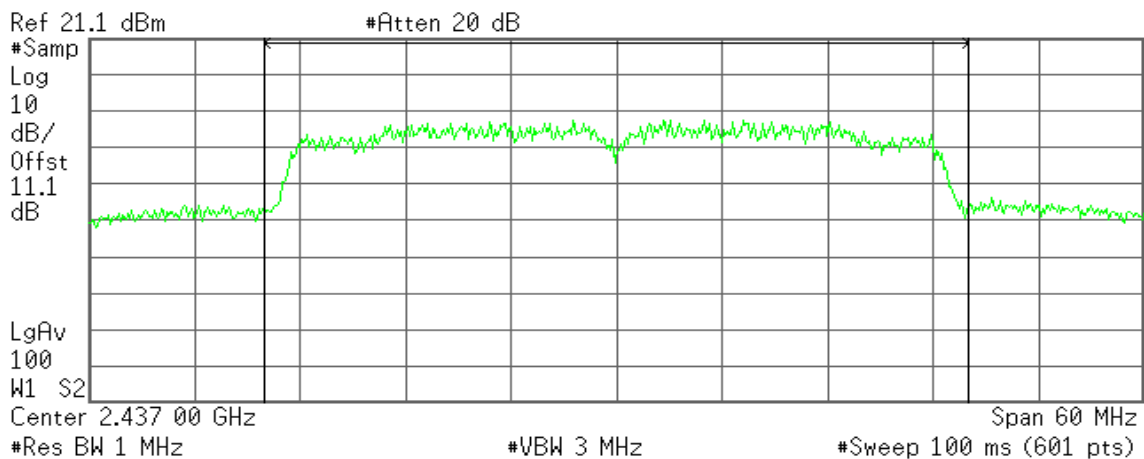

Channel Power

15.03 dBm /40.0000 MHz

Power Spectral Density

-60.99 dBm/Hz





### Average power (CH High)

Agilent 20:05:18 Oct 12, 2012

R T

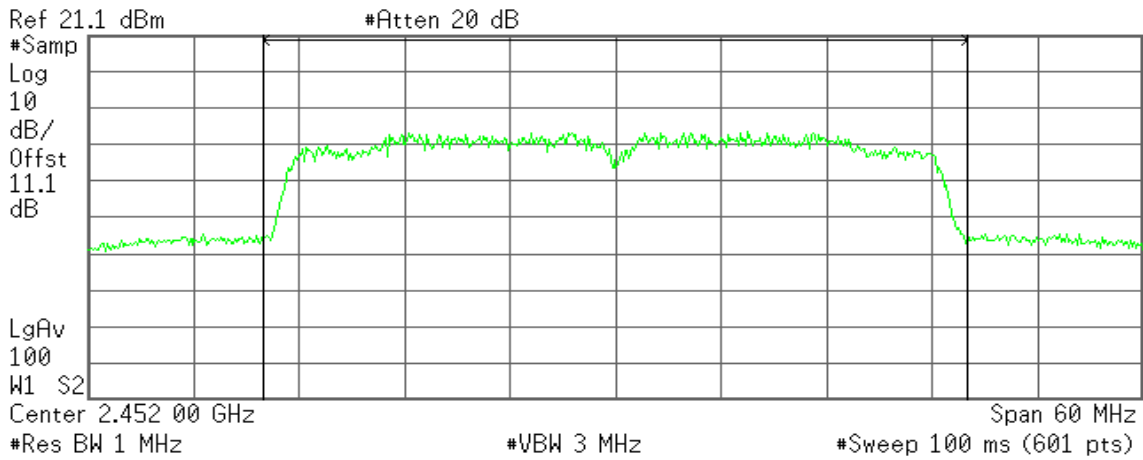

Channel Power

12.30 dBm /40.0000 MHz

Power Spectral Density

-63.73 dBm/Hz

### IEEE 802.11n HT40 MHz mode / Aux Antenna

#### Average power (CH Low)

Agilent

R T

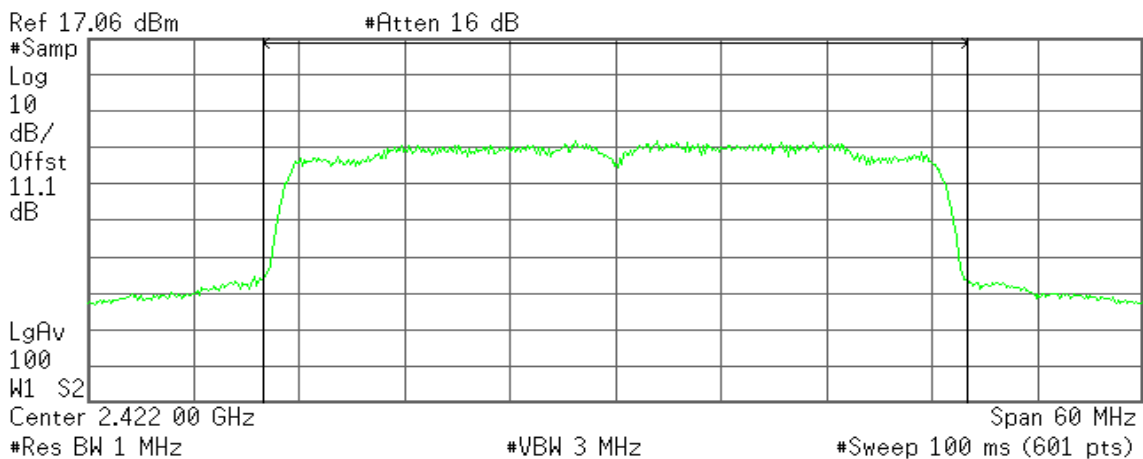

Channel Power

5.18 dBm /40.0000 MHz

Power Spectral Density

-70.84 dBm/Hz



### Average power (CH Mid)

Agilent

R T

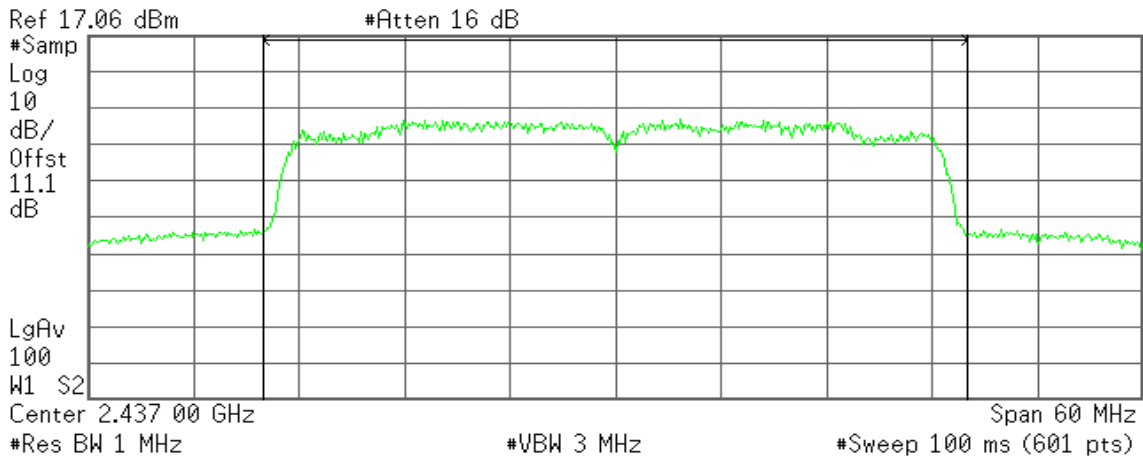

Channel Power

10.61 dBm /40.0000 MHz

Power Spectral Density

-65.41 dBm/Hz

### Average power (CH High)

Agilent

R T

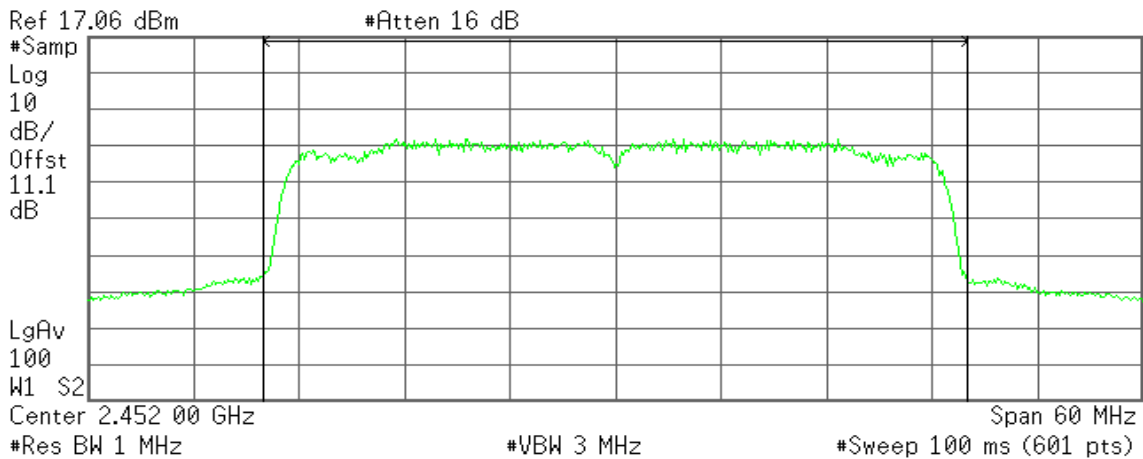

Channel Power

5.50 dBm /40.0000 MHz

Power Spectral Density

-70.52 dBm/Hz



### IEEE 802.11a mode

#### Average power (CH Low)

Agilent

R T

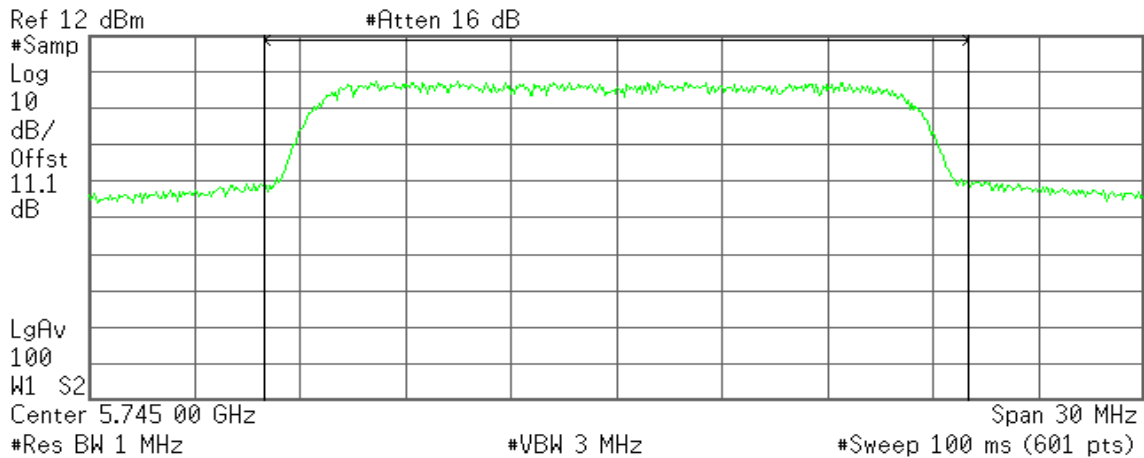

Channel Power

13.08 dBm /20.0000 MHz

Power Spectral Density

-59.93 dBm/Hz

#### Average power (CH Mid)

Agilent

R T

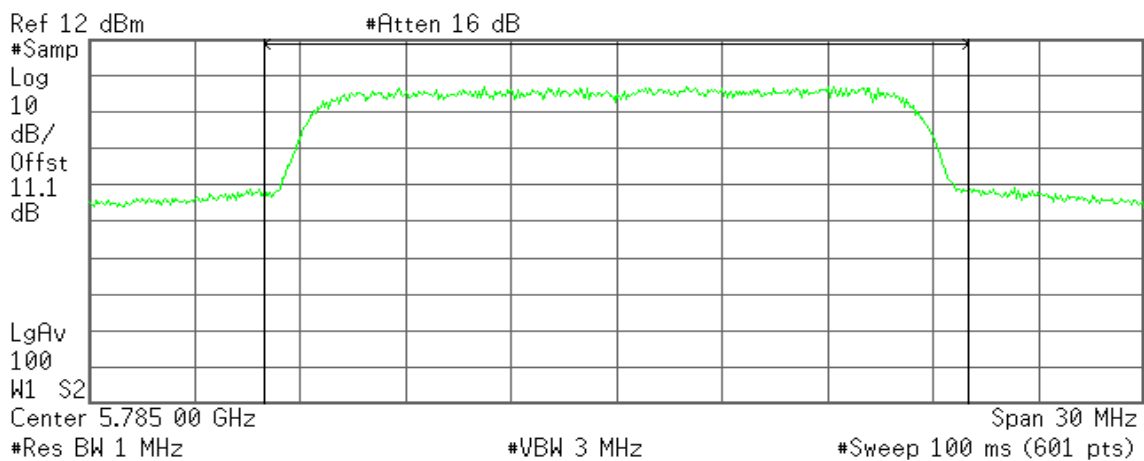

Channel Power

12.63 dBm /20.0000 MHz

Power Spectral Density

-60.38 dBm/Hz



### Average power (CH High)

Agilent

R T

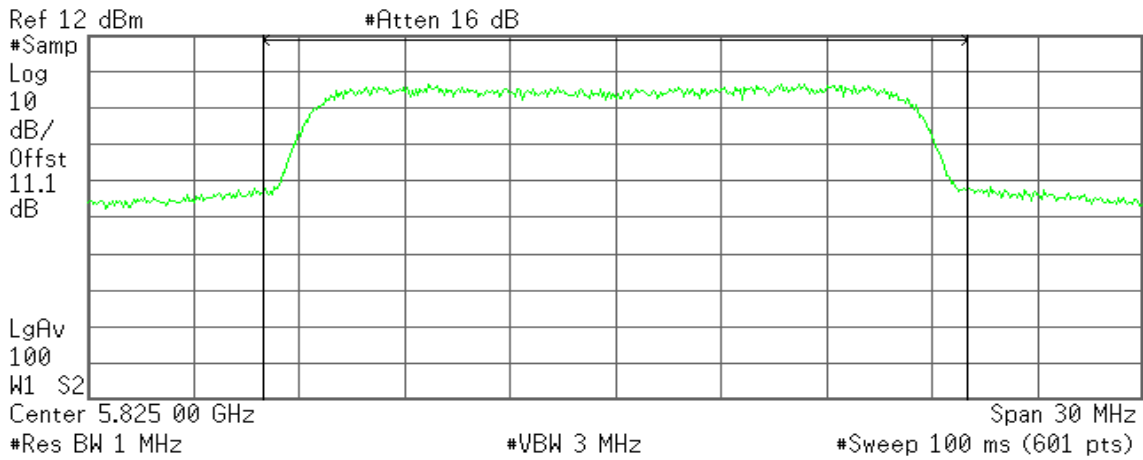

Channel Power

11.91 dBm /20.0000 MHz

Power Spectral Density

-61.10 dBm/Hz

### IEEE 802.11n HT 20 MHz mode

#### Average power (CH Low)

Agilent

R T

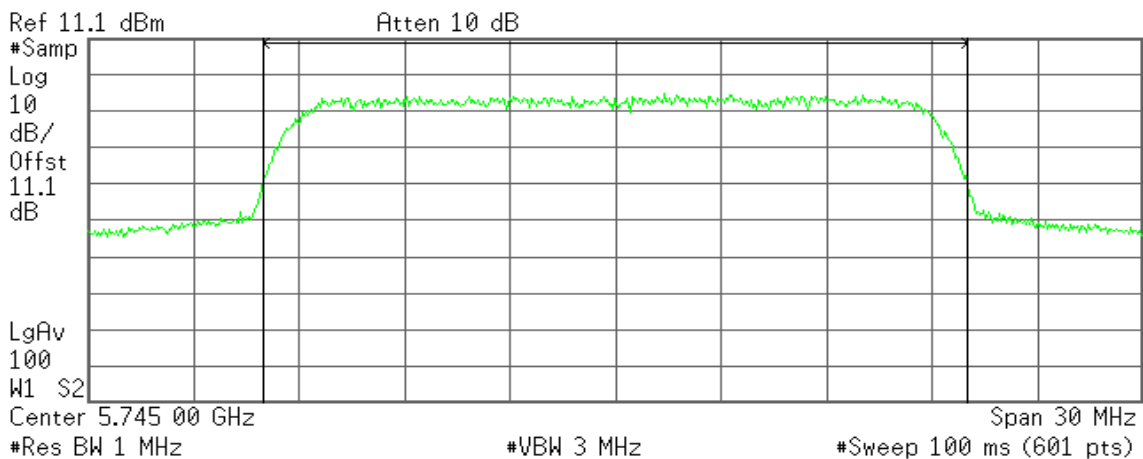

Channel Power

9.69 dBm /20.0000 MHz

Power Spectral Density

-63.32 dBm/Hz



### Average power (CH Mid)

Agilent

R T

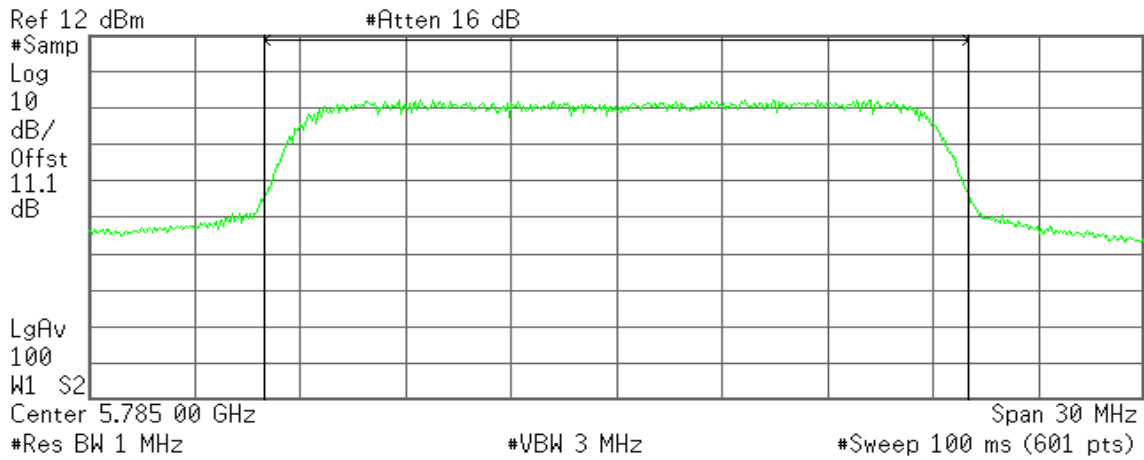

Channel Power

8.81 dBm /20.0000 MHz

Power Spectral Density

-64.20 dBm/Hz

### Average power (CH High)

Agilent

R T

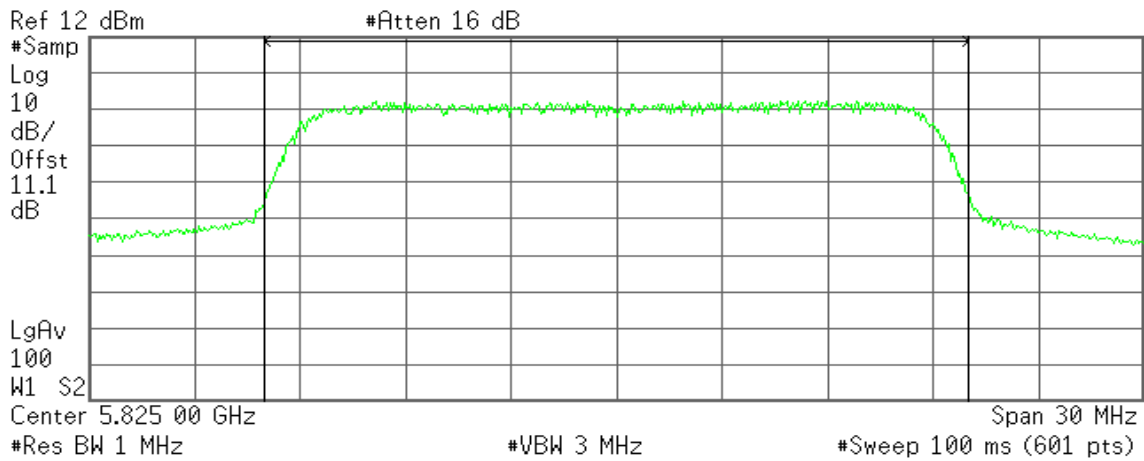

Channel Power

8.44 dBm /20.0000 MHz

Power Spectral Density

-64.57 dBm/Hz



### IEEE 802.11n HT 40 MHz mode

#### Average power (CH Low)

Agilent

R T

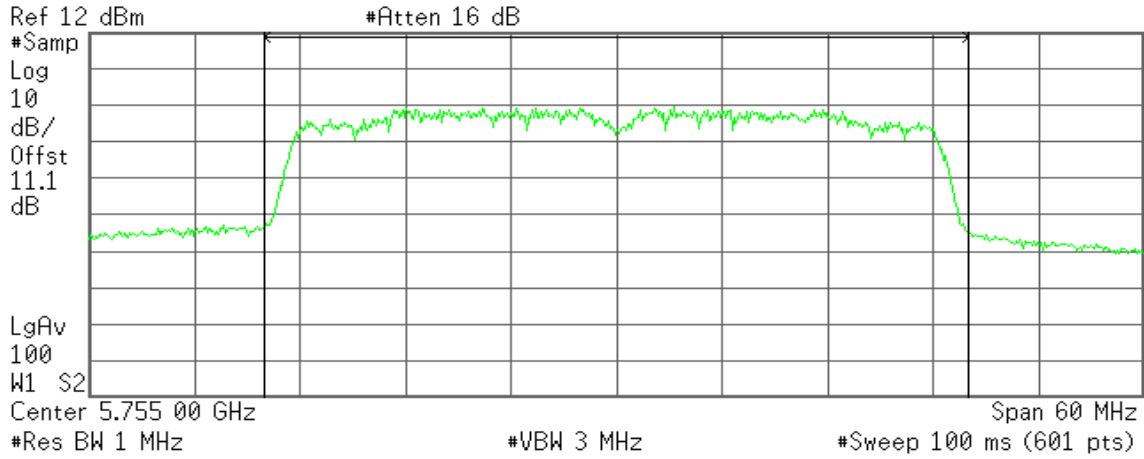

Channel Power

8.53 dBm /40.0000 MHz

Power Spectral Density

-67.49 dBm/Hz

#### Average power (CH High)

Agilent

R T

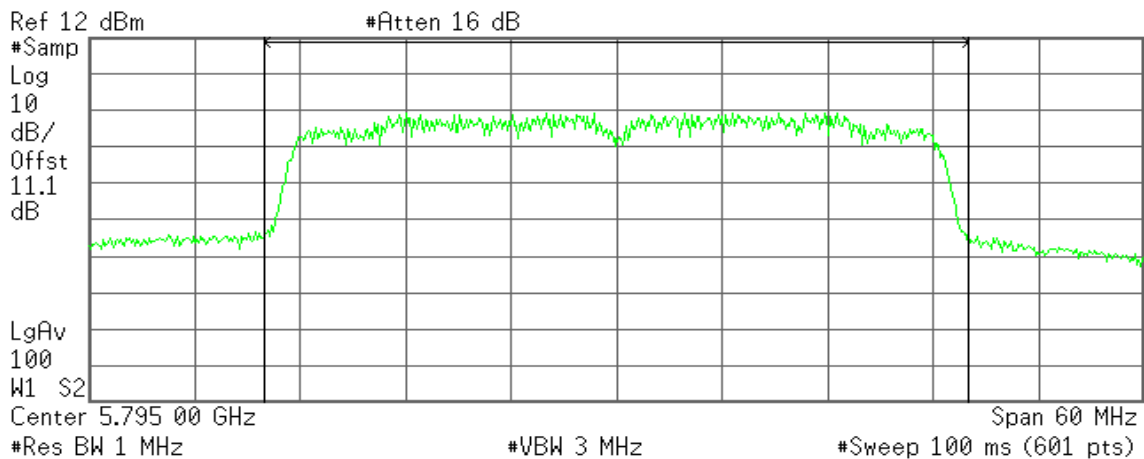

Channel Power

7.79 dBm /40.0000 MHz

Power Spectral Density

-68.23 dBm/Hz



## 7.5 BAND EDGES MEASUREMENT

### LIMIT

According to §15.247(d), in any 100 kHz bandwidth outside the frequency bands in which the spread spectrum intentional radiator is operating, the radio frequency power that is produced by the intentional radiator shall be at least 20 dB below that in the 100 kHz bandwidth within the band that contains the highest level of the desired power, based on either an RF conducted or a radiated measurement, provided the transmitter demonstrates compliance with the peak conducted power limits. In addition, radiated emissions which fall in the restricted bands, as defined in §15.205(a), must also comply with the radiated emission limits specified in 15.209(a) (see Section 15.205(c)).

### Test Configuration

#### For Radiated

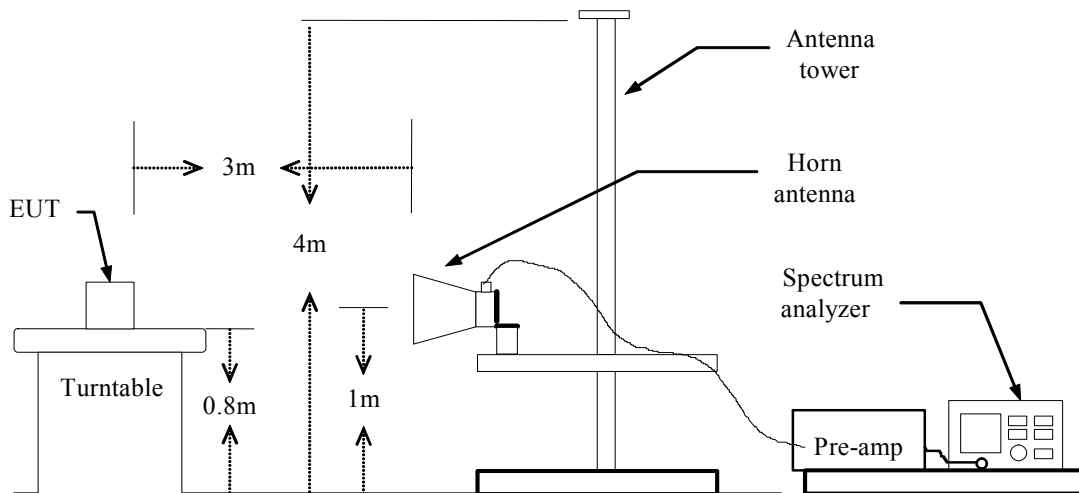

#### For Conducted

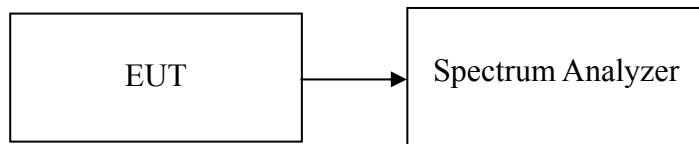



## **TEST PROCEDURE**

### **For Radiated**

1. The EUT is placed on a turntable, which is 0.8m above the ground plane.
2. The turntable shall be rotated for 360 degrees to determine the position of maximum emission level.
3. EUT is set 3m away from the receiving antenna, which is varied from 1m to 4m to find out the highest emission.
4. Set the spectrum analyzer in the following setting in order to capture the lower and upper band-edges of the emission:
  - (a) PEAK: RBW=VBW=1MHz / Sweep=AUTO
  - (b) AVERAGE: RBW=1MHz / VBW=10Hz / Sweep=AUTO
5. Repeat the procedures until all the PEAK and AVERAGE versus POLARIZATION are measured.

### **For Conducted**

Conducted RF measurements of the transmitter output were made to confirm that the EUT antenna port conducted emissions meet the specified limit and to identify any spurious signals that require further investigation or measurements on the radiated emissions site.

The transmitter output is connected to the spectrum analyzer. The resolution bandwidth is set to 100 kHz. The video bandwidth is set to 100 kHz.

## **TEST RESULTS**

Refer to attach spectrum analyzer data chart.





**802.11a Mode**

1. Operating Frequency: 5725-5875MHz
2. CH Low: 5745MHz, CH High: 5825MHz
3. 6dB bandwidth: CH Low: 16.5833MHz, CH High: 16.5833MHz

Because the mentioned conditions, the test is not applicable.



### Band Edges (IEEE 802.11b mode / CH Low)

Detector mode: Peak

Polarity: Vertical

Agilent

R T

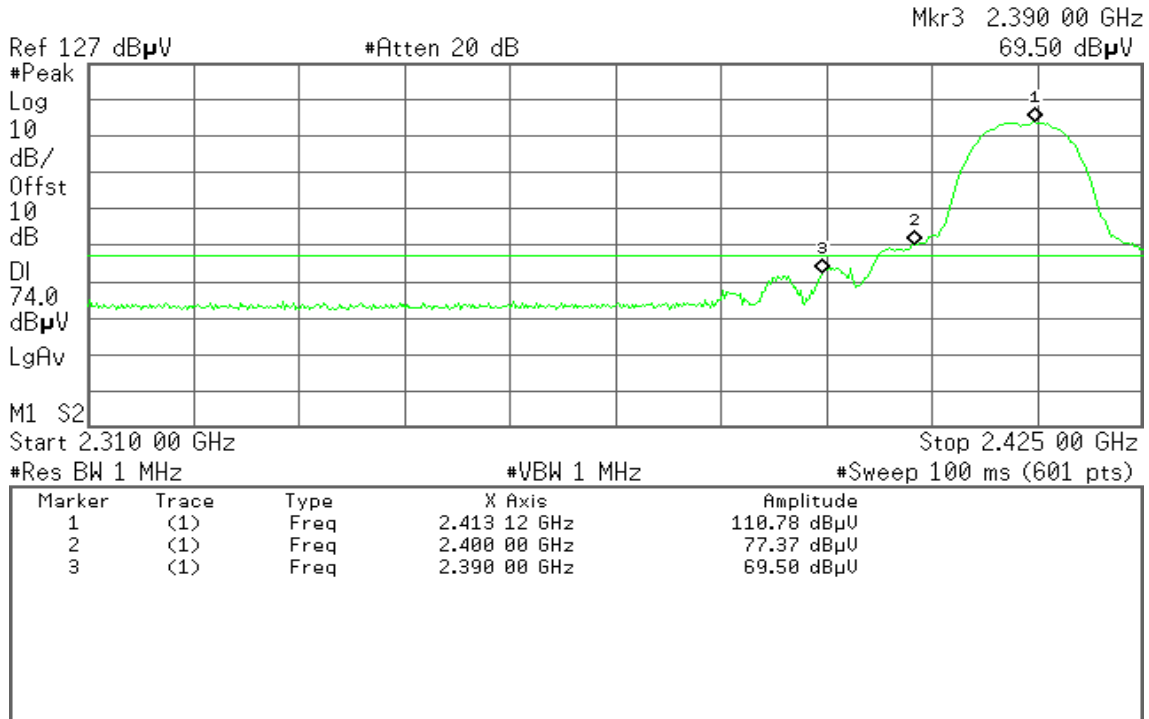

Detector mode: Average

Polarity: Vertical

Agilent

R T

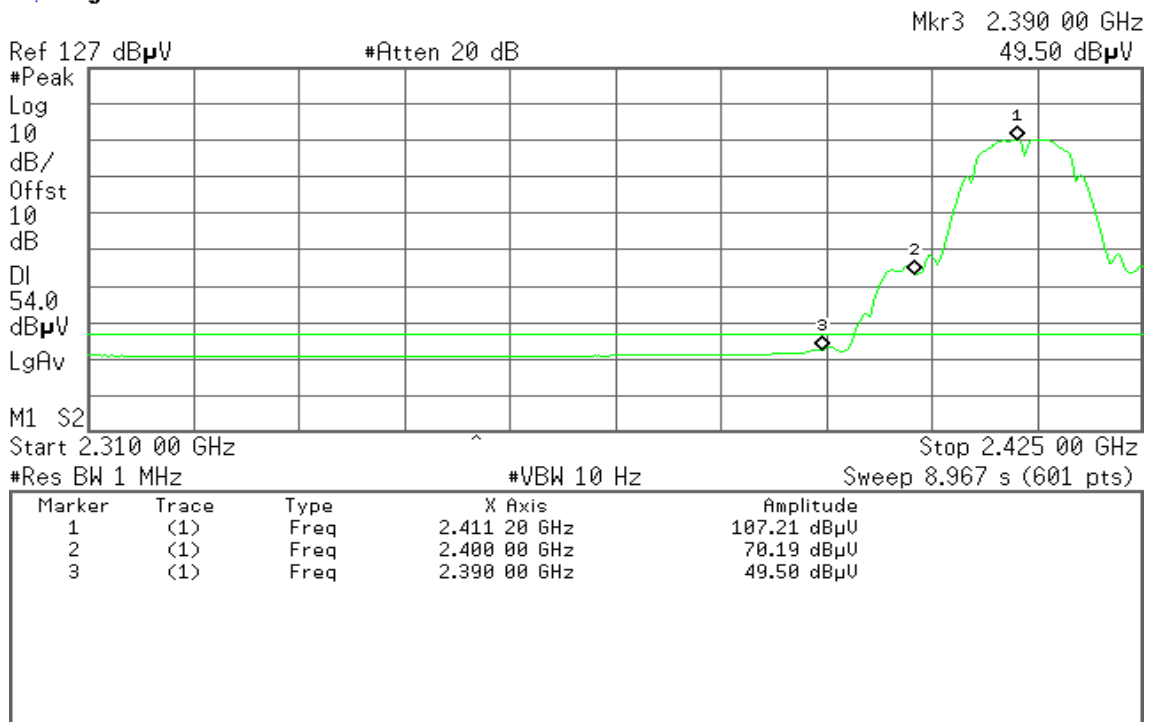



Detector mode: Peak

Polarity: Horizontal

Agilent

R T

Mkr3 2.390 00 GHz  
66.98 dBμV

Ref 127 dBμV

#Atten 20 dB

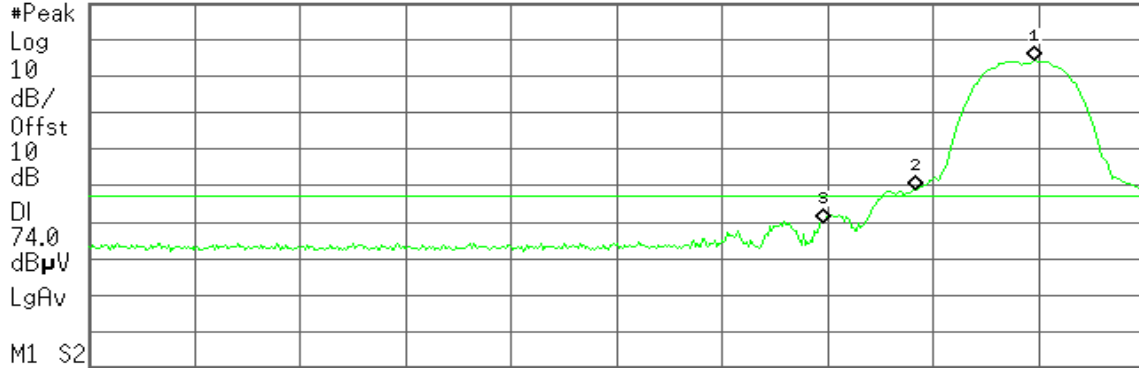

M1 S2  
Start 2.310 00 GHz

Stop 2.425 00 GHz

#Res BW 1 MHz

#VBW 1 MHz

#Sweep 100 ms (601 pts)

Marker	Trace	Type	X Axis	Amplitude
1	(1)	Freq	2.412 92 GHz	111.22 dBμV
2	(1)	Freq	2.400 00 GHz	75.98 dBμV
3	(1)	Freq	2.390 00 GHz	66.98 dBμV

Detector mode: Average

Polarity: Horizontal

Agilent

R T

Mkr3 2.390 00 GHz  
49.53 dBμV

Ref 127 dBμV

#Atten 20 dB

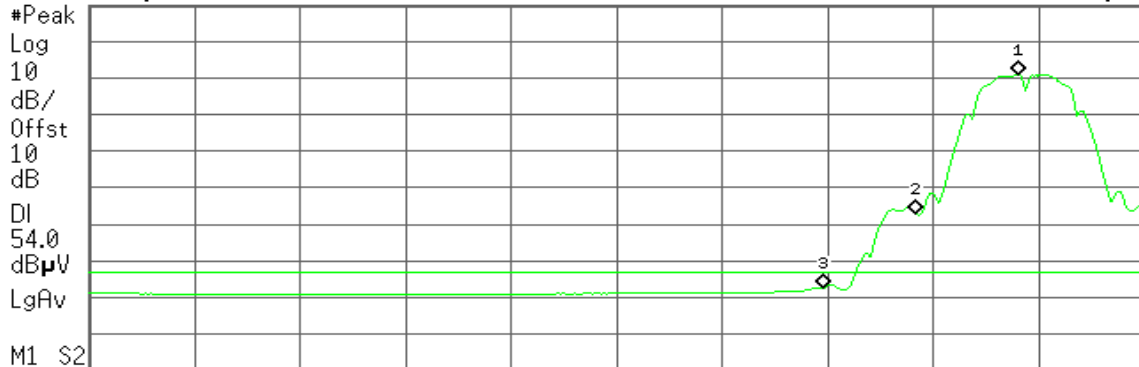

M1 S2  
Start 2.310 00 GHz ^

Stop 2.425 00 GHz

#Res BW 1 MHz

#VBW 10 Hz

Sweep 8.967 s (601 pts)

Marker	Trace	Type	X Axis	Amplitude
1	(1)	Freq	2.411 20 GHz	108.04 dBμV
2	(1)	Freq	2.400 00 GHz	69.68 dBμV
3	(1)	Freq	2.390 00 GHz	49.53 dBμV



### Band Edges (IEEE 802.11b mode / CH High)

Detector mode: Peak

Polarity: Vertical

Agilent

R T

Mkr2 2.483 50 GHz

68.68 dBμV

Ref 127 dBμV

#Atten 20 dB

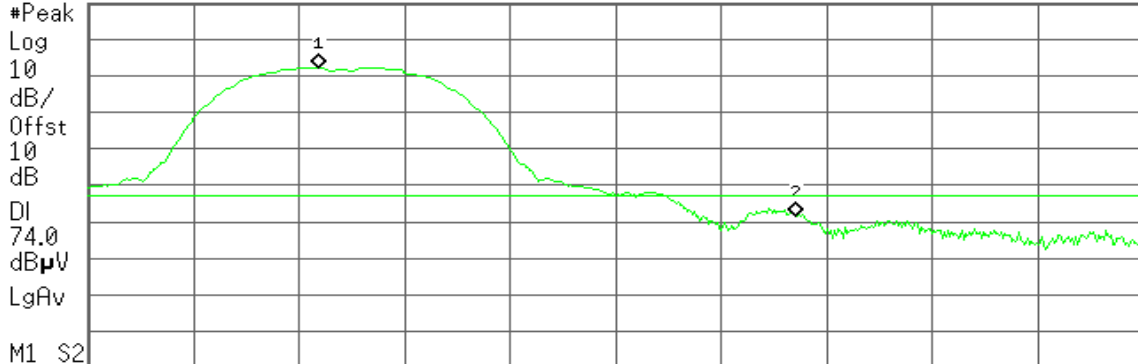

Start 2.450 00 GHz

Stop 2.500 00 GHz

#Res BW 1 MHz

#VBW 1 MHz

#Sweep 100 ms (601 pts)

Marker	Trace	Type	X Axis	Amplitude
1	(1)	Freq	2.460 92 GHz	109.42 dBμU
2	(1)	Freq	2.483 50 GHz	68.68 dBμU

Detector mode: Average

Polarity: Vertical

Agilent

R T

Mkr2 2.483 50 GHz

49.20 dBμV

Ref 127 dBμV

#Atten 20 dB

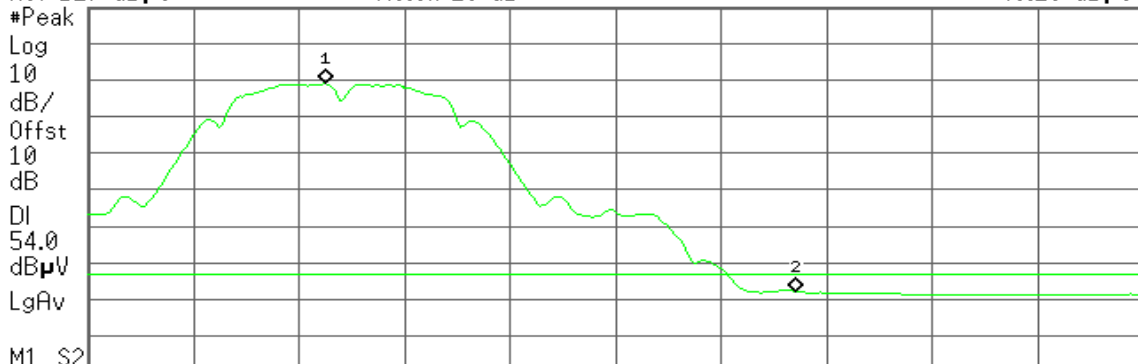

Start 2.450 00 GHz

Stop 2.500 00 GHz

#Res BW 1 MHz

#VBW 10 Hz

Sweep 3.899 s (601 pts)

Marker	Trace	Type	X Axis	Amplitude
1	(1)	Freq	2.461 25 GHz	106.03 dBμU
2	(1)	Freq	2.483 50 GHz	49.20 dBμU



Detector mode: Peak

Polarity: Horizontal

Agilent

R T

Mkr2 2.483 50 GHz  
71.09 dBμV

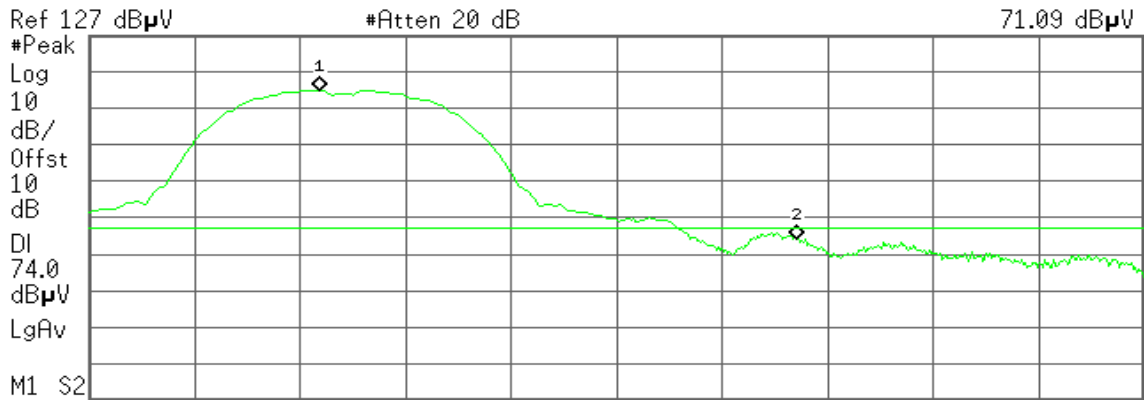

Start 2.450 00 GHz Stop 2.500 00 GHz  
#Res BW 1 MHz #VBW 1 MHz #Sweep 100 ms (601 pts)

Marker	Trace	Type	X Axis	Amplitude
1	(1)	Freq	2.460 92 GHz	111.81 dBμU
2	(1)	Freq	2.483 50 GHz	71.09 dBμU

Detector mode: Average

Polarity: Horizontal

Agilent

R T

Mkr2 2.483 50 GHz  
49.97 dBμV

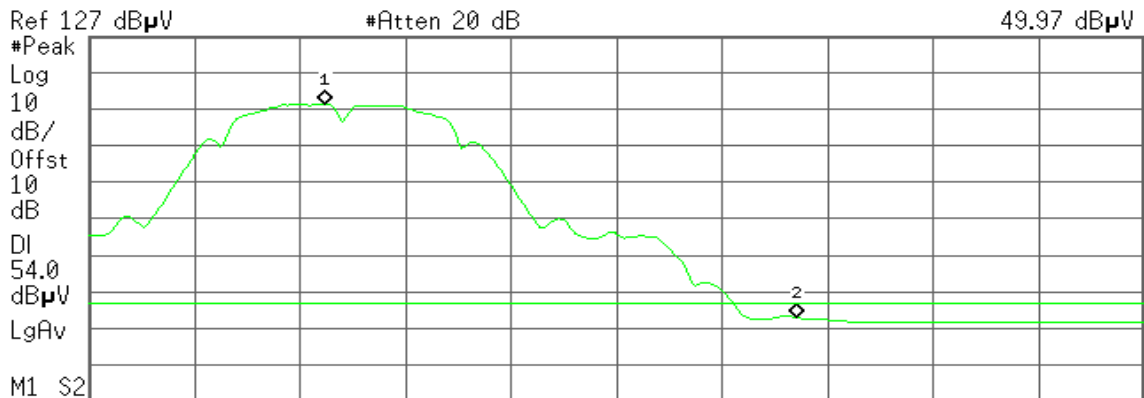

Start 2.450 00 GHz Stop 2.500 00 GHz  
#Res BW 1 MHz #VBW 10 Hz Sweep 3.899 s (601 pts)

Marker	Trace	Type	X Axis	Amplitude
1	(1)	Freq	2.461 17 GHz	108.52 dBμU
2	(1)	Freq	2.483 50 GHz	49.97 dBμU



Band Edges (IEEE 802.11g mode / CH Low)

Detector mode: Peak

Polarity: Vertical

Agilent

R T

Mkr3 2.390 00 GHz  
67.99 dBµV

Ref 127 dBµV

#Atten 20 dB

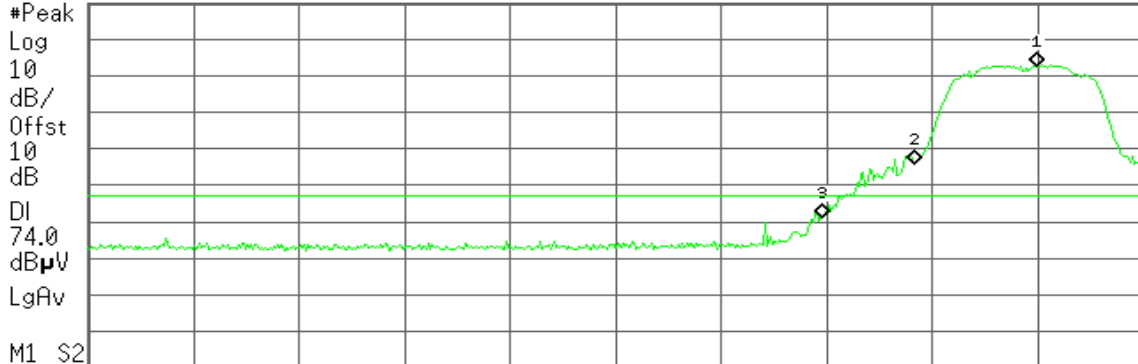

Start 2.310 00 GHz

Stop 2.425 00 GHz

#Res BW 1 MHz

#VBW 1 MHz

#Sweep 100 ms (601 pts)

Marker	Trace	Type	X Axis	Amplitude
1	(1)	Freq	2.413 50 GHz	109.82 dBµU
2	(1)	Freq	2.400 00 GHz	82.96 dBµU
3	(1)	Freq	2.390 00 GHz	67.99 dBµU

Detector mode: Average

Polarity: Vertical

Agilent

R T

Mkr3 2.390 00 GHz  
51.38 dBµV

Ref 127 dBµV

#Atten 20 dB



Start 2.310 00 GHz

Stop 2.425 00 GHz

#Res BW 1 MHz

#VBW 10 Hz

Sweep 8.967 s (601 pts)

Marker	Trace	Type	X Axis	Amplitude
1	(1)	Freq	2.410 24 GHz	100.41 dBµU
2	(1)	Freq	2.400 00 GHz	67.19 dBµU
3	(1)	Freq	2.390 00 GHz	51.38 dBµU



Detector mode: Peak

Polarity: Horizontal

Agilent

R T

Mkr3 2.390 00 GHz  
68.82 dBµV

Ref 127 dBµV

#Atten 20 dB

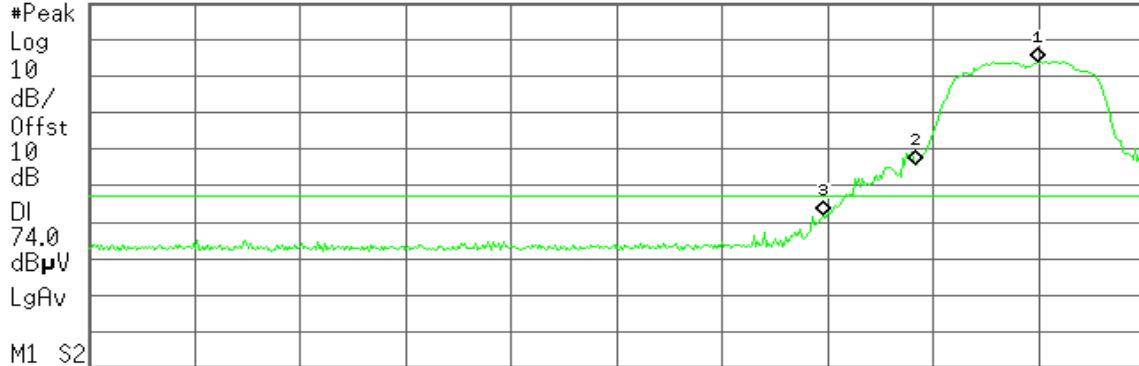

Start 2.310 00 GHz

Stop 2.425 00 GHz

#Res BW 1 MHz

#VBW 1 MHz

#Sweep 100 ms (601 pts)

Marker	Trace	Type	X Axis	Amplitude
1	(1)	Freq	2.413 50 GHz	110.92 dBµU
2	(1)	Freq	2.400 00 GHz	82.87 dBµU
3	(1)	Freq	2.390 00 GHz	68.82 dBµU

Detector mode: Average

Polarity: Horizontal

Agilent

R T

Mkr3 2.390 00 GHz  
51.38 dBµV

Ref 127 dBµV

#Atten 20 dB

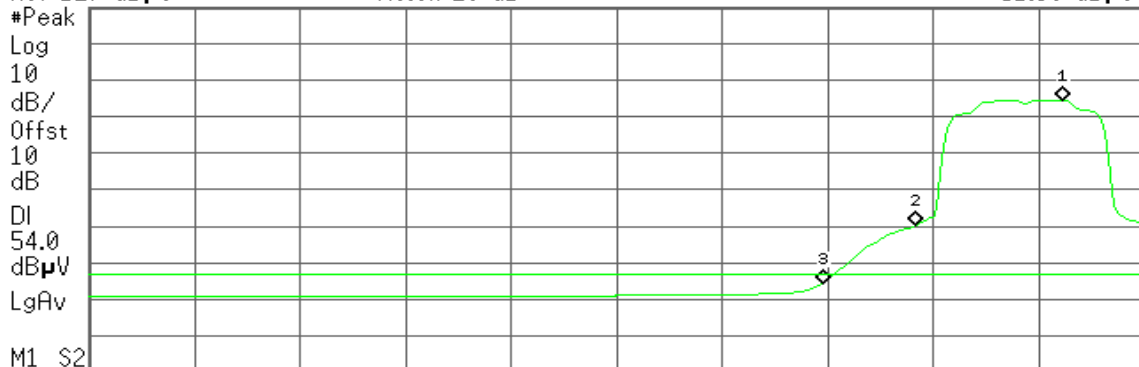

Start 2.310 00 GHz

Stop 2.425 00 GHz

#Res BW 1 MHz

#VBW 10 Hz

Sweep 8.967 s (601 pts)

Marker	Trace	Type	X Axis	Amplitude
1	(1)	Freq	2.416 18 GHz	101.61 dBµU
2	(1)	Freq	2.400 00 GHz	67.28 dBµU
3	(1)	Freq	2.390 00 GHz	51.38 dBµU



### Band Edges (IEEE 802.11g mode / CH High)

Detector mode: Peak

Polarity: Vertical

Agilent

R T

Mkr2 2.483 50 GHz  
67.19 dBμV

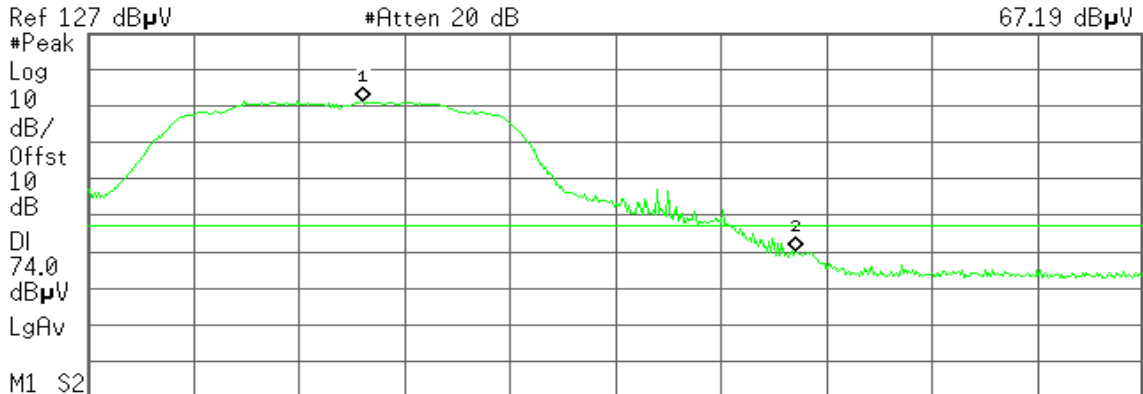

Start 2.450 00 GHz Stop 2.500 00 GHz  
#Res BW 1 MHz #VBW 1 MHz #Sweep 100 ms (601 pts)

Marker	Trace	Type	X Axis	Amplitude
1	(1)	Freq	2.463 00 GHz	108.49 dBμU
2	(1)	Freq	2.483 50 GHz	67.19 dBμU

Detector mode: Average

Polarity: Vertical

Agilent

R T

Mkr2 2.483 50 GHz  
50.50 dBμV

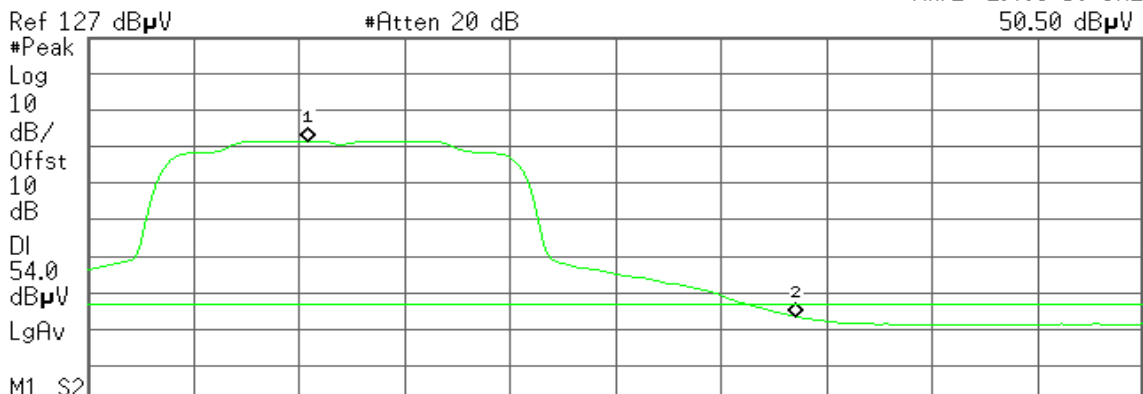

Start 2.450 00 GHz Stop 2.500 00 GHz  
#Res BW 1 MHz #VBW 10 Hz Sweep 3.899 s (601 pts)

Marker	Trace	Type	X Axis	Amplitude
1	(1)	Freq	2.460 42 GHz	98.50 dBμU
2	(1)	Freq	2.483 50 GHz	50.50 dBμU





Detector mode: Peak

Polarity: Horizontal

Agilent

R T

Mkr2 2.483 50 GHz  
66.68 dBμV

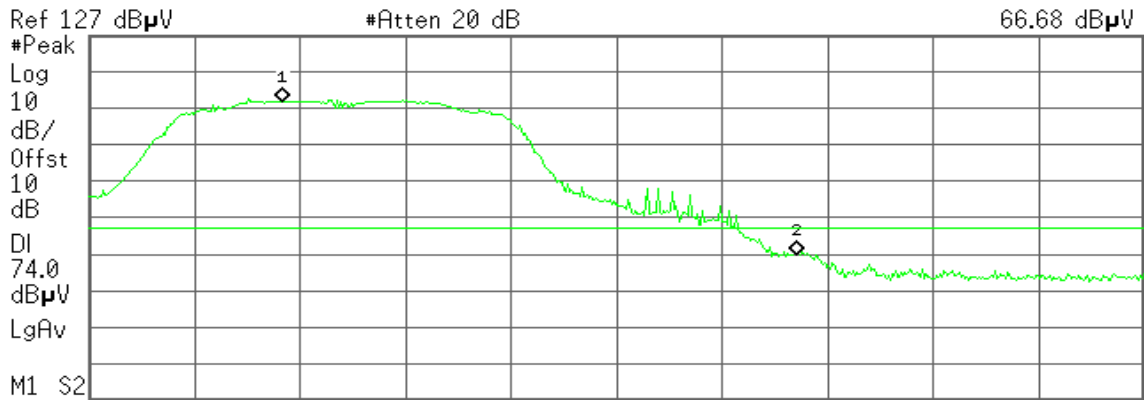

Start 2.450 00 GHz Stop 2.500 00 GHz  
#Res BW 1 MHz #VBW 1 MHz #Sweep 100 ms (601 pts)

Marker	Trace	Type	X Axis	Amplitude
1	(1)	Freq	2.459 17 GHz	109.01 dBμU
2	(1)	Freq	2.483 50 GHz	66.68 dBμU

Detector mode: Average

Polarity: Horizontal

Agilent

R T

Mkr2 2.483 50 GHz  
51.68 dBμV

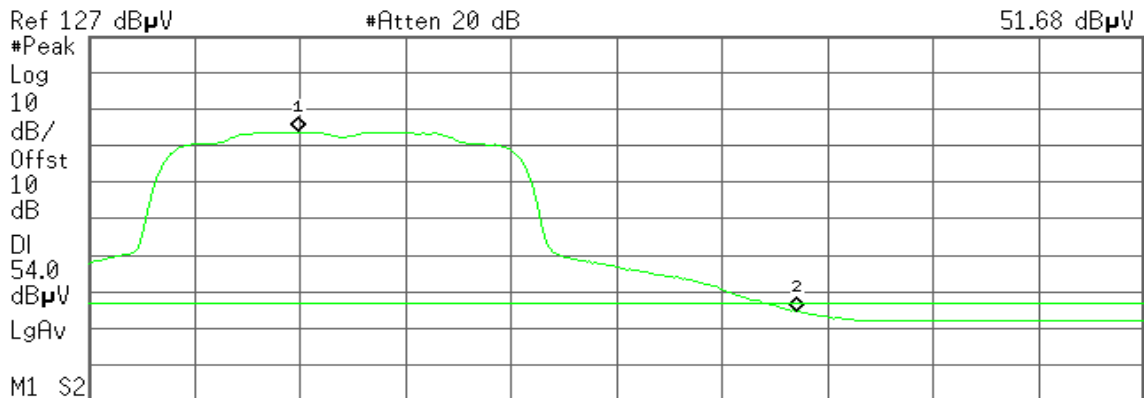

Start 2.450 00 GHz Stop 2.500 00 GHz  
#Res BW 1 MHz #VBW 10 Hz Sweep 3.899 s (601 pts)

Marker	Trace	Type	X Axis	Amplitude
1	(1)	Freq	2.459 92 GHz	100.81 dBμU
2	(1)	Freq	2.483 50 GHz	51.68 dBμU



### Band Edges (IEEE 802.11n HT 20 MHz mode / CH Low)

Detector mode: Peak

Polarity: Vertical

Agilent

R T

Mkr3 2.390 00 GHz  
67.68 dB $\mu$ V

Ref 127 dB $\mu$ V

#Atten 20 dB

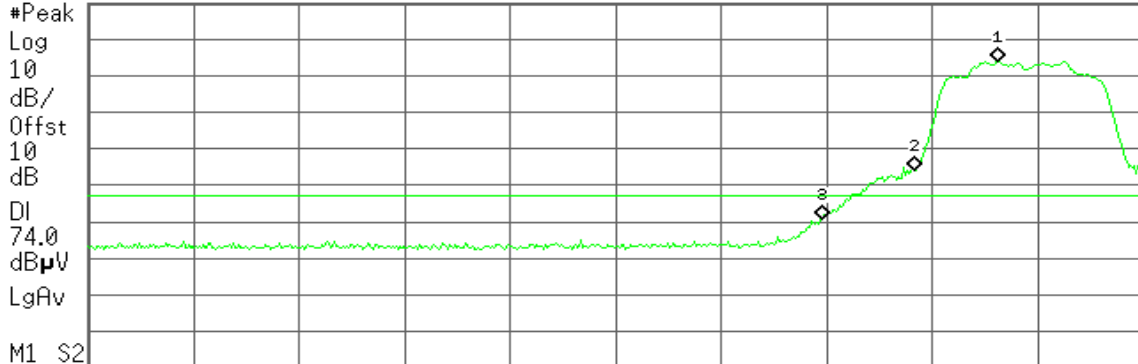

Start 2.310 00 GHz

Stop 2.425 00 GHz

#Res BW 1 MHz

#VBW 1 MHz

#Sweep 100 ms (601 pts)

Marker	Trace	Type	X Axis	Amplitude
1	(1)	Freq	2.409 09 GHz	110.89 dB $\mu$ U
2	(1)	Freq	2.400 00 GHz	80.96 dB $\mu$ U
3	(1)	Freq	2.390 00 GHz	67.68 dB $\mu$ U

Detector mode: Average

Polarity: Vertical

Agilent

R T

Mkr3 2.390 00 GHz  
52.74 dB $\mu$ V

Ref 127 dB $\mu$ V

#Atten 20 dB



Start 2.310 00 GHz

Stop 2.425 00 GHz

#Res BW 1 MHz

#VBW 10 Hz

Sweep 8.967 s (601 pts)

Marker	Trace	Type	X Axis	Amplitude
1	(1)	Freq	2.409 09 GHz	98.77 dB $\mu$ U
2	(1)	Freq	2.400 00 GHz	65.87 dB $\mu$ U
3	(1)	Freq	2.390 00 GHz	52.74 dB $\mu$ U



Detector mode: Peak

Polarity: Horizontal

Agilent

R T

Mkr3 2.390 00 GHz  
67.69 dBμV

Ref 127 dBμV

#Atten 20 dB

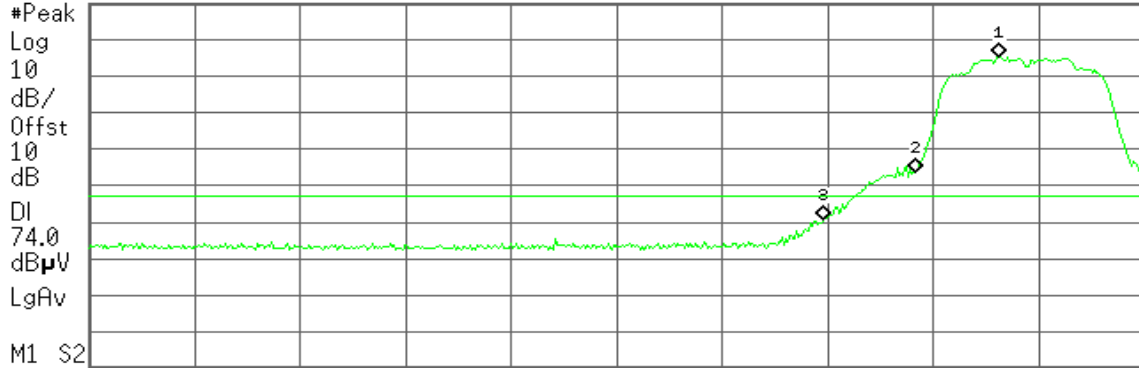

Start 2.310 00 GHz

Stop 2.425 00 GHz

#Res BW 1 MHz

#VBW 1 MHz

#Sweep 100 ms (601 pts)

Marker	Trace	Type	X Axis	Amplitude
1	(1)	Freq	2.400 00 GHz	112.33 dBμV
2	(1)	Freq	2.400 00 GHz	88.57 dBμV
3	(1)	Freq	2.390 00 GHz	67.69 dBμV

Detector mode: Average

Polarity: Horizontal

Agilent

R T

Mkr3 2.390 00 GHz  
52.76 dBμV

Ref 127 dBμV

#Atten 20 dB



Start 2.310 00 GHz

Stop 2.425 00 GHz

#Res BW 1 MHz

#VBW 10 Hz

Sweep 8.967 s (601 pts)

Marker	Trace	Type	X Axis	Amplitude
1	(1)	Freq	2.415 99 GHz	100.14 dBμV
2	(1)	Freq	2.400 00 GHz	66.03 dBμV
3	(1)	Freq	2.390 00 GHz	52.76 dBμV







### Band Edges (IEEE 802.11n HT 40 MHz mode / CH Low)

Detector mode: Peak

Polarity: Vertical

Agilent

R T

Mkr3 2.390 00 GHz  
70.01 dB $\mu$ V

Ref 127 dB $\mu$ V

#Atten 20 dB

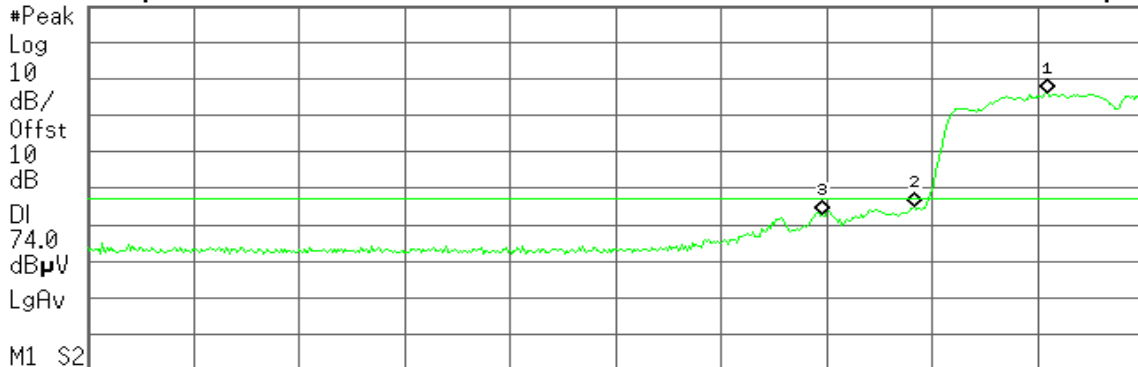

Start 2.310 00 GHz

Stop 2.425 00 GHz

#Res BW 1 MHz

#VBW 1 MHz

#Sweep 100 ms (601 pts)

Marker	Trace	Type	X Axis	Amplitude
1	(1)	Freq	2.414 65 GHz	103.20 dB $\mu$ U
2	(1)	Freq	2.400 00 GHz	71.94 dB $\mu$ U
3	(1)	Freq	2.390 00 GHz	70.01 dB $\mu$ U

Detector mode: Average

Polarity: Vertical

Agilent

R T

Mkr3 2.390 00 GHz  
53.28 dB $\mu$ V

Ref 127 dB $\mu$ V

#Atten 20 dB

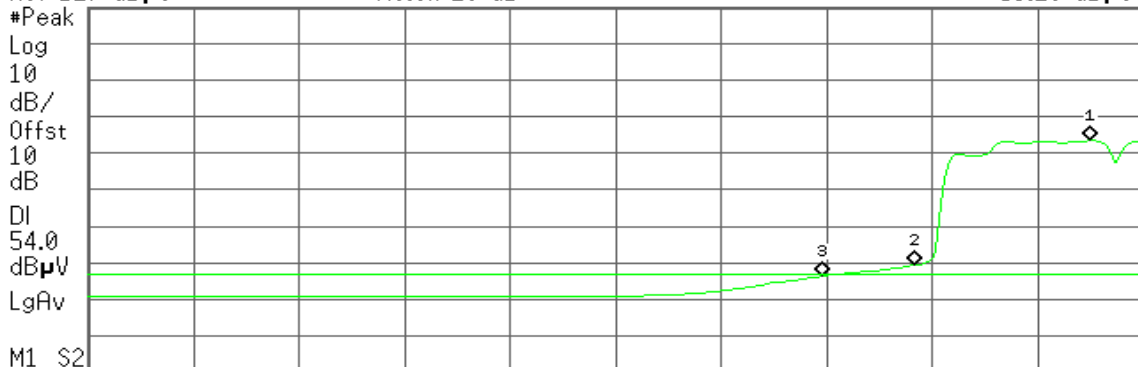

Start 2.310 00 GHz

Stop 2.425 00 GHz

#Res BW 1 MHz

#VBW 10 Hz

Sweep 8.967 s (601 pts)

Marker	Trace	Type	X Axis	Amplitude
1	(1)	Freq	2.419 25 GHz	90.54 dB $\mu$ U
2	(1)	Freq	2.400 00 GHz	56.53 dB $\mu$ U
3	(1)	Freq	2.390 00 GHz	53.28 dB $\mu$ U



Detector mode: Peak

Polarity: Horizontal

Agilent

R T

Mkr4 2.388 58 GHz  
72.31 dBμV

Ref 127 dBμV

#Atten 20 dB

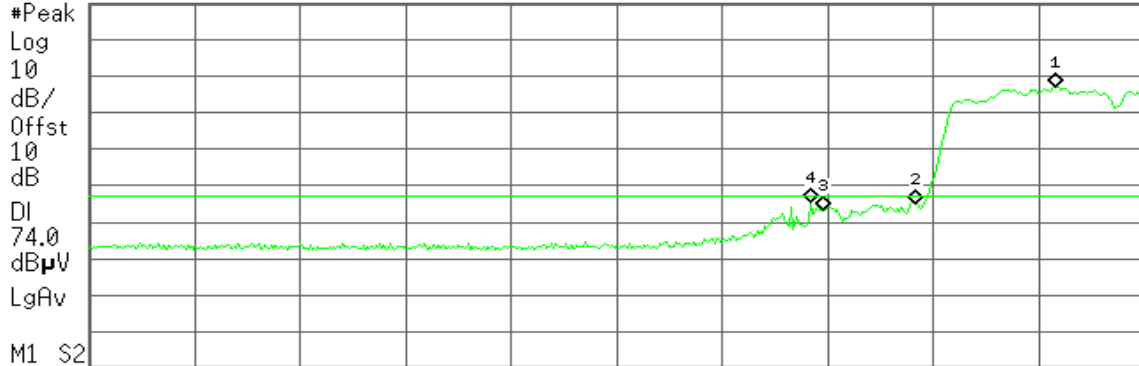

M1 S2  
Start 2.310 00 GHz

Stop 2.425 00 GHz

#Res BW 1 MHz

#VBW 1 MHz

#Sweep 100 ms (601 pts)

Marker	Trace	Type	X Axis	Amplitude
1	(1)	Freq	2.415 42 GHz	104.01 dBμU
2	(1)	Freq	2.400 00 GHz	72.06 dBμU
3	(1)	Freq	2.390 00 GHz	70.10 dBμU
4	(1)	Freq	2.388 58 GHz	72.31 dBμU

Detector mode: Average

Polarity: Horizontal

Agilent

R T

Mkr3 2.390 00 GHz  
52.62 dBμV

Ref 127 dBμV

#Atten 20 dB

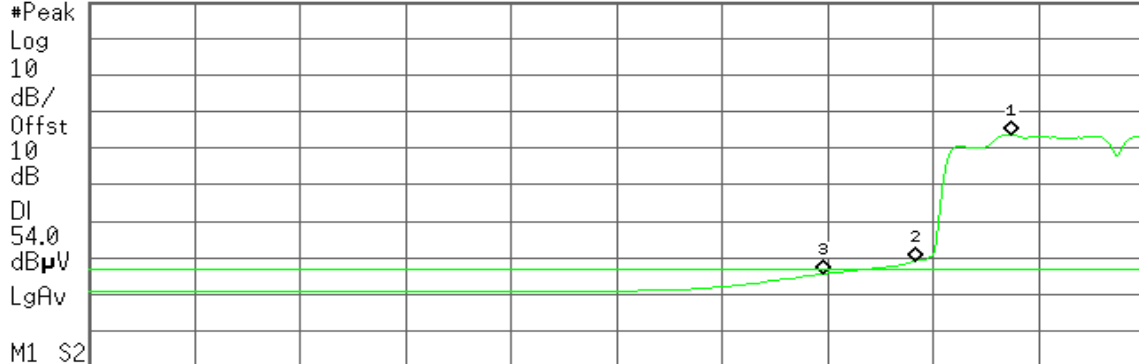

M1 S2  
Start 2.310 00 GHz

Stop 2.425 00 GHz

#Res BW 1 MHz

#VBW 10 Hz

#Sweep 8.967 s (601 pts)

Marker	Trace	Type	X Axis	Amplitude
1	(1)	Freq	2.410 43 GHz	90.58 dBμU
2	(1)	Freq	2.400 00 GHz	56.19 dBμU
3	(1)	Freq	2.390 00 GHz	52.62 dBμU



Band Edges (IEEE 802.11n HT 40 MHz mode / CH High)

Detector mode: Peak

Polarity: Vertical

Agilent

R T

Mkr2 2.483 50 GHz  
67.30 dBµV

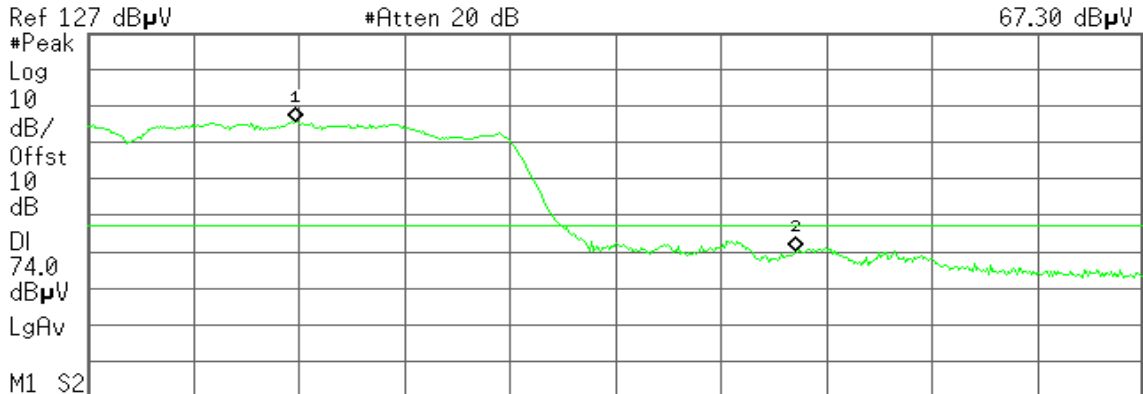

Start 2.450 00 GHz Stop 2.500 00 GHz  
#Res BW 1 MHz #VBW 1 MHz #Sweep 100 ms (601 pts)

Marker	Trace	Type	X Axis	Amplitude
1	(1)	Freq	2.459 83 GHz	102.58 dBµU
2	(1)	Freq	2.483 50 GHz	67.30 dBµU

Detector mode: Average

Polarity: Vertical

Agilent

R T

Mkr2 2.483 50 GHz  
52.39 dBµV

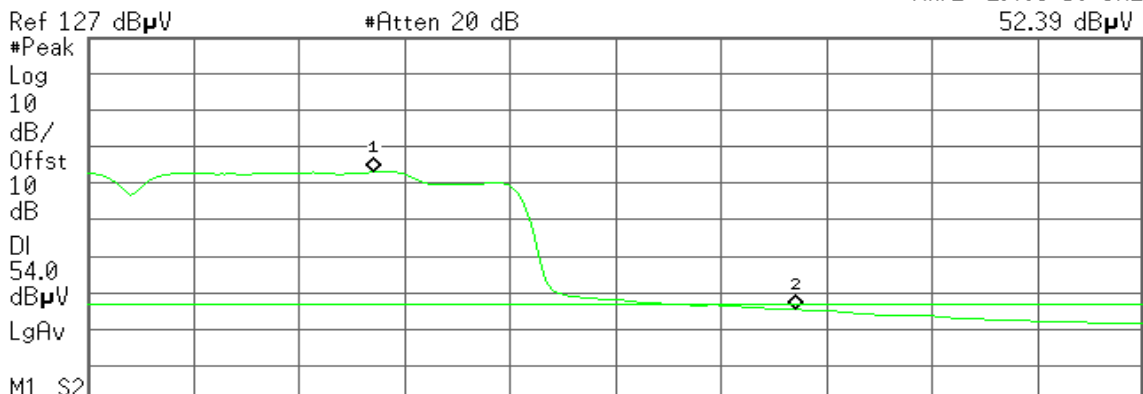

Start 2.450 00 GHz Stop 2.500 00 GHz  
#Res BW 1 MHz #VBW 10 Hz Sweep 3.899 s (601 pts)

Marker	Trace	Type	X Axis	Amplitude
1	(1)	Freq	2.463 50 GHz	90.01 dBµU
2	(1)	Freq	2.483 50 GHz	52.39 dBµU





Detector mode: Peak

Polarity: Horizontal

Agilent

R T

Mkr2 2.483 50 GHz  
71.35 dBμV

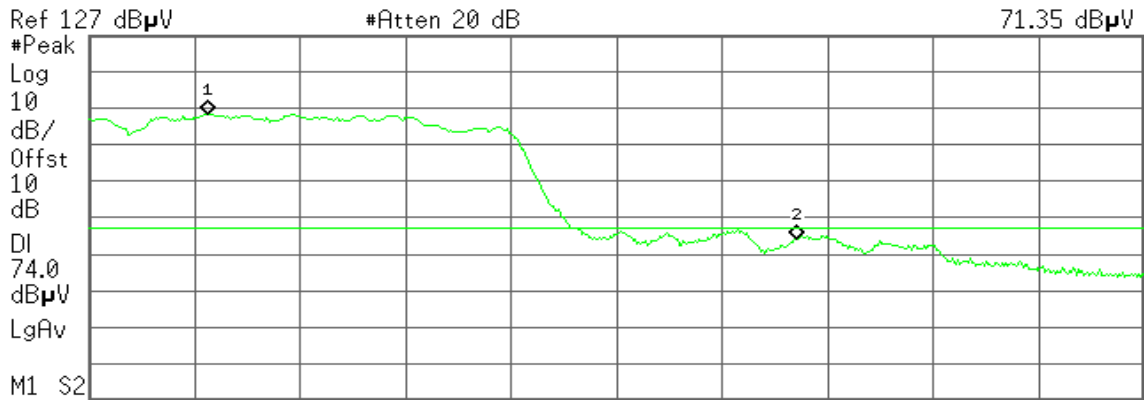

M1 S2  
Start 2.450 00 GHz Stop 2.500 00 GHz  
#Res BW 1 MHz #VBW 1 MHz #Sweep 100 ms (601 pts)

Marker	Trace	Type	X Axis	Amplitude
1	(1)	Freq	2.455 67 GHz	105.39 dBμU
2	(1)	Freq	2.483 50 GHz	71.35 dBμU

Detector mode: Average

Polarity: Horizontal

Agilent

R T

Mkr2 2.483 50 GHz  
53.27 dBμV

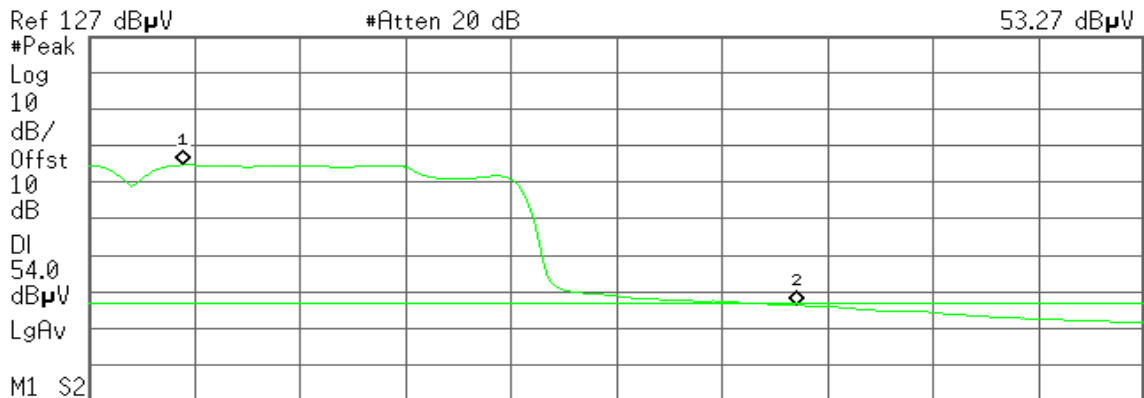

M1 S2  
Start 2.450 00 GHz Stop 2.500 00 GHz  
#Res BW 1 MHz #VBW 10 Hz Sweep 3.899 s (601 pts)

Marker	Trace	Type	X Axis	Amplitude
1	(1)	Freq	2.454 42 GHz	91.80 dBμU
2	(1)	Freq	2.483 50 GHz	53.27 dBμU



### Conducted Band Edges (IEEE 802.11b mode / CH High)

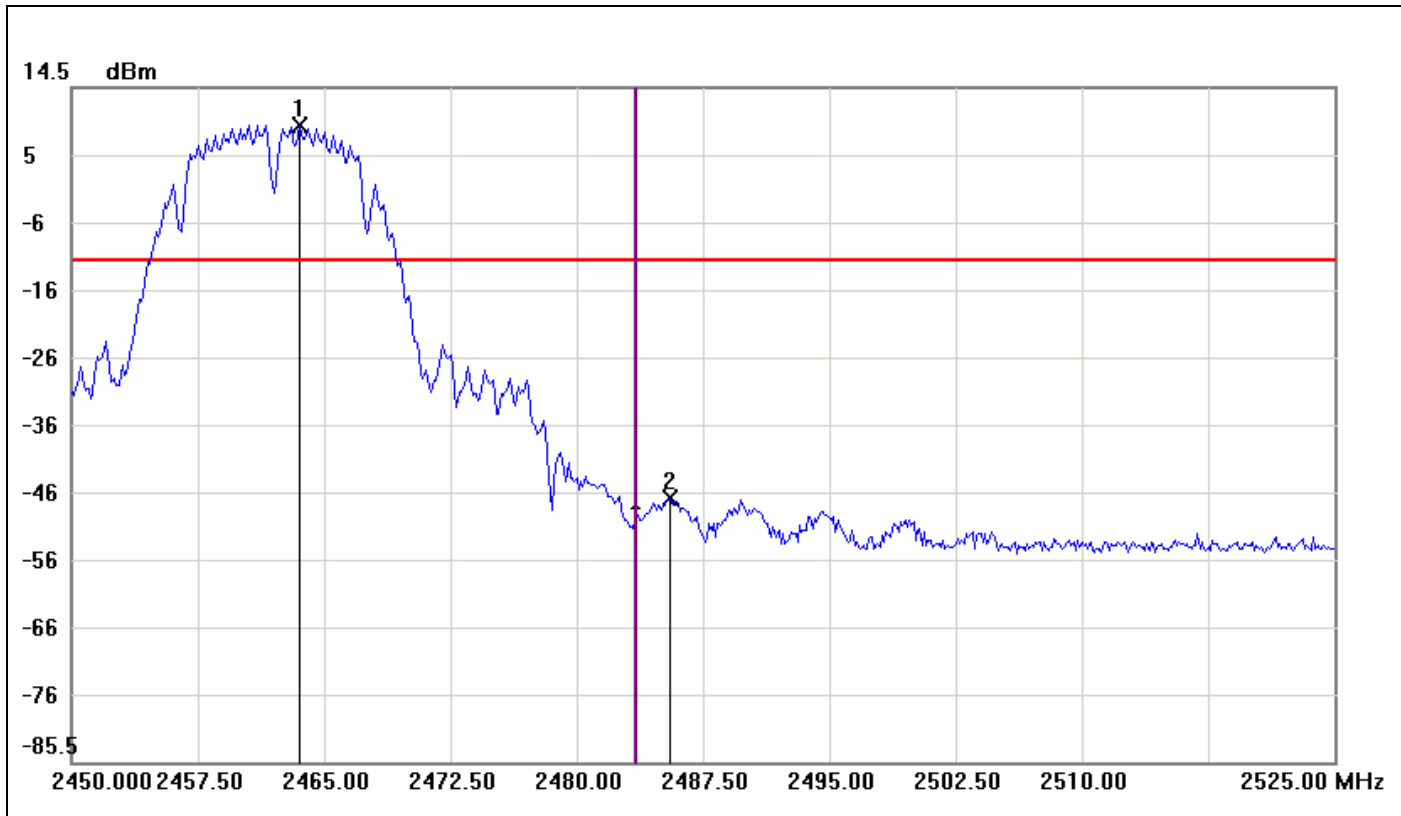

No.	Frequency(MHz)	Result(dBm)	Limit(dBm)	Margin(dBm)
1	2463.5000	8.99	-11.01	20.00
2	2485.5000	-46.48	-11.01	-35.47



### Conducted Band Edges (IEEE 802.11g mode / CH Low)

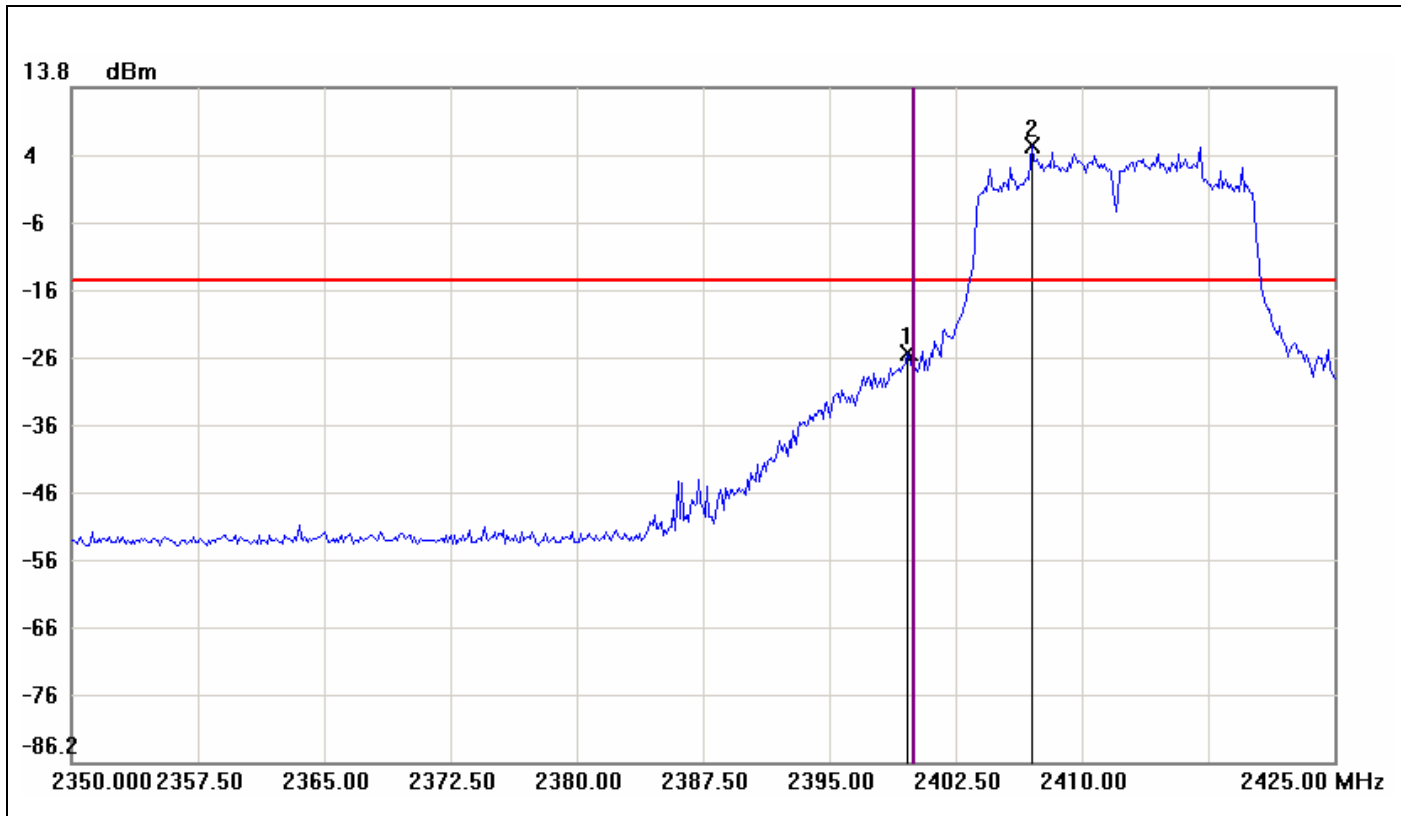

No.	Frequency(MHz)	Result(dBm)	Limit(dBm)	Margin(dBm)
1	2399.6250	-25.72	-14.97	-10.75
2	2407.0000	5.03	-14.97	20.00



### Conducted Band Edges (IEEE 802.11g mode / CH High)

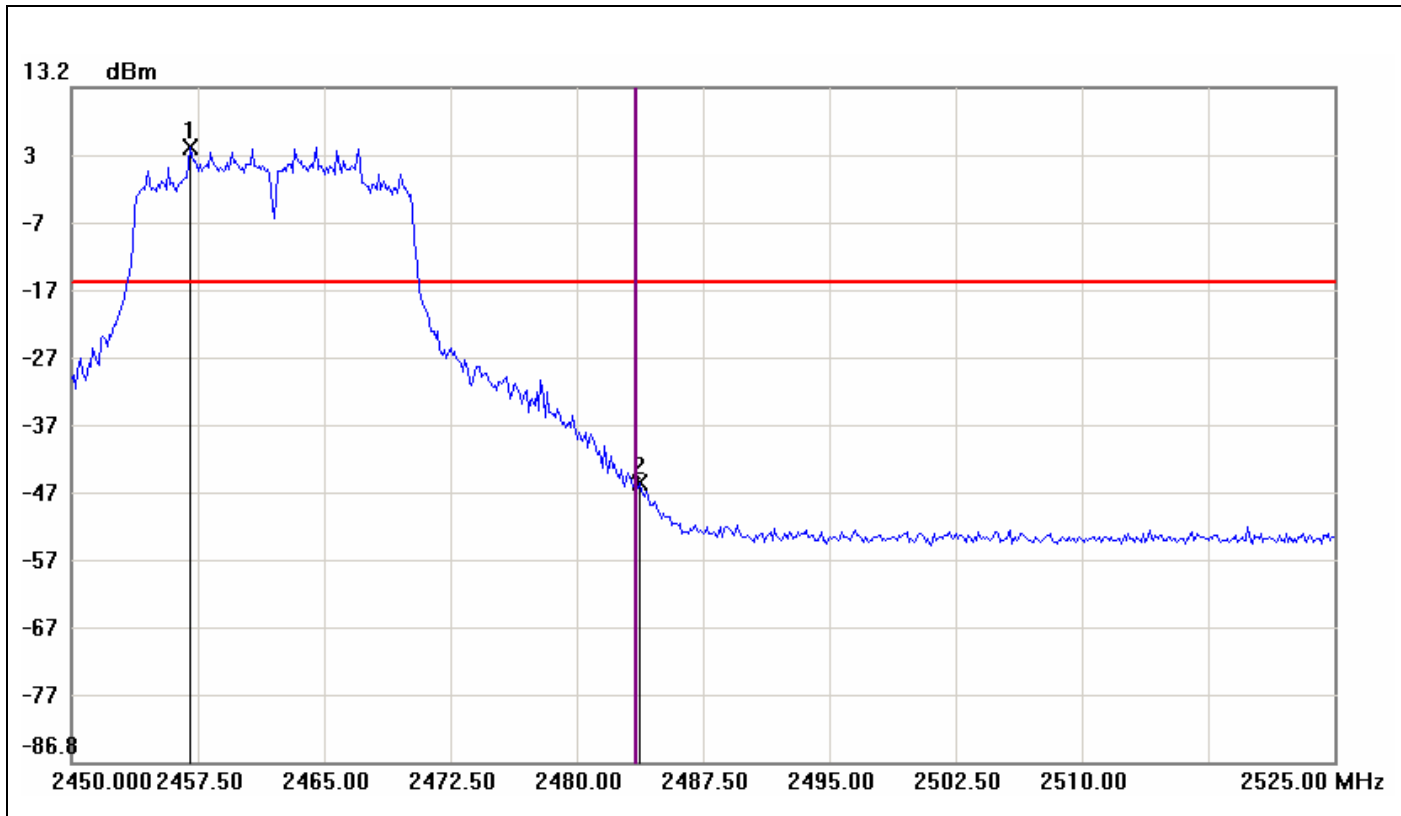

No.	Frequency(MHz)	Result(dBm)	Limit(dBm)	Margin(dBm)
1	2457.0000	4.39	-15.61	20.00
2	2483.7500	-45.54	-15.61	-29.93



Conducted Band Edges (IEEE 802.11n HT20 MHz mode / CH Low)

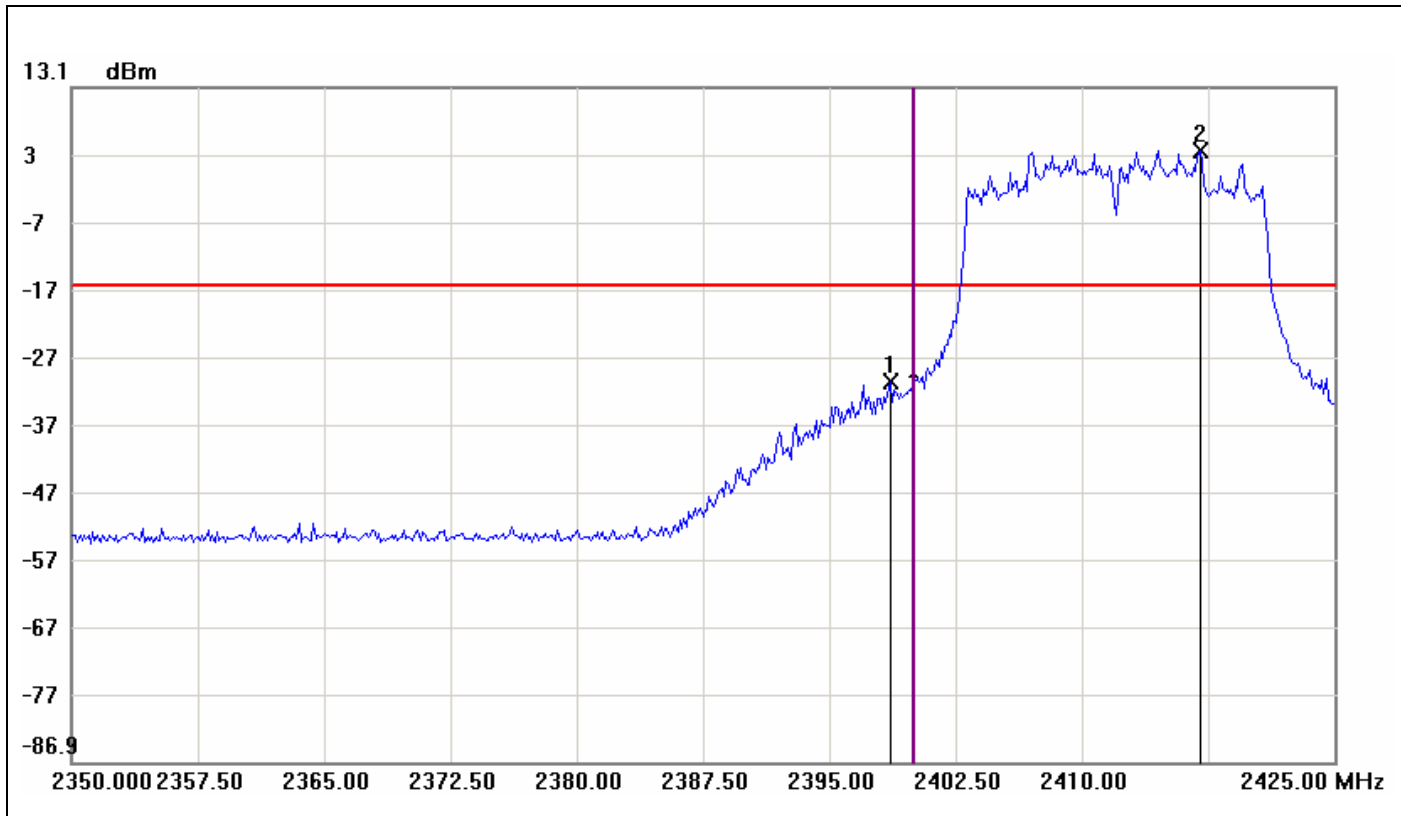

No.	Frequency(MHz)	Result(dBm)	Limit(dBm)	Margin(dBm)
1	2398.6250	-30.43	-16.34	-14.09
2	2417.0000	3.66	-16.34	20.00



**Conducted Band Edges (IEEE 802.11n HT20 MHz mode / CH High)**

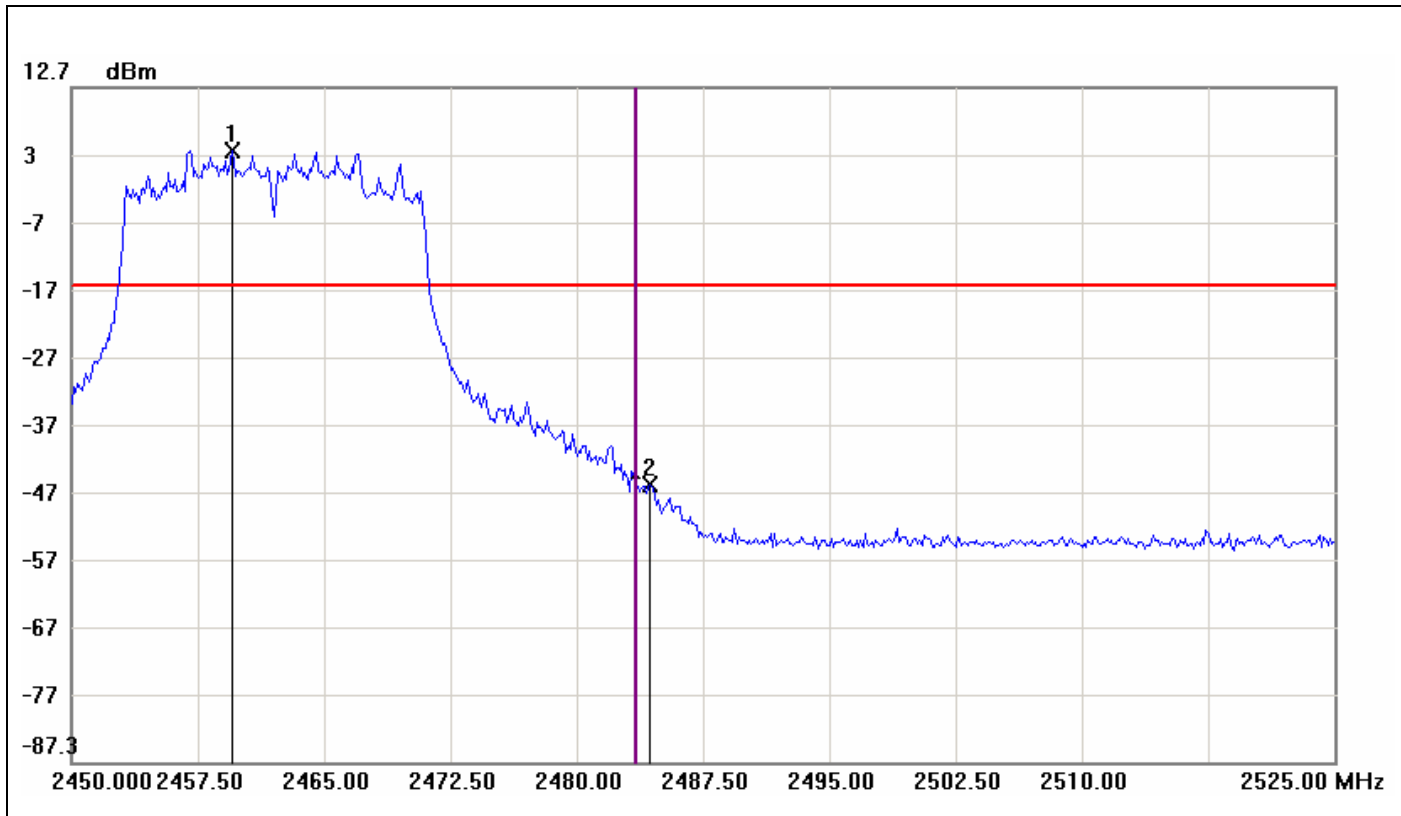

No.	Frequency(MHz)	Result(dBm)	Limit(dBm)	Margin(dBm)
1	2459.5000	3.38	-16.62	20.00
2	2484.3750	-46.15	-16.62	-29.53



**Conducted Band Edges (IEEE 802.11n HT40 MHz mode / CH Low)**

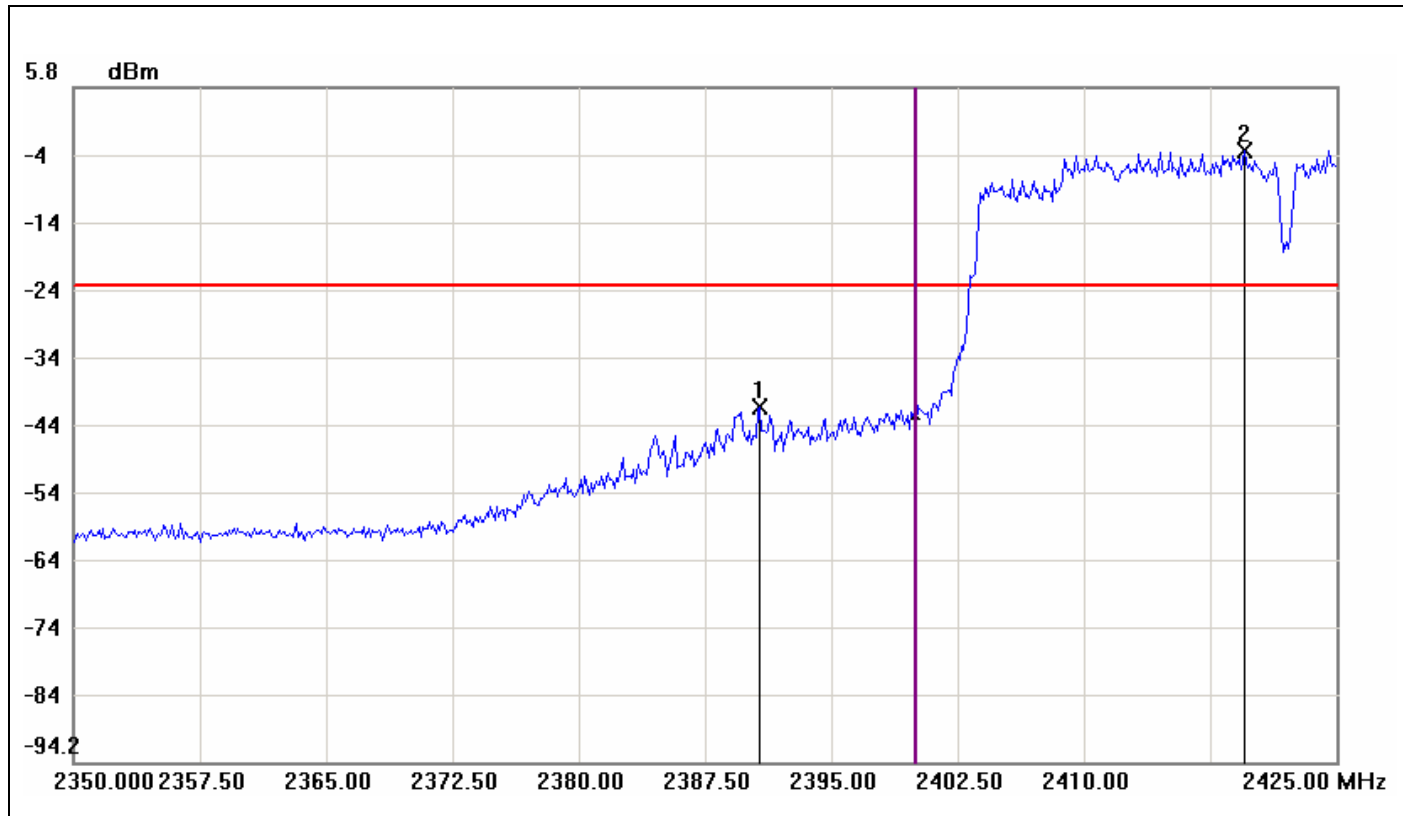

No.	Frequency(MHz)	Result(dBm)	Limit(dBm)	Margin(dBm)
1	2390.7500	-41.63	-23.50	-18.13
2	2419.5000	-3.50	-23.50	20.00



Conducted Band Edges (IEEE 802.11n HT40 MHz mode / CH High)

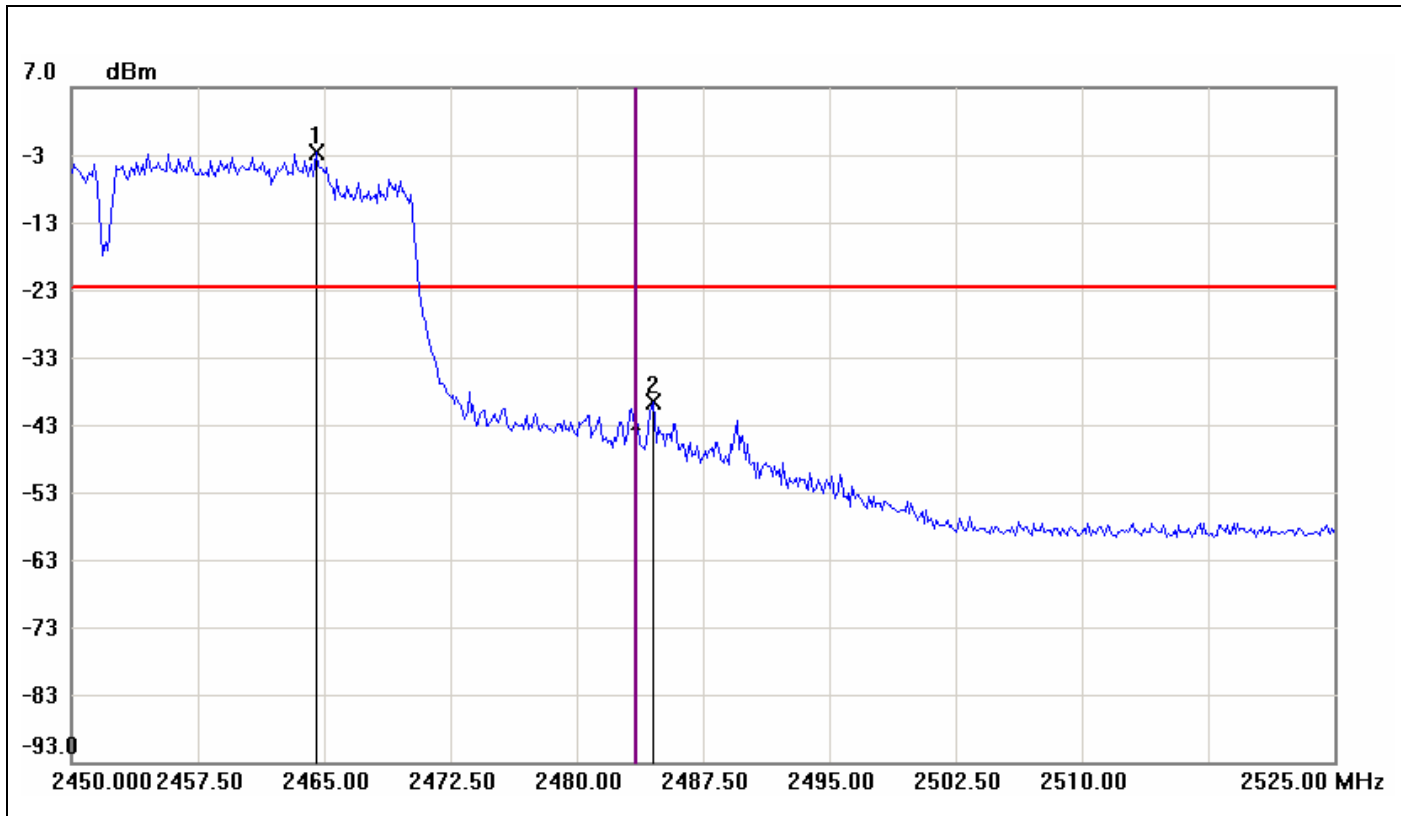

No.	Frequency(MHz)	Result(dBm)	Limit(dBm)	Margin(dBm)
1	2464.5000	-2.68	-22.68	20.00
2	2484.5000	-39.62	-22.68	-16.94





## 7.6 PEAK POWER SPECTRAL DENSITY

### LIMIT

1. According to §15.247(e), for digitally modulated systems, the power spectral density conducted from the intentional radiator to the antenna shall not be greater than 8 dBm in any 3 kHz band during any time interval of continuous transmission.
2. According to §15.247(f), the digital modulation operation of the hybrid system, with the frequency hopping turned off, shall comply with the power density requirements of paragraph (d) of this section.

### Test Configuration

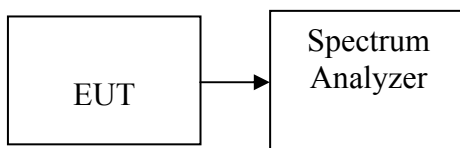

### TEST PROCEDURE

The transmitter output is connected to a spectrum analyzer. Set the RBW = 100 kHz, VBW = 300 kHz, span 5-30% greater than EBW, Detector = peak, Trace mode = max hold, Sweep = auto couple. Scale the observed power level to an equivalent value in 3 kHz by adjusting (reducing) the measured power by a bandwidth correction factor (BWCF) where  $BWCF = 10\log(3\text{ kHz}/100\text{ kHz} = -15.2\text{ dB})$ . Record the maximum reading. Repeat the above procedure until the measurements for all frequencies are completed.

### TEST RESULTS

*No non-compliance noted*

**Test Data****Test mode: IEEE 802.11b mode**

Channel	Frequency (MHz)	100kHz PPSD (dBm)	3kHz PPSD (dBm)	Limit (dBm)	Result
Low	2412	-6.88	-22.08	8	PASS
Mid	2437	-6.45	-21.65		PASS
High	2462	-6.68	-21.88		PASS

**Test mode: IEEE 802.11g mode**

Channel	Frequency (MHz)	100kHz PPSD (dBm)	3kHz PPSD (dBm)	Limit (dBm)	Result
Low	2412	-10.13	-25.33	8	PASS
Mid	2437	-6.94	-22.14		PASS
High	2462	-10.88	-26.08		PASS

**Test mode: IEEE 802.11n HT 20 MHz mode**

Channel	Frequency (MHz)	Main Antenna PPSD	Aux Antenna PPSD	100kHz PPSD (dBm)	3kHz PPSD (dBm)	Limit (dBm)	Result
Low	2412	-11.28	-14.40	-9.56	-24.76	4.89	PASS
Mid	2437	-10.72	-12.59	-8.54	-23.74		PASS
High	2462	-12.14	-16.18	-10.70	-25.9		PASS

**Test mode: IEEE 802.11n HT 40 MHz mode**

Channel	Frequency (MHz)	Main Antenna PPSD	Aux Antenna PPSD	100kHz PPSD (dBm)	3kHz PPSD (dBm)	Limit (dBm)	Result
Low	2422	-18.02	-21.95	-16.54	-31.74	4.89	PASS
Mid	2437	-9.51	-17.84	-8.91	-24.11		PASS
High	2452	-17.64	-22.83	-16.49	-31.69		PASS

**Remark:** Total Output Power (w) = Main Antenna( $10^{(Output\ Power / 10) / 1000}$ ) + Aux Antenna ( $10^{(Output\ Power / 10) / 1000}$ )



**Test mode: IEEE 802.11a mode**

Channel	Frequency (MHz)	100kHz (dBm)	3kHz (dBm)	Limit (dBm)	Result
Low	5745	-12.36	-27.56	8	PASS
Mid	5785	-13.81	-29.01		PASS
High	5825	-13.47	-28.67		PASS

**Test mode: IEEE 802.11n HT 20 MHz mode**

Channel	Frequency (MHz)	100kHz (dBm)	3kHz (dBm)	Limit (dBm)	Result
Low	5745	-14.70	-29.90	8	PASS
Mid	5785	-15.03	-30.23		PASS
High	5825	-14.79	-29.99		PASS

**Test mode: IEEE 802.11n HT 40 MHz mode**

Channel	Frequency (MHz)	100kHz (dBm)	3kHz (dBm)	Limit (dBm)	Result
Low	5755	-18.92	-34.12	8	PASS
High	5795	-19.23	-34.43		PASS



**Test Plot**

IEEE 802.11b mode

PPSD (CH Low)

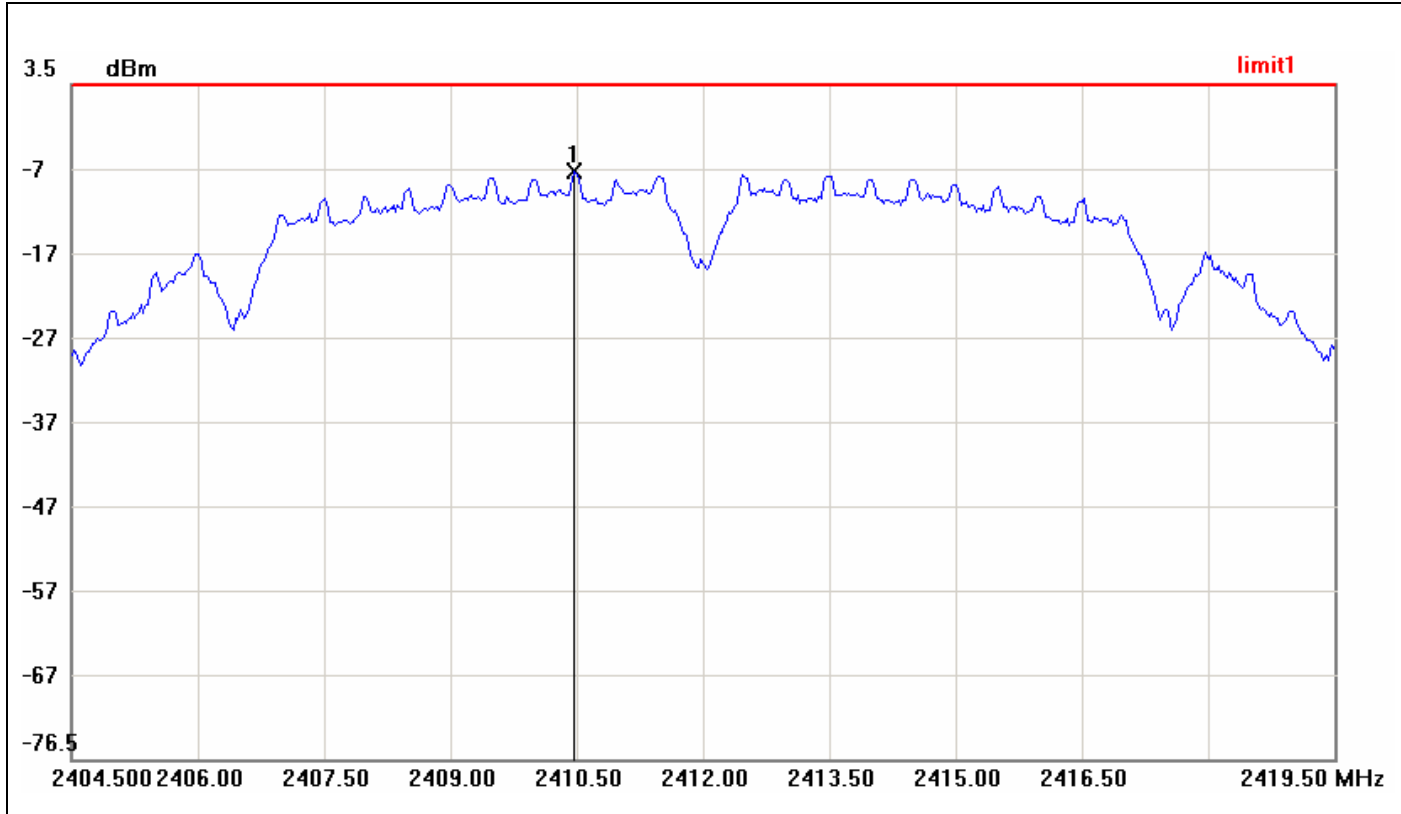

No.	Frequency(MHz)	Result(dBm)	Limit(dBm)	Margin(dBm)
1	2410.4750	-6.88	8.00	-14.88



PPSD (CH Mid)

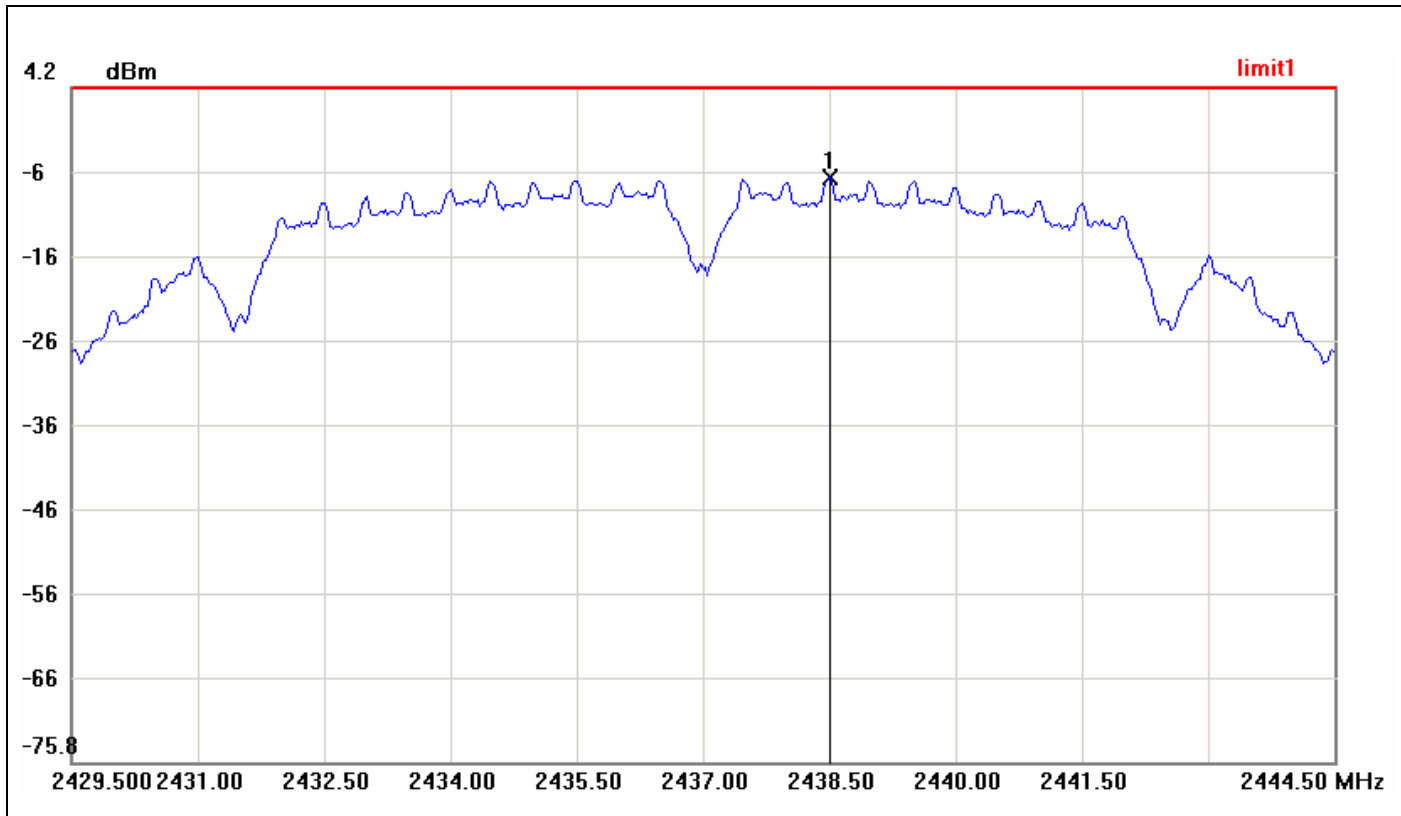

No.	Frequency(MHz)	Result(dBm)	Limit(dBm)	Margin(dBm)
1	2438.5000	-6.45	8.00	-14.45



PPSD (CH High)

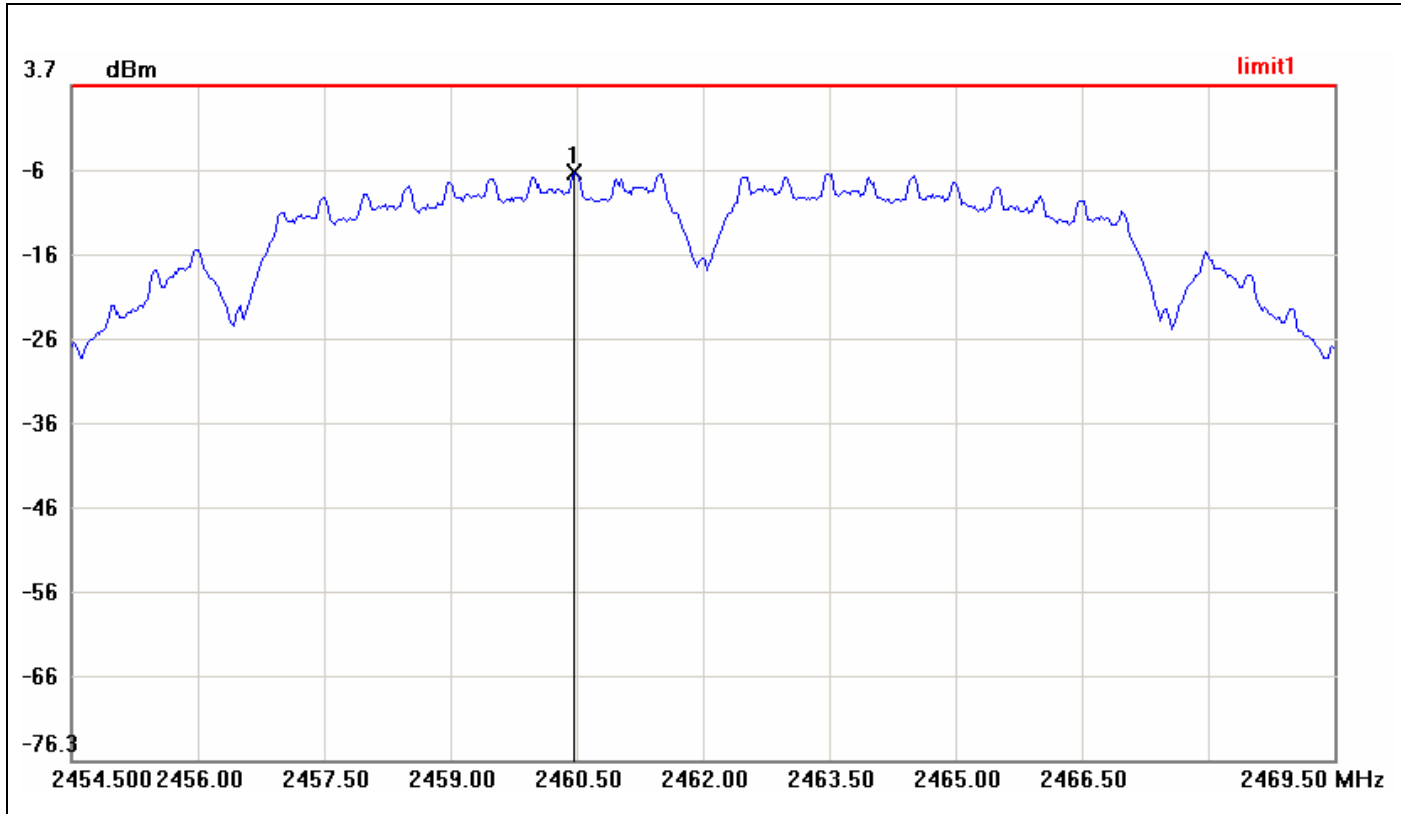

No.	Frequency(MHz)	Result(dBm)	Limit(dBm)	Margin(dBm)
1	2460.4750	-6.68	8.00	-14.68



IEEE 802.11g mode

PPSD (CH Low)

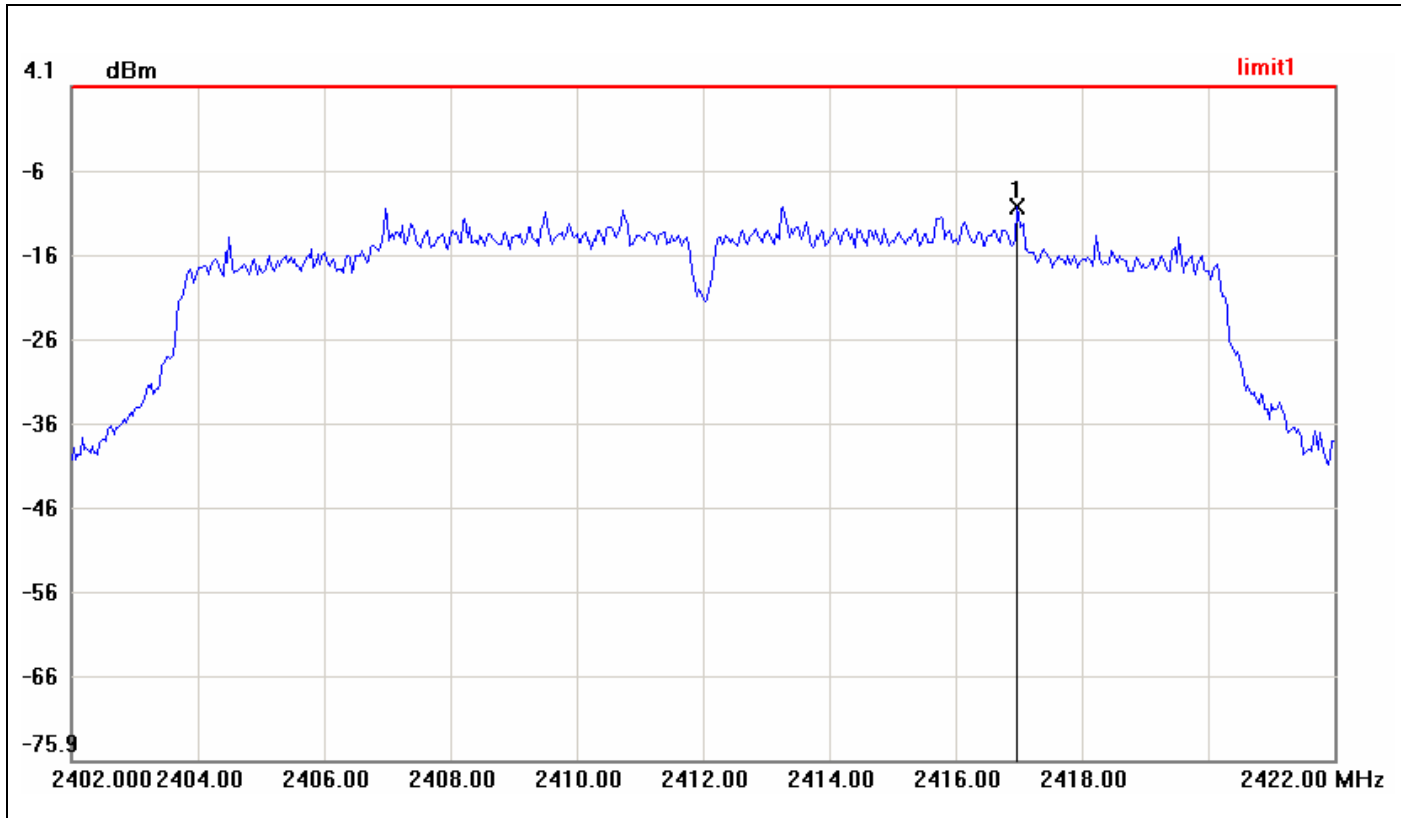

No.	Frequency(MHz)	Result(dBm)	Limit(dBm)	Margin(dBm)
1	2416.9667	-10.13	8.00	-18.13



PPSD (CH Mid)

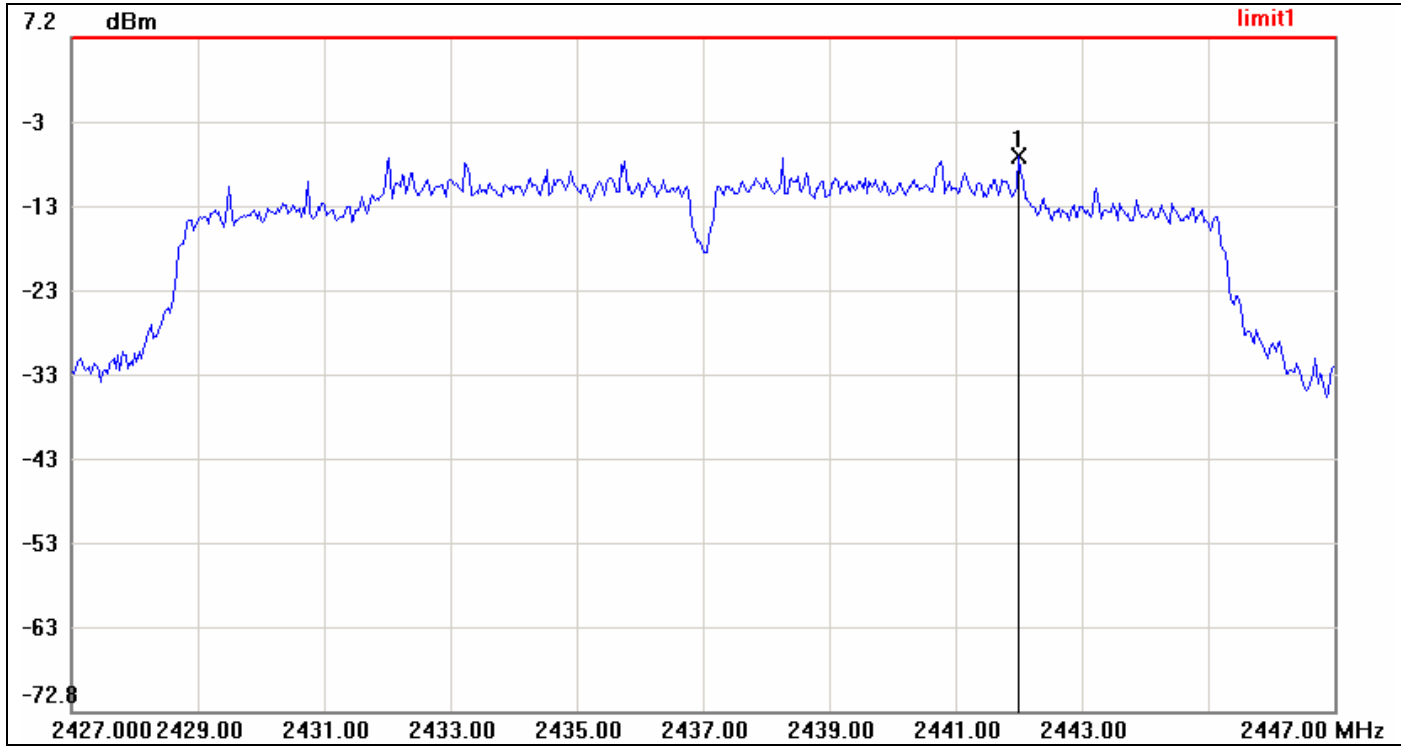

No.	Frequency(MHz)	Result(dBm)	Limit(dBm)	Margin(dBm)
1	2437.0000	-6.94	8.00	-14.94





PPSD (CH High)

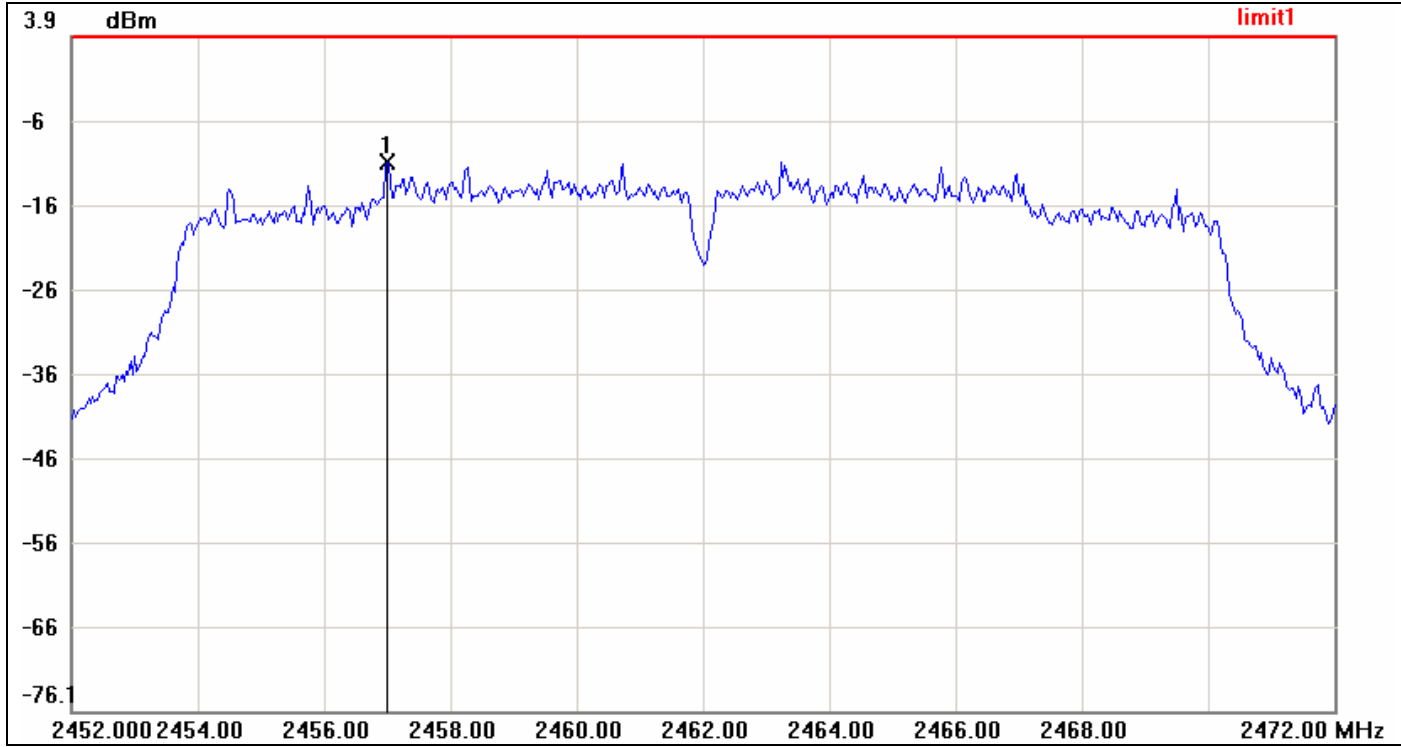

No.	Frequency(MHz)	Result(dBm)	Limit(dBm)	Margin(dBm)
1	2457.0000	-10.88	8.00	-18.88



IEEE 802.11n HT 20 MHz mode / Main Antenna

PPSD (CH Low)

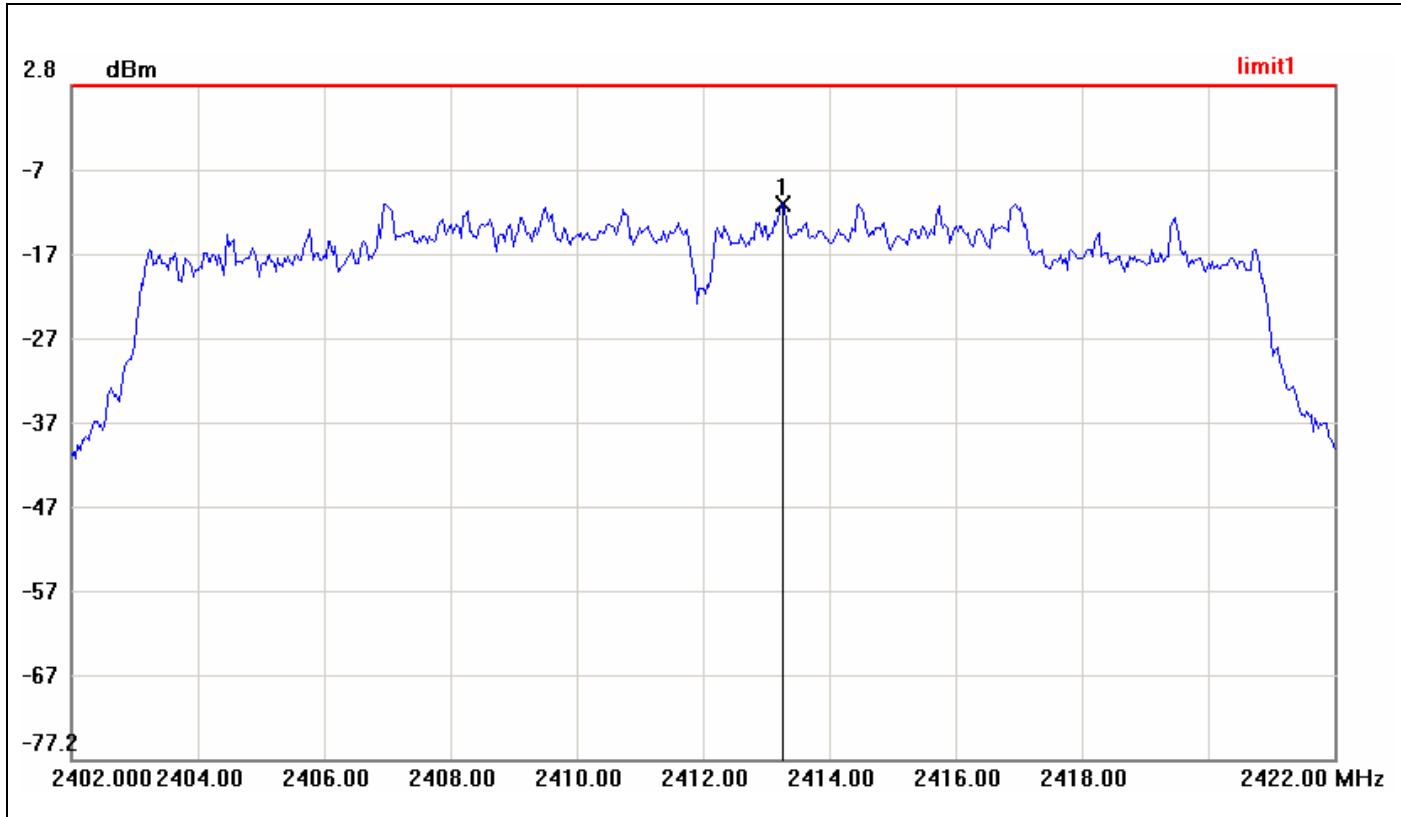

No.	Frequency(MHz)	Result(dBm)	Limit(dBm)	Margin(dBm)
1	2413.2667	-11.28	8.00	-19.28



PPSD (CH Mid)

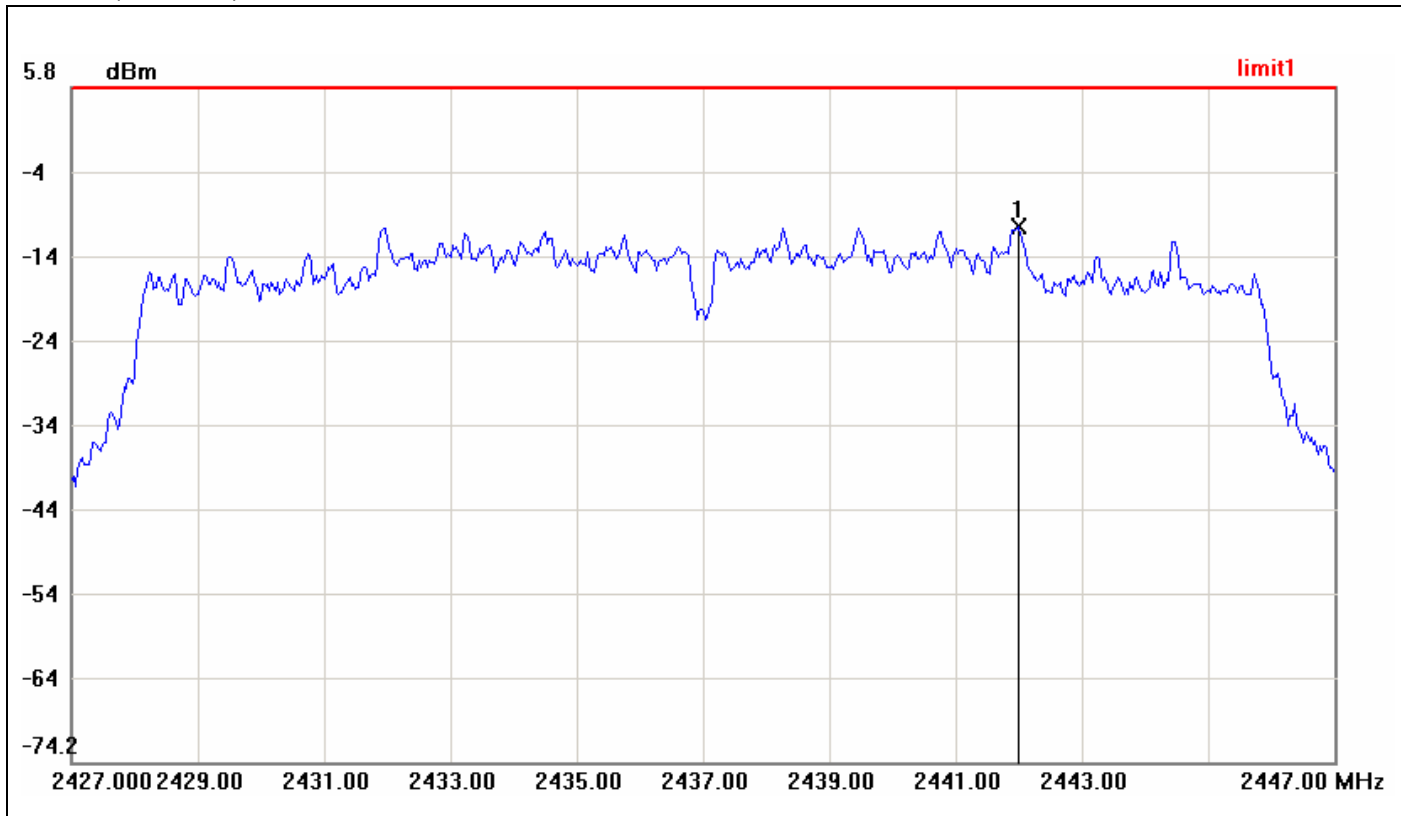

No.	Frequency(MHz)	Result(dBm)	Limit(dBm)	Margin(dBm)
1	2437.0000	-10.72	8.00	-18.72



PPSD (CH High)

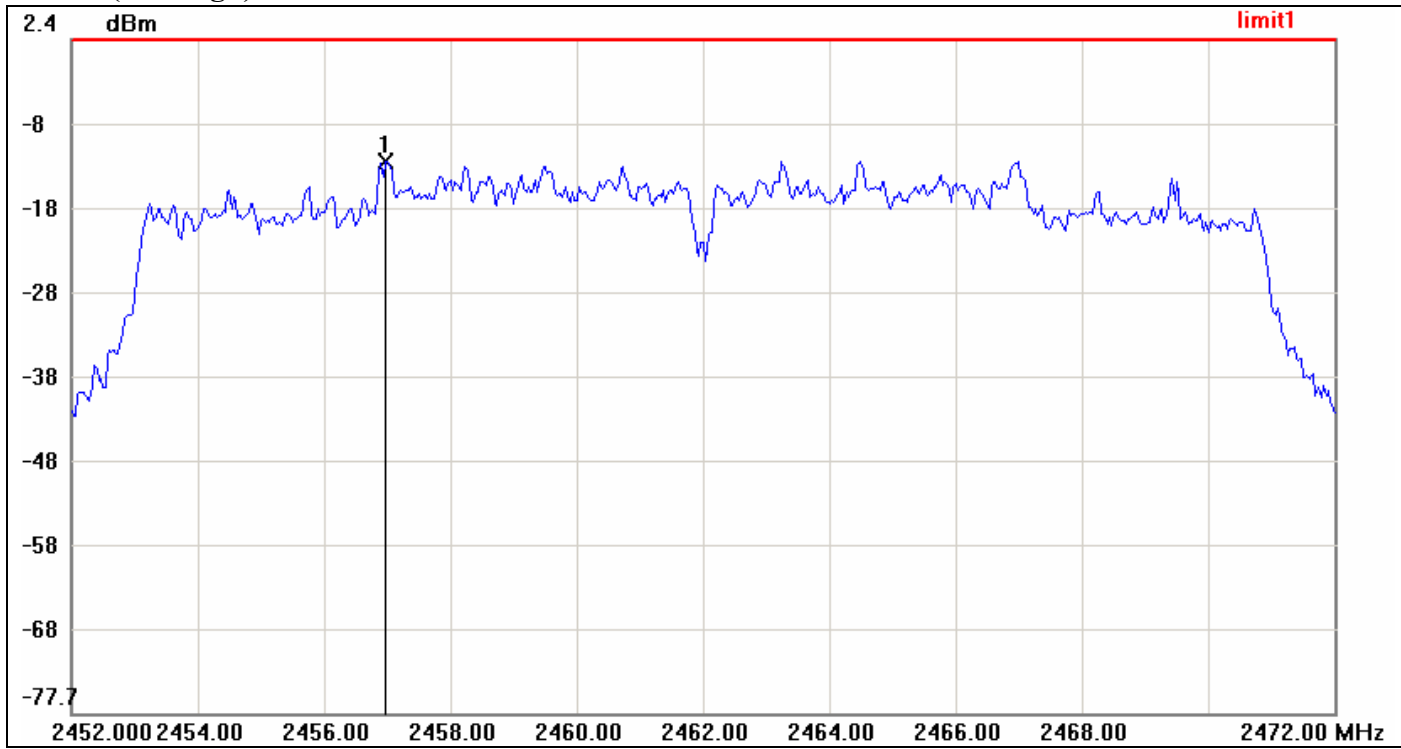

No.	Frequency(MHz)	Result(dBm)	Limit(dBm)	Margin(dBm)
1	2456.9667	-12.14	8.00	-20.14



IEEE 802.11n HT 20 MHz mode / Aux Antenna

PPSD (CH Low)

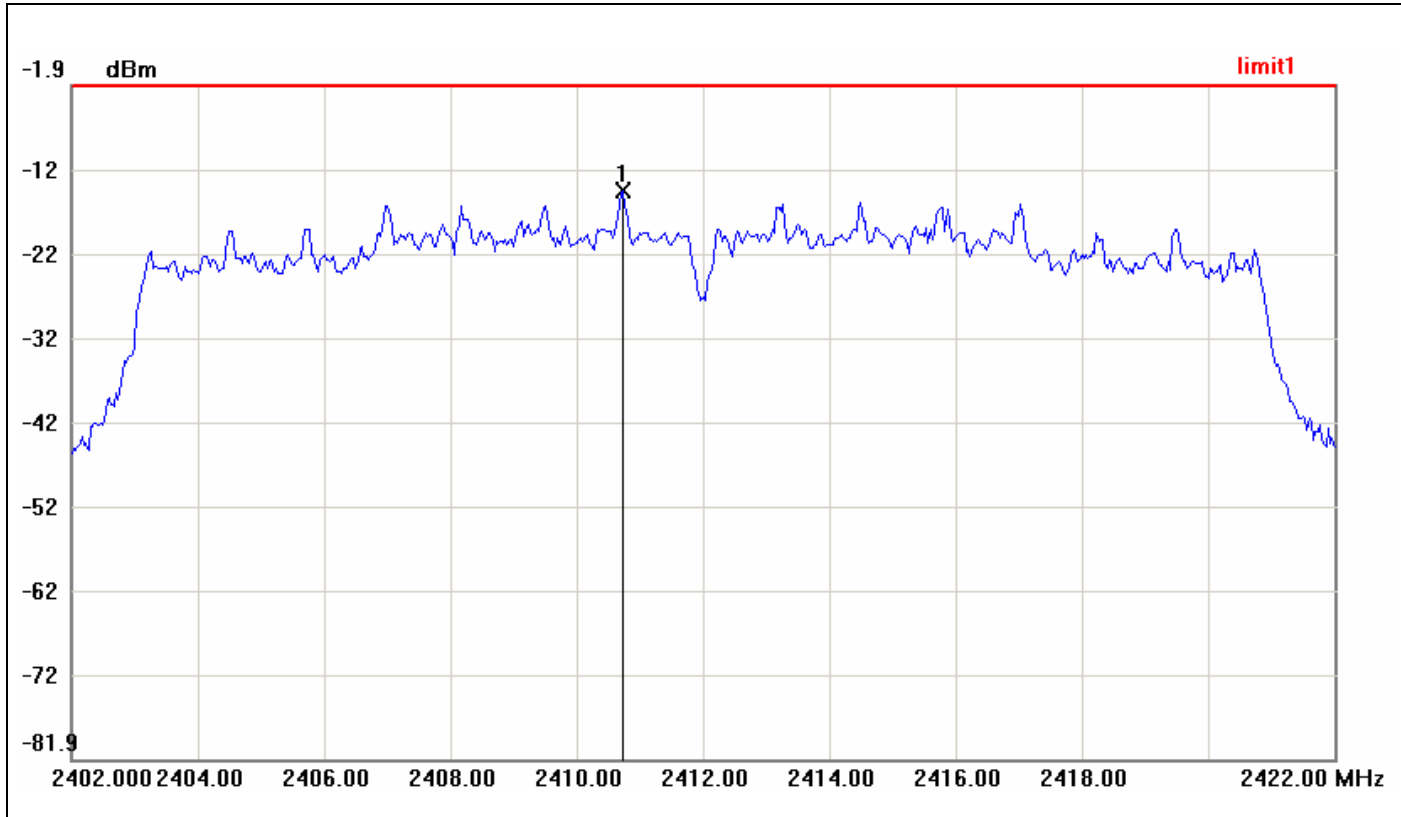

No.	Frequency(MHz)	Result(dBm)	Limit(dBm)	Margin(dBm)
1	2410.7333	-14.40	8.00	-22.40



PPSD (CH Mid)

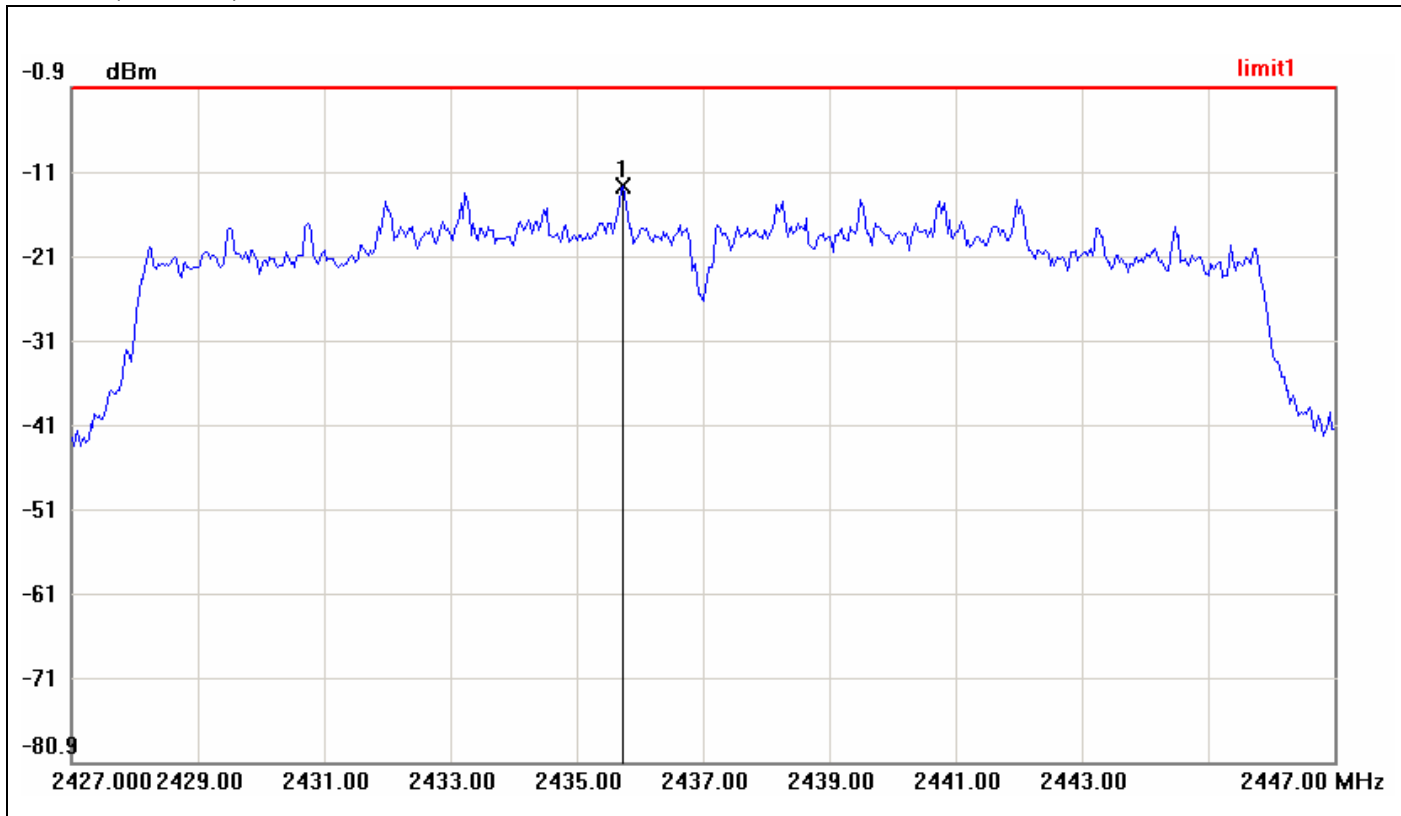

No.	Frequency(MHz)	Result(dBm)	Limit(dBm)	Margin(dBm)
1	2435.7333	-12.59	8.00	-20.59



PPSD (CH High)

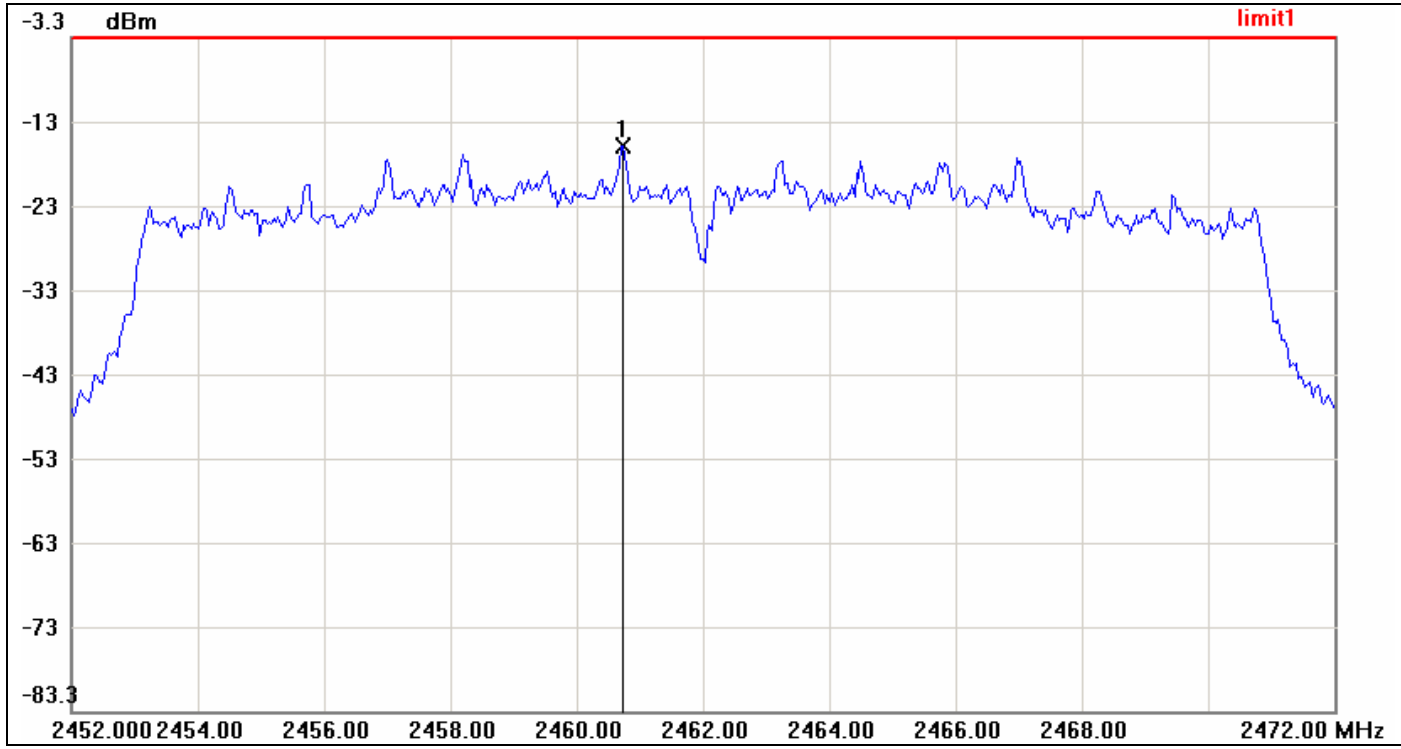

No.	Frequency(MHz)	Result(dBm)	Limit(dBm)	Margin(dBm)
1	2460.7333	-16.18	8.00	-24.18



IEEE 802.11n HT 40 MHz mode / Main Antenna

PPSD (CH Low)

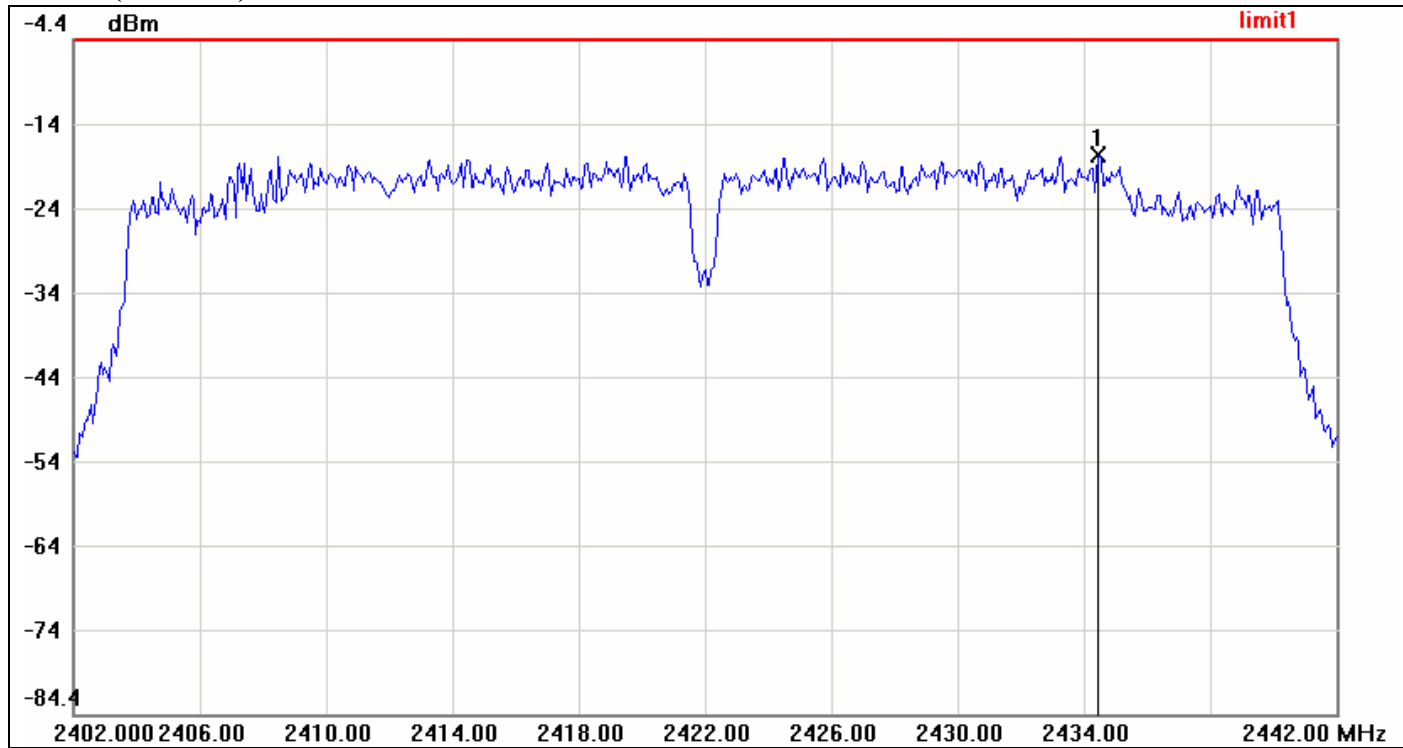

No.	Frequency(MHz)	Result(dBm)	Limit(dBm)	Margin(dBm)
1	2434.4667	-18.02	8.00	-26.02





PPSD (CH Mid)

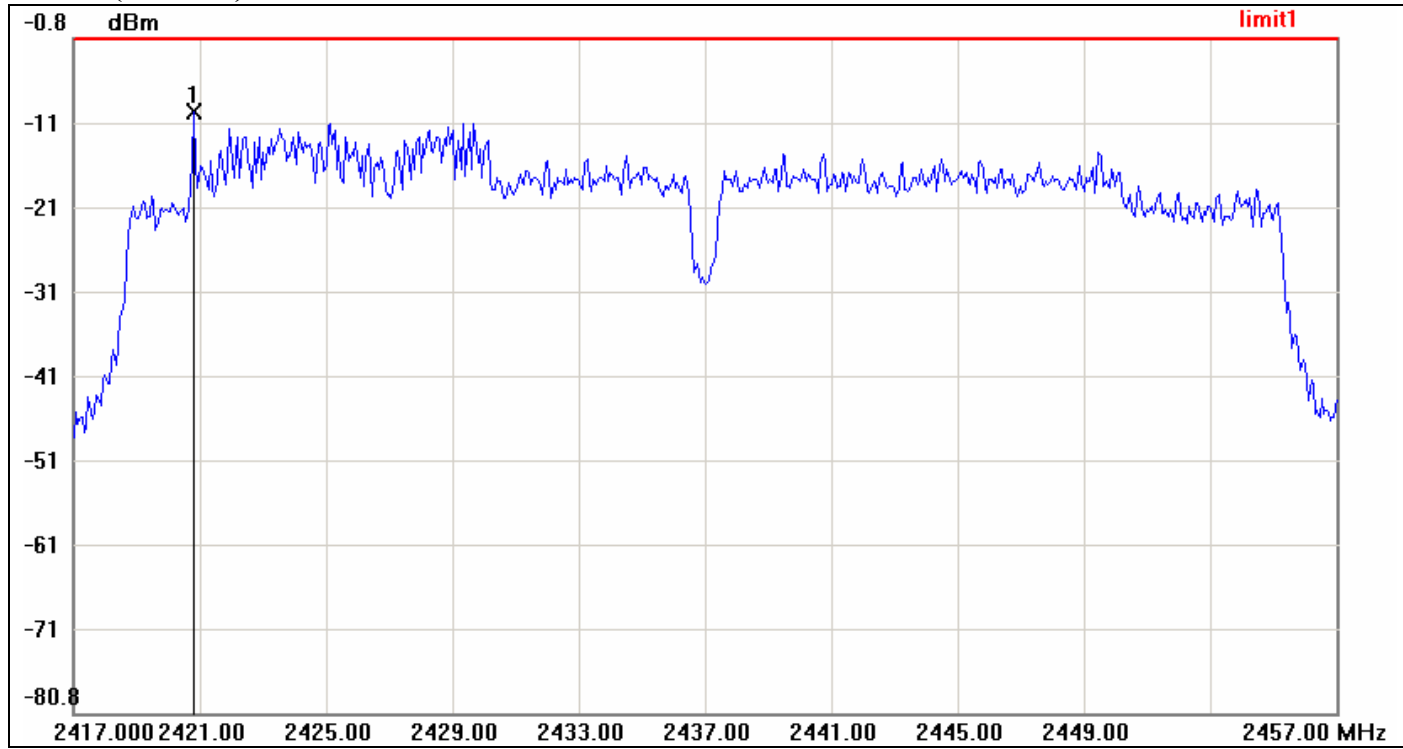

No.	Frequency(MHz)	Result(dBm)	Limit(dBm)	Margin(dBm)
1	2420.8000	-9.51	8.00	-17.51



PPSD (CH High)

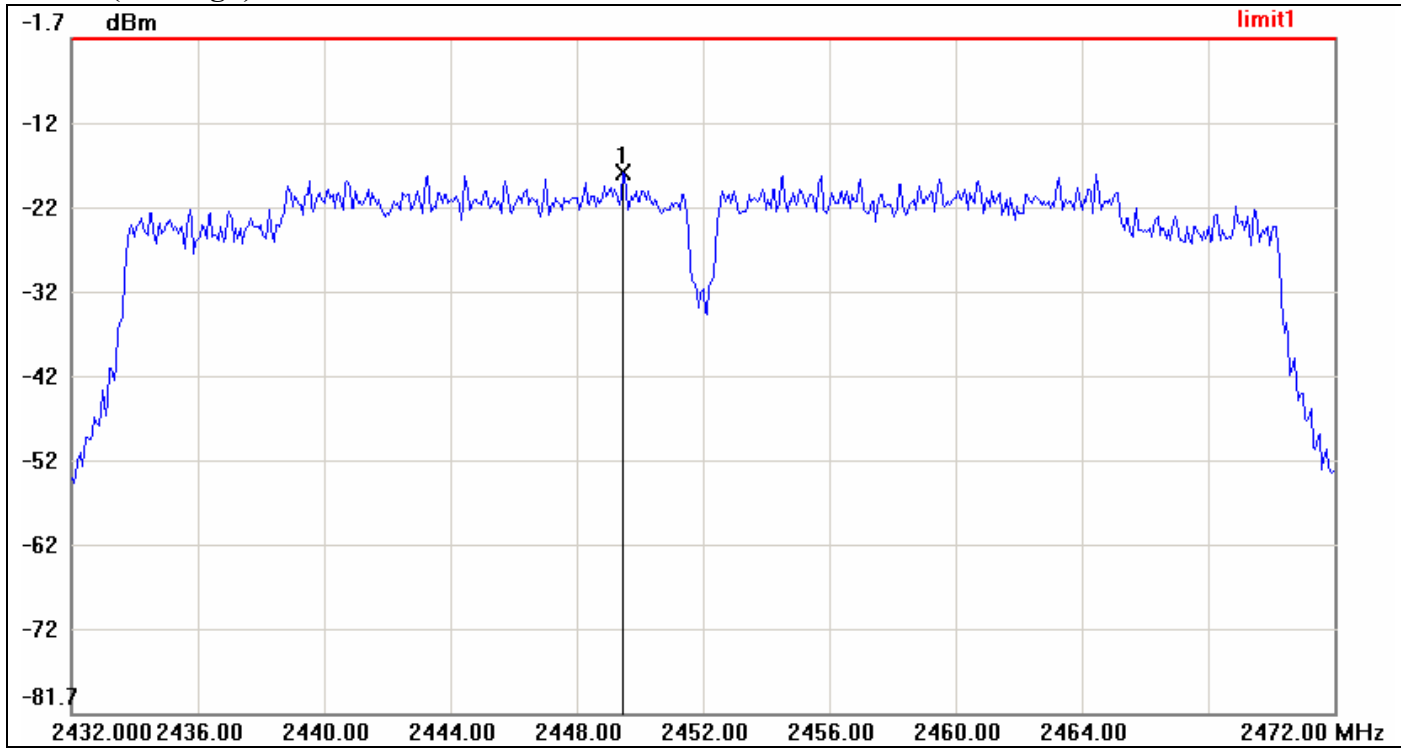

No.	Frequency(MHz)	Result(dBm)	Limit(dBm)	Margin(dBm)
1	2449.4667	-17.64	8.00	-25.64



IEEE 802.11n HT 40 MHz mode / Aux Antenna

PPSD (CH Low)

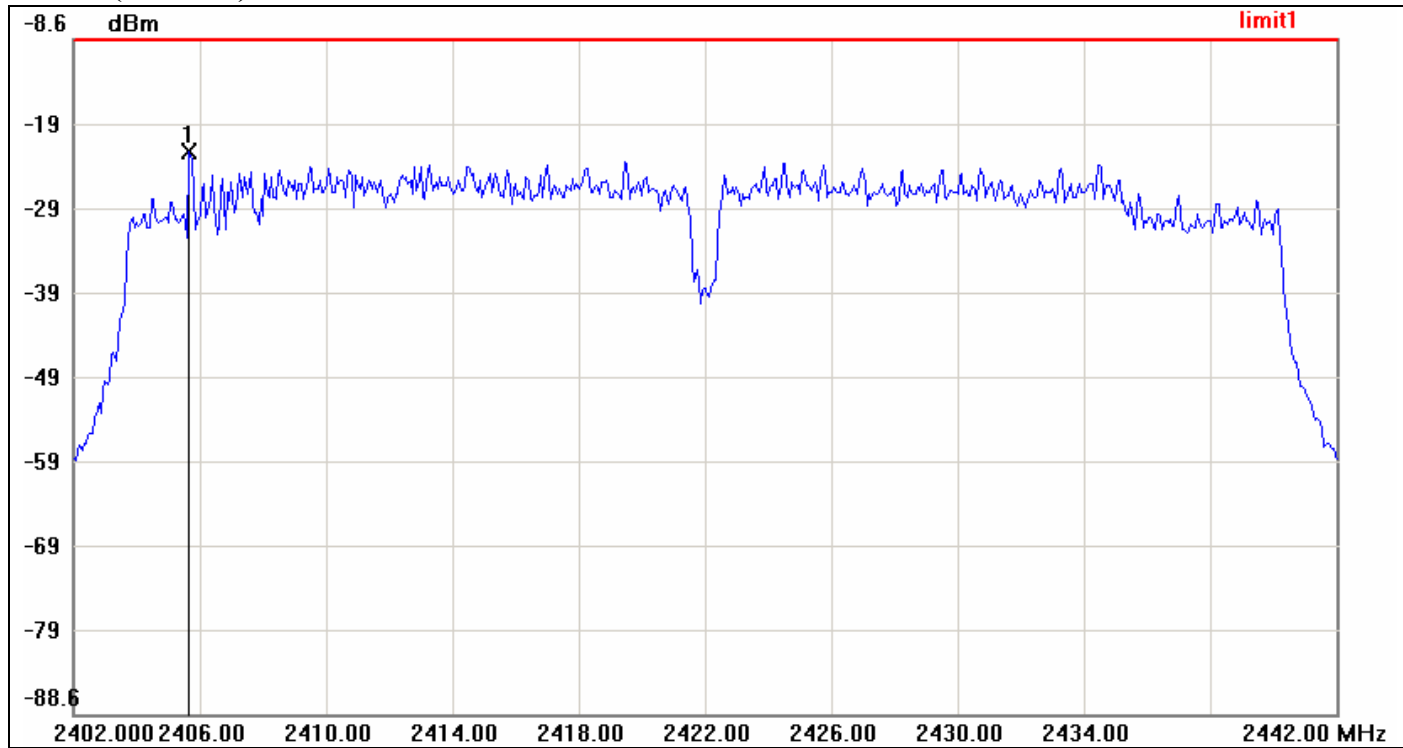

No.	Frequency(MHz)	Result(dBm)	Limit(dBm)	Margin(dBm)
1	2405.6667	-21.95	8.00	-29.95



PPSD (CH Mid)

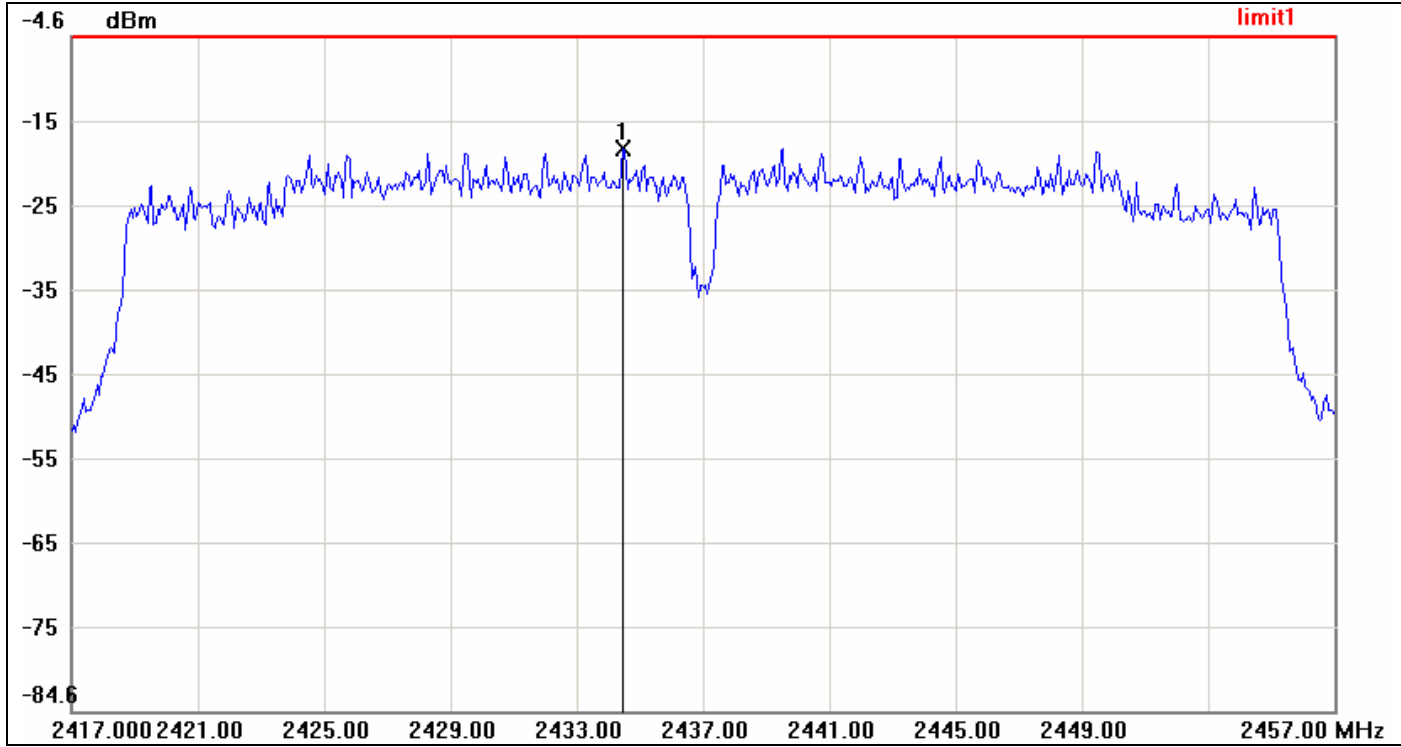

No.	Frequency(MHz)	Result(dBm)	Limit(dBm)	Margin(dBm)
1	2434.4667	-17.84	8.00	-25.84



PPSD (CH High)

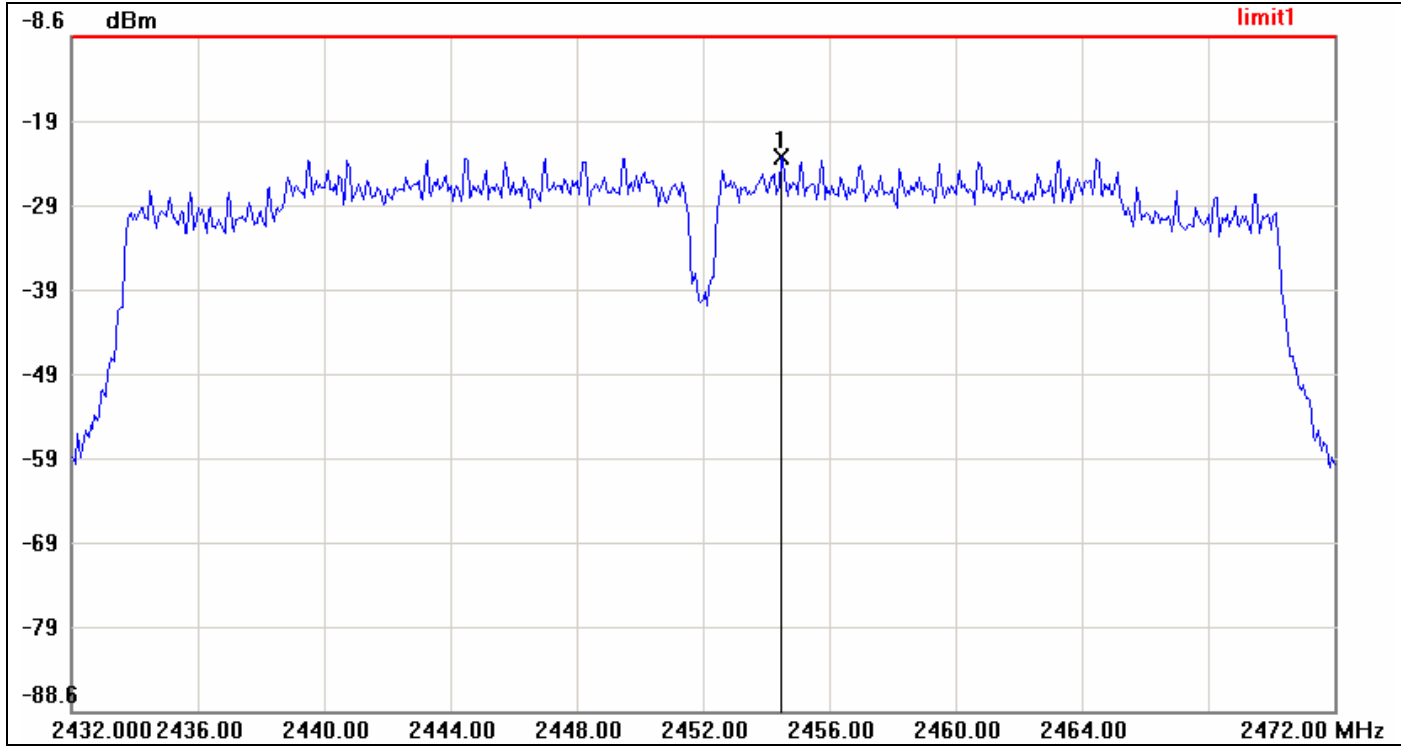

No.	Frequency(MHz)	Result(dBm)	Limit(dBm)	Margin(dBm)
1	2454.4667	-22.83	8.00	-30.83



IEEE 802.11a mode

PPSD (CH Low)

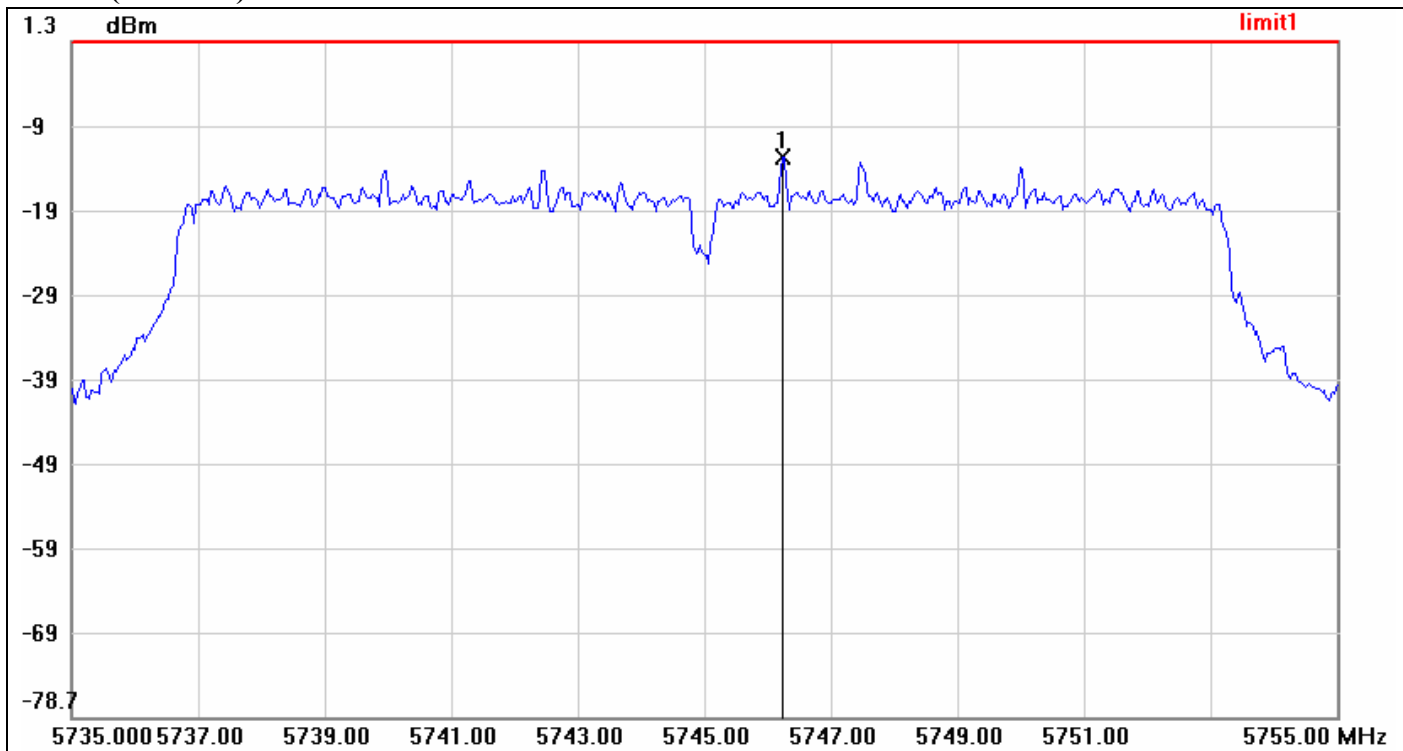

No.	Frequency(MHz)	Result(dBm)	Limit(dBm)	Margin(dBm)
1	5746.2333	-12.36	8	-20.36



PPSD (CH Mid)

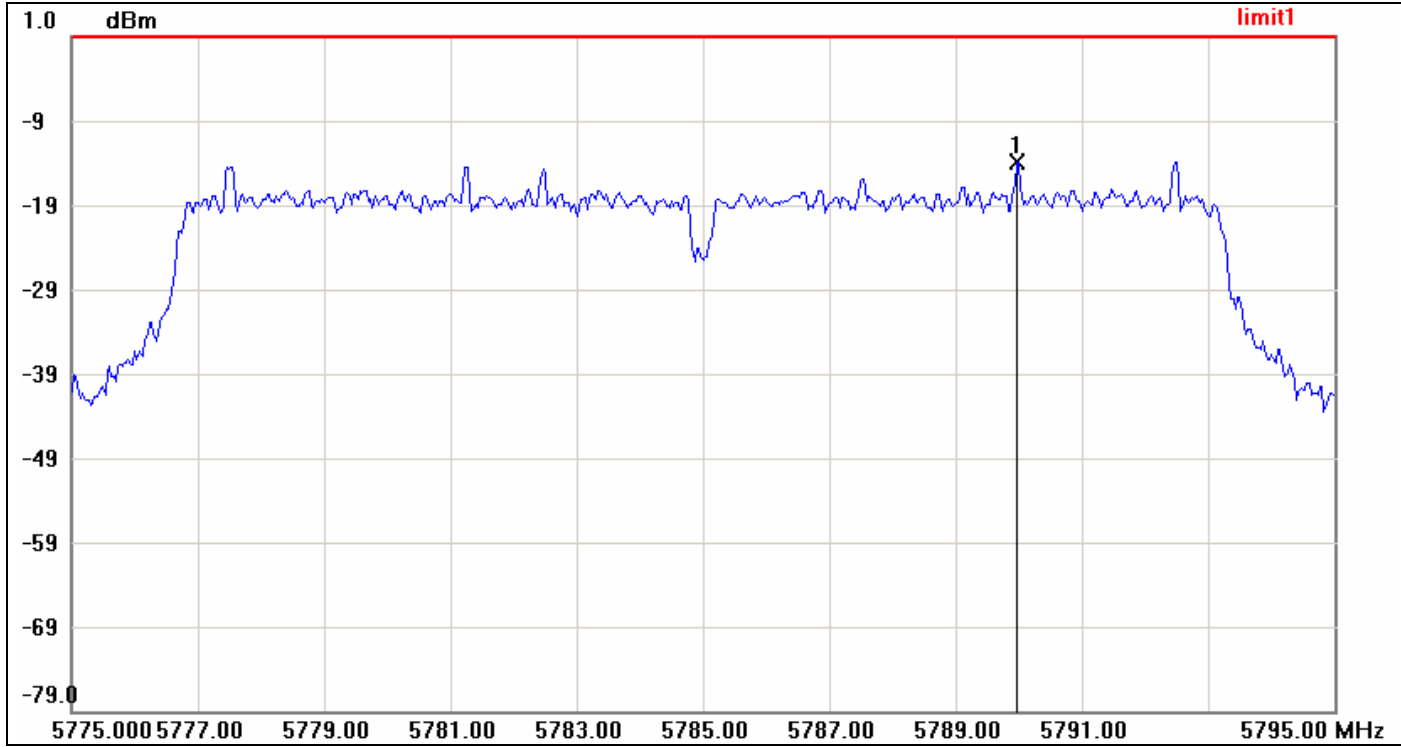

No.	Frequency(MHz)	Result(dBm)	Limit(dBm)	Margin(dBm)
1	5789.9667	-13.81	8.00	-21.81



PPSD (CH High)

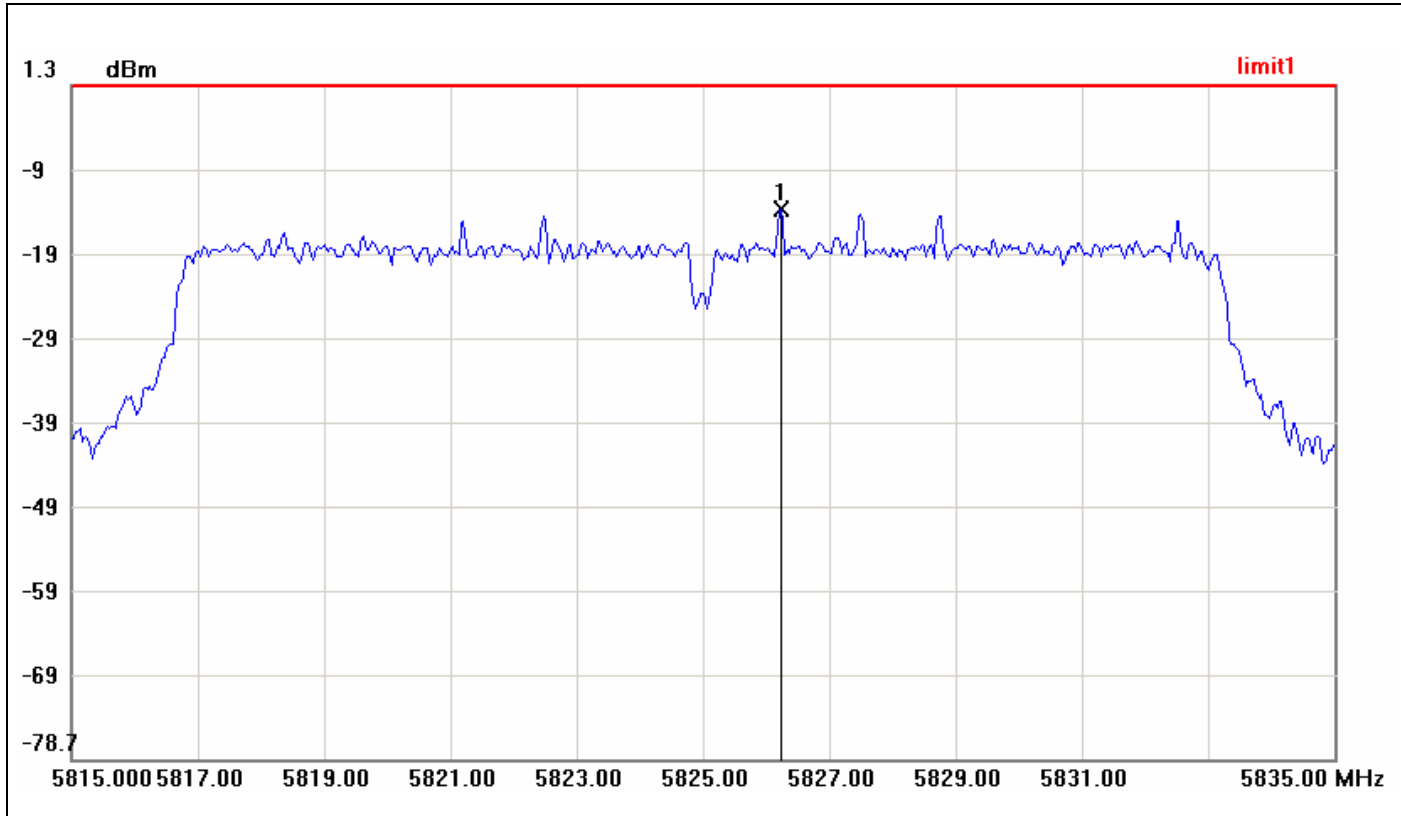

No.	Frequency(MHz)	Result(dBm)	Limit(dBm)	Margin(dBm)
1	5826.2333	-13.47	8.00	-21.47





IEEE 802.11n HT 20 MHz mode

PPSD (CH Low)

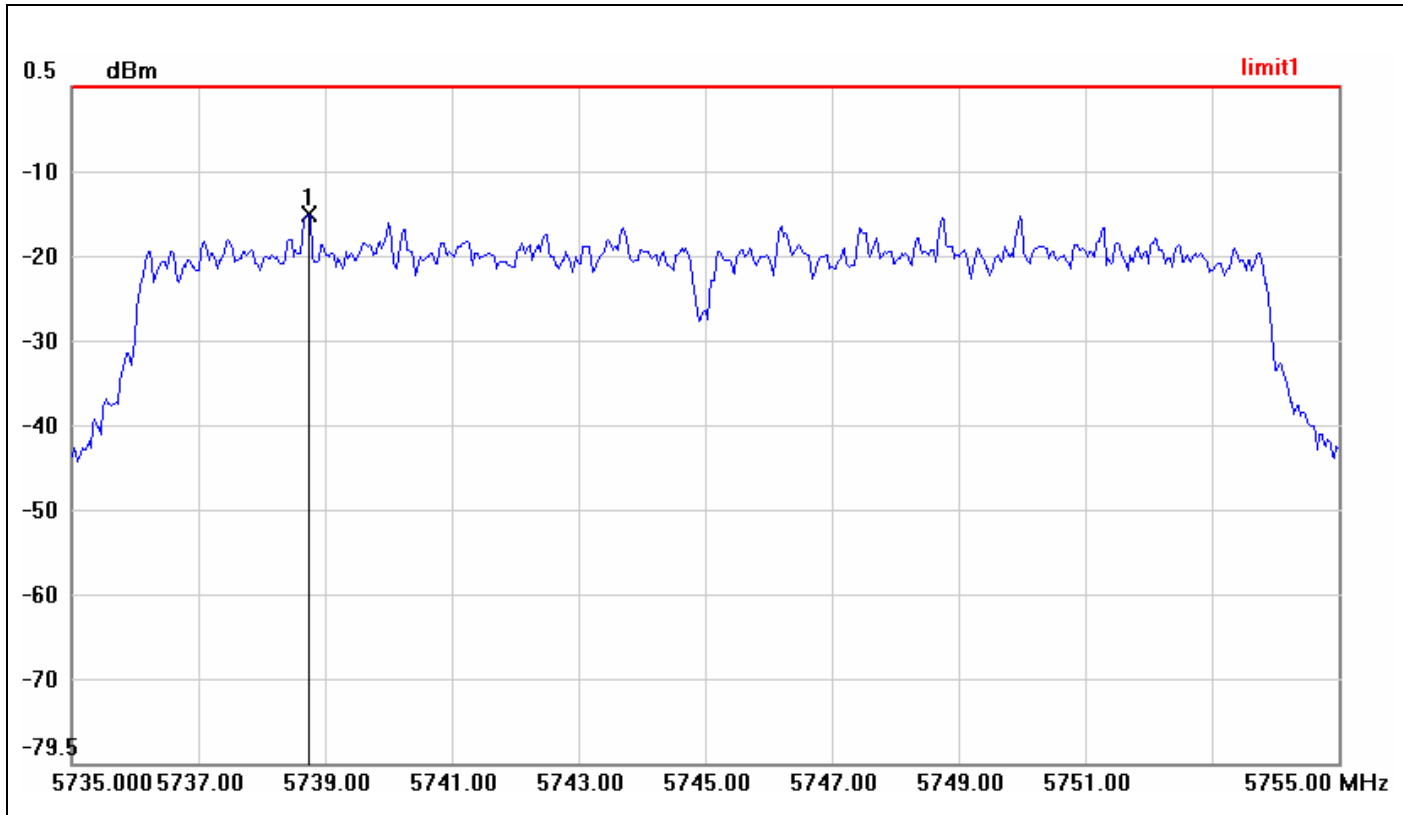

No.	Frequency(MHz)	Result(dBm)	Limit(dBm)	Margin(dBm)
1	5738.7333	-14.70	8	-22.70



PPSD (CH Mid)

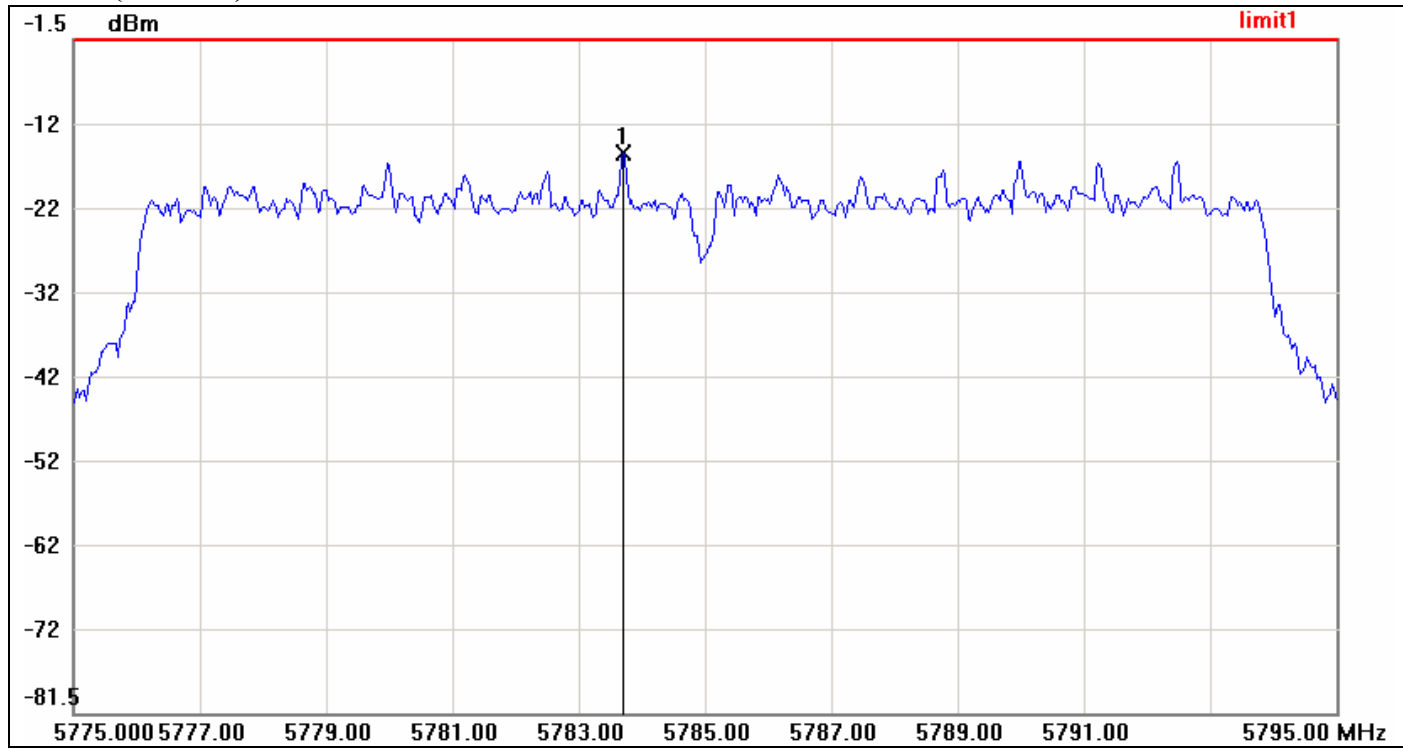

No.	Frequency(MHz)	Result(dBm)	Limit(dBm)	Margin(dBm)
1	5783.7000	-15.03	8.00	-23.03



PPSD (CH High)

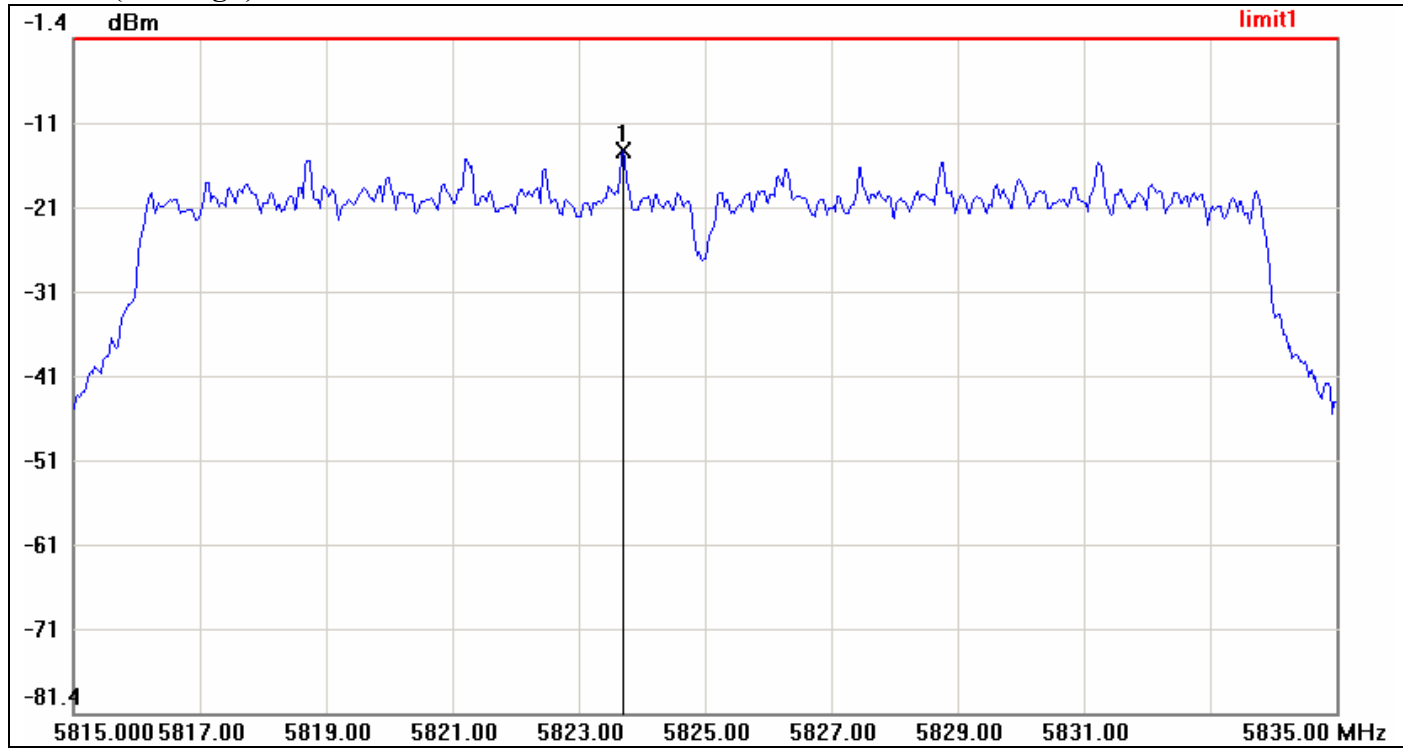

No.	Frequency(MHz)	Result(dBm)	Limit(dBm)	Margin(dBm)
1	5823.7000	-14.79	8.00	-22.79



IEEE 802.11n HT 40 MHz mode

PPSD (CH Low)

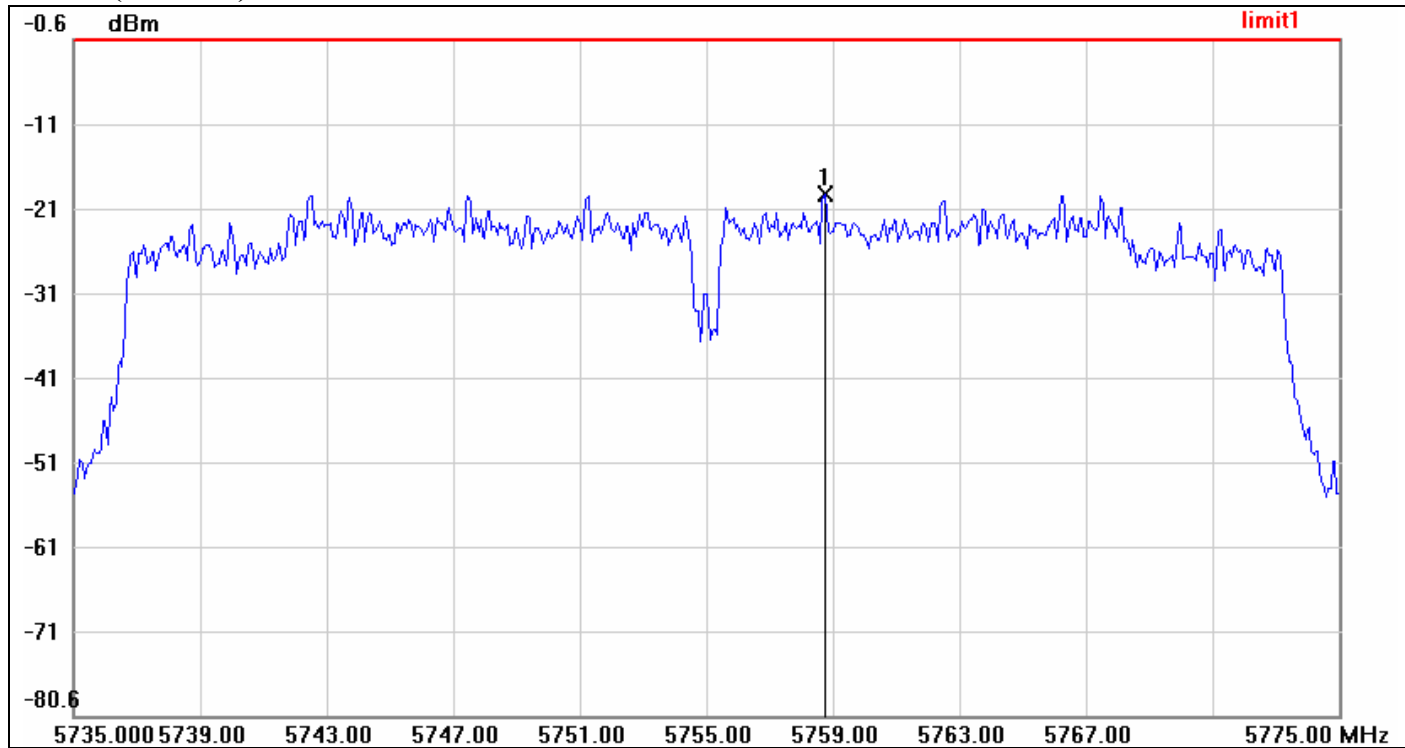

No.	Frequency(MHz)	Result(dBm)	Limit(dBm)	Margin(dBm)
1	5758.7333	-18.92	8	-26.92



PPSD (CH High)

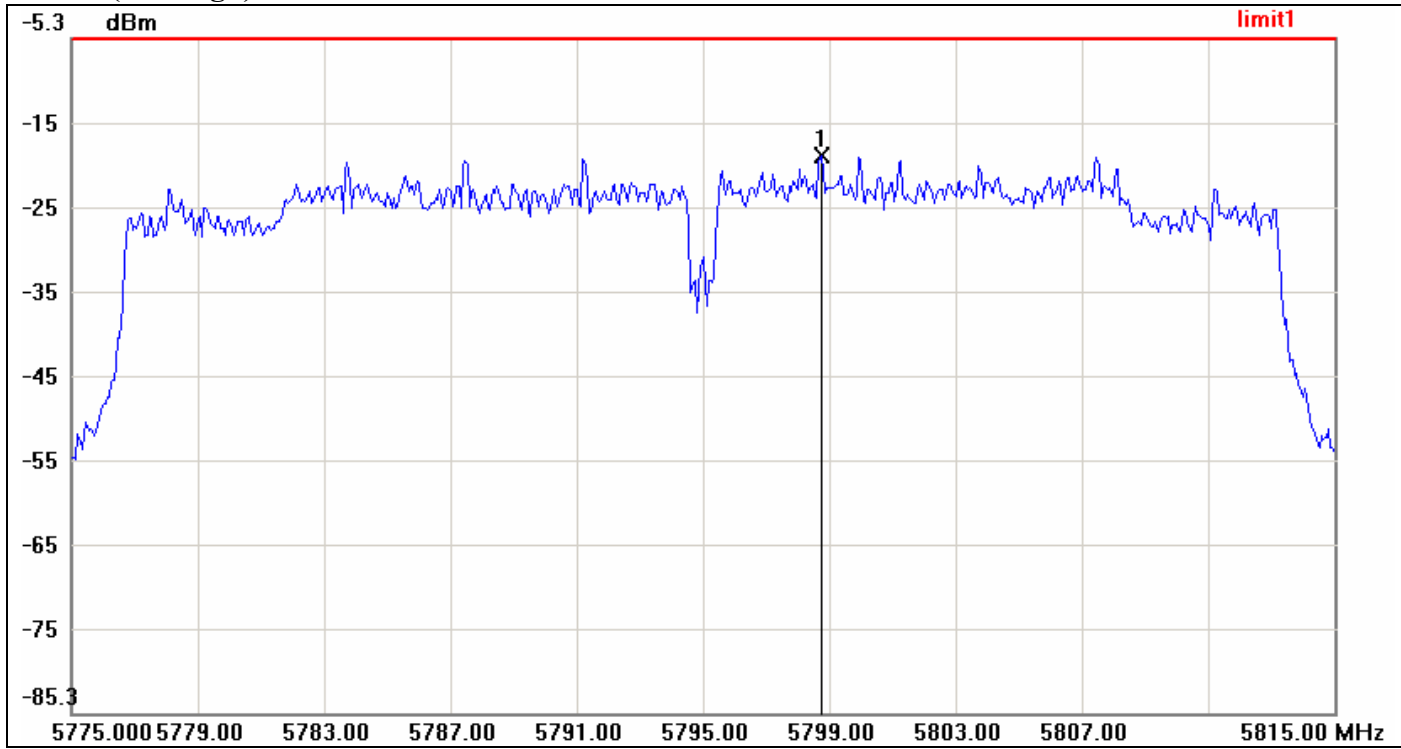

No.	Frequency(MHz)	Result(dBm)	Limit(dBm)	Margin(dBm)
1	5798.7333	-19.23	8.00	-27.23



## 7.7 SPURIOUS EMISSIONS

### 7.7.1 Conducted Measurement

#### **LIMIT**

According to §15.247(d) & RSS-210 §A8.5, in any 100 kHz bandwidth outside the frequency bands in which the spread spectrum intentional radiator is operating, the radio frequency power that is produced by the intentional radiator shall be at least 20 dB below that in the 100 kHz bandwidth within the band that contains the highest level of the desired power, based on either an RF conducted or a radiated measurement, provided the transmitter demonstrates compliance with the peak conducted power limits. In addition, radiated emissions which fall in the restricted bands, as defined in §15.205(a), must also comply with the radiated emission limits specified in 15.209(a) (see Section 15.205(c)).

#### **Test Configuration**

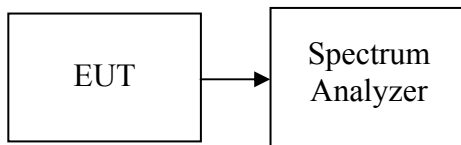

#### **TEST PROCEDURE**

Conducted RF measurements of the transmitter output were made to confirm that the EUT antenna port conducted emissions meet the specified limit and to identify any spurious signals that require further investigation or measurements on the radiated emissions site.

The transmitter output is connected to the spectrum analyzer. The resolution bandwidth is set to 100 kHz. The video bandwidth is set to 100 kHz.

Measurements are made over the 30MHz to 26GHz range for IEEE 802.11b/g, 30MHz to 40GHz range for IEEE 802.11a with the transmitter set to the lowest, middle, and highest channels.

#### **TEST RESULTS**

*No non-compliance noted*



**Test Plot**

**IEEE 802.11b mode**

**CH Low**

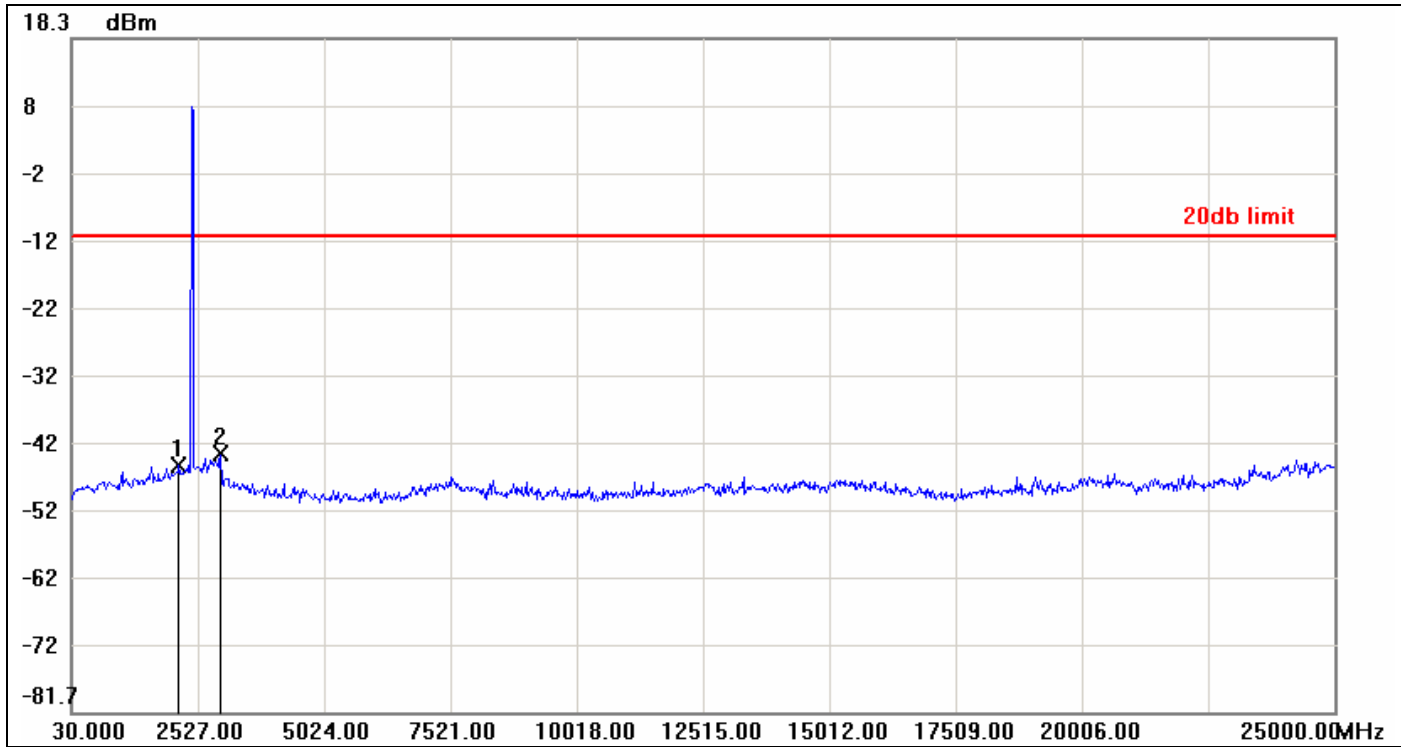

No.	Frequency(MHz)	Result(dBm)	Limit(dBm)	Margin(dBm)
1	2152.4500	-45.01	-10.96	-34.05
2	2976.4600	-43.46	-10.96	-32.50



### CH Mid

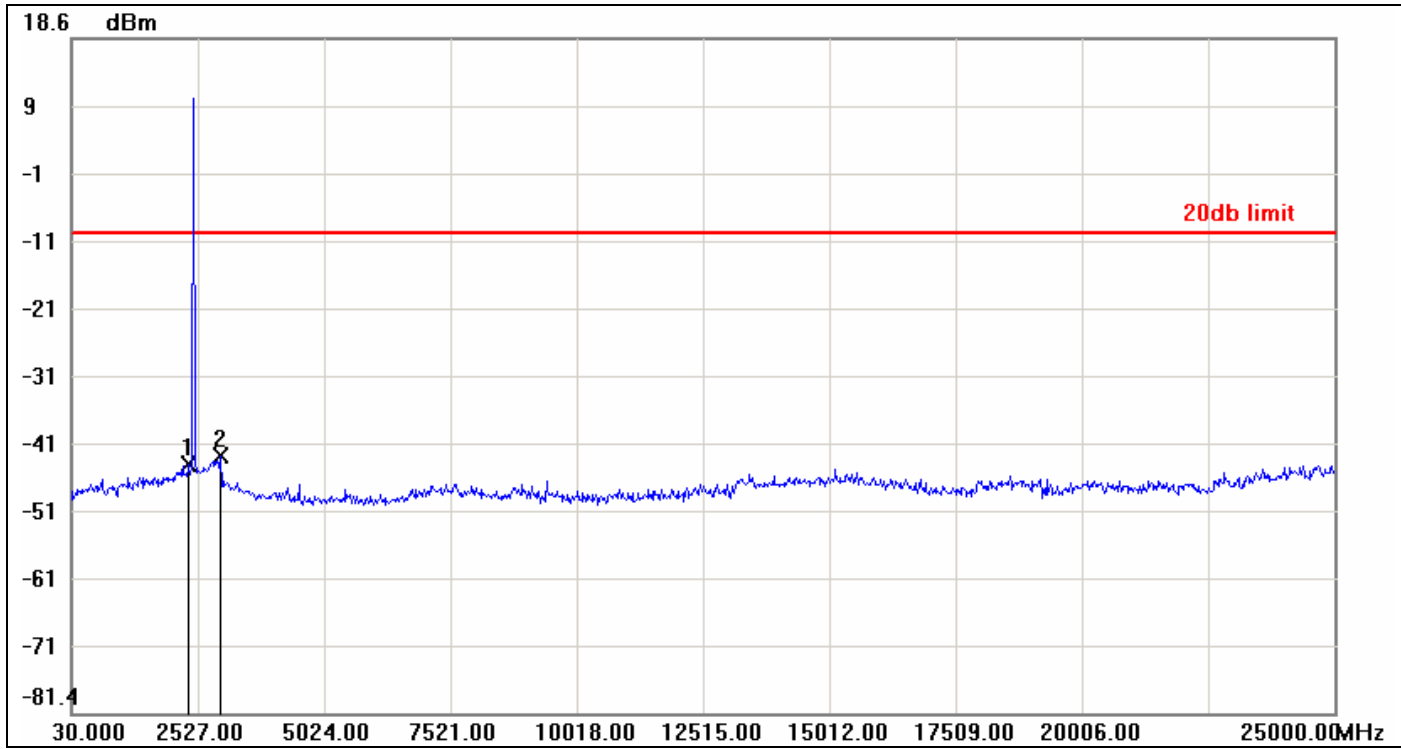

No.	Frequency(MHz)	Result(dBm)	Limit(dBm)	Margin(dBm)
1	2352.2100	-44.44	-10.34	-34.10
2	2976.4600	-43.36	-10.34	-33.02





### CH High

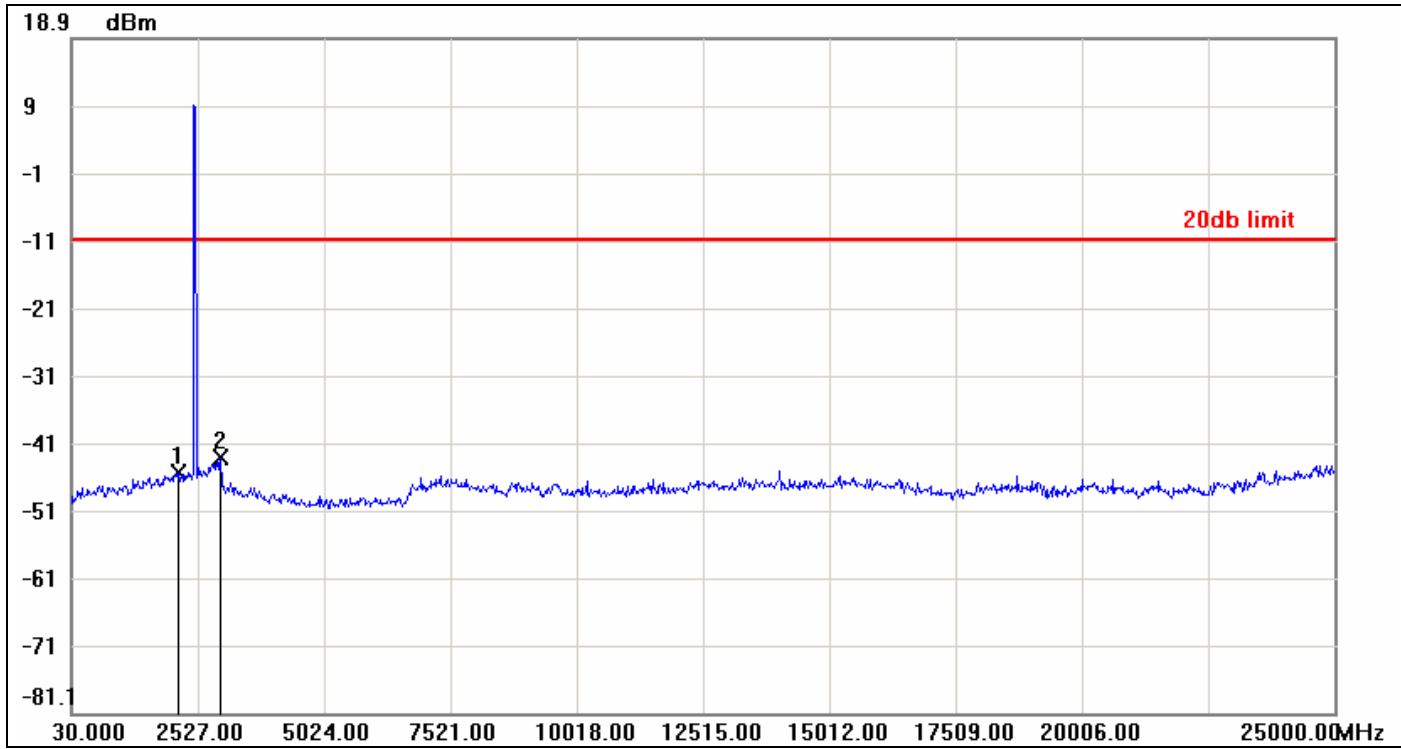

No.	Frequency(MHz)	Result(dBm)	Limit(dBm)	Margin(dBm)
1	2152.4500	-45.39	-10.96	-34.43
2	2976.4600	-43.24	-10.96	-32.28



IEEE 802.11g mode

CH Low

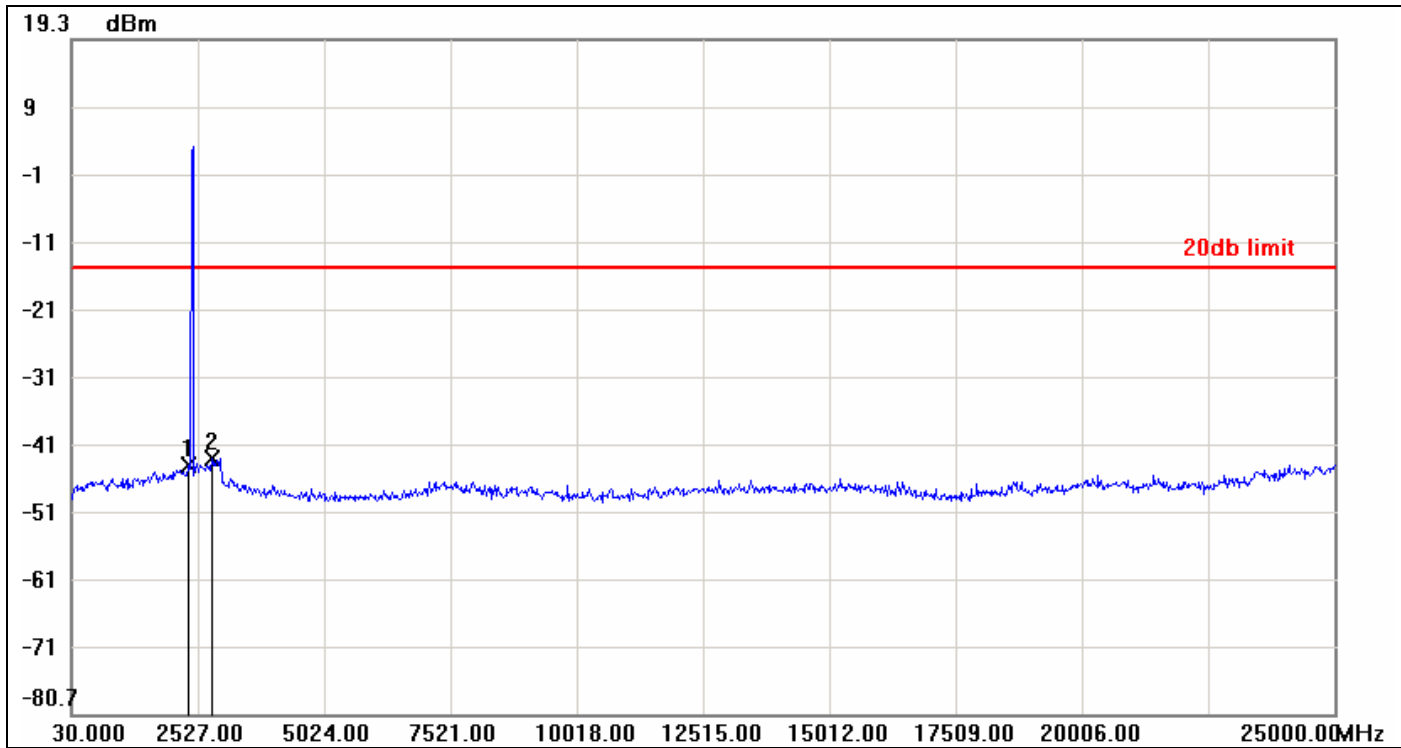

No.	Frequency(MHz)	Result(dBm)	Limit(dBm)	Margin(dBm)
1	2352.2100	-43.83	-14.49	-29.34
2	2801.6700	-42.84	-14.49	-28.35



### CH Mid

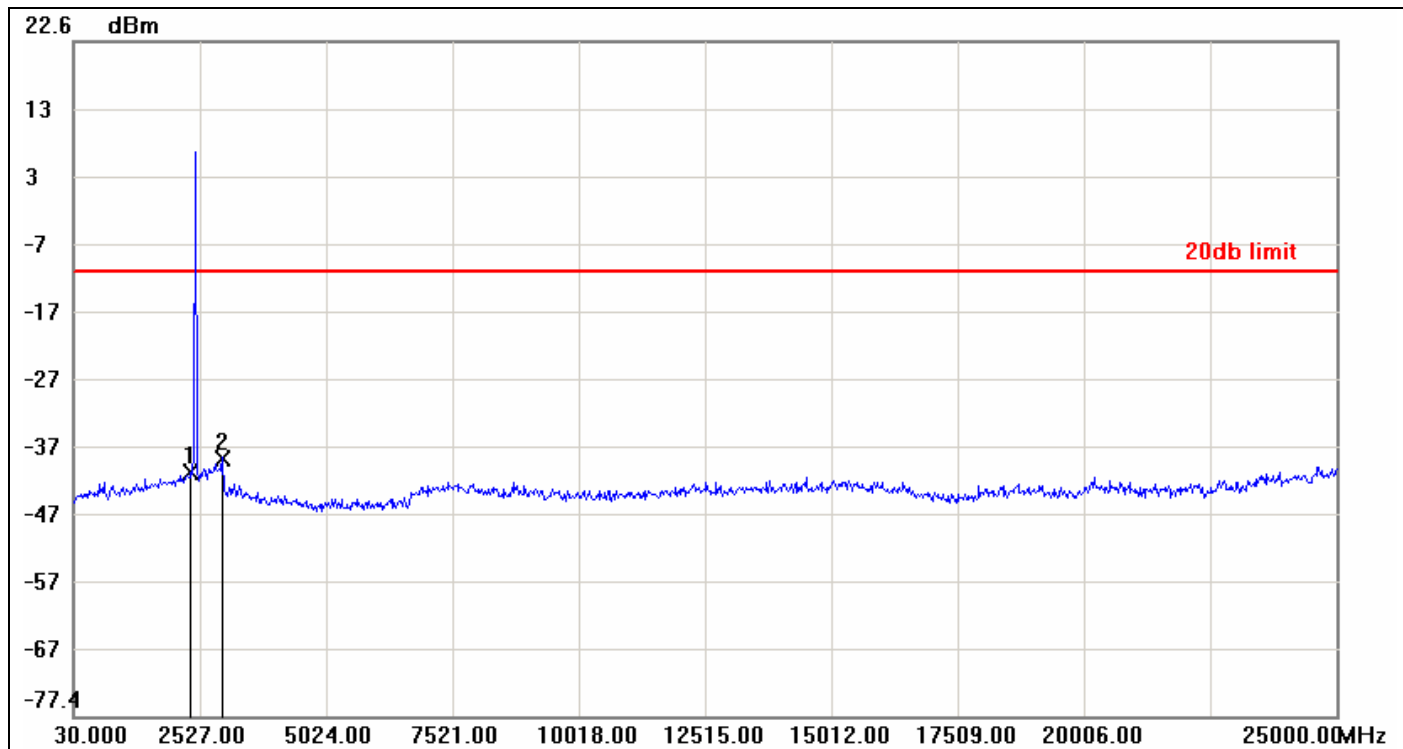

No.	Frequency(MHz)	Result(dBm)	Limit(dBm)	Margin(dBm)
1	2352.2100	-41.36	-11.44	-29.92
2	2976.4600	-39.13	-11.44	-27.69



### CH High

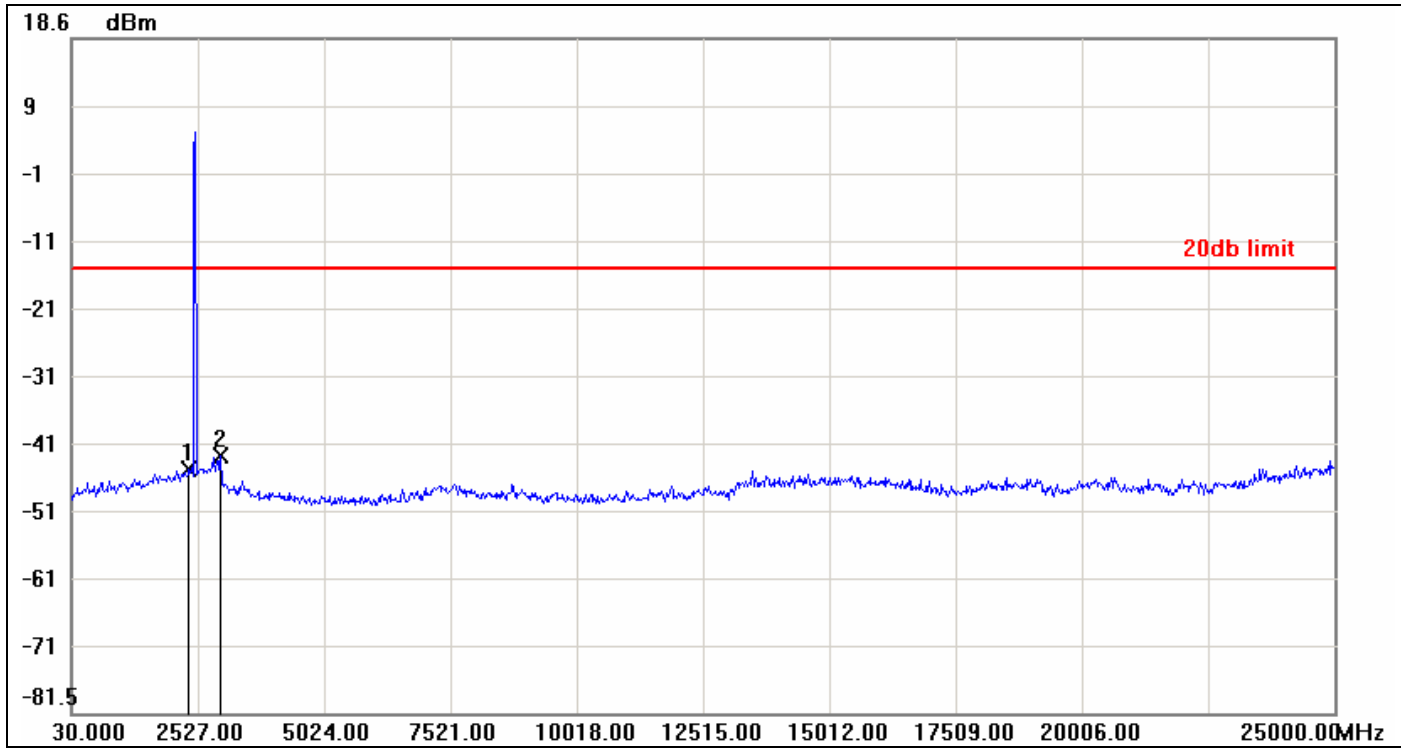

No.	Frequency(MHz)	Result(dBm)	Limit(dBm)	Margin(dBm)
1	2352.2100	-45.29	-15.60	-29.69
2	2976.4600	-43.30	-15.60	-27.70



IEEE 802.11n HT 20 MHz mode / Main Antenna

CH Low

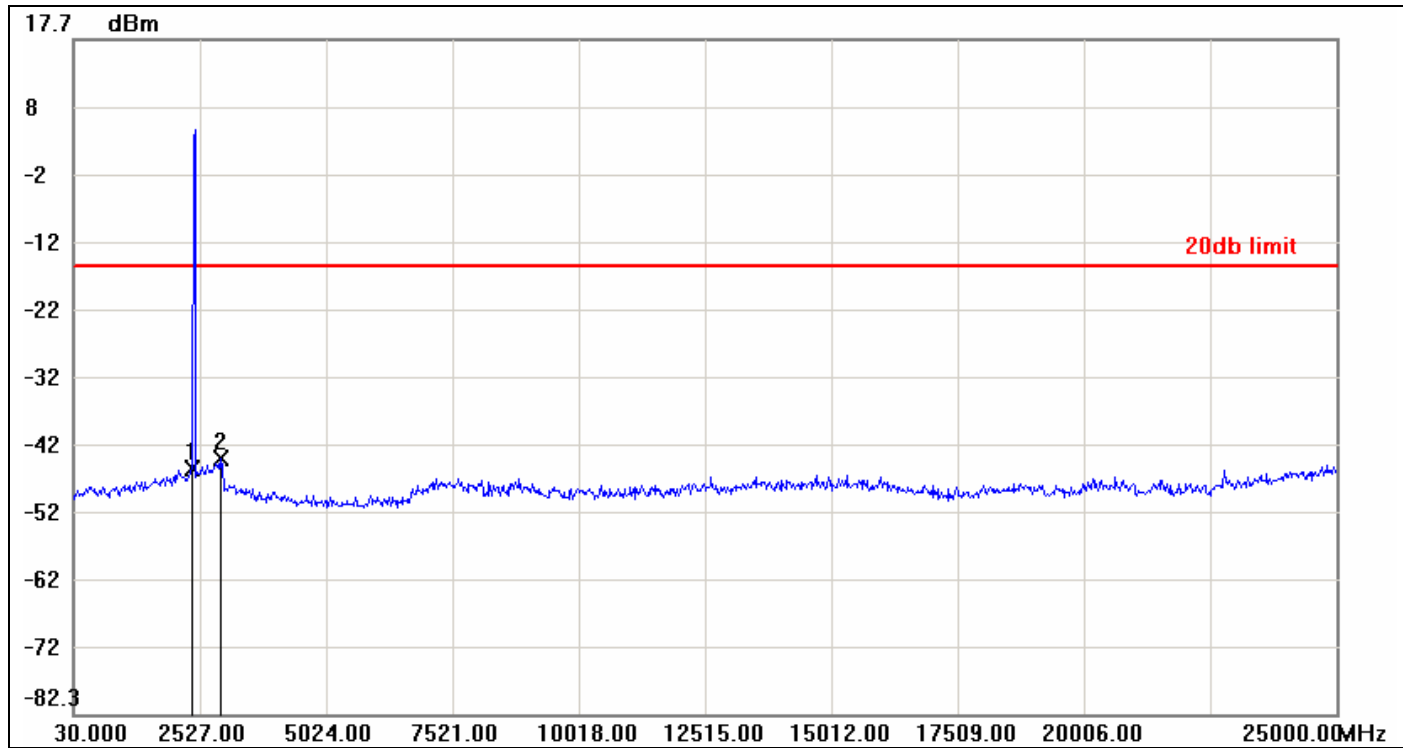

No.	Frequency(MHz)	Result(dBm)	Limit(dBm)	Margin(dBm)
1	2377.1800	-45.94	-15.82	-30.12
2	2926.5200	-44.48	-15.82	-28.66



### CH Mid

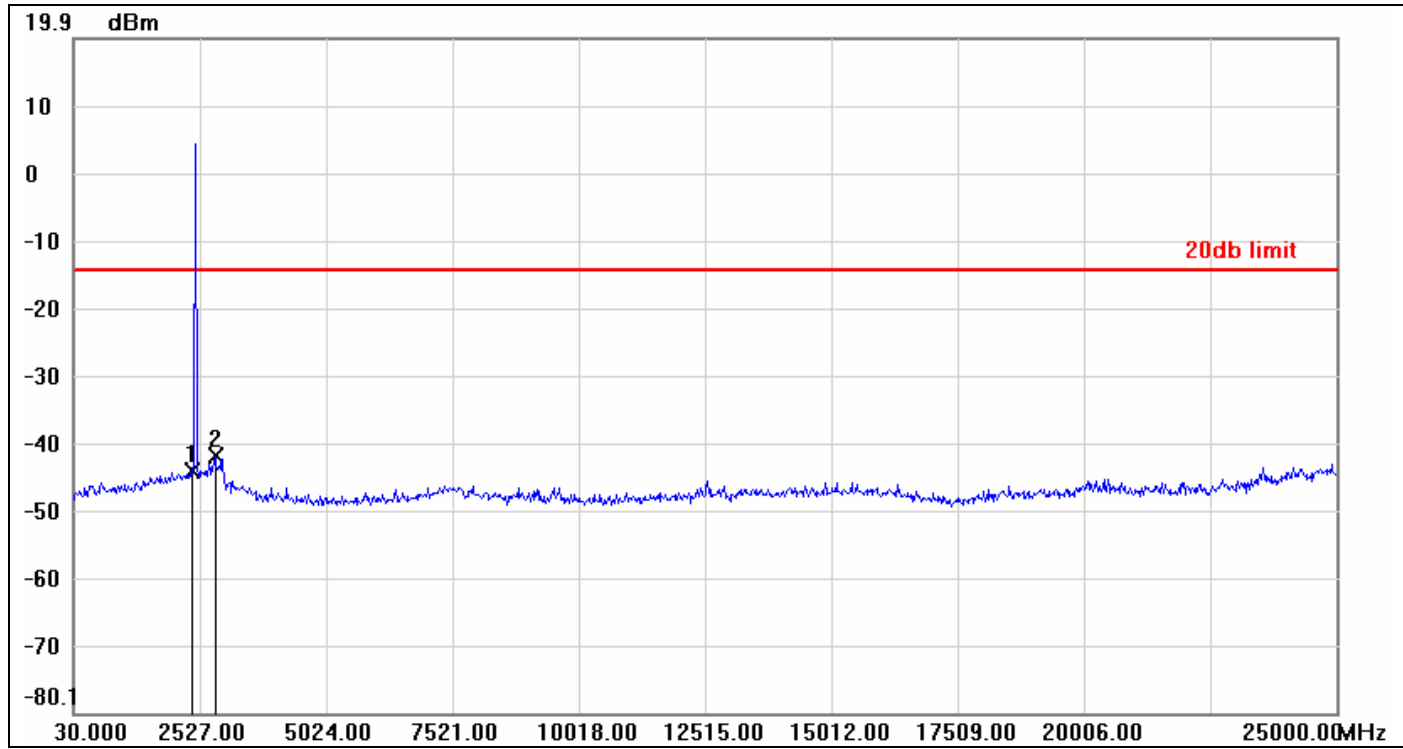

No.	Frequency(MHz)	Result(dBm)	Limit(dBm)	Margin(dBm)
1	2377.1800	-44.33	-14.46	-29.87
2	2826.6400	-42.07	-14.46	-27.61



### CH High

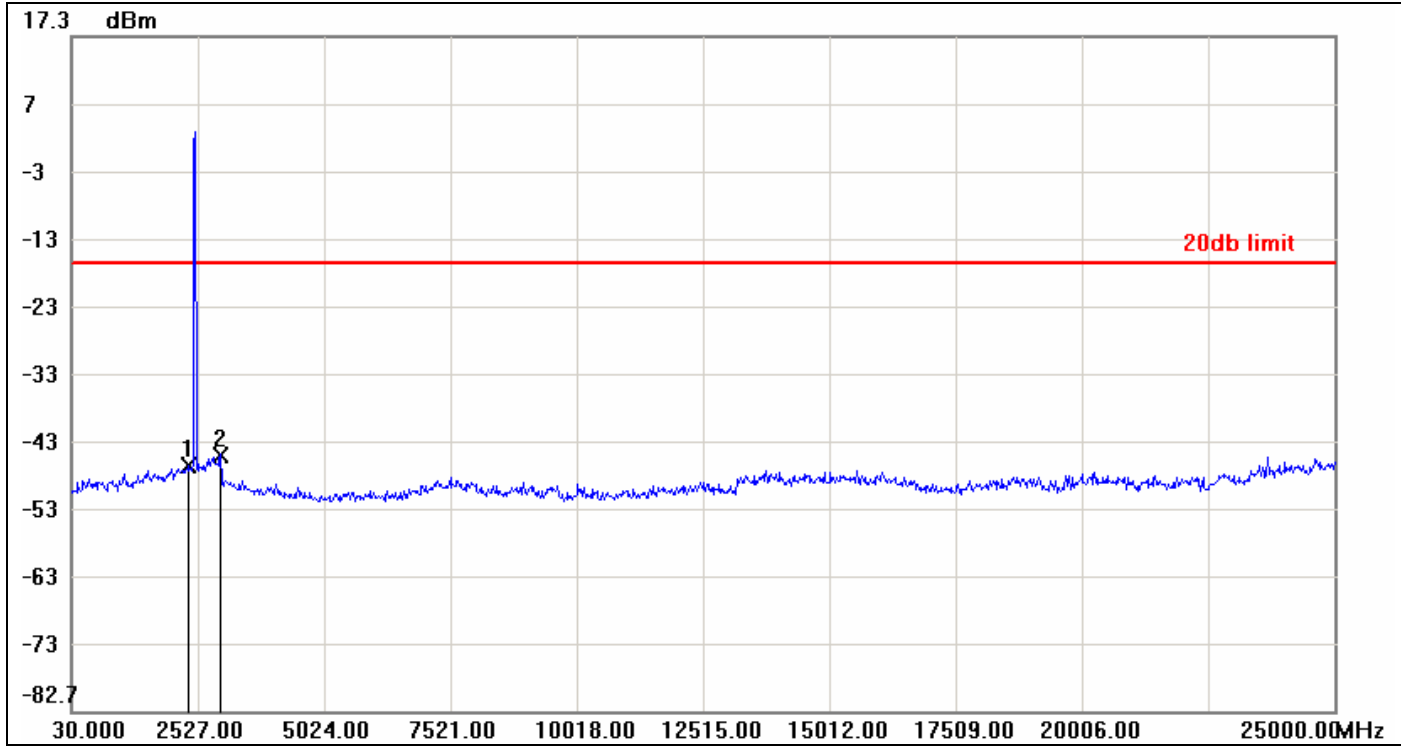

No.	Frequency(MHz)	Result(dBm)	Limit(dBm)	Margin(dBm)
1	2352.2100	-46.22	-16.24	-29.98
2	2976.4600	-44.66	-16.24	-28.42



IEEE 802.11n HT 20 MHz mode / Aux Antenna

CH Low

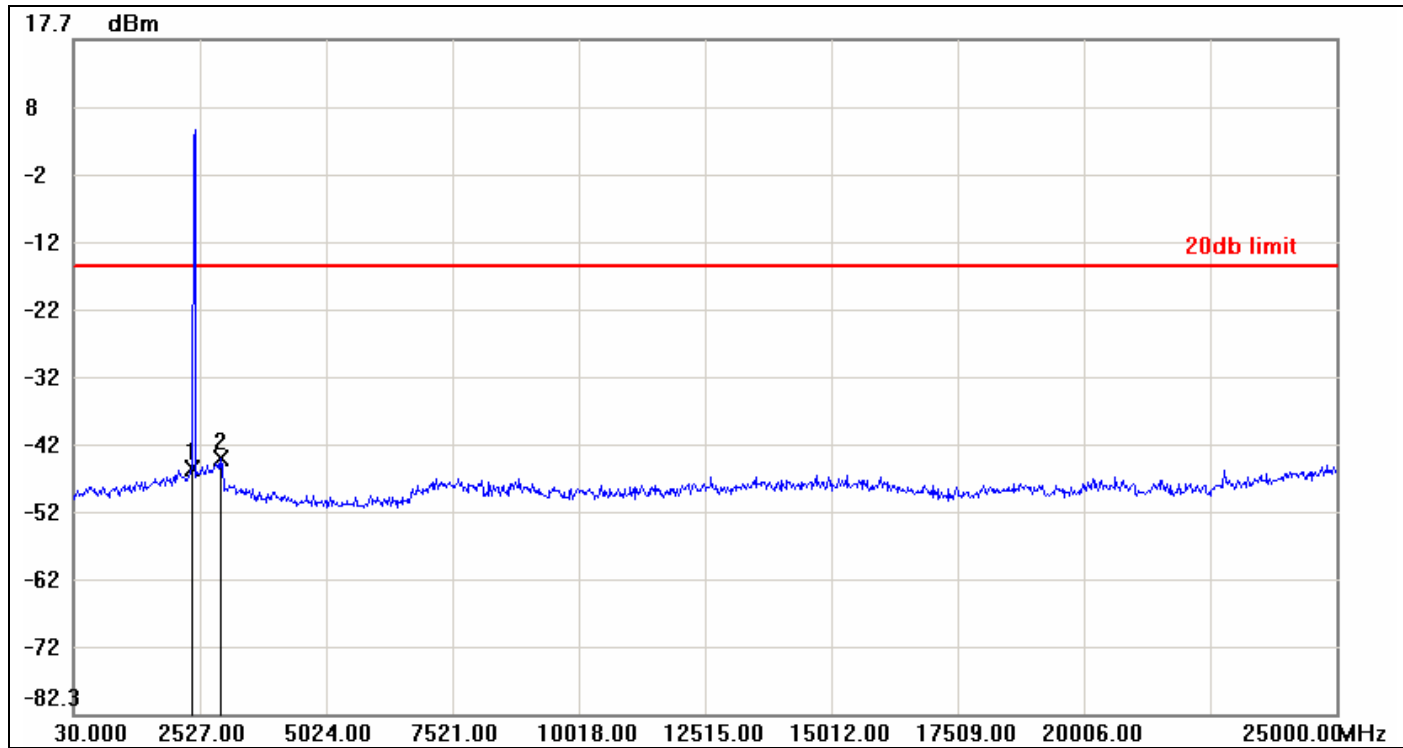

No.	Frequency(MHz)	Result(dBm)	Limit(dBm)	Margin(dBm)
1	2377.1800	-45.94	-15.82	-30.12
2	2926.5200	-44.48	-15.82	-28.66





CH Mid

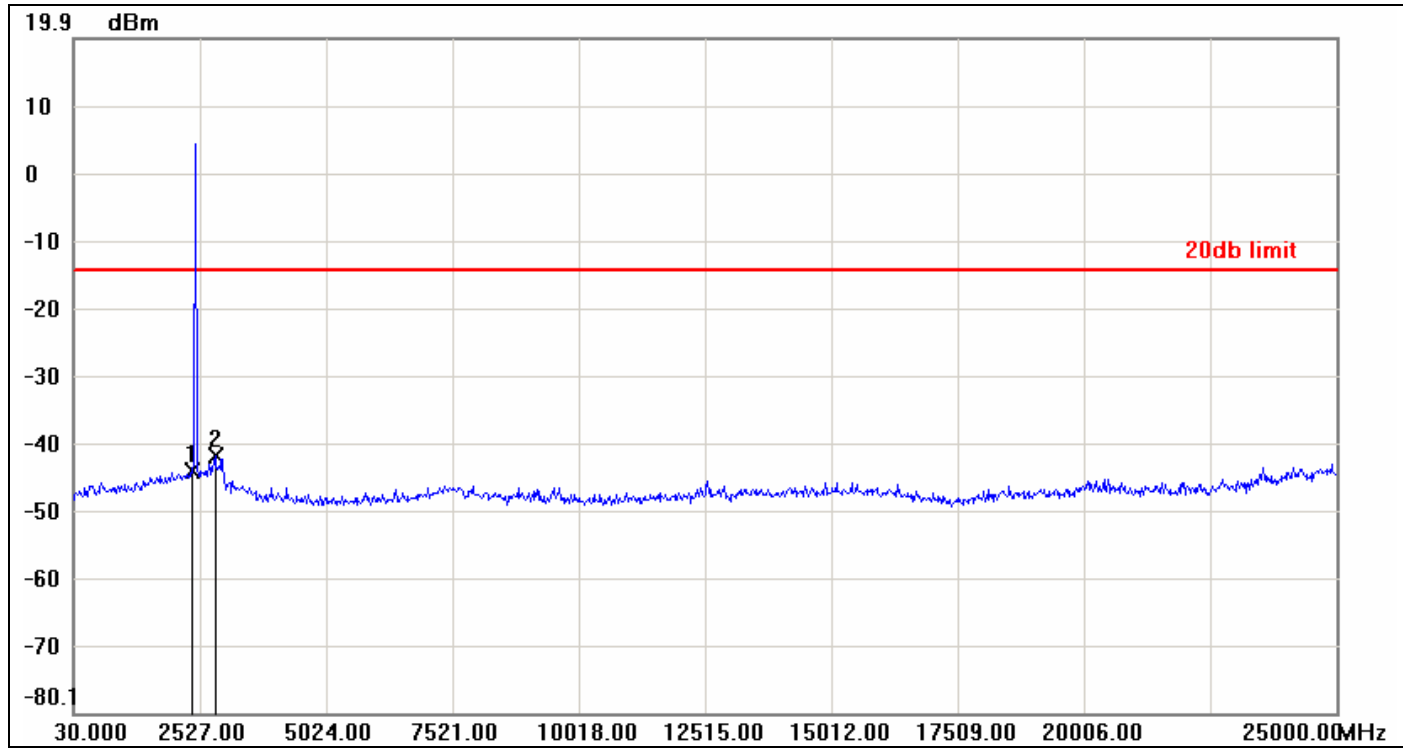

No.	Frequency(MHz)	Result(dBm)	Limit(dBm)	Margin(dBm)
1	2377.1800	-44.33	-14.46	-29.87
2	2826.6400	-42.07	-14.46	-27.61



### CH High

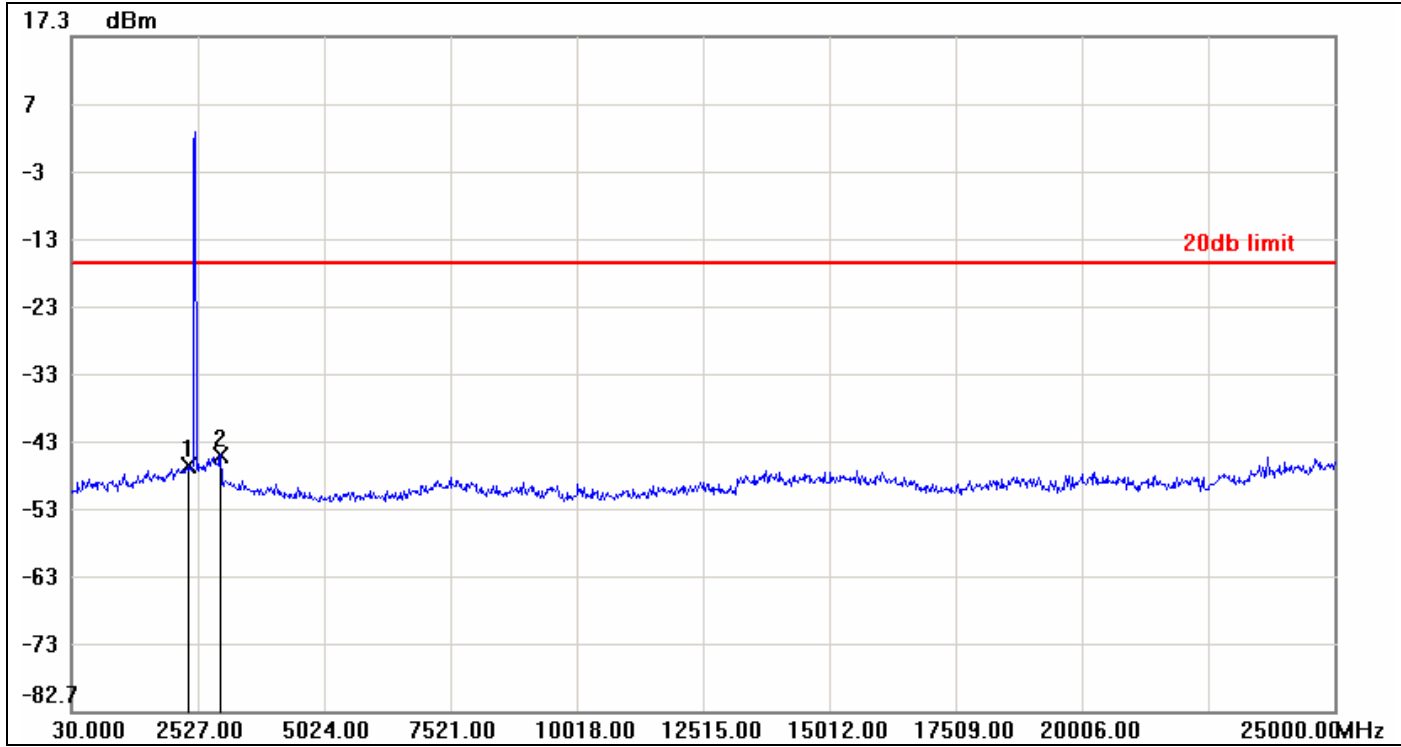

No.	Frequency(MHz)	Result(dBm)	Limit(dBm)	Margin(dBm)
1	2352.2100	-46.22	-16.24	-29.98
2	2976.4600	-44.66	-16.24	-28.42



IEEE 802.11n HT 40 MHz mode / Main Antenna

CH Low

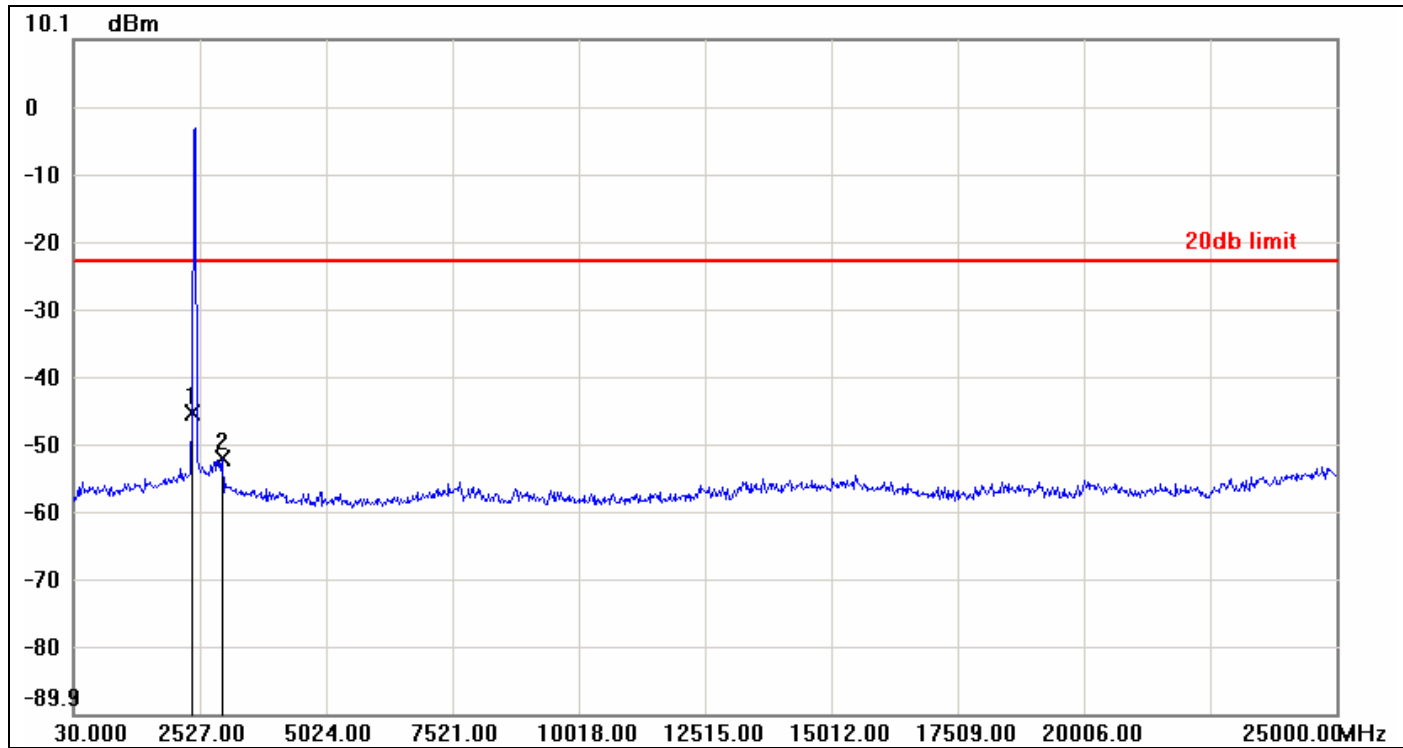

No.	Frequency(MHz)	Result(dBm)	Limit(dBm)	Margin(dBm)
1	2377.1800	-45.35	-22.84	-22.51
2	2976.4600	-52.07	-22.84	-29.23



CH Mid

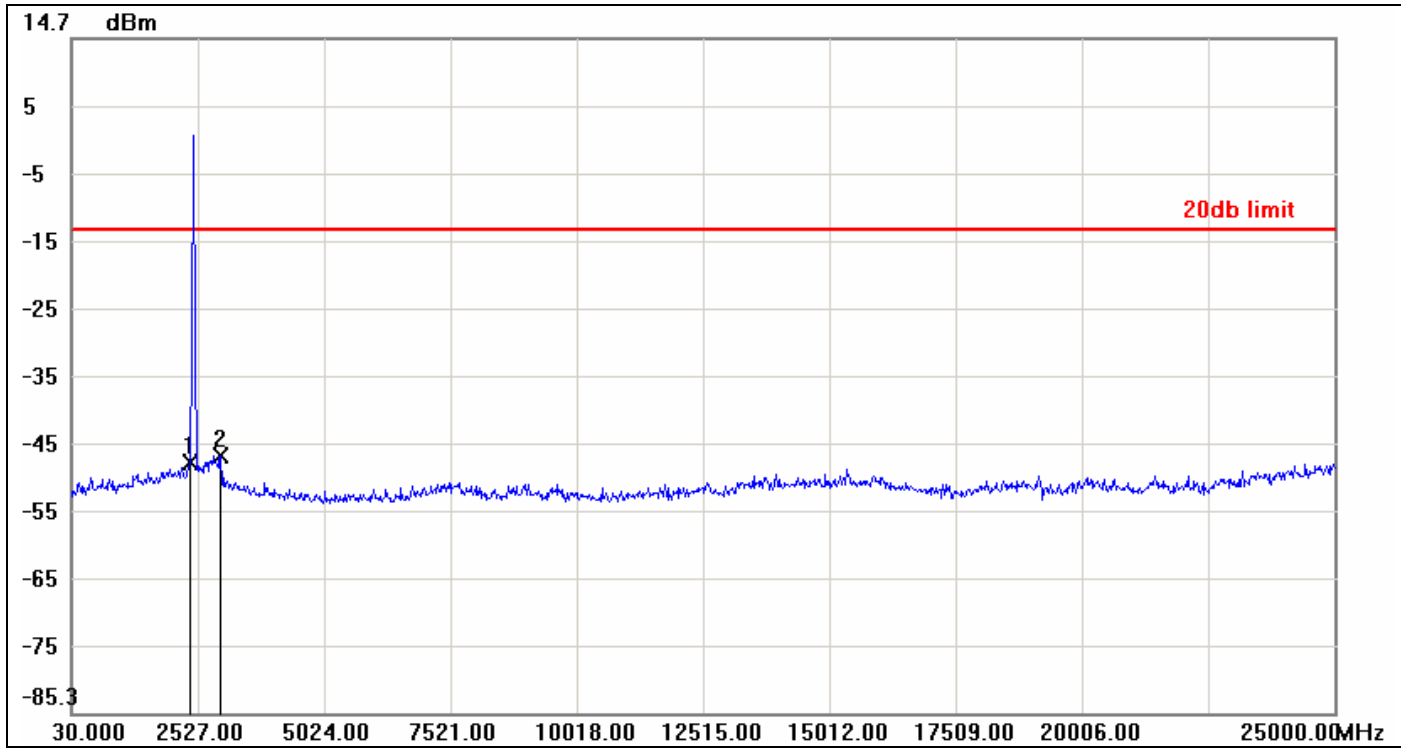

No.	Frequency(MHz)	Result(dBm)	Limit(dBm)	Margin(dBm)
1	2377.1800	-48.18	-13.71	-34.47
2	2976.4600	-47.21	-13.71	-33.50



### CH High

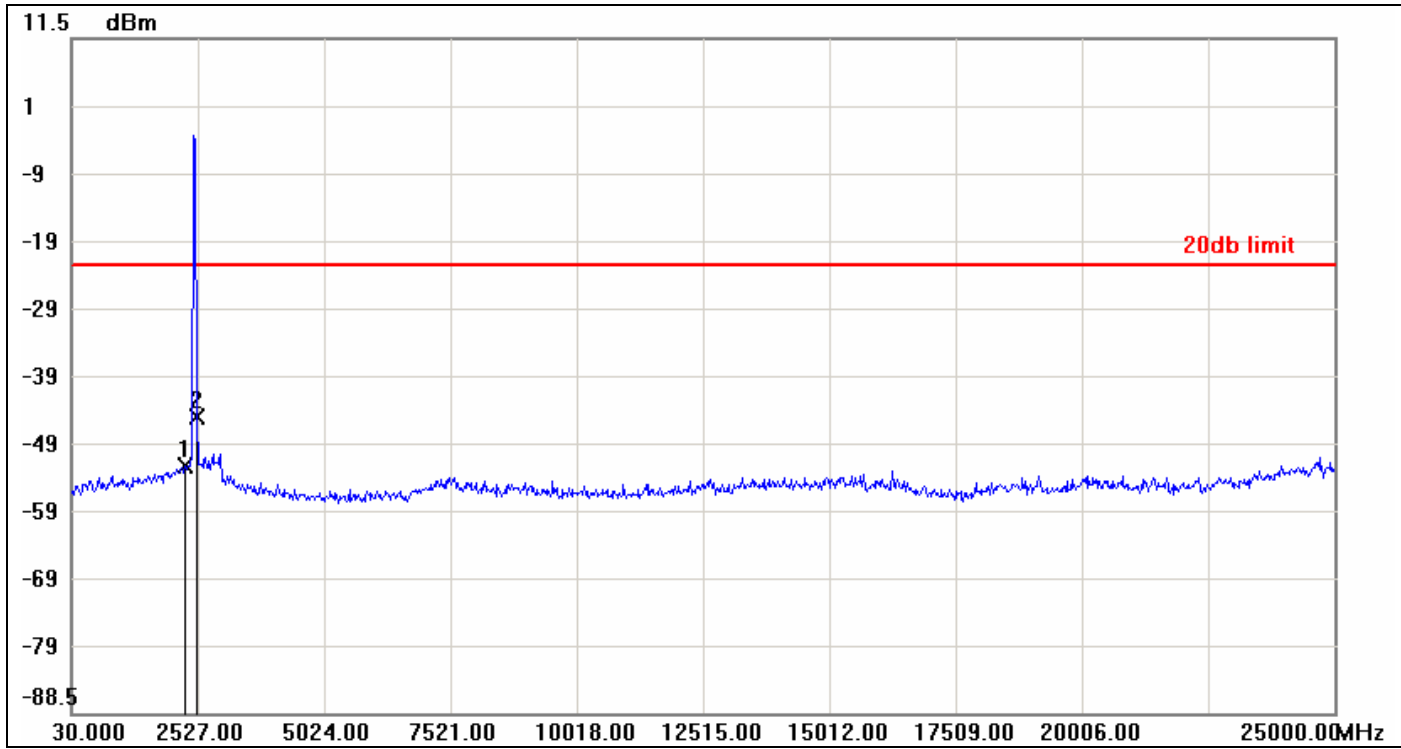

No.	Frequency(MHz)	Result(dBm)	Limit(dBm)	Margin(dBm)
1	2277.3000	-51.78	-22.19	-29.59
2	2502.0300	-44.60	-22.19	-22.41



IEEE 802.11n HT 40 MHz mode / Aux Antenna

CH Low

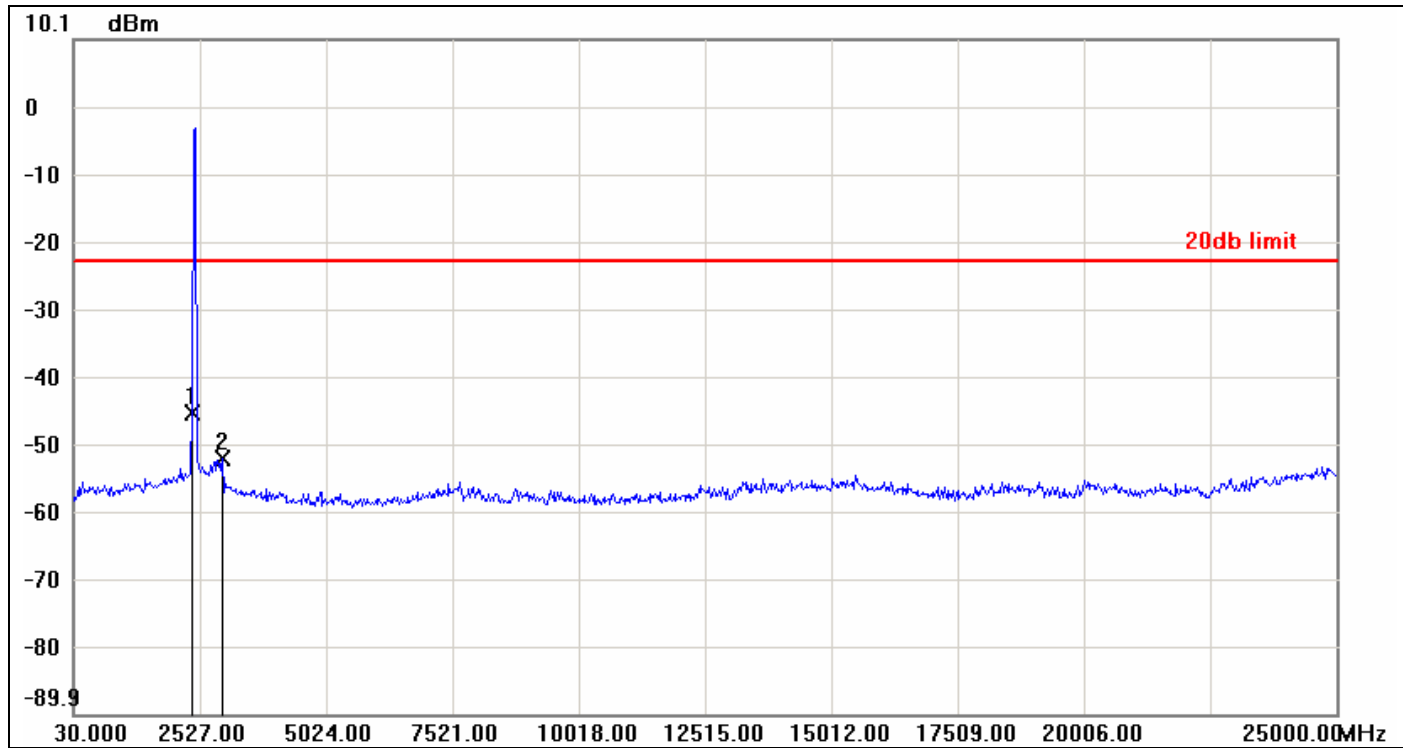

No.	Frequency(MHz)	Result(dBm)	Limit(dBm)	Margin(dBm)
1	2377.1800	-45.35	-22.84	-22.51
2	2976.4600	-52.07	-22.84	-29.23



### CH Mid

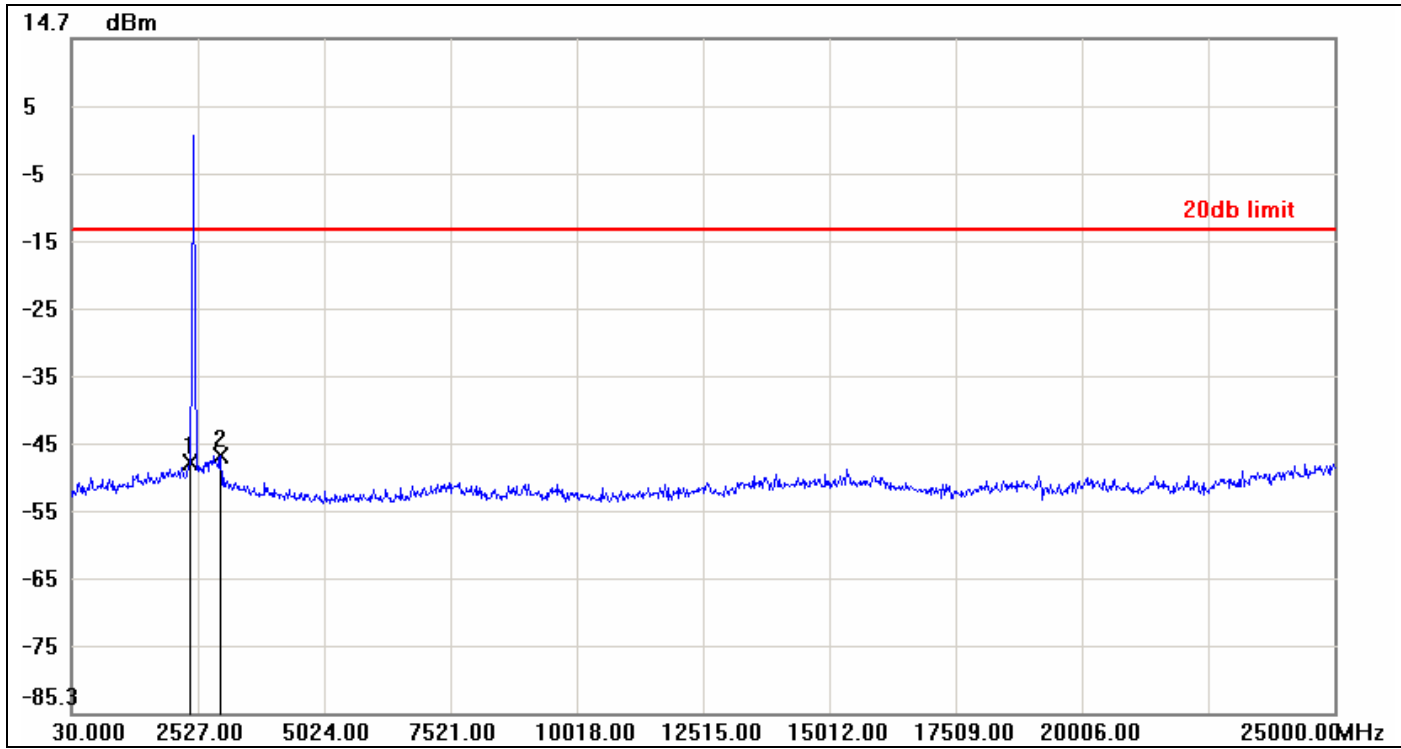

No.	Frequency(MHz)	Result(dBm)	Limit(dBm)	Margin(dBm)
1	2377.1800	-48.18	-13.71	-34.47
2	2976.4600	-47.21	-13.71	-33.50



### CH High

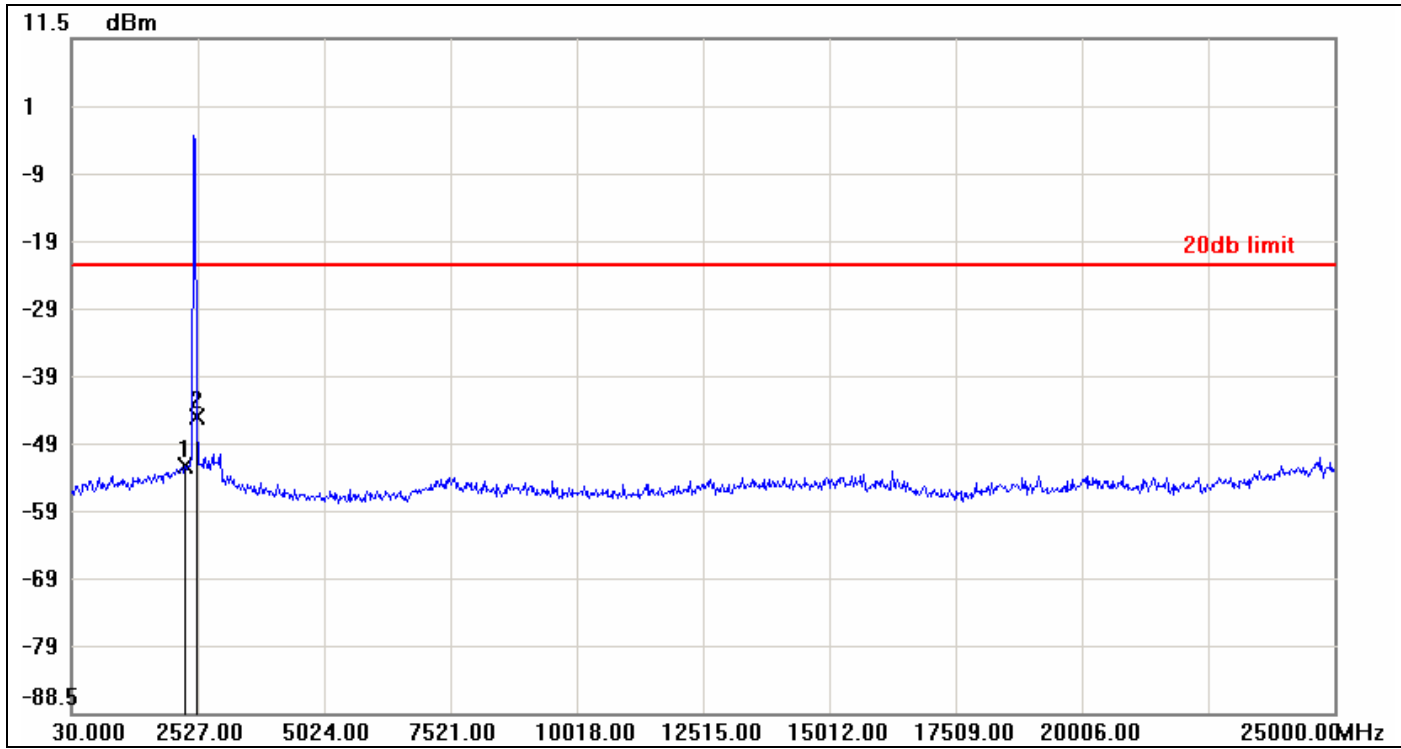

No.	Frequency(MHz)	Result(dBm)	Limit(dBm)	Margin(dBm)
1	2277.3000	-51.78	-22.19	-29.59
2	2502.0300	-44.60	-22.19	-22.41





IEEE 802.11a mode

CH Low

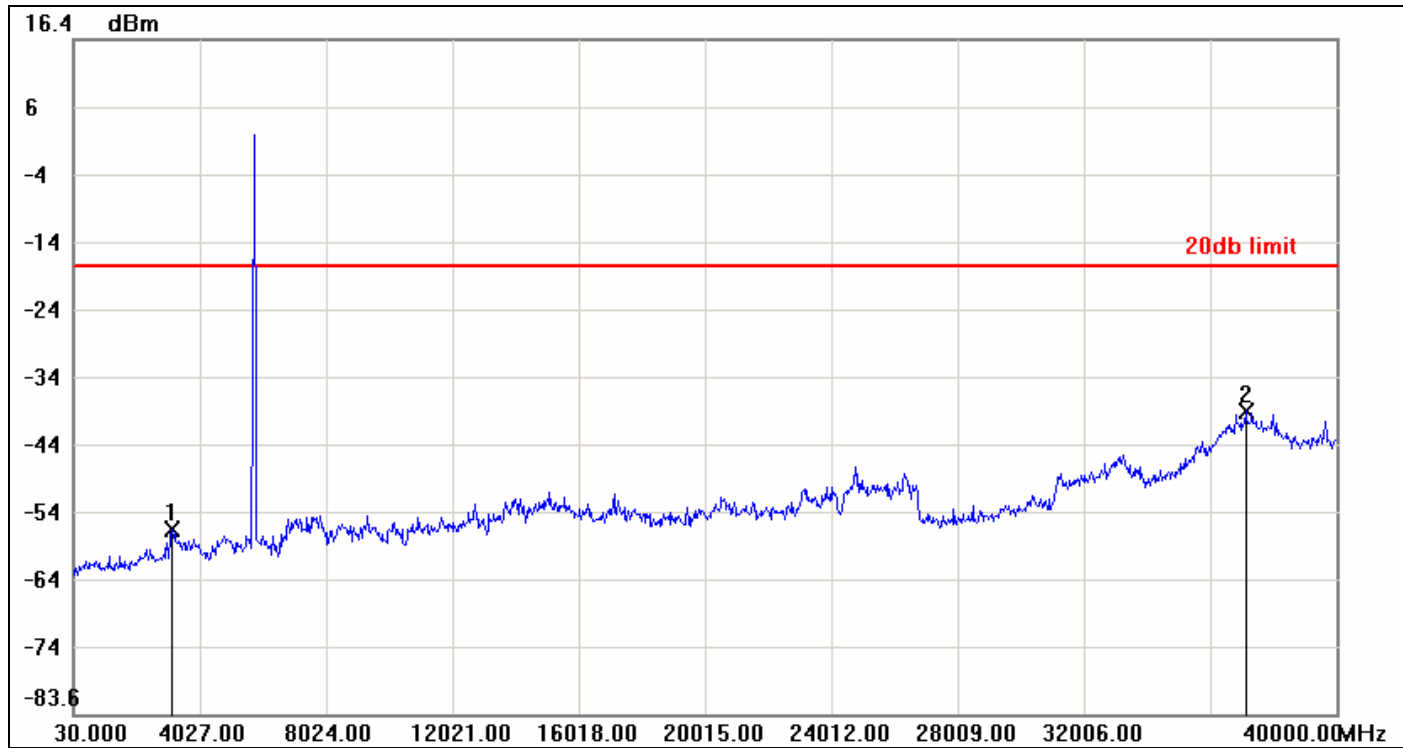

No.	Frequency(MHz)	Result(dBm)	Limit(dBm)	Margin(dBm)
1	3147.6600	-56.31	-17.18	-39.13
2	37122.1600	-38.74	-17.18	-21.56



### CH Mid

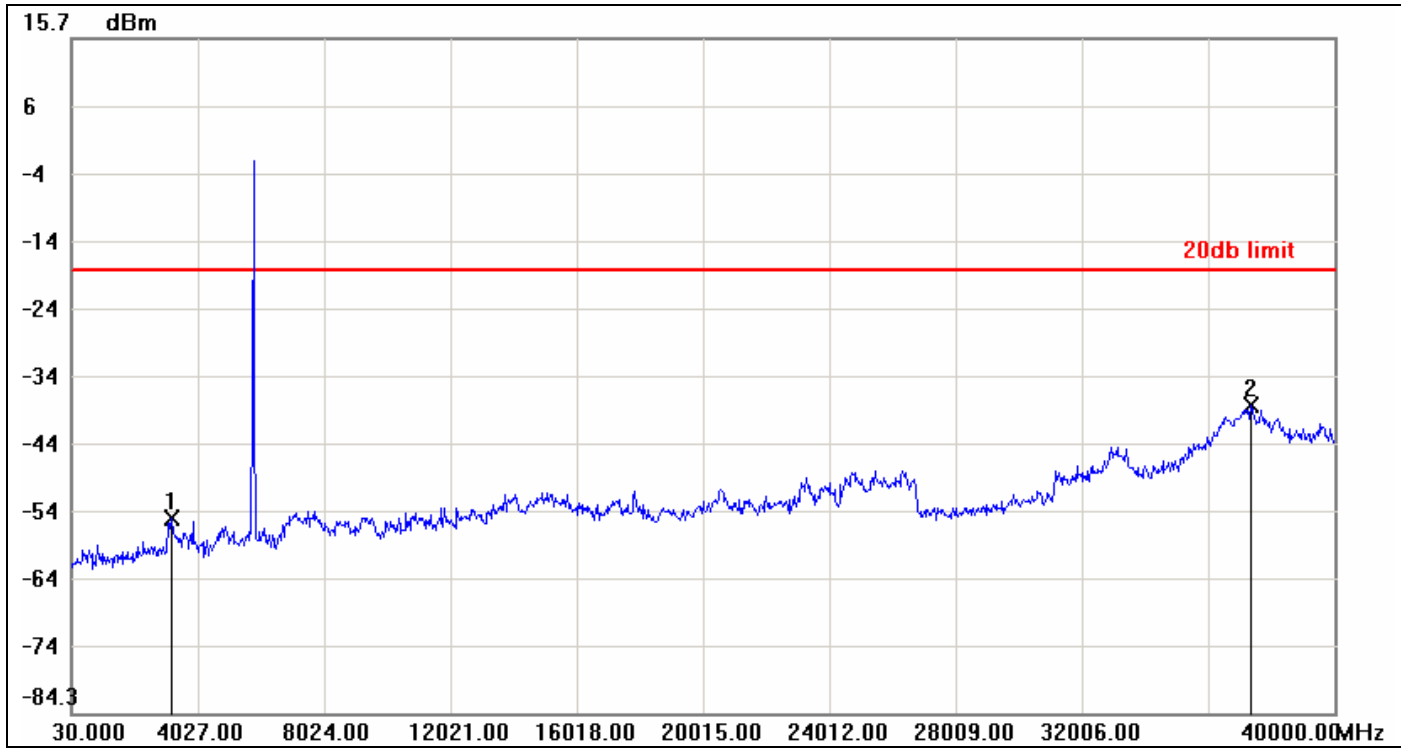

No.	Frequency(MHz)	Result(dBm)	Limit(dBm)	Margin(dBm)
1	3187.6300	-55.50	-18.79	-36.71
2	37361.9800	-38.57	-18.79	-19.78



### CH High

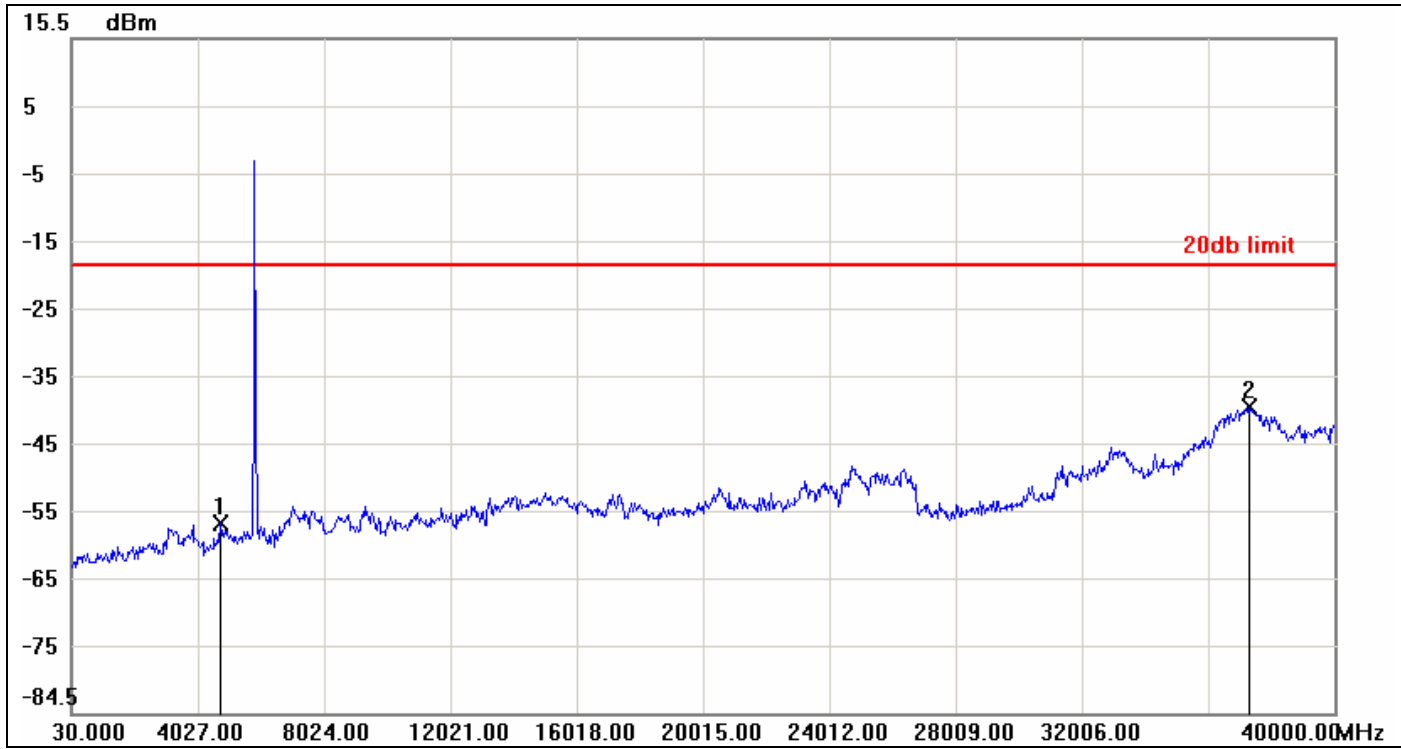

No.	Frequency(MHz)	Result(dBm)	Limit(dBm)	Margin(dBm)
1	4746.4600	-56.50	-18.17	-38.33
2	37322.0100	-39.13	-18.17	-20.96



IEEE 802.11n HT 20 MHz mode

CH Low

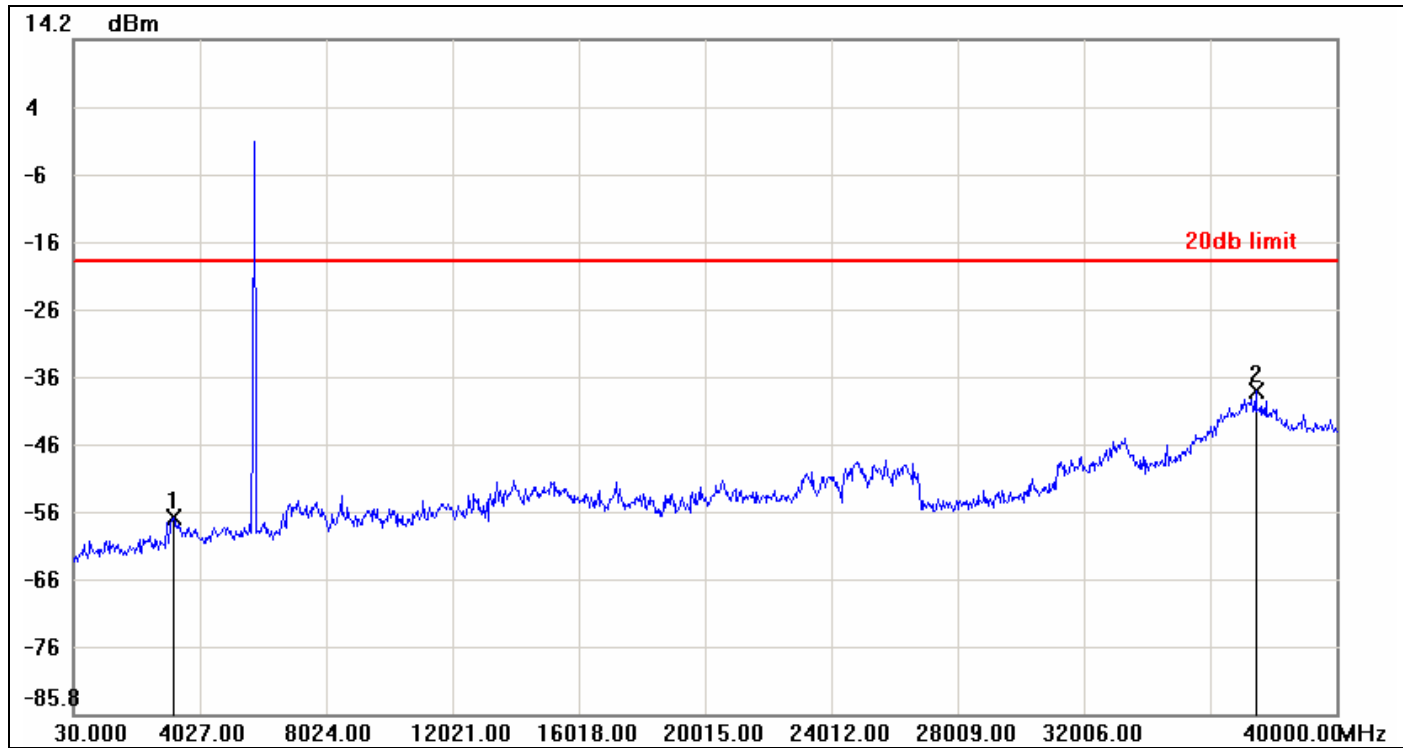

No.	Frequency(MHz)	Result(dBm)	Limit(dBm)	Margin(dBm)
1	3187.6300	-56.70	-18.69	-38.01
2	37441.9200	-37.84	-18.69	-19.15



### CH Mid



No.	Frequency(MHz)	Result(dBm)	Limit(dBm)	Margin(dBm)
1	3107.6900	-55.80	-20.08	-35.72
2	37242.0700	-38.53	-20.08	-18.45



### CH High

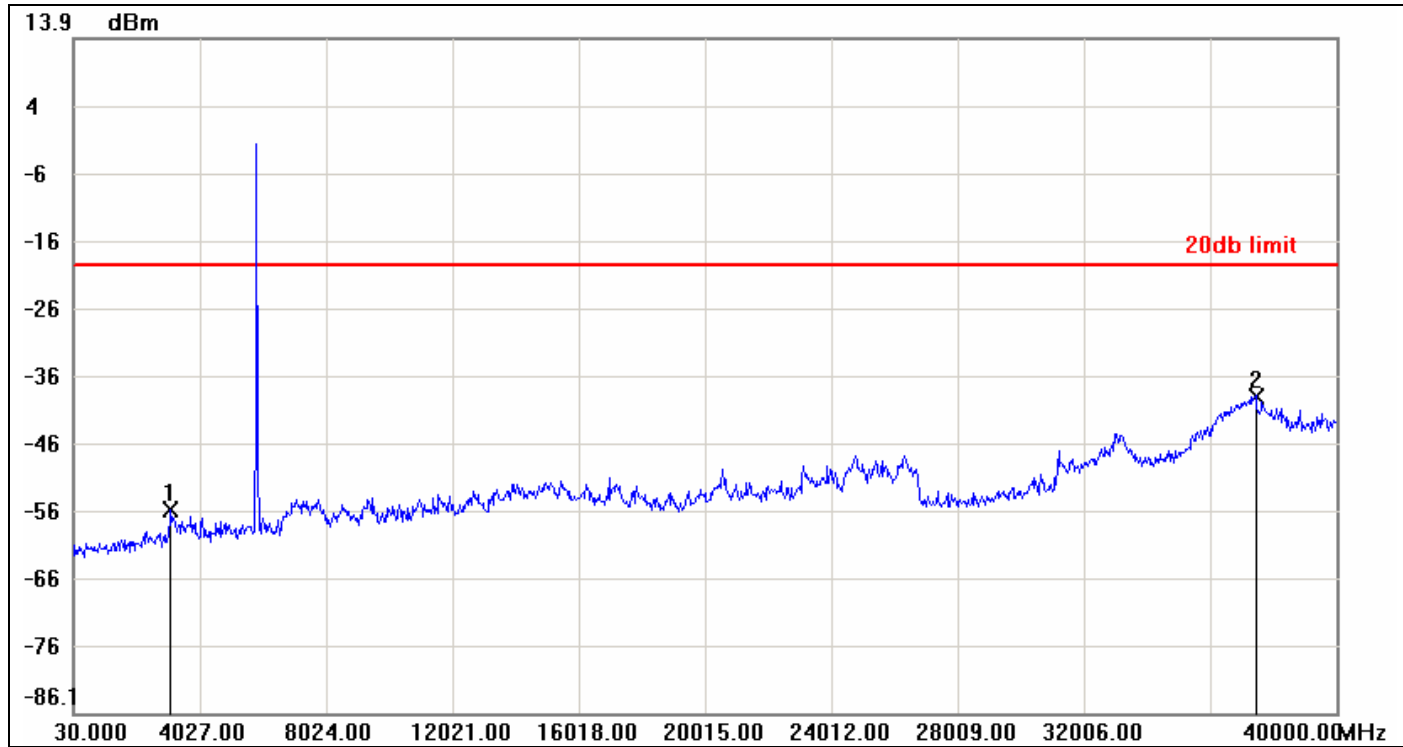

No.	Frequency(MHz)	Result(dBm)	Limit(dBm)	Margin(dBm)
1	3107.6900	-55.97	-19.66	-36.31
2	37441.9200	-39.11	-19.66	-19.45



IEEE 802.11n HT 40 MHz mode

CH Low

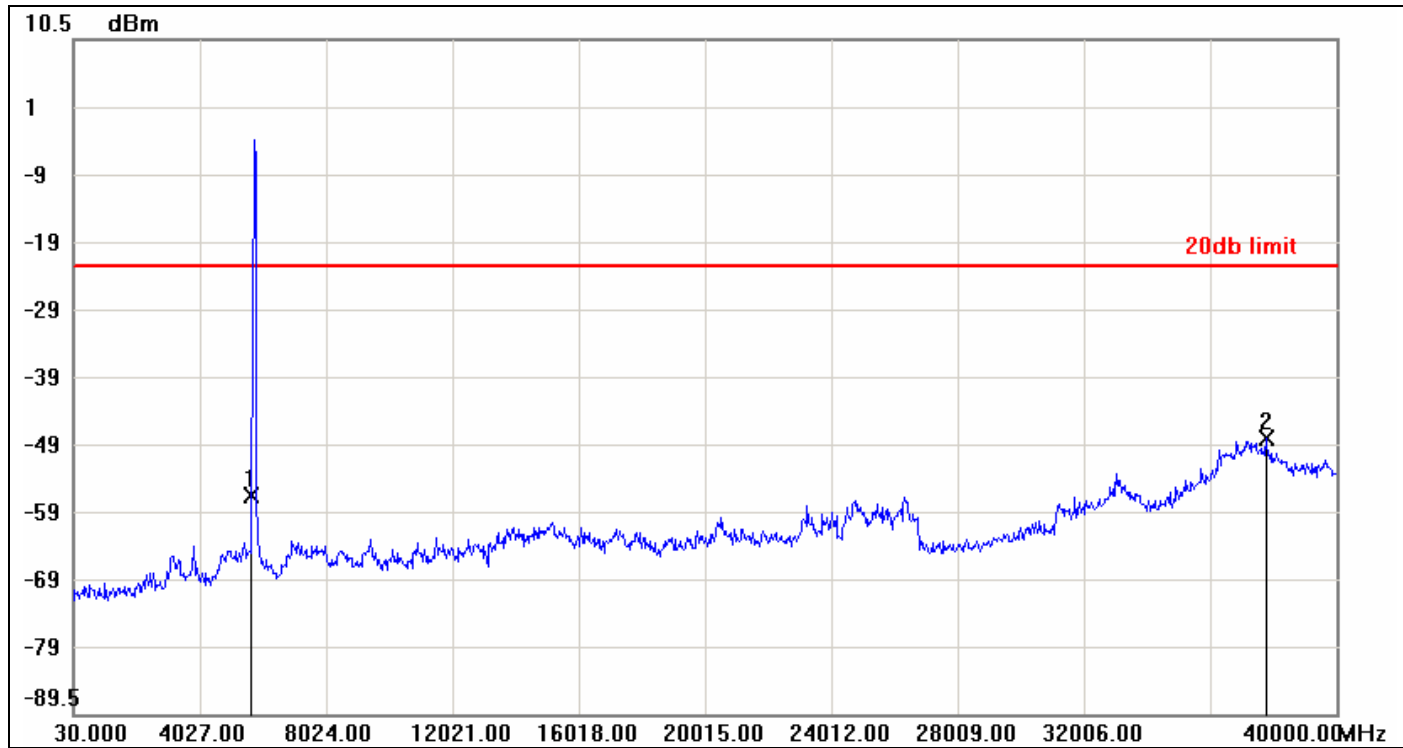

No.	Frequency(MHz)	Result(dBm)	Limit(dBm)	Margin(dBm)
1	5665.7700	-57.06	-23.18	-33.88
2	37761.6800	-48.49	-23.18	-25.31



### CH High

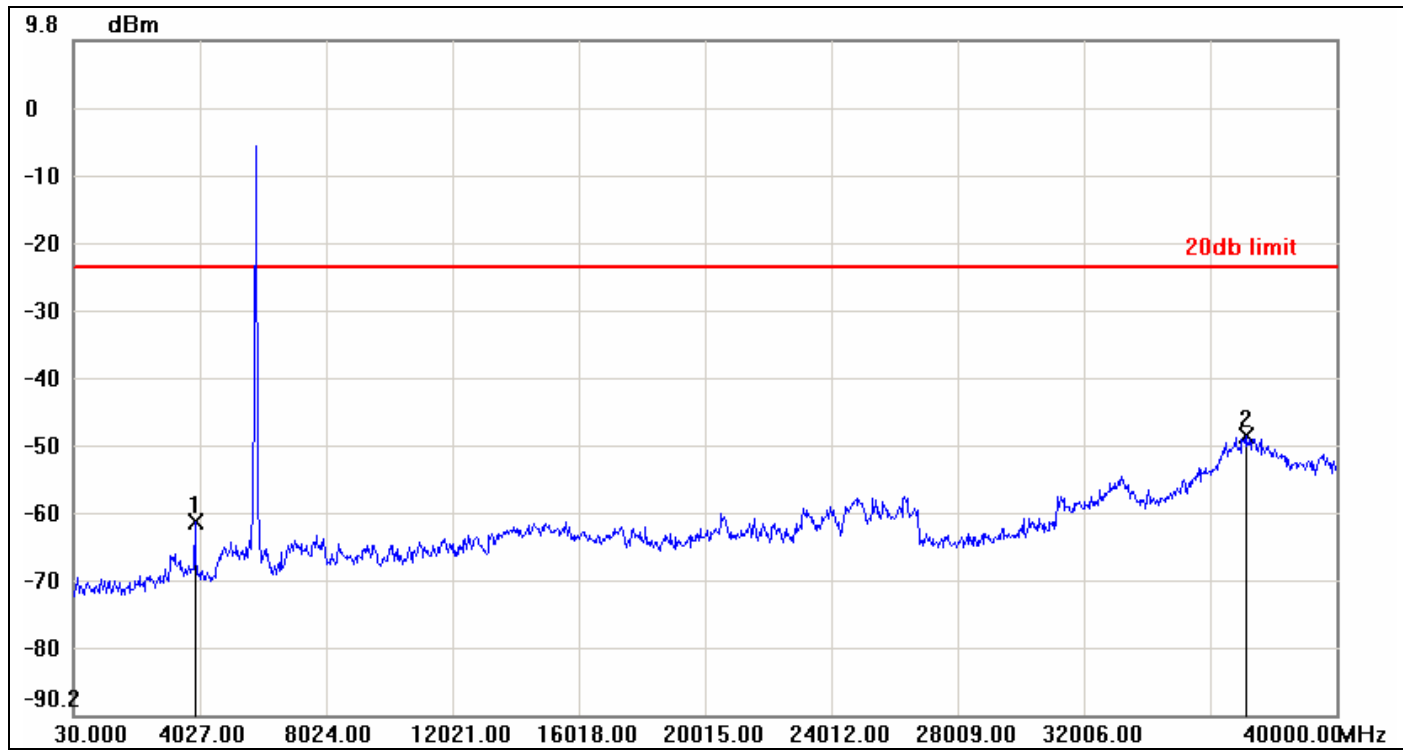

No.	Frequency(MHz)	Result(dBm)	Limit(dBm)	Margin(dBm)
1	3867.1200	-61.58	-23.78	-37.80
2	37122.1600	-48.86	-23.78	-25.08





## 7.7.2 Radiated Emissions

### LIMIT

1. Except as provided elsewhere in this Subpart, the emissions from an intentional radiator shall not exceed the field strength levels specified in the following table:

Frequency (MHz)	Field Strength ( $\mu\text{V}/\text{m}$ )	Measurement Distance (m)
30-88	100*	3
88-216	150*	3
216-960	200*	3
Above 960	500	3

**Remark:** Except as provided in paragraph (g), fundamental emissions from intentional radiators operating under this Section shall not be located in the frequency bands 54-72 MHz, 76-88 MHz, 174-216 MHz or 470-806 MHz. However, operation within these frequency bands is permitted under other sections of this Part, e.g., Sections 15.231 and 15.241.

2. In the above emission table, the tighter limit applies at the band edges.

Frequency (MHz)	Field Strength ( $\mu\text{V}/\text{m}$ at 3-meter)	Field Strength (dB $\mu\text{V}/\text{m}$ at 3-meter)
30-88	100	40
88-216	150	43.5
216-960	200	46
Above 960	500	54



### Test Configuration

#### 9kHz ~ 30MHz

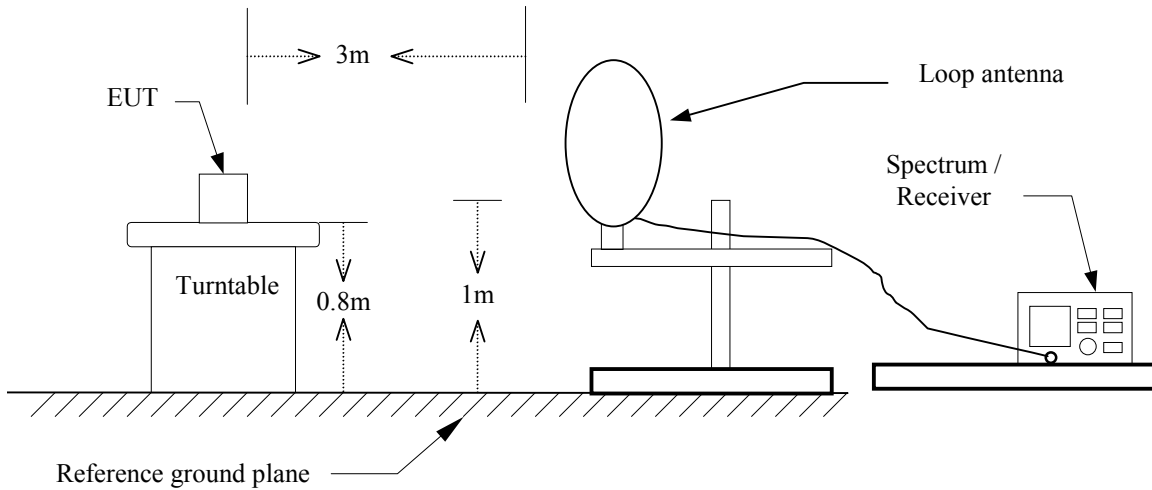

#### 30MHz ~ 1 GHz

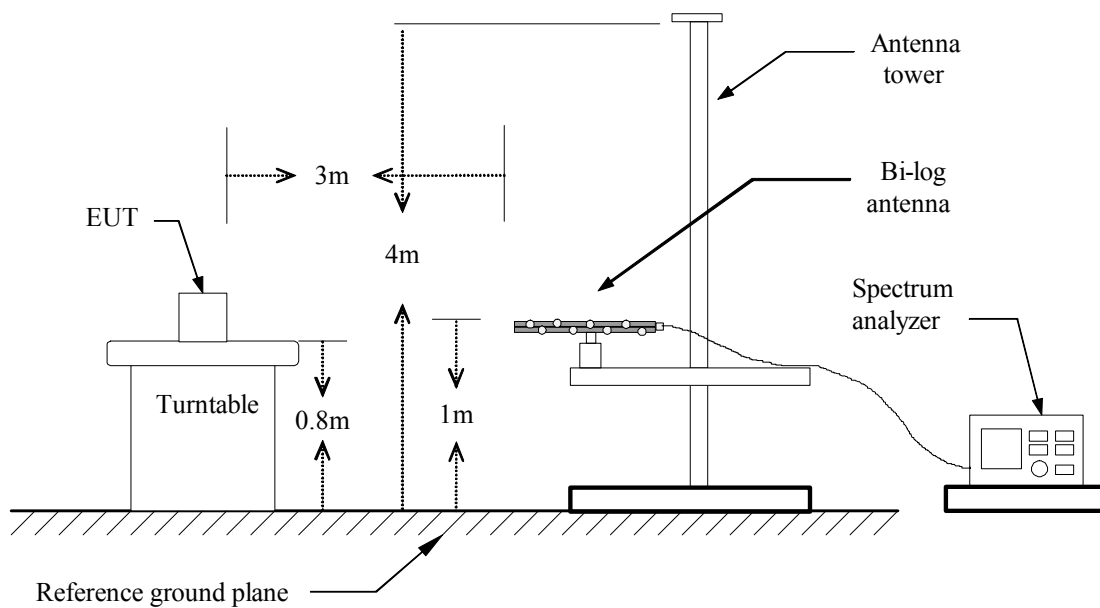



Above 1 GHz

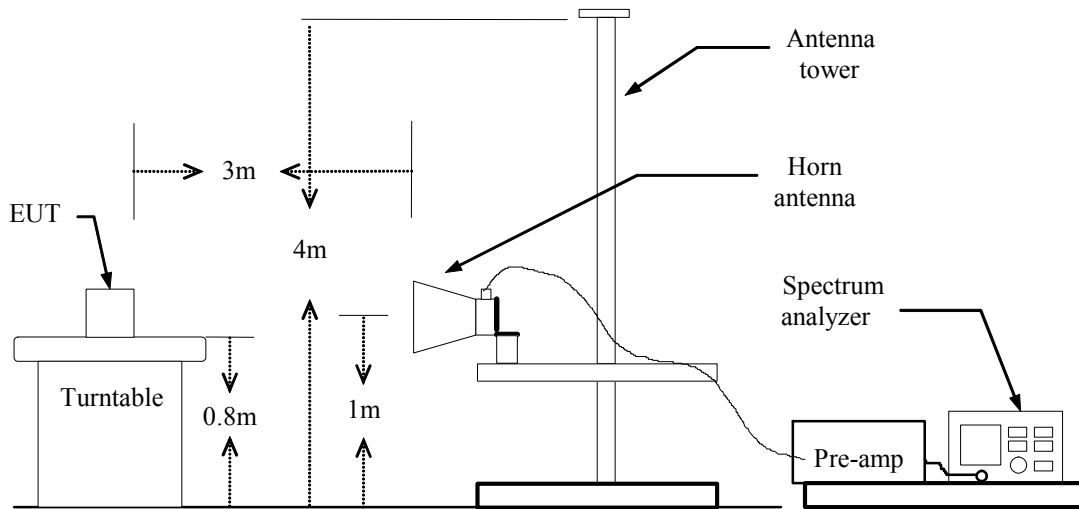



## **TEST PROCEDURE**

1. The EUT is placed on a turntable, which is 0.8m above ground plane.
2. The turntable shall be rotated for 360 degrees to determine the position of maximum emission level.
3. EUT is set 3m away from the receiving antenna, which is varied from 1m to 4m to find out the highest emissions.
4. Maximum procedure was performed on the six highest emissions to ensure EUT compliance.
5. And also, each emission was to be maximized by changing the polarization of receiving antenna both horizontal and vertical.
6. Set the spectrum analyzer in the following setting as:  
Below 1GHz:  
RBW=100kHz / VBW=300kHz / Sweep=AUTO  
Above 1GHz:  
(a) PEAK: RBW=VBW=1MHz / Sweep=AUTO  
(b) AVERAGE: RBW=1MHz / VBW=10Hz / Sweep=AUTO
7. Repeat above procedures until the measurements for all frequencies are complete.

**Below 1 GHz**

**Operation Mode:** Normal Link      **Test Date:** August 1, 2012  
**Temperature:** 28°C      **Tested by:** Waternil Guan  
**Humidity:** 62 % RH      **Polarity:** Ver. / Hor.

Frequency (MHz)	Reading (dBuV)	Correction Factor (dB/m)	Result (dBuV/m)	Limit (dBuV/m)	Margin (dB)	Remark	Ant. Pol. (H/V)
36.79	48.50	-10.64	37.86	40.00	-2.14	QP	V
150.28	52.60	-13.73	38.87	43.50	-4.63	Peak	V
348.16	54.52	-10.49	44.03	46.00	-1.97	Peak	V
474.26	50.12	-8.22	41.90	46.00	-4.10	QP	V
497.54	50.12	-7.74	42.38	46.00	-3.62	QP	V
928.22	40.84	-1.20	39.65	46.00	-6.35	Peak	V
125.06	47.91	-13.27	34.64	43.50	-8.86	Peak	H
350.10	54.26	-10.46	42.80	46.00	-2.20	QP	H
450.01	48.06	-8.72	39.34	46.00	-6.66	Peak	H
494.63	48.19	-7.80	40.39	46.00	-5.61	Peak	H
666.32	46.45	-5.26	41.18	46.00	-4.82	Peak	H
928.22	42.29	-1.20	41.10	46.00	-4.90	Peak	H

**Remark:**

1. Measuring frequencies from 30 MHz to the 1GHz.
2. Radiated emissions measured in frequency range from 30 MHz to 1000MHz were made with an instrument using peak/quasi-peak detector mode.
3. Quasi-peak test would be performed if the peak result were greater than the quasi-peak limit or as required by the applicant.
4. Data of measurement within this frequency range shown " --- " in the table above means the reading of emissions are attenuated more than 20dB below the permissible limits or the field strength is too small to be measured.
5. Measurements above show only up to 6 maximum emissions noted, or would be lesser, with " N/A " remark, if no specific emissions from the EUT are recorded (ie: margin>20dB from the applicable limit) and considered that's already beyond the background noise floor.
6.  $Margin (dB) = Remark\ result (dBuV/m) - Quasi-peak\ limit (dBuV/m)$ .

**Above 1 GHz****Operation Mode:** Tx / IEEE 802.11b mode / CH Low**Test Date:** June 16, 2012**Temperature:** 26°C**Tested by:** Alan Wu**Humidity:** 53% RH**Polarity:** Ver. / Hor.

Frequency (MHz)	Reading (Peak) (dBuV)	Reading (Average) (dBuV)	Correction Factor (dB/m)	Result (Peak) (dBuV/m)	Result (Average) (dBuV/m)	Limit (Peak) (dBuV/m)	Limit (Average) (dBuV/m)	Margin (dB)	Remark	Ant. Pol. (H/V)
1038.00	55.12	---	-3.76	51.37	---	74.00	54.00	-2.63	Peak	V
1150.00	55.22	---	-3.40	51.82	---	74.00	54.00	-2.18	Peak	V
1432.00	54.87	---	-2.49	52.38	---	74.00	54.00	-1.62	Peak	V
1684.00	53.13	---	-0.62	52.51	---	74.00	54.00	-1.49	Peak	V
4860.00	39.25	---	9.58	48.82	---	74.00	54.00	-5.18	Peak	V
6525.00	38.28	---	12.38	50.65	---	74.00	54.00	-3.35	Peak	V
1064.00	55.19	---	-3.67	51.52	---	74.00	54.00	-2.48	Peak	H
1190.00	54.98	---	-3.27	51.71	---	74.00	54.00	-2.29	Peak	H
1386.00	54.40	---	-2.64	51.77	---	74.00	54.00	-2.23	Peak	H
1680.00	53.10	---	-0.65	52.45	---	74.00	54.00	-1.55	Peak	H
4950.00	39.58	---	9.80	49.37	---	74.00	54.00	-4.63	Peak	H
5805.00	39.59	---	11.40	50.99	---	74.00	54.00	-3.01	Peak	H

**Remark:**

1. Measuring frequencies from 1 GHz to the 10th harmonic of highest fundamental frequency.
2. Radiated emissions measured in frequency above 1000MHz were made with an instrument using peak/average detector mode.
3. Average test would be performed if the peak result were greater than the average limit or as required by the applicant.
4. Data of measurement within this frequency range shown " --- " in the table above means the reading of emissions are attenuated more than 20dB below the permissible limits or the field strength is too small to be measured.
5. Measurements above show only up to 6 maximum emissions noted, or would be lesser, with " N/A " remark, if no specific emissions from the EUT are recorded (ie: margin > 20dB from the applicable limit) and considered that's already beyond the background noise floor.
6. Margin (dB) = Remark result (dBuV/m) – Average limit (dBuV/m).

**Operation Mode:** Tx / IEEE 802.11b mode / CH Mid**Test Date:** June 16, 2012**Temperature:** 26°C**Tested by:** Alan Wu**Humidity:** 53% RH**Polarity:** Ver. / Hor.

Frequency (MHz)	Reading (Peak) (dBuV)	Reading (Average) (dBuV)	Correction Factor (dB/m)	Result (Peak) (dBuV/m)	Result (Average) (dBuV/m)	Limit (Peak) (dBuV/m)	Limit (Average) (dBuV/m)	Margin (dB)	Remark	Ant. Pol. (H/V)
1030.00	54.89	---	-3.78	51.10	---	74.00	54.00	-2.90	Peak	V
1200.00	54.02	---	-3.24	50.78	---	74.00	54.00	-3.22	Peak	V
1350.00	53.90	---	-2.75	51.15	---	74.00	54.00	-2.85	Peak	V
1662.00	53.66	---	-0.82	52.84	---	74.00	54.00	-1.16	Peak	V
4455.00	40.10	---	8.54	48.64	---	74.00	54.00	-5.36	Peak	V
6060.00	38.33	---	11.88	50.21	---	74.00	54.00	-3.79	Peak	V
1060.00	54.01	---	-3.69	50.32	---	74.00	54.00	-3.68	Peak	H
1224.00	54.37	---	-3.16	51.21	---	74.00	54.00	-2.79	Peak	H
1452.00	54.36	---	-2.42	51.94	---	74.00	54.00	-2.06	Peak	H
1682.00	53.15	---	-0.64	52.52	---	74.00	54.00	-1.48	Peak	H
4920.00	38.99	---	9.72	48.72	---	74.00	54.00	-5.28	Peak	H
6540.00	38.53	---	12.37	50.90	---	74.00	54.00	-3.10	Peak	H

**Remark:**

1. Measuring frequencies from 1 GHz to the 10th harmonic of highest fundamental frequency.
2. Radiated emissions measured in frequency above 1000MHz were made with an instrument using peak/average detector mode.
3. Average test would be performed if the peak result were greater than the average limit or as required by the applicant.
4. Data of measurement within this frequency range shown " --- " in the table above means the reading of emissions are attenuated more than 20dB below the permissible limits or the field strength is too small to be measured.
5. Measurements above show only up to 6 maximum emissions noted, or would be lesser, with " N/A " remark, if no specific emissions from the EUT are recorded (ie: margin>20dB from the applicable limit) and considered that's already beyond the background noise floor.
6. Margin (dB) = Remark result (dBuV/m) – Average limit (dBuV/m).

**Operation Mode:** Tx / IEEE 802.11b mode / CH High**Test Date:** June 16, 2012**Temperature:** 26°C**Tested by:** Alan Wu**Humidity:** 53% RH**Polarity:** Ver. / Hor.

Frequency (MHz)	Reading (Peak) (dBuV)	Reading (Average) (dBuV)	Correction Factor (dB/m)	Result (Peak) (dBuV/m)	Result (Average) (dBuV/m)	Limit (Peak) (dBuV/m)	Limit (Average) (dBuV/m)	Margin (dB)	Remark	Ant. Pol. (H/V)
1050.00	54.86	---	-3.72	51.14	---	74.00	54.00	-2.86	Peak	V
1296.00	55.21	---	-2.93	52.28	---	74.00	54.00	-1.72	Peak	v
1484.00	53.94	---	-2.32	51.62	---	74.00	54.00	-2.38	Peak	V
1662.00	52.94	---	-0.82	52.13	---	74.00	54.00	-1.87	Peak	V
4920.00	39.89	---	9.72	49.61	---	74.00	54.00	-4.39	Peak	V
6510.00	38.23	---	12.38	50.61	---	74.00	54.00	-3.39	Peak	V
1062.00	54.80	---	-3.68	51.12	---	74.00	54.00	-2.88	Peak	H
1212.00	55.59	---	-3.20	52.39	---	74.00	54.00	-1.61	Peak	H
1412.00	53.23	---	-2.55	50.67	---	74.00	54.00	-3.33	Peak	H
1652.00	53.00	---	-0.91	52.10	---	74.00	54.00	-1.90	Peak	H
4875.00	39.23	---	9.61	48.84	---	74.00	54.00	-5.16	Peak	H
6600.00	38.34	---	12.36	50.70	---	74.00	54.00	-3.30	Peak	H

**Remark:**

1. Measuring frequencies from 1 GHz to the 10th harmonic of highest fundamental frequency.
2. Radiated emissions measured in frequency above 1000MHz were made with an instrument using peak/average detector mode.
3. Average test would be performed if the peak result were greater than the average limit or as required by the applicant.
4. Data of measurement within this frequency range shown " --- " in the table above means the reading of emissions are attenuated more than 20dB below the permissible limits or the field strength is too small to be measured.
5. Measurements above show only up to 6 maximum emissions noted, or would be lesser, with " N/A " remark, if no specific emissions from the EUT are recorded (ie: margin>20dB from the applicable limit) and considered that's already beyond the background noise floor.
6. Margin (dB) = Remark result (dBuV/m) – Average limit (dBuV/m).



**Operation Mode:** Tx / IEEE 802.11g mode / CH Low**Test Date:** June 16, 2012**Temperature:** 26°C**Tested by:** Alan Wu**Humidity:** 53% RH**Polarity:** Ver. / Hor.

Frequency (MHz)	Reading (Peak) (dBuV)	Reading (Average) (dBuV)	Correction Factor (dB/m)	Result (Peak) (dBuV/m)	Result (Average) (dBuV/m)	Limit (Peak) (dBuV/m)	Limit (Average) (dBuV/m)	Margin (dB)	Remark	Ant. Pol. (H/V)
1020.00	54.48	---	-3.82	50.67	---	74.00	54.00	-3.33	Peak	V
1218.00	54.49	---	-3.18	51.31	---	74.00	54.00	-2.69	Peak	V
1392.00	53.99	---	-2.62	51.37	---	74.00	54.00	-2.63	Peak	V
1586.00	53.55	---	-1.50	52.05	---	74.00	54.00	-1.95	Peak	V
1750.00	52.59	---	-0.02	52.56	---	74.00	54.00	-1.44	Peak	V
6000.00	39.34	---	11.81	51.15	---	74.00	54.00	-2.85	Peak	V
1056.00	55.76	---	-3.70	52.06	---	74.00	54.00	-1.94	Peak	H
1246.00	54.00	---	-3.09	50.91	---	74.00	54.00	-3.09	Peak	H
1452.00	52.48	---	-2.42	50.05	---	74.00	54.00	-3.95	Peak	H
1716.00	52.95	---	-0.33	52.62	---	74.00	54.00	-1.38	Peak	H
4860.00	39.30	---	9.58	48.88	---	74.00	54.00	-5.12	Peak	H
7005.00	39.19	---	12.31	51.50	---	74.00	54.00	-2.50	Peak	H

**Remark:**

1. Measuring frequencies from 1 GHz to the 10th harmonic of highest fundamental frequency.
2. Radiated emissions measured in frequency above 1000MHz were made with an instrument using peak/average detector mode.
3. Average test would be performed if the peak result were greater than the average limit or as required by the applicant.
4. Data of measurement within this frequency range shown " --- " in the table above means the reading of emissions are attenuated more than 20dB below the permissible limits or the field strength is too small to be measured.
5. Measurements above show only up to 6 maximum emissions noted, or would be lesser, with " N/A " remark, if no specific emissions from the EUT are recorded (ie: margin>20dB from the applicable limit) and considered that's already beyond the background noise floor.
6. Margin (dB) = Remark result (dBuV/m) – Average limit (dBuV/m).

**Operation Mode:** Tx / IEEE 802.11g mode / CH Mid**Test Date:** June 16, 2012**Temperature:** 26°C**Tested by:** Alan Wu**Humidity:** 53% RH**Polarity:** Ver. / Hor.

Frequency (MHz)	Reading (Peak) (dBuV)	Reading (Average) (dBuV)	Correction Factor (dB/m)	Result (Peak) (dBuV/m)	Result (Average) (dBuV/m)	Limit (Peak) (dBuV/m)	Limit (Average) (dBuV/m)	Margin (dB)	Remark	Ant. Pol. (H/V)
1048.00	54.78	---	-3.73	51.05	---	74.00	54.00	-2.95	Peak	V
1298.00	54.70	---	-2.92	51.78	---	74.00	54.00	-2.22	Peak	V
1450.00	52.55	---	-2.43	50.11	---	74.00	54.00	-3.89	Peak	V
1600.00	53.35	---	-1.37	51.98	---	74.00	54.00	-2.02	Peak	V
4200.00	40.28	---	7.68	47.95	---	74.00	54.00	-6.05	Peak	V
5400.00	38.04	---	10.58	48.62	---	74.00	54.00	-5.38	Peak	V
1098.00	55.46	---	-3.56	51.89	---	74.00	54.00	-2.11	Peak	H
1234.00	53.94	---	-3.13	50.81	---	74.00	54.00	-3.19	Peak	H
1452.00	53.77	---	-2.42	51.35	---	74.00	54.00	-2.65	Peak	H
1694.00	52.49	---	-0.53	51.96	---	74.00	54.00	-2.04	Peak	H
5235.00	39.34	---	10.31	49.65	---	74.00	54.00	-4.35	Peak	H
6285.00	38.53	---	12.13	50.67	---	74.00	54.00	-3.33	Peak	H

**Remark:**

1. Measuring frequencies from 1 GHz to the 10th harmonic of highest fundamental frequency.
2. Radiated emissions measured in frequency above 1000MHz were made with an instrument using peak/average detector mode.
3. Average test would be performed if the peak result were greater than the average limit or as required by the applicant.
4. Data of measurement within this frequency range shown " --- " in the table above means the reading of emissions are attenuated more than 20dB below the permissible limits or the field strength is too small to be measured.
5. Measurements above show only up to 6 maximum emissions noted, or would be lesser, with " N/A " remark, if no specific emissions from the EUT are recorded (ie: margin>20dB from the applicable limit) and considered that's already beyond the background noise floor.
6. Margin (dB) = Remark result (dBuV/m) – Average limit (dBuV/m).

**Operation Mode:** Tx / IEEE 802.11g mode / CH High**Test Date:** June 16, 2012**Temperature:** 26°C**Tested by:** Alan Wu**Humidity:** 53% RH**Polarity:** Ver. / Hor.

Frequency (MHz)	Reading (Peak) (dBuV)	Reading (Average) (dBuV)	Correction Factor (dB/m)	Result (Peak) (dBuV/m)	Result (Average) (dBuV/m)	Limit (Peak) (dBuV/m)	Limit (Average) (dBuV/m)	Margin (dB)	Remark	Ant. Pol. (H/V)
1060.00	55.59	---	-3.69	51.91	---	74.00	54.00	-2.09	Peak	V
1326.00	54.52	---	-2.83	51.69	---	74.00	54.00	-2.31	Peak	V
1544.00	53.38	---	-1.87	51.51	---	74.00	54.00	-2.49	Peak	V
1756.00	52.72	---	0.03	52.75	---	74.00	54.00	-1.25	Peak	V
4905.00	38.83	---	9.69	48.52	---	74.00	54.00	-5.48	Peak	V
6510.00	38.29	---	12.38	50.66	---	74.00	54.00	-3.34	Peak	V
1108.00	55.19	---	-3.53	51.66	---	74.00	54.00	-2.34	Peak	H
1302.00	53.88	---	-2.91	50.98	---	74.00	54.00	-3.02	Peak	H
1452.00	53.45	---	-2.42	51.03	---	74.00	54.00	-2.97	Peak	H
1664.00	53.55	---	-0.80	52.75	---	74.00	54.00	-1.25	Peak	H
4230.00	40.05	---	7.78	47.83	---	74.00	54.00	-6.17	Peak	H
5730.00	38.97	---	11.24	50.21	---	74.00	54.00	-3.79	Peak	H

**Remark:**

1. Measuring frequencies from 1 GHz to the 10th harmonic of highest fundamental frequency.
2. Radiated emissions measured in frequency above 1000MHz were made with an instrument using peak/average detector mode.
3. Average test would be performed if the peak result were greater than the average limit or as required by the applicant.
4. Data of measurement within this frequency range shown " --- " in the table above means the reading of emissions are attenuated more than 20dB below the permissible limits or the field strength is too small to be measured.
5. Measurements above show only up to 6 maximum emissions noted, or would be lesser, with " N/A " remark, if no specific emissions from the EUT are recorded (ie: margin > 20dB from the applicable limit) and considered that's already beyond the background noise floor.
6. Margin (dB) = Remark result (dBuV/m) – Average limit (dBuV/m).



**Operation Mode:** TX / IEEE 802.11n HT 20 MHz mode  
/ CH Low

**Test Date:** June 16, 2012

**Temperature:** 26°C

**Tested by:** Alan Wu

**Humidity:** 53% RH

**Polarity:** Ver. / Hor.

Frequency (MHz)	Reading (Peak) (dBuV)	Reading (Average) (dBuV)	Correction Factor (dB/m)	Result (Peak) (dBuV/m)	Result (Average) (dBuV/m)	Limit (Peak) (dBuV/m)	Limit (Average) (dBuV/m)	Margin (dB)	Remark	Ant. Pol. (H/V)
1044.00	54.81	---	-3.74	51.07	---	74.00	54.00	-2.93	Peak	V
1300.00	54.20	---	-2.91	51.29	---	74.00	54.00	-2.71	Peak	V
1574.00	53.15	---	-1.61	51.54	---	74.00	54.00	-2.46	Peak	V
1728.00	53.00	---	-0.22	52.77	---	74.00	54.00	-1.23	Peak	V
4612.50	39.40	---	8.97	48.36	---	74.00	54.00	-5.64	Peak	V
6382.50	39.46	---	12.25	51.70	---	74.00	54.00	-2.30	Peak	V
1006.00	55.46	---	-3.86	51.60	---	74.00	54.00	-2.40	Peak	H
1220.00	53.90	---	-3.17	50.73	---	74.00	54.00	-3.27	Peak	H
1400.00	53.85	---	-2.59	51.26	---	74.00	54.00	-2.74	Peak	H
1626.00	53.13	---	-1.14	51.99	---	74.00	54.00	-2.01	Peak	H
4785.00	39.73	---	9.39	49.12	---	74.00	54.00	-4.88	Peak	H
5625.00	39.52	---	11.02	50.53	---	74.00	54.00	-3.47	Peak	H

**Remark:**

1. Measuring frequencies from 1 GHz to the 10th harmonic of highest fundamental frequency.
2. Radiated emissions measured in frequency above 1000MHz were made with an instrument using peak/average detector mode.
3. Average test would be performed if the peak result were greater than the average limit or as required by the applicant.
4. Data of measurement within this frequency range shown " --- " in the table above means the reading of emissions are attenuated more than 20dB below the permissible limits or the field strength is too small to be measured.
5. Measurements above show only up to 6 maximum emissions noted, or would be lesser, with " N/A " remark, if no specific emissions from the EUT are recorded (ie: margin>20dB from the applicable limit) and considered that's already beyond the background noise floor.
6. Margin (dB) = Remark result (dBuV/m) – Average limit (dBuV/m).



**Operation Mode:** TX / IEEE 802.11n HT 20 MHz mode  
/ CH Mid

**Test Date:** June 16, 2012

**Temperature:** 26°C

**Tested by:** Alan Wu

**Humidity:** 53% RH

**Polarity:** Ver. / Hor.

Frequency (MHz)	Reading (Peak) (dBuV)	Reading (Average) (dBuV)	Correction Factor (dB/m)	Result (Peak) (dBuV/m)	Result (Average) (dBuV/m)	Limit (Peak) (dBuV/m)	Limit (Average) (dBuV/m)	Margin (dB)	Remark	Ant. Pol. (H/V)
1026.00	55.17	---	-3.80	51.37	---	74.00	54.00	-2.63	Peak	V
1210.00	53.56	---	-3.20	50.36	---	74.00	54.00	-3.64	Peak	V
1414.00	53.68	---	-2.55	51.14	---	74.00	54.00	-2.86	Peak	V
1650.00	53.38	---	-0.92	52.46	---	74.00	54.00	-1.54	Peak	V
4875.00	39.07	---	9.61	48.68	---	74.00	54.00	-5.32	Peak	V
6457.50	39.78	---	12.33	52.11	---	74.00	54.00	-1.89	Peak	V
1026.00	53.87	---	-3.80	50.08	---	74.00	54.00	-3.92	Peak	H
1218.00	54.50	---	-3.18	51.32	---	74.00	54.00	-2.68	Peak	H
1392.00	53.07	---	-2.62	50.45	---	74.00	54.00	-3.55	Peak	H
1570.00	53.53	---	-1.64	51.88	---	74.00	54.00	-2.12	Peak	H
4515.00	40.33	---	8.73	49.06	---	74.00	54.00	-4.94	Peak	H
5827.50	38.80	---	11.44	50.24	---	74.00	54.00	-3.76	Peak	H

**Remark:**

1. Measuring frequencies from 1 GHz to the 10th harmonic of highest fundamental frequency.
2. Radiated emissions measured in frequency above 1000MHz were made with an instrument using peak/average detector mode.
3. Average test would be performed if the peak result were greater than the average limit or as required by the applicant.
4. Data of measurement within this frequency range shown " --- " in the table above means the reading of emissions are attenuated more than 20dB below the permissible limits or the field strength is too small to be measured.
5. Measurements above show only up to 6 maximum emissions noted, or would be lesser, with " N/A " remark, if no specific emissions from the EUT are recorded (ie: margin>20dB from the applicable limit) and considered that's already beyond the background noise floor.
6. Margin (dB) = Remark result (dBuV/m) – Average limit (dBuV/m).



**Operation Mode:** TX / IEEE 802.11n HT 20 MHz mode  
/ CH High

**Test Date:** June 16, 2012

**Temperature:** 26°C

**Tested by:** Alan Wu

**Humidity:** 53% RH

**Polarity:** Ver. / Hor.

Frequency (MHz)	Reading (Peak) (dBuV)	Reading (Average) (dBuV)	Correction Factor (dB/m)	Result (Peak) (dBuV/m)	Result (Average) (dBuV/m)	Limit (Peak) (dBuV/m)	Limit (Average) (dBuV/m)	Margin (dB)	Remark	Ant. Pol. (H/V)
1044.00	55.13	---	-3.74	51.39	---	74.00	54.00	-2.61	Peak	V
1242.00	55.39	---	-3.10	52.29	---	74.00	54.00	-1.71	Peak	V
1434.00	54.01	---	-2.48	51.53	---	74.00	54.00	-2.47	Peak	V
1650.00	52.82	---	-0.92	51.90	---	74.00	54.00	-2.10	Peak	V
4762.50	39.30	---	9.34	48.64	---	74.00	54.00	-5.36	Peak	V
6015.00	38.71	---	11.83	50.54	---	74.00	54.00	-3.46	Peak	V
1110.00	54.95	---	-3.53	51.42	---	74.00	54.00	-2.58	Peak	H
1206.00	53.89	---	-3.22	50.68	---	74.00	54.00	-3.32	Peak	H
1336.00	53.46	---	-2.80	50.67	---	74.00	54.00	-3.33	Peak	H
1520.00	54.82	---	-2.09	52.73	---	74.00	54.00	-1.27	Peak	H
5055.00	39.51	---	10.01	49.52	---	74.00	54.00	-4.48	Peak	H
6007.50	38.90	---	11.82	50.72	---	74.00	54.00	-3.28	Peak	H

**Remark:**

1. Measuring frequencies from 1 GHz to the 10th harmonic of highest fundamental frequency.
2. Radiated emissions measured in frequency above 1000MHz were made with an instrument using peak/average detector mode.
3. Average test would be performed if the peak result were greater than the average limit or as required by the applicant.
4. Data of measurement within this frequency range shown " --- " in the table above means the reading of emissions are attenuated more than 20dB below the permissible limits or the field strength is too small to be measured.
5. Measurements above show only up to 6 maximum emissions noted, or would be lesser, with " N/A " remark, if no specific emissions from the EUT are recorded (ie: margin>20dB from the applicable limit) and considered that's already beyond the background noise floor.
6. Margin (dB) = Remark result (dBuV/m) – Average limit (dBuV/m).



**Operation Mode:** TX / IEEE 802.11n HT 40 MHz mode  
/ CH Low

**Test Date:** June 16, 2012

**Temperature:** 26°C

**Tested by:** Alan Wu

**Humidity:** 53% RH

**Polarity:** Ver. / Hor.

Frequency (MHz)	Reading (Peak) (dBuV)	Reading (Average) (dBuV)	Correction Factor (dB/m)	Result (Peak) (dBuV/m)	Result (Average) (dBuV/m)	Limit (Peak) (dBuV/m)	Limit (Average) (dBuV/m)	Margin (dB)	Remark	Ant. Pol. (H/V)
1092.00	54.66	---	-3.58	51.07	---	74.00	54.00	-2.93	Peak	V
1328.00	54.95	---	-2.82	52.13	---	74.00	54.00	-1.87	Peak	V
1536.00	54.42	---	-1.95	52.47	---	74.00	54.00	-1.53	Peak	V
1728.00	51.78	---	-0.22	51.56	---	74.00	54.00	-2.44	Peak	V
4522.50	40.19	---	8.75	48.94	---	74.00	54.00	-5.06	Peak	V
5760.00	39.10	---	11.30	50.40	---	74.00	54.00	-3.60	Peak	V
1068.00	54.19	---	-3.66	50.53	---	74.00	54.00	-3.47	Peak	H
1256.00	54.01	---	-3.06	50.95	---	74.00	54.00	-3.05	Peak	H
1436.00	53.76	---	-2.48	51.29	---	74.00	54.00	-2.71	Peak	H
1654.00	52.78	---	-0.89	51.89	---	74.00	54.00	-2.11	Peak	H
4800.00	39.24	---	9.43	48.67	---	74.00	54.00	-5.33	Peak	H
6465.00	38.27	---	12.34	50.61	---	74.00	54.00	-3.39	Peak	H

**Remark:**

1. Measuring frequencies from 1 GHz to the 10th harmonic of highest fundamental frequency.
2. Radiated emissions measured in frequency above 1000MHz were made with an instrument using peak/average detector mode.
3. Average test would be performed if the peak result were greater than the average limit or as required by the applicant.
4. Data of measurement within this frequency range shown " --- " in the table above means the reading of emissions are attenuated more than 20dB below the permissible limits or the field strength is too small to be measured.
5. Measurements above show only up to 6 maximum emissions noted, or would be lesser, with " N/A " remark, if no specific emissions from the EUT are recorded (ie: margin>20dB from the applicable limit) and considered that's already beyond the background noise floor.
6. Margin (dB) = Remark result (dBuV/m) – Average limit (dBuV/m).



**Operation Mode:** TX / IEEE 802.11n HT 40 MHz mode  
/ CH Mid

**Test Date:** June 16, 2012

**Temperature:** 26°C

**Tested by:** Alan Wu

**Humidity:** 53% RH

**Polarity:** Ver. / Hor.

Frequency (MHz)	Reading (Peak) (dBuV)	Reading (Average) (dBuV)	Correction Factor (dB/m)	Result (Peak) (dBuV/m)	Result (Average) (dBuV/m)	Limit (Peak) (dBuV/m)	Limit (Average) (dBuV/m)	Margin (dB)	Remark	Ant. Pol. (H/V)
1018.00	54.84	---	-3.82	51.02	---	74.00	54.00	-2.98	Peak	V
1180.00	54.60	---	-3.30	51.30	---	74.00	54.00	-2.70	Peak	V
1340.00	53.74	---	-2.79	50.96	---	74.00	54.00	-3.04	Peak	V
1534.00	52.77	---	-1.96	50.80	---	74.00	54.00	-3.20	Peak	V
4890.00	39.23	---	9.65	48.88	---	74.00	54.00	-5.12	Peak	V
6330.00	37.61	---	12.19	49.79	---	74.00	54.00	-4.21	Peak	V
1016.00	54.60	---	-3.83	50.77	---	74.00	54.00	-3.23	Peak	H
1236.00	53.40	---	-3.12	50.28	---	74.00	54.00	-3.72	Peak	H
1426.00	54.13	---	-2.51	51.62	---	74.00	54.00	-2.38	Peak	H
1654.00	52.08	---	-0.89	51.19	---	74.00	54.00	-2.81	Peak	H
4785.00	39.51	---	9.39	48.90	---	74.00	54.00	-5.10	Peak	H
6652.50	38.15	---	12.36	50.51	---	74.00	54.00	-3.49	Peak	H

**Remark:**

1. Measuring frequencies from 1 GHz to the 10th harmonic of highest fundamental frequency.
2. Radiated emissions measured in frequency above 1000MHz were made with an instrument using peak/average detector mode.
3. Average test would be performed if the peak result were greater than the average limit or as required by the applicant.
4. Data of measurement within this frequency range shown " --- " in the table above means the reading of emissions are attenuated more than 20dB below the permissible limits or the field strength is too small to be measured.
5. Measurements above show only up to 6 maximum emissions noted, or would be lesser, with " N/A " remark, if no specific emissions from the EUT are recorded (ie: margin>20dB from the applicable limit) and considered that's already beyond the background noise floor.
6. Margin (dB) = Remark result (dBuV/m) – Average limit (dBuV/m).





**Operation Mode:** TX / IEEE 802.11n HT 40 MHz mode  
/ CH High

**Test Date:** June 16, 2012

**Temperature:** 26°C

**Tested by:** Alan Wu

**Humidity:** 53% RH

**Polarity:** Ver. / Hor.

Frequency (MHz)	Reading (Peak) (dBuV)	Reading (Average) (dBuV)	Correction Factor (dB/m)	Result (Peak) (dBuV/m)	Result (Average) (dBuV/m)	Limit (Peak) (dBuV/m)	Limit (Average) (dBuV/m)	Margin (dB)	Remark	Ant. Pol. (H/V)
1018.00	54.84	---	-3.82	51.02	---	74.00	54.00	-2.98	Peak	V
1180.00	54.60	---	-3.30	51.30	---	74.00	54.00	-2.70	Peak	V
1340.00	53.74	---	-2.79	50.96	---	74.00	54.00	-3.04	Peak	V
1534.00	52.77	---	-1.96	50.80	---	74.00	54.00	-3.20	Peak	V
4890.00	39.23	---	9.65	48.88	---	74.00	54.00	-5.12	Peak	V
6330.00	37.61	---	12.19	49.79	---	74.00	54.00	-4.21	Peak	V
1058.00	54.75	---	-3.69	51.06	---	74.00	54.00	-2.94	Peak	H
1322.00	53.57	---	-2.84	50.73	---	74.00	54.00	-3.27	Peak	H
1534.00	52.79	---	-1.96	50.83	---	74.00	54.00	-3.17	Peak	H
1678.00	52.02	---	-0.67	51.35	---	74.00	54.00	-2.65	Peak	H
4897.50	39.26	---	9.67	48.93	---	74.00	54.00	-5.07	Peak	H
5917.50	37.93	---	11.64	49.57	---	74.00	54.00	-4.43	Peak	H

**Remark:**

1. Measuring frequencies from 1 GHz to the 10th harmonic of highest fundamental frequency.
2. Radiated emissions measured in frequency above 1000MHz were made with an instrument using peak/average detector mode.
3. Average test would be performed if the peak result were greater than the average limit or as required by the applicant.
4. Data of measurement within this frequency range shown " --- " in the table above means the reading of emissions are attenuated more than 20dB below the permissible limits or the field strength is too small to be measured.
5. Measurements above show only up to 6 maximum emissions noted, or would be lesser, with " N/A " remark, if no specific emissions from the EUT are recorded (ie: margin>20dB from the applicable limit) and considered that's already beyond the background noise floor.
6. Margin (dB) = Remark result (dBuV/m) – Average limit (dBuV/m).

**Operation Mode:** Tx / IEEE 802.11a mode / CH Low**Test Date:** June 30, 2012**Temperature:** 26°C**Tested by:** Alan Wu**Humidity:** 53% RH**Polarity:** Ver. / Hor.

Frequency (MHz)	Reading (Peak) (dBuV)	Reading (Average) (dBuV)	Correction Factor (dB/m)	Result (Peak) (dBuV/m)	Result (Average) (dBuV/m)	Limit (Peak) (dBuV/m)	Limit (Average) (dBuV/m)	Margin (dB)	Remark	Ant. Pol. (H/V)
2995.00	56.57	---	-8.84	47.72	---	74.00	54.00	-6.28	Peak	V
3890.00	54.36	---	-8.19	46.17	---	74.00	54.00	-7.83	Peak	V
4680.00	53.89	---	-5.71	48.18	---	74.00	54.00	-5.82	Peak	V
6540.00	52.72	---	-2.06	50.66	---	74.00	54.00	-3.34	Peak	V
7272.00	52.08	---	-0.87	51.21	---	74.00	54.00	-2.79	Peak	V
7980.00	51.86	---	0.19	52.05	---	74.00	54.00	-1.95	Peak	V
1990.00	56.83	---	-12.02	44.81	---	74.00	54.00	-9.19	Peak	H
2875.00	55.40	---	-9.18	46.22	---	74.00	54.00	-7.78	Peak	H
4540.00	53.47	---	-5.80	47.68	---	74.00	54.00	-6.32	Peak	H
6036.00	52.95	---	-2.48	50.47	---	74.00	54.00	-3.53	Peak	H
6756.00	53.45	---	-1.84	51.61	---	74.00	54.00	-2.39	Peak	H
7428.00	51.53	---	-0.46	51.06	---	74.00	54.00	-2.94	Peak	H

**Remark:**

1. Measuring frequencies from 1 GHz to the 10th harmonic of highest fundamental frequency.
2. Radiated emissions measured in frequency above 1000MHz were made with an instrument using peak/average detector mode.
3. Average test would be performed if the peak result were greater than the average limit or as required by the applicant.
4. Data of measurement within this frequency range shown " --- " in the table above means the reading of emissions are attenuated more than 20dB below the permissible limits or the field strength is too small to be measured.
5. Measurements above show only up to 6 maximum emissions noted, or would be lesser, with " N/A " remark, if no specific emissions from the EUT are recorded (ie: margin > 20dB from the applicable limit) and considered that's already beyond the background noise floor.
6. Margin (dB) = Remark result (dBuV/m) – Average limit (dBuV/m).

**Operation Mode:** Tx / IEEE 802.11a mode / CH Mid**Test Date:** June 30, 2012**Temperature:** 26°C**Tested by:** Alan Wu**Humidity:** 53% RH**Polarity:** Ver. / Hor.

Frequency (MHz)	Reading (Peak) (dBuV)	Reading (Average) (dBuV)	Correction Factor (dB/m)	Result (Peak) (dBuV/m)	Result (Average) (dBuV/m)	Limit (Peak) (dBuV/m)	Limit (Average) (dBuV/m)	Margin (dB)	Remark	Ant. Pol. (H/V)
1995.00	58.46	---	-11.98	46.48	---	74.00	54.00	-7.52	Peak	V
2995.00	56.06	---	-8.84	47.21	---	74.00	54.00	-6.79	Peak	V
4690.00	54.07	---	-5.70	48.37	---	74.00	54.00	-5.63	Peak	V
6012.00	52.99	---	-2.50	50.49	---	74.00	54.00	-3.51	Peak	V
6636.00	53.68	---	-1.96	51.72	---	74.00	54.00	-2.28	Peak	V
7740.00	51.60	---	-0.04	51.55	---	74.00	54.00	-2.45	Peak	V
1650.00	59.63	---	-14.94	44.69	---	74.00	54.00	-9.31	Peak	H
2975.00	55.12	---	-8.90	46.22	---	74.00	54.00	-7.78	Peak	H
4510.00	54.79	---	-5.82	48.98	---	74.00	54.00	-5.02	Peak	H
6024.00	53.32	---	-2.49	50.83	---	74.00	54.00	-3.17	Peak	H
6840.00	52.14	---	-1.75	50.39	---	74.00	54.00	-3.61	Peak	H
7764.00	51.52	---	-0.02	51.50	---	74.00	54.00	-2.50	Peak	H

**Remark:**

1. Measuring frequencies from 1 GHz to the 10th harmonic of highest fundamental frequency.
2. Radiated emissions measured in frequency above 1000MHz were made with an instrument using peak/average detector mode.
3. Average test would be performed if the peak result were greater than the average limit or as required by the applicant.
4. Data of measurement within this frequency range shown " --- " in the table above means the reading of emissions are attenuated more than 20dB below the permissible limits or the field strength is too small to be measured.
5. Measurements above show only up to 6 maximum emissions noted, or would be lesser, with " N/A " remark, if no specific emissions from the EUT are recorded (ie: margin > 20dB from the applicable limit) and considered that's already beyond the background noise floor.
6.  $Margin (dB) = Remark\ result (dBuV/m) - Average\ limit (dBuV/m)$ .

**Operation Mode:** Tx / IEEE 802.11a mode / CH High**Test Date:** June 30, 2012**Temperature:** 26°C**Tested by:** Alan Wu**Humidity:** 53% RH**Polarity:** Ver. / Hor.

Frequency (MHz)	Reading (Peak) (dBuV)	Reading (Average) (dBuV)	Correction Factor (dB/m)	Result (Peak) (dBuV/m)	Result (Average) (dBuV/m)	Limit (Peak) (dBuV/m)	Limit (Average) (dBuV/m)	Margin (dB)	Remark	Ant. Pol. (H/V)
1990.00	58.46	---	-12.02	46.44	---	74.00	54.00	-7.56	Peak	V
2660.00	56.15	---	-9.79	46.36	---	74.00	54.00	-7.64	Peak	V
4745.00	54.68	---	-5.66	49.01	---	74.00	54.00	-4.99	Peak	V
6672.00	53.11	---	-1.92	51.19	---	74.00	54.00	-2.81	Peak	V
7680.00	51.60	---	-0.10	51.50	---	74.00	54.00	-2.50	Peak	V
8868.00	51.37	---	1.26	52.64	---	74.00	54.00	-1.36	Peak	V
2060.00	56.70	---	-11.73	44.97	---	74.00	54.00	-9.03	Peak	H
2945.00	54.92	---	-8.98	45.93	---	74.00	54.00	-8.07	Peak	H
4610.00	53.83	---	-5.75	48.08	---	74.00	54.00	-5.92	Peak	H
6768.00	54.01	---	-1.82	52.19	---	74.00	54.00	-1.81	Peak	H
7524.00	52.31	---	-0.25	52.06	---	74.00	54.00	-1.94	Peak	H
8616.00	51.80	---	0.40	52.19	---	74.00	54.00	-1.81	Peak	H

**Remark:**

1. Measuring frequencies from 1 GHz to the 10th harmonic of highest fundamental frequency.
2. Radiated emissions measured in frequency above 1000MHz were made with an instrument using peak/average detector mode.
3. Average test would be performed if the peak result were greater than the average limit or as required by the applicant.
4. Data of measurement within this frequency range shown " --- " in the table above means the reading of emissions are attenuated more than 20dB below the permissible limits or the field strength is too small to be measured.
5. Measurements above show only up to 6 maximum emissions noted, or would be lesser, with " N/A " remark, if no specific emissions from the EUT are recorded (ie: margin > 20dB from the applicable limit) and considered that's already beyond the background noise floor.
6.  $Margin (dB) = Remark\ result (dBuV/m) - Average\ limit (dBuV/m)$ .



**Operation Mode:** TX / IEEE 802.11n HT 20 MHz mode  
/ CH Low

**Test Date:** June 30, 2012

**Temperature:** 26°C

**Tested by:** Alan Wu

**Humidity:** 53% RH

**Polarity:** Ver. / Hor.

Frequency (MHz)	Reading (Peak) (dBuV)	Reading (Average) (dBuV)	Correction Factor (dB/m)	Result (Peak) (dBuV/m)	Result (Average) (dBuV/m)	Limit (Peak) (dBuV/m)	Limit (Average) (dBuV/m)	Margin (dB)	Remark	Ant. Pol. (H/V)
1990.00	58.80	---	-12.02	46.78	---	74.00	54.00	-7.22	Peak	V
2660.00	57.78	---	-9.79	47.99	---	74.00	54.00	-6.01	Peak	V
2995.00	56.73	---	-8.84	47.89	---	74.00	54.00	-6.11	Peak	V
6012.00	53.43	---	-2.50	50.93	---	74.00	54.00	-3.07	Peak	V
7548.00	51.94	---	-0.23	51.71	---	74.00	54.00	-2.29	Peak	V
8676.00	51.96	---	0.60	52.57	---	74.00	54.00	-1.43	Peak	V
2175.00	56.72	---	-11.34	45.38	---	74.00	54.00	-8.62	Peak	H
3020.00	54.73	---	-8.82	45.91	---	74.00	54.00	-8.09	Peak	H
4535.00	53.54	---	-5.80	47.74	---	74.00	54.00	-6.26	Peak	H
6012.00	52.34	---	-2.50	49.85	---	74.00	54.00	-4.15	Peak	H
7356.00	52.52	---	-0.65	51.87	---	74.00	54.00	-2.13	Peak	H
8772.00	51.61	---	0.93	52.54	---	74.00	54.00	-1.46	Peak	H

**Remark:**

1. Measuring frequencies from 1 GHz to the 10th harmonic of highest fundamental frequency.
2. Radiated emissions measured in frequency above 1000MHz were made with an instrument using peak/average detector mode.
3. Average test would be performed if the peak result were greater than the average limit or as required by the applicant.
4. Data of measurement within this frequency range shown " --- " in the table above means the reading of emissions are attenuated more than 20dB below the permissible limits or the field strength is too small to be measured.
5. Measurements above show only up to 6 maximum emissions noted, or would be lesser, with " N/A " remark, if no specific emissions from the EUT are recorded (ie: margin>20dB from the applicable limit) and considered that's already beyond the background noise floor.
6. Margin (dB) = Remark result (dBuV/m) – Average limit (dBuV/m).



**Operation Mode:** TX / IEEE 802.11n HT 20 MHz mode  
/ CH Mid

**Test Date:** June 30, 2012

**Temperature:** 26°C

**Tested by:** Alan Wu

**Humidity:** 53% RH

**Polarity:** Ver. / Hor.

Frequency (MHz)	Reading (Peak) (dBuV)	Reading (Average) (dBuV)	Correction Factor (dB/m)	Result (Peak) (dBuV/m)	Result (Average) (dBuV/m)	Limit (Peak) (dBuV/m)	Limit (Average) (dBuV/m)	Margin (dB)	Remark	Ant. Pol. (H/V)
2100.00	58.32	---	-11.59	46.72	---	74.00	54.00	-7.28	Peak	V
2660.00	58.39	---	-9.79	48.61	---	74.00	54.00	-5.39	Peak	V
4510.00	54.16	---	-5.82	48.34	---	74.00	54.00	-5.66	Peak	V
6132.00	52.78	---	-2.40	50.38	---	74.00	54.00	-3.62	Peak	V
7080.00	52.09	---	-1.37	50.72	---	74.00	54.00	-3.28	Peak	V
7968.00	51.65	---	0.18	51.83	---	74.00	54.00	-2.17	Peak	V
1330.00	62.82	---	-16.47	46.36	---	74.00	54.00	-7.64	Peak	H
3205.00	54.55	---	-8.79	45.76	---	74.00	54.00	-8.24	Peak	H
4620.00	54.19	---	-5.74	48.45	---	74.00	54.00	-5.55	Peak	H
6108.00	53.37	---	-2.42	50.95	---	74.00	54.00	-3.05	Peak	H
7512.00	52.93	---	-0.26	52.67	---	74.00	54.00	-1.33	Peak	H
8868.00	51.56	---	1.26	52.83	---	74.00	54.00	-1.17	Peak	H

**Remark:**

1. Measuring frequencies from 1 GHz to the 10th harmonic of highest fundamental frequency.
2. Radiated emissions measured in frequency above 1000MHz were made with an instrument using peak/average detector mode.
3. Average test would be performed if the peak result were greater than the average limit or as required by the applicant.
4. Data of measurement within this frequency range shown " --- " in the table above means the reading of emissions are attenuated more than 20dB below the permissible limits or the field strength is too small to be measured.
5. Measurements above show only up to 6 maximum emissions noted, or would be lesser, with " N/A " remark, if no specific emissions from the EUT are recorded (ie: margin>20dB from the applicable limit) and considered that's already beyond the background noise floor.
6. Margin (dB) = Remark result (dBuV/m) – Average limit (dBuV/m).



**Operation Mode:** TX / IEEE 802.11n HT 20 MHz mode / CH High      **Test Date:** June 30, 2012  
**Temperature:** 26°C      **Tested by:** Alan Wu  
**Humidity:** 53% RH      **Polarity:** Ver. / Hor.

Frequency (MHz)	Reading (Peak) (dBuV)	Reading (Average) (dBuV)	Correction Factor (dB/m)	Result (Peak) (dBuV/m)	Result (Average) (dBuV/m)	Limit (Peak) (dBuV/m)	Limit (Average) (dBuV/m)	Margin (dB)	Remark	Ant. Pol. (H/V)
2655.00	57.44	---	-9.80	47.64	---	74.00	54.00	-6.36	Peak	V
2995.00	56.74	---	-8.84	47.90	---	74.00	54.00	-6.10	Peak	V
4630.00	54.39	---	-5.74	48.65	---	74.00	54.00	-5.35	Peak	V
6708.00	52.57	---	-1.89	50.68	---	74.00	54.00	-3.32	Peak	V
7416.00	52.02	---	-0.49	51.53	---	74.00	54.00	-2.47	Peak	V
8652.00	51.17	---	0.52	51.69	---	74.00	54.00	-2.31	Peak	V
1805.00	60.63	---	-13.61	47.03	---	74.00	54.00	-6.97	Peak	H
3165.00	55.01	---	-8.80	46.21	---	74.00	54.00	-7.79	Peak	H
4680.00	53.93	---	-5.71	48.23	---	74.00	54.00	-5.77	Peak	H
6684.00	52.52	---	-1.91	50.61	---	74.00	54.00	-3.39	Peak	H
7716.00	51.82	---	-0.07	51.75	---	74.00	54.00	-2.25	Peak	H
8640.00	51.76	---	0.48	52.23	---	74.00	54.00	-1.77	Peak	H

**Remark:**

1. Measuring frequencies from 1 GHz to the 10th harmonic of highest fundamental frequency.
2. Radiated emissions measured in frequency above 1000MHz were made with an instrument using peak/average detector mode.
3. Average test would be performed if the peak result were greater than the average limit or as required by the applicant.
4. Data of measurement within this frequency range shown " --- " in the table above means the reading of emissions are attenuated more than 20dB below the permissible limits or the field strength is too small to be measured.
5. Measurements above show only up to 6 maximum emissions noted, or would be lesser, with " N/A " remark, if no specific emissions from the EUT are recorded (ie: margin>20dB from the applicable limit) and considered that's already beyond the background noise floor.
6. Margin (dB) = Remark result (dBuV/m) – Average limit (dBuV/m).



**Operation Mode:** TX / IEEE 802.11n HT 40 MHz mode  
/ CH Low

**Test Date:** June 30, 2012

**Temperature:** 26°C

**Tested by:** Alan Wu

**Humidity:** 53% RH

**Polarity:** Ver. / Hor.

Frequency (MHz)	Reading (Peak) (dBuV)	Reading (Average) (dBuV)	Correction Factor (dB/m)	Result (Peak) (dBuV/m)	Result (Average) (dBuV/m)	Limit (Peak) (dBuV/m)	Limit (Average) (dBuV/m)	Margin (dB)	Remark	Ant. Pol. (H/V)
2000.00	56.64	---	-11.93	44.70	---	74.00	54.00	-9.30	Peak	V
2860.00	57.28	---	-9.22	48.05	---	74.00	54.00	-5.95	Peak	V
5135.00	54.05	---	-5.18	48.88	---	74.00	54.00	-5.12	Peak	V
6012.00	52.80	---	-2.50	50.30	---	74.00	54.00	-3.70	Peak	V
7260.00	51.72	---	-0.90	50.82	---	74.00	54.00	-3.18	Peak	V
8616.00	51.73	---	0.40	52.13	---	74.00	54.00	-1.87	Peak	V
3155.00	55.29	---	-8.80	46.49	---	74.00	54.00	-7.51	Peak	H
4610.00	54.23	---	-5.75	48.48	---	74.00	54.00	-5.52	Peak	H
5145.00	53.34	---	-5.15	48.19	---	74.00	54.00	-5.81	Peak	H
6012.00	53.16	---	-2.50	50.67	---	74.00	54.00	-3.33	Peak	H
6828.00	53.23	---	-1.76	51.47	---	74.00	54.00	-2.53	Peak	H
7992.00	52.50	---	0.20	52.70	---	74.00	54.00	-1.30	Peak	H

**Remark:**

1. Measuring frequencies from 1 GHz to the 10th harmonic of highest fundamental frequency.
2. Radiated emissions measured in frequency above 1000MHz were made with an instrument using peak/average detector mode.
3. Average test would be performed if the peak result were greater than the average limit or as required by the applicant.
4. Data of measurement within this frequency range shown " --- " in the table above means the reading of emissions are attenuated more than 20dB below the permissible limits or the field strength is too small to be measured.
5. Measurements above show only up to 6 maximum emissions noted, or would be lesser, with " N/A " remark, if no specific emissions from the EUT are recorded (ie: margin>20dB from the applicable limit) and considered that's already beyond the background noise floor.
6. Margin (dB) = Remark result (dBuV/m) – Average limit (dBuV/m).





**Operation Mode:** TX / IEEE 802.11n HT 40 MHz mode  
/ CH High

**Test Date:** June 30, 2012

**Temperature:** 26°C

**Tested by:** Alan Wu

**Humidity:** 53% RH

**Polarity:** Ver. / Hor.

Frequency (MHz)	Reading (Peak) (dBuV)	Reading (Average) (dBuV)	Correction Factor (dB/m)	Result (Peak) (dBuV/m)	Result (Average) (dBuV/m)	Limit (Peak) (dBuV/m)	Limit (Average) (dBuV/m)	Margin (dB)	Remark	Ant. Pol. (H/V)
2660.00	55.72	---	-9.79	45.93	---	74.00	54.00	-8.07	Peak	V
4690.00	53.88	---	-5.70	48.18	---	74.00	54.00	-5.82	Peak	V
5365.00	53.93	---	-4.62	49.30	---	74.00	54.00	-4.70	Peak	V
6396.00	52.59	---	-2.19	50.41	---	74.00	54.00	-3.59	Peak	V
7512.00	52.01	---	-0.26	51.75	---	74.00	54.00	-2.25	Peak	V
8616.00	51.52	---	0.40	51.92	---	74.00	54.00	-2.08	Peak	V
2665.00	56.88	---	-9.77	47.11	---	74.00	54.00	-6.89	Peak	H
4635.00	53.47	---	-5.73	47.74	---	74.00	54.00	-6.26	Peak	H
5480.00	53.47	---	-4.35	49.13	---	74.00	54.00	-4.87	Peak	H
6000.00	53.12	---	-2.51	50.61	---	74.00	54.00	-3.39	Peak	H
7428.00	52.08	---	-0.46	51.62	---	74.00	54.00	-2.38	Peak	H
8688.00	51.36	---	0.64	52.00	---	74.00	54.00	-2.00	Peak	H

**Remark:**

1. Measuring frequencies from 1 GHz to the 10th harmonic of highest fundamental frequency.
2. Radiated emissions measured in frequency above 1000MHz were made with an instrument using peak/average detector mode.
3. Average test would be performed if the peak result were greater than the average limit or as required by the applicant.
4. Data of measurement within this frequency range shown " --- " in the table above means the reading of emissions are attenuated more than 20dB below the permissible limits or the field strength is too small to be measured.
5. Measurements above show only up to 6 maximum emissions noted, or would be lesser, with " N/A " remark, if no specific emissions from the EUT are recorded (ie: margin>20dB from the applicable limit) and considered that's already beyond the background noise floor.
6. Margin (dB) = Remark result (dBuV/m) – Average limit (dBuV/m).



## 7.8 POWERLINE CONDUCTED EMISSIONS

### LIMIT

According to §15.207(a), except as shown in paragraphs (b) and (c) of this section, for an intentional radiator that is designed to be connected to the public utility (AC) power line, the radio frequency voltage that is conducted back onto the AC power line on any frequency or frequencies within the band 150 kHz to 30 MHz shall not exceed the limits in the following table, as measured using a 50  $\mu$ H/50 ohms line impedance stabilization network (LISN). Compliance with the provisions of this paragraph shall be based on the measurement of the radio frequency voltage between each power line and ground at the power terminal. The lower limit applies at the boundary between the frequency ranges.

Frequency Range (MHz)	Limits (dB $\mu$ V)	
	Quasi-peak	Average
0.15 to 0.50	66 to 56*	56 to 46*
0.50 to 5	56	46
5 to 30	60	50

\* Decreases with the logarithm of the frequency.

### Test Configuration

See test photographs attached in Appendix 1 for the actual connections between EUT and support equipment.

### TEST PROCEDURE

1. The EUT was placed on a table, which is 0.8m above ground plane.
2. Maximum procedure was performed on the six highest emissions to ensure EUT compliance.
3. Repeat above procedures until all frequency measured were complete.

### TEST RESULTS

The initial step in collecting conducted data is a spectrum analyzer peak scan of the measurement range. Significant peaks are then marked as shown on the following data page, and these signals are then quasi-peaked.



**Test Data**

<b>Operation Mode:</b>	Normal Link	<b>Test Date:</b>	August 20, 2012
<b>Temperature:</b>	22°C	<b>Tested by:</b>	Alan Wu
<b>Humidity:</b>	58% RH		

**Conducted emissions (Line 1)**

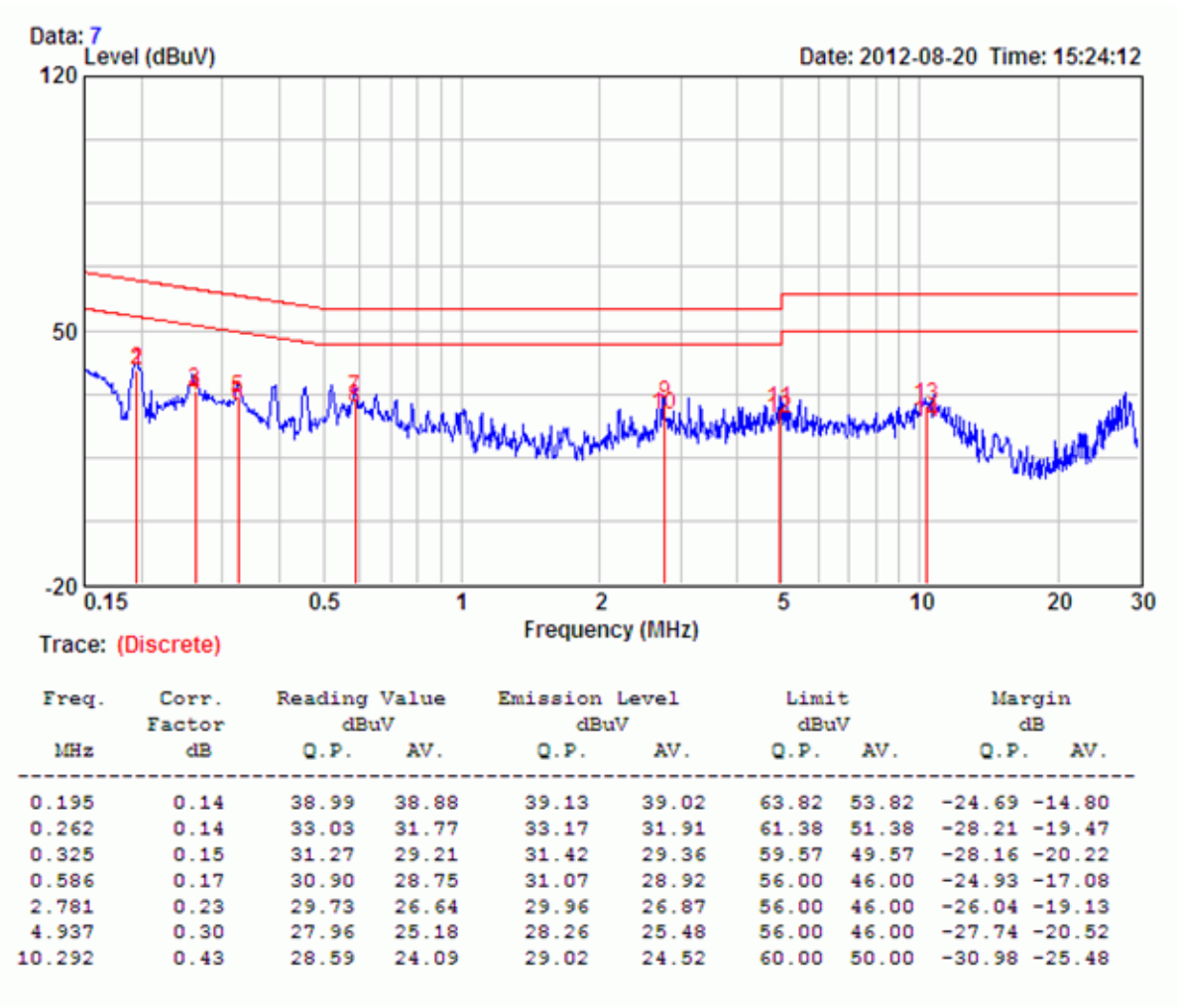

Remarks: 1. The emission levels of other frequencies were very low against the limits .  
 2. Correction Factor = Insertion loss + Cable loss  
 3. Margin value = Emission level - Limit value



Conducted emissions (Line 2)

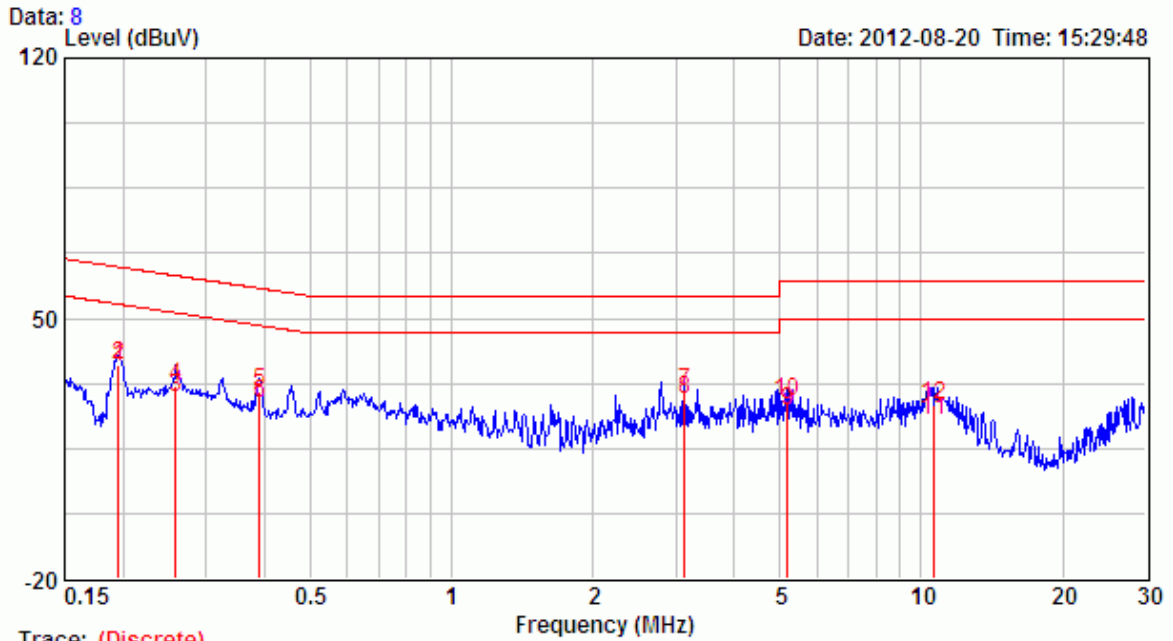

Freq. MHz	Corr. Factor dB	Reading Value dBuV		Emission Level dBuV		Limit dBuV		Margin dB	
		Q.P.	AV.	Q.P.	AV.	Q.P.	AV.	Q.P.	AV.
0.195	0.11	37.33	36.84	37.44	36.95	63.80	53.80	-26.36	-16.85
0.259	0.12	31.81	28.75	31.93	28.87	61.47	51.47	-29.54	-22.60
0.389	0.13	30.21	27.17	30.34	27.30	58.08	48.08	-27.74	-20.78
3.130	0.22	30.13	28.04	30.35	28.26	56.00	46.00	-25.65	-17.74
5.180	0.27	27.32	25.01	27.59	25.28	60.00	50.00	-32.41	-24.72
10.602	0.38	26.26	22.12	26.64	22.50	60.00	50.00	-33.36	-27.50

Remarks: 1. The emission levels of other frequencies were very low against the limits .  
 2. Correction Factor = Insertion loss + Cable loss  
 3. Margin value = Emission level - Limit value