



FCC 47 CFR PART 15 SUBPART E

TEST REPORT

For

Notebook Computer

Model: V200

Trade Name: Getac

Issued to

Getac Technology Corp.

**4F, No.1, R&D 2nd Road, Hsin-Chu Science-Based Industrial Park,
Hsin-Chu Hsien, Taiwan, R.O.C.**

Issued by

Compliance Certification Services Inc.

**No.11, Wu-Gong 6th Rd., Wugu Industrial Park,
New Taipei City 248, Taiwan (R.O.C.)**

<http://www.ccsrf.com>

service@ccsrf.com

Issued Date: October 15, 2012



Note: This report shall not be reproduced except in full, without the written approval of Compliance Certification Services Inc. This document may be altered or revised by Compliance Certification Services Inc. personnel only, and shall be noted in the revision section of the document.



Revision History

Rev.	Issue Date	Revisions	Effect Page	Revised By
00	October 15, 2012	Initial Issue	ALL	Eunice Shen



TABLE OF CONTENTS

1. TEST RESULT CERTIFICATION.....	4
2. EUT DESCRIPTION	5
3. TEST METHODOLOGY	7
3.1 EUT CONFIGURATION	7
3.2 EUT EXERCISE	7
3.3 GENERAL TEST PROCEDURES	7
3.4 FCC PART 15.205 RESTRICTED BANDS OF OPERATIONS	8
3.5 DESCRIPTION OF TEST MODES	9
4. INSTRUMENT CALIBRATION.....	10
4.1 MEASURING INSTRUMENT CALIBRATION	10
4.2 MEASUREMENT EQUIPMENT USED	10
4.3 MEASUREMENT UNCERTAINTY	11
5. FACILITIES AND ACCREDITATIONS	12
5.1 FACILITIES	12
5.2 EQUIPMENT	12
5.3 TABLE OF ACCREDITATIONS AND LISTINGS	13
6. SETUP OF EQUIPMENT UNDER TEST	14
6.1 SETUP CONFIGURATION OF EUT	14
6.2 SUPPORT EQUIPMENT	14
7. FCC PART 15 REQUIREMENTS.....	15
7.1 26 DB EMISSION BANDWIDTH	15
7.2 MAXIMUM CONDUCTED OUTPUT POWER	43
7.3 BAND EDGES MEASUREMENT	48
7.4 PEAK POWER SPECTRAL DENSITY	61
7.5 PEAK EXCURSION	89
7.6 RADIATED UNDESIRABLE EMISSION.....	105
7.7 POWERLINE CONDUCTED EMISSIONS	135
7.8 FREQUENCY STABILITY.....	138
7.9 DYNAMIC FREQUENCY SELECTION.....	157
APPENDIX I RADIO FREQUENCY EXPOSURE	204
APPENDIX II PHOTOGRAPHS OF TEST SETUP.....	205
APPENDIX 1 - PHOTOGRAPHS OF EUT	



1. TEST RESULT CERTIFICATION

Applicant: Getac Technology Corp.
4F, No.1, R&D 2nd Road, Hsin-Chu Science-Based Industrial
Park, Hsin-Chu Hsien, Taiwan, R.O.C.

Equipment Under Test: Notebook Computer

Trade Name: Getac

Model: V200

Date of Test: June 27 ~ September 10, 2012

APPLICABLE STANDARDS	
STANDARD	TEST RESULT
FCC 47 CFR Part 15 Subpart E	No non-compliance noted

We hereby certify that:

Compliance Certification Services Inc. tested the above equipment. The test data, data evaluation, test procedures, and equipment configurations shown in this report were made in accordance with the procedures given in ANSI C63.4: 2009 and the energy emitted by the sample EUT tested as described in this report is in compliance with conducted and radiated emission limits of FCC Rules Part 15.407.

The test results of this report relate only to the tested sample identified in this report.

Approved by:

Reviewed by:

Miller Lee
Section Manager
Compliance Certification Services Inc.

Gina Lo
Section Manager
Compliance Certification Services Inc.



2. EUT DESCRIPTION

Product	Notebook Computer				
Trade Name	Getac				
Model Number	V200				
Model Discrepancy	N/A				
Received Date	July 11, 2012				
Power Supply	<p>1. Powered from Power Adapter</p> <p>A) Brand: Getac / Model: ADM-6019M I/P: 100-240V, 50-60Hz, 1.5A O/P: 19V, 3.16A</p> <p>B) Brand: Getac / Model: ADM-9019M-GTK I/P: 100-240V, 50-60Hz, 1.5A O/P: 19V, 4.74A</p> <p>C) Brand: FSP / Model: FSP090-DMBB1 I/P: 100-240V, 50-60Hz, 1.5A O/P: 19V, 4.74A</p> <p>2. Powered from Battery Model: BP-LC3100/32-01P1 Rating: DC10.8V, 6100mAh, 65Wh</p>				
Operating Frequency Range & Number of Channels		Mode	Frequency Range (MHz)	Number of Channels	
	UNII Band I	IEEE 802.11a	5180 – 5240	4 Channels	
		IEEE 802.11n HT 20 MHz mode	5180 – 5240	4 Channels	
		IEEE 802.11n HT 40 MHz mode	5190 ~ 5230	2 Channels	
	UNII Band II	IEEE 802.11a	5260 - 5320	4 Channels	
		IEEE 802.11n HT 20 MHz mode	5260 - 5320	4 Channels	
		IEEE 802.11n HT 40 MHz mode	5270 - 5310	2 Channels	
	UNII Band III	IEEE 802.11a	5500 - 5700	11 Channels	
		IEEE 802.11n HT 20 MHz mode	5500 – 5700	11 Channels	
IEEE 802.11n HT 40 MHz mode		5510 - 5670	5 Channels		
Transmit Power		Mode	Frequency Range (MHz)	Output Power (dBm)	Output Power (w)
	UNII Band I	IEEE 802.11a	5180 – 5240	12.46	0.0176
		IEEE 802.11n HT 20 MHz	5180 – 5240	9.75	0.0094
		IEEE 802.11n HT 40 MHz	5190 ~ 5230	8.46	0.0070
	UNII Band II	IEEE 802.11a	5260 - 5320	13.53	0.0225
		IEEE 802.11n HT 20 MHz	5260 - 5320	11.16	0.0131
		IEEE 802.11n HT 40 MHz	5270 - 5310	9.83	0.0096
	UNII Band III	IEEE 802.11a	5500 - 5700	13.53	0.0225
		IEEE 802.11n HT 20 MHz	5500 – 5700	11.22	0.0132
IEEE 802.11n HT 40 MHz		5510 - 5670	10.45	0.0111	
Modulation Technique	OFDM (QPSK, BPSK, 16-QAM, 64-QAM)				



Transmit Data Rate	IEEE 802.11a mode: 54, 48, 36, 24, 18, 12, 9, 6 Mbps IEEE 802.11n HT 20 MHz mode: OFDM (6.5, 7.2, 13, 14.4, 14.44, 19.5, 21.7, 26, 28.89, 28.9, 39, 43.3, 43.33 52, 57.78, 57.8, 58.5, 65.0, 72.2, 78, 86.67, 104, 115.56, 117, 130, 144.44 Mbps) IEEE 802.11n HT 40 MHz mode: OFDM (13.5, 15, 27, 30, 40.5, 45, 54, 60, 81, 90, 108, 120, 121.5, 135, 150, 162, 180, 216, 240, 243, 270, 300 Mbps)
Antenna Specification	3.34 dBi
Antenna Designation	PIFA Antenna

Remark:

1. The sample selected for test was production product and was provided by manufacturer.
2. This submittal(s) (test report) is intended for FCC ID: **MAU048** filing to comply with Section 15.207, 15.209 and 15.247 of the FCC Part 15, Subpart C Rules.

Operation Frequency:

UNLICENSED NATIONAL INFORMATION INFRASTRUCTURE (U-NII)	
CHANNEL	MHz
36	5180
38	5190
40	5200
44	5220
46	5230
48	5240
52	5260
54	5270
56	5280
60	5300
62	5310
64	5320
100	5500
102	5510
104	5520
108	5540
110	5550
112	5560
116	5580
134	5670
136	5680
140	5700



3. TEST METHODOLOGY

Both conducted and radiated testing was performed according to the procedures in ANSI C63.4. Radiated testing was performed at an antenna to EUT distance 3 meters.

3.1 EUT CONFIGURATION

The EUT configuration for testing is installed for RF field strength measurement to meet the Commissions requirement, and is operated in a manner intended to generate the maximum emission in a continuous normal application.

3.2 EUT EXERCISE

The EUT is operated in the engineering mode to fix the Tx frequency for the purposes of measurement.

According to its specifications, the EUT must comply with the requirements of Section 15.407 under the FCC Rules Part 15 Subpart E.

3.3 GENERAL TEST PROCEDURES

Conducted Emissions

The EUT is placed on the turntable, which is positioned at 0.8 m above the ground plane. According to the requirements in Section 13.1.4.1 of ANSI C63.4, the conducted emission from the EUT is measured in the frequency range between 0.15 MHz and 30MHz, using the CISPR Quasi-Peak detector mode.

Radiated Emissions

The EUT is placed on the turntable, which is 0.8 m above the ground plane. The turntable is then rotated for 360 degrees to determine the proper orientation for the maximum emission level. The EUT is set 3m away from the receiving antenna, which is varied from 1m to 4m to find out the highest emission level. And, each emission is to be maximized by changing the horizontal and vertical polarization of the receiving antenna. In order to find out the maximum emissions, exploratory radiated emission measurements were made according to the requirements in Section 13.1.4.1 of ANSI C63.4.



3.4 FCC PART 15.205 RESTRICTED BANDS OF OPERATIONS

(a) Except as shown in paragraph (d) of this section, only spurious emissions are permitted in any of the frequency bands listed below:

MHz	MHz	MHz	GHz
0.090 - 0.110	16.42 - 16.423	399.9 - 410	4.5 - 5.15
¹ 0.495 - 0.505	16.69475 - 16.69525	608 - 614	5.35 - 5.46
2.1735 - 2.1905	16.80425 - 16.80475	960 - 1240	7.25 - 7.75
4.125 - 4.128	25.5 - 25.67	1300 - 1427	8.025 - 8.5
4.17725 - 4.17775	37.5 - 38.25	1435 - 1626.5	9.0 - 9.2
4.20725 - 4.20775	73 - 74.6	1645.5 - 1646.5	9.3 - 9.5
6.215 - 6.218	74.8 - 75.2	1660 - 1710	10.6 - 12.7
6.26775 - 6.26825	108 - 121.94	1718.8 - 1722.2	13.25 - 13.4
6.31175 - 6.31225	123 - 138	2200 - 2300	14.47 - 14.5
8.291 - 8.294	149.9 - 150.05	2310 - 2390	15.35 - 16.2
8.362 - 8.366	156.52475 -	2483.5 - 2500	17.7 - 21.4
8.37625 - 8.38675	156.52525	2655 - 2900	22.01 - 23.12
8.41425 - 8.41475	156.7 - 156.9	3260 - 3267	23.6 - 24.0
12.29 - 12.293	162.0125 - 167.17	3332 - 3339	31.2 - 31.8
12.51975 - 12.52025	167.72 - 173.2	3345.8 - 3358	36.43 - 36.5
12.57675 - 12.57725	240 - 285	3600 - 4400	(²)
13.36 - 13.41	322 - 335.4		

¹ Until February 1, 1999, this restricted band shall be 0.490-0.510 MHz.

² Above 38.6

(b) Except as provided in paragraphs (d) and (e), the field strength of emissions appearing within these frequency bands shall not exceed the limits shown in Section 15.209. At frequencies equal to or less than 1000 MHz, compliance with the limits in Section 15.209 shall be demonstrated using measurement instrumentation employing a CISPR quasi-peak detector. Above 1000 MHz, compliance with the emission limits in Section 15.209 shall be demonstrated based on the average value of the measured emissions. The provisions in Section 15.35 apply to these measurements.



3.5 DESCRIPTION OF TEST MODES

The EUT (model: V200) comes with three types of power adapter for sale. After the preliminary test, the EUT with adapter (Model: ADM-9019M-GTK) was found to emit the worst emissions and therefore had been tested under operating condition.

Software used to control the EUT for staying in continuous transmitting mode was programmed.

After verification, all tests were carried out with the worst case test modes as shown below except radiated spurious emission below 1GHz, which worst case was in normal link mode only.

IEEE 802.11a mode / 5180 ~ 5240MHz:

Channel Low (5180MHz), Channel Mid (5220MHz) and Channel High (5240MHz) with 6Mbps data rate were chosen for full testing.

IEEE 802.11n HT 20 MHz mode / 5180 ~ 5240MHz:

Channel Low (5180MHz), Channel Mid (5220MHz) and Channel High (5240MHz) with 6.5Mbps data rate were chosen for full testing.

IEEE 802.11n HT 40 MHz mode / 5190 ~ 5230MHz:

Channel Low (5190MHz) and Channel High (5230MHz) with 13.5Mbps data rate were chosen for full testing.

IEEE 802.11a mode / 5260 ~ 5320MHz:

Channel Low (5260MHz), Channel Mid (5280MHz) and Channel High (5320MHz) with 6Mbps data rate were chosen for full testing.

IEEE 802.11n HT 20 MHz mode / 5260 ~ 5320MHz:

Channel Low (5260MHz), Channel Mid (5280MHz) and Channel High (5320MHz) with 6.5Mbps data rate were chosen for full testing.

IEEE 802.11n HT 40 MHz mode / 5270 ~ 5310MHz:

Channel Low (5270MHz) and Channel High (5310MHz) with 13.5Mbps data rate were chosen for full testing.

IEEE 802.11a mode / 5500 ~ 5700MHz:

Channel Low (5500MHz), Channel Mid (5600MHz) and Channel High (5700MHz) with 6Mbps data rate were chosen for full testing.

IEEE 802.11n HT 20 MHz mode / 5500 ~ 5700MHz:

Channel Low (5500MHz), Channel Mid (5600MHz) and Channel High (5700MHz) with 6.5Mbps data rate were chosen for full testing.

IEEE 802.11n HT 40 MHz mode / 5510 ~ 5670MHz:

Channel Low (5510MHz), Channel Mid (5590MHz) and Channel High (5670MHz) with 13.5Mbps data rate were chosen for full testing.



4. INSTRUMENT CALIBRATION

4.1 MEASURING INSTRUMENT CALIBRATION

The measuring equipment, which was utilized in performing the tests documented herein, has been calibrated in accordance with the manufacturer's recommendations for utilizing calibration equipment, which is traceable to recognized national standards.

4.2 MEASUREMENT EQUIPMENT USED

Equipment Used for Emissions Measurement

Remark: Each piece of equipment is scheduled for calibration once a year and Loop Antenna is scheduled for calibration once three years.

Conducted Emissions Test Site				
Name of Equipment	Manufacturer	Model	Serial Number	Calibration Due
Spectrum Analyzer	Agilent	E4446A	MY43360131	03/16/2013
Power Meter	Anritsu	ML2495A	1012009	04/26/2013
Power Sensor	Anritsu	MA2411B	0917072	04/26/2013

966Chamber B				
Name of Equipment	Manufacturer	Model	Serial Number	Calibration Due
Spectrum Analyzer	Agilent	E4446A	MY46180323	04/22/2013
EMI Receiver	ROHDE & SCHWARZ	ESCS 30	826547/004	10/27/2012
Broadband Hybrid Bi-Log Antenna	Sunol Sciences	JB1	A100209-4	10/01/2013
Double-Ridged Waveguide Horn	ETS-LINDGREN	3117	00078733	12/06/2012
Horn Antenna	COM-POWER	AH-840	03077	12/06/2012
Pre-Amplifier	Agilent	8447D	2944A10052	07/17/2013
Pre-Amplifier	Agilent	8449B	3008A01916	07/17/2013
Notch Filters Band Reject	Micro-Tronics	BRM05702-01	026	N.C.R.
Band Reject Filter	Micro-Tronics	BRC50703-01	004	N.C.R.
Band Reject Filter	Micro-Tronics	BRC50704-01	004	N.C.R.
Band Reject Filter	Micro-Tronics	BRC50705-01	007	N.C.R.
LOOP Antenna	EMCO	6502	8905-2356	06/10/2013

Conducted Emission room				
Name of Equipment	Manufacturer	Model	Serial Number	Calibration Due
L.I.S.N	SCHWARZBECK	NSLK 8127	8127-465	08/07/2013
L.I.S.N	SCHWARZBECK	NSLK 8127	8127-473	03/12/2013
EMI Receiver	ROHDE & SCHWARZ	ESCS 30	835418/008	10/20/2012
Pulse Limiter	ROHDE & SCHWARZ	ESH3-Z2	100117	07/03/2013

Dynamic Frequency Selection				
Name of Equipment	Manufacturer	Model	Serial Number	Calibration Due
Spectrum Analyzer	Rohde&Schwarz	FSEK 30	100264	05/23/2013
Signal Generator	Agilent	E8267C	US42340162	08/07/2013



4.3 MEASUREMENT UNCERTAINTY

PARAMETER	UNCERTAINTY
Conducted Emission (Mains Terminals), 9kHz to 30MHz	+/- 2.48
Conducted Emission (Telecommunication Port), 150kHz to 30MHz	+/- 3.09
3M Semi Anechoic Chamber / 30M~1000M	+/- 3.97
3M Semi Anechoic Chamber / 1G~18G	+/- 3.58
3M Semi Anechoic Chamber / 18G~26G	+/- 3.59
3M Semi Anechoic Chamber / 26G~40G	+/- 3.81

Remark: This uncertainty represents an expanded uncertainty expressed at approximately the 95% confidence level using a coverage factor of $k=2$.



5. FACILITIES AND ACCREDITATIONS

5.1 FACILITIES

All measurement facilities used to collect the measurement data are located at

NO. 989-1 Wen Shan Rd., Shang Shan Village, Qionglin Shiang Hsinchu County 30741,
Taiwan, R.O.C

No.11, Wu-Gong 6th Rd., Wugu Industrial Park, New Taipei City 248, Taiwan (R.O.C.)
Tel: 886-2-2299-9720 / Fax: 886-2-2298-4045

No.81-1, Lane 210, Bade 2nd Rd., Lujhu Township, Taoyuan County 33841, TAIWAN, R.O.C.
Tel: 886-3-324-0332 / Fax: 886-3-324-5235

The sites are constructed in conformance with the requirements of ANSI C63.7, ANSI C63.4 and CISPR Publication 22.

5.2 EQUIPMENT

Radiated emissions are measured with one or more of the following types of linearly polarized antennas: tuned dipole, biconical, log periodic, bi-log, and/or ridged waveguide, horn. Spectrum analyzers with pre-selectors and quasi-peak detectors are used to perform radiated measurements.



Conducted emissions are measured with Line Impedance Stabilization Networks and EMI Test Receivers.

Calibrated wideband preamplifiers, coaxial cables, and coaxial attenuators are also used for making measurements.

All receiving equipment conforms to CISPR Publication 16-1, "Radio Interference Measuring Apparatus and Measurement Methods."



5.3 TABLE OF ACCREDITATIONS AND LISTINGS

Country	Agency	Scope of Accreditation	Logo
USA	FCC	3M Semi Anechoic Chamber (FCC MRA: TW1039) to perform FCC Part 15 measurements	 FCC MRA: TW1039
Taiwan	TAF	LP0002, RTTE01, FCC Method-47 CFR Part 15 Subpart C, D, E, RSS-210, RSS-310 IDA TS SRD, AS/NZS 4268, AS/NZS 4771, TS 12.1 & 12.2, ETSI EN 300 440-1, ETSI EN 300 440-2, ETSI EN 300 328, ETSI EN 300 220-1, ETSI EN 300 220-2, ETSI EN 301 893, ETSI EN 301 489-1/3/7/17 FCC OET Bulletin 65 + Supplement C, EN 50360, EN 50361, EN 50371, RSS 102, EN 50383, EN 50385, EN 50392, IEC 62209, CNS 14958-1, CNS 14959 FCC Method -47 CFR Part 15 Subpart B IEC / EN 61000-3-2, IEC / EN 61000-3-3, IEC / EN 61000-4-2/3/4/5/6/8/11	
Canada	Industry Canada	3M Semi Anechoic Chamber (IC 2324G-1 / IC 2324G-2) to perform	 IC 2324G-1 IC 2324G-2

* No part of this report may be used to claim or imply product endorsement by A2LA or any agency of the US Government.



6. SETUP OF EQUIPMENT UNDER TEST

6.1 SETUP CONFIGURATION OF EUT

See test photographs attached in Appendix I for the actual connections between EUT and support equipment.

6.2 SUPPORT EQUIPMENT

No.	Product	Manufacturer	Model No.	Serial No.	FCC ID
1	Notebook PC	HP	ProBook 4421s	CNF03242PJ	DoC
2	LCD Monitor	ViewSonic	VA1918wm	R18082200388	DoC
3	Micro SD	SanDisk	SDSDM-1024	BB07251CTE	---
4	External hard drive	TeraSys	F12-U	4912A002	---
5	Modem	ZyXEL	Omni 56K	S1Z4107727	1880MNI56K
6	USB 3.0	ADATA	C103/16GB	---	---
7	CF Adaptor	iEI	1211004-0040	00082900065	---
8	USB 2.0	---	---	---	---

Remark:

1. All the equipment/cables were placed in the worst-case configuration to maximize the emission during the test.
2. Grounding was established in accordance with the manufacturer's requirements and conditions for the intended use.



7. FCC PART 15 REQUIREMENTS

7.1 26 DB EMISSION BANDWIDTH

LIMIT

According to §15.303(c), for purposes of this subpart the emission bandwidth shall be determined by measuring the width of the signal between two points, one below the carrier center frequency and one above the carrier center frequency, that are 26 dB down relative to the maximum level of the modulated carrier. Compliance with the emissions limits is based on the use of measurement instrumentation employing a peak detector function with an instrument resolutions bandwidth approximately equal to 1.0 percent of the emission bandwidth of the device under measurement.

Test Configuration

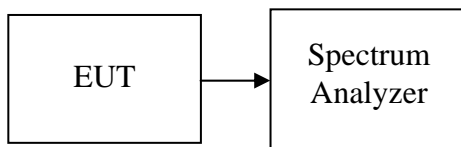

TEST PROCEDURE

1. Place the EUT on the table and set it in the transmitting mode.
2. Remove the antenna from the EUT and then connect a low-loss RF cable from the antenna port to the spectrum analyzer.
3. Set the spectrum analyzer as $RBW > 1\%EBW$, $VBW > RBW$, $Span > 26dB$ bandwidth, and Sweep = auto.
4. Mark the peak frequency and $-26dB$ (upper and lower) frequency.
5. Repeat until all the rest channels were investigated.

TEST RESULTS

No non-compliance noted



Test Data

Test mode: IEEE 802.11a mode / 5180 ~ 5240MHz

Channel	Frequency (MHz)	Bandwidth (MHz)
Low	5180	20.8
Mid	5220	21
High	5240	23.4666

Test mode: IEEE 802.11n HT 20 MHz mode / 5180 ~ 5240MHz

Channel	Frequency (MHz)	Bandwidth (MHz)
Low	5180	20.8
Mid	5220	20.8
High	5240	20.8

Test mode: IEEE 802.11n HT 40 MHz mode/ 5190 ~ 5230MHz

Channel	Frequency (MHz)	Bandwidth (MHz)
Low	5190	39.4
High	5230	39.3

Test mode: IEEE 802.11a mode / 5260 ~ 5320MHz

Channel	Frequency (MHz)	Bandwidth (MHz)
Low	5260	25.4666
Mid	5280	23.8667
High	5320	23.7333

Test mode: IEEE 802.11n HT 20 MHz mode / 5260 ~ 5320MHz

Channel	Frequency (MHz)	Bandwidth (MHz)
Low	5260	20.8666
Mid	5280	20.8
High	5320	21.0666

Test mode: IEEE 802.11n HT 40 MHz mode/ 5270 ~ 5310MHz

Channel	Frequency (MHz)	Bandwidth (MHz)
Low	5270	39.4
High	5310	39.3



Test mode: IEEE 802.11a mode / 5500 ~ 5700MHz

Channel	Frequency (MHz)	Bandwidth (MHz)
Low	5500	32
Mid	5600	24.1334
High	5700	30.6667

Test mode: IEEE 802.11n HT 20 MHz mode / 5500 ~ 5700MHz

Channel	Frequency (MHz)	Bandwidth (MHz)
Low	5500	21.6
Mid	5600	20.8
High	5700	21.2666

Test mode: IEEE 802.11n HT 40 MHz mode / 5510 ~ 5670MHz

Channel	Frequency (MHz)	Bandwidth (MHz)
Low	5510	39
Mid	5590	39
High	5670	39.1



Test Plot

IEEE 802.11a mode / 5180 ~ 5240MHz

CH Low

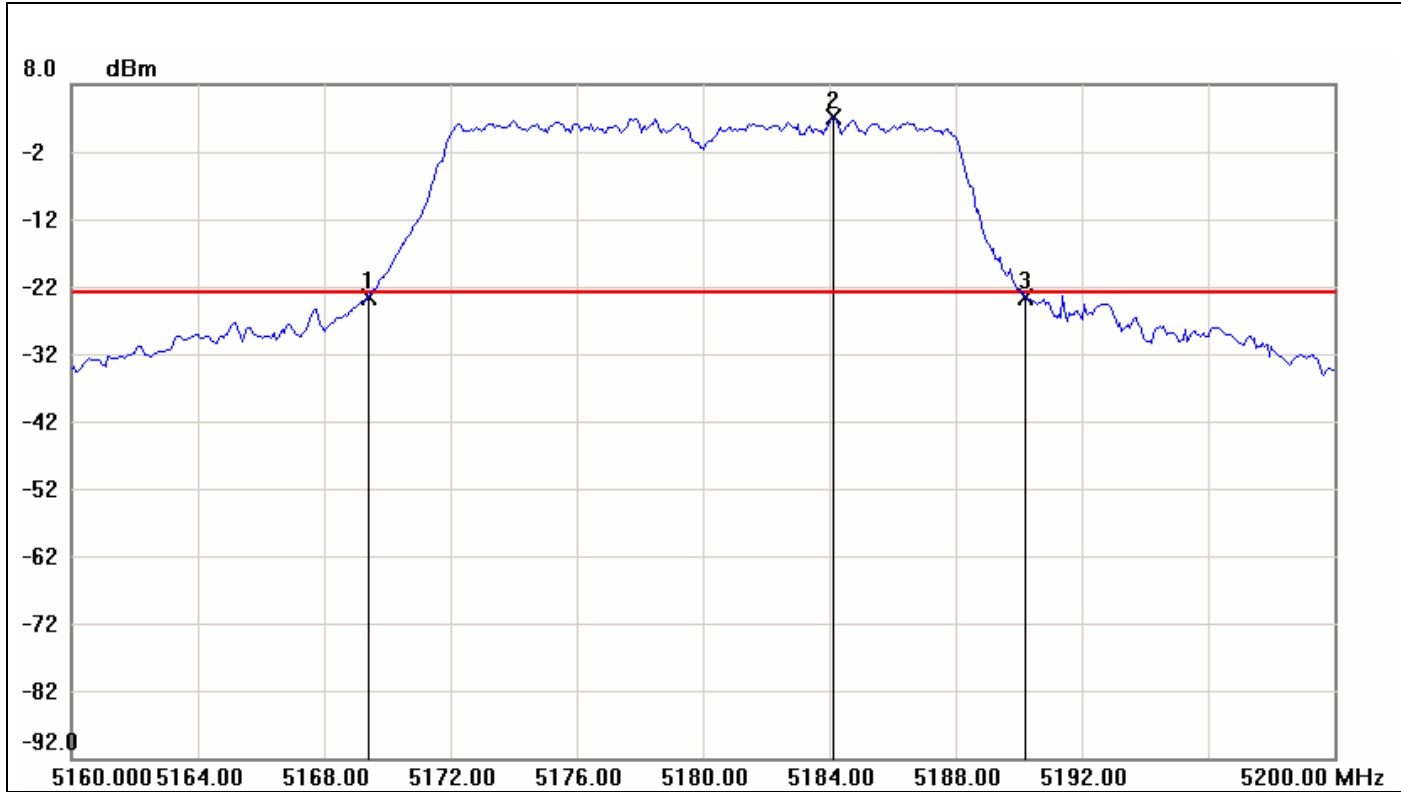

No.	Frequency(MHz)	Result(dBm)	Limit(dBm)	Margin(dBm)
1	5169.4000	-23.55	-22.89	-0.66
2	5184.1333	3.11	-22.89	26.00
3	5190.2000	-23.64	-22.89	-0.75

No.		Δ Frequency(MHz)	Δ Level(dB)
1	mk3-mk1	20.8	-0.09



CH Mid

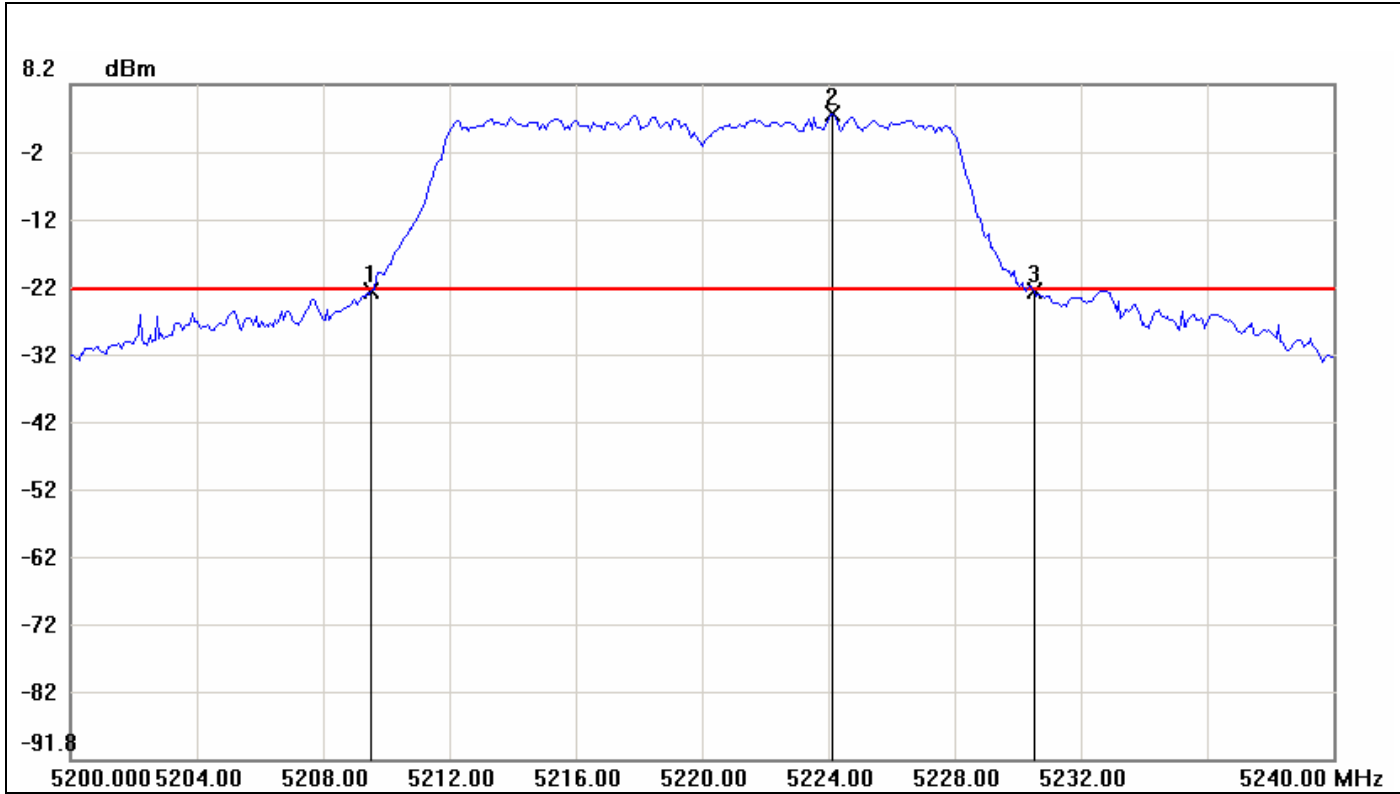

No.	Frequency(MHz)	Result(dBm)	Limit(dBm)	Margin(dBm)
1	5209.5333	-22.46	-22.20	-0.26
2	5224.1333	3.80	-22.20	26.00
3	5230.5333	-22.29	-22.20	-0.09

No.		Δ Frequency(MHz)	Δ Level(dB)
1	mk3-mk1	21	0.17



CH High

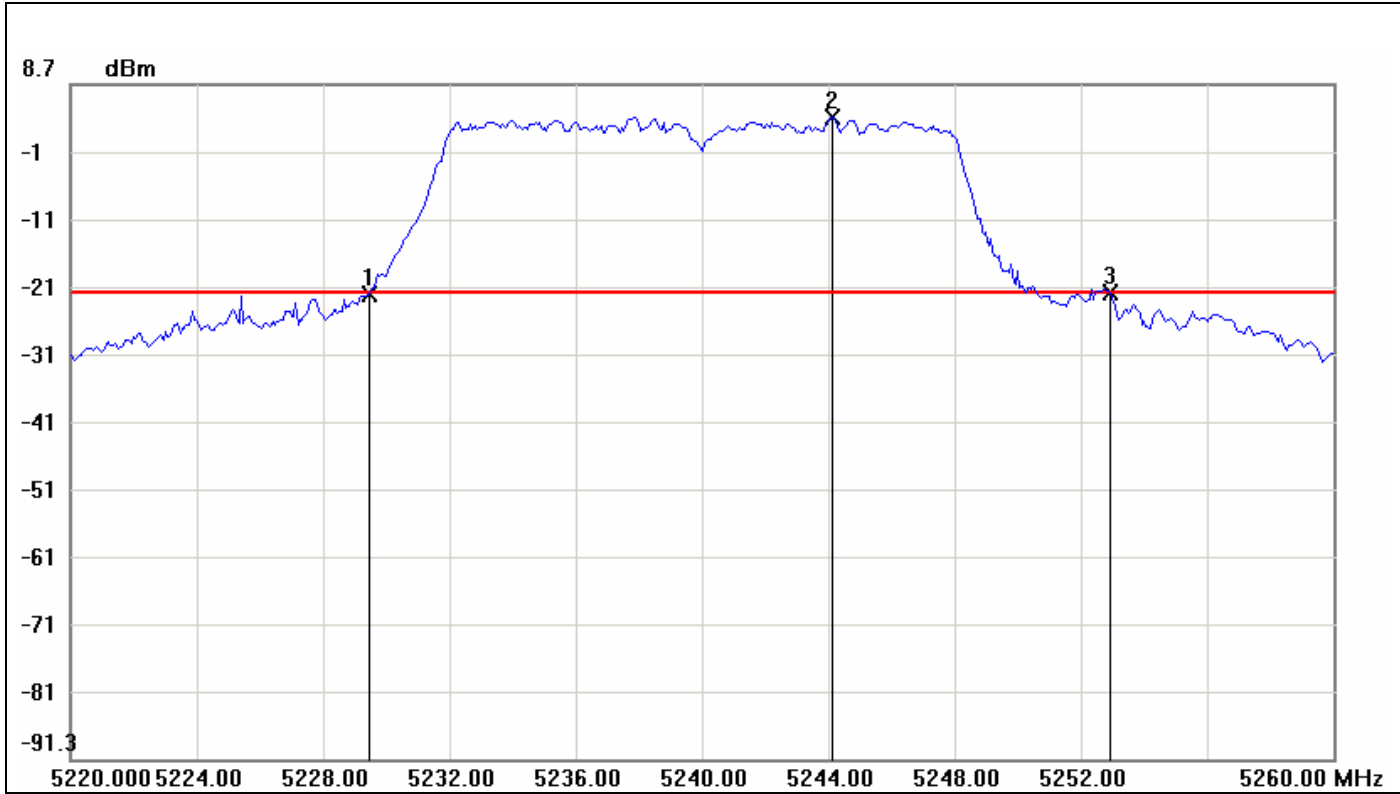

No.	Frequency(MHz)	Result(dBm)	Limit(dBm)	Margin(dBm)
1	5229.4667	-22.39	-22.13	-0.26
2	5244.1333	3.87	-22.13	26.00
3	5252.9333	-22.26	-22.13	-0.13

No.		Δ Frequency(MHz)	Δ Level(dB)
1	mk3-mk1	23.4666	0.13



IEEE 802.11n HT 20 MHz mode / 5180 ~ 5240MHz

CH Low

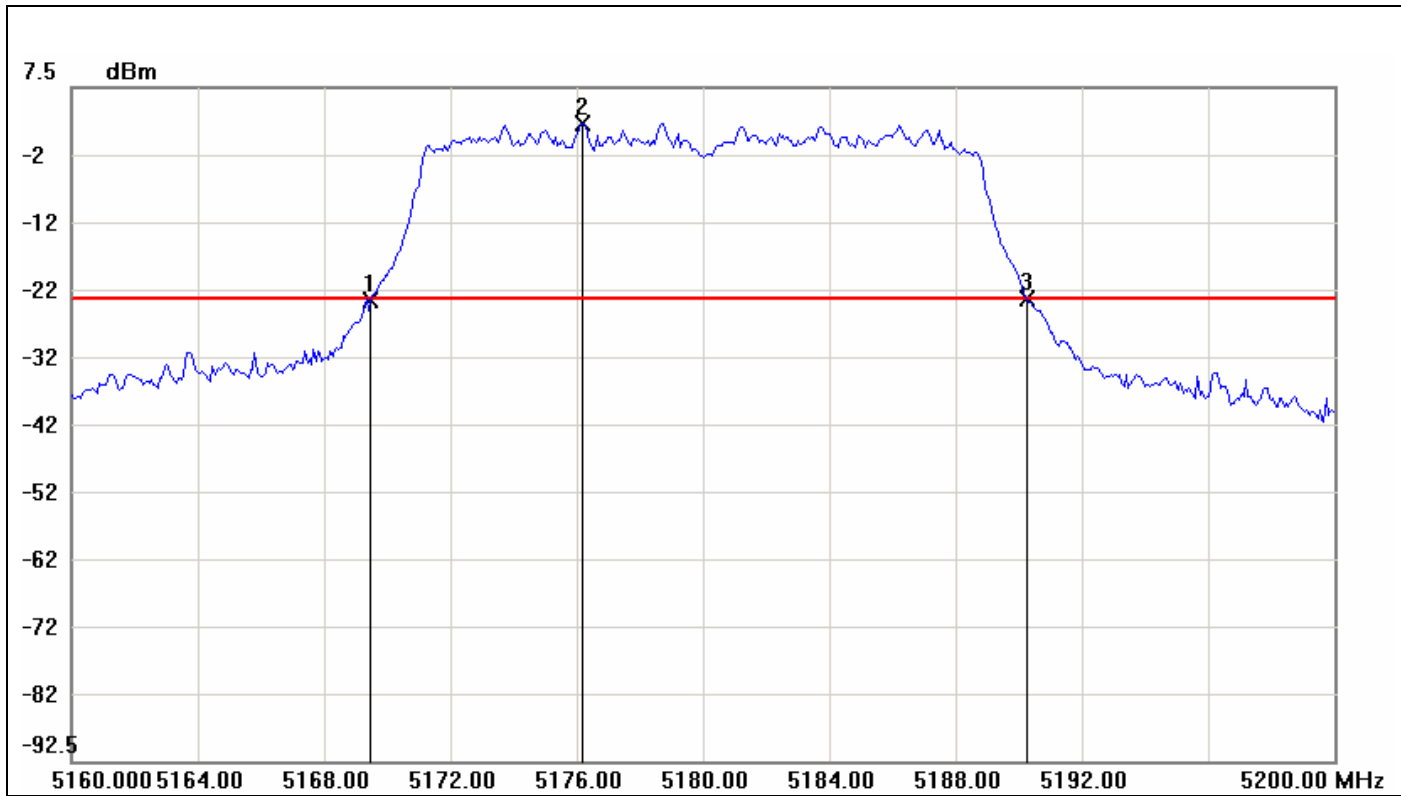

No.	Frequency(MHz)	Result(dBm)	Limit(dBm)	Margin(dBm)
1	5169.4667	-24.21	-23.87	-0.34
2	5176.2000	2.13	-23.87	26.00
3	5190.2667	-23.90	-23.87	-0.03

No.		Δ Frequency(MHz)	Δ Level(dB)
1	mk3-mk1	20.8	0.31



CH Mid

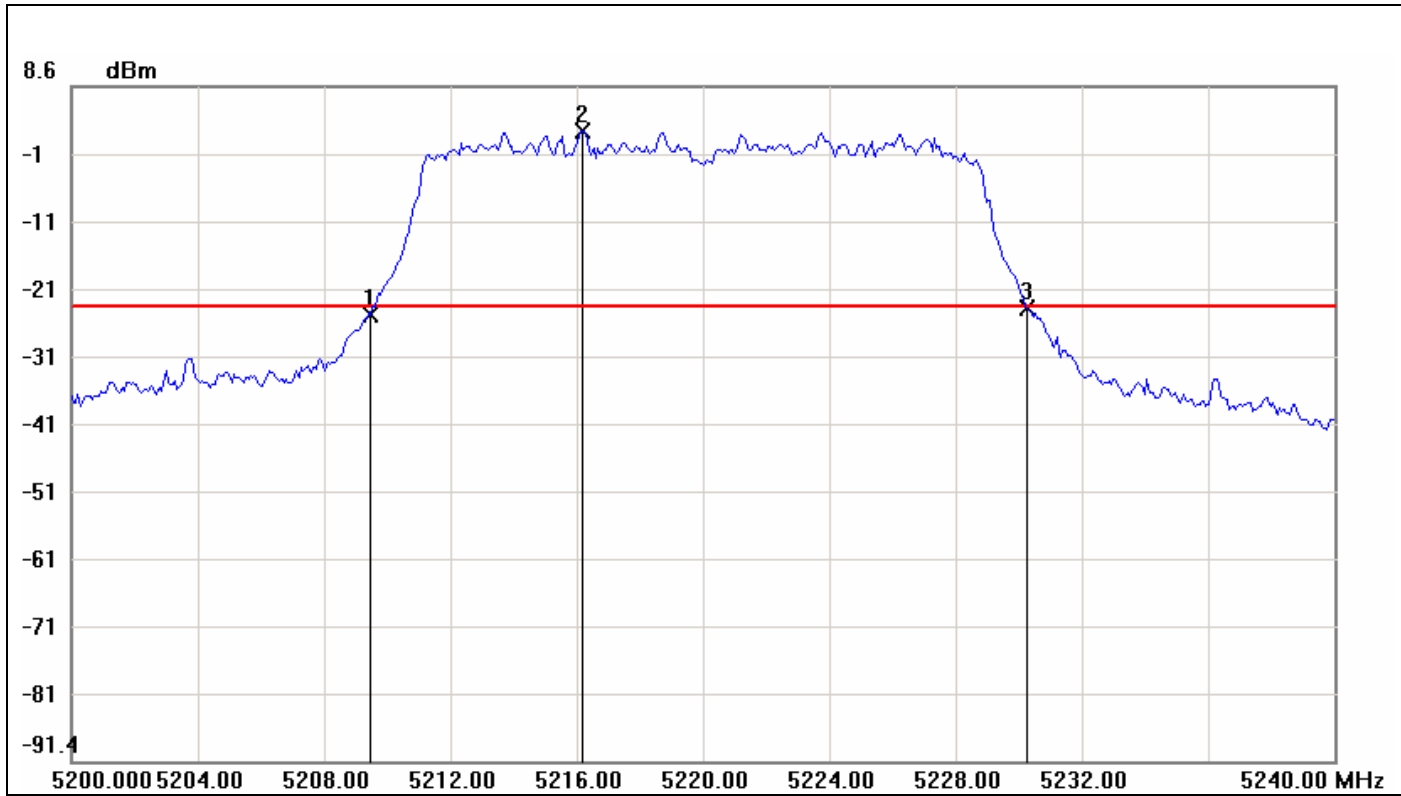

No.	Frequency(MHz)	Result(dBm)	Limit(dBm)	Margin(dBm)
1	5209.4667	-25.33	-24.09	-1.24
2	5216.2000	1.91	-24.09	26.00
3	5230.2667	-24.12	-24.09	-0.03

No.		Δ Frequency(MHz)	Δ Level(dB)
1	mk3-mk1	20.8	1.21



CH High

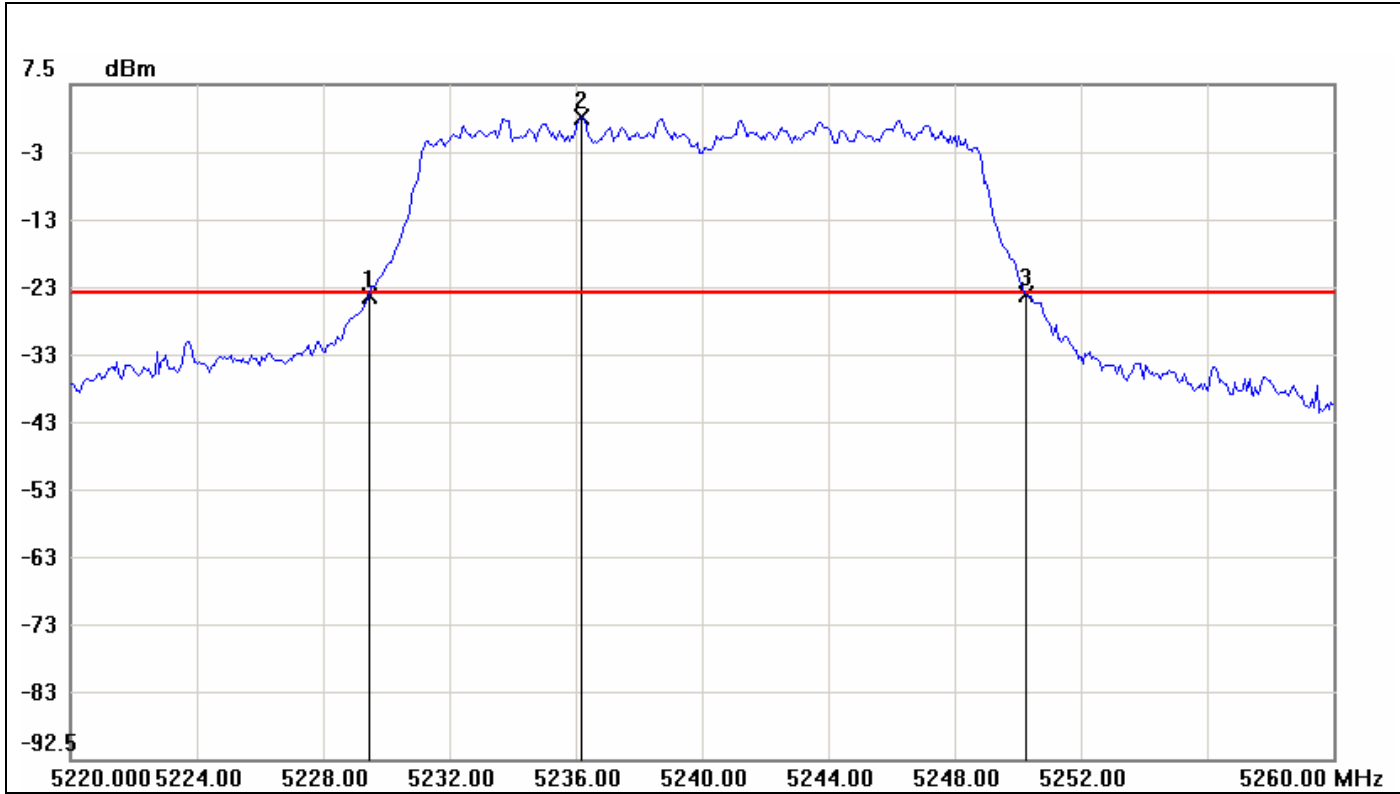

No.	Frequency(MHz)	Result(dBm)	Limit(dBm)	Margin(dBm)
1	5229.4667	-24.03	-23.52	-0.51
2	5236.2000	2.48	-23.52	26.00
3	5250.2667	-23.58	-23.52	-0.06

No.		Δ Frequency(MHz)	Δ Level(dB)
1	mk3-mk1	20.8	0.45



IEEE 802.11n HT 40 MHz mode / 5190 ~ 5230MHz

CH Low

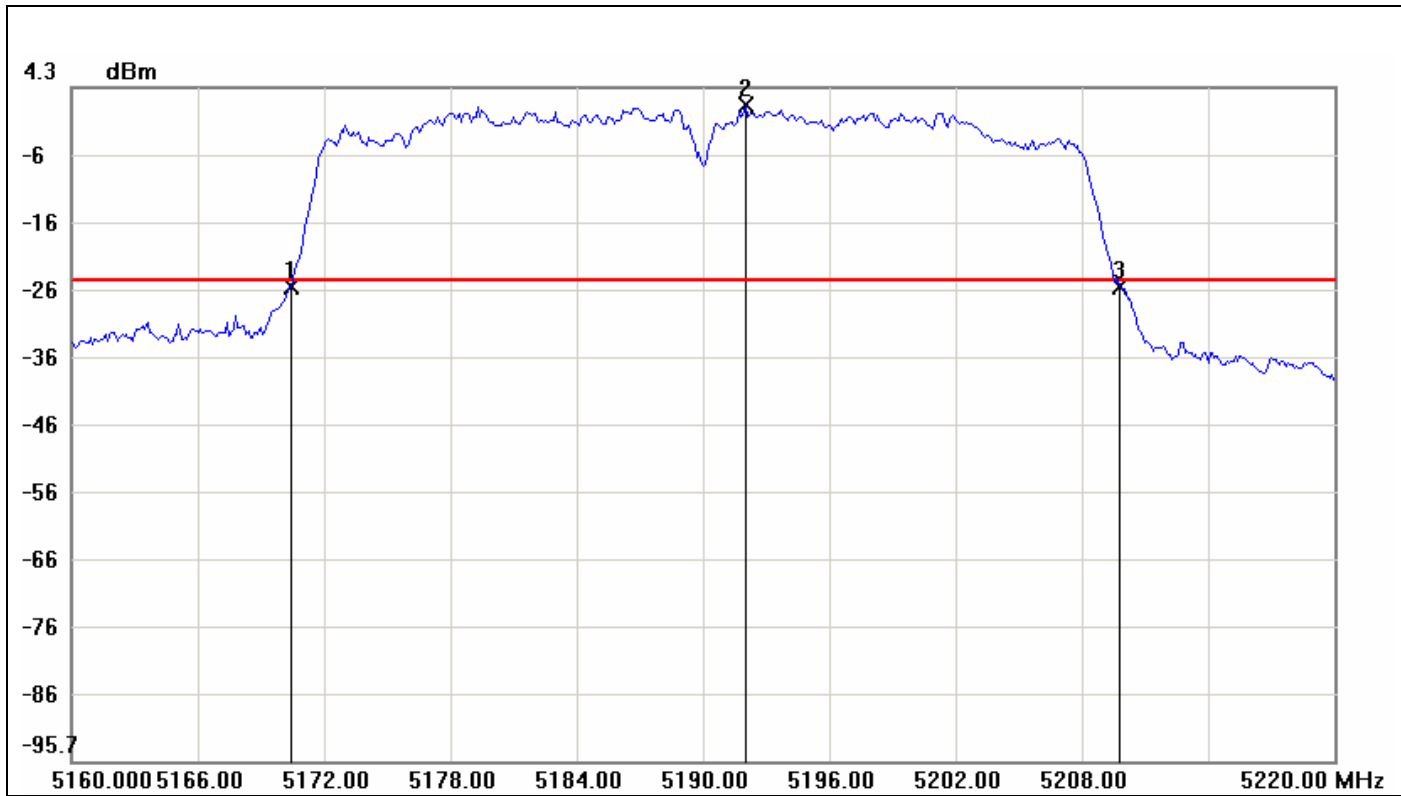

No.	Frequency(MHz)	Result(dBm)	Limit(dBm)	Margin(dBm)
1	5170.4000	-25.23	-24.30	-0.93
2	5192.0000	1.70	-24.30	26.00
3	5209.8000	-25.47	-24.30	-1.17

No.		Δ Frequency(MHz)	Δ Level(dB)
1	mk3-mk1	39.4	-0.24



CH High

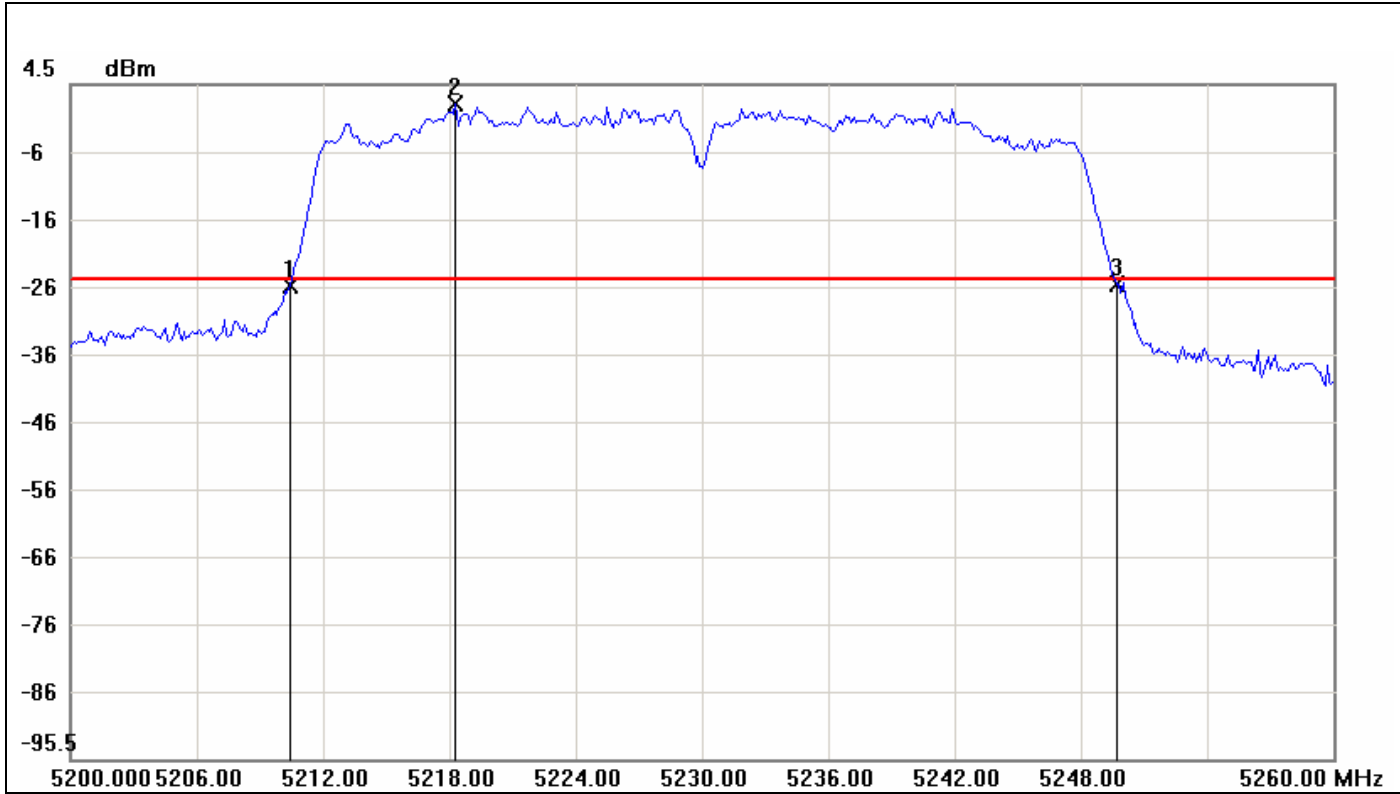

No.	Frequency(MHz)	Result(dBm)	Limit(dBm)	Margin(dBm)
1	5210.4000	-25.25	-24.41	-0.84
2	5218.3000	1.59	-24.41	26.00
3	5249.7000	-25.21	-24.41	-0.80

No.		Δ Frequency(MHz)	Δ Level(dB)
1	mk3-mk1	39.3	0.04



IEEE 802.11a mode / 5260 ~ 5320MHz

CH Low

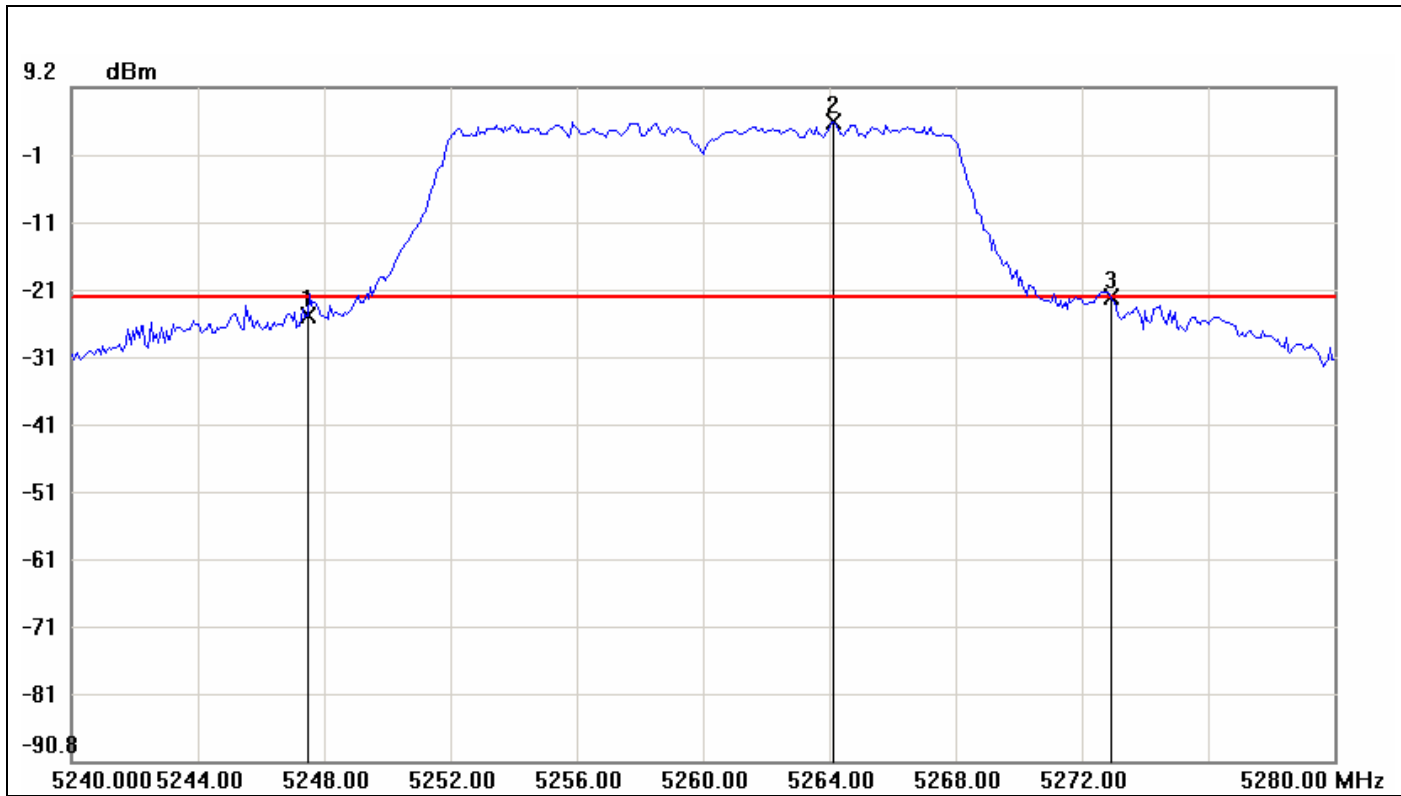

No.	Frequency(MHz)	Result(dBm)	Limit(dBm)	Margin(dBm)
1	5247.4667	-24.56	-21.82	-2.74
2	5264.1333	4.18	-21.82	26.00
3	5272.9333	-21.85	-21.82	-0.03

No.		Δ Frequency(MHz)	Δ Level(dB)
1	mk3-mk1	25.4666	2.71



CH Mid

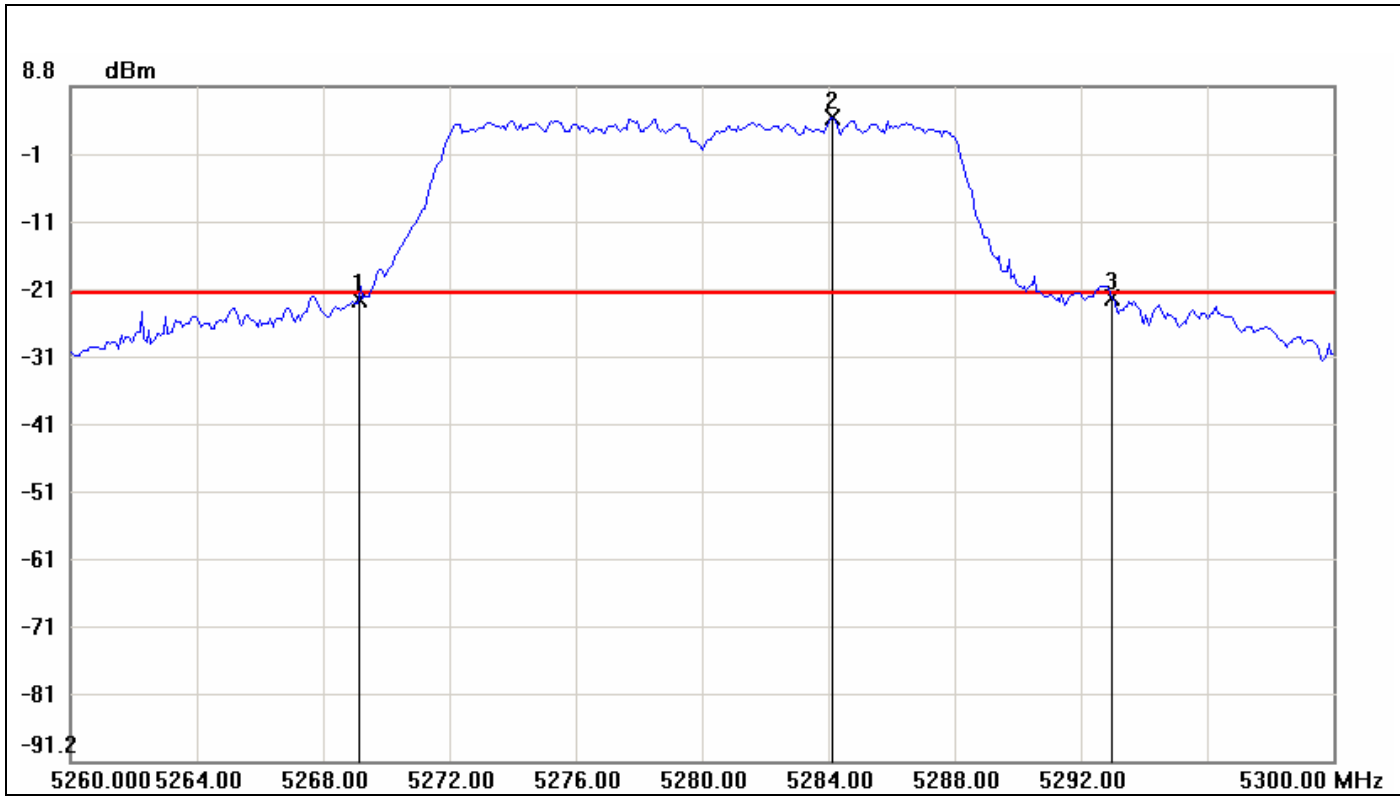

No.	Frequency(MHz)	Result(dBm)	Limit(dBm)	Margin(dBm)
1	5269.1333	-22.69	-21.83	-0.86
2	5284.1333	4.17	-21.83	26.00
3	5293.0000	-22.45	-21.83	-0.62

No.		Δ Frequency(MHz)	Δ Level(dB)
1	mk3-mk1	23.8667	0.24



CH High

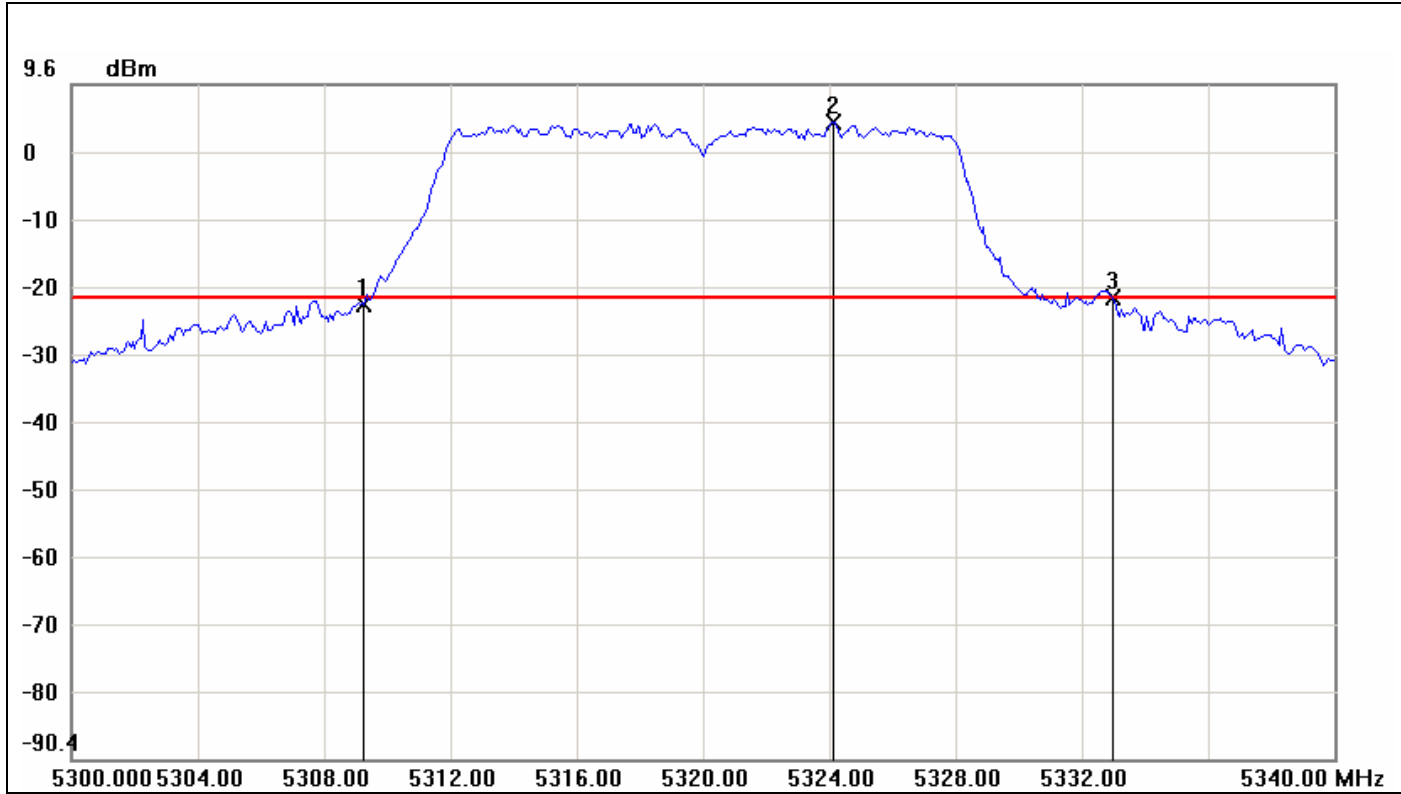

No.	Frequency(MHz)	Result(dBm)	Limit(dBm)	Margin(dBm)
1	5309.2667	-22.98	-22.03	-0.95
2	5324.1333	3.97	-22.03	26.00
3	5333.0000	-22.13	-22.03	-0.10

No.		Δ Frequency(MHz)	Δ Level(dB)
1	mk3-mk1	23.7333	0.85



IEEE 802.11n HT 20 MHz mode / 5260 ~ 5320MHz

CH Low

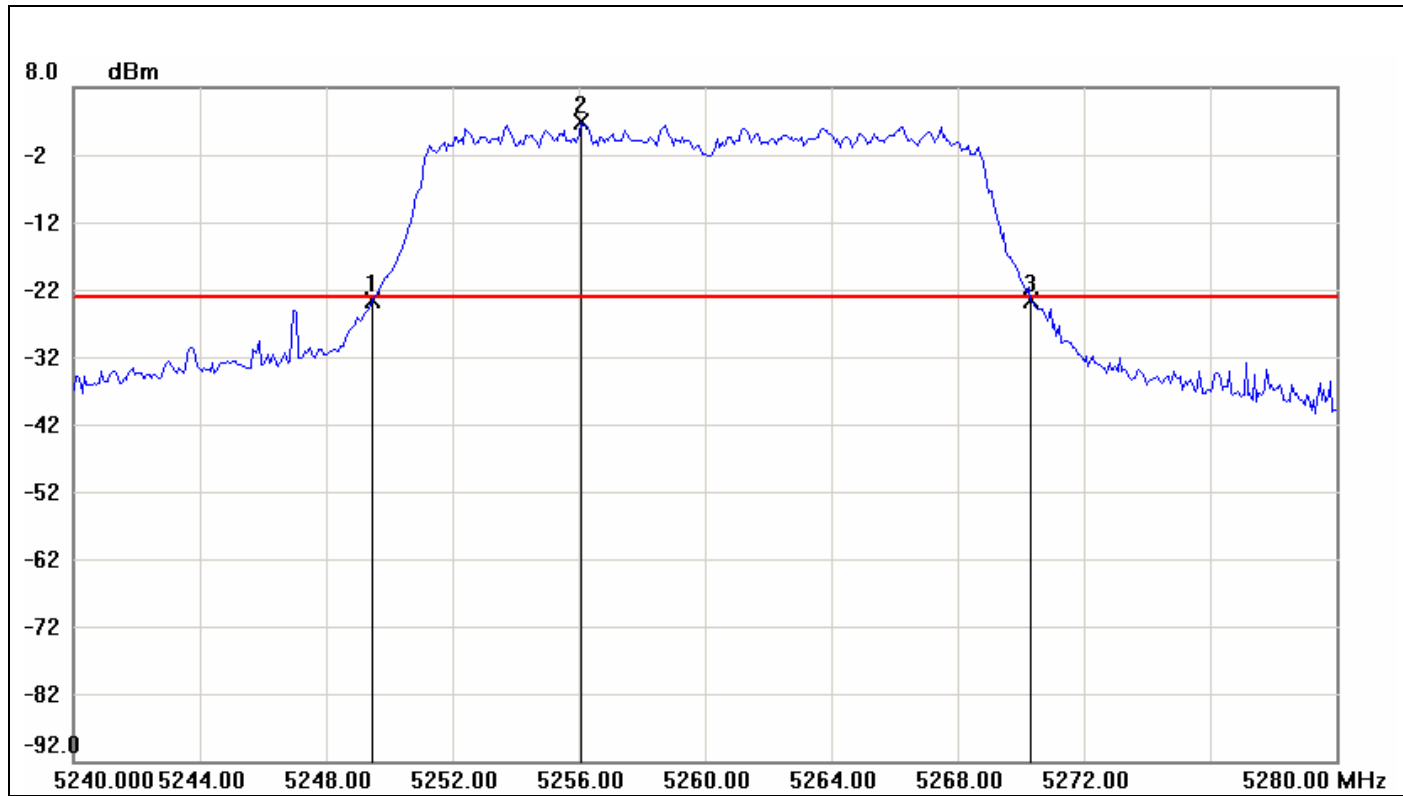

No.	Frequency(MHz)	Result(dBm)	Limit(dBm)	Margin(dBm)
1	5249.4667	-23.73	-23.17	-0.56
2	5256.0667	2.83	-23.17	26.00
3	5270.3333	-23.55	-23.17	-0.38

No.		Δ Frequency(MHz)	Δ Level(dB)
1	mk3-mk1	20.8666	0.18



CH Mid

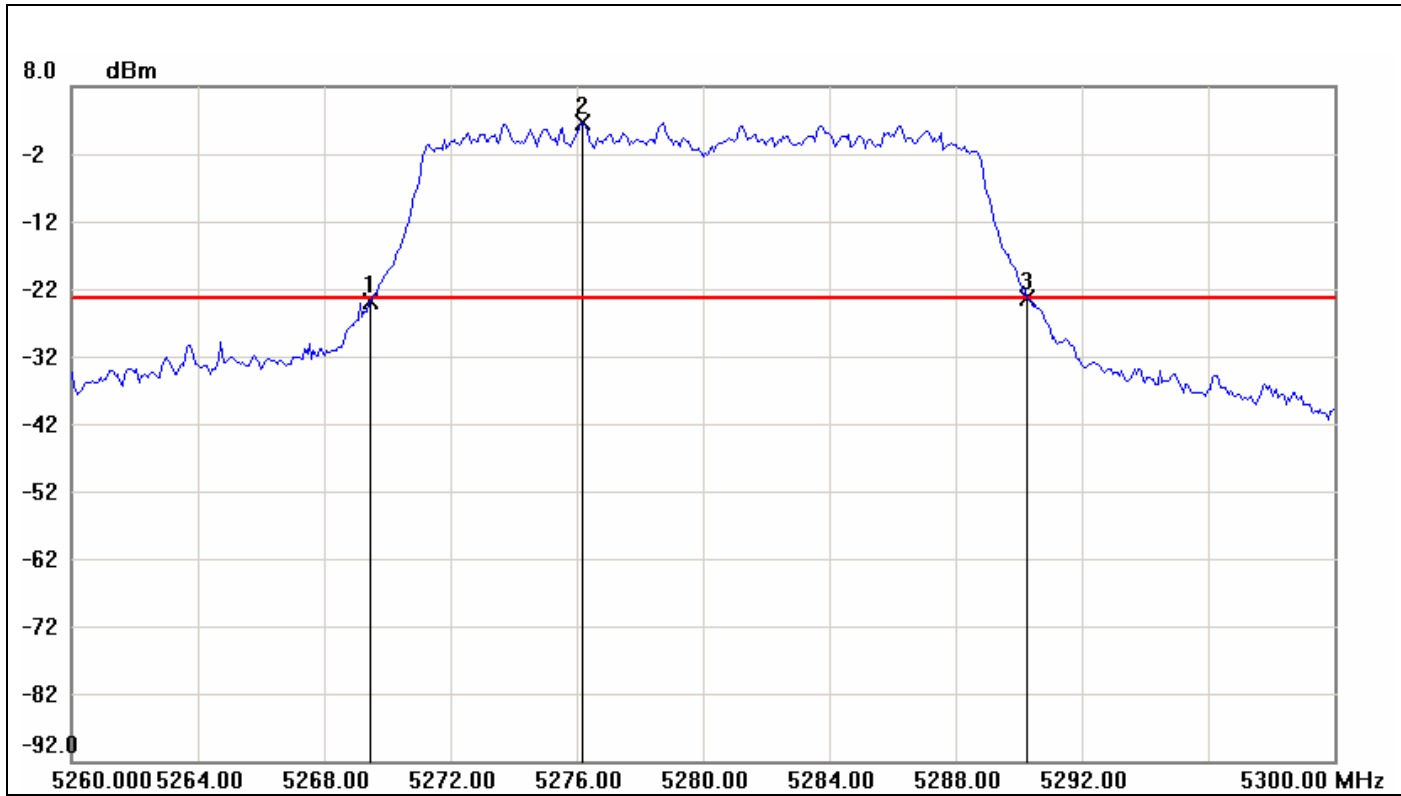

No.	Frequency(MHz)	Result(dBm)	Limit(dBm)	Margin(dBm)
1	5269.4667	-24.00	-23.35	-0.65
2	5276.2000	2.65	-23.35	26.00
3	5290.2667	-23.39	-23.35	-0.04

No.		Δ Frequency(MHz)	Δ Level(dB)
1	mk3-mk1	20.8	0.61



CH High

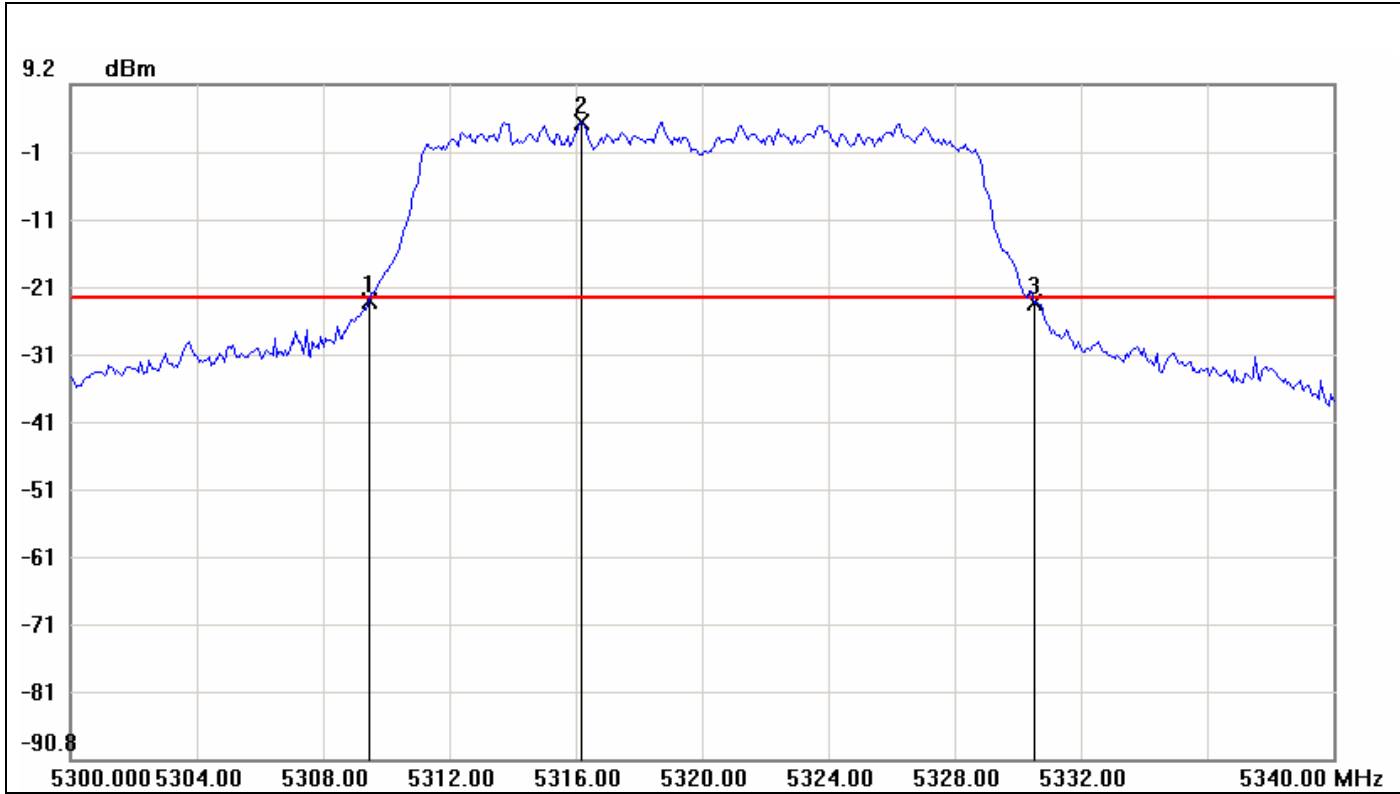

No.	Frequency(MHz)	Result(dBm)	Limit(dBm)	Margin(dBm)
1	5309.4667	-23.00	-22.30	-0.70
2	5316.2000	3.70	-22.30	26.00
3	5330.5333	-23.19	-22.30	-0.89

No.		Δ Frequency(MHz)	Δ Level(dB)
1	mk3-mk1	21.0666	-0.19



IEEE 802.11n HT 40 MHz mode / 5270 ~ 5310MHz

CH Low

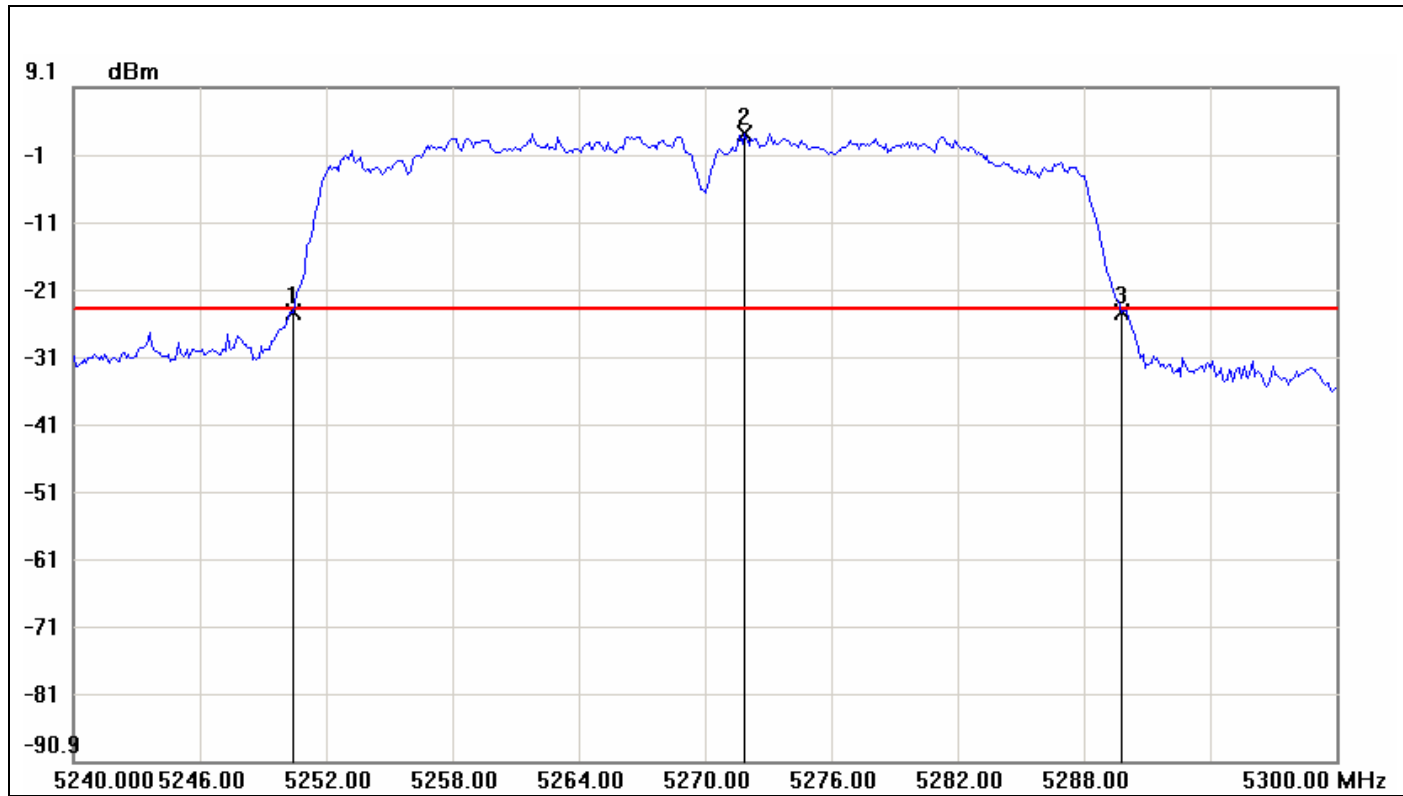

No.	Frequency(MHz)	Result(dBm)	Limit(dBm)	Margin(dBm)
1	5250.4000	-24.22	-23.68	-0.54
2	5271.9000	2.32	-23.68	26.00
3	5289.8000	-24.17	-23.68	-0.49

No.		Δ Frequency(MHz)	Δ Level(dB)
1	mk3-mk1	39.4	0.05



CH High

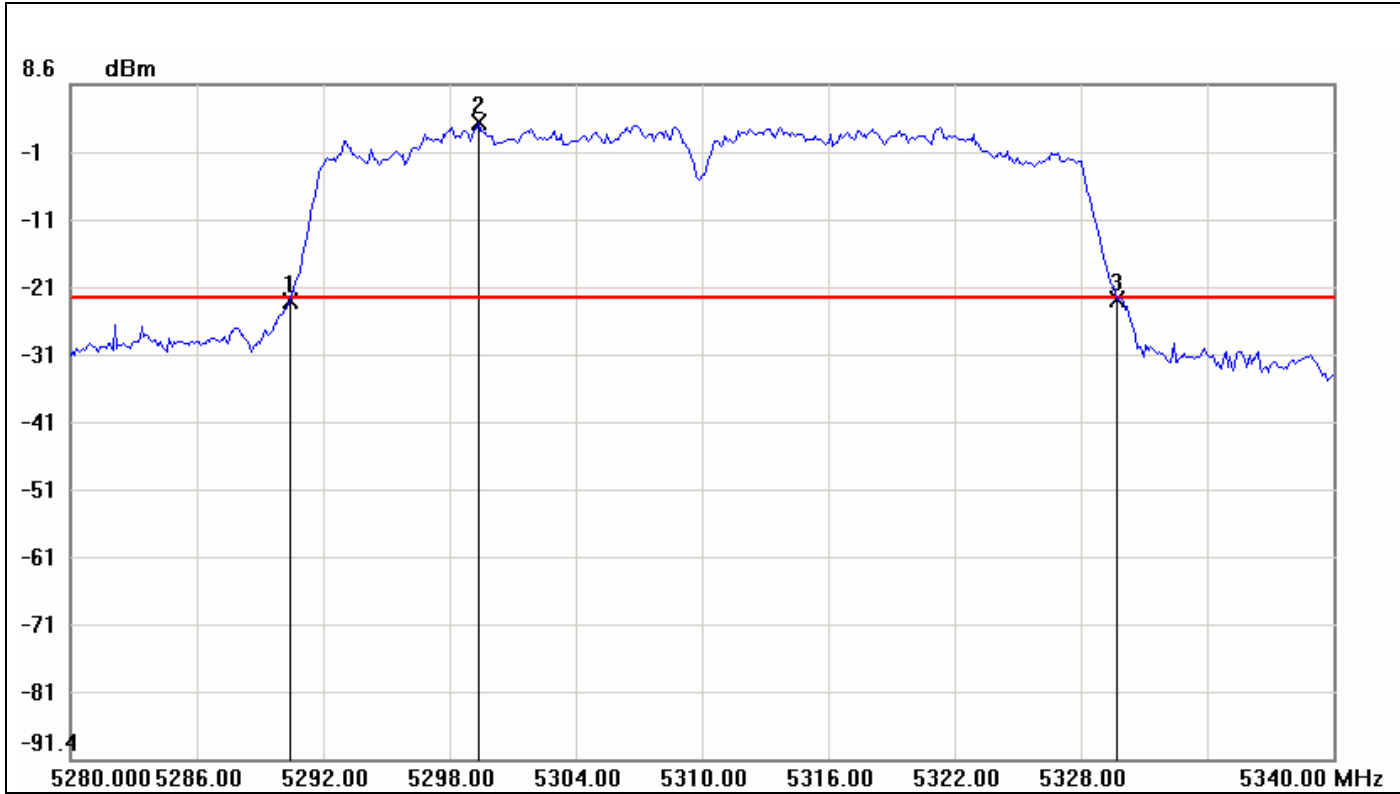

No.	Frequency(MHz)	Result(dBm)	Limit(dBm)	Margin(dBm)
1	5290.4000	-23.56	-22.98	-0.58
2	5299.4000	3.02	-22.98	26.00
3	5329.7000	-23.19	-22.98	-0.21

No.		Δ Frequency(MHz)	Δ Level(dB)
1	mk3-mk1	39.3	0.37



Test mode: IEEE 802.11a mode / 5500 ~ 5700MHz

CH Low

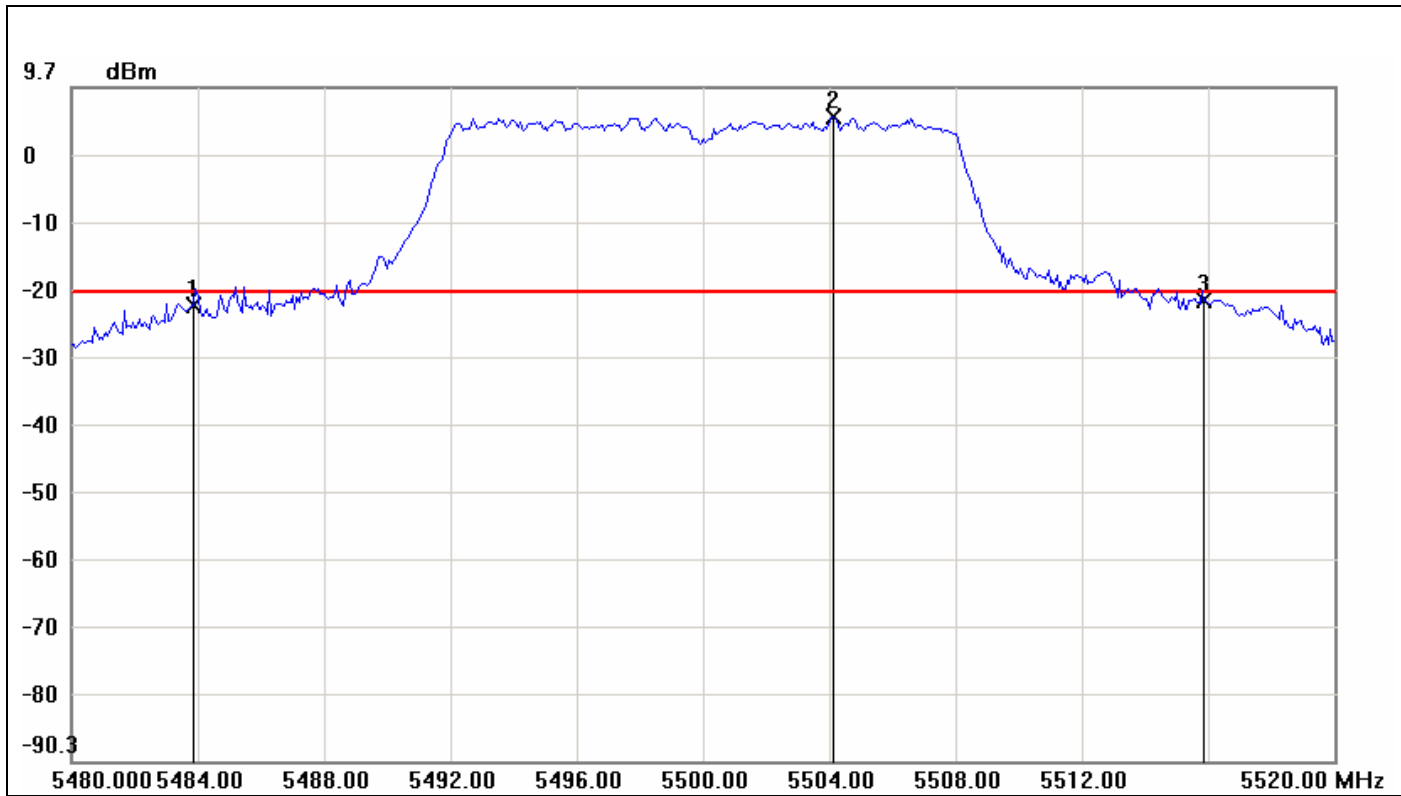

No.	Frequency(MHz)	Result(dBm)	Limit(dBm)	Margin(dBm)
1	5483.8667	-22.55	-20.59	-1.96
2	5504.1333	5.41	-20.59	26.00
3	5515.8667	-21.83	-20.59	-1.24

No.		Δ Frequency(MHz)	Δ Level(dB)
1	mk3-mk1	32	0.72



CH Mid

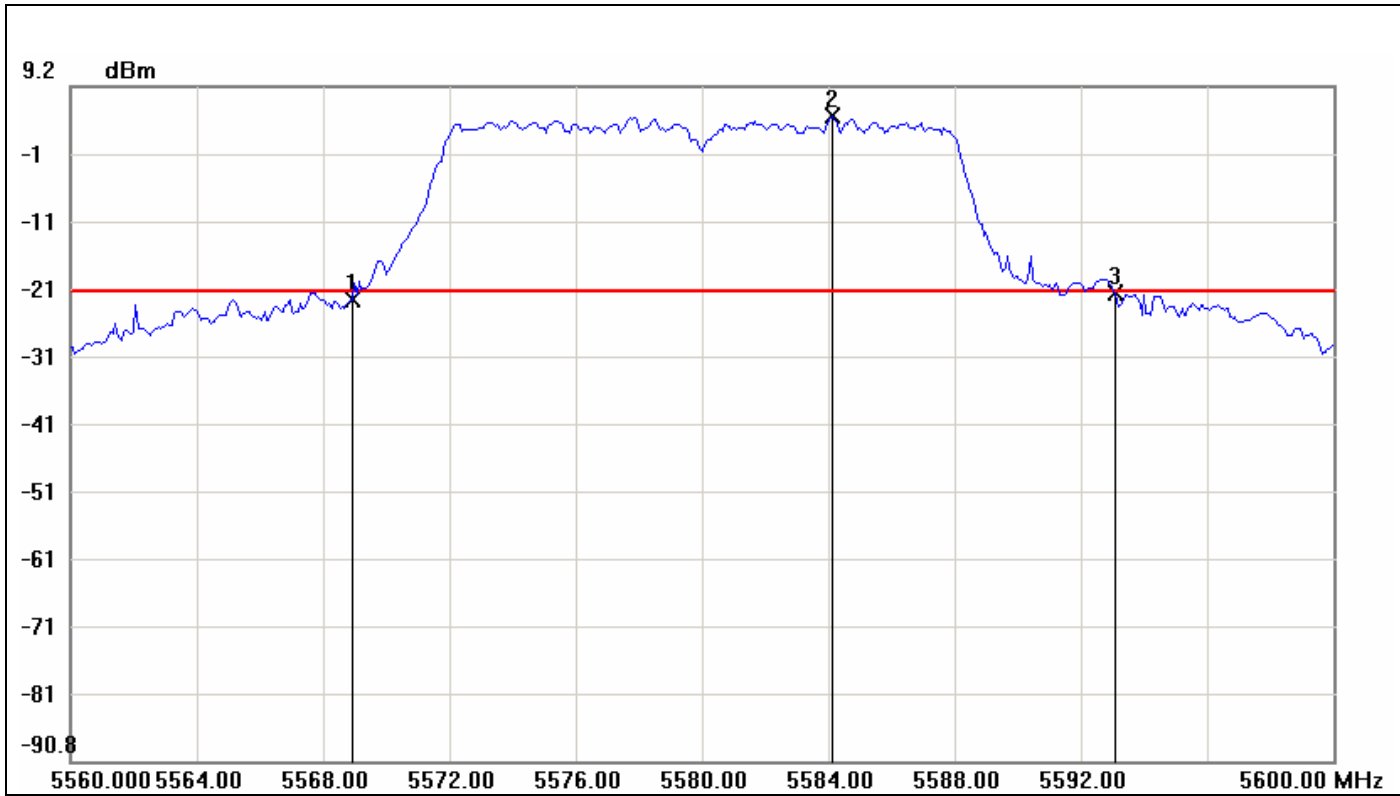

No.	Frequency(MHz)	Result(dBm)	Limit(dBm)	Margin(dBm)
1	5568.9333	-22.40	-21.30	-1.10
2	5584.1333	4.70	-21.30	26.00
3	5593.0667	-21.46	-21.30	-0.16

No.		Δ Frequency(MHz)	Δ Level(dB)
1	mk3-mk1	24.1334	0.94



CH High

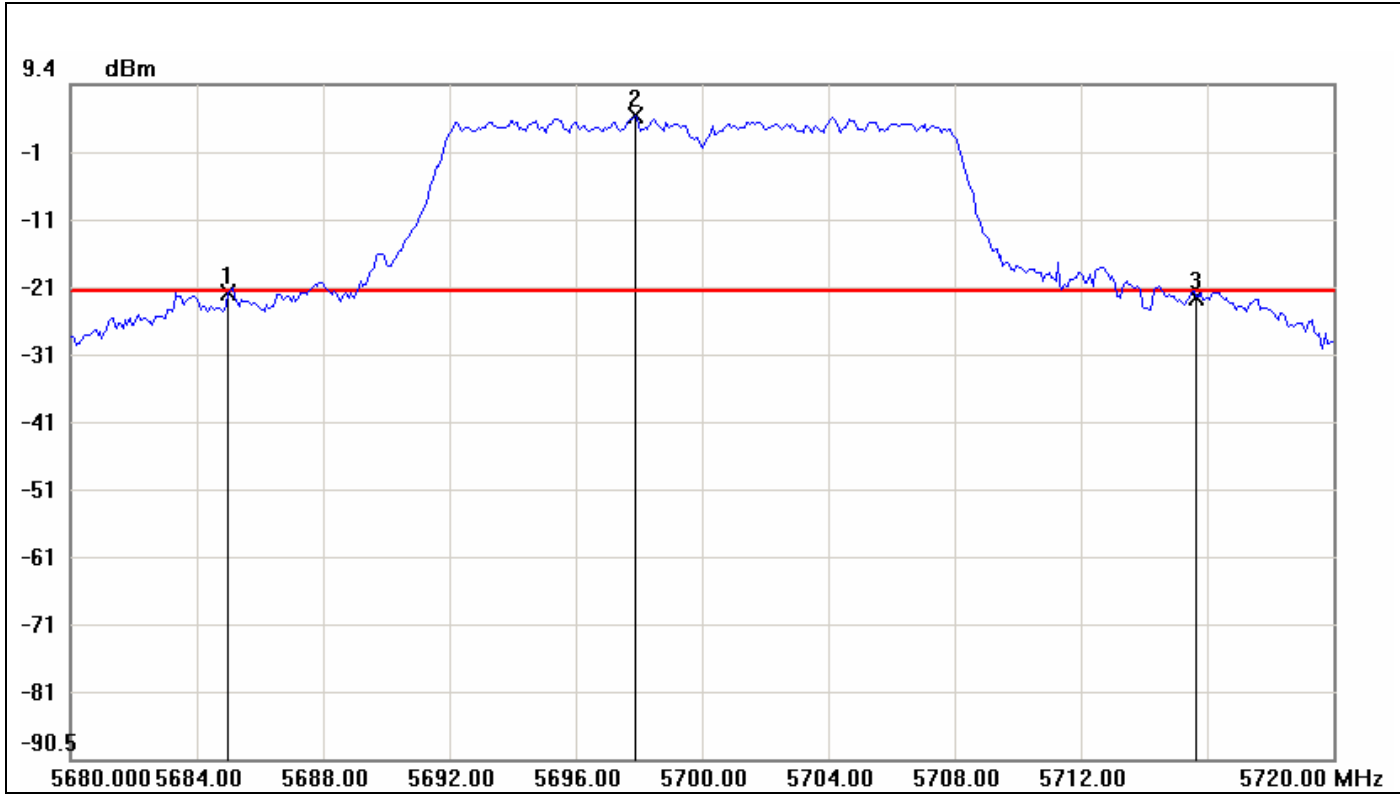

No.	Frequency(MHz)	Result(dBm)	Limit(dBm)	Margin(dBm)
1	5685.0000	-21.44	-21.24	-0.20
2	5697.8667	4.76	-21.24	26.00
3	5715.6667	-22.05	-21.24	-0.81

No.		Δ Frequency(MHz)	Δ Level(dB)
1	mk3-mk1	30.6667	-0.61



IEEE 802.11n HT 20 MHz mode / 5500 ~ 5700MHz

CH Low

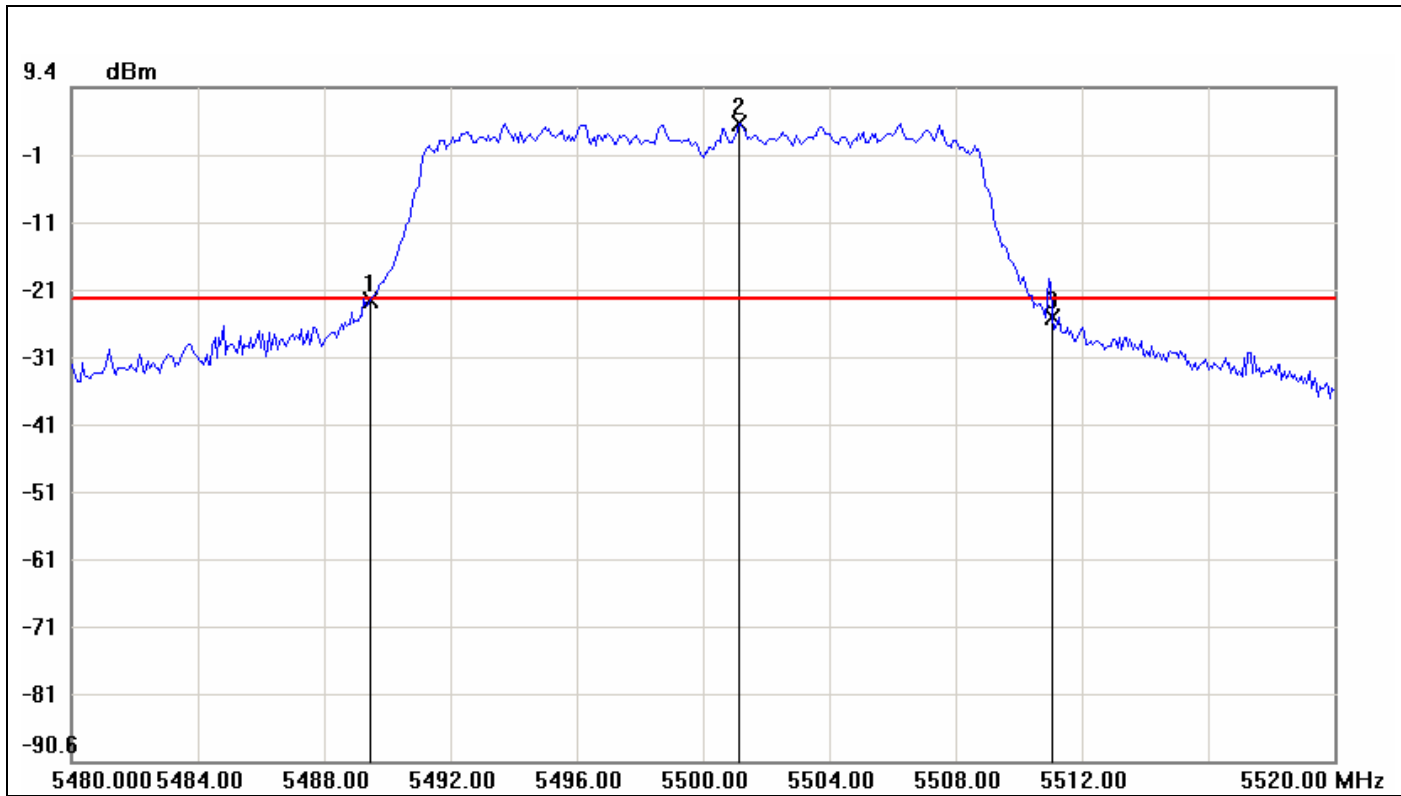

No.	Frequency(MHz)	Result(dBm)	Limit(dBm)	Margin(dBm)
1	5489.4667	-22.32	-21.87	-0.45
2	5501.1333	4.13	-21.87	26.00
3	5511.0667	-24.65	-21.87	-2.78

No.		Δ Frequency(MHz)	Δ Level(dB)
1	mk3-mk1	21.6	-2.33



CH Mid

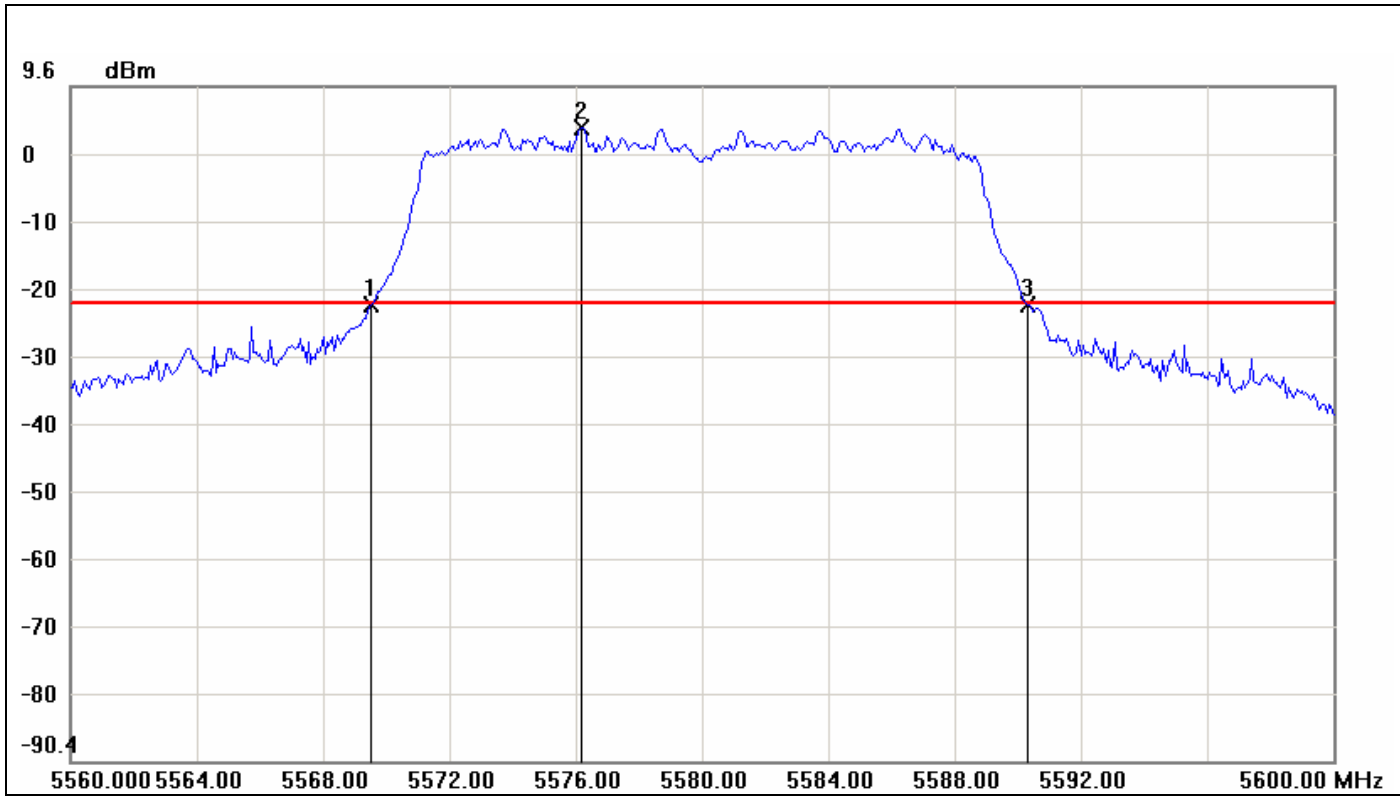

No.	Frequency(MHz)	Result(dBm)	Limit(dBm)	Margin(dBm)
1	5569.5333	-22.67	-22.63	-0.04
2	5576.2000	3.37	-22.63	26.00
3	5590.3333	-22.78	-22.63	-0.15

No.		Δ Frequency(MHz)	Δ Level(dB)
1	mk3-mk1	20.8	-0.11



CH High

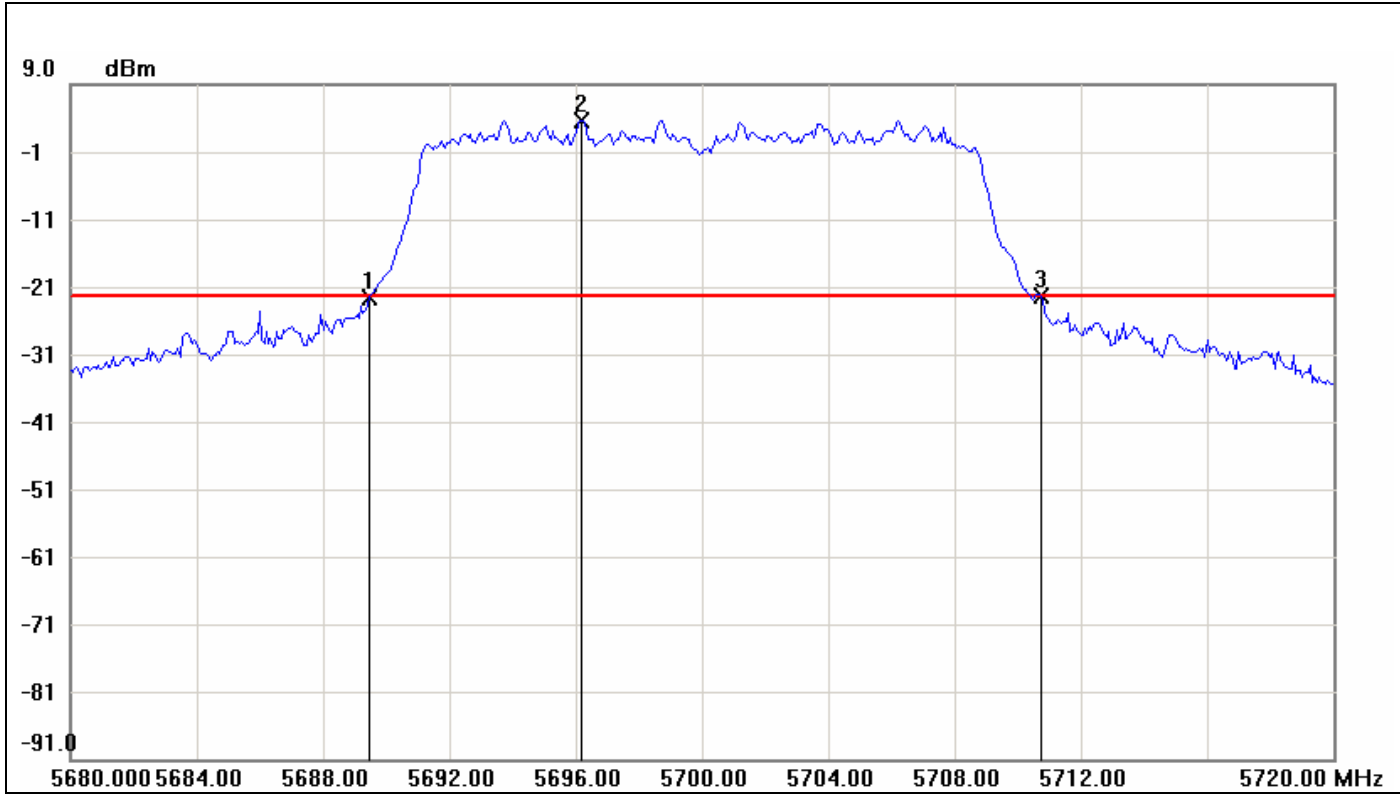

No.	Frequency(MHz)	Result(dBm)	Limit(dBm)	Margin(dBm)
1	5689.4667	-22.59	-22.36	-0.23
2	5696.2000	3.64	-22.36	26.00
3	5710.7333	-22.41	-22.36	-0.05

No.		Δ Frequency(MHz)	Δ Level(dB)
1	mk3-mk1	21.2666	0.18



IEEE 802.11n HT 40 MHz mode / 5510 ~ 5670MHz

CH Low

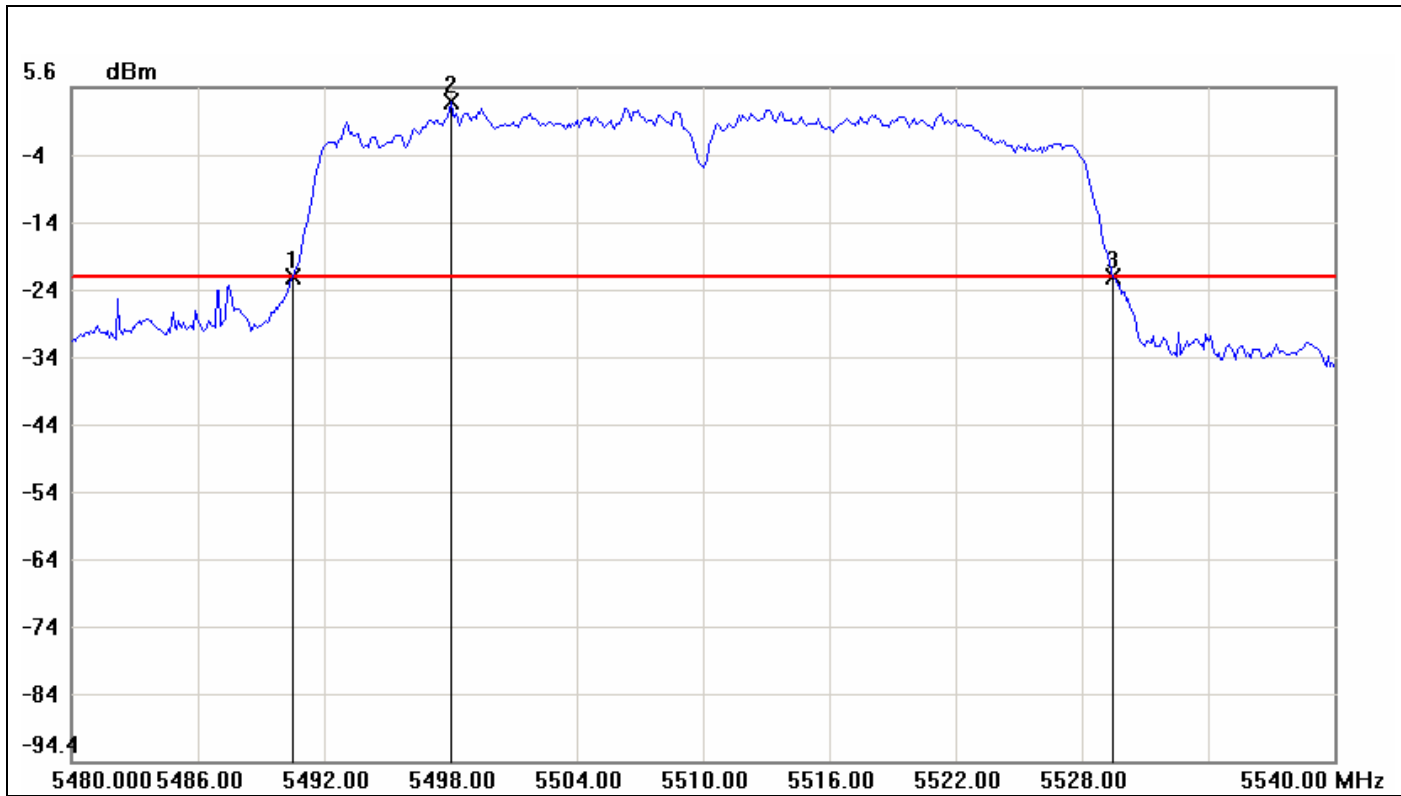

No.	Frequency(MHz)	Result(dBm)	Limit(dBm)	Margin(dBm)
1	5490.5000	-22.58	-22.40	-0.18
2	5498.0000	3.60	-22.40	26.00
3	5529.5000	-22.51	-22.40	-0.11

No.		ΔFrequency(MHz)	ΔLevel(dB)
1	mk3-mk1	39	0.07



CH Mid

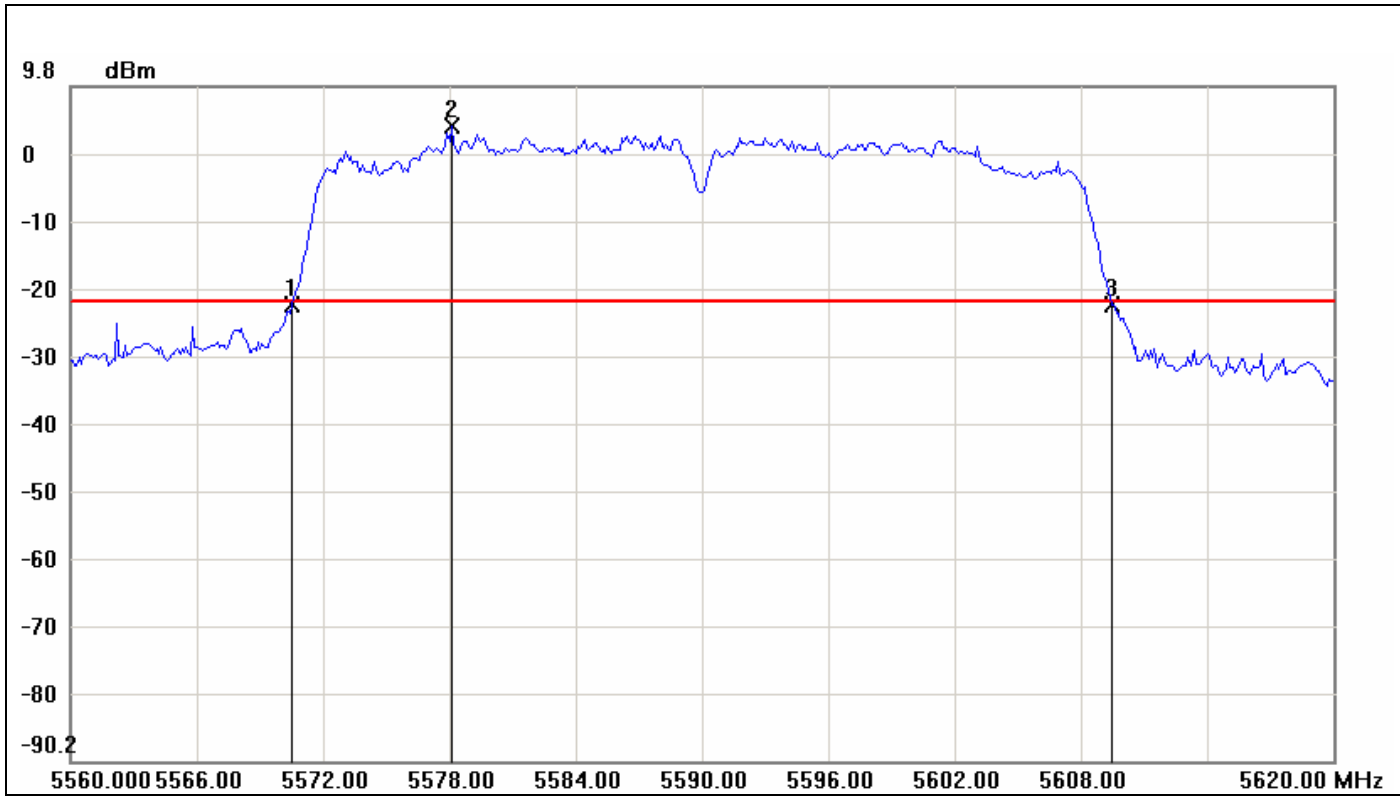

No.	Frequency(MHz)	Result(dBm)	Limit(dBm)	Margin(dBm)
1	5530.5000	-22.52	-22.06	-0.46
2	5538.1000	3.94	-22.06	26.00
3	5569.5000	-22.57	-22.06	-0.51

No.		Δ Frequency(MHz)	Δ Level(dB)
1	mk3-mk1	39	-0.05



CH High

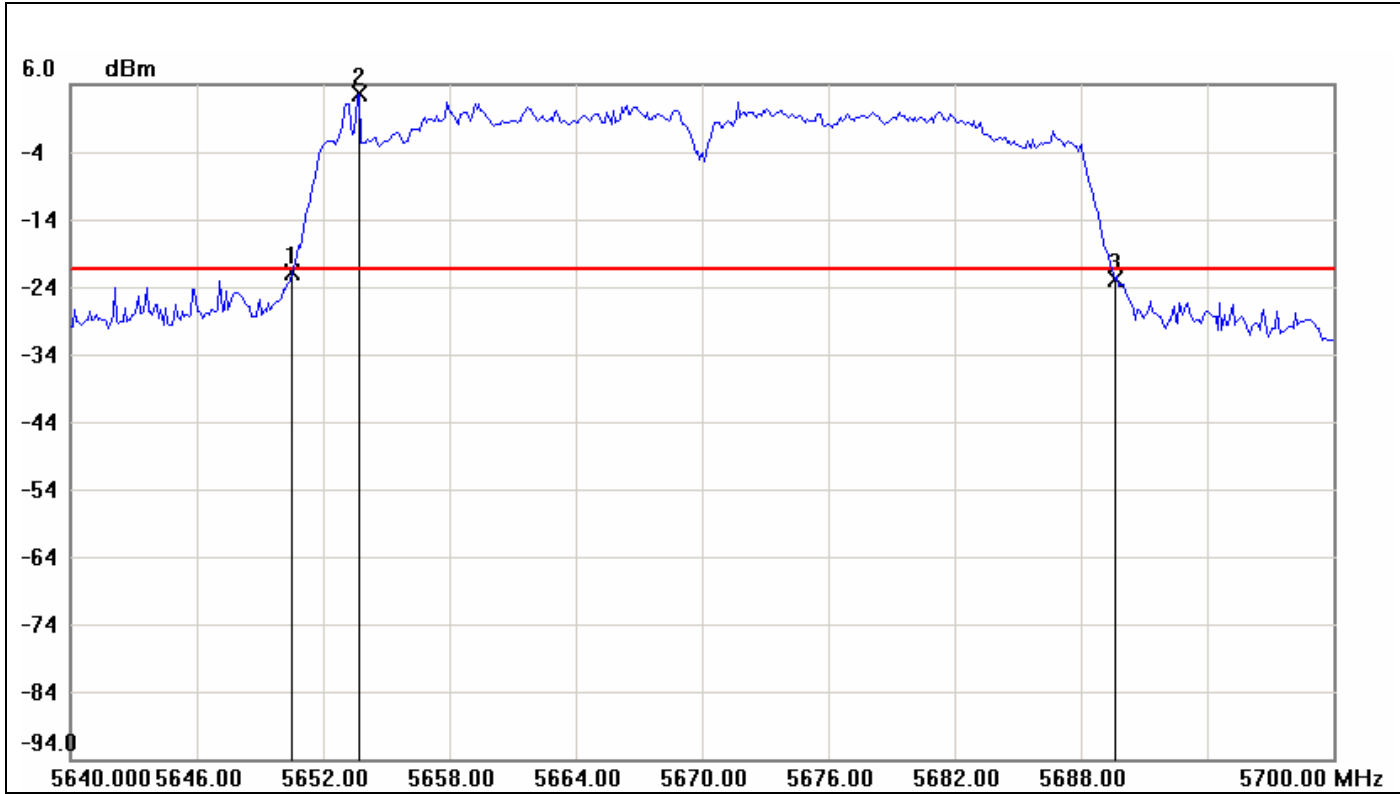

No.	Frequency(MHz)	Result(dBm)	Limit(dBm)	Margin(dBm)
1	5650.5000	-21.94	-21.40	-0.54
2	5653.7000	4.60	-21.40	26.00
3	5689.6000	-22.83	-21.40	-1.43

No.		Δ Frequency(MHz)	Δ Level(dB)
1	mk3-mk1	39.1	-0.89



7.2 MAXIMUM CONDUCTED OUTPUT POWER

LIMIT

According to §15.407(a),

- (1) For the band 5.15-5.25 GHz, the maximum conducted output power over the frequency band of operation shall not exceed the lesser of 50 mW or $4 \text{ dBm} + 10 \log B$, where B is the 26 dB emission bandwidth in MHz.
- (2) For the 5.25-5.35 GHz and 5.47-5.725 GHz bands, the maximum conducted output power over the frequency bands of operation shall not exceed the lesser of 250 mW or $11 \text{ dBm} + 10 \log B$, where B is the 26 dB emission bandwidth in MHz.

If transmitting antennas of directional gain greater than 6dBi are used, both the peak transmit power and the peak power spectral density shall be reduced by the amount in dB that the directional gain of the antenna exceeds 6dBi.

The peak power shall not exceed the limit as follow:

Specified Limit of the Peak Power

Test mode: IEEE 802.11a mode / 5180 ~ 5240MHz

Channel	Frequency (MHz)	26 dB Bandwidth (B) (MHz)	10 Log B (dB)	4 + 10 Log B (dBm)	Maximum Conducted Output Power Limit (dBm)
Low	5180	20.80	13.18063	17.18063	17.00
Mid	5220	21.00	13.22219	17.22219	17.00
High	5240	23.47	13.70439	17.70439	17.00

Test mode: IEEE 802.11n HT 20 MHz mode / 5180 ~ 5240MHz

Channel	Frequency (MHz)	26 dB Bandwidth (B) (MHz)	10 Log B (dB)	4 + 10 Log B (dBm)	Maximum Conducted Output Power Limit (dBm)
Low	5180	20.80	13.18063	17.18063	17.00
Mid	5220	20.80	13.18063	17.18063	17.00
High	5240	20.80	13.18063	17.18063	17.00

Test mode: IEEE 802.11n HT 40 MHz mode / 5190 ~ 5230MHz

Channel	Frequency (MHz)	26 dB Bandwidth (B) (MHz)	10 Log B (dB)	4 + 10 Log B (dBm)	Maximum Conducted Output Power Limit (dBm)
Low	5190	39.40	15.95496	19.95496	17.00
High	5230	39.30	15.94393	19.94393	17.00

**Test mode: IEEE 802.11a mode / 5260 ~ 5320MHz**

Channel	Frequency (MHz)	26 dB Bandwidth (B) (MHz)	10 Log B (dB)	11 + 10 Log B (dBm)	Maximum Conducted Output Power Limit (dBm)
Low	5260	25.47	14.05961	25.05961	23.00
Mid	5280	23.87	13.77780	24.77780	23.00
High	5320	23.73	13.75353	24.75353	23.00

Test mode: IEEE 802.11n HT 20 MHz mode / 5260 ~ 5320MHz

Channel	Frequency (MHz)	26 dB Bandwidth (B) (MHz)	10 Log B (dB)	11 + 10 Log B (dBm)	Maximum Conducted Output Power Limit (dBm)
Low	5260	20.87	13.19439	24.19439	23.00
Mid	5280	20.80	13.18063	24.18063	23.00
High	5320	21.07	13.23582	24.23582	23.00

Test mode: IEEE 802.11n HT 40 MHz mode / 5270 ~ 5310MHz

Channel	Frequency (MHz)	26 dB Bandwidth (B) (MHz)	10 Log B (dB)	11 + 10 Log B (dBm)	Maximum Conducted Output Power Limit (dBm)
Low	5270	39.40	15.95496	26.95496	23.00
High	5310	39.30	15.94393	26.94393	23.00

Test mode: IEEE 802.11a mode / 5500 ~ 5700MHz

Channel	Frequency (MHz)	26 dB Bandwidth (B) (MHz)	10 Log B (dB)	11 + 10 Log B (dBm)	Maximum Conducted Output Power Limit (dBm)
Low	5500	32.00	15.05150	26.05150	23.00
Mid	5600	24.13	13.82611	24.82611	23.00
High	5700	30.67	14.86657	25.86657	23.00

Test mode: IEEE 802.11n HT 20 MHz mode/ 5500 ~ 5700MHz

Channel	Frequency (MHz)	26 dB Bandwidth (B) (MHz)	10 Log B (dB)	11 + 10 Log B (dBm)	Maximum Conducted Output Power Limit (dBm)
Low	5500	21.60	13.34454	24.34454	23.00
Mid	5600	20.80	13.18063	24.18063	23.00
High	5700	21.27	13.27686	24.27686	23.00

Test mode: IEEE 802.11n HT 40 MHz mode / 5510 ~ 5670MHz

Channel	Frequency (MHz)	26 dB Bandwidth (B) (MHz)	10 Log B (dB)	11 + 10 Log B (dBm)	Maximum Conducted Output Power Limit (dBm)
Low	5510	39.00	15.91065	26.91065	23.00
Mid	5590	39.10	15.92177	26.92177	23.00
High	5670	39.00	15.91065	26.91065	23.00



Test Configuration

The EUT was connected to a spectrum analyzer through a 50Ω RF cable.

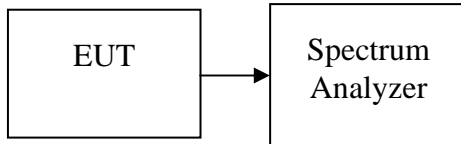

TEST PROCEDURE

Set span to encompass the entire emission bandwidth (EBW) of the signal.

Set RBW = 1 MHz / Set VBW = 3 MHz.

Use sample detector mode if bin width (i.e., span/number of points in spectrum display) < 0.5 RBW. Otherwise use peak detector mode. Use a video trigger with the trigger level set to enable triggering only on full power pulses. Transmitter must operate at full control power for entire sweep of every sweep. If the device transmits continuously, with no off intervals or reduced power intervals, the trigger may be set to “free run”. Trace average 100 traces in power averaging mode. Compute power by integrating the spectrum across the 26 dB EBW of the signal. The integration can be performed using the spectrum analyzer’s band power measurement function with band limits set equal to the EBW band edges or by summing power levels in each 1 MHz band in linear power terms. The 1 MHz band power levels to be summed can be obtained by averaging, in linear power terms, power levels in each frequency bin across the 1 MHz.

TEST RESULTS

No non-compliance noted



Test Data

Test mode: IEEE 802.11a mode / 5180 ~ 5240MHz

Channel	Frequency (MHz)	Maximum Conducted Output Power (dBm)	Limit (dBm)
Low	5180	11.57	17.00
Mid	5220	12.45	17.00
High	5240	12.46	17.00

Test mode: IEEE 802.11n HT 20 MHz mode / 5180 ~ 5240MHz

Channel	Frequency (MHz)	Maximum Conducted Output Power (dBm)	Limit (dBm)
Low	5180	9.05	17.00
Mid	5220	9.53	17.00
High	5240	9.75	17.00

Test mode: IEEE 802.11n HT 40 MHz mode / 5190 ~ 5230MHz

Channel	Frequency (MHz)	Maximum Conducted Output Power (dBm)	Limit (dBm)
Low	5190	8.03	17.00
High	5230	8.46	17.00



Test mode: IEEE 802.11a mode / 5260 ~ 5320MHz

Channel	Frequency (MHz)	Maximum Conducted Output Power (dBm)	Limit (dBm)
Low	5260	13.19	24.00
Mid	5280	13.53	24.00
High	5320	13.34	24.00

Test mode: IEEE 802.11n HT 20 MHz mode / 5260 ~ 5320MHz

Channel	Frequency (MHz)	Maximum Conducted Output Power (dBm)	Limit (dBm)
Low	5260	10.07	23.00
Mid	5280	10.83	23.00
High	5320	11.16	23.00

Test mode: IEEE 802.11n HT 40 MHz mode / 5270 ~ 5310MHz

Channel	Frequency (MHz)	Maximum Conducted Output Power (dBm)	Limit (dBm)
Low	5270	9.52	23.00
High	5310	9.83	23.00

Test mode: IEEE 802.11a mode / 5500 ~ 5700MHz

Channel	Frequency (MHz)	Maximum Conducted Output Power (dBm)	Limit (dBm)
Low	5500	13.53	23.00
Mid	5600	13.46	23.00
High	5700	13.36	23.00

Test mode: IEEE 802.11n HT 20 MHz mode / 5500 ~ 5700MHz

Channel	Frequency (MHz)	Maximum Conducted Output Power (dBm)	Limit (dBm)
Low	5500	11.22	23.00
Mid	5600	11.10	23.00
High	5700	10.42	23.00

Test mode: IEEE 802.11n HT 40 MHz mode / 5510 ~ 5670MHz

Channel	Frequency (MHz)	Maximum Conducted Output Power (dBm)	Limit (dBm)
Low	5510	10.12	23.00
Mid	5590	10.08	23.00
High	5670	10.45	23.00



7.3 BAND EDGES MEASUREMENT

LIMIT

According to §15.407(b),

- (1) The provisions of Section 15.205 of this part apply to intentional radiators operating under this section.
- (2) When measuring the emission limits, the nominal carrier frequency shall be adjusted as close to the upper and lower frequency block edges as the design of the equipment permits.

Test Configuration

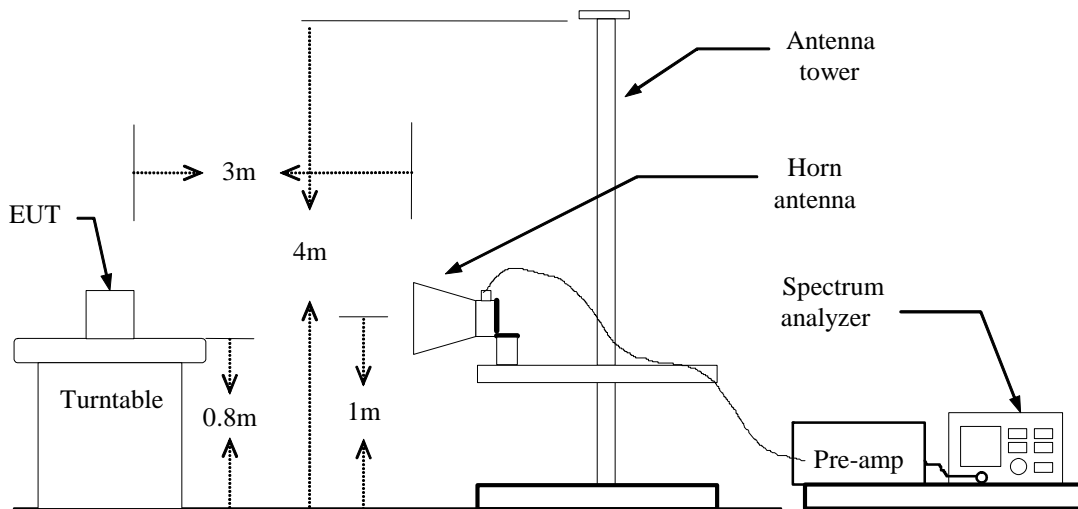

TEST PROCEDURE

1. The EUT is placed on a turntable, which is 0.8m above the ground plane.
2. The turntable shall be rotated for 360 degrees to determine the position of maximum emission level.
3. EUT is set 3m away from the receiving antenna, which is varied from 1m to 4m to find out the highest emission.
4. Set the spectrum analyzer in the following setting in order to capture the lower and upper band-edges of the emission:
 - (a) PEAK: RBW=VBW=1MHz / Sweep=AUTO
 - (b) AVERAGE: RBW=1MHz / VBW=10Hz / Sweep=AUTO
5. Repeat the procedures until all the PEAK and AVERAGE versus POLARIZATION are measured.

TEST RESULTS

Refer to attach spectrum analyzer data chart.

802.11a Mode

1. Operating Frequency: 5500-5700MHz
2. CH Low: 5500MHz, CH High: 5700MHz
3. 26dB bandwidth: CH Low: 24.520MHz, CH High: 23.510MHz

Because the mentioned conditions, the test is not applicable.



Band Edges (IEEE 802.11a mode / 5180 MHz)

Detector mode: Peak

Polarity: Vertical

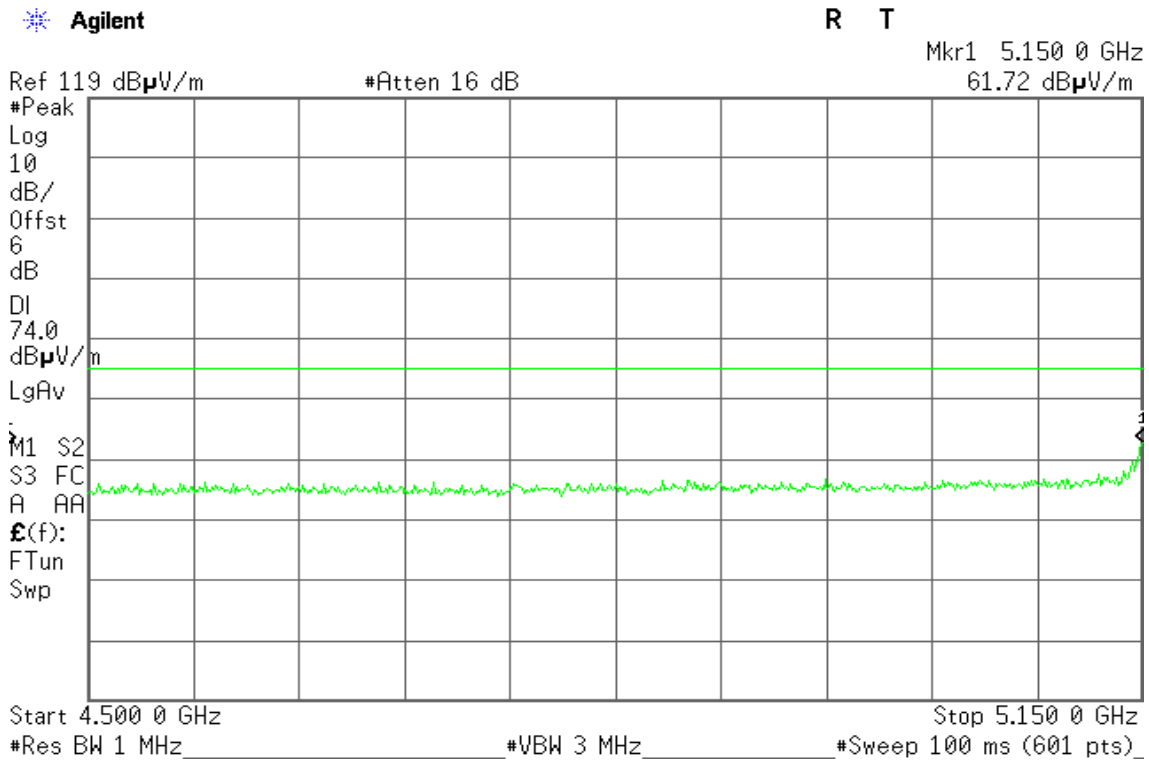

Detector mode: Average

Polarity: Vertical

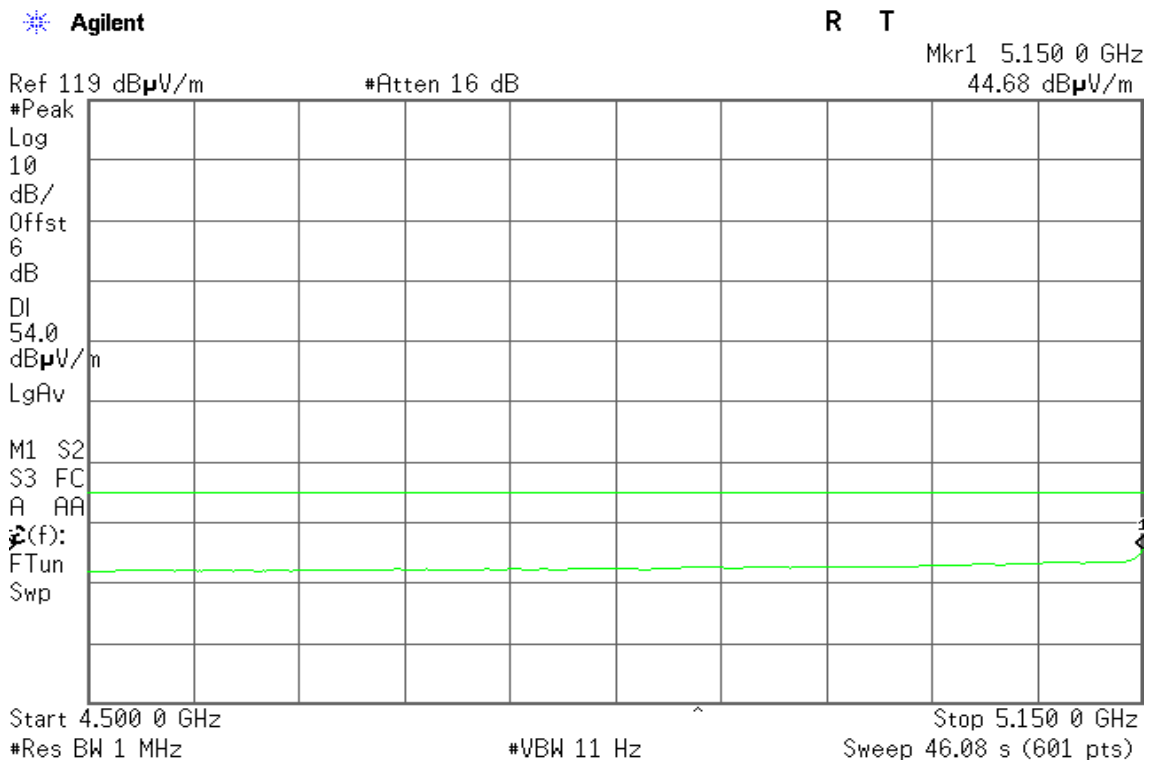



Detector mode: Peak

Polarity: Horizontal

Agilent

R T

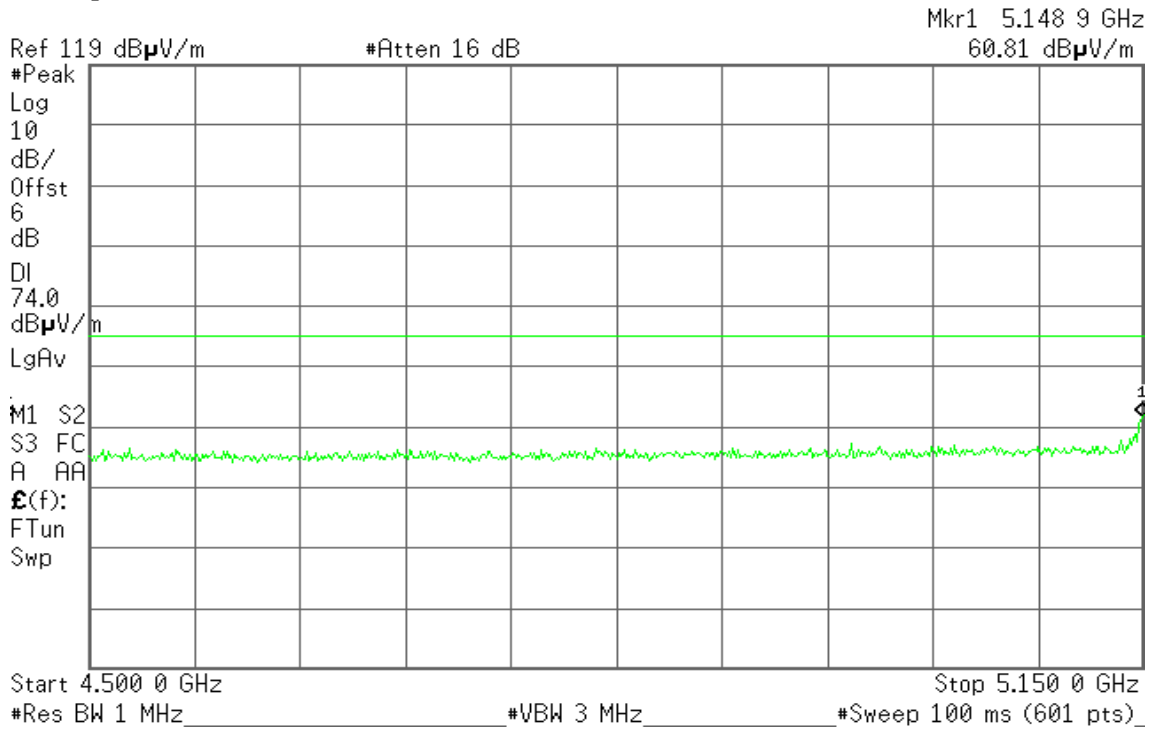

Detector mode: Average

Polarity: Horizontal

Agilent

R T

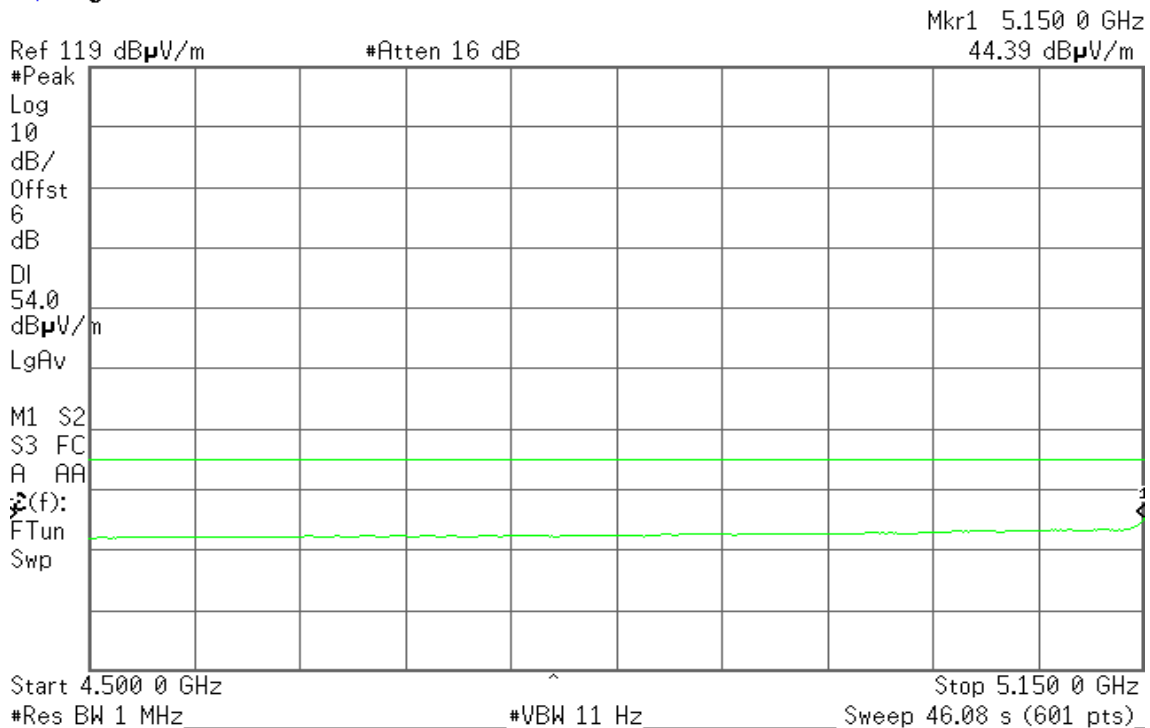



Band Edges (IEEE 802.11a mode / 5320 MHz)

Detector mode: Peak

Polarity: Vertical

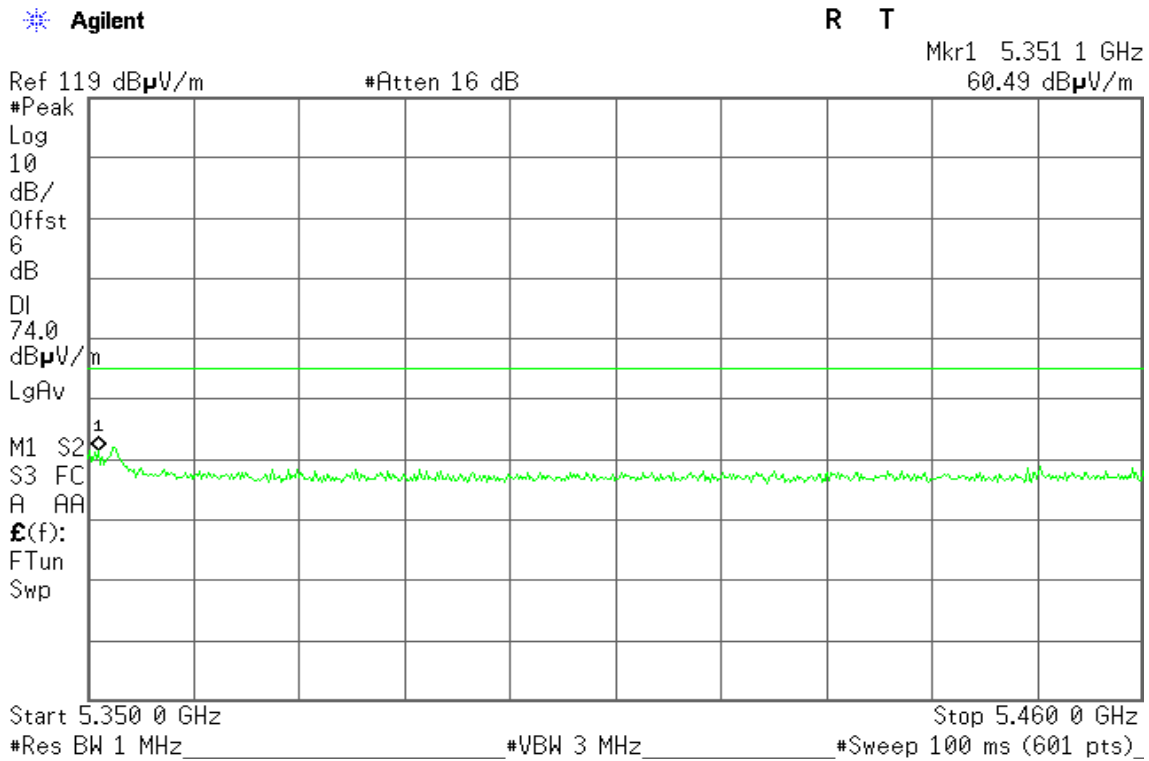

Detector mode: Average

Polarity: Vertical

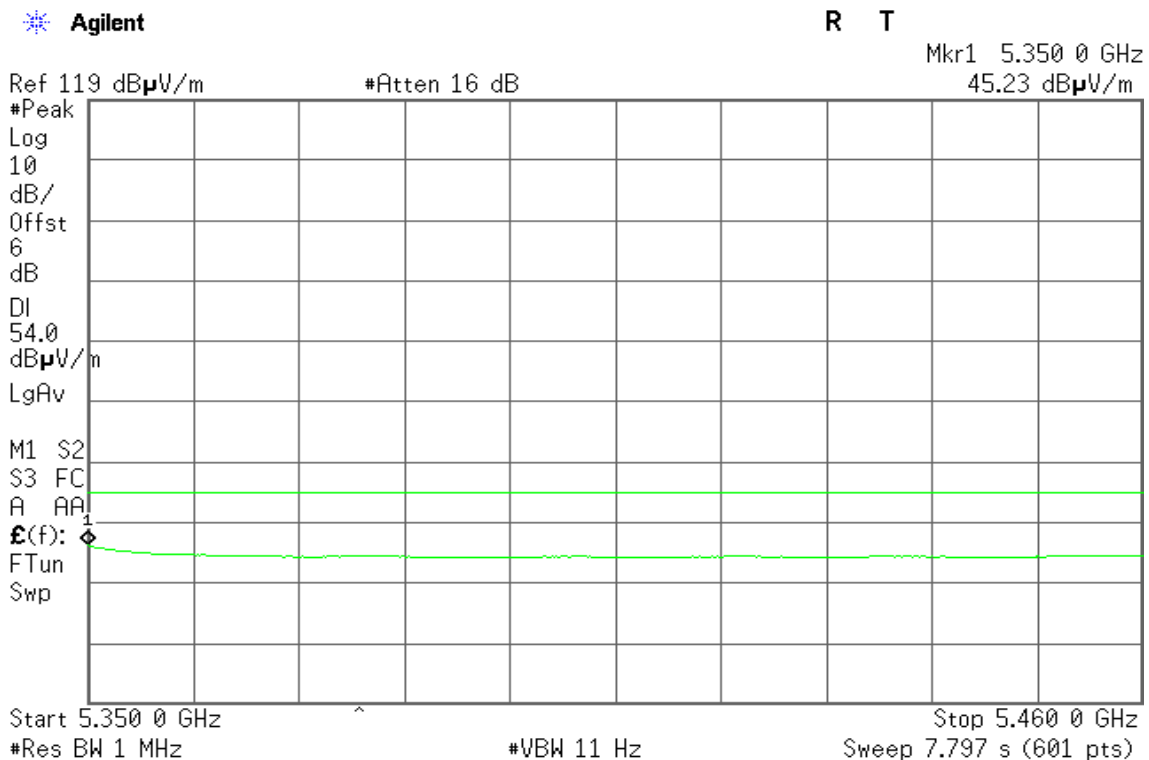



Detector mode: Peak

Polarity: Horizontal

Agilent

R T

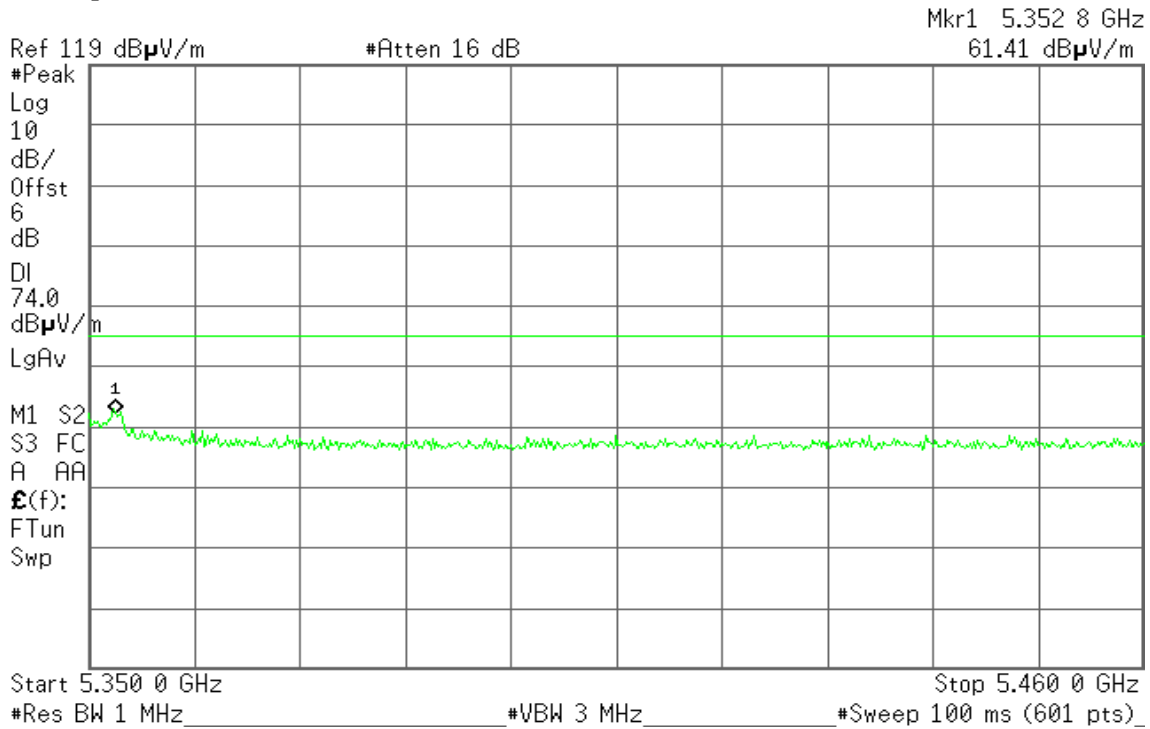

Detector mode: Average

Polarity: Horizontal

Agilent

R T

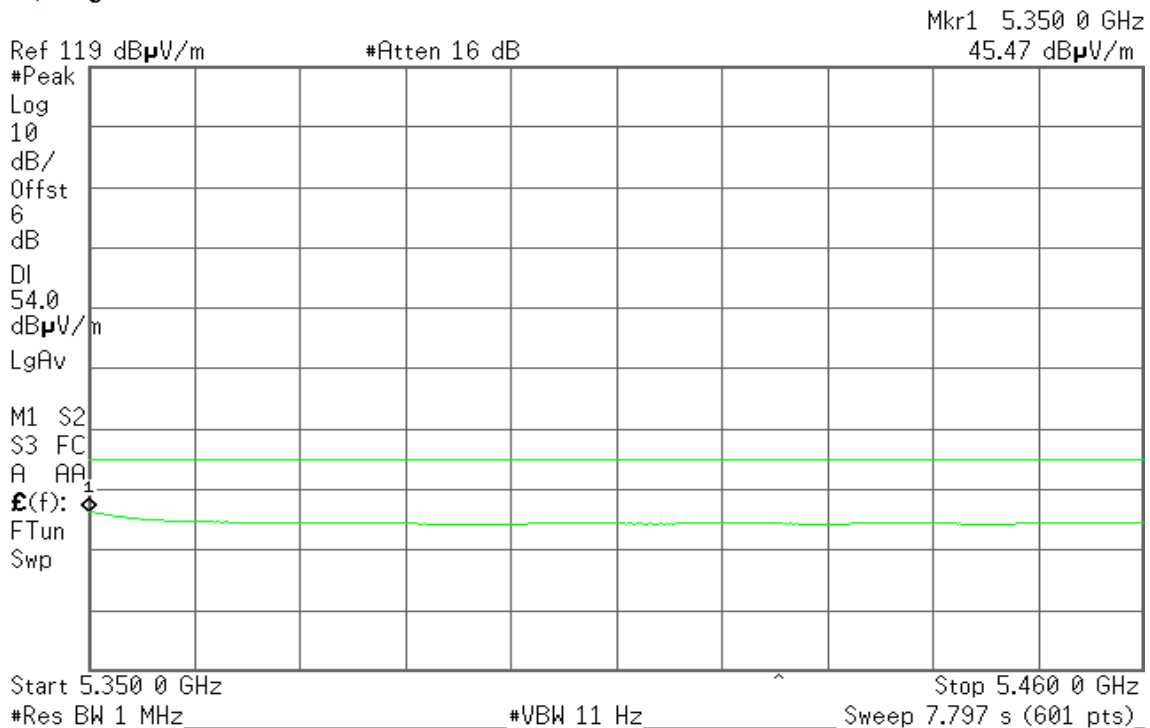



Band Edges (IEEE 802.11n HT 20 MHz mode / 5180 MHz)

Detector mode: Peak

Polarity: Vertical

Agilent

R T

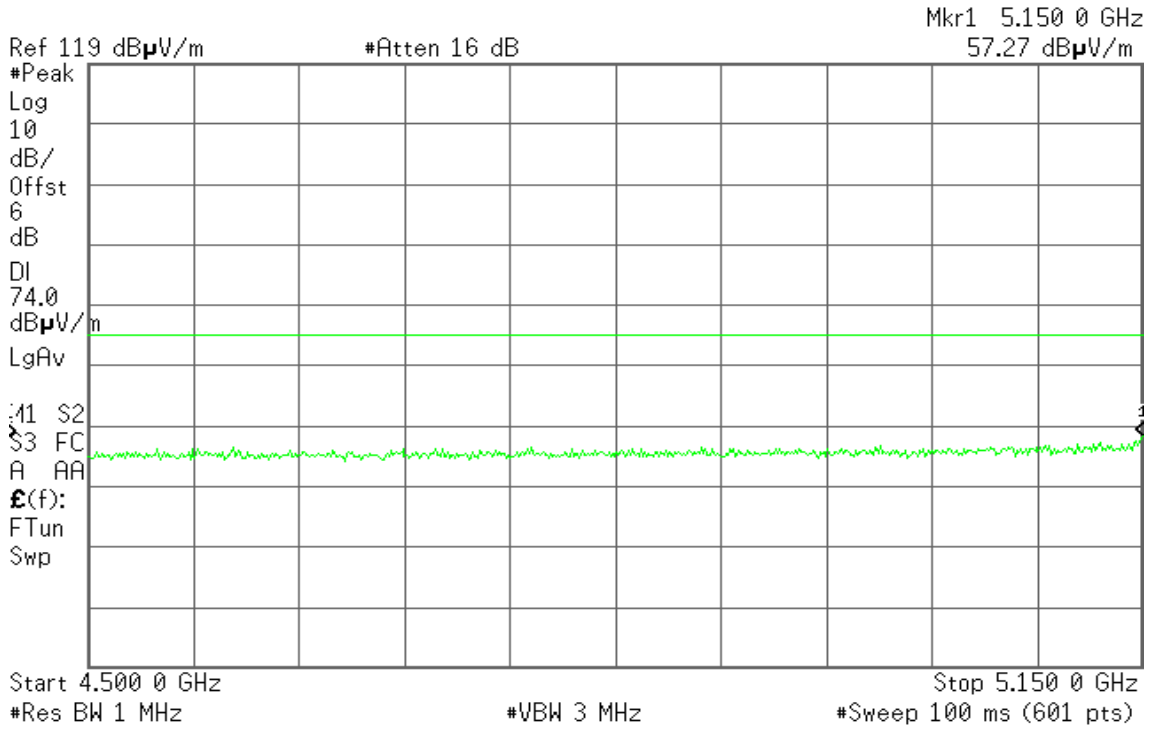

Detector mode: Average

Polarity: Vertical

Agilent

R T

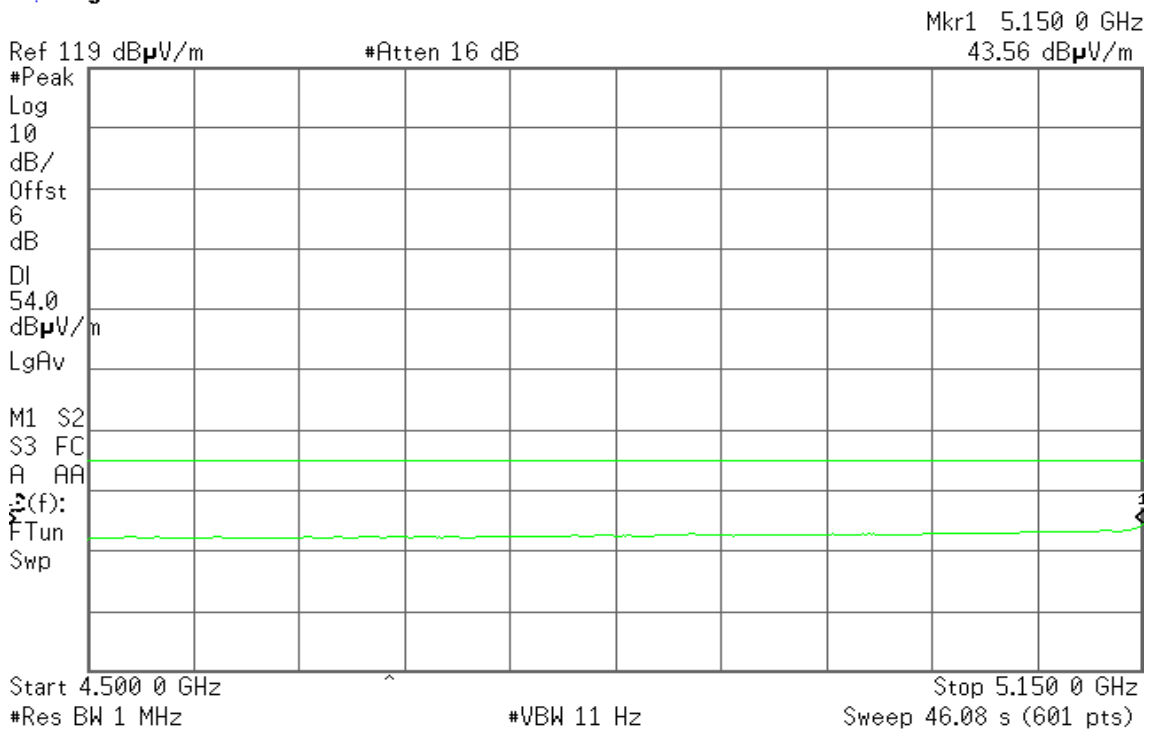



Detector mode: Peak

Polarity: Horizontal

Agilent

R T

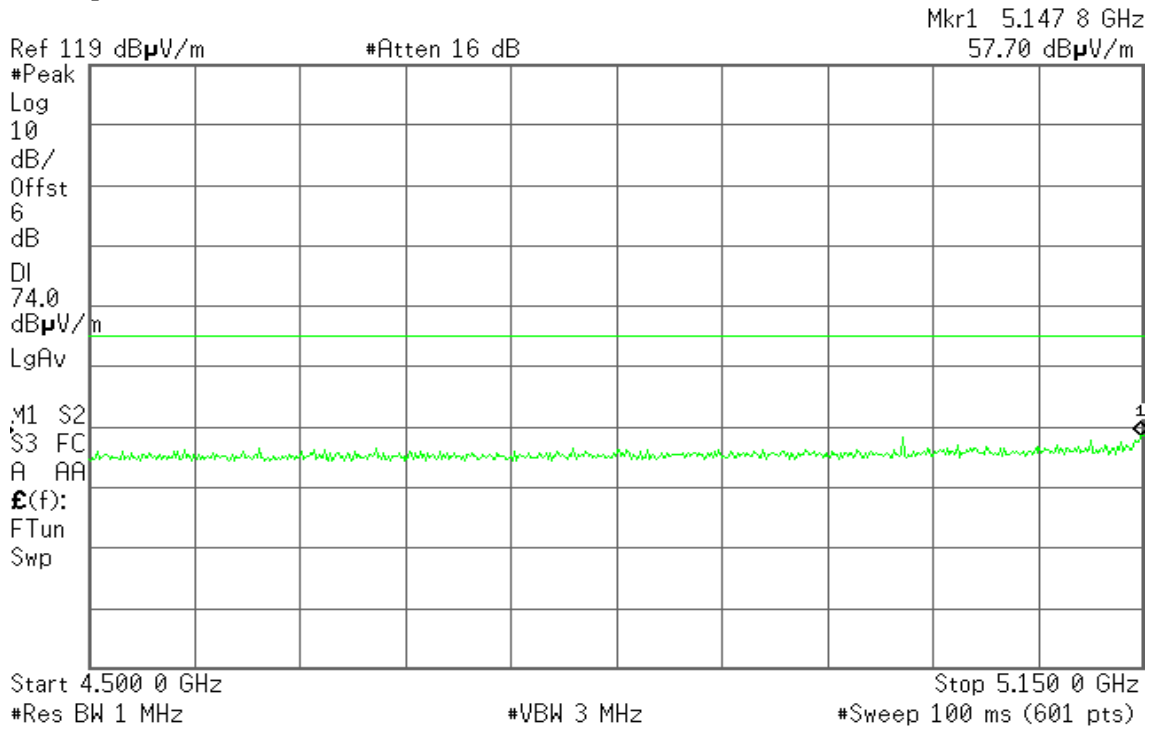

Detector mode: Average

Polarity: Horizontal

Agilent

R T

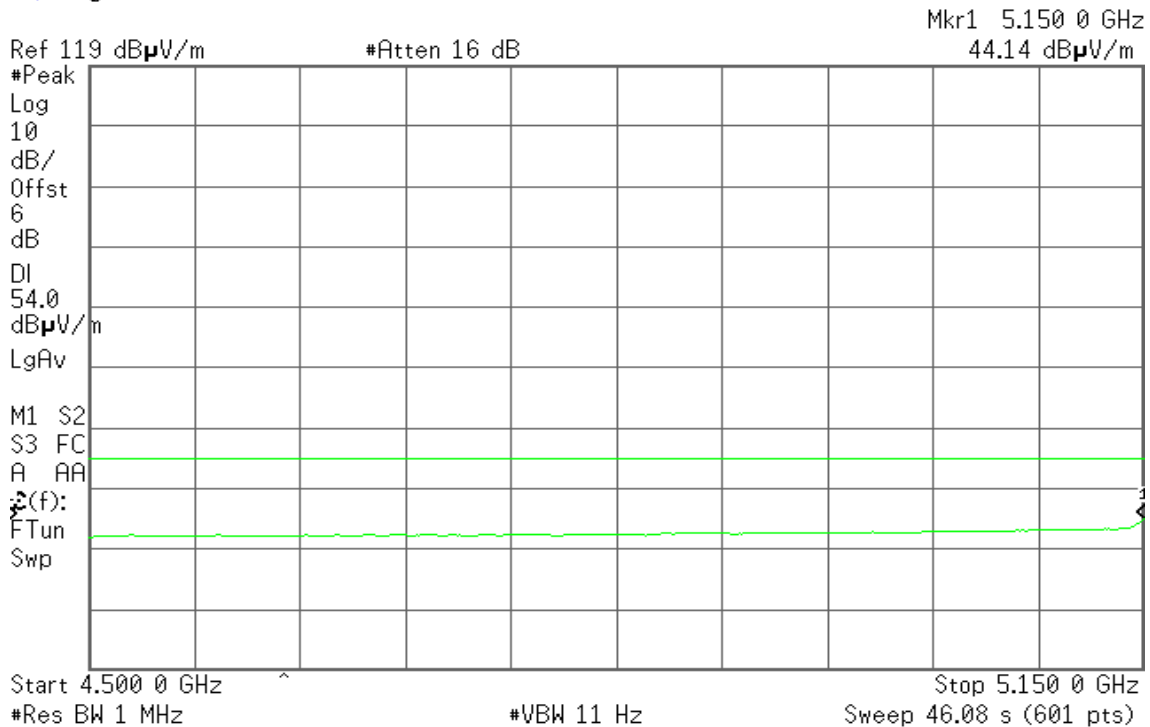



Band Edges (IEEE 802.11n HT 20 MHz mode / 5320 MHz)

Detector mode: Peak

Polarity: Vertical

Agilent

R T

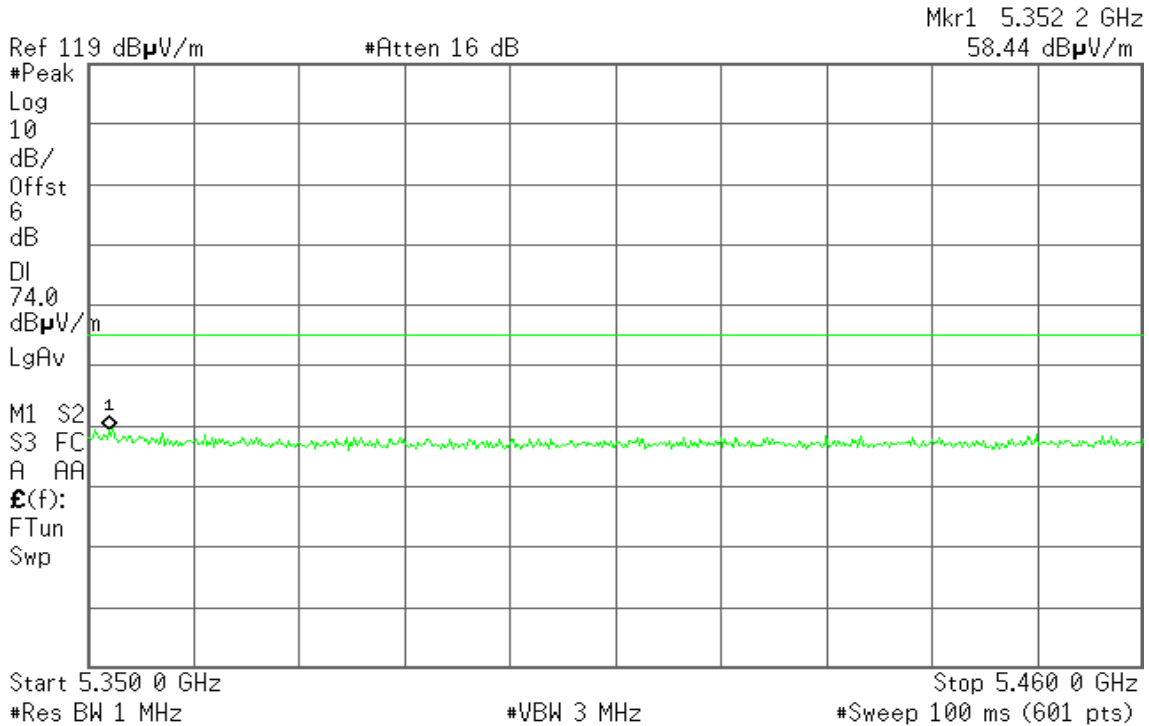

Detector mode: Average

Polarity: Vertical

Agilent

R T

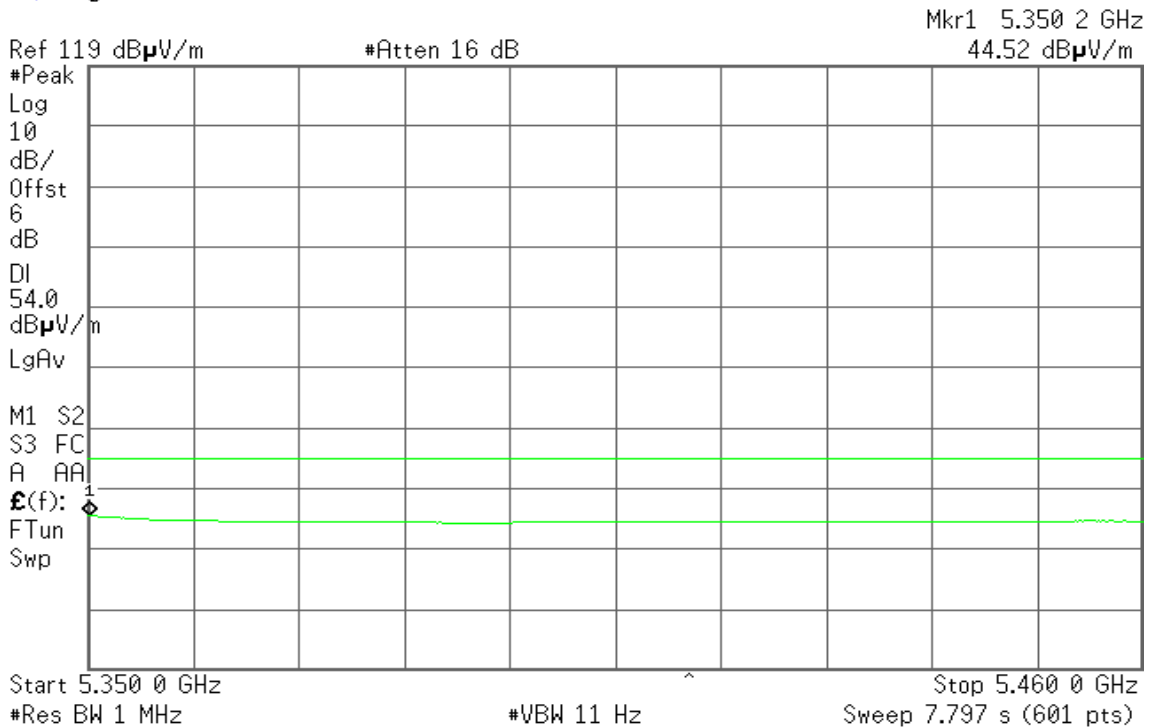



Detector mode: Peak

Polarity: Horizontal

Agilent

R T

Mkr1 5.352 2 GHz
59.06 dB μ V/m

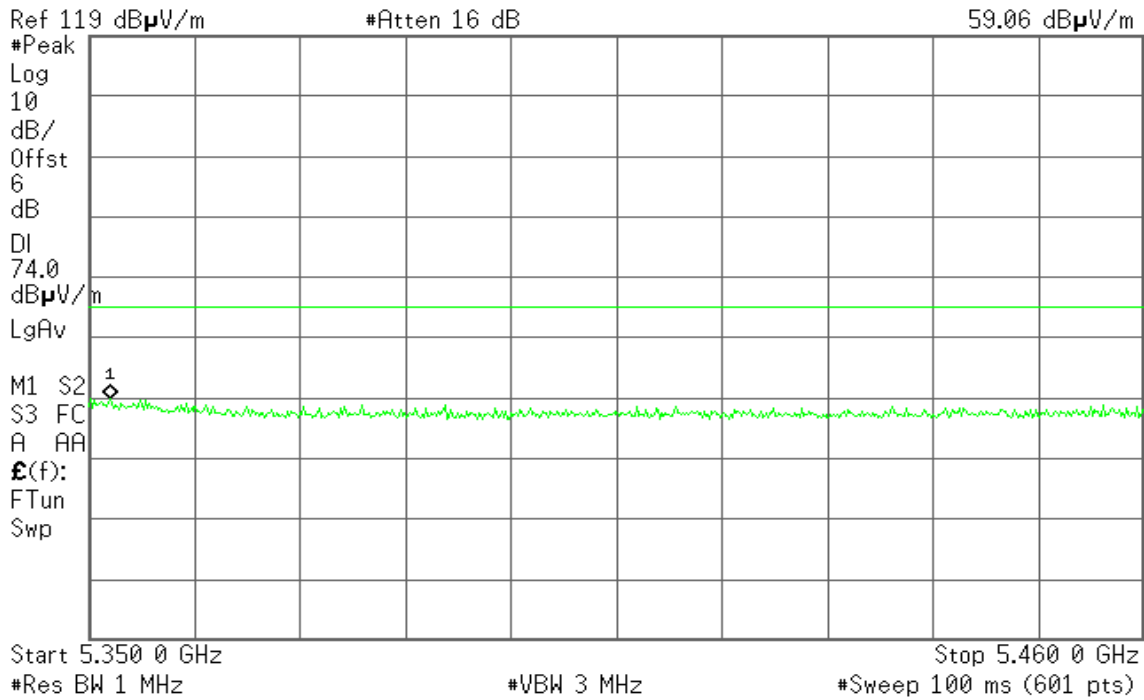

Detector mode: Average

Polarity: Horizontal

Agilent

R T

Mkr1 5.350 0 GHz
44.84 dB μ V/m

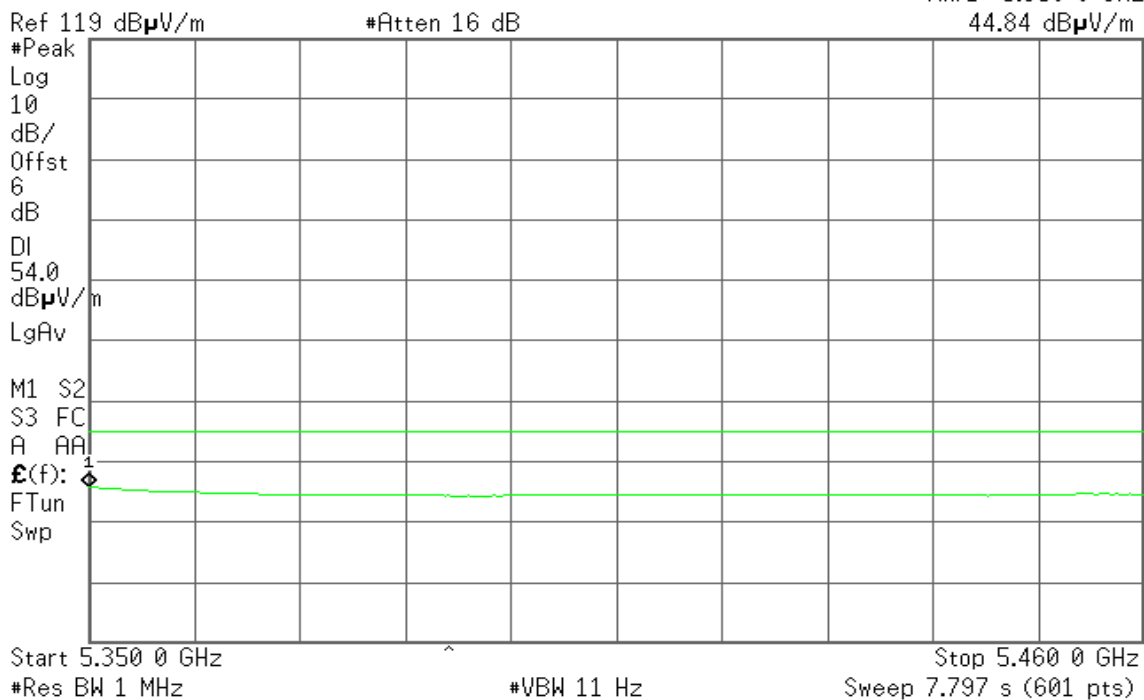



Band Edges (IEEE 802.11n HT 40 MHz mode / 5190 MHz)

Detector mode: Peak

Polarity: Vertical

Agilent

R T

Mkr1 5.148 9 GHz
64.80 dB μ V/m

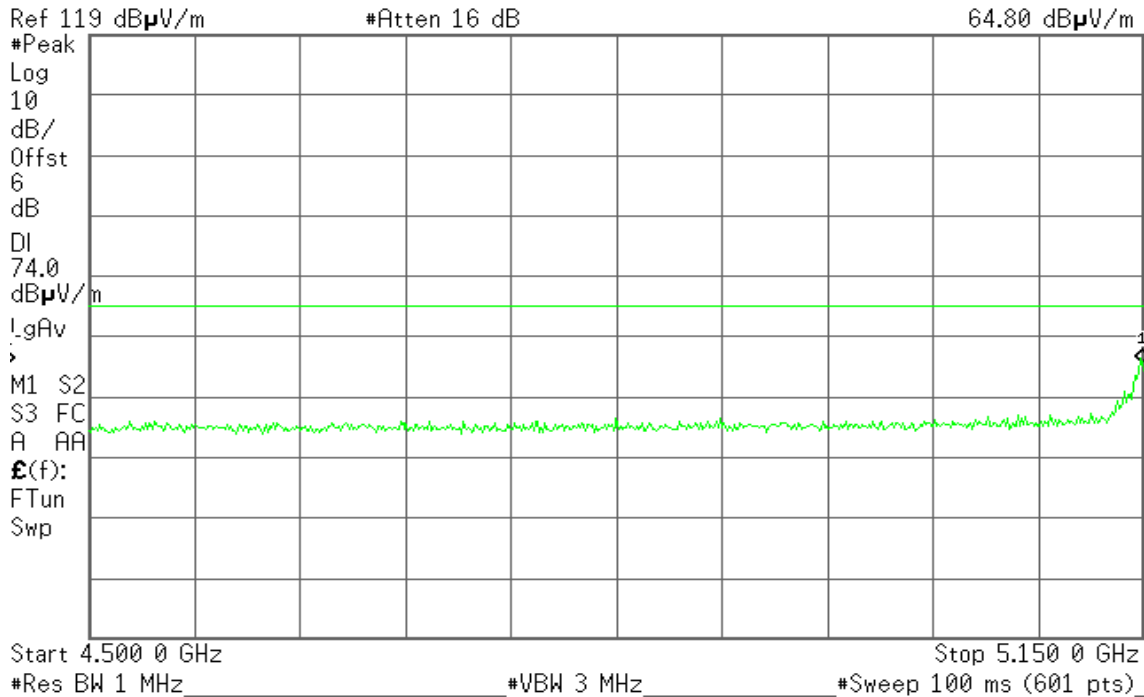

Detector mode: Average

Polarity: Vertical

Agilent

R T

Mkr1 5.150 0 GHz
50.64 dB μ V/m





Detector mode: Peak

Polarity: Horizontal

Agilent

R T

Mkr1 5.1478 GHz
64.44 dB μ V/m

Ref 119 dB μ V/m

#Atten 16 dB

#Peak

Log

10

dB/

Offst

6

dB

DI

74.0

dB μ V/m

LgAv

.

M1 S2

S3 FC

A AA

$\mathcal{E}(f)$:

FTun

Swp

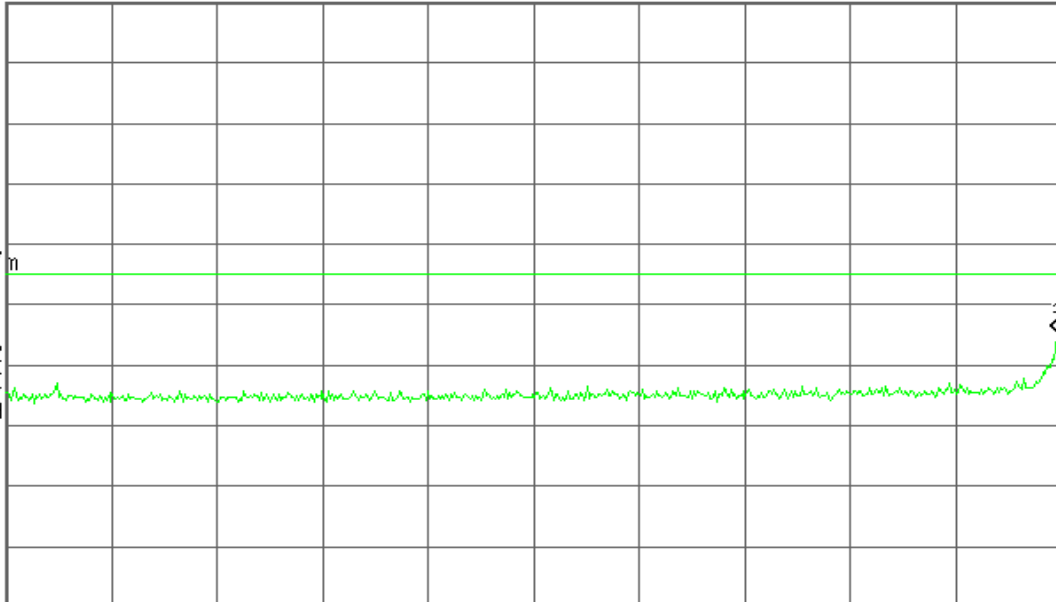

Start 4.5000 GHz

Stop 5.1500 GHz

#Res BW 1 MHz

#VBW 3 MHz

#Sweep 100 ms (601 pts)

Detector mode: Average

Polarity: Horizontal

Agilent

R T

Mkr1 5.1500 GHz
50.47 dB μ V/m

Ref 119 dB μ V/m

#Atten 16 dB

#Peak

Log

10

dB/

Offst

6

dB

DI

54.0

dB μ V/m

LgAv

M1 S2

S3 FC

A AA

$\mathcal{E}(f)$:

FTun

Swp

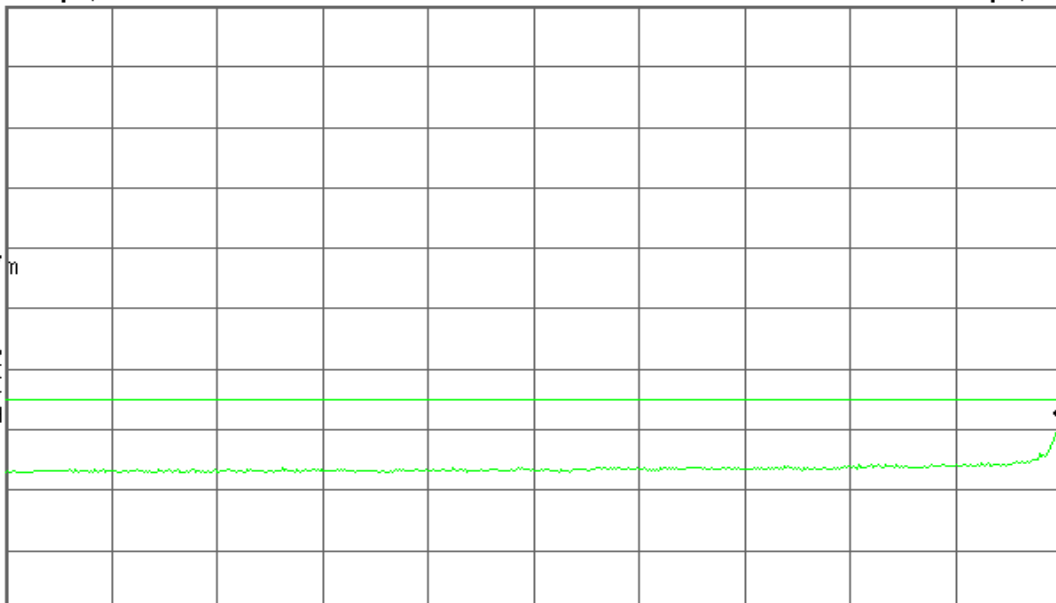

Start 4.5000 GHz

Stop 5.1500 GHz

#Res BW 1 MHz

#VBW 2 kHz

Sweep 253.4 ms (601 pts)



Band Edges (IEEE 802.11n HT 40 MHz mode / CH 5310 MHz)

Detector mode: Peak

Polarity: Vertical

Agilent

R T

Mkr1 5.351 8 GHz
62.75 dB μ V/m

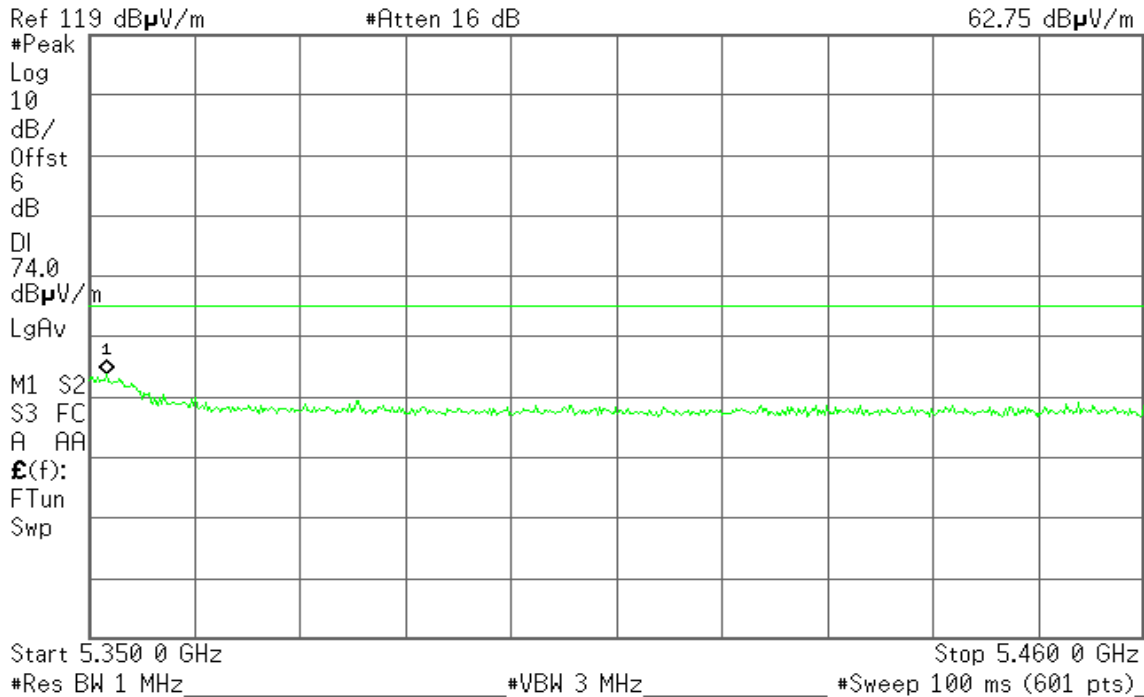

Detector mode: Average

Polarity: Vertical

Agilent

R T

Mkr1 5.350 5 GHz
48.13 dB μ V/m

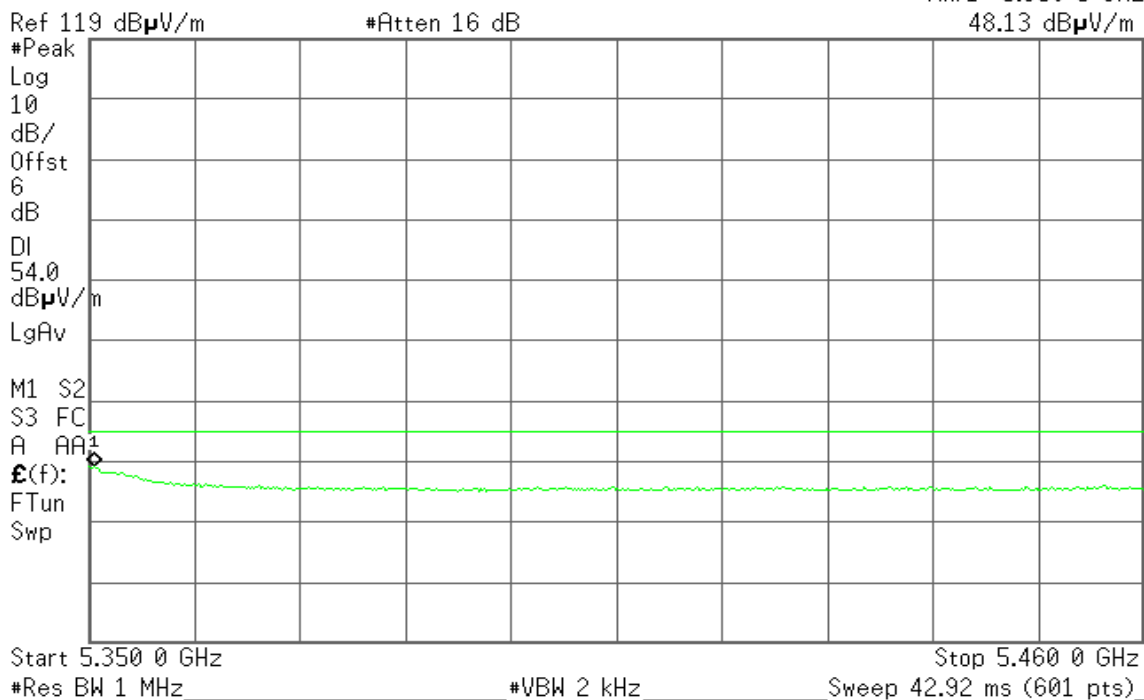



Detector mode: Peak

Polarity: Horizontal

Agilent

R T

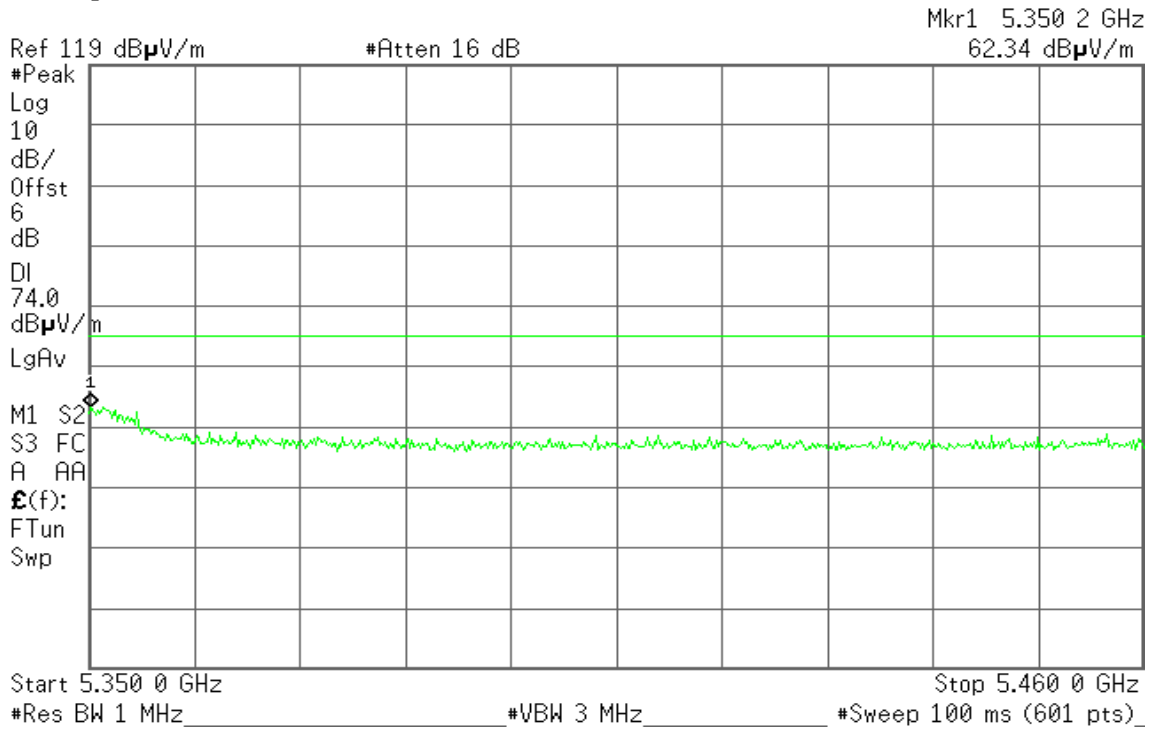

Detector mode: Average

Polarity: Horizontal

Agilent

R T

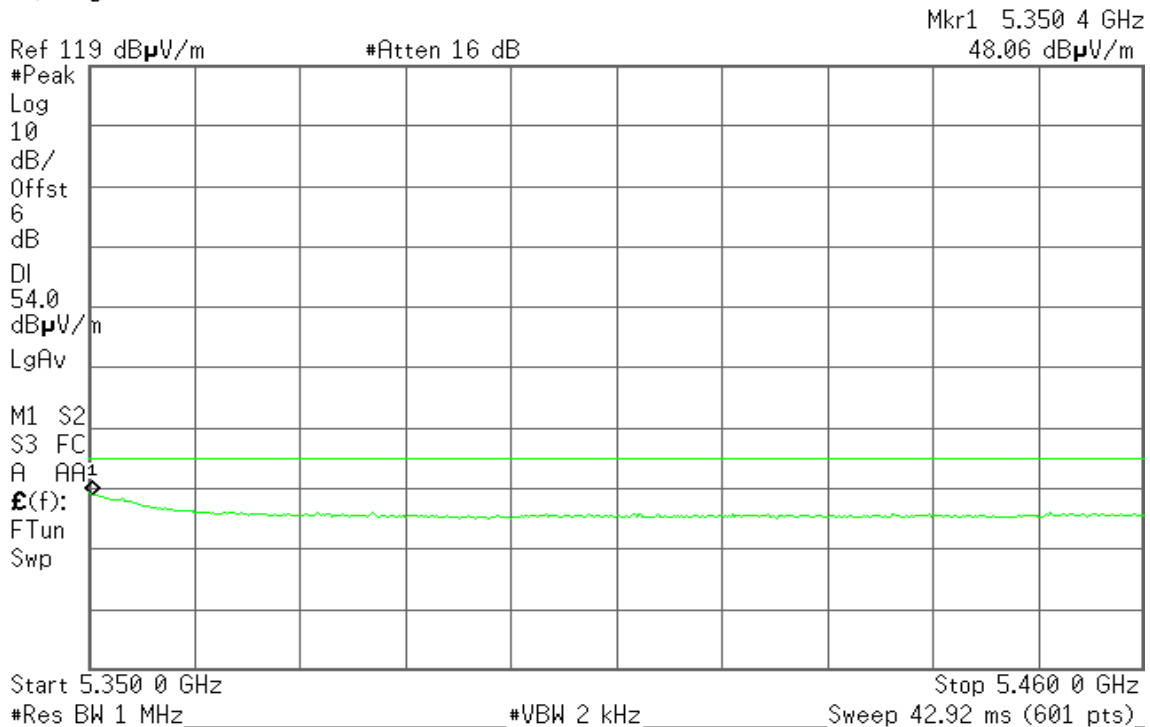



7.4 PEAK POWER SPECTRAL DENSITY

LIMIT

According to §15.407(a),

- (1) For the band 5.15-5.25 GHz, the peak power spectral density shall not exceed 4dBm in any 1MHz band.
- (2) For the band 5.25-5.35 GHz and 5.47-5.725 GHz bands, the peak power spectral density shall not exceed 11dBm in any 1MHz band.

If transmitting antennas of directional gain greater than 6dBi are used, both the peak transmit power and the peak power spectral density shall be reduced by the amount in dB that the directional gain of the antenna exceeds 6dBi.

Test Configuration

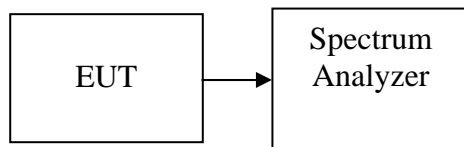

TEST PROCEDURE

1. Place the EUT on the table and set it in transmitting mode.
Remove the antenna from the EUT and then connect a low loss RF cable from the antenna port to the spectrum analyzer.
2. Set the spectrum analyzer as RBW = 1MHz, VBW = 3MHz, Span = Sweep= AUTO
3. Record the max. reading.
4. Repeat the above procedure until the measurements for all frequencies are completed

TEST RESULTS

No non-compliance noted



Test Data

Test mode: IEEE 802.11a mode / 5180 ~ 5240MHz

Channel	Frequency (MHz)	PPSD (dBm)	Limit (dBm)	Margin	Result
Low	5180	0.06	4.00	-3.94	PASS
Mid	5220	0.72	4.00	-3.28	PASS
High	5240	0.95	4.00	-3.05	PASS

Test mode: IEEE 802.11n HT 20 MHz mode / 5180 ~ 5240MHz

Channel	Frequency (MHz)	PPSD (dBm)	Limit (dBm)	Margin	Result
Low	5180	-2.51	4.00	-6.51	PASS
Mid	5220	-2.72	4.00	-6.72	PASS
High	5240	-2.63	4.00	-6.63	PASS

Test mode: IEEE 802.11n HT 40 MHz mode / 5190 ~ 5230MHz

Channel	Frequency (MHz)	PPSD (dBm)	Limit (dBm)	Margin	Result
Low	5190	-5.33	4.00	-9.33	PASS
High	5230	-5.80	4.00	-9.80	PASS



Test mode: IEEE 802.11a mode/ 5260 ~ 5320MHz

Channel	Frequency (MHz)	PPSD (dBm)	Limit (dBm)	Margin	Result
Low	5260	1.58	11.00	-9.42	PASS
Mid	5280	1.37	11.00	-9.63	PASS
High	5320	1.11	11.00	-9.89	PASS

Test mode: IEEE 802.11n HT 20 MHz mode / 5260 ~ 5320MHz

Channel	Frequency (MHz)	PPSD (dBm)	Limit (dBm)	Margin	Result
Low	5260	-2.23	11.00	-13.23	PASS
Mid	5280	-1.85	11.00	-12.85	PASS
High	5320	-1.25	11.00	-12.25	PASS

Test mode: IEEE 802.11n HT 40 MHz mode / 5270 ~ 5310MHz

Channel	Frequency (MHz)	PPSD (dBm)	Limit (dBm)	Margin	Result
Low	5270	-4.71	11.00	-15.71	PASS
High	5310	-3.66	11.00	-14.66	PASS

Test mode: IEEE 802.11a mode / 5500 ~ 5700MHz

Channel	Frequency (MHz)	PPSD (dBm)	Limit (dBm)	Margin	Result
Low	5500	1.93	11.00	-9.07	PASS
Mid	5600	1.77	11.00	-9.23	PASS
High	5700	1.61	11.00	-9.39	PASS

Test mode: IEEE 802.11n HT 20 MHz mode / 5500 ~ 5700MHz

Channel	Frequency (MHz)	PPSD (dBm)	Limit (dBm)	Margin	Result
Low	5500	-0.50	11.00	-11.50	PASS
Mid	5600	-1.07	11.00	-12.07	PASS
High	5700	-0.98	11.00	-11.98	PASS

Test mode: IEEE 802.11n HT 40 MHz mode / 5510 ~ 5670MHz

Channel	Frequency (MHz)	PPSD (dBm)	Limit (dBm)	Margin	Result
Low	5510	-4.05	11.00	-15.05	PASS
Mid	5590	-4.02	11.00	-15.02	PASS
High	5670	-3.22	11.00	-14.22	PASS



Test Plot

IEEE 802.11a mode / 5180 ~ 5240MHz

CH Low

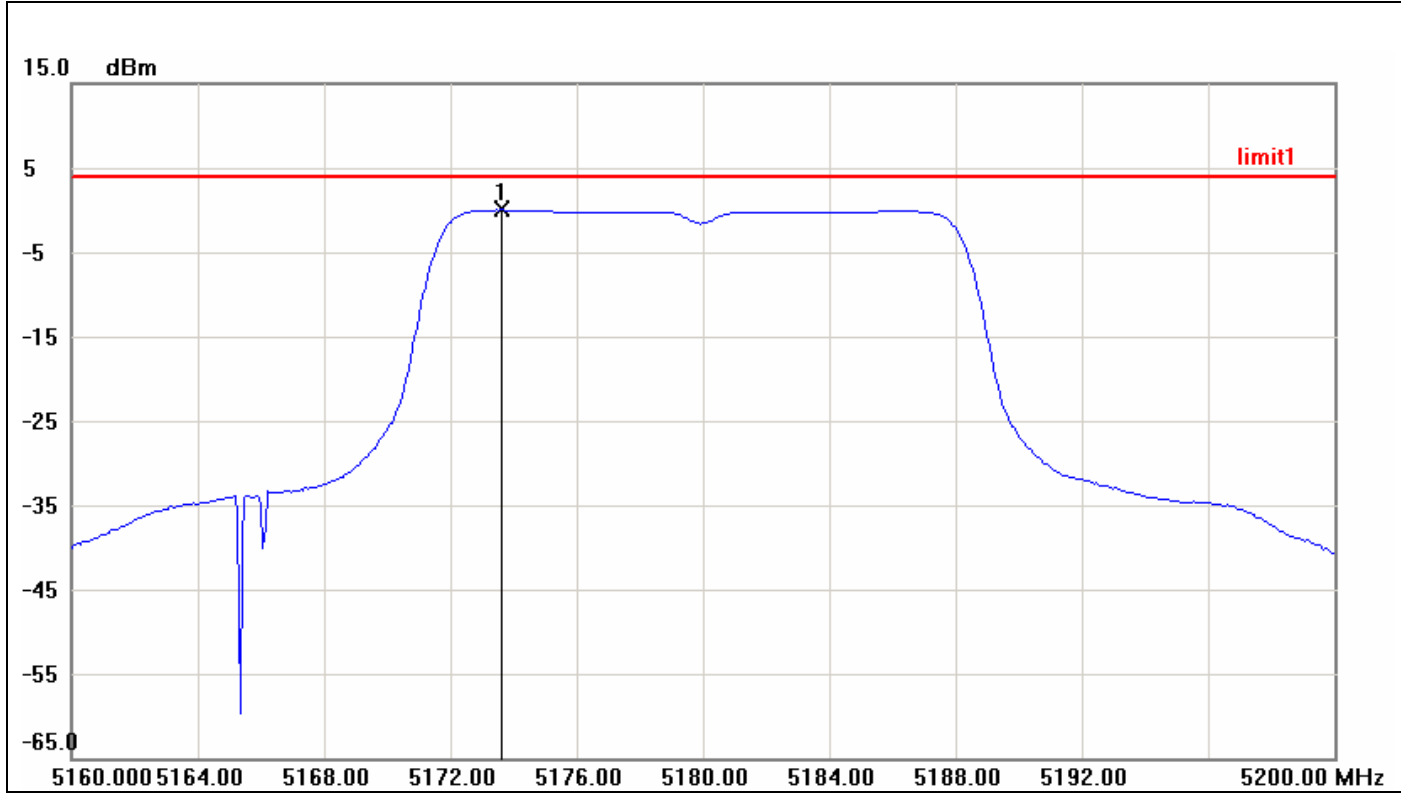

No.	Frequency(MHz)	Result(dBm)	Limit(dBm)	Margin(dBm)
1	5173.6000	0.06	4.00	-3.94



CH Mid

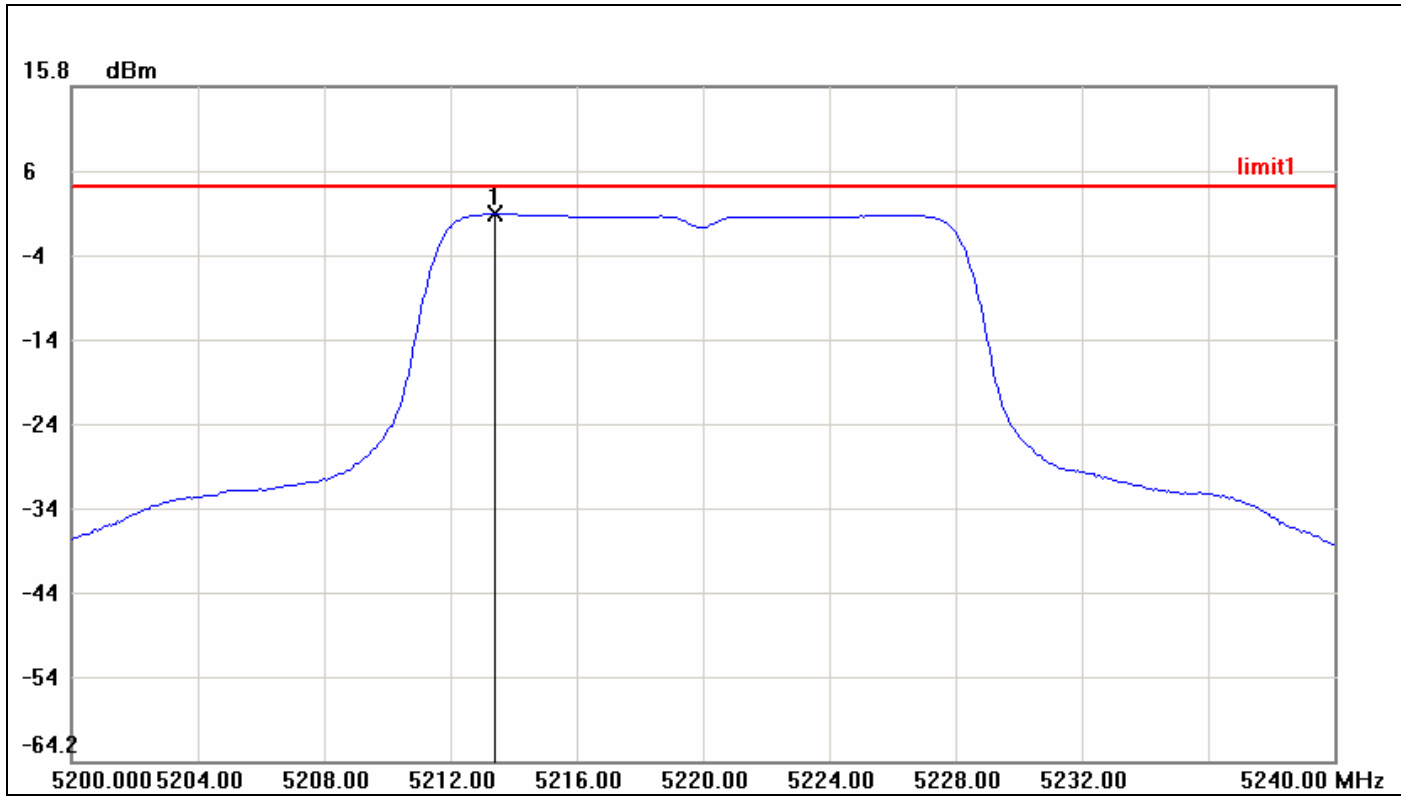

No.	Frequency(MHz)	Result(dBm)	Limit(dBm)	Margin(dBm)
1	5213.4000	0.72	4.00	-3.28



CH High

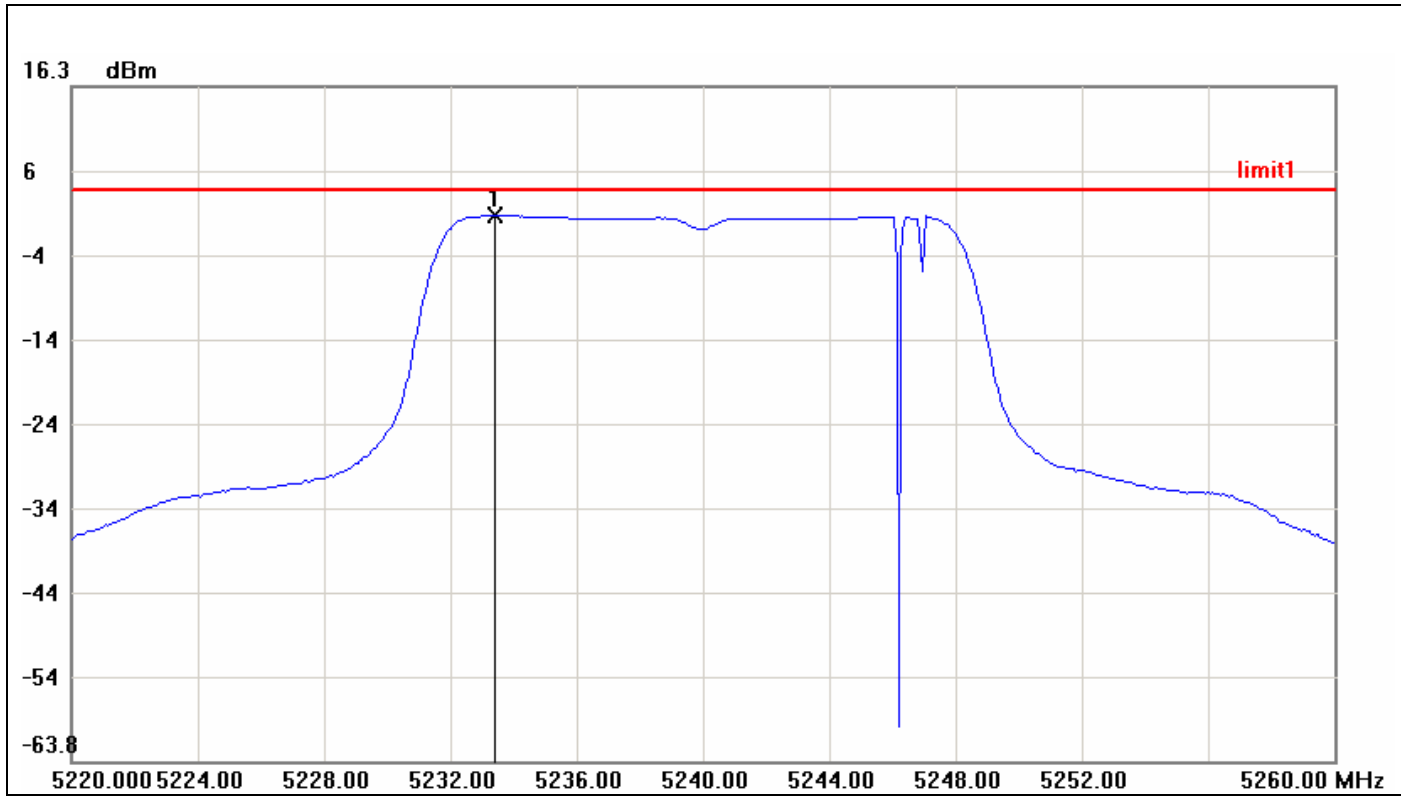

No.	Frequency(MHz)	Result(dBm)	Limit(dBm)	Margin(dBm)
1	5233.4000	0.95	4.00	-3.05



IEEE 802.11n HT 20 MHz mode / 5180 ~ 5240MHz

CH Low

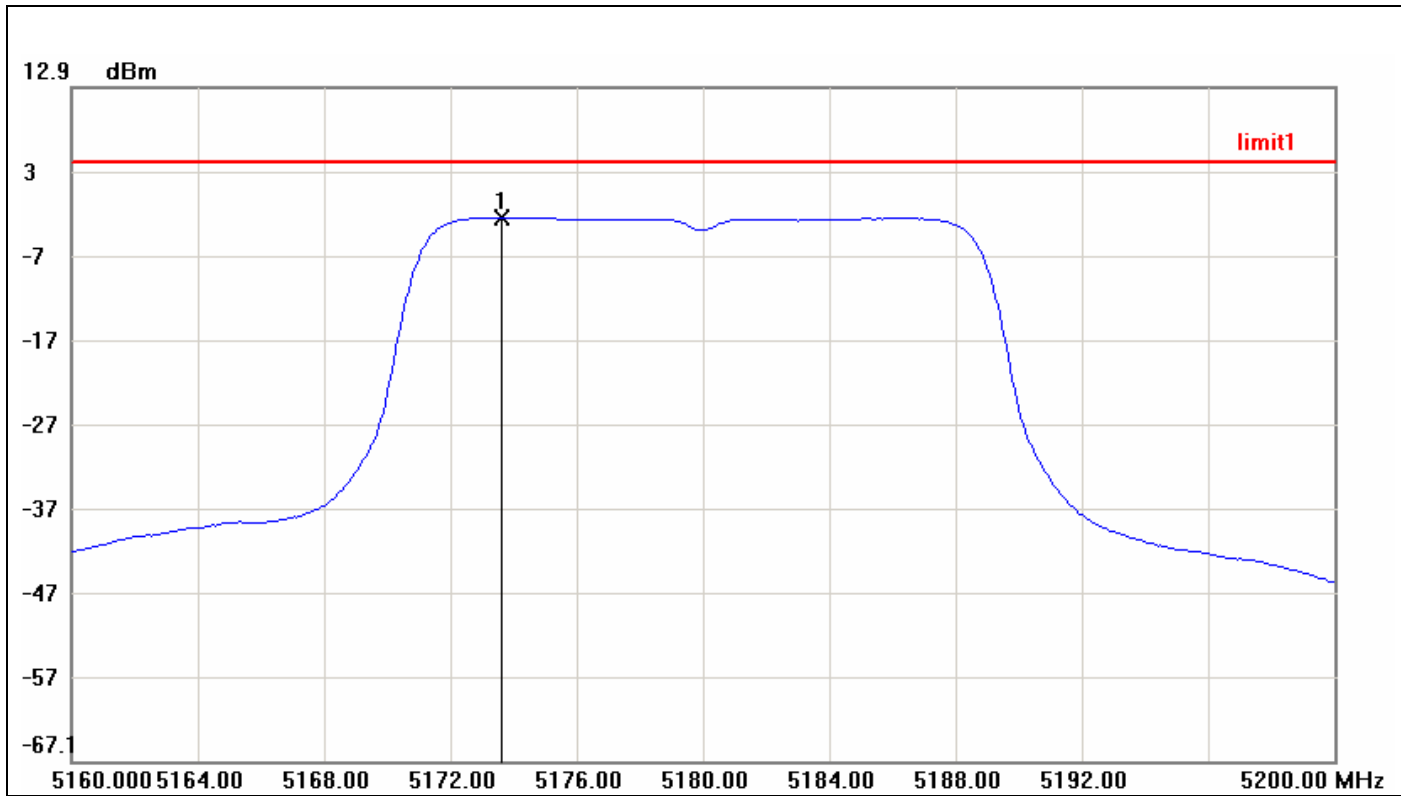

No.	Frequency(MHz)	Result(dBm)	Limit(dBm)	Margin(dBm)
1	5173.6000	-2.51	4.00	-6.51



CH Mid

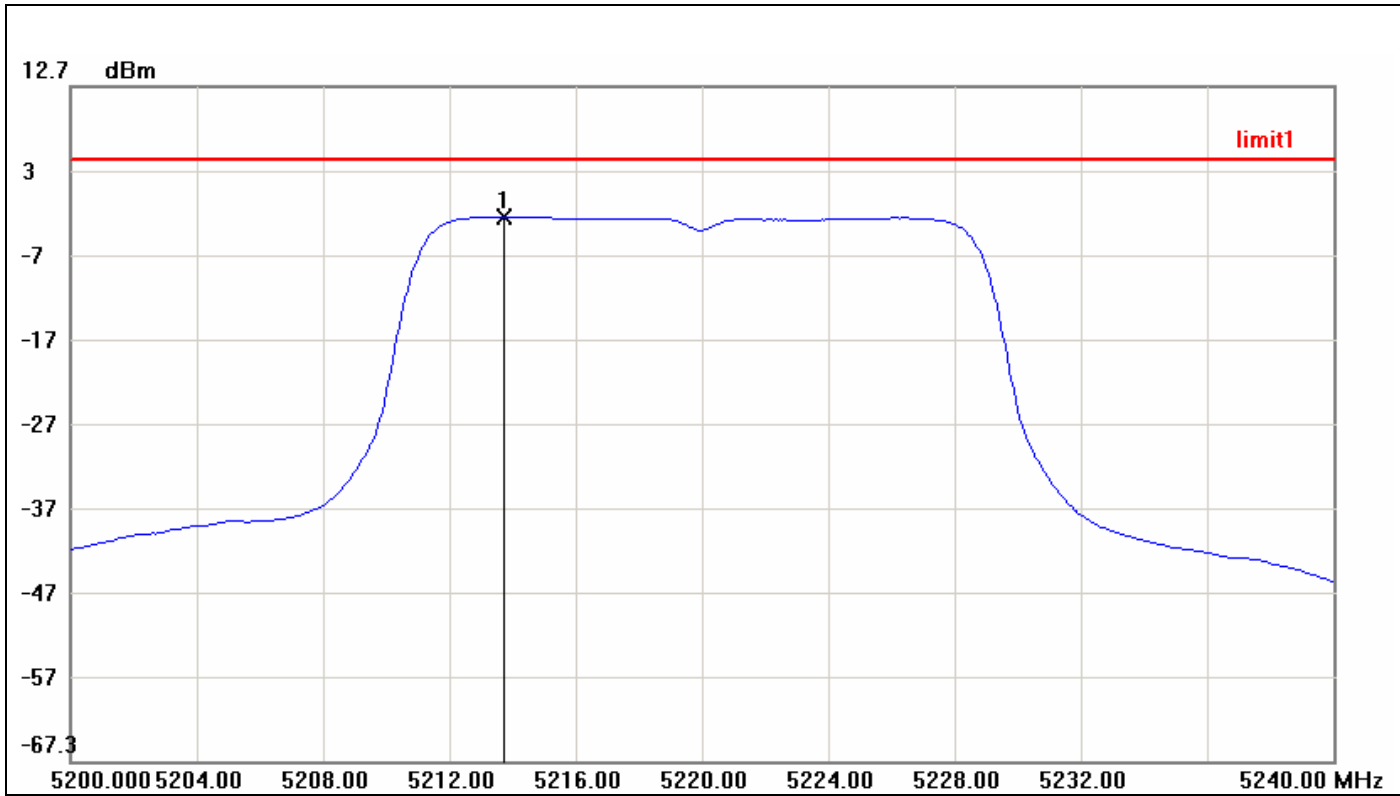

No.	Frequency(MHz)	Result(dBm)	Limit(dBm)	Margin(dBm)
1	5213.7333	-2.72	4.00	-6.72



CH High

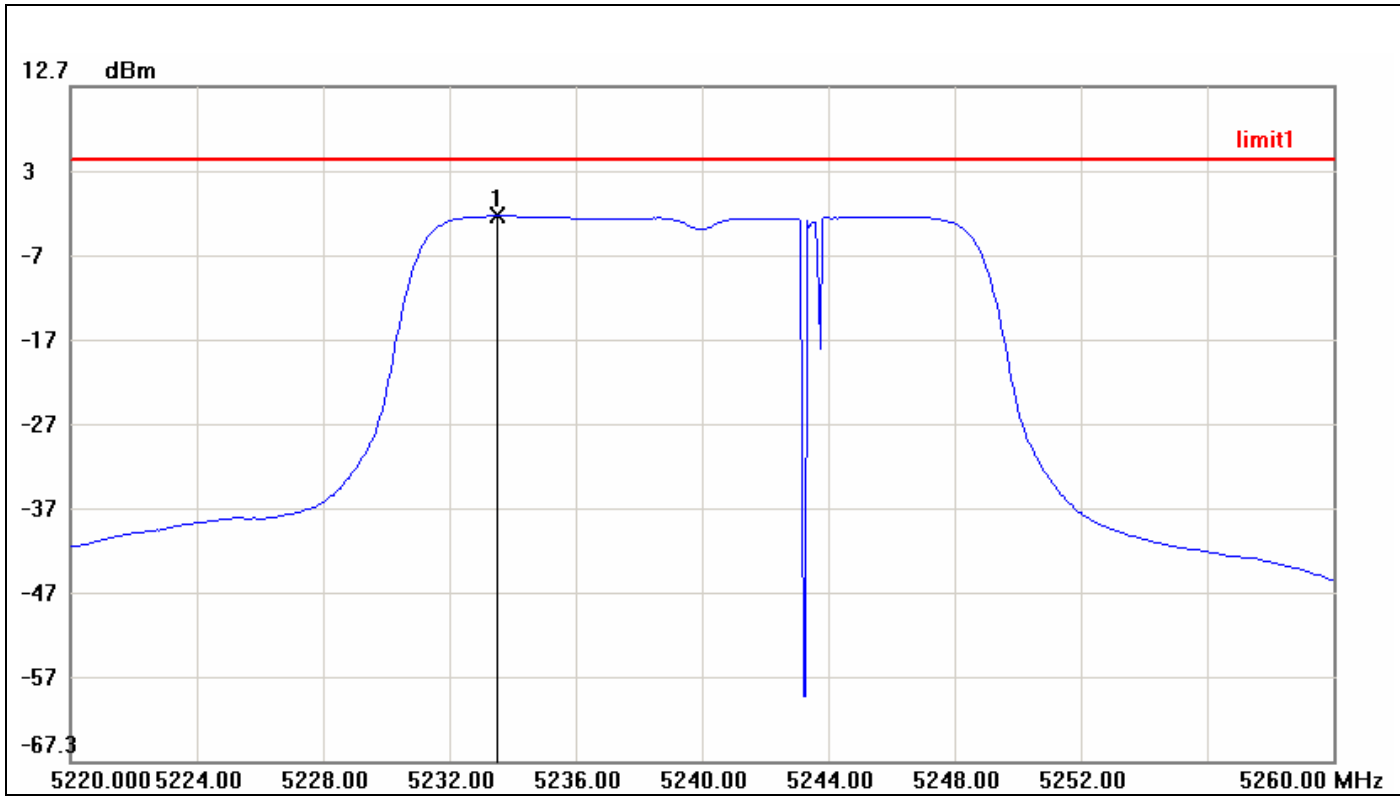

No.	Frequency(MHz)	Result(dBm)	Limit(dBm)	Margin(dBm)
1	5233.5333	-2.63	4.00	-6.63



IEEE 802.11n HT 40 MHz mode / 5190 ~ 5230MHz

CH Low

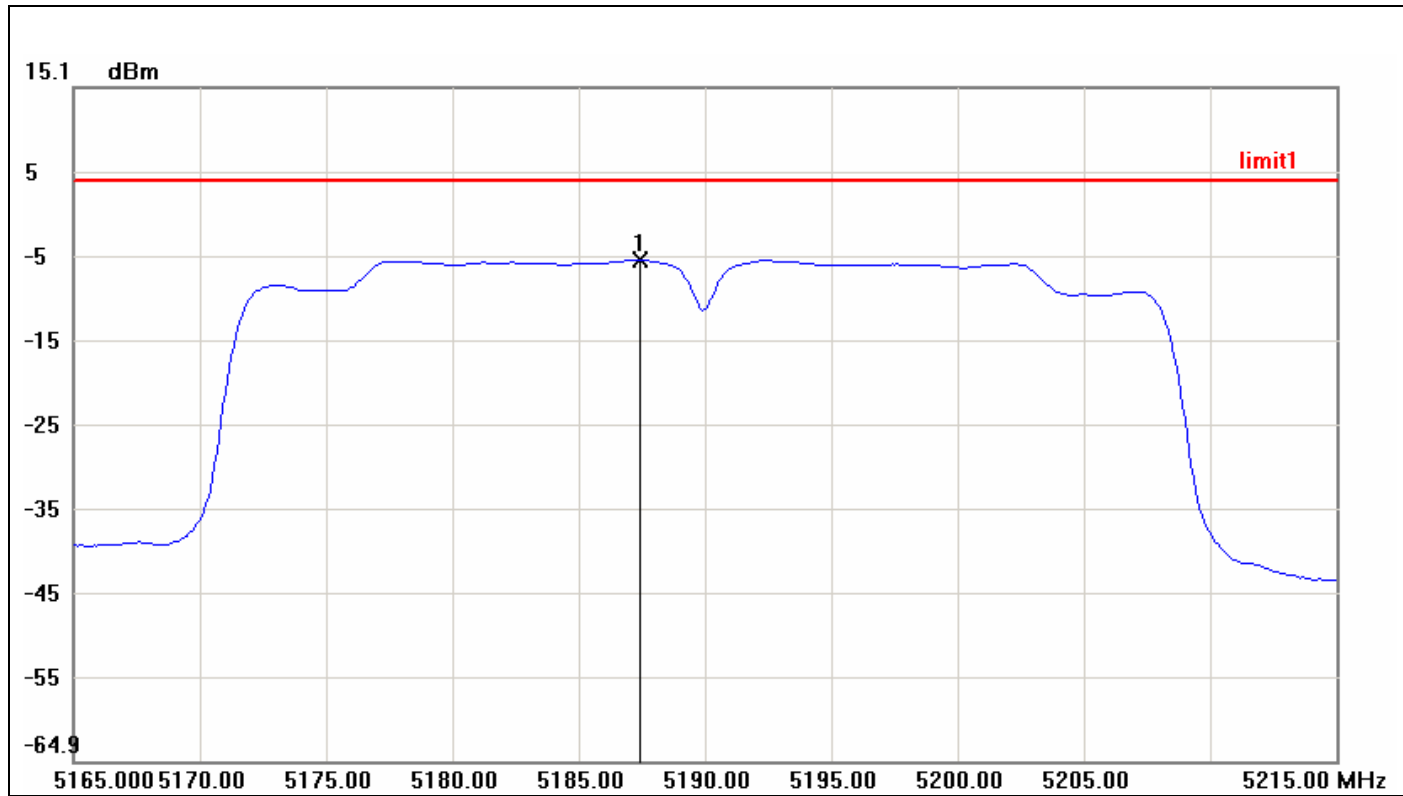

No.	Frequency(MHz)	Result(dBm)	Limit(dBm)	Margin(dBm)
1	5187.4167	-5.33	4.00	-9.33



CH High

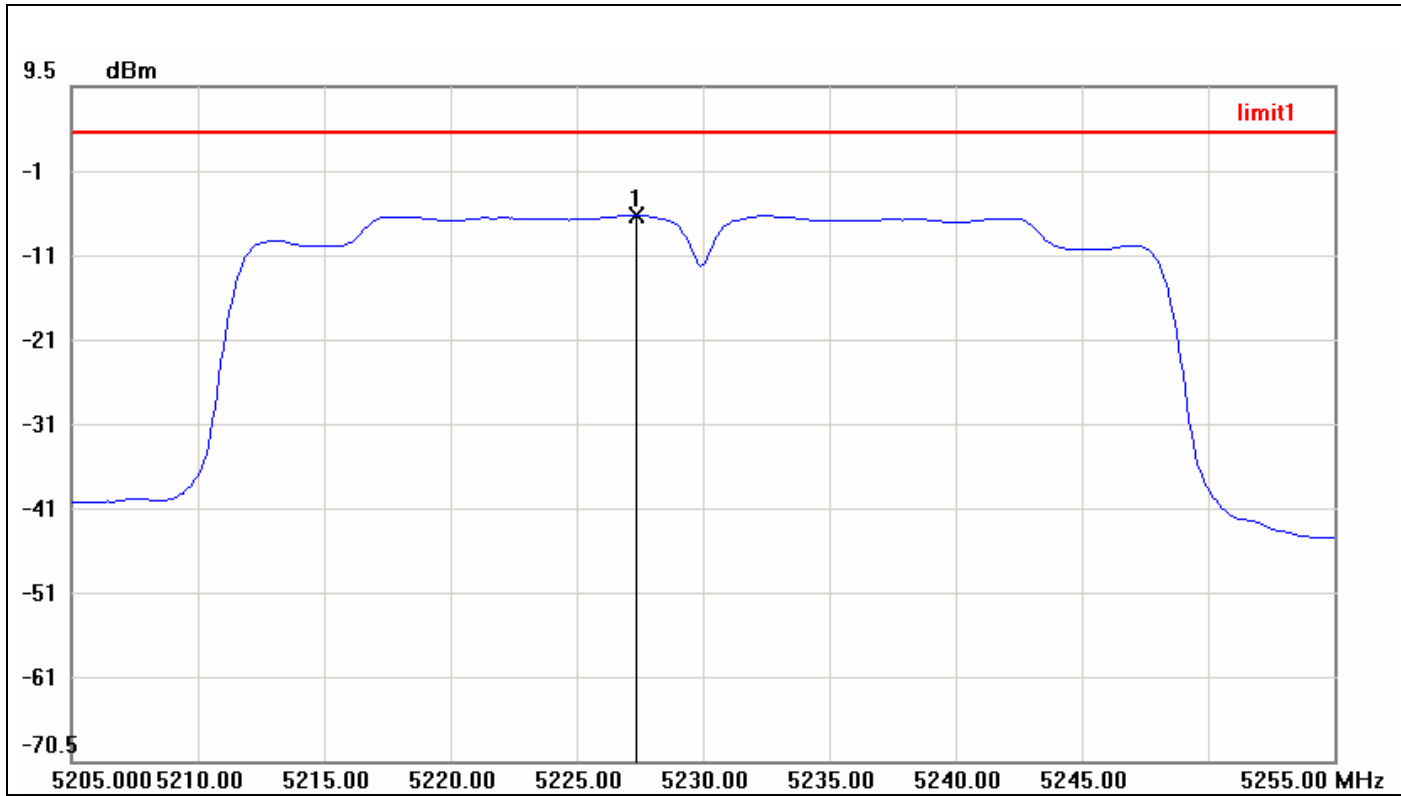

No.	Frequency(MHz)	Result(dBm)	Limit(dBm)	Margin(dBm)
1	5227.3333	-5.80	4.00	-9.80



IEEE 802.11a mode / 5260 ~ 5320MHz

CH Low

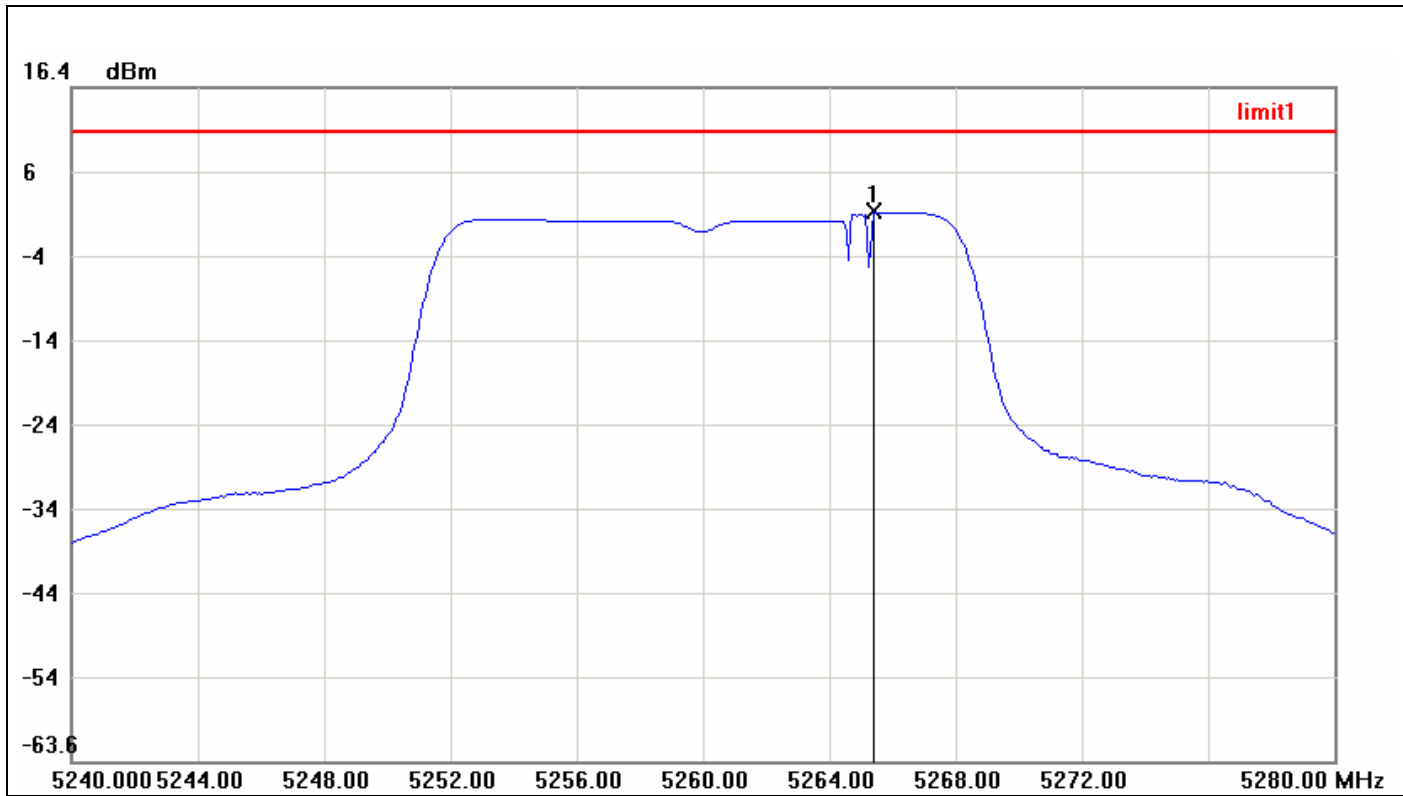

No.	Frequency(MHz)	Result(dBm)	Limit(dBm)	Margin(dBm)
1	5265.4000	1.58	11.00	-9.42



CH Mid

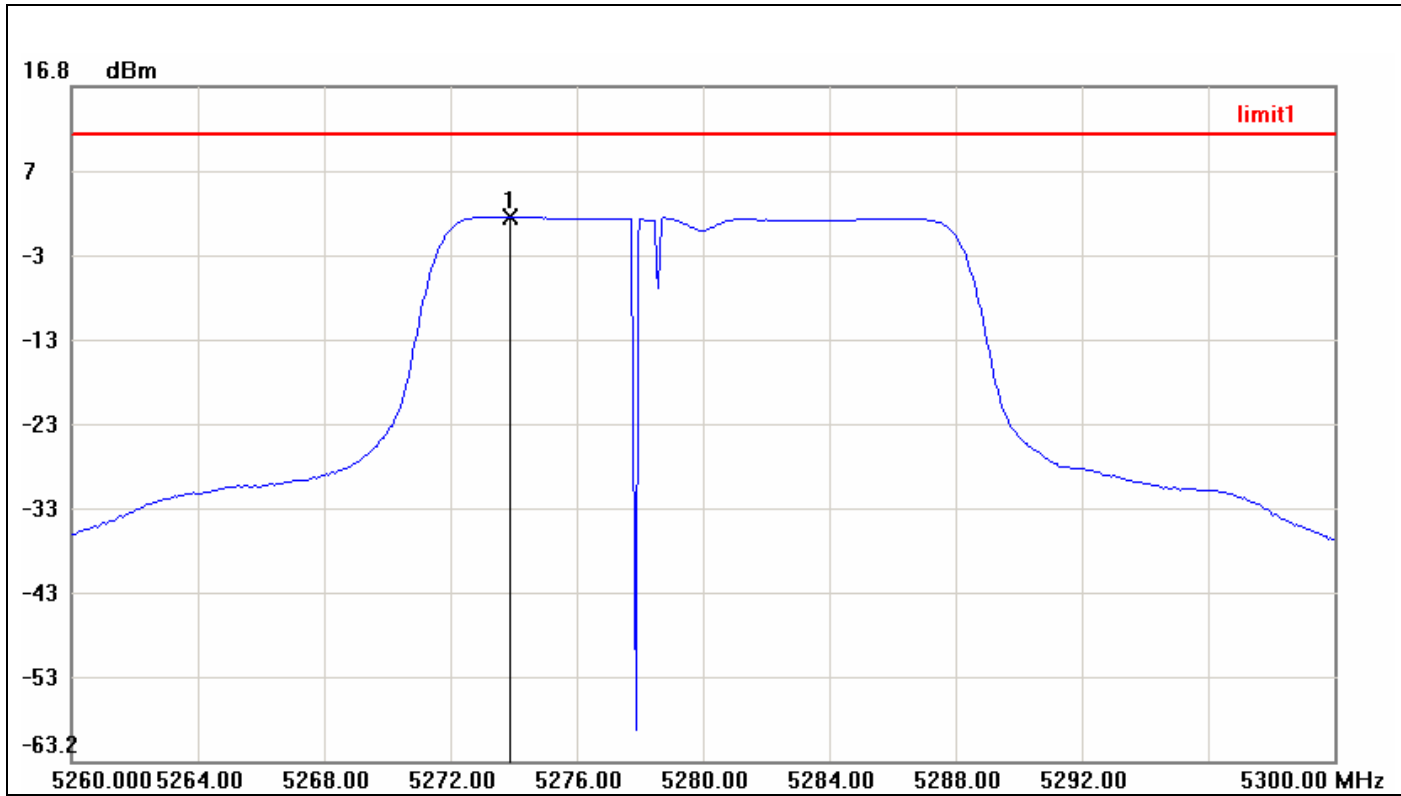

No.	Frequency(MHz)	Result(dBm)	Limit(dBm)	Margin(dBm)
1	5273.8667	1.37	11.00	-9.63



CH High

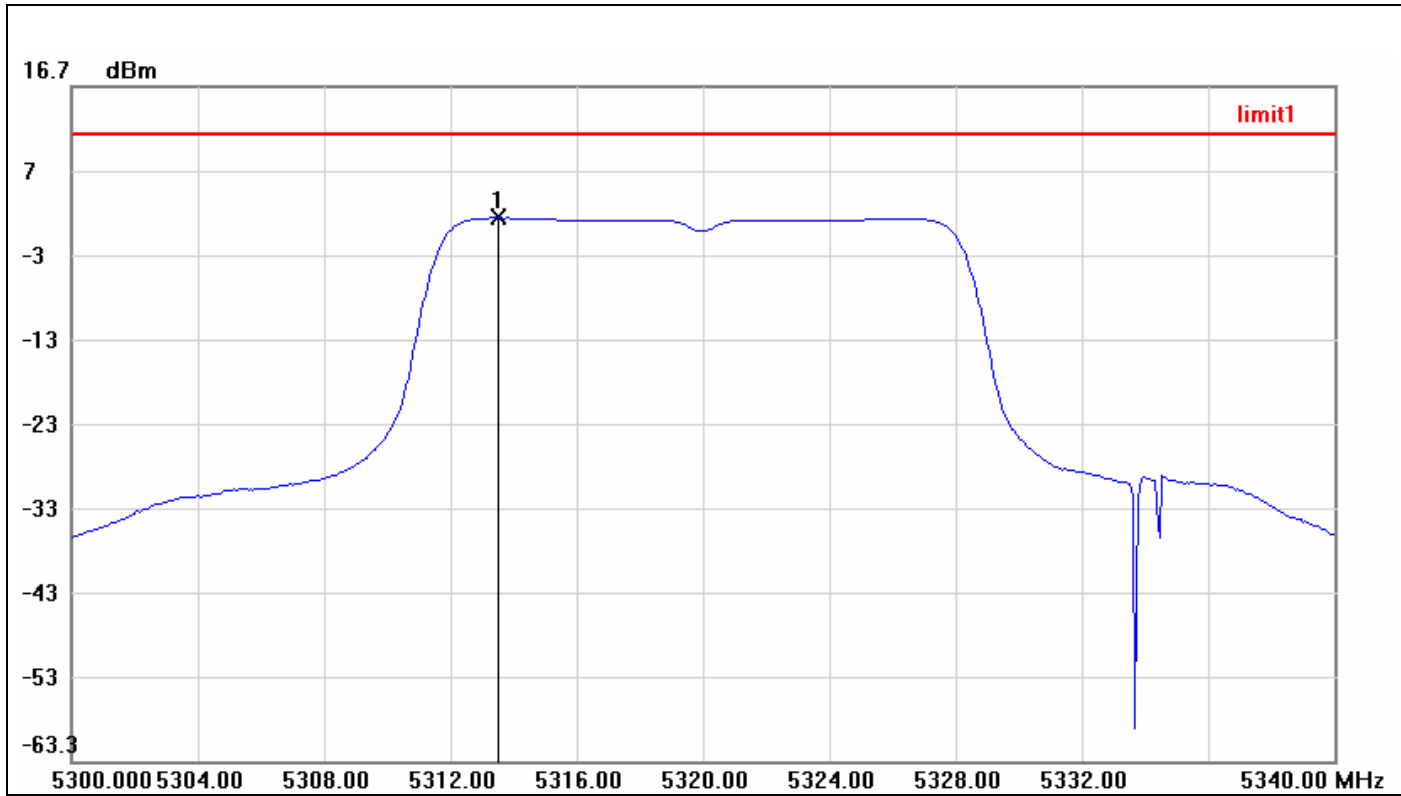

No.	Frequency(MHz)	Result(dBm)	Limit(dBm)	Margin(dBm)
1	5313.5333	1.11	11.00	-9.89



IEEE 802.11n HT 20 MHz mode / 5260 ~ 5320MHz

CH Low

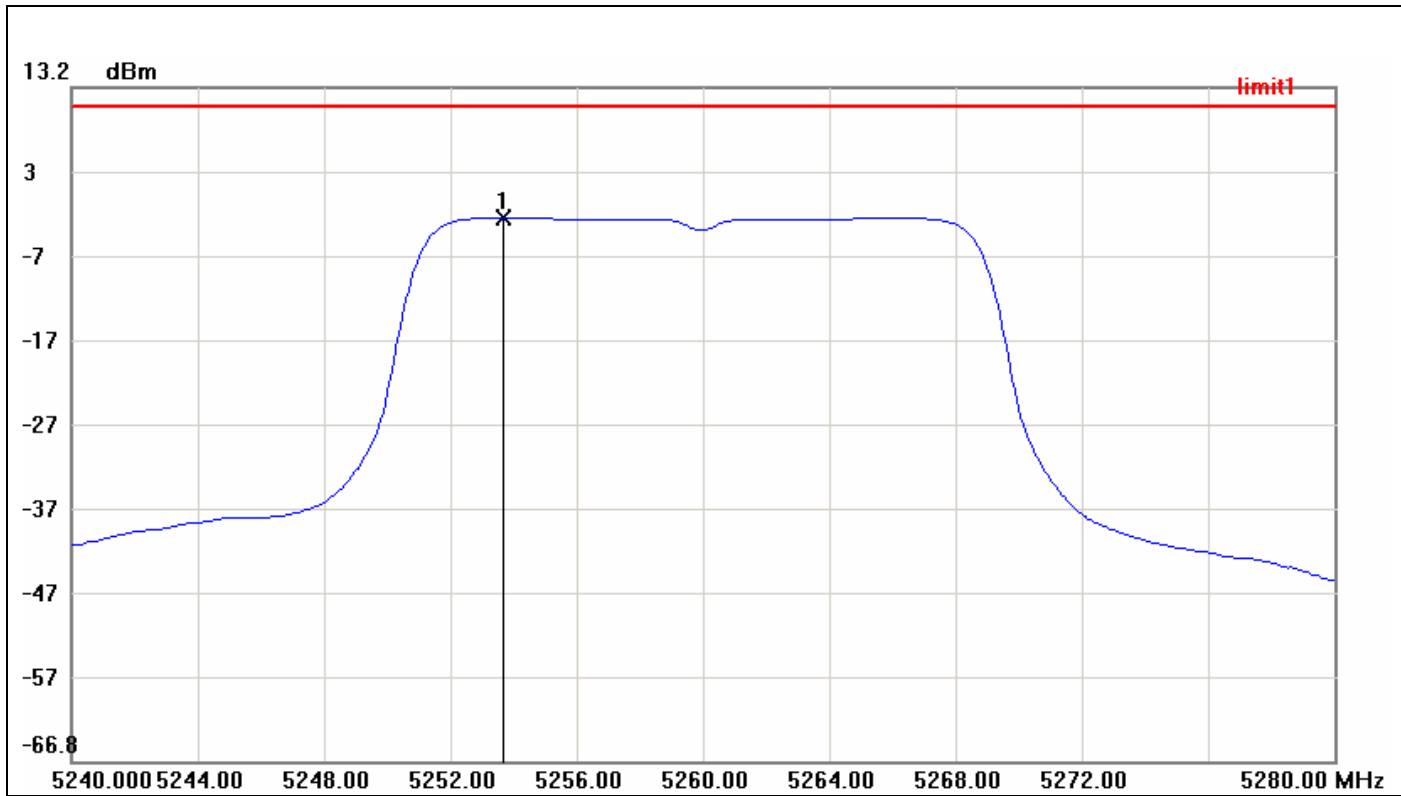

No.	Frequency(MHz)	Result(dBm)	Limit(dBm)	Margin(dBm)
1	5253.6667	-2.23	11.00	-13.23



CH Mid

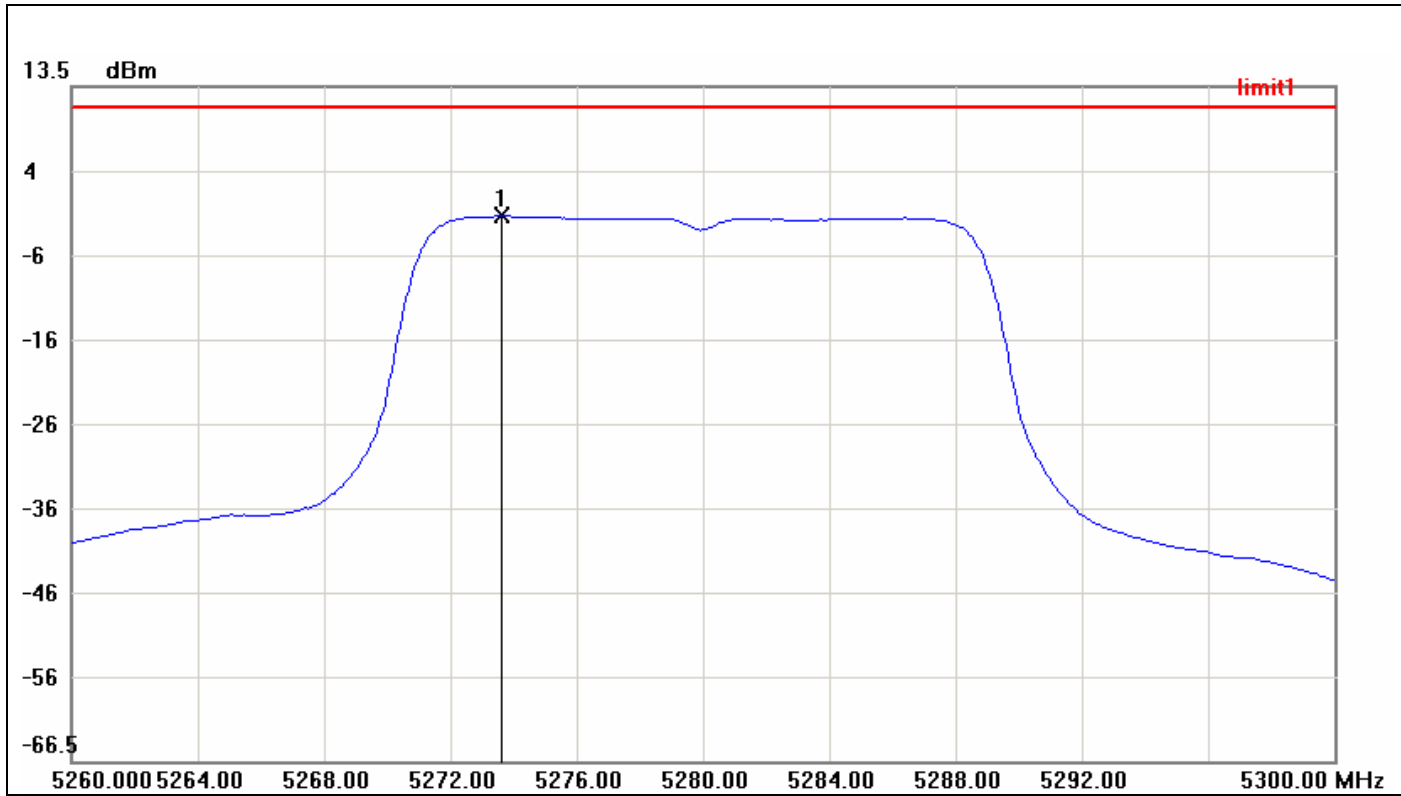

No.	Frequency(MHz)	Result(dBm)	Limit(dBm)	Margin(dBm)
1	5273.6000	-1.85	11.00	-12.85



CH High

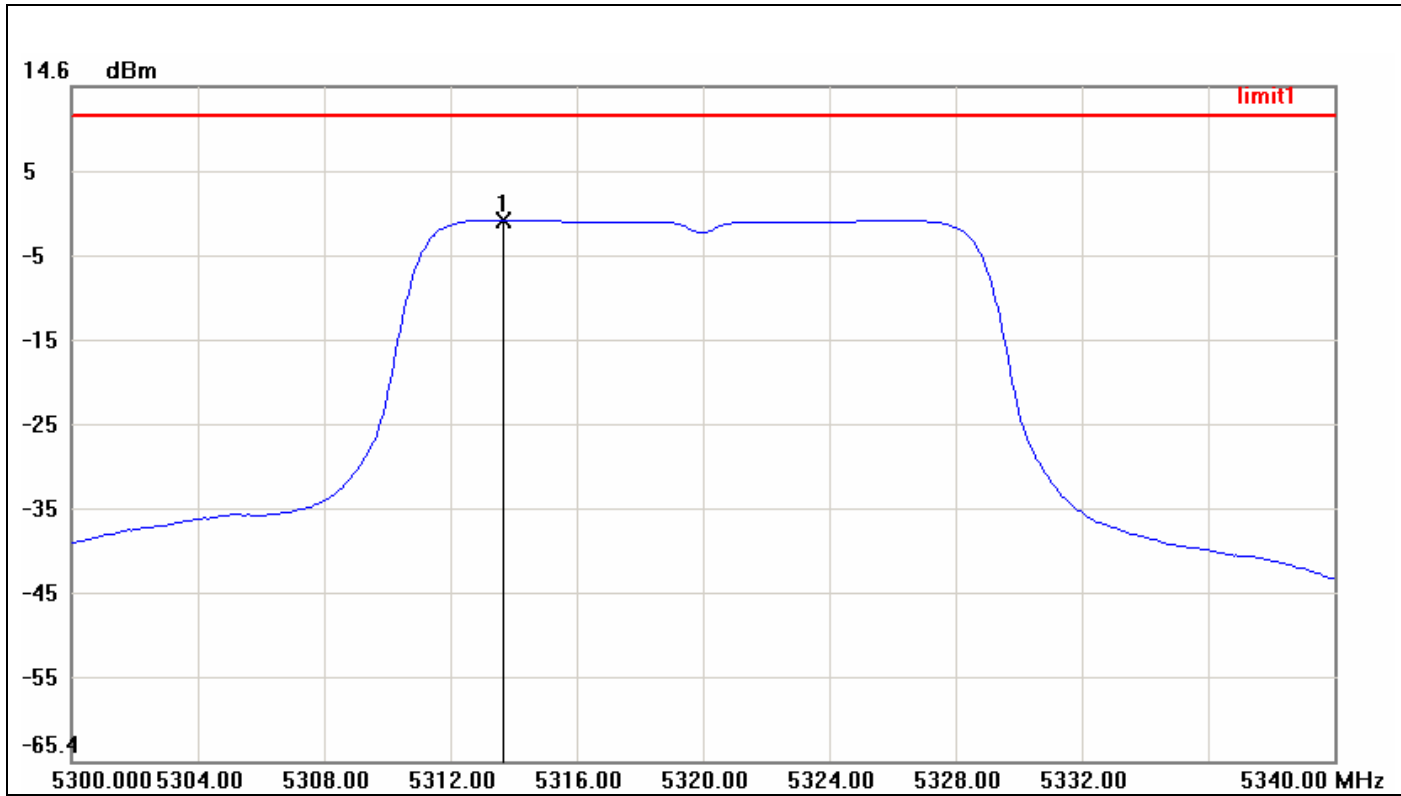

No.	Frequency(MHz)	Result(dBm)	Limit(dBm)	Margin(dBm)
1	5313.6667	-1.25	11.00	-12.25



IEEE 802.11n HT 40 MHz mode / 5270 ~ 5310MHz

CH Low

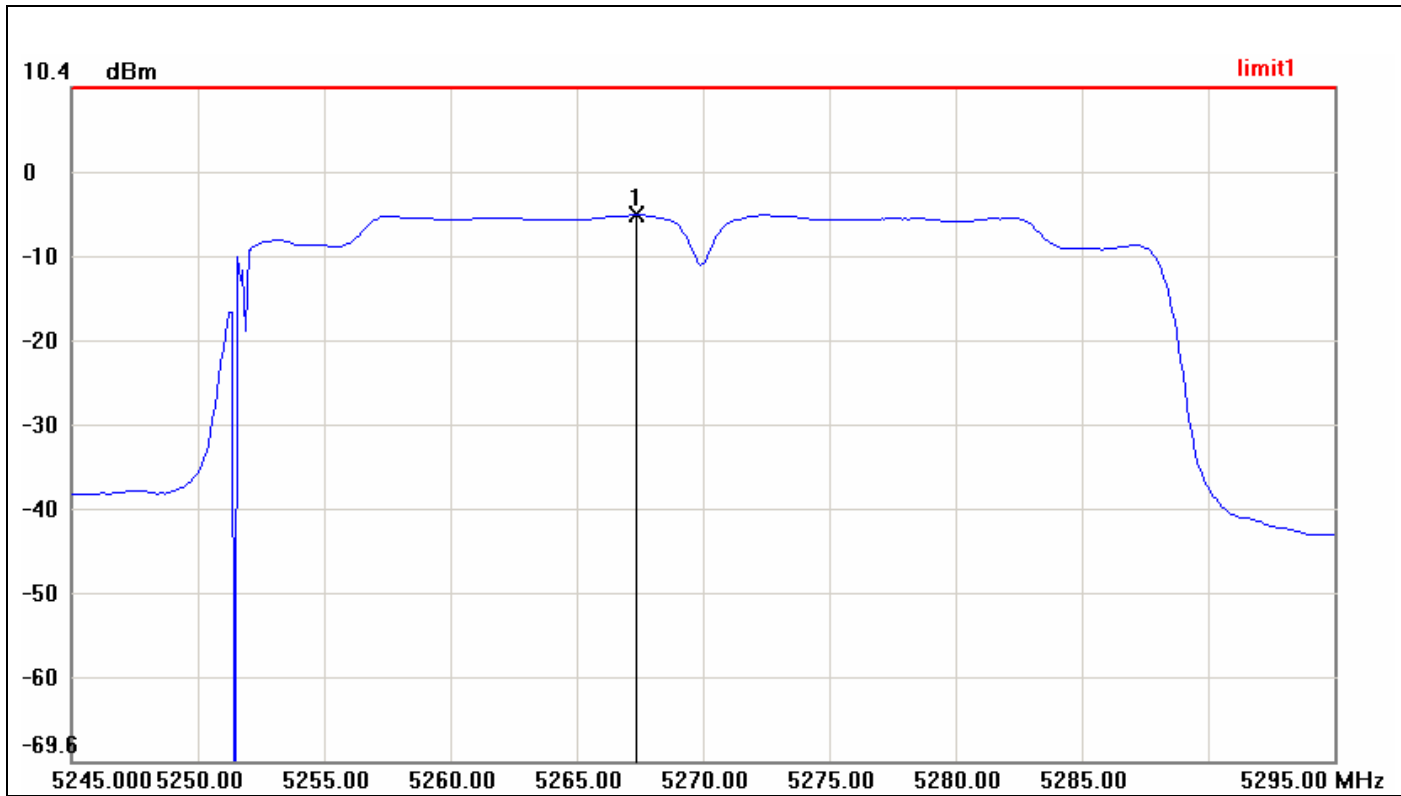

No.	Frequency(MHz)	Result(dBm)	Limit(dBm)	Margin(dBm)
1	5267.3333	-4.71	11.00	-15.71



CH High

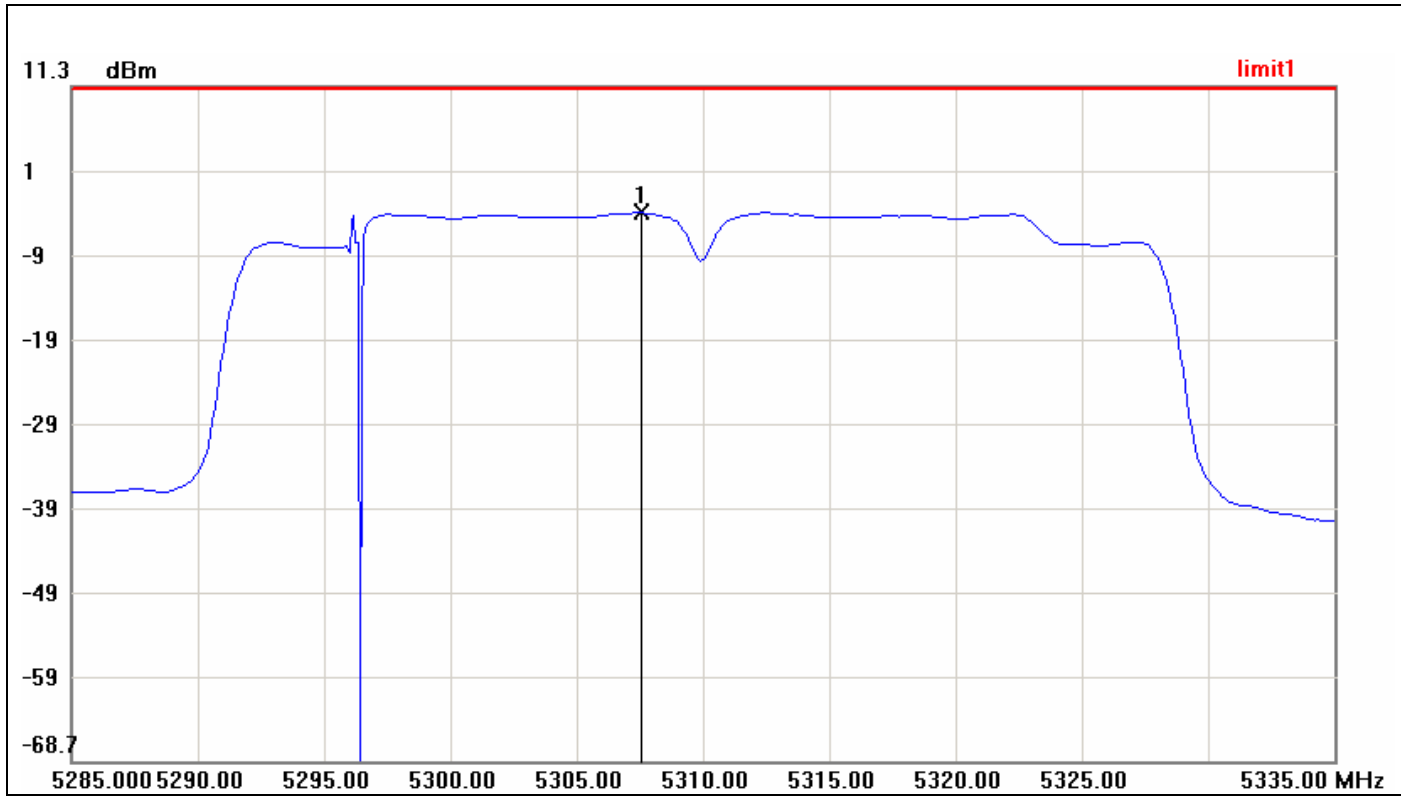

No.	Frequency(MHz)	Result(dBm)	Limit(dBm)	Margin(dBm)
1	5307.5833	-3.66	11.00	-14.66



Test mode: IEEE 802.11a mode / 5500 ~ 5700MHz

CH Low

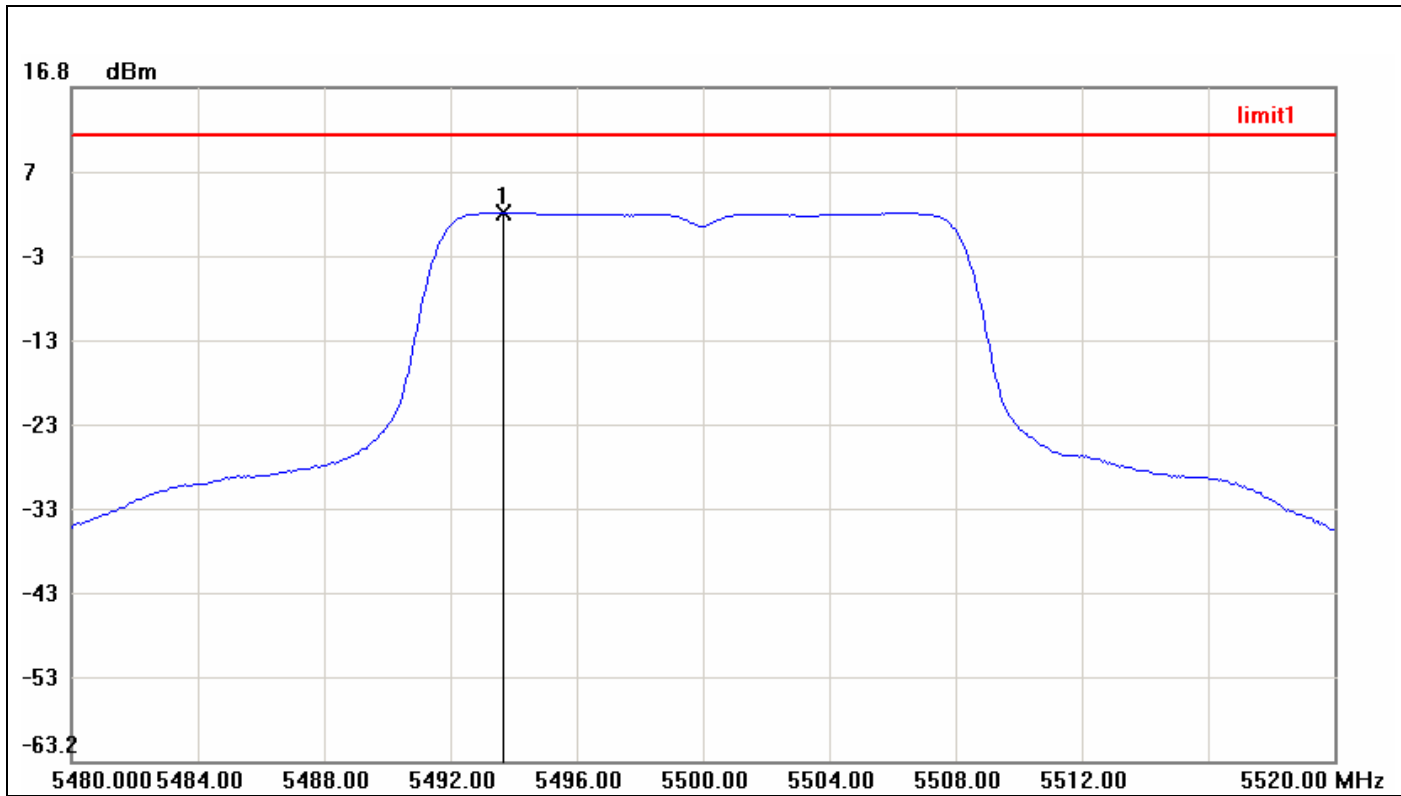

No.	Frequency(MHz)	Result(dBm)	Limit(dBm)	Margin(dBm)
1	5493.6667	1.93	11.00	-9.07



CH Mid

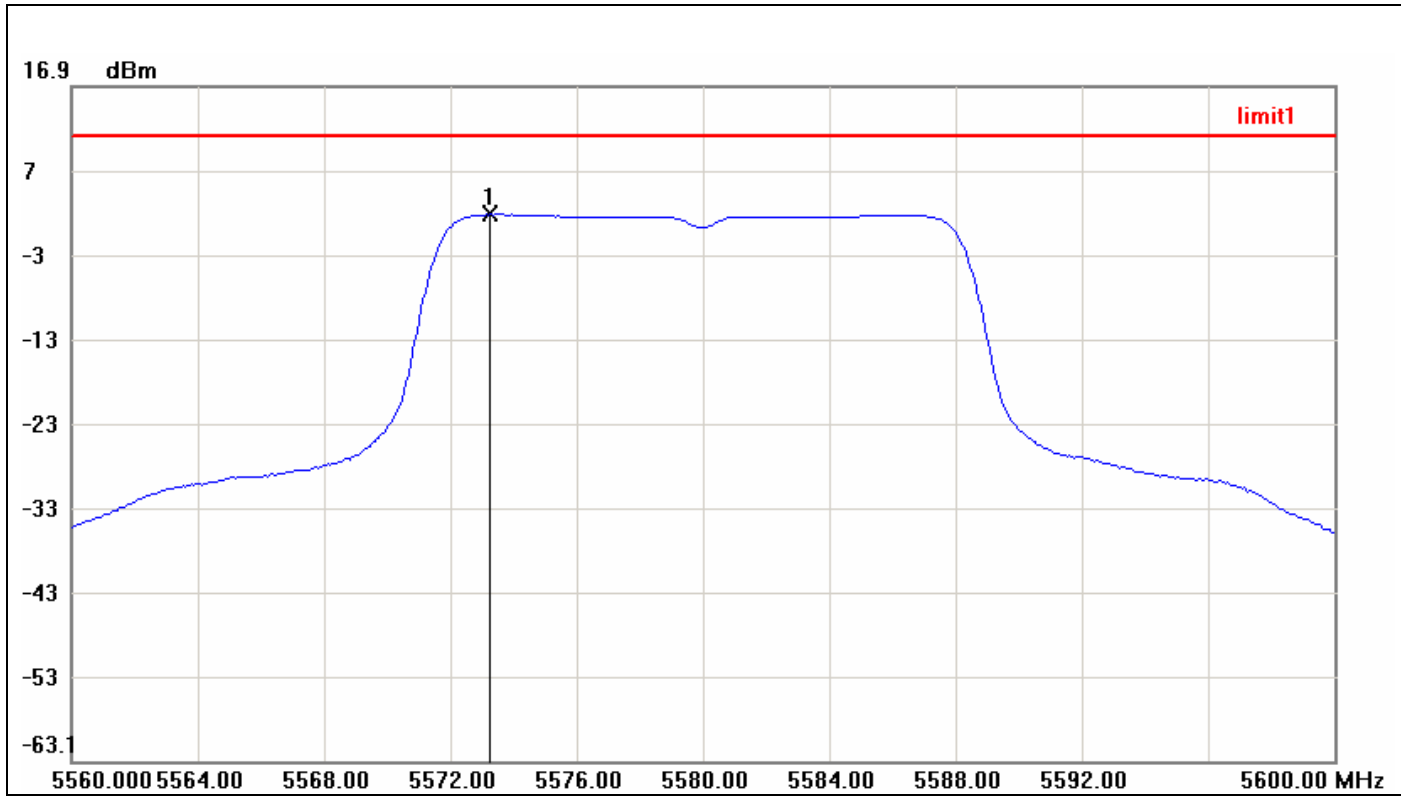

No.	Frequency(MHz)	Result(dBm)	Limit(dBm)	Margin(dBm)
1	5573.2667	1.77	11.00	-9.23



CH High

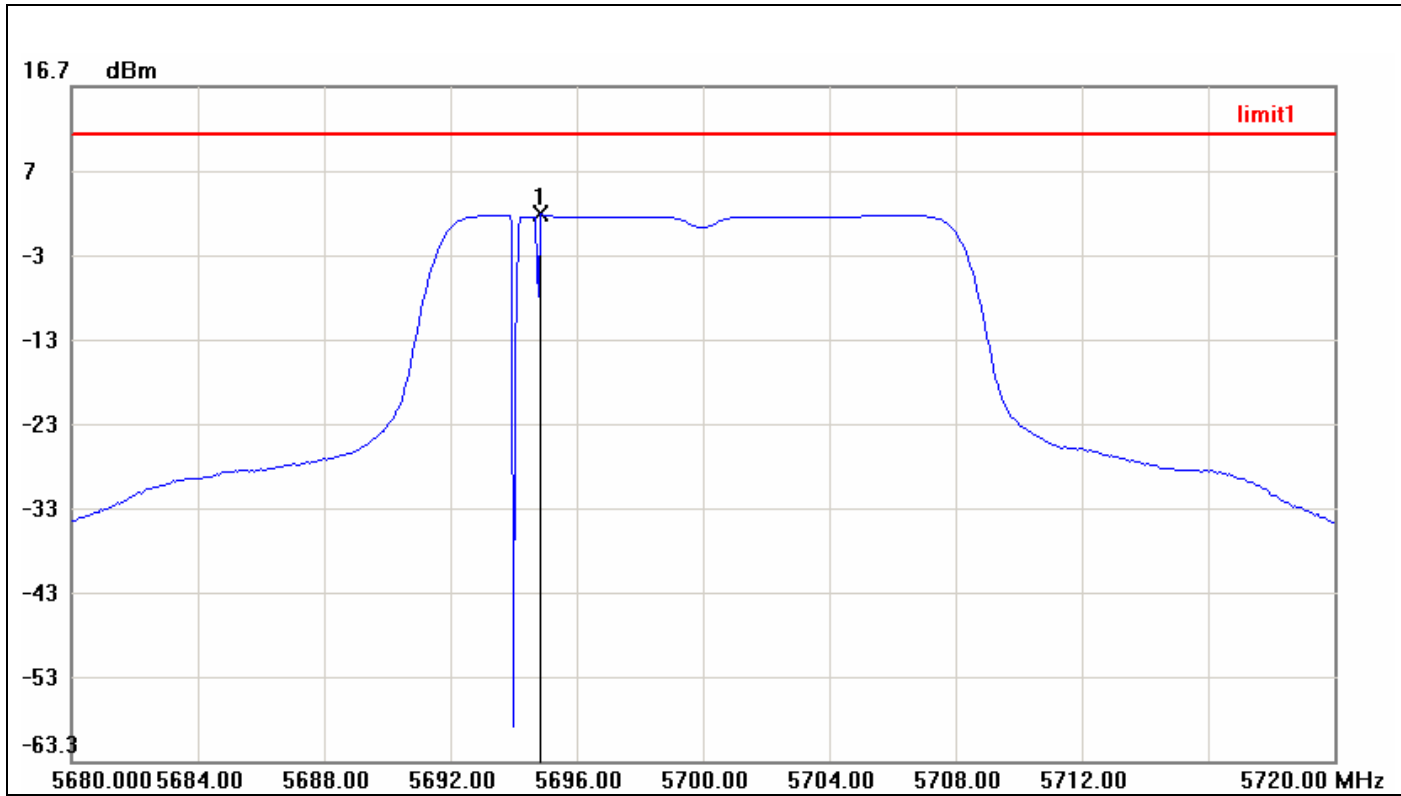

No.	Frequency(MHz)	Result(dBm)	Limit(dBm)	Margin(dBm)
1	5694.8667	1.61	11.00	-9.39



IEEE 802.11n HT 20 MHz mode / 5500 ~ 5700MHz

CH Low

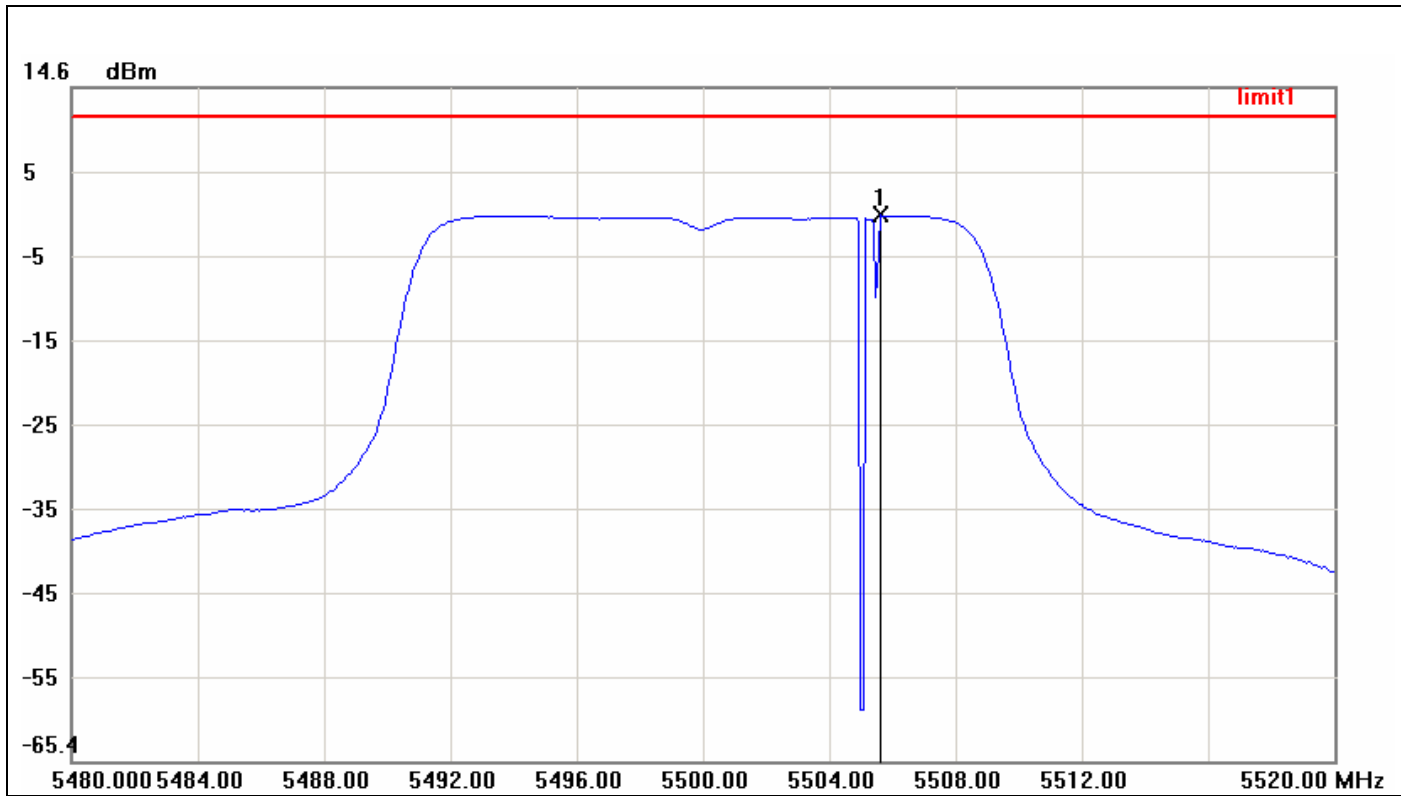

No.	Frequency(MHz)	Result(dBm)	Limit(dBm)	Margin(dBm)
1	5505.6000	-0.50	11.00	-11.50



CH Mid

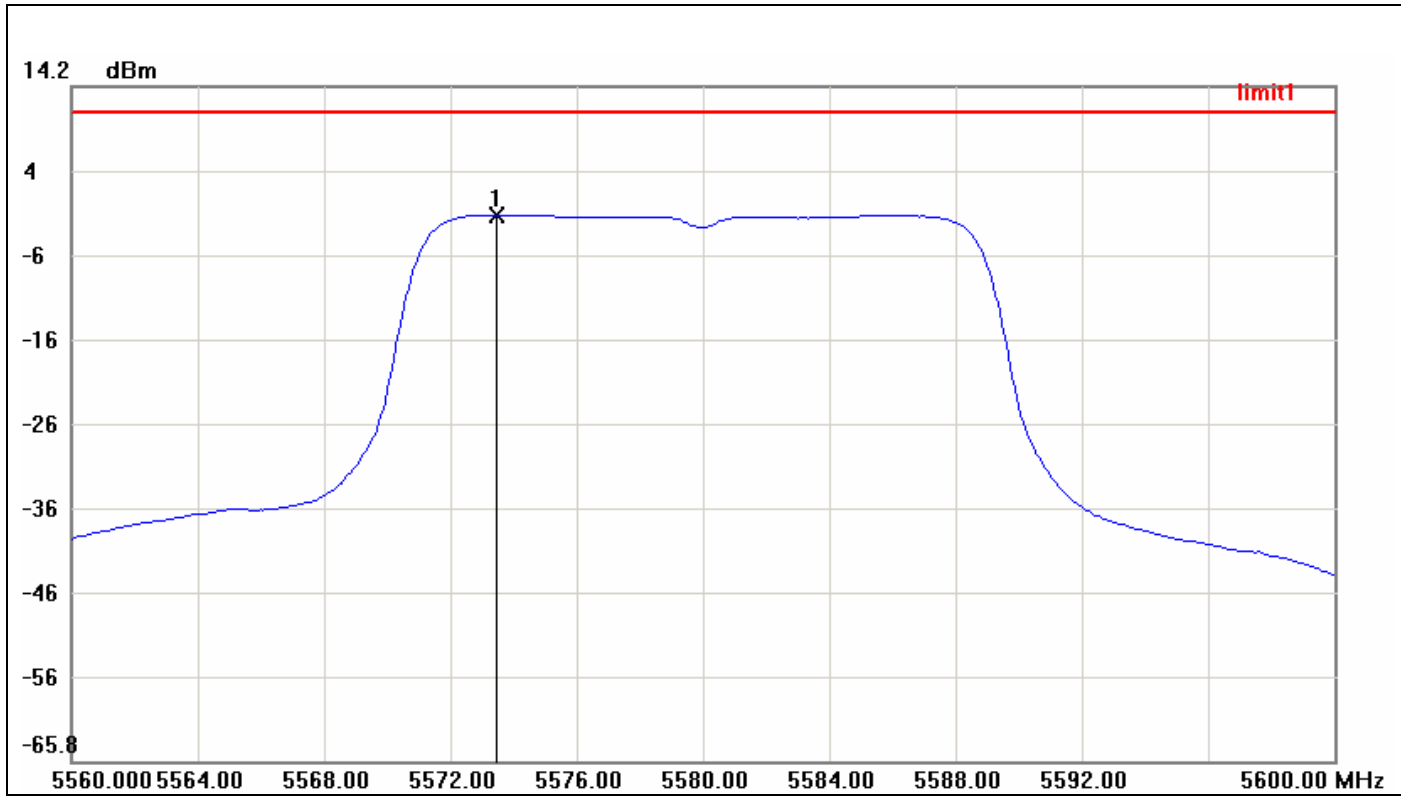

No.	Frequency(MHz)	Result(dBm)	Limit(dBm)	Margin(dBm)
1	5573.4667	-1.07	11.00	-12.07



CH High

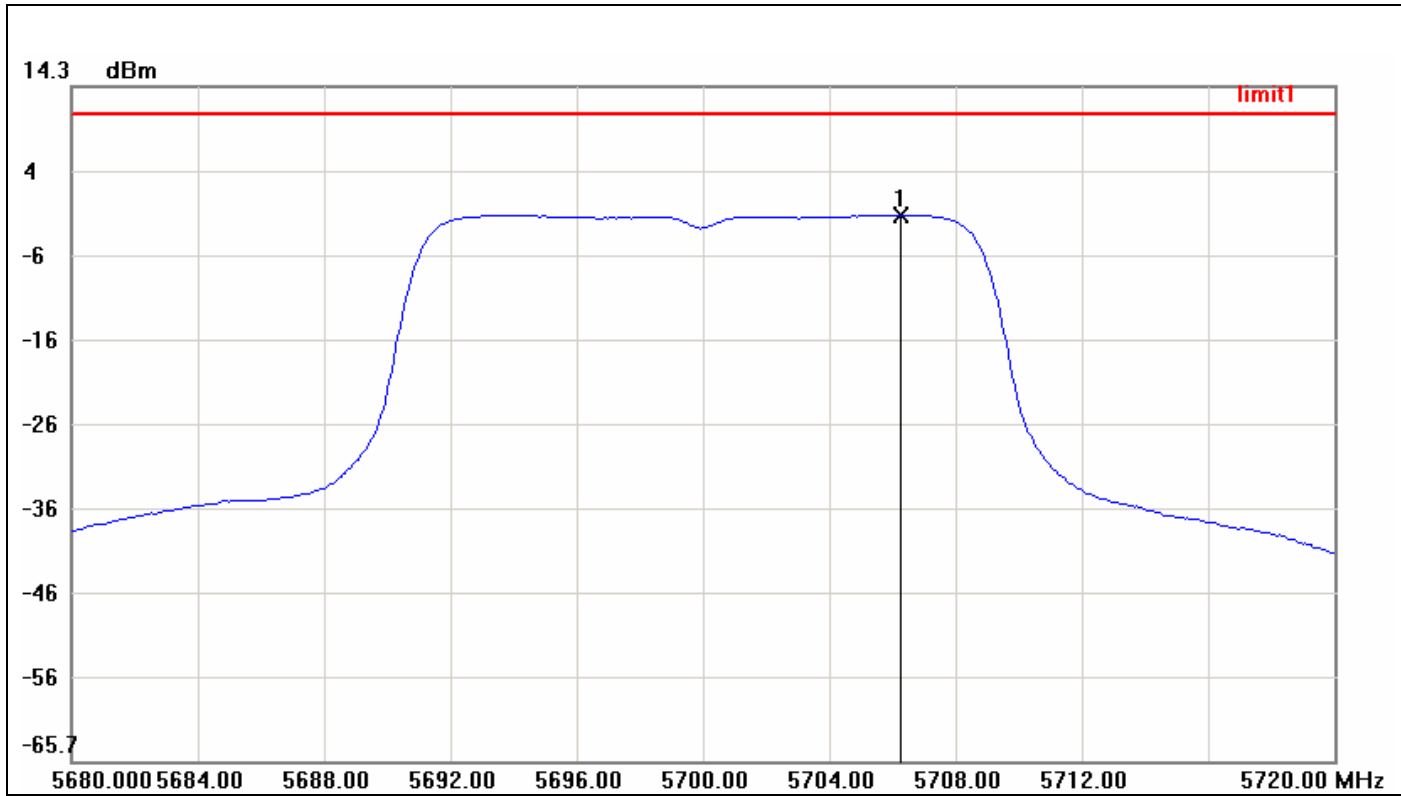

No.	Frequency(MHz)	Result(dBm)	Limit(dBm)	Margin(dBm)
1	5706.2667	-0.98	11.00	-11.98



IEEE 802.11n HT 40 MHz mode / 5510 ~ 5670MHz

CH Low

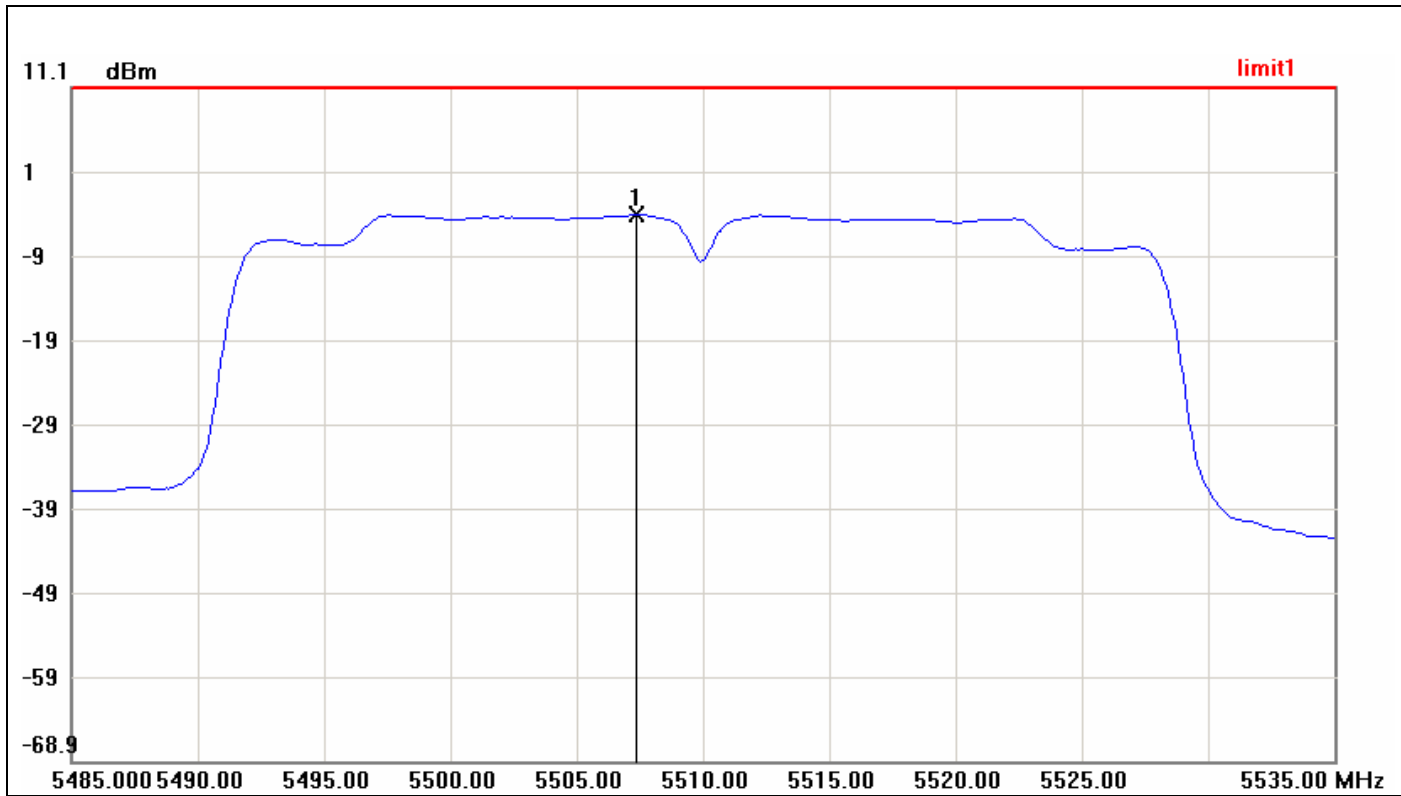

No.	Frequency(MHz)	Result(dBm)	Limit(dBm)	Margin(dBm)
1	5507.3333	-4.05	11.00	-15.05



CH Mid

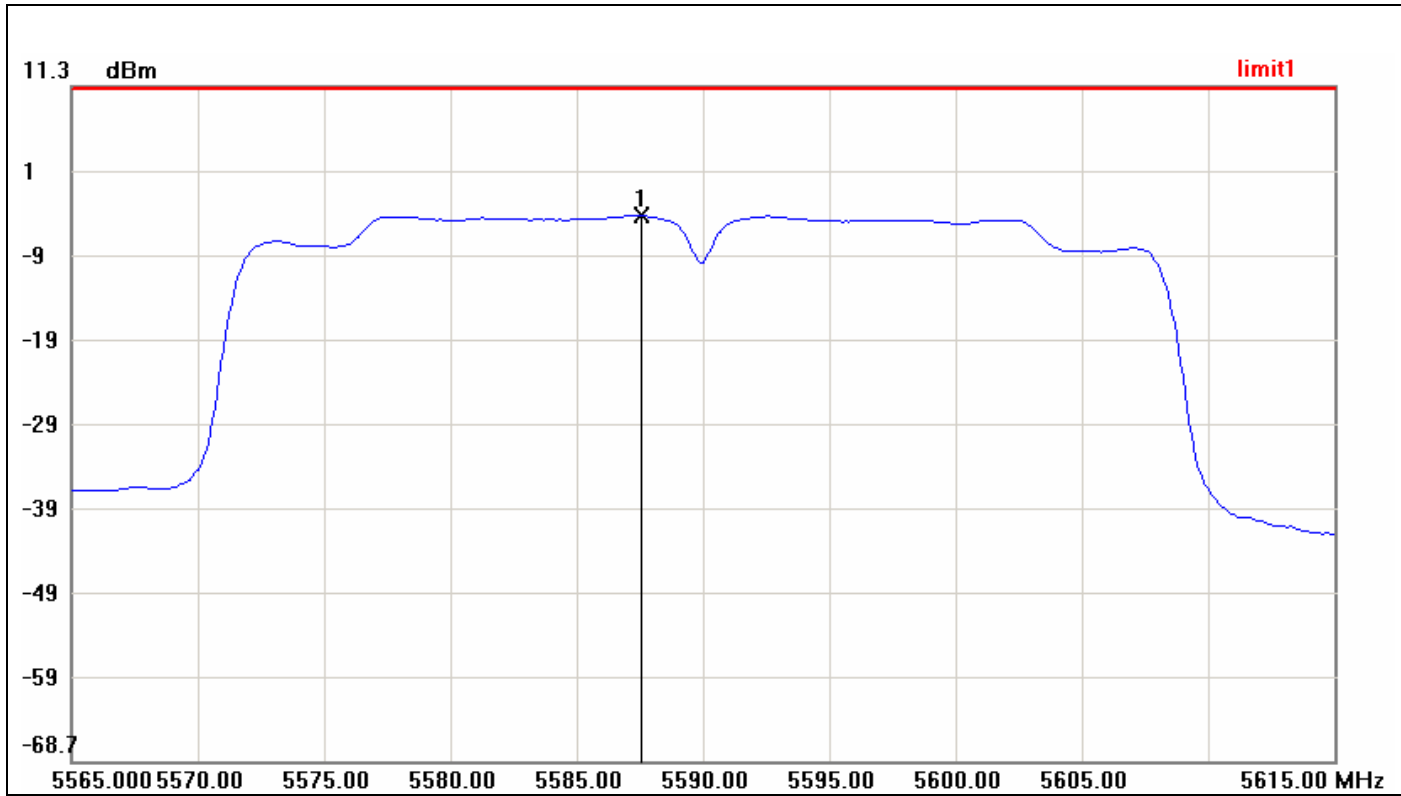

No.	Frequency(MHz)	Result(dBm)	Limit(dBm)	Margin(dBm)
1	5547.5833	-4.02	11.00	-15.02



CH High

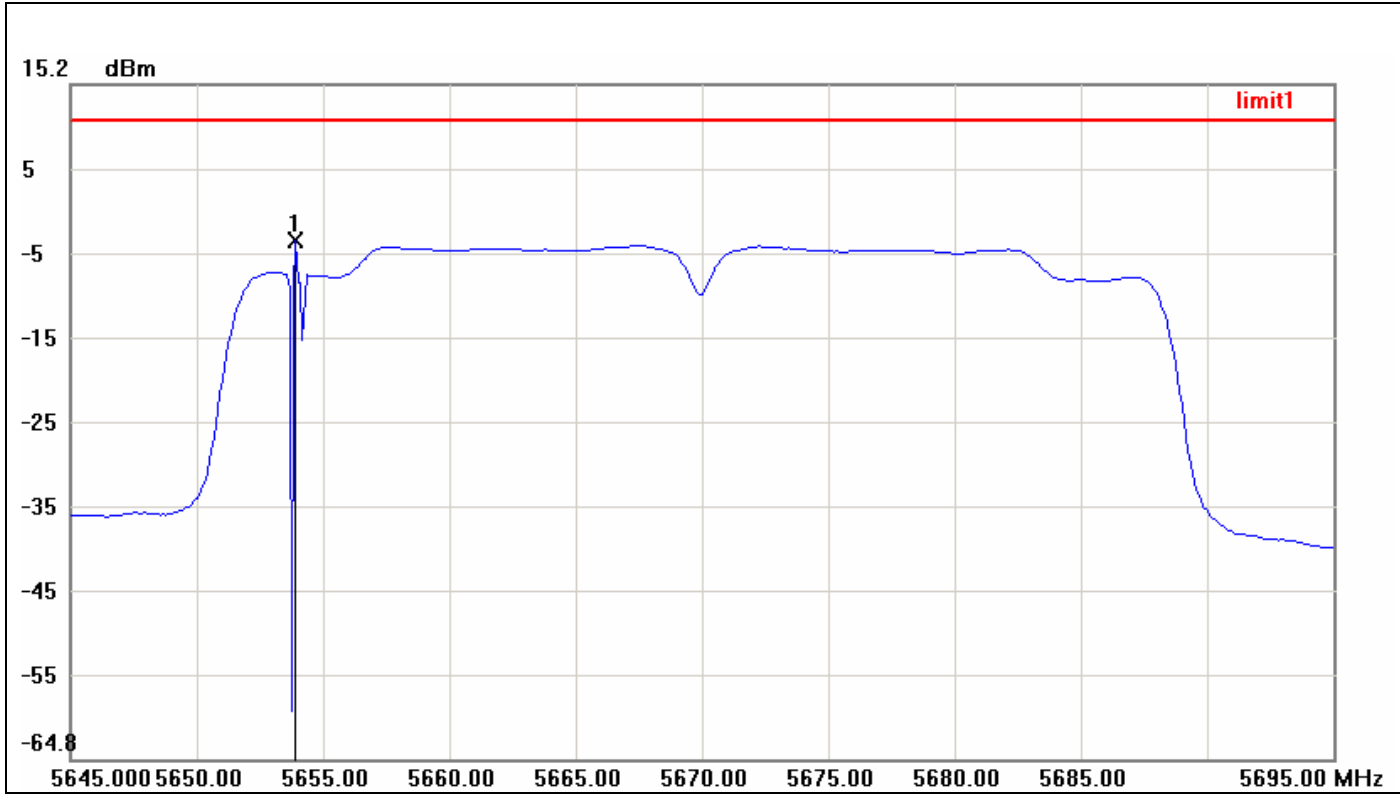

No.	Frequency(MHz)	Result(dBm)	Limit(dBm)	Margin(dBm)
1	5653.9167	-3.22	11.00	-14.22



7.5 PEAK EXCURSION

LIMIT

According to §15.407(a)(6), the ratio of the peak excursion of the modulation envelope (measured using a peak hold function) to the maximum conducted output power (measured as specified above) shall not exceed 13 dB across any 1 MHz bandwidth or the emission bandwidth whichever is less.

Test Configuration

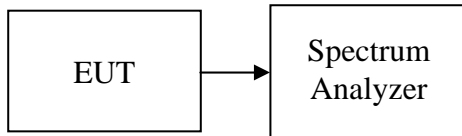

TEST PROCEDURE

The test is performed in accordance with <FCC Public Notice: APPENDIX A Guidelines for Assessing Unlicensed National Information Infrastructure (U-NII) Devices> – Part 15, Subpart E, August 2002.

1. Place the EUT on the table and set it in transmitting mode.
2. Remove the antenna from the EUT and then connect a low loss RF cable from the antenna port to spectrum.
3. Trace A, Set RBW = 1MHz, VBW = 3MHz, Span >26dB bandwidth, Max. hold.
4. Delta Mark trace A Maximum frequency and trace B same frequency.
5. Repeat the above procedure until measurements for all frequencies were complete.

TEST RESULTS

No non-compliance noted

**Test Data****Test mode: IEEE 802.11a mode / 5180 ~ 5240MHz**

Channel	Frequency (MHz)	Peak Excursion (dB)	Limit (dB)	Margin (dB)	Result
Low	5180	8.29	13.00	-4.71	PASS
Mid	5220	8.72	13.00	-4.28	PASS
High	5240	8.18	13.00	-4.82	PASS

Test mode: IEEE 802.11n HT 20 MHz mode / 5180 ~ 5240MHz

Channel	Frequency (MHz)	Peak Excursion (dB)	Limit (dB)	Margin (dB)	Result
Low	5180	10.43	13.00	-2.57	PASS
Mid	5220	10.41	13.00	-2.59	PASS
High	5240	10.02	13.00	-2.98	PASS

Test mode: IEEE 802.11n HT 40 MHz mode / 5190 ~ 5230MHz

Channel	Frequency (MHz)	Peak Excursion (dB)	Limit (dB)	Margin (dB)	Result
Low	5190	10.03	13.00	-2.97	PASS
High	5230	10.79	13.00	-2.21	PASS

Test mode: IEEE 802.11a mode / 5260 ~ 5320MHz

Channel	Frequency (MHz)	Peak Excursion (dB)	Limit (dB)	Margin (dB)	Result
Low	5260	8.65	13.00	-4.35	PASS
Mid	5280	8.18	13.00	-4.82	PASS
High	5320	8.27	13.00	-4.73	PASS

Test mode: IEEE 802.11n HT 20 MHz mode / 5260 ~ 5320MHz

Channel	Frequency (MHz)	Peak Excursion (dB)	Limit (dB)	Margin (dB)	Result
Low	5260	10.45	13.00	-2.55	PASS
Mid	5280	10.28	13.00	-2.72	PASS
High	5320	10.34	13.00	-2.66	PASS

Test mode: IEEE 802.11n HT 40 MHz mode / 5270 ~ 5310MHz

Channel	Frequency (MHz)	Peak Excursion (dB)	Limit (dB)	Margin (dB)	Result
Low	5270	9.96	13.00	-3.04	PASS
High	5310	9.93	13.00	-3.07	PASS



Test mode: IEEE 802.11a mode / 5500 ~ 5700MHz

Channel	Frequency (MHz)	Peak Excursion (dB)	Limit (dB)	Margin (dB)	Result
Low	5500	8.81	13.00	-4.19	PASS
Mid	5600	8.92	13.00	-4.08	PASS
High	5700	8.83	13.00	-4.17	PASS

Test mode: IEEE 802.11n HT 20 MHz mode / 5500 ~ 5700MHz

Channel	Frequency (MHz)	Peak Excursion (dB)	Limit (dB)	Margin (dB)	Result
Low	5500	10.43	13.00	-2.57	PASS
Mid	5600	10.53	13.00	-2.47	PASS
High	5700	10.86	13.00	-2.14	PASS

Test mode: IEEE 802.11n HT 40 MHz mode / 5510 ~ 5670MHz

Channel	Frequency (MHz)	Peak Excursion (dB)	Limit (dB)	Margin (dB)	Result
Low	5510	10.29	13.00	-2.71	PASS
Mid	5590	10.48	13.00	-2.52	PASS
High	5670	10.35	13.00	-2.65	PASS



Test Plot

IEEE 802.11a mode / 5180 ~ 5240MHz

CH Low

Agilent

R L

Δ Mkr1 2.25 MHz
8.29 dB

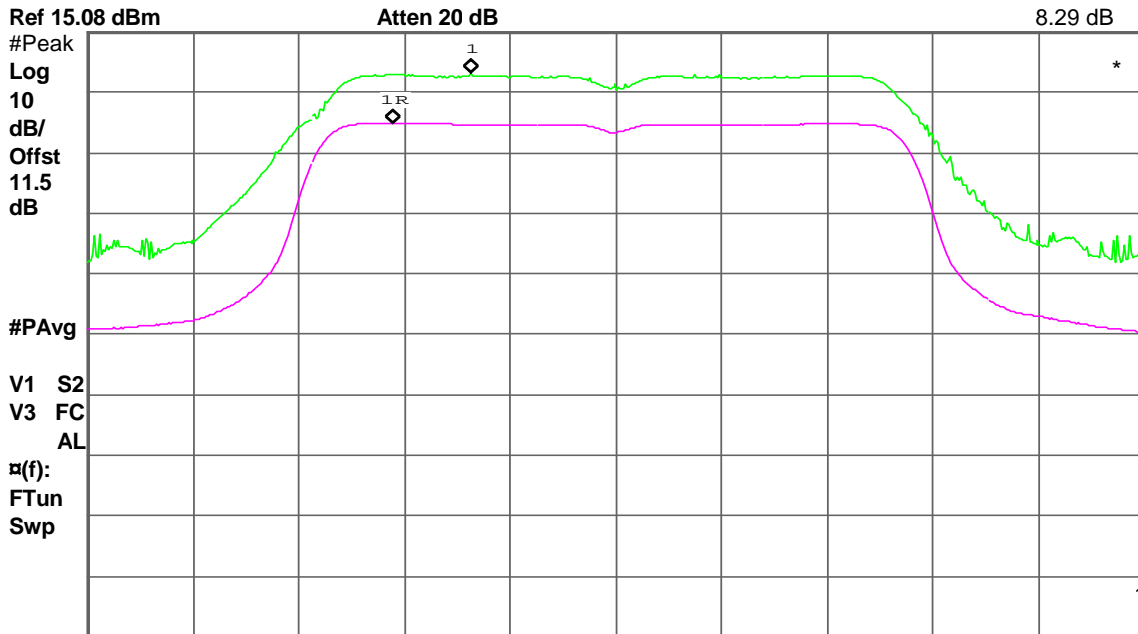

Center 5.180 00 GHz
#Res BW 1 MHz

#VBW 3 MHz

Span 30 MHz
#Sweep 6 s (601 pts)

CH Mid

Agilent

R L

Δ Mkr1 2.25 MHz
8.72 dB

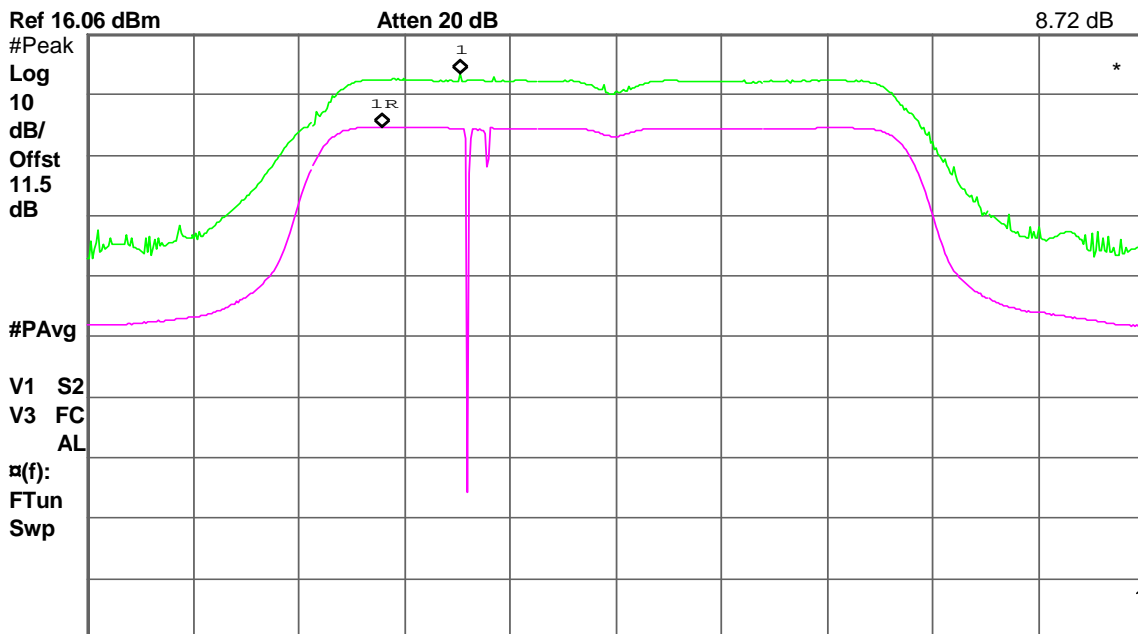

Center 5.220 00 GHz
#Res BW 1 MHz

#VBW 3 MHz

Span 30 MHz
#Sweep 6 s (601 pts)



CH High

Agilent

R L

Δ Mkr1 8.60 MHz
8.18 dB

Ref 15.95 dBm

Atten 20 dB

#Peak

Log

10

dB/

Offst

11.5

dB

#PAvg

V1 S2

V3 FC

AL

⌘(f):

FTun

Swp

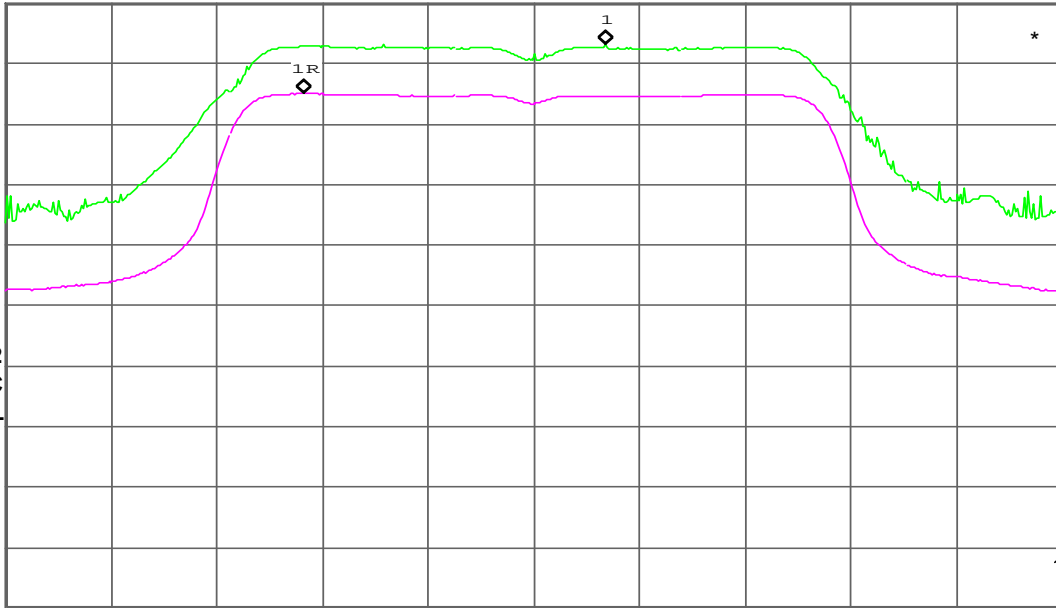

Center 5.240 00 GHz

#Res BW 1 MHz

#VBW 3 MHz

Span 30 MHz
#Sweep 6 s (601 pts)

IEEE 802.11n HT 20 MHz mode / 5180 ~ 5240MHz

CH Low

Agilent

R L

Δ Mkr1 11.90 MHz
10.43 dB

Ref 15.17 dBm

Atten 20 dB

#Peak

Log

10

dB/

Offst

11.5

dB

#PAvg

V1 S2

V3 FC

AL

⌘(f):

FTun

Swp

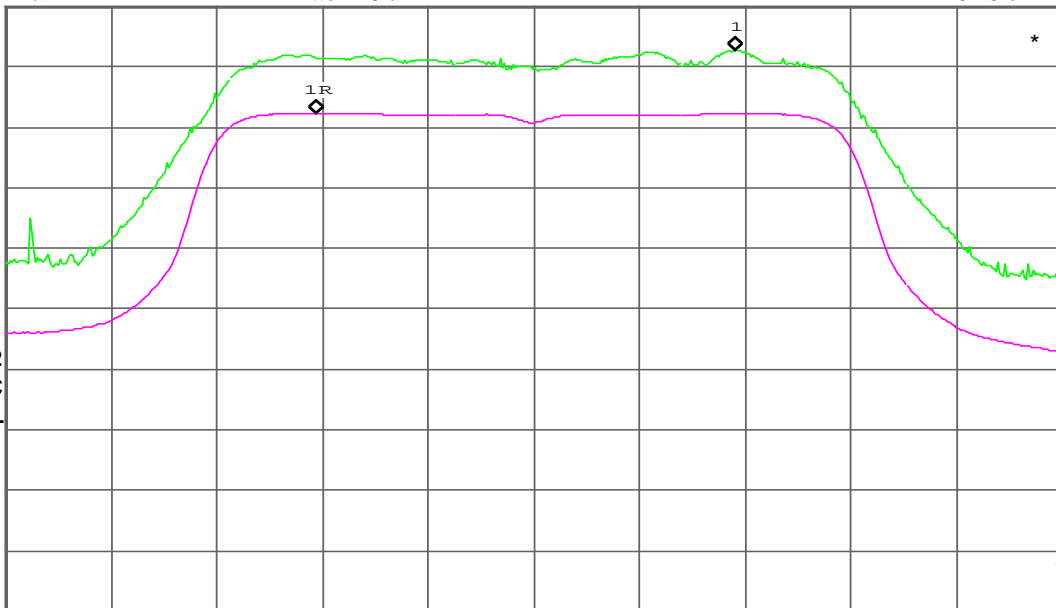

Center 5.180 00 GHz

#Res BW 1 MHz

#VBW 3 MHz

Span 30 MHz
#Sweep 6 s (601 pts)



CH Mid

Agilent

R L

Δ Mkr1 12.15 MHz
10.41 dB

Ref 15.47 dBm

Atten 20 dB

#Peak

Log

10

dB/

Offst

11.5

dB

#PAvg

V1 S2

V3 FC

AL

⌘(f):

FTun

Swp

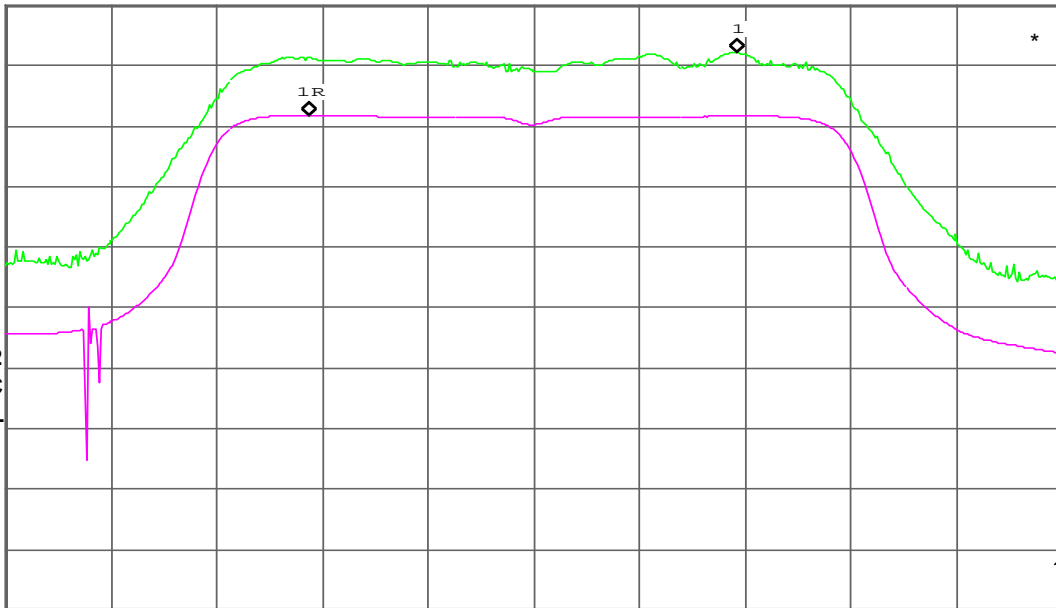

Center 5.220 00 GHz

#Res BW 1 MHz

#VBW 3 MHz

Span 30 MHz
#Sweep 6 s (601 pts)

CH High

Agilent

R L

Δ Mkr1 11.65 MHz
10.02 dB

Ref 13.29 dBm

Atten 20 dB

#Peak

Log

10

dB/

Offst

11.5

dB

#PAvg

V1 S2

V3 FC

AL

⌘(f):

FTun

Swp

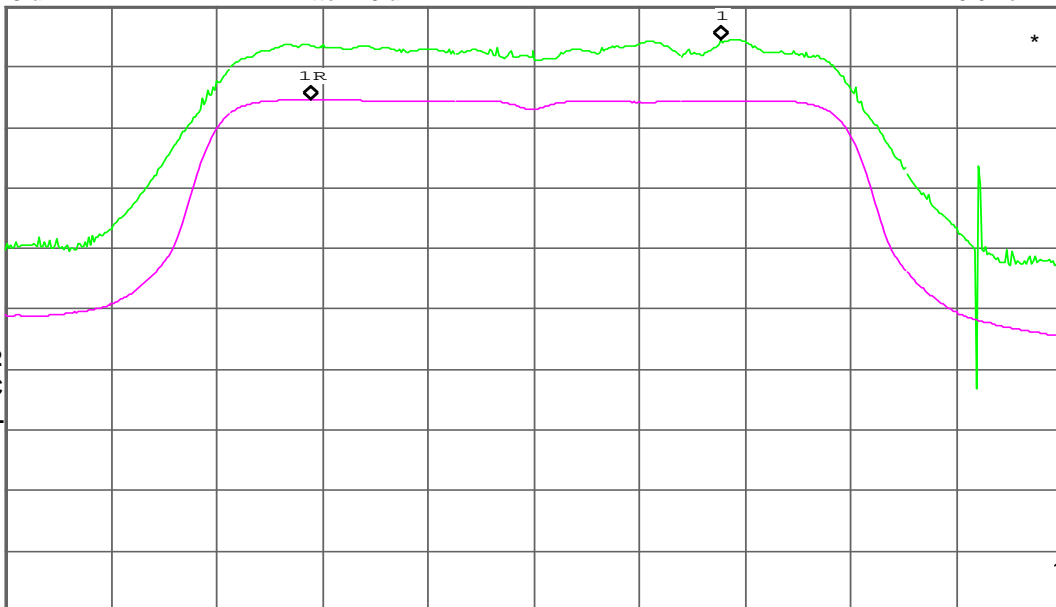

Center 5.240 00 GHz

#Res BW 1 MHz

#VBW 3 MHz

Span 30 MHz
#Sweep 6 s (601 pts)



IEEE 802.11n HT 40 MHz mode / 5190 ~ 5230MHz

CH Low

Agilent

R L

Δ Mkr1 -5.67 MHz
10.03 dB

Ref 9.482 dBm

Atten 10 dB

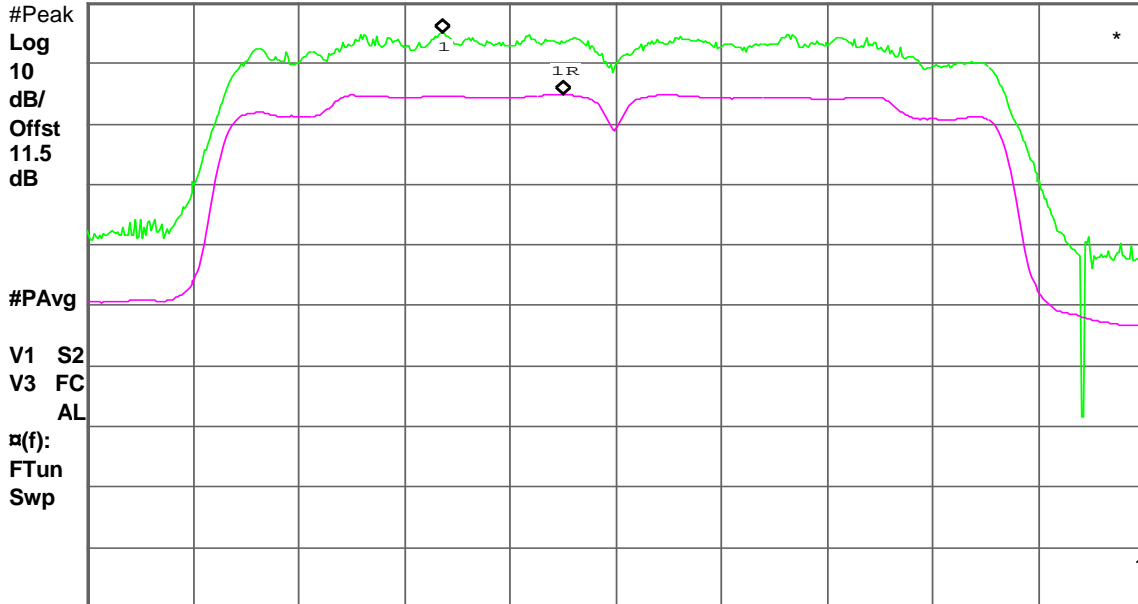

Center 5.190 00 GHz

Span 50 MHz

#Res BW 1 MHz

#VBW 3 MHz

#Sweep 6 s (601 pts)

CH High

Agilent

R L

Δ Mkr1 -5.67 MHz
10.79 dB

Ref 14.61 dBm

Atten 20 dB

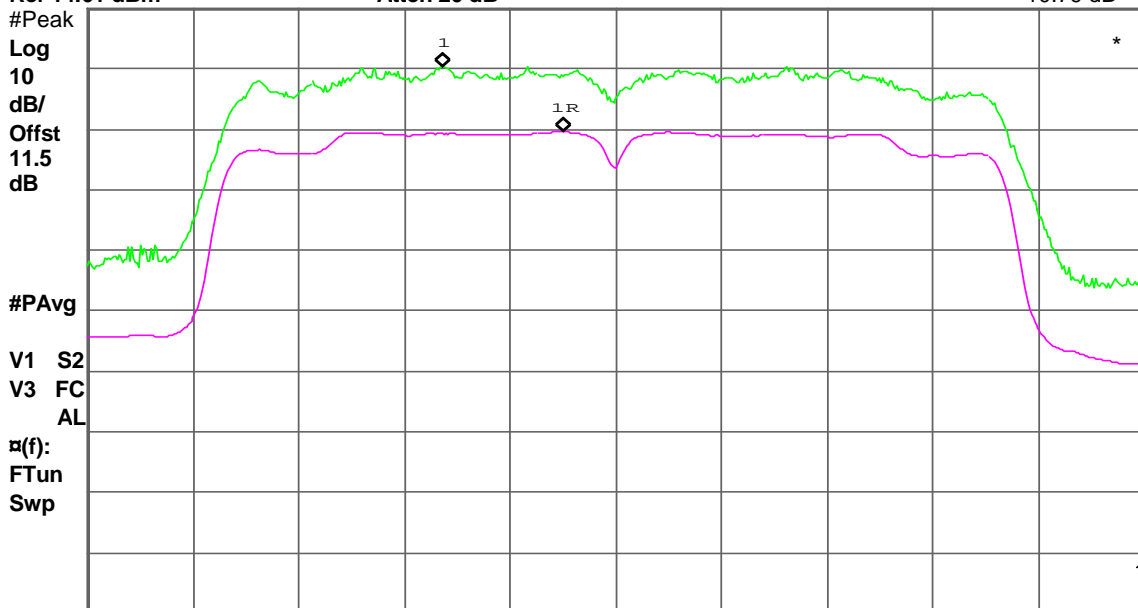

Center 5.230 00 GHz

Span 50 MHz

#Res BW 1 MHz

#VBW 3 MHz

#Sweep 6 s (601 pts)



IEEE 802.11a mode / 5260 ~ 5320MHz

CH Low

Agilent

R L

Δ Mkr1 2.30 MHz
8.65 dB

Ref 15.71 dBm

Atten 20 dB

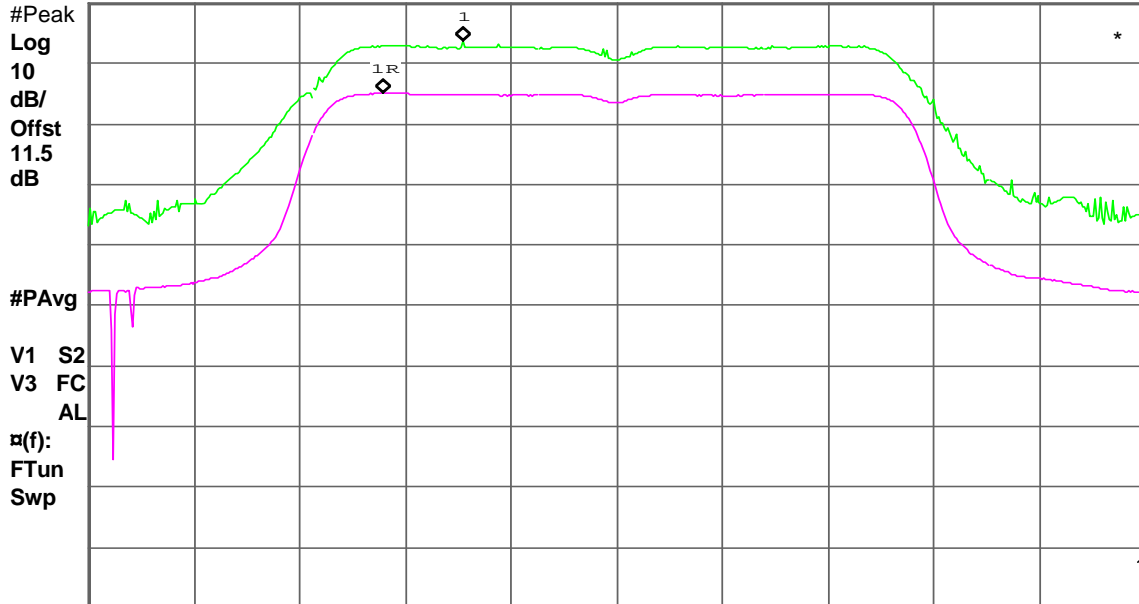

Center 5.260 00 GHz

#Res BW 1 MHz

#VBW 3 MHz

Span 30 MHz

#Sweep 6 s (601 pts)

CH Mid

Agilent

R L

Δ Mkr1 2.20 MHz
8.18 dB

Ref 15.62 dBm

Atten 20 dB

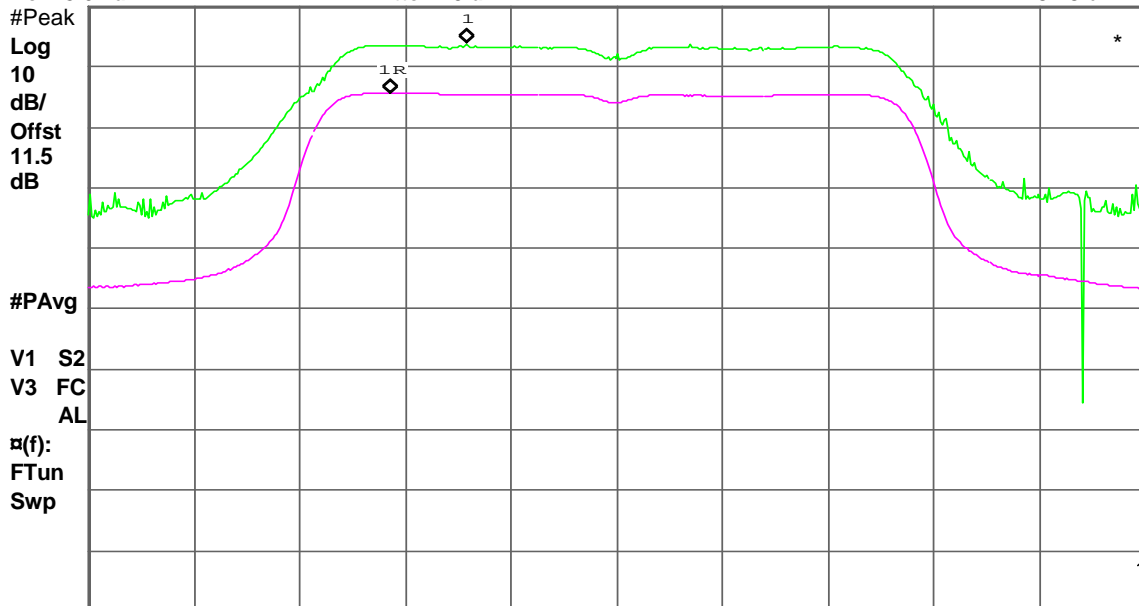

Center 5.280 00 GHz

#Res BW 1 MHz

#VBW 3 MHz

Span 30 MHz

#Sweep 6 s (601 pts)



CH High

Agilent

R L

Δ Mkr1 2.40 MHz
8.27 dB

Ref 16.12 dBm

Atten 20 dB

#Peak

Log

10

dB/

Offst

11.5

dB

#PAvg

V1 S2

V3 FC

AL

⌘(f):

FTun

Swp

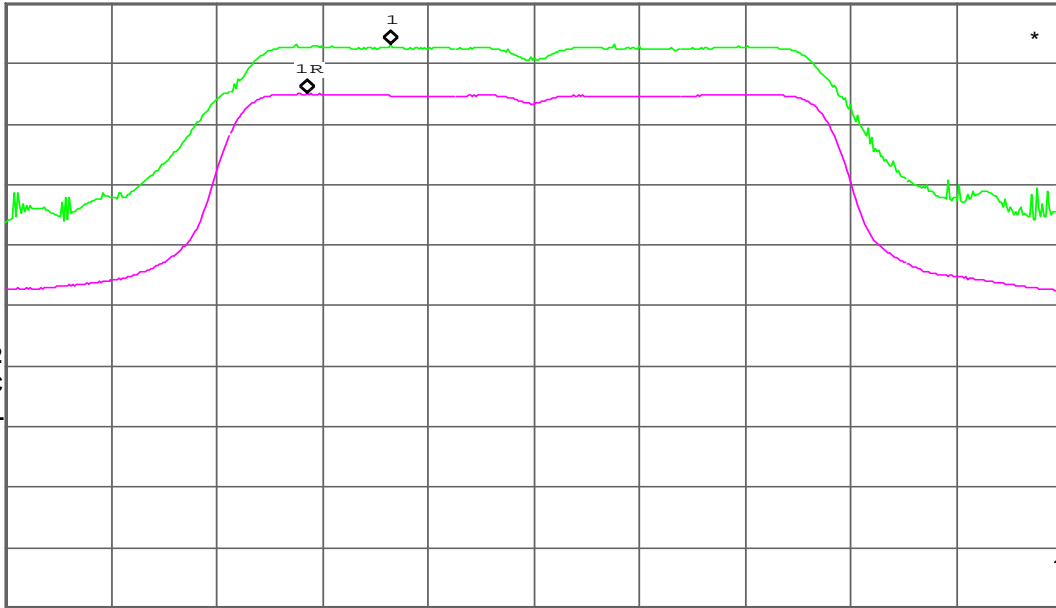

Center 5.320 00 GHz

#Res BW 1 MHz

#VBW 3 MHz

Span 30 MHz
#Sweep 6 s (601 pts)

IEEE 802.11n HT 20 MHz mode / 5260 ~ 5320MHz

CH Low

Agilent

R L

Δ Mkr1 12.05 MHz
10.45 dB

Ref 13.08 dBm

Atten 20 dB

#Peak

Log

10

dB/

Offst

11.5

dB

#PAvg

V1 S2

V3 FC

AL

⌘(f):

FTun

Swp

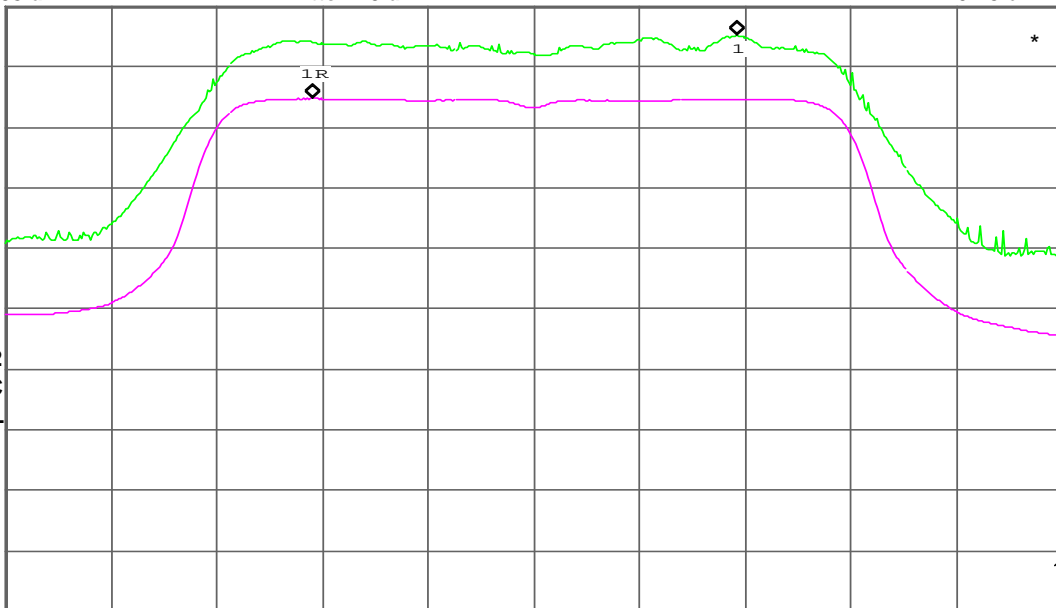

Center 5.260 00 GHz

#Res BW 1 MHz

#VBW 3 MHz

Span 30 MHz
#Sweep 6 s (601 pts)



CH Mid

Agilent

R L

Δ Mkr1 12.20 MHz
10.28 dB

Ref 13.59 dBm

Atten 20 dB

#Peak
Log
10
dB/
Offst
11.5
dB

#PAvg

V1 S2
V3 FC
AL

⌘(f):
FTun
Swp

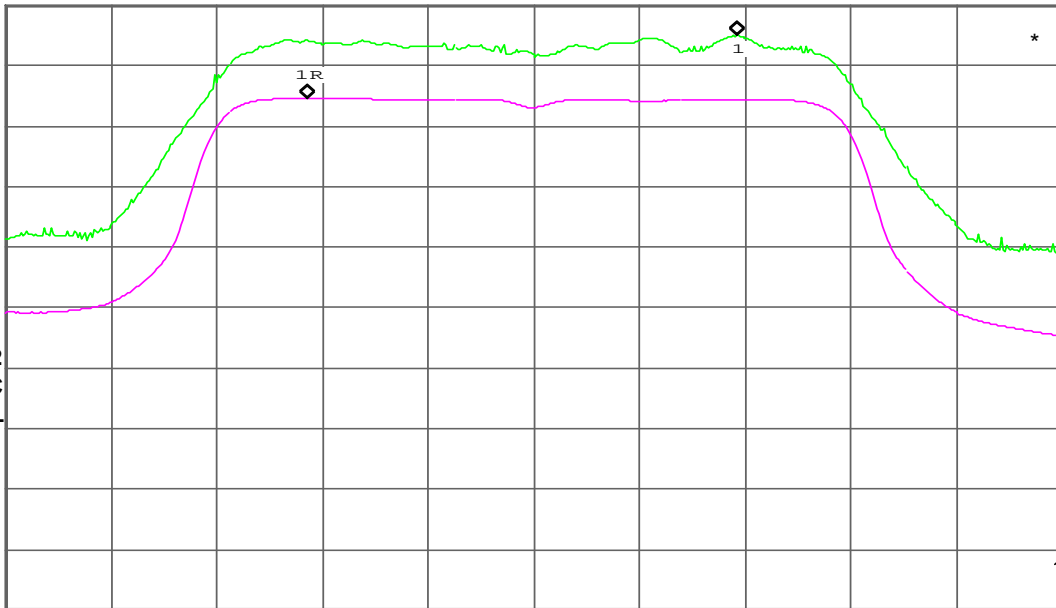

Center 5.280 00 GHz

#Res BW 1 MHz

#VBW 3 MHz

Span 30 MHz
#Sweep 6 s (601 pts)

CH High

Agilent

R L

Δ Mkr1 12.05 MHz
10.34 dB

Ref 14.68 dBm

Atten 20 dB

#Peak
Log
10
dB/
Offst
11.5
dB

#PAvg

V1 S2
V3 FC
AL

⌘(f):
FTun
Swp

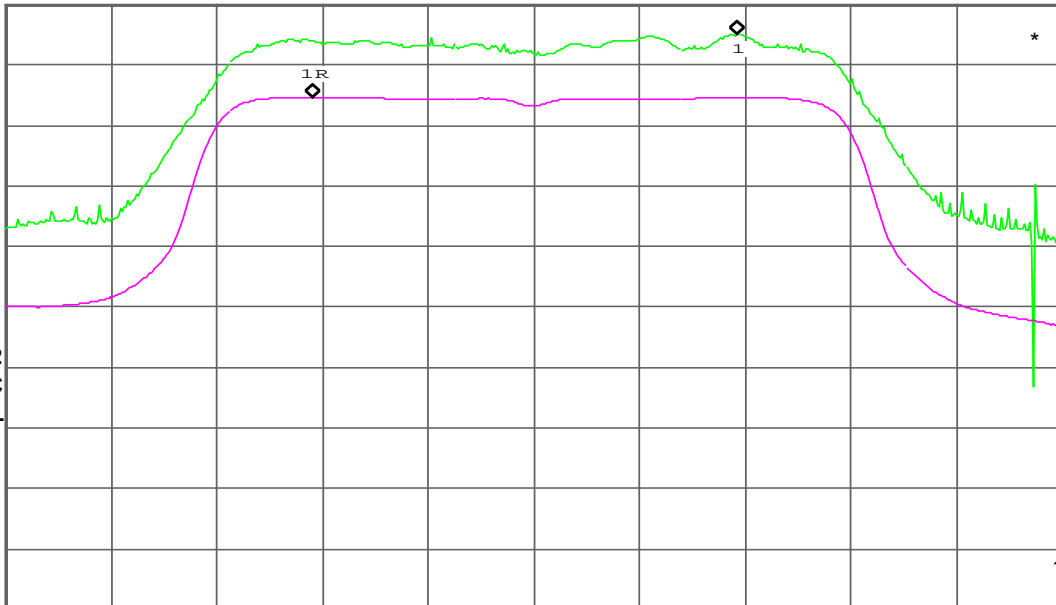

Center 5.320 00 GHz

#Res BW 1 MHz

#VBW 3 MHz

Span 30 MHz
#Sweep 6 s (601 pts)



IEEE 802.11n HT 40 MHz mode / 5270 ~ 5310MHz

CH Low

Agilent

R L

Δ Mkr1 -5.58 MHz
9.96 dB

Ref 10.55 dBm

Atten 10 dB

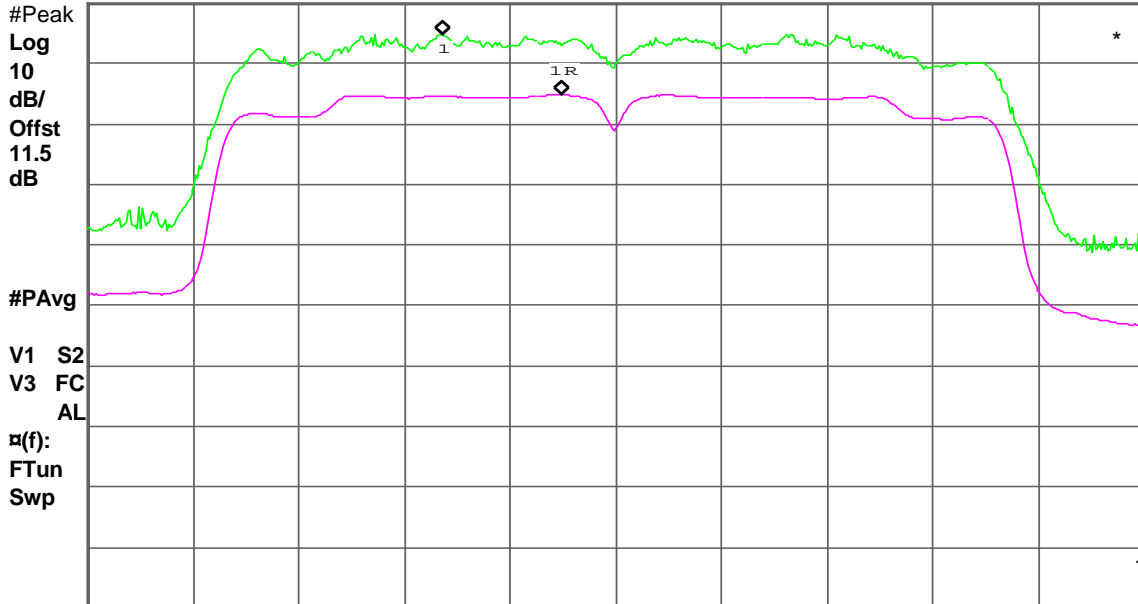

Center 5.270 00 GHz

#Res BW 1 MHz

#VBW 3 MHz

Span 50 MHz

#Sweep 6 s (601 pts)

CH High

Agilent

R L

Δ Mkr1 5.75 MHz
9.93 dB

Ref 10.54 dBm

Atten 10 dB

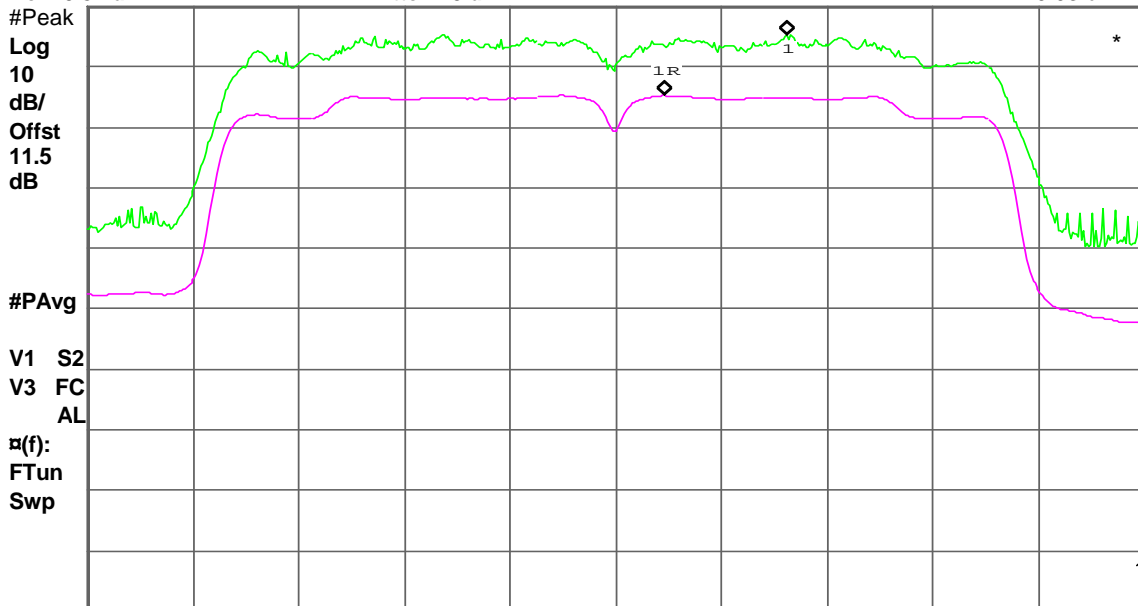

Center 5.310 00 GHz

#Res BW 1 MHz

#VBW 3 MHz

Span 50 MHz

#Sweep 6 s (601 pts)



Test mode: IEEE 802.11a mode / 5500 ~ 5700MHz

CH Low

Agilent

R L

Δ Mkr1 2.25 MHz
8.81 dB

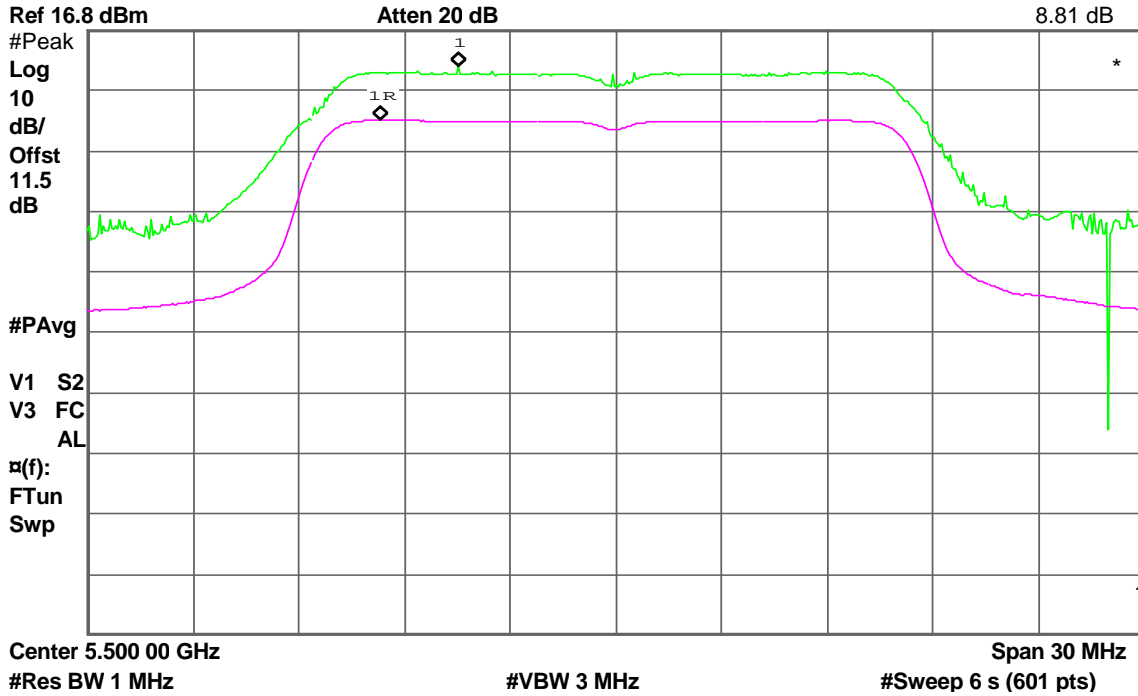

CH Mid

Agilent

R L

Δ Mkr1 1.55 MHz
8.92 dB

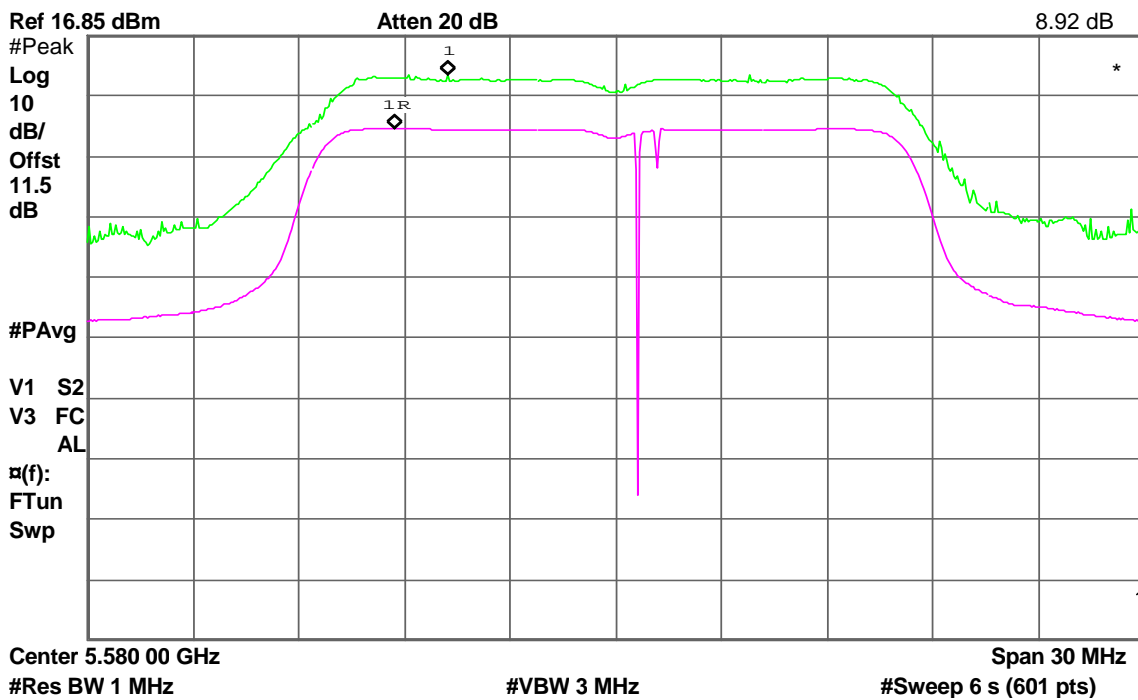



CH High

Agilent

R L

Δ Mkr1 2.25 MHz
8.83 dB

Ref 16.67 dBm

Atten 20 dB

#Peak

Log

10

dB/

Offst

11.5

dB

#PAvg

V1 S2

V3 FC

AL

⌘(f):

FTun

Swp

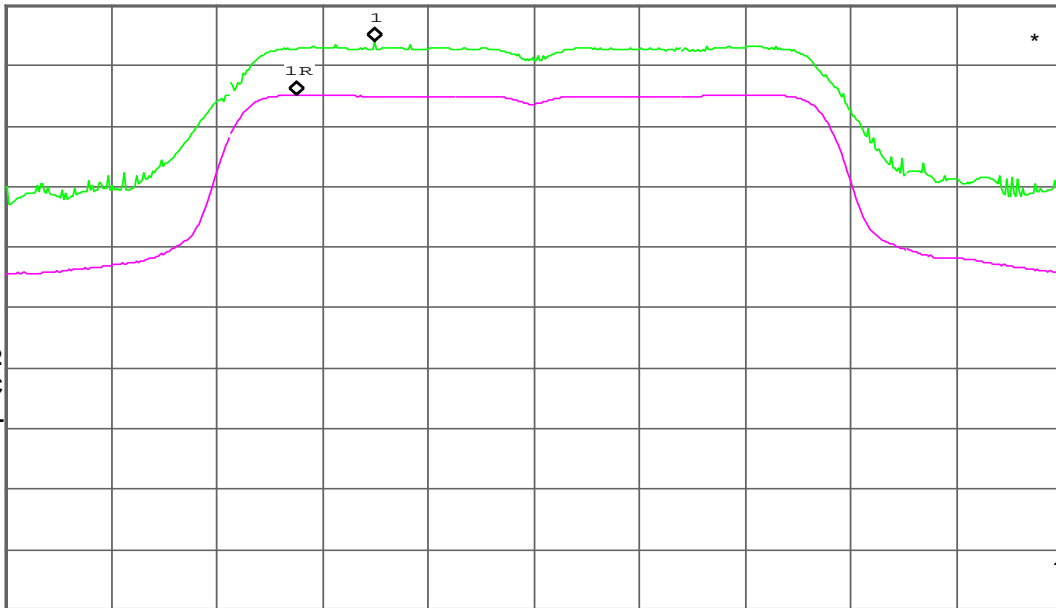

Center 5.7000 GHz

#Res BW 1 MHz

#VBW 3 MHz

Span 30 MHz

#Sweep 6 s (601 pts)

IEEE 802.11n HT 20 MHz mode / 5500 ~ 5700MHz

CH Low

Agilent

R L

Δ Mkr1 12.00 MHz
10.43 dB

Ref 14.67 dBm

Atten 20 dB

#Peak

Log

10

dB/

Offst

11.5

dB

#PAvg

V1 S2

V3 FC

AL

⌘(f):

FTun

Swp

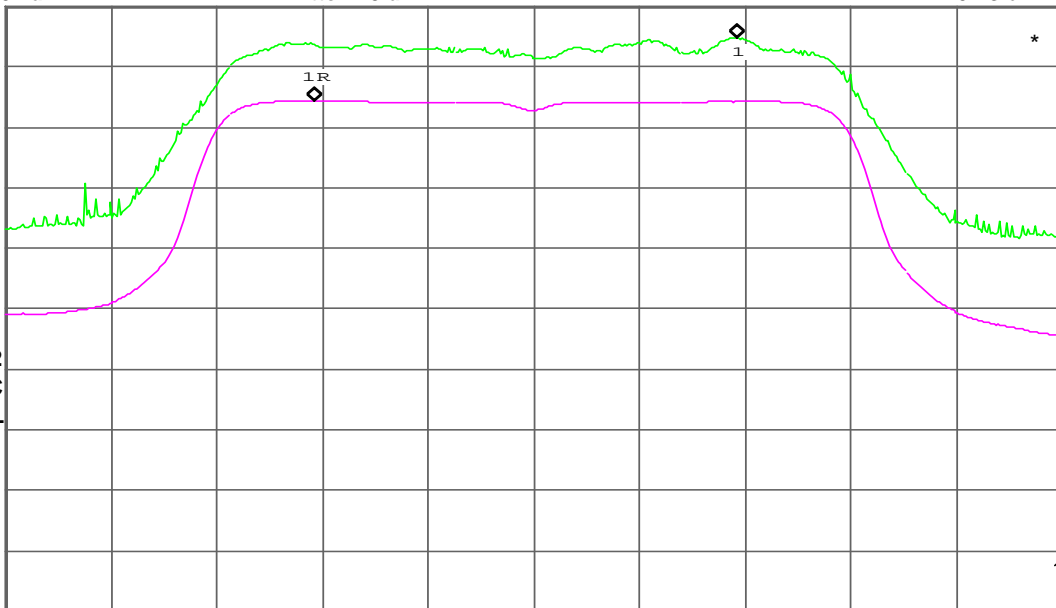

Center 5.5000 GHz

#Res BW 1 MHz

#VBW 3 MHz

Span 30 MHz

#Sweep 6 s (601 pts)



CH Mid

Agilent

R L

Δ Mkr1 12.10 MHz
10.53 dB

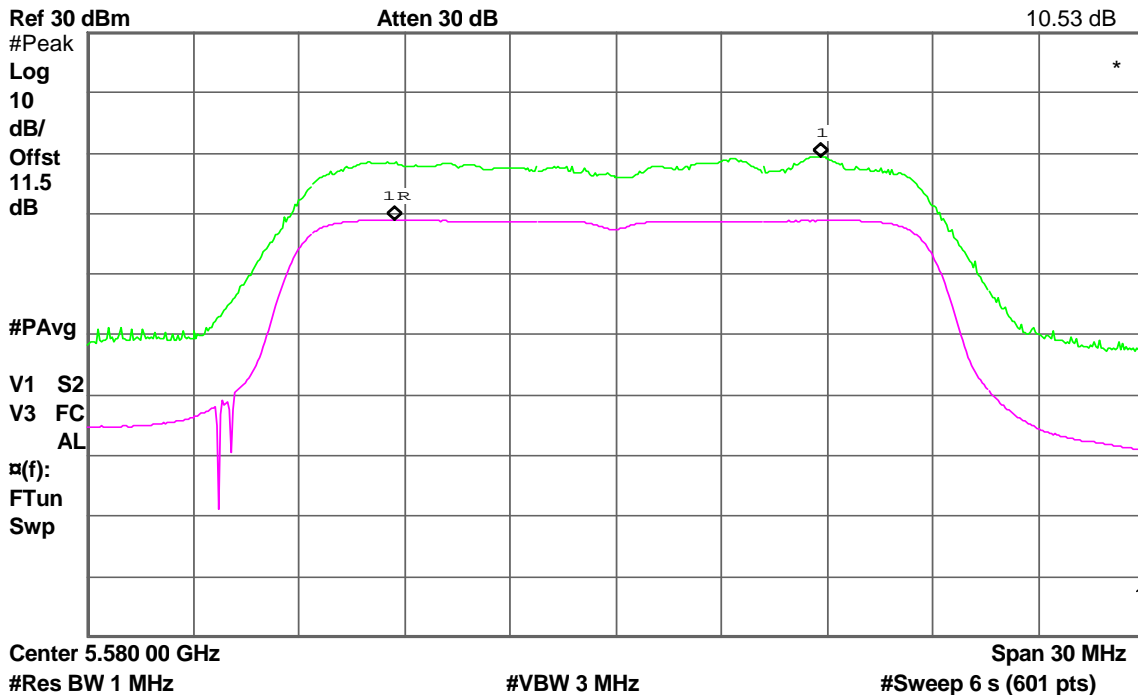

CH High

Agilent

R L

Δ Mkr1 -500 kHz
10.86 dB

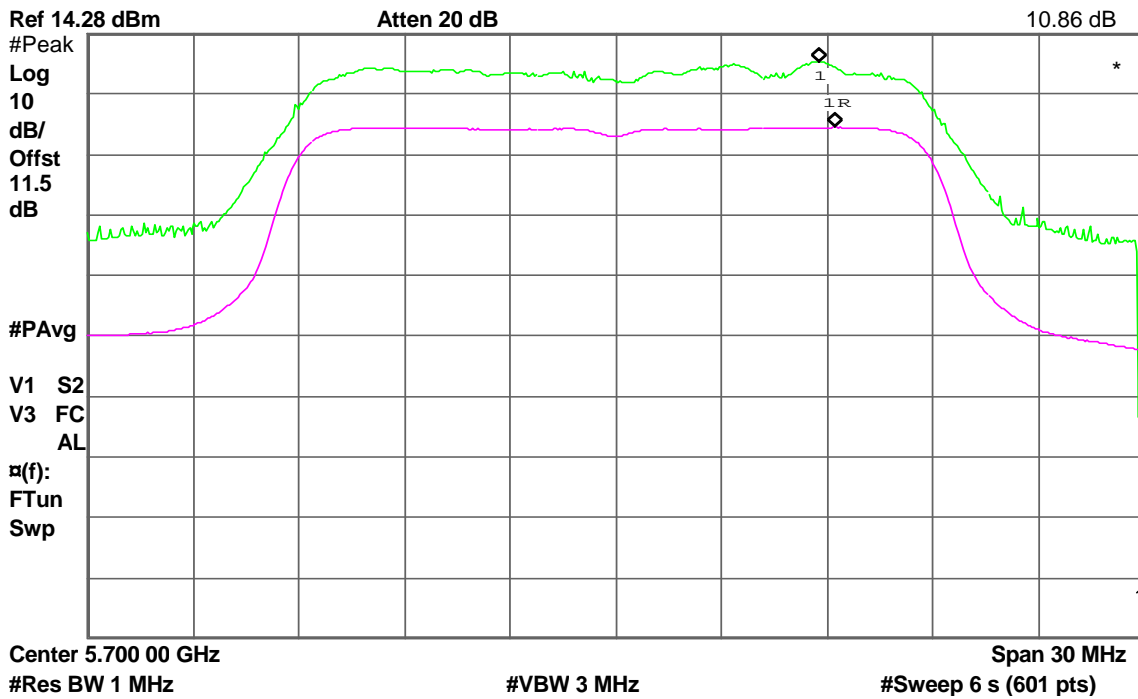



IEEE 802.11n HT 40 MHz mode / 5510 ~ 5670MHz

CH Low

Agilent

R L

Δ Mkr1 -8.83 MHz
10.29 dB

Ref 11.49 dBm

Atten 10 dB

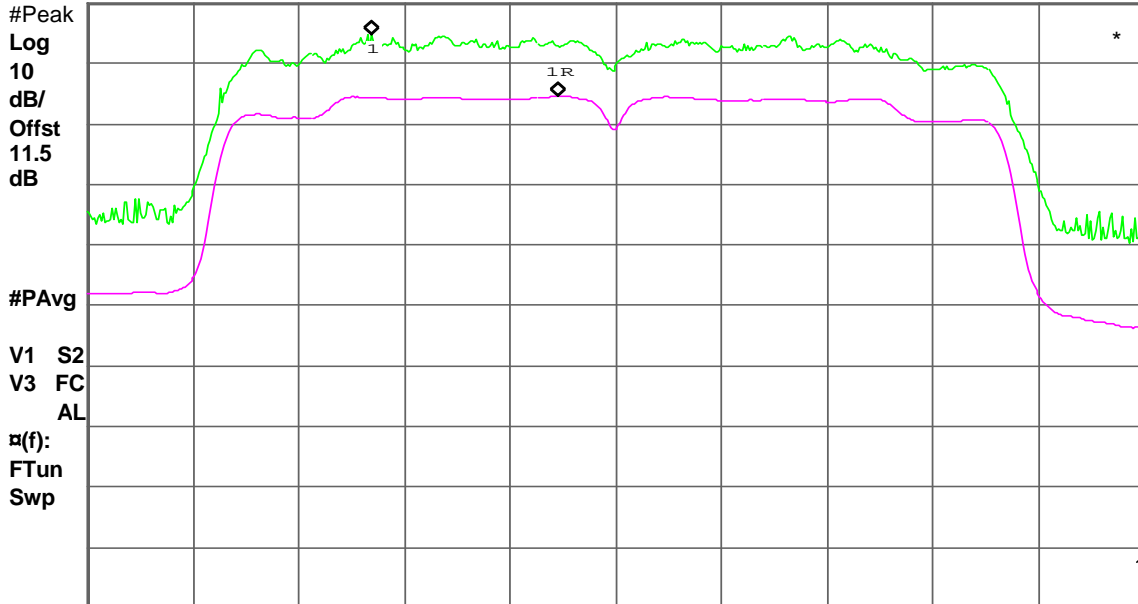

Center 5.510 00 GHz

Span 50 MHz

#Res BW 1 MHz

#VBW 3 MHz

#Sweep 6 s (601 pts)

CH Mid

Agilent

R L

Δ Mkr1 -5.42 MHz
10.48 dB

Ref 15.97 dBm

Atten 20 dB

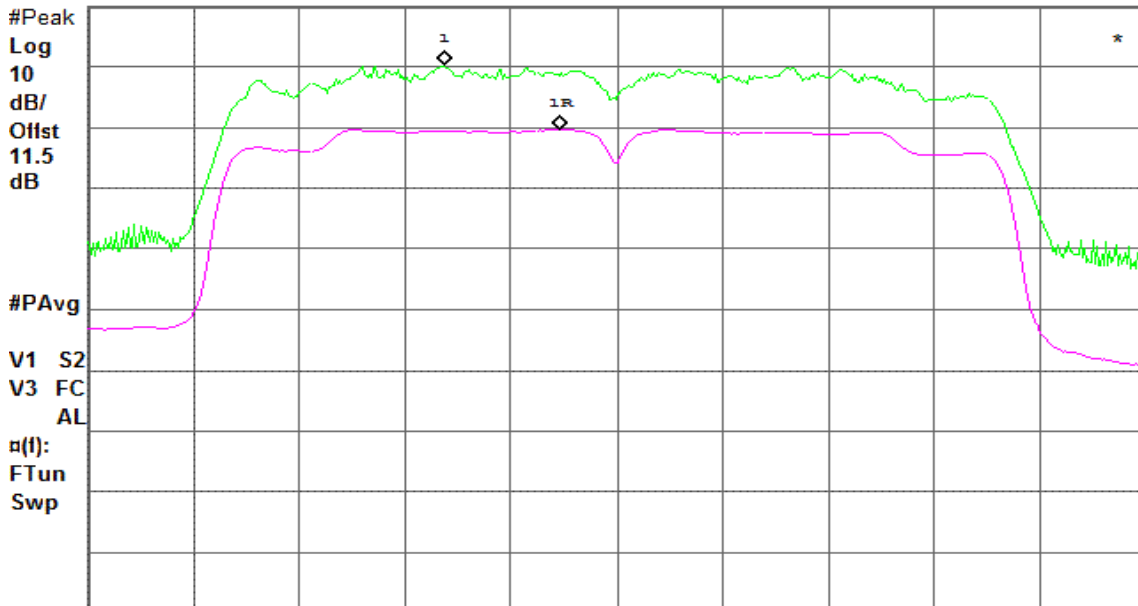

Center 5.550 00 GHz

Span 50 MHz

#Res BW 1 MHz

#VBW 3 MHz

#Sweep 6 s (601 pts)



CH High

Agilent

R L

Δ Mkr1 10.83 MHz
10.35 dB

Ref 11.3 dBm

Atten 10 dB

#Peak

Log

10

dB/

Offst

11.5

dB

#PAvg

V1 S2

V3 FC

AL

α(f):

FTun

Swp

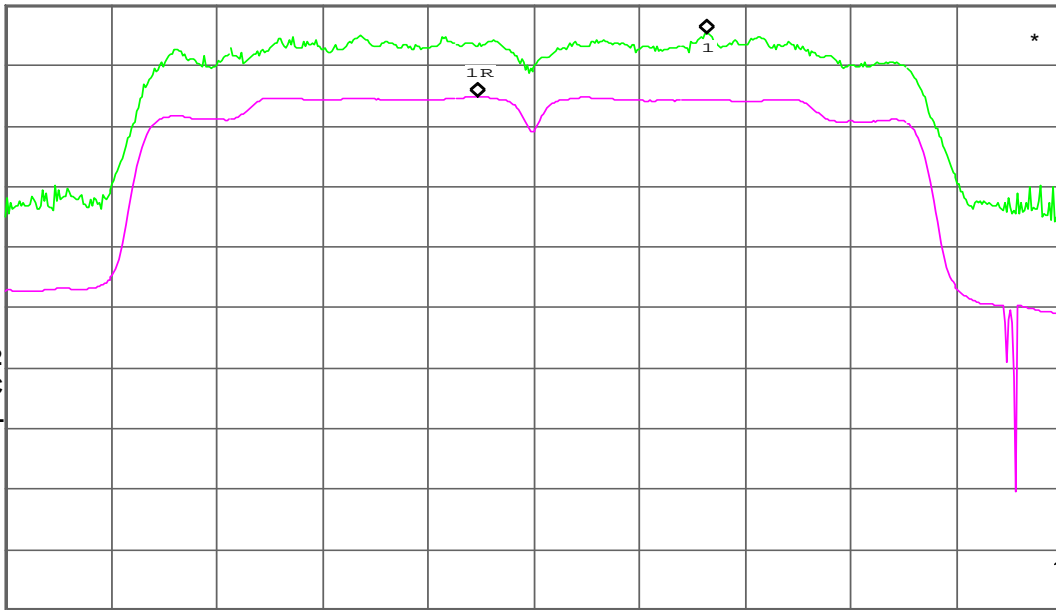

Center 5.670 00 GHz

#Res BW 1 MHz

#VBW 3 MHz

Span 50 MHz

#Sweep 6 s (601 pts)



7.6 RADIATED UNDESIRABLE EMISSION

1. According to §15.209(a), except as provided elsewhere in this Subpart, the emissions from an intentional radiator shall not exceed the field strength levels specified in the following table:

Frequency (MHz)	Field Strength ($\mu\text{V/m}$)	Measurement Distance (m)
30-88	100*	3
88-216	150*	3
216-960	200*	3
Above 960	500	3

Remark: Except as provided in paragraph (g), fundamental emissions from intentional radiators operating under this Section shall not be located in the frequency bands 54-72 MHz, 76-88 MHz, 174-216 MHz or 470-806 MHz. However, operation within these frequency bands is permitted under other sections of this Part, e.g., Sections 15.231 and 15.241.

2. In the emission table above, the tighter limit applies at the band edges.

Frequency (MHz)	Field Strength ($\mu\text{V/m}$ at 3-meter)	Field Strength (dB $\mu\text{V/m}$ at 3-meter)
30-88	100	40
88-216	150	43.5
216-960	200	46
Above 960	500	54



Test Configuration

9kHz ~ 30MHz

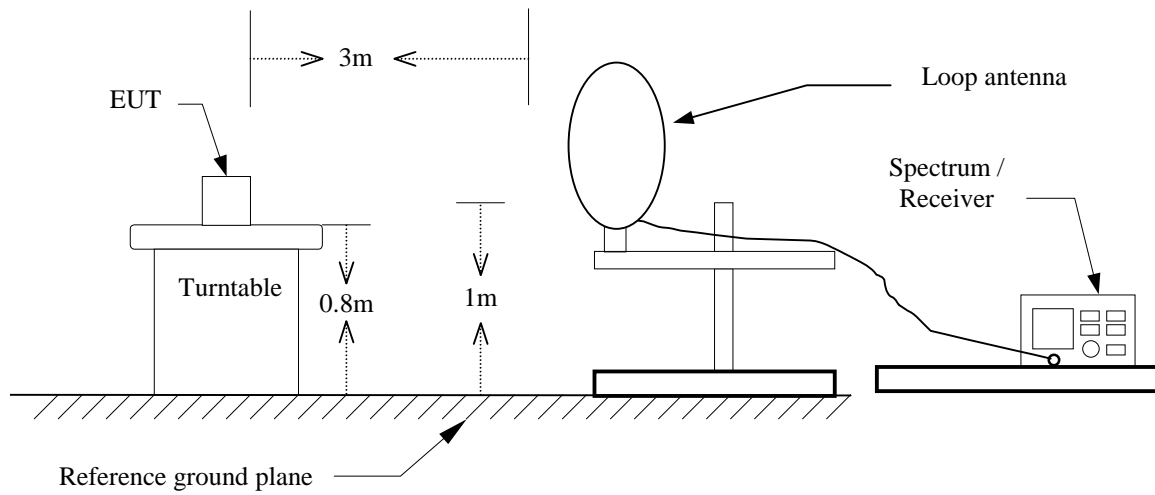

30MHz ~ 1GHz

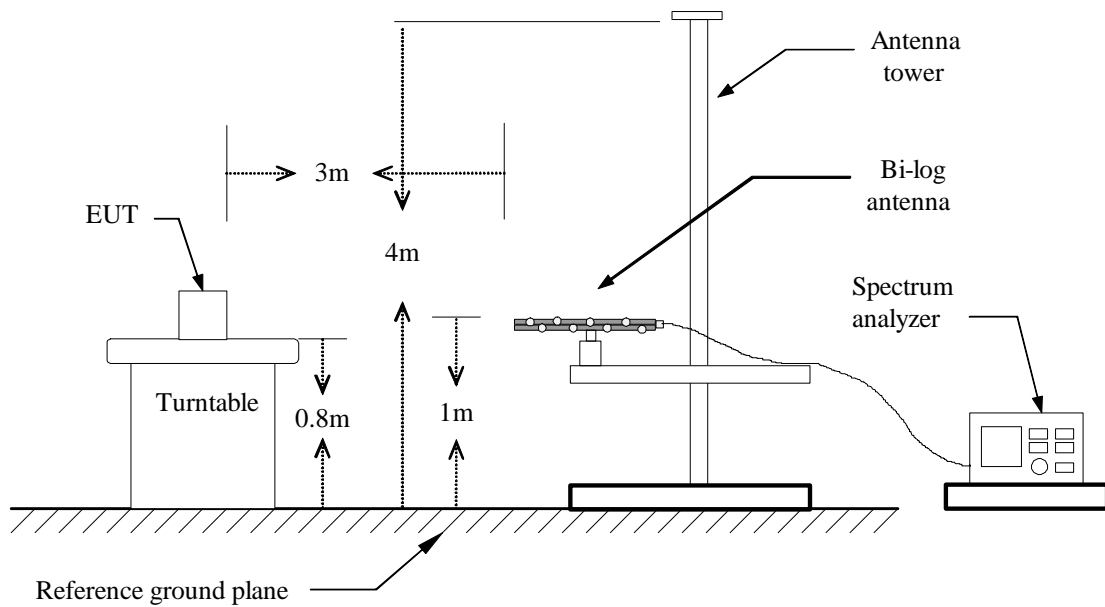



Above 1 GHz

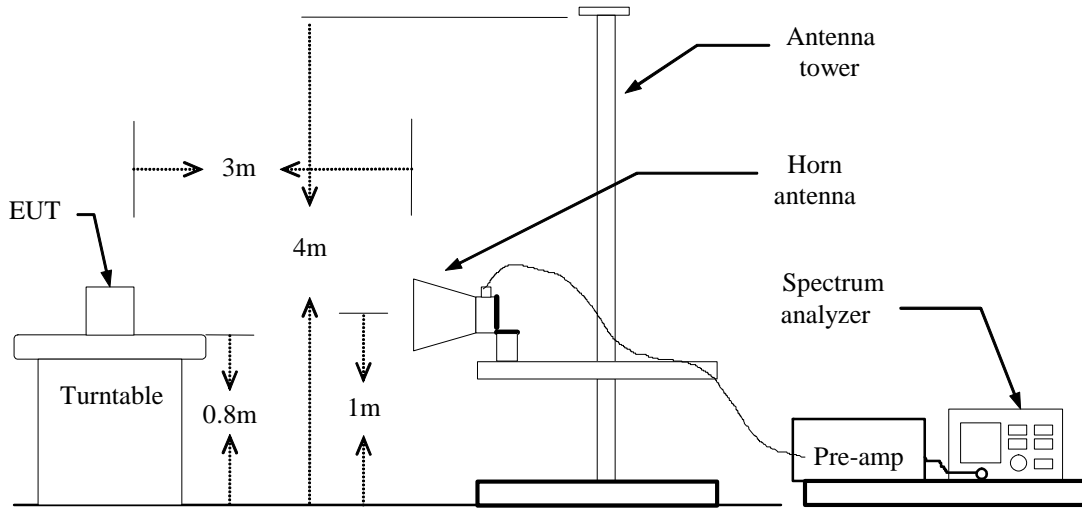



TEST PROCEDURE

1. The EUT is placed on a turntable, which is 0.8m above ground plane.
2. The turntable shall be rotated for 360 degrees to determine the position of maximum emission level.
3. EUT is set 3m away from the receiving antenna, which is varied from 1m to 4m to find out the highest emissions.
4. Maximum procedure was performed on the six highest emissions to ensure EUT compliance.
5. And also, each emission was to be maximized by changing the polarization of receiving antenna both horizontal and vertical.
6. Set the spectrum analyzer in the following setting as:

Below 1GHz:

RBW=100kHz / VBW=300kHz / Sweep=AUTO

Above 1GHz:

(a) PEAK: RBW=VBW=1MHz / Sweep=AUTO

(b) AVERAGE: RBW=1MHz / VBW=10Hz / Sweep=AUTO

7. Repeat above procedures until the measurements for all frequencies are complete.



TEST RESULTS

Below 1 GHz

Operation Mode: Normal Link **Test Date:** September 7, 2012
Temperature: 26°C **Tested by:** Shawn Wu
Humidity: 60 % RH **Polarity:** Ver. / Hor.

Frequency (MHz)	Reading (dBuV)	Correction Factor (dB/m)	Result (dBuV/m)	Limit (dBuV/m)	Margin (dB)	Remark	Ant. Pol. (H/V)
57.4833	54.77	-18.81	35.96	40.00	-4.04	peak	V
387.2833	43.81	-9.80	34.01	46.00	-11.99	peak	V
416.3833	41.27	-9.30	31.97	46.00	-14.03	peak	V
451.9500	39.90	-8.61	31.29	46.00	-14.71	peak	V
666.9667	41.41	-5.95	35.46	46.00	-10.54	peak	V
749.4167	37.27	-4.76	32.51	46.00	-13.49	peak	V
257.9500	49.80	-12.50	37.30	46.00	-8.70	peak	H
301.6000	46.76	-11.15	35.61	46.00	-10.39	peak	H
387.2833	47.00	-9.80	37.20	46.00	-8.80	peak	H
747.8000	38.07	-4.79	33.28	46.00	-12.72	peak	H
809.2333	38.38	-4.20	34.18	46.00	-11.82	peak	H
914.3167	37.28	-2.94	34.34	46.00	-11.66	peak	H

Remark:

1. Measuring frequencies from 30 MHz to the 1GHz.
2. Radiated emissions measured in frequency range from 30 MHz to 1000MHz were made with an instrument using peak/quasi-peak detector mode.
3. Quasi-peak test would be performed if the peak result were greater than the quasi-peak limit or as required by the applicant.
4. Measurements above show only up to 6 maximum emissions noted, or would be lesser, with " N/A " remark, if no specific emissions from the EUT are recorded (ie: margin > 20dB from the applicable limit) and considered that's already beyond the background noise floor.
5. Margin (dB) = Remark result (dBuV/m) – Quasi-peak limit (dBuV/m).



Above 1 GHz

Operation Mode: Tx / IEEE 802.11a mode /
5180 ~ 5240MHz / CH Low

Test Date: September 10, 2012

Temperature: 26°C

Tested by: Shawn Wu

Humidity: 60% RH

Polarity: Ver. / Hor.

Frequency (MHz)	Reading (dBuV)	Correct Factor(dB/m)	Result (dBuV/m)	Limit (dBuV/m)	Margin (dB)	Remark	Antenna Polarization (V/H)
2400.000	56.02	-6.64	49.38	68.30	-18.92	peak	V
N/A							
2785.000	55.84	-5.98	49.86	74.00	-24.14	peak	H
N/A							

Remark:

1. Measuring frequencies from 1 GHz to the 10th harmonic of highest fundamental frequency.
2. Radiated emissions measured in frequency above 1000MHz were made with an instrument using peak/average detector mode.
3. Average test would be performed if the peak result were greater than the average limit.
4. Data of measurement within this frequency range shown “ --- ” in the table above means the reading of emissions are attenuated more than 20dB below the permissible limits or the field strength is too small to be measured.
5. Measurements above show only up to 6 maximum emissions noted, or would be lesser, with “ N/A ” remark, if no specific emissions from the EUT are recorded (ie: margin>20dB from the applicable limit) and considered that's already beyond the background noise floor.
6. Margin (dB) = Remark result (dBuV/m) – Average limit (dBuV/m).



Operation Mode: Tx / IEEE 802.11a mode /
5180 ~ 5240MHz / CH Mid

Test Date: September 10, 2012

Temperature: 26°C

Tested by: Shawn Wu

Humidity: 60% RH

Polarity: Ver. / Hor.

Frequency (MHz)	Reading (dBuV)	Correct Factor(dB/m)	Result (dBuV/m)	Limit (dBuV/m)	Margin (dB)	Remark	Antenna Polarization (V/H)
2330.000	56.11	-6.87	49.24	74.00	-24.76	peak	V
N/A							
1956.667	57.44	-7.45	49.99	68.30	-18.31	peak	H
N/A							

Remark:

1. Measuring frequencies from 1 GHz to the 10th harmonic of highest fundamental frequency.
2. Radiated emissions measured in frequency above 1000MHz were made with an instrument using peak/average detector mode.
3. Average test would be performed if the peak result were greater than the average limit.
4. Data of measurement within this frequency range shown “ --- ” in the table above means the reading of emissions are attenuated more than 20dB below the permissible limits or the field strength is too small to be measured.
5. Measurements above show only up to 6 maximum emissions noted, or would be lesser, with “ N/A ” remark, if no specific emissions from the EUT are recorded (ie: margin>20dB from the applicable limit) and considered that's already beyond the background noise floor.
6. $Margin (dB) = Remark\ result (dBuV/m) - Average\ limit (dBuV/m)$.



Operation Mode: Tx / IEEE 802.11a mode /
5180 ~ 5240MHz / CH High

Test Date: September 10, 2012

Temperature: 26°C

Tested by: Shawn Wu

Humidity: 60% RH

Polarity: Ver. / Hor.

Frequency (MHz)	Reading (dBuV)	Correct Factor(dB/m)	Result (dBuV/m)	Limit (dBuV/m)	Margin (dB)	Remark	Antenna Polarization (V/H)
2120.000	56.83	-7.06	49.77	68.30	-18.53	peak	V
N/A							
2470.000	56.09	-6.67	49.42	68.30	-18.88	peak	H
N/A							

Remark:

1. Measuring frequencies from 1 GHz to the 10th harmonic of highest fundamental frequency.
2. Radiated emissions measured in frequency above 1000MHz were made with an instrument using peak/average detector mode.
3. Average test would be performed if the peak result were greater than the average limit.
4. Data of measurement within this frequency range shown " --- " in the table above means the reading of emissions are attenuated more than 20dB below the permissible limits or the field strength is too small to be measured.
5. Measurements above show only up to 6 maximum emissions noted, or would be lesser, with " N/A " remark, if no specific emissions from the EUT are recorded (ie: margin>20dB from the applicable limit) and considered that's already beyond the background noise floor.
6. Margin (dB) = Remark result (dBuV/m) – Average limit (dBuV/m).



Operation Mode: Tx / IEEE 802.11n HT 20 MHz mode / 5180 ~ 5240MHz / CH Low

Test Date: September 10, 2012

Temperature: 26°C

Tested by: Shawn Wu

Humidity: 60% RH

Polarity: Ver. / Hor.

Frequency (MHz)	Reading (dBuV)	Correct Factor(dB/m)	Result (dBuV/m)	Limit (dBuV/m)	Margin (dB)	Remark	Antenna Polarization (V/H)
2283.333	70.53	-6.98	63.55	74.00	-10.45	peak	V
2283.333	43.29	-6.98	36.31	54.00	-17.69	AVG	V
2913.333	60.91	-5.66	55.25	68.30	-13.05	peak	V
2913.333	43.13	-5.66	37.47	54.00	-16.53	AVG	V
N/A							
2271.667	68.34	-6.98	61.36	74.00	-12.64	peak	H
2271.667	43.26	-6.98	36.28	54.00	-17.72	AVG	H
2913.333	62.11	-5.66	56.45	68.30	-11.85	peak	H
2913.333	43.16	-5.66	37.50	54.00	-16.50	AVG	H
N/A							

Remark:

1. Measuring frequencies from 1 GHz to the 10th harmonic of highest fundamental frequency.
2. Radiated emissions measured in frequency above 1000MHz were made with an instrument using peak/average detector mode.
3. Average test would be performed if the peak result were greater than the average limit.
4. Data of measurement within this frequency range shown " --- " in the table above means the reading of emissions are attenuated more than 20dB below the permissible limits or the field strength is too small to be measured.
5. Measurements above show only up to 6 maximum emissions noted, or would be lesser, with " N/A " remark, if no specific emissions from the EUT are recorded (ie: margin>20dB from the applicable limit) and considered that's already beyond the background noise floor.
6. Margin (dB) = Remark result (dBuV/m) – Average limit (dBuV/m).



Operation Mode: Tx / IEEE 802.11n HT 20 MHz mode / 5180 ~ 5240MHz / CH Mid

Test Date: September 10, 2012

Temperature: 26°C

Tested by: Shawn Wu

Humidity: 60% RH

Polarity: Ver. / Hor.

Frequency (MHz)	Reading (dBuV)	Correct Factor(dB/m)	Result (dBuV/m)	Limit (dBuV/m)	Margin (dB)	Remark	Antenna Polarization (V/H)
2470.000	56.49	-6.67	49.82	68.30	-18.48	peak	V
N/A							
2878.333	56.17	-5.74	50.43	74.00	-23.57	peak	H
N/A							

Remark:

1. Measuring frequencies from 1 GHz to the 10th harmonic of highest fundamental frequency.
2. Radiated emissions measured in frequency above 1000MHz were made with an instrument using peak/average detector mode.
3. Average test would be performed if the peak result were greater than the average limit.
4. Data of measurement within this frequency range shown “ --- ” in the table above means the reading of emissions are attenuated more than 20dB below the permissible limits or the field strength is too small to be measured.
5. Measurements above show only up to 6 maximum emissions noted, or would be lesser, with “ N/A ” remark, if no specific emissions from the EUT are recorded (ie: margin>20dB from the applicable limit) and considered that's already beyond the background noise floor.
6. Margin (dB) = Remark result (dBuV/m) – Average limit (dBuV/m).



Operation Mode: Tx / IEEE 802.11n HT 20 MHz mode / 5180 ~ 5240MHz / CH High

Test Date: September 10, 2012

Temperature: 26°C

Tested by: Shawn Wu

Humidity: 60% RH

Polarity: Ver. / Hor.

Frequency (MHz)	Reading (dBuV)	Correct Factor(dB/m)	Result (dBuV/m)	Limit (dBuV/m)	Margin (dB)	Remark	Antenna Polarization (V/H)
2318.333	56.82	-6.91	49.91	74.00	-24.09	peak	V
N/A							
2621.667	55.82	-6.39	49.43	68.30	-18.87	peak	H
N/A							

Remark:

1. Measuring frequencies from 1 GHz to the 10th harmonic of highest fundamental frequency.
2. Radiated emissions measured in frequency above 1000MHz were made with an instrument using peak/average detector mode.
3. Average test would be performed if the peak result were greater than the average limit.
4. Data of measurement within this frequency range shown “ --- ” in the table above means the reading of emissions are attenuated more than 20dB below the permissible limits or the field strength is too small to be measured.
5. Measurements above show only up to 6 maximum emissions noted, or would be lesser, with “ N/A ” remark, if no specific emissions from the EUT are recorded (ie: margin>20dB from the applicable limit) and considered that's already beyond the background noise floor.
6. $Margin (dB) = Remark\ result (dBuV/m) - Average\ limit (dBuV/m)$.



Operation Mode: Tx / IEEE 802.11n HT 40 MHz mode / 5190 ~ 5230MHz / CH Low

Test Date: September 10, 2012

Temperature: 26°C

Tested by: Shawn Wu

Humidity: 60% RH

Polarity: Ver. / Hor.

Frequency (MHz)	Reading (dBuV)	Correct Factor(dB/m)	Result (dBuV/m)	Limit (dBuV/m)	Margin (dB)	Remark	Antenna Polarization (V/H)
2283.333	66.43	-6.98	59.45	74.00	-14.55	peak	V
2283.333	44.50	-6.98	37.52	54.00	-16.48	AVG	V
N/A							
2271.667	65.90	-6.98	58.92	74.00	-15.08	peak	H
2271.667	44.24	-6.98	37.26	54.00	-16.74	AVG	H
2925.000	60.31	-5.63	54.68	68.30	-13.62	peak	H
2925.000	44.11	-5.63	38.48	54.00	-15.52	AVG	H
N/A							

Remark:

1. Measuring frequencies from 1 GHz to the 10th harmonic of highest fundamental frequency.
2. Radiated emissions measured in frequency above 1000MHz were made with an instrument using peak/average detector mode.
3. Average test would be performed if the peak result were greater than the average limit.
4. Data of measurement within this frequency range shown “ --- ” in the table above means the reading of emissions are attenuated more than 20dB below the permissible limits or the field strength is too small to be measured.
5. Measurements above show only up to 6 maximum emissions noted, or would be lesser, with “ N/A ” remark, if no specific emissions from the EUT are recorded (ie: margin>20dB from the applicable limit) and considered that's already beyond the background noise floor.
6. $Margin (dB) = Remark\ result (dBuV/m) - Average\ limit (dBuV/m)$.



Operation Mode: Tx / IEEE 802.11n HT 40 MHz mode / 5190 ~ 5230MHz / CH High

Test Date: September 10, 2012

Temperature: 26°C

Tested by: Shawn Wu

Humidity: 60% RH

Polarity: Ver. / Hor.

Frequency (MHz)	Reading (dBuV)	Correct Factor(dB/m)	Result (dBuV/m)	Limit (dBuV/m)	Margin (dB)	Remark	Antenna Polarization (V/H)
2901.667	56.14	-5.69	50.45	68.30	-17.85	peak	V
N/A							
2843.333	56.18	-5.83	50.35	74.00	-23.65	peak	H
N/A							

Remark:

1. Measuring frequencies from 1 GHz to the 10th harmonic of highest fundamental frequency.
2. Radiated emissions measured in frequency above 1000MHz were made with an instrument using peak/average detector mode.
3. Average test would be performed if the peak result were greater than the average limit.
4. Data of measurement within this frequency range shown “ --- ” in the table above means the reading of emissions are attenuated more than 20dB below the permissible limits or the field strength is too small to be measured.
5. Measurements above show only up to 6 maximum emissions noted, or would be lesser, with “ N/A ” remark, if no specific emissions from the EUT are recorded (ie: margin>20dB from the applicable limit) and considered that's already beyond the background noise floor.
6. $Margin (dB) = Remark\ result (dBuV/m) - Average\ limit (dBuV/m)$.



Operation Mode: Tx / IEEE 802.11a mode / 5260 ~ 5320MHz / CH Low

Test Date: September 10, 2012

Temperature: 26°C

Tested by: Shawn Wu

Humidity: 60% RH

Polarity: Ver. / Hor.

Frequency (MHz)	Reading (dBuV)	Correct Factor(dB/m)	Result (dBuV/m)	Limit (dBuV/m)	Margin (dB)	Remark	Antenna Polarization (V/H)
2785.000	56.11	-5.98	50.13	74.00	-23.87	peak	V
N/A							
2785.000	56.21	-5.98	50.23	74.00	-23.77	peak	H
N/A							

Remark:

1. Measuring frequencies from 1 GHz to the 10th harmonic of highest fundamental frequency.
2. Radiated emissions measured in frequency above 1000MHz were made with an instrument using peak/average detector mode.
3. Average test would be performed if the peak result were greater than the average limit.
4. Data of measurement within this frequency range shown “ --- ” in the table above means the reading of emissions are attenuated more than 20dB below the permissible limits or the field strength is too small to be measured.
5. Measurements above show only up to 6 maximum emissions noted, or would be lesser, with “ N/A ” remark, if no specific emissions from the EUT are recorded (ie: margin>20dB from the applicable limit) and considered that's already beyond the background noise floor.
6. $Margin (dB) = Remark\ result (dBuV/m) - Average\ limit (dBuV/m)$.



Operation Mode: Tx / IEEE 802.11a mode / 5260 ~ 5320MHz / CH Mid

Test Date: September 10, 2012

Temperature: 26°C

Tested by: Shawn Wu

Humidity: 60% RH

Polarity: Ver. / Hor.

Frequency (MHz)	Reading (dBuV)	Correct Factor(dB/m)	Result (dBuV/m)	Limit (dBuV/m)	Margin (dB)	Remark	Antenna Polarization (V/H)
2691.667	55.23	-6.21	49.02	74.00	-24.98	peak	V
N/A							
2283.333	56.34	-6.98	49.36	74.00	-24.64	peak	H
N/A							

Remark:

1. Measuring frequencies from 1 GHz to the 10th harmonic of highest fundamental frequency.
2. Radiated emissions measured in frequency above 1000MHz were made with an instrument using peak/average detector mode.
3. Average test would be performed if the peak result were greater than the average limit.
4. Data of measurement within this frequency range shown “ --- ” in the table above means the reading of emissions are attenuated more than 20dB below the permissible limits or the field strength is too small to be measured.
5. Measurements above show only up to 6 maximum emissions noted, or would be lesser, with “ N/A ” remark, if no specific emissions from the EUT are recorded (ie: margin>20dB from the applicable limit) and considered that's already beyond the background noise floor.
6. $Margin (dB) = Remark\ result (dBuV/m) - Average\ limit (dBuV/m)$.



Operation Mode: Tx / IEEE 802.11a mode / 5260 ~ 5320MHz / CH High

Test Date: September 10, 2012

Temperature: 26°C

Tested by: Shawn Wu

Humidity: 60% RH

Polarity: Ver. / Hor.

Frequency (MHz)	Reading (dBuV)	Correct Factor(dB/m)	Result (dBuV/m)	Limit (dBuV/m)	Margin (dB)	Remark	Antenna Polarization (V/H)
2656.667	55.88	-6.30	49.58	74.00	-24.42	peak	V
N/A							
2913.333	55.75	-5.66	50.09	68.30	-18.21	peak	H
N/A							

Remark:

1. Measuring frequencies from 1 GHz to the 10th harmonic of highest fundamental frequency.
2. Radiated emissions measured in frequency above 1000MHz were made with an instrument using peak/average detector mode.
3. Average test would be performed if the peak result were greater than the average limit.
4. Data of measurement within this frequency range shown “ --- ” in the table above means the reading of emissions are attenuated more than 20dB below the permissible limits or the field strength is too small to be measured.
5. Measurements above show only up to 6 maximum emissions noted, or would be lesser, with “ N/A ” remark, if no specific emissions from the EUT are recorded (ie: margin>20dB from the applicable limit) and considered that's already beyond the background noise floor.
6. Margin (dB) = Remark result (dBuV/m) – Average limit (dBuV/m).



Operation Mode: Tx / IEEE 802.11n HT 20 MHz mode / 5260 ~ 5320MHz / CH Low

Test Date: September 10, 2012

Temperature: 26°C

Tested by: Shawn Wu

Humidity: 60% RH

Polarity: Ver. / Hor.

Frequency (MHz)	Reading (dBuV)	Correct Factor(dB/m)	Result (dBuV/m)	Limit (dBuV/m)	Margin (dB)	Remark	Antenna Polarization (V/H)
2831.667	55.44	-5.86	49.58	74.00	-24.42	peak	V
N/A							
2831.667	55.81	-5.86	49.95	74.00	-24.05	peak	H
N/A							

Remark:

1. Measuring frequencies from 1 GHz to the 10th harmonic of highest fundamental frequency.
2. Radiated emissions measured in frequency above 1000MHz were made with an instrument using peak/average detector mode.
3. Average test would be performed if the peak result were greater than the average limit.
4. Data of measurement within this frequency range shown “ --- ” in the table above means the reading of emissions are attenuated more than 20dB below the permissible limits or the field strength is too small to be measured.
5. Measurements above show only up to 6 maximum emissions noted, or would be lesser, with “ N/A ” remark, if no specific emissions from the EUT are recorded (ie: margin>20dB from the applicable limit) and considered that's already beyond the background noise floor.
6. $Margin (dB) = Remark\ result (dBuV/m) - Average\ limit (dBuV/m)$.



Operation Mode: Tx / IEEE 802.11n HT 20 MHz mode / 5260 ~ 5320MHz / CH Mid

Test Date: September 10, 2012

Temperature: 26°C

Tested by: Shawn Wu

Humidity: 60% RH

Polarity: Ver. / Hor.

Frequency (MHz)	Reading (dBuV)	Correct Factor(dB/m)	Result (dBuV/m)	Limit (dBuV/m)	Margin (dB)	Remark	Antenna Polarization (V/H)
2808.333	56.05	-5.92	50.13	74.00	-23.87	peak	V
N/A							
2563.333	55.89	-6.53	49.36	68.30	-18.94	peak	H
N/A							

Remark:

1. Measuring frequencies from 1 GHz to the 10th harmonic of highest fundamental frequency.
2. Radiated emissions measured in frequency above 1000MHz were made with an instrument using peak/average detector mode.
3. Average test would be performed if the peak result were greater than the average limit.
4. Data of measurement within this frequency range shown “ --- ” in the table above means the reading of emissions are attenuated more than 20dB below the permissible limits or the field strength is too small to be measured.
5. Measurements above show only up to 6 maximum emissions noted, or would be lesser, with “ N/A ” remark, if no specific emissions from the EUT are recorded (ie: margin>20dB from the applicable limit) and considered that's already beyond the background noise floor.
6. $Margin (dB) = Remark\ result (dBuV/m) - Average\ limit (dBuV/m)$.



Operation Mode: Tx / IEEE 802.11n HT 20 MHz mode / 5260 ~ 5320MHz / CH High

Test Date: September 10, 2012

Temperature: 26°C

Tested by: Shawn Wu

Humidity: 60% RH

Polarity: Ver. / Hor.

Frequency (MHz)	Reading (dBuV)	Correct Factor(dB/m)	Result (dBuV/m)	Limit (dBuV/m)	Margin (dB)	Remark	Antenna Polarization (V/H)
2680.000	55.93	-6.24	49.69	74.00	-24.31	peak	V
N/A							
2668.333	56.42	-6.27	50.15	74.00	-23.85	peak	H
N/A							

Remark:

1. Measuring frequencies from 1 GHz to the 10th harmonic of highest fundamental frequency.
2. Radiated emissions measured in frequency above 1000MHz were made with an instrument using peak/average detector mode.
3. Average test would be performed if the peak result were greater than the average limit.
4. Data of measurement within this frequency range shown “ --- ” in the table above means the reading of emissions are attenuated more than 20dB below the permissible limits or the field strength is too small to be measured.
5. Measurements above show only up to 6 maximum emissions noted, or would be lesser, with “ N/A ” remark, if no specific emissions from the EUT are recorded (ie: margin>20dB from the applicable limit) and considered that's already beyond the background noise floor.
6. Margin (dB) = Remark result (dBuV/m) – Average limit (dBuV/m).



Operation Mode: Tx / IEEE 802.11n HT 40 MHz mode / 5270 ~ 5310MHz / CH Low

Test Date: September 10, 2012

Temperature: 26°C

Tested by: Shawn Wu

Humidity: 60% RH

Polarity: Ver. / Hor.

Frequency (MHz)	Reading (dBuV)	Correct Factor(dB/m)	Result (dBuV/m)	Limit (dBuV/m)	Margin (dB)	Remark	Antenna Polarization (V/H)
2668.333	55.87	-6.27	49.60	74.00	-24.40	peak	V
N/A							
2773.333	56.19	-6.01	50.18	74.00	-23.82	peak	H
N/A							

Remark:

1. Measuring frequencies from 1 GHz to the 10th harmonic of highest fundamental frequency.
2. Radiated emissions measured in frequency above 1000MHz were made with an instrument using peak/average detector mode.
3. Average test would be performed if the peak result were greater than the average limit.
4. Data of measurement within this frequency range shown “ --- ” in the table above means the reading of emissions are attenuated more than 20dB below the permissible limits or the field strength is too small to be measured.
5. Measurements above show only up to 6 maximum emissions noted, or would be lesser, with “ N/A ” remark, if no specific emissions from the EUT are recorded (ie: margin>20dB from the applicable limit) and considered that's already beyond the background noise floor.
6. $Margin (dB) = Remark\ result (dBuV/m) - Average\ limit (dBuV/m)$.



Operation Mode: Tx / IEEE 802.11n HT 40 MHz mode / 5270 ~ 5310MHz / CH High

Test Date: September 10, 2012

Temperature: 26°C

Tested by: Shawn Wu

Humidity: 60% RH

Polarity: Ver. / Hor.

Frequency (MHz)	Reading (dBuV)	Correct Factor(dB/m)	Result (dBuV/m)	Limit (dBuV/m)	Margin (dB)	Remark	Antenna Polarization (V/H)
1968.333	57.99	-7.36	50.63	68.30	-17.67	peak	V
N/A							
2563.333	55.55	-6.53	49.02	68.30	-19.28	peak	H
N/A							

Remark:

1. Measuring frequencies from 1 GHz to the 10th harmonic of highest fundamental frequency.
2. Radiated emissions measured in frequency above 1000MHz were made with an instrument using peak/average detector mode.
3. Average test would be performed if the peak result were greater than the average limit.
4. Data of measurement within this frequency range shown “ --- ” in the table above means the reading of emissions are attenuated more than 20dB below the permissible limits or the field strength is too small to be measured.
5. Measurements above show only up to 6 maximum emissions noted, or would be lesser, with “ N/A ” remark, if no specific emissions from the EUT are recorded (ie: margin>20dB from the applicable limit) and considered that's already beyond the background noise floor.
6. Margin (dB) = Remark result (dBuV/m) – Average limit (dBuV/m).



Operation Mode: Tx / IEEE 802.11a mode /
5500 ~ 5700MHz / CH Low

Test Date: September 10,
2012

Temperature: 26°C

Tested by: Shawn Wu

Humidity: 60% RH

Polarity: Ver. / Hor.

Frequency (MHz)	Reading (dBuV)	Correct Factor(dB/m)	Result (dBuV/m)	Limit (dBuV/m)	Margin (dB)	Remark	Antenna Polarization (V/H)
2446.667	55.99	-6.66	49.33	68.30	-18.97	peak	V
N/A							
2435.000	56.24	-6.66	49.58	68.30	-18.72	peak	H
N/A							

Remark:

1. Measuring frequencies from 1 GHz to the 10th harmonic of highest fundamental frequency.
2. Radiated emissions measured in frequency above 1000MHz were made with an instrument using peak/average detector mode.
3. Average test would be performed if the peak result were greater than the average limit or as required by the applicant.
4. Data of measurement within this frequency range shown " --- " in the table above means the reading of emissions are attenuated more than 20dB below the permissible limits or the field strength is too small to be measured.
5. Measurements above show only up to 6 maximum emissions noted, or would be lesser, with " N/A " remark, if no specific emissions from the EUT are recorded (ie: margin>20dB from the applicable limit) and considered that's already beyond the background noise floor.
6. Margin (dB) = Remark result (dBuV/m) – Average limit (dBuV/m).



Operation Mode: Tx / IEEE 802.11a mode /
5500 ~ 5700MHz /CH Mid

Test Date: September 10, 2012

Temperature: 26°C

Tested by: Shawn Wu

Humidity: 60% RH

Polarity: Ver. / Hor.

Frequency (MHz)	Reading (dBuV)	Correct Factor(dB/m)	Result (dBuV/m)	Limit (dBuV/m)	Margin (dB)	Remark	Antenna Polarization (V/H)
2038.333	56.21	-7.10	49.11	68.30	-19.19	peak	V
N/A							
2680.000	55.64	-6.24	49.40	74.00	-24.60	peak	H
N/A							

Remark:

1. Measuring frequencies from 1 GHz to the 10th harmonic of highest fundamental frequency.
2. Radiated emissions measured in frequency above 1000MHz were made with an instrument using peak/average detector mode.
3. Average test would be performed if the peak result were greater than the average limit.
4. Data of measurement within this frequency range shown " --- " in the table above means the reading of emissions are attenuated more than 20dB below the permissible limits or the field strength is too small to be measured.
5. Measurements above show only up to 6 maximum emissions noted, or would be lesser, with " N/A " remark, if no specific emissions from the EUT are recorded (ie: margin>20dB from the applicable limit) and considered that's already beyond the background noise floor.
6. Margin (dB) = Remark result (dBuV/m) – Average limit (dBuV/m).



Operation Mode: Tx / IEEE 802.11a mode /
5500 ~ 5700MHz / CH High

Test Date: September 10, 2012

Temperature: 26°C

Tested by: Shawn Wu

Humidity: 60% RH

Polarity: Ver. / Hor.

Frequency (MHz)	Reading (dBuV)	Correct Factor(dB/m)	Result (dBuV/m)	Limit (dBuV/m)	Margin (dB)	Remark	Antenna Polarization (V/H)
2458.333	56.22	-6.67	49.55	68.30	-18.75	peak	V
N/A							
2668.333	55.93	-6.27	49.66	74.00	-24.34	peak	H
N/A							

Remark:

1. Measuring frequencies from 1 GHz to the 10th harmonic of highest fundamental frequency.
2. Radiated emissions measured in frequency above 1000MHz were made with an instrument using peak/average detector mode.
3. Average test would be performed if the peak result were greater than the average limit.
4. Data of measurement within this frequency range shown " --- " in the table above means the reading of emissions are attenuated more than 20dB below the permissible limits or the field strength is too small to be measured.
5. Measurements above show only up to 6 maximum emissions noted, or would be lesser, with " N/A " remark, if no specific emissions from the EUT are recorded (ie: margin>20dB from the applicable limit) and considered that's already beyond the background noise floor.
6. Margin (dB) = Remark result (dBuV/m) – Average limit (dBuV/m).



Operation Mode: Tx / IEEE 802.11n HT 20 MHz mode / 5500 ~ 5700MHz / CH Low

Test Date: September 10, 2012

Temperature: 26°C

Tested by: Shawn Wu

Humidity: 60% RH

Polarity: Ver. / Hor.

Frequency (MHz)	Reading (dBuV)	Correct Factor(dB/m)	Result (dBuV/m)	Limit (dBuV/m)	Margin (dB)	Remark	Antenna Polarization (V/H)
2435.000	55.76	-6.66	49.10	68.30	-19.20	peak	V
N/A							
2563.333	60.42	-6.53	53.89	68.30	-14.41	peak	H
2563.333	42.90	-6.53	36.37	54.00	-17.63	AVG	H
N/A							

Remark:

1. Measuring frequencies from 1 GHz to the 10th harmonic of highest fundamental frequency.
2. Radiated emissions measured in frequency above 1000MHz were made with an instrument using peak/average detector mode.
3. Average test would be performed if the peak result were greater than the average limit or as required by the applicant.
4. Data of measurement within this frequency range shown " --- " in the table above means the reading of emissions are attenuated more than 20dB below the permissible limits or the field strength is too small to be measured.
5. Measurements above show only up to 6 maximum emissions noted, or would be lesser, with " N/A " remark, if no specific emissions from the EUT are recorded (ie: margin>20dB from the applicable limit) and considered that's already beyond the background noise floor.
6. Margin (dB) = Remark result (dBuV/m) – Average limit (dBuV/m).



Operation Mode: Tx / IEEE 802.11n HT 20 MHz mode / 5500 ~ 5700MHz / CH Mid **Test Date:** September 10, 2012

Temperature: 26°C **Tested by:** Shawn Wu

Humidity: 60% RH **Polarity:** Ver. / Hor.

Frequency (MHz)	Reading (dBuV)	Correct Factor(dB/m)	Result (dBuV/m)	Limit (dBuV/m)	Margin (dB)	Remark	Antenna Polarization (V/H)
2890.000	55.58	-5.72	49.86	74.00	-24.14	peak	V
N/A							
2318.333	56.31	-6.91	49.40	74.00	-24.60	peak	H
N/A							

Remark:

1. Measuring frequencies from 1 GHz to the 10th harmonic of highest fundamental frequency.
2. Radiated emissions measured in frequency above 1000MHz were made with an instrument using peak/average detector mode.
3. Average test would be performed if the peak result were greater than the average limit.
4. Data of measurement within this frequency range shown " --- " in the table above means the reading of emissions are attenuated more than 20dB below the permissible limits or the field strength is too small to be measured.
5. Measurements above show only up to 6 maximum emissions noted, or would be lesser, with " N/A " remark, if no specific emissions from the EUT are recorded (ie: margin>20dB from the applicable limit) and considered that's already beyond the background noise floor.
6. Margin (dB) = Remark result (dBuV/m) – Average limit (dBuV/m).



Operation Mode: Tx / IEEE 802.11n HT 20 MHz mode / 5500 ~ 5700MHz / CH High

Test Date: September 10, 2012

Temperature: 26°C

Tested by: Shawn Wu

Humidity: 60% RH

Polarity: Ver. / Hor.

Frequency (MHz)	Reading (dBuV)	Correct Factor(dB/m)	Result (dBuV/m)	Limit (dBuV/m)	Margin (dB)	Remark	Antenna Polarization (V/H)
2458.333	56.28	-6.67	49.61	68.30	-18.69	peak	V
N/A							
2551.667	56.54	-6.56	49.98	68.30	-18.32	peak	H
N/A							

Remark:

1. Measuring frequencies from 1 GHz to the 10th harmonic of highest fundamental frequency.
2. Radiated emissions measured in frequency above 1000MHz were made with an instrument using peak/average detector mode.
3. Average test would be performed if the peak result were greater than the average limit or as required by the applicant.
4. Data of measurement within this frequency range shown " --- " in the table above means the reading of emissions are attenuated more than 20dB below the permissible limits or the field strength is too small to be measured.
5. Measurements above show only up to 6 maximum emissions noted, or would be lesser, with " N/A " remark, if no specific emissions from the EUT are recorded (ie: margin>20dB from the applicable limit) and considered that's already beyond the background noise floor.
6. $Margin (dB) = Remark\ result (dBuV/m) - Average\ limit (dBuV/m)$.



Operation Mode: Tx / IEEE 802.11n HT 40 MHz mode / 5510 ~ 5670MHz / CH Low

Test Date: September 10, 2012

Temperature: 26°C

Tested by: Shawn Wu

Humidity: 60% RH

Polarity: Ver. / Hor.

Frequency (MHz)	Reading (dBuV)	Correct Factor(dB/m)	Result (dBuV/m)	Limit (dBuV/m)	Margin (dB)	Remark	Antenna Polarization (V/H)
2913.333	58.53	-5.66	52.87	68.30	-15.43	peak	V
2913.333	43.34	-5.66	37.68	54.00	-16.32	AVG	V
N/A							
2586.667	65.88	-6.47	59.41	68.30	-8.89	peak	H
2586.667	43.75	-6.47	37.28	54.00	-16.72	AVG	H
2936.667	62.29	-5.60	56.69	68.30	-11.61	peak	H
2936.667	44.16	-5.60	38.56	54.00	-15.44	AVG	H
4558.333	59.43	-0.30	59.13	74.00	-14.87	peak	H
4558.333	39.42	-0.30	39.12	54.00	-14.88	AVG	H

Remark:

1. Measuring frequencies from 1 GHz to the 10th harmonic of highest fundamental frequency.
2. Radiated emissions measured in frequency above 1000MHz were made with an instrument using peak/average detector mode.
3. Average test would be performed if the peak result were greater than the average limit or as required by the applicant.
4. Data of measurement within this frequency range shown " --- " in the table above means the reading of emissions are attenuated more than 20dB below the permissible limits or the field strength is too small to be measured.
5. Measurements above show only up to 6 maximum emissions noted, or would be lesser, with " N/A " remark, if no specific emissions from the EUT are recorded (ie: margin>20dB from the applicable limit) and considered that's already beyond the background noise floor.
6. Margin (dB) = Remark result (dBuV/m) – Average limit (dBuV/m).



Operation Mode: Tx / IEEE 802.11n HT 40 MHz mode / 5510 ~ 5670MHz / CH Mid

Test Date: September 10, 2012

Temperature: 26°C

Tested by: Shawn Wu

Humidity: 60% RH

Polarity: Ver. / Hor.

Frequency (MHz)	Reading (dBuV)	Correct Factor(dB/m)	Result (dBuV/m)	Limit (dBuV/m)	Margin (dB)	Remark	Antenna Polarization (V/H)
2563.333	56.59	-6.53	50.06	68.30	-18.24	peak	V
N/A							
2913.333	56.11	-5.66	50.45	68.30	-17.85	peak	H
N/A							

Remark:

1. Measuring frequencies from 1 GHz to the 10th harmonic of highest fundamental frequency.
2. Radiated emissions measured in frequency above 1000MHz were made with an instrument using peak/average detector mode.
3. Average test would be performed if the peak result were greater than the average limit or as required by the applicant.
4. Data of measurement within this frequency range shown " --- " in the table above means the reading of emissions are attenuated more than 20dB below the permissible limits or the field strength is too small to be measured.
5. Measurements above show only up to 6 maximum emissions noted, or would be lesser, with " N/A " remark, if no specific emissions from the EUT are recorded (ie: margin>20dB from the applicable limit) and considered that's already beyond the background noise floor.
6. $Margin (dB) = Remark\ result (dBuV/m) - Average\ limit (dBuV/m)$.



Operation Mode: Tx / IEEE 802.11n HT 40 MHz mode / 5510 ~ 5670MHz / CH High

Test Date: September 10, 2012

Temperature: 26°C

Tested by: Shawn Wu

Humidity: 60% RH

Polarity: Ver. / Hor.

Frequency (MHz)	Reading (dBuV)	Correct Factor(dB/m)	Result (dBuV/m)	Limit (dBuV/m)	Margin (dB)	Remark	Antenna Polarization (V/H)
1968.333	57.60	-7.36	50.24	68.30	-18.06	peak	V
N/A							
2878.333	55.14	-5.74	49.40	74.00	-24.60	peak	H
N/A							

Remark:

1. Measuring frequencies from 1 GHz to the 10th harmonic of highest fundamental frequency.
2. Radiated emissions measured in frequency above 1000MHz were made with an instrument using peak/average detector mode.
3. Average test would be performed if the peak result were greater than the average limit or as required by the applicant.
4. Data of measurement within this frequency range shown " --- " in the table above means the reading of emissions are attenuated more than 20dB below the permissible limits or the field strength is too small to be measured.
5. Measurements above show only up to 6 maximum emissions noted, or would be lesser, with " N/A " remark, if no specific emissions from the EUT are recorded (ie: margin>20dB from the applicable limit) and considered that's already beyond the background noise floor.
6. $Margin (dB) = Remark\ result (dBuV/m) - Average\ limit (dBuV/m)$.



7.7 POWERLINE CONDUCTED EMISSIONS

LIMIT

According to §15.207(a), except as shown in paragraphs (b) and (c) of this section, for an intentional radiator that is designed to be connected to the public utility (AC) power line, the radio frequency voltage that is conducted back onto the AC power line on any frequency or frequencies within the band 150 kHz to 30 MHz shall not exceed the limits in the following table, as measured using a 50 μ H/50 ohms line impedance stabilization network (LISN). Compliance with the provisions of this paragraph shall be based on the measurement of the radio frequency voltage between each power line and ground at the power terminal. The lower limit applies at the boundary between the frequency ranges.

Frequency Range (MHz)	Limits (dB μ V)	
	Quasi-peak	Average
0.15 to 0.50	66 to 56*	56 to 46*
0.50 to 5	56	46
5 to 30	60	50

* Decreases with the logarithm of the frequency.

TEST CONFIGURATION

See test photographs attached in Appendix 1 for the actual connections between EUT and support equipment.

TEST PROCEDURE

1. The EUT was placed on a table, which is 0.8m above ground plane.
2. Maximum procedure was performed on the six highest emissions to ensure EUT compliance.
3. Repeat above procedures until all frequency measured were complete.

TEST RESULTS

The initial step in collecting conducted data is a spectrum analyzer peak scan of the measurement range. Significant peaks are then marked as shown on the following data page, and these signals are then quasi-peaked.



Test Data

Operation Mode: Normal Link
Temperature: 22°C
Humidity: 58% RH

Test Date: August 20, 2012
Tested by: Alan Wu

Conducted emissions (Line 1)

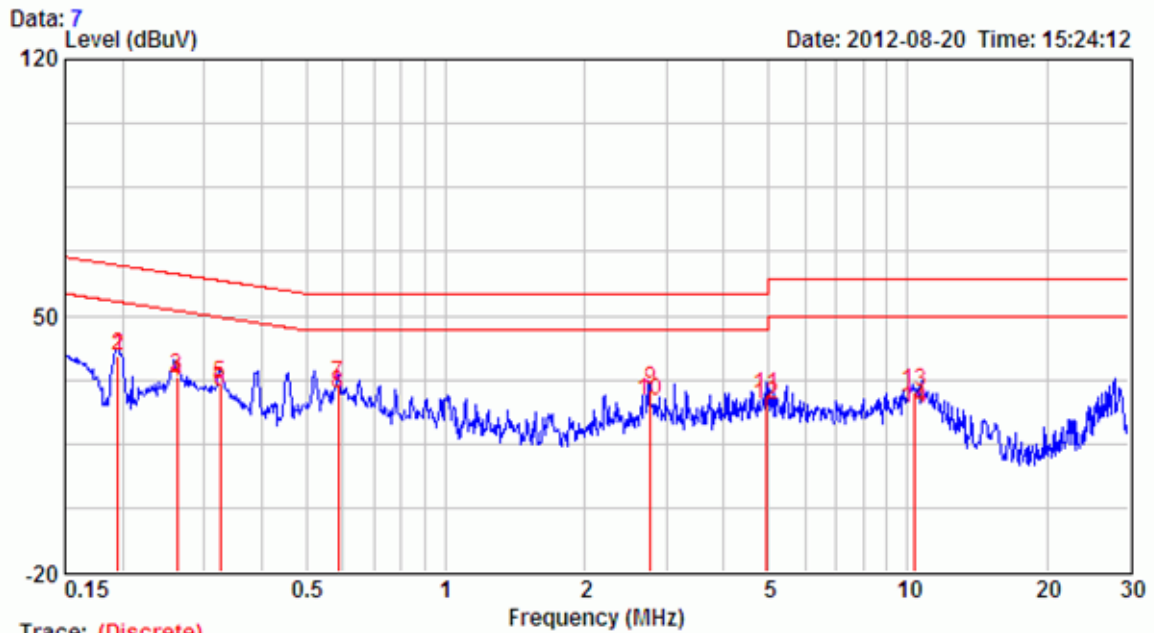

Trace: (Discrete)

Freq. MHz	Corr. Factor dB	Reading Value dBUV		Emission Level dBUV		Limit dBUV		Margin dB	
		Q.P.	AV.	Q.P.	AV.	Q.P.	AV.	Q.P.	AV.
0.195	0.14	38.99	38.88	39.13	39.02	63.82	53.82	-24.69	-14.80
0.262	0.14	33.03	31.77	33.17	31.91	61.38	51.38	-28.21	-19.47
0.325	0.15	31.27	29.21	31.42	29.36	59.57	49.57	-28.16	-20.22
0.586	0.17	30.90	28.75	31.07	28.92	56.00	46.00	-24.93	-17.08
2.781	0.23	29.73	26.64	29.96	26.87	56.00	46.00	-26.04	-19.13
4.937	0.30	27.96	25.18	28.26	25.48	56.00	46.00	-27.74	-20.52
10.292	0.43	28.59	24.09	29.02	24.52	60.00	50.00	-30.98	-25.48

Remarks: 1. The emission levels of other frequencies were very low against the limits .
 2. Correction Factor = Insertion loss + Cable loss
 3. Margin value = Emission level - Limit value



Conducted emissions (Line 2)

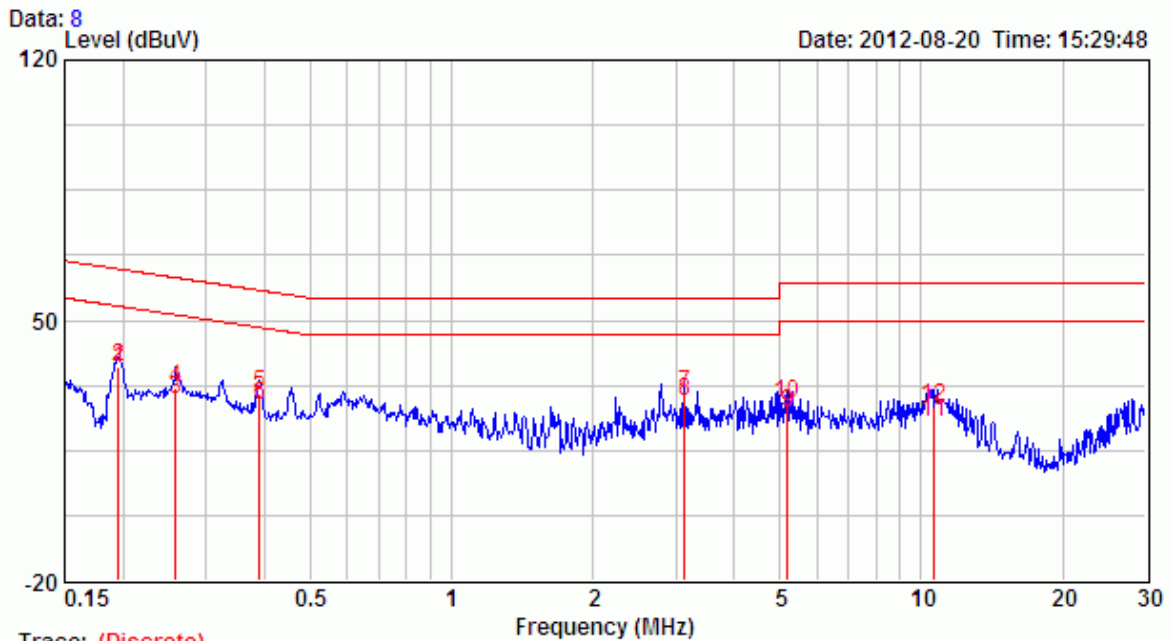

Freq. MHz	Corr. Factor dB	Reading Value dBuV		Emission Level dBuV		Limit dBuV		Margin dB	
		Q.P.	AV.	Q.P.	AV.	Q.P.	AV.	Q.P.	AV.
0.195	0.11	37.33	36.84	37.44	36.95	63.80	53.80	-26.36	-16.85
0.259	0.12	31.81	28.75	31.93	28.87	61.47	51.47	-29.54	-22.60
0.389	0.13	30.21	27.17	30.34	27.30	58.08	48.08	-27.74	-20.78
3.130	0.22	30.13	28.04	30.35	28.26	56.00	46.00	-25.65	-17.74
5.180	0.27	27.32	25.01	27.59	25.28	60.00	50.00	-32.41	-24.72
10.602	0.38	26.26	22.12	26.64	22.50	60.00	50.00	-33.36	-27.50

Remarks: 1. The emission levels of other frequencies were very low against the limits .
 2. Correction Factor = Insertion loss + Cable loss
 3. Margin value = Emission level - Limit value



7.8 FREQUENCY STABILITY

LIMIT

According to §15.407(g), manufacturers of U-NII devices are responsible for ensuring frequency stability such that an emission is maintained within the band of operation under all conditions of normal operation as specified in the user's manual.

Test Configuration

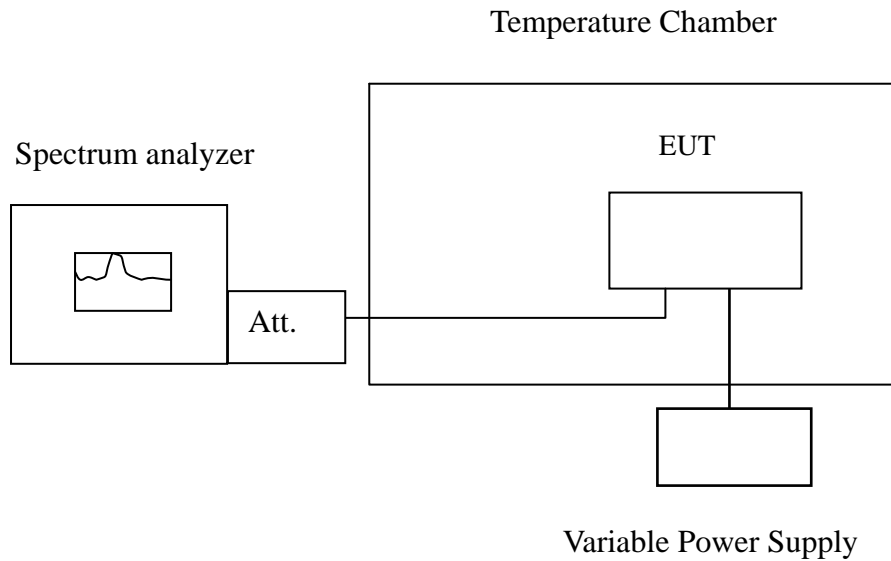

Remark: Measurement setup for testing on Antenna connector



TEST PROCEDURE

The equipment under test was connected to an external AC or DC power supply and input rated voltage. RF output was connected to a frequency counter or spectrum analyzer via feed through attenuators. The EUT was placed inside the temperature chamber. Set the spectrum analyzer RBW low enough to obtain the desired frequency resolution and measure EUT 20°C operating frequency as reference frequency. Turn EUT off and set the chamber temperature to -20°C. After the temperature stabilized for approximately 30 minutes recorded the frequency. Repeat step measure with 10°C increased per stage until the highest temperature of +50°C reached.

TEST RESULTS

No non-compliance noted.

IEEE 802.11a mode / 5180 ~ 5240 MHz:

CH Low

Operating Frequency: 5180 MHz				
Environment Temperature (°C)	Voltage (V)	Measured Frequency (MHz)	Limit Range	Test Result
50	120	5179.9873	5150~5250	pass
40	120	5180.0032	5150~5250	pass
30	120	5179.9979	5150~5250	pass
20	120	5179.9888	5150~5250	pass
10	120	5180.0061	5150~5250	pass
0	120	5179.9768	5150~5250	pass
-10	120	5179.9878	5150~5250	pass
-20	120	5179.9739	5150~5250	pass

Operating Frequency: 5180 MHz				
Environment Temperature (°C)	Voltage (V)	Measured Frequency (MHz)	Limit Range	Test Result
20	108	5179.9857	5150~5250	Pass
	120	5179.9888	5150~5250	Pass
	132	5180.0062	5150~5250	Pass



CH High

Operating Frequency: 5240 MHz				
Environment Temperature (°C)	Voltage (V)	Measured Frequency (MHz)	Limit Range	Test Result
50	120	5240.0157	5150~5250	Pass
40	120	5239.9882	5150~5250	Pass
30	120	5239.9617	5150~5250	Pass
20	120	5239.9975	5150~5250	Pass
10	120	5240.0133	5150~5250	Pass
0	120	5240.0080	5150~5250	Pass
-10	120	5239.9838	5150~5250	Pass
-20	120	5240.0072	5150~5250	Pass

Operating Frequency: 5240 MHz				
Environment Temperature (°C)	Voltage (V)	Measured Frequency (MHz)	Limit Range	Test Result
20	108	5239.9786	5150~5250	Pass
	120	5239.9975	5150~5250	Pass
	132	5240.0097	5150~5250	Pass



IEEE 802.11n HT 20 MHz mode / 5180 ~ 5240 MHz:

CH Low

Operating Frequency: 5180 MHz				
Environment Temperature (°C)	Voltage (V)	Measured Frequency (MHz)	Limit Range	Test Result
50	120	5180.0123	5150~5250	Pass
40	120	5179.9803	5150~5250	Pass
30	120	5180.0037	5150~5250	Pass
20	120	5179.9978	5150~5250	Pass
10	120	5179.9713	5150~5250	Pass
0	120	5180.0067	5150~5250	Pass
-10	120	5179.9832	5150~5250	Pass
-20	120	5179.9930	5150~5250	Pass

Operating Frequency: 5180 MHz				
Environment Temperature (°C)	Voltage (V)	Measured Frequency (MHz)	Limit Range	Test Result
20	108	5180.0147	5150~5250	Pass
	120	5179.9861	5150~5250	Pass
	132	5179.9938	5150~5250	Pass



CH High

Operating Frequency: 5240 MHz				
Environment Temperature (°C)	Voltage (V)	Measured Frequency (MHz)	Limit Range	Test Result
50	120	5239.9989	5150~5250	Pass
40	120	5240.0088	5150~5250	Pass
30	120	5240.0076	5150~5250	Pass
20	120	5240.0141	5150~5250	Pass
10	120	5240.0083	5150~5250	Pass
0	120	5239.9736	5150~5250	Pass
-10	120	5240.0139	5150~5250	Pass
-20	120	5239.9792	5150~5250	Pass

Operating Frequency: 5240 MHz				
Environment Temperature (°C)	Voltage (V)	Measured Frequency (MHz)	Limit Range	Test Result
20	108	5239.9912	5150~5250	Pass
	120	5239.9865	5150~5250	Pass
	132	5239.9983	5150~5250	Pass



IEEE 802.11n HT 40 MHz mode / 5190 ~ 5230 MHz:

CH Low

Operating Frequency: 5190 MHz				
Environment Temperature (°C)	Voltage (V)	Measured Frequency (MHz)	Limit Range	Test Result
50	120	5190.0126	5150~5250	Pass
40	120	5190.0183	5150~5250	Pass
30	120	5189.9860	5150~5250	Pass
20	120	5189.9842	5150~5250	Pass
10	120	5189.9829	5150~5250	Pass
0	120	5190.0057	5150~5250	Pass
-10	120	5190.0069	5150~5250	Pass
-20	120	5190.0037	5150~5250	Pass

Operating Frequency: 5190 MHz				
Environment Temperature (°C)	Voltage (V)	Measured Frequency (MHz)	Limit Range	Test Result
20	108	5189.9942	5150~5250	Pass
	120	5189.9842	5150~5250	Pass
	132	5189.9958	5150~5250	Pass



CH High

Operating Frequency: 5230 MHz				
Environment Temperature (°C)	Voltage (V)	Measured Frequency (MHz)	Limit Range	Test Result
50	120	5230.0164	5150~5250	Pass
40	120	5229.9731	5150~5250	Pass
30	120	5229.9759	5150~5250	Pass
20	120	5229.9949	5150~5250	Pass
10	120	5229.9984	5150~5250	Pass
0	120	5230.0077	5150~5250	Pass
-10	120	5229.9843	5150~5250	Pass
-20	120	5230.0131	5150~5250	Pass

Operating Frequency: 5230 MHz				
Environment Temperature (°C)	Voltage (V)	Measured Frequency (MHz)	Limit Range	Test Result
20	108	5229.9972	5150~5250	Pass
	120	5229.9949	5150~5250	Pass
	132	5230.0060	5150~5250	Pass



IEEE 802.11a mode / 5260 ~ 5320 MHz:

CH Low

Operating Frequency: 5260 MHz				
Environment Temperature (°C)	Voltage (V)	Measured Frequency (MHz)	Limit Range	Test Result
50	120	5260.0068	5250~5350	Pass
40	120	5259.9829	5250~5350	Pass
30	120	5259.9740	5250~5350	Pass
20	120	5260.0434	5250~5350	Pass
10	120	5259.9756	5250~5350	Pass
0	120	5259.9774	5250~5350	Pass
-10	120	5260.0067	5250~5350	Pass
-20	120	5259.9849	5250~5350	Pass

Operating Frequency: 5260 MHz				
Environment Temperature (°C)	Voltage (V)	Measured Frequency (MHz)	Limit Range	Test Result
20	108	5260.0039	5250~5350	Pass
	120	5260.0434	5250~5350	Pass
	132	5259.9752	5250~5350	Pass



CH High

Operating Frequency: 5320 MHz				
Environment Temperature (°C)	Voltage (V)	Measured Frequency (MHz)	Limit Range	Test Result
50	120	5319.9958	5250~5350	Pass
40	120	5319.9818	5250~5350	Pass
30	120	5320.0229	5250~5350	Pass
20	120	5320.0134	5250~5350	Pass
10	120	5320.0149	5250~5350	Pass
0	120	5320.0026	5250~5350	Pass
-10	120	5319.9975	5250~5350	Pass
-20	120	5319.9838	5250~5350	Pass

Operating Frequency: 5320 MHz				
Environment Temperature (°C)	Voltage (V)	Measured Frequency (MHz)	Limit Range	Test Result
20	108	5320.0127	5250~5350	Pass
	120	5320.0134	5250~5350	Pass
	132	5320.0067	5250~5350	Pass



IEEE 802.11n HT 20 MHz mode / 5260 ~ 5320 MHz:

CH Low

Operating Frequency: 5260 MHz				
Environment Temperature (°C)	Voltage (V)	Measured Frequency (MHz)	Limit Range	Test Result
50	120	5259.9826	5250~5350	Pass
40	120	5260.0199	5250~5350	Pass
30	120	5260.0152	5250~5350	Pass
20	120	5259.9967	5250~5350	Pass
10	120	5259.9912	5250~5350	Pass
0	120	5260.0178	5250~5350	Pass
-10	120	5259.9802	5250~5350	Pass
-20	120	5259.9775	5250~5350	Pass

Operating Frequency: 5260 MHz				
Environment Temperature (°C)	Voltage (V)	Measured Frequency (MHz)	Limit Range	Test Result
20	108	5260.0082	5250~5350	Pass
	120	5259.9869	5250~5350	Pass
	132	5259.9806	5250~5350	Pass



CH High

Operating Frequency: 5320 MHz				
Environment Temperature (°C)	Voltage (V)	Measured Frequency (MHz)	Limit Range	Test Result
50	120	5320.0045	5250~5350	Pass
40	120	5319.9744	5250~5350	Pass
30	120	5320.0018	5250~5350	Pass
20	120	5320.0027	5250~5350	Pass
10	120	5319.9796	5250~5350	Pass
0	120	5319.9800	5250~5350	Pass
-10	120	5319.9745	5250~5350	Pass
-20	120	5319.9751	5250~5350	Pass

Operating Frequency: 5320 MHz				
Environment Temperature (°C)	Voltage (V)	Measured Frequency (MHz)	Limit Range	Test Result
20	108	5319.9851	5250~5350	Pass
	120	5319.9724	5250~5350	Pass
	132	5320.0036	5250~5350	Pass



IEEE 802.11n HT 40 MHz mode / 5270 ~ 5310 MHz:

CH Low

Operating Frequency: 5270 MHz				
Environment Temperature (°C)	Voltage (V)	Measured Frequency (MHz)	Limit Range	Test Result
50	120	5269.9977	5250~5350	Pass
40	120	5269.9828	5250~5350	Pass
30	120	5270.0119	5250~5350	Pass
20	120	5269.9946	5250~5350	Pass
10	120	5270.0187	5250~5350	Pass
0	120	5269.9783	5250~5350	Pass
-10	120	5270.0108	5250~5350	Pass
-20	120	5269.9914	5250~5350	Pass

Operating Frequency: 5270 MHz				
Environment Temperature (°C)	Voltage (V)	Measured Frequency (MHz)	Limit Range	Test Result
20	108	5270.0128	5250~5350	Pass
	120	5269.9946	5250~5350	Pass
	132	5270.0258	5250~5350	Pass



CH High

Operating Frequency: 5310 MHz				
Environment Temperature (°C)	Voltage (V)	Measured Frequency (MHz)	Limit Range	Test Result
50	120	5310.0028	5250~5350	Pass
40	120	5310.0072	5250~5350	Pass
30	120	5309.9737	5250~5350	Pass
20	120	5309.9915	5250~5350	Pass
10	120	5310.0038	5250~5350	Pass
0	120	5310.0080	5250~5350	Pass
-10	120	5309.9726	5250~5350	Pass
-20	120	5309.9836	5250~5350	Pass

Operating Frequency: 5310 MHz				
Environment Temperature (°C)	Voltage (V)	Measured Frequency (MHz)	Limit Range	Test Result
20	108	5309.9982	5250~5350	Pass
	120	5309.9915	5250~5350	Pass
	132	5310.0056	5250~5350	Pass



IEEE 802.11a mode / 5500 ~ 5700 MHz:

CH Low

Operating Frequency: 5500 MHz				
Environment Temperature (°C)	Voltage (V)	Measured Frequency (MHz)	Limit Range	Test Result
50	120	5499.9962	5470~5725	Pass
40	120	5499.9947	5470~5725	Pass
30	120	5499.9960	5470~5725	Pass
20	120	5499.9933	5470~5725	Pass
10	120	5499.9857	5470~5725	Pass
0	120	5499.9882	5470~5725	Pass
-10	120	5500.0077	5470~5725	Pass
-20	120	5500.0057	5470~5725	Pass

Operating Frequency: 5500 MHz				
Environment Temperature (°C)	Voltage (V)	Measured Frequency (MHz)	Limit Range	Test Result
20	108	5499.9879	5470~5725	Pass
	120	5499.9933	5470~5725	Pass
	132	5500.0139	5470~5725	Pass



CH High

Operating Frequency: 5700 MHz				
Environment Temperature (°C)	Voltage (V)	Measured Frequency (MHz)	Limit Range	Test Result
50	120	5700.0280	5470~5725	Pass
40	120	5699.9768	5470~5725	Pass
30	120	5700.0080	5470~5725	Pass
20	120	5699.9752	5470~5725	Pass
10	120	5699.9738	5470~5725	Pass
0	120	5700.0072	5470~5725	Pass
-10	120	5700.0015	5470~5725	Pass
-20	120	5700.0199	5470~5725	Pass

Operating Frequency: 5700 MHz				
Environment Temperature (°C)	Voltage (V)	Measured Frequency (MHz)	Limit Range	Test Result
20	108	5700.0138	5470~5725	Pass
	120	5699.9752	5470~5725	Pass
	132	5699.9942	5470~5725	Pass



IEEE 802.11n HT 20 MHz mode / 5500 ~ 5700 MHz:

CH Low

Operating Frequency: 5500 MHz				
Environment Temperature (°C)	Voltage (V)	Measured Frequency (MHz)	Limit Range	Test Result
50	120	5500.0154	5470~5725	Pass
40	120	5499.9715	5470~5725	Pass
30	120	5499.9875	5470~5725	Pass
20	120	5500.0238	5470~5725	Pass
10	120	5499.9756	5470~5725	Pass
0	120	5500.0160	5470~5725	Pass
-10	120	5500.0169	5470~5725	Pass
-20	120	5499.9789	5470~5725	Pass

Operating Frequency: 5500 MHz				
Environment Temperature (°C)	Voltage (V)	Measured Frequency (MHz)	Limit Range	Test Result
20	108	5500.0063	5470~5725	Pass
	120	5500.0238	5470~5725	Pass
	132	5500.0138	5470~5725	Pass



CH High

Operating Frequency: 5700 MHz				
Environment Temperature (°C)	Voltage (V)	Measured Frequency (MHz)	Limit Range	Test Result
50	120	5699.9790	5470~5725	Pass
40	120	5700.0032	5470~5725	Pass
30	120	5699.9957	5470~5725	Pass
20	120	5699.9772	5470~5725	Pass
10	120	5700.0059	5470~5725	Pass
0	120	5700.0138	5470~5725	Pass
-10	120	5699.9776	5470~5725	Pass
-20	120	5699.9987	5470~5725	Pass

Operating Frequency: 5700 MHz				
Environment Temperature (°C)	Voltage (V)	Measured Frequency (MHz)	Limit Range	Test Result
20	108	5700.0565	5470~5725	Pass
	120	5699.9772	5470~5725	Pass
	132	5699.9484	5470~5725	Pass



IEEE 802.11n HT 40 MHz mode / 5510 ~ 5670 MHz:

CH Low

Operating Frequency: 5510 MHz				
Environment Temperature (°C)	Voltage (V)	Measured Frequency (MHz)	Limit Range	Test Result
50	120	5509.9838	5470~5725	Pass
40	120	5510.0059	5470~5725	Pass
30	120	5510.0067	5470~5725	Pass
20	120	5509.9926	5470~5725	Pass
10	120	5509.9972	5470~5725	Pass
0	120	5510.0143	5470~5725	Pass
-10	120	5510.0139	5470~5725	Pass
-20	120	5509.9817	5470~5725	Pass

Operating Frequency: 5510 MHz				
Environment Temperature (°C)	Voltage (V)	Measured Frequency (MHz)	Limit Range	Test Result
20	108	5509.9385	5470~5725	Pass
	120	5509.9926	5470~5725	Pass
	132	5509.9827	5470~5725	Pass



CH High

Operating Frequency: 5670 MHz				
Environment Temperature (°C)	Voltage (V)	Measured Frequency (MHz)	Limit Range	Test Result
50	120	5670.0038	5470~5725	Pass
40	120	5669.9859	5470~5725	Pass
30	120	5670.0039	5470~5725	Pass
20	120	5670.0128	5470~5725	Pass
10	120	5669.9958	5470~5725	Pass
0	120	5669.9730	5470~5725	Pass
-10	120	5669.9922	5470~5725	Pass
-20	120	5669.9719	5470~5725	Pass

Operating Frequency: 5670 MHz				
Environment Temperature (°C)	Voltage (V)	Measured Frequency (MHz)	Limit Range	Test Result
20	108	5670.0143	5470~5725	Pass
	120	5670.0128	5470~5725	Pass
	132	5670.0371	5470~5725	Pass



7.9 DYNAMIC FREQUENCY SELECTION

LIMIT

According to §15.407 (h) and FCC 06-96 appendix “compliance measurement procedures for unlicensed-national information infrastructure devices operating in the 5250-5350 MHz and 5470-5725 MHz bands incorporating dynamic frequency selection”.

Table 1: Applicability of DFS requirements prior to use of a channel

Requirement	Operational Mode		
	Master	Client (without radar detection)	Client(with radar detection)
Non-Occupancy Period	Yes	Yes	Yes
DFS Detection Threshold	Yes	Not required	Yes
Channel Availability Check Time	Yes	Not required	Not required
Uniform Spreading	Yes	Not required	Not required
U-NII Detection Bandwidth	Yes	Not required	Yes

Table 2: Applicability of DFS requirements during normal operation

Requirement	Operational Mode		
	Master	Client (without radar detection)	Client(with radar detection)
DFS Detection Threshold	Yes	Not required	Yes
Channel Closing Transmission Time	Yes	Yes	Yes
Channel Move Time	Yes	Yes	Yes
U-NII Detection Bandwidth	Yes	Not required	Yes

Table 3: Interference Threshold values, Master or Client incorporating In-Service

Maximum Transmit Power	Value (see note)
>=200 Milliwatt	-64 dBm
< 200 Milliwatt	-62 dBm

Note 1: This is the level at the input of the receiver assuming a 0 dBi receive antenna.

Note 2: Throughout these test procedures an additional 1 dB has been added to the amplitude of the test transmission waveforms to account for variations in measurement equipment. This will ensure that the test signal is at or above the detection threshold level to trigger a DFS response.



Table 4: DFS Response requirement values

Parameter	Value
Non-occupancy period	30 minutes
Channel Availability Check Time	60 seconds
Channel Move Time	10 seconds
Channel Closing Transmission Time	200 milliseconds + approx. 60 milliseconds over remaining 10 second period
U-NII Detection Bandwidth	Minimum 80% of the UNII 99% transmission power bandwidth. See Note 3.

The instant that the Channel Move Time and the Channel Closing Transmission Time begins is as follows:

- For the Short pulse radar Test Signals this instant is the end of the Burst.
- For the Frequency Hopping radar Test Signal, this instant is the end of the last radar burst generated.
- For the Long Pulse radar Test Signal this instant is the end of the 12 second period defining the radar transmission.

The Channel Closing Transmission Time is comprised of 200 milliseconds starting at the beginning of the Channel Move Time plus any additional intermittent control signals required to facilitate channel changes (an aggregate of approximately 60 milliseconds) during the remainder of the 10 second period. The aggregate duration of control signals will not count quiet periods in between transmissions.

Table 5 – Short Pulse Radar Test Waveforms

Radar Type	Pulse Width (Microseconds)	PRI (Microseconds)	Pulses	Minimum Percentage of Successful Detection	Minimum Trials
1	1	1428	18	60%	30
2	1-5	150-230	23-29	60%	30
3	6-10	200-500	16-18	60%	30
4	11-20	200-500	12-16	60%	30
Aggregate (Radar Types 1-4)				80%	120

Table 6 – Long Pulse Radar Test Signal

Radar Waveform	Bursts	Pulses per Burst	Pulse Width (µsec)	Chirp Width (µsec)	PRI (µsec)	Minimum Percentage of Successful Detection	Minimum Trials
5	8-20	1-3	50-100	5-20	1000-2000	80%	30

Table 7 – Frequency Hopping Radar Test Signal

Radar Waveform	Pulse Width (µsec)	PRI (µsec)	Burst Length (ms)	Pulses Per Hop	Hopping Rate (kHz)	Minimum Percentage of Successful Detection	Minimum Trials
6	1	333	300	9	0.33	70%	30



DESCRIPTION OF EUT

Overview Of EUT With Respect To §15.407 (H) Requirements

The EUT operates over the 5250-5350 MHz range as a Client Device that does not have radar detection capability.

The antenna assembly utilized with the EUT has a gain of 3.34 dBi.

The highest power level is 13.53 dBm EIRP in the 5500 ~ 5700MHz band.

The EUT uses one transmitter connected to two 50-ohm coaxial antenna ports via a diversity switch. Two antenna port is connected to the test system since the EUT has two antenna.

The Slave device associated with the EUT during these tests does not have radar detection capability.

WLAN traffic is generated by streaming the video file TestFile.mp2 “6 ½ Magic Hours” from the Master to the Slave in full motion video mode using the media player with the V2.61 Codec package.

TPC is not required since the maximum EIRP is less than 500 mW (27 dBm).

The EUT utilizes the 802.11a architecture, with a nominal channel bandwidth of 20 MHz.

The Master Device is a Cisco Aironet 802.11a/b/g Access Point, FCC ID: LDK102073.

The rated output power of the Master unit is < 23dBm (EIRP). Therefore the required interference threshold level is -62 dBm. After correction for antenna gain and procedural adjustments, the required conducted threshold at the antenna port is $-62 + 3.34 = -58.66$ dBm.

The calibrated conducted DFS Detection Threshold level is set to -58.66 dBm. The tested level is lower than the required level hence it provides margin to the limit.

Manufacturer’s Statement Regarding Uniform Channel Spreading

The end product implements an automatic channel selection feature at startup such that operation commences on channels distributed across the entire set of allowed 5GHz channels. This feature will ensure uniform spreading is achieved while avoiding non-allowed channels due to prior radar events.



TEST AND MEASUREMENT SYSTEM

System Overview

The measurement system is based on a conducted test method.

The short pulse and long pulse signal generating system utilizes the NTIA software. The Vector Signal Generator has been validated by the NTIA. The hopping signal generating system utilizes the CCS simulated hopping method and system, which has been validated by the DoD, FCC and NTIA. The software selects waveform parameters from within the bounds of the signal type on a random basis using uniform distribution.

The short pulse types 2, 3 and 4, and the long pulse type 5 parameters are randomized at run-time.

The hopping type 6 pulse parameters are fixed while the hopping sequence is based on the August 2005 NTIA Hopping Frequency List. The initial starting point randomized at run-time and each subsequent starting point is incremented by 475. Each frequency in the 100-length segment is compared to the boundaries of the EUT Detection Bandwidth and the software creates a hopping burst pattern in accordance with Section 7.4.1.3 Method #2 Simulated Frequency Hopping Radar Waveform Generating Subsystem of FCC 06-96 APPENDIX. The frequency of the signal generator is incremented in 1 MHz steps from FL to FH for each successive trial. This incremental sequence is repeated as required to generate a minimum of 30 total trials and to maintain a uniform frequency distribution over the entire Detection Bandwidth.

The signal monitoring equipment consists of a spectrum analyzer set to display 8001 bins on the horizontal axis. The time-domain resolution is 2 msec / bin with a 16 second sweep time, meeting the 10 second short pulse reporting criteria. The aggregate ON time is calculated by multiplying the number of bins above a threshold during a particular observation period by the dwell time per bin, with the analyzer set to peak detection and max hold. The time-domain resolution is 3 msec / bin with a 24 second sweep time, meeting the 22 second long pulse reporting criteria and allowing a minimum of 10 seconds after the end of the long pulse waveform.

Should multiple RF ports be utilized for the Master and/or Slave devices (for example, for diversity or MIMO implementations), 50 ohm termination would be removed from the splitter so that connection can be established between splitter and the Master and/or Slave devices.

Conducted Method System Block Diagram

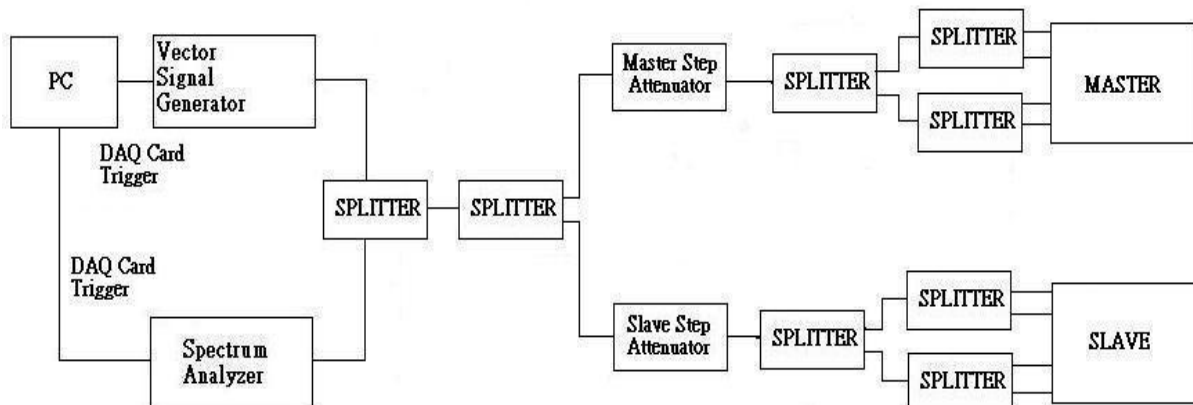



System Calibration

Connect the spectrum analyzer to the test system in place of the master device. Set the signal generator to CW mode. Adjust the amplitude of the signal generator to yield a measured level of -62 dBm on the spectrum analyzer.

Without changing any of the instrument settings, reconnect the spectrum analyzer to the Common port of the Spectrum Analyzer Combiner/Divider and connect a 50 ohm load to the Master Device port of the test system.

Measure the amplitude and calculate the difference from -62 dBm. Adjust the Reference Level Offset of the spectrum analyzer to this difference. Confirm that the signal is displayed at -62 dBm. Readjust the RBW and VBW to 3 MHz, set the span to 10 MHz, and confirm that the signal is still displayed at -62 dBm.

The spectrum analyzer displays the level of the signal generator as received at the antenna ports of the Master Device. The interference detection threshold may be varied from the calibrated value of -62 dBm and the spectrum analyzer will still indicate the level as received by the Master Device.

Set the signal generator to produce a radar waveform, trigger a burst manually and measure the level on the spectrum analyzer. Readjust the amplitude of the signal generator as required so that the peak level of the waveform is at a displayed level equal to the required or desired interference detection threshold. Separate signal generator amplitude settings are determined as required for each radar type.

Adjustment Of Displayed Traffic Level

Establish a link between the Master and Slave, adjusting the Link Step Attenuator as needed to provide a suitable received level at the Master and Slave devices. Stream the video test file to generate WLAN traffic. Confirm that the WLAN traffic level, as displayed on the spectrum analyzer, is at lower amplitude than the radar detection threshold. Confirm that the displayed traffic is from the Master Device. For Master Device testing confirm that the displayed traffic does not include Slave Device traffic. For Slave Device testing confirm that the displayed traffic does not include Master Device traffic.

If a different setting of the Master Step Attenuator is required to meet the above conditions, perform a new System Calibration for the new Master Step Attenuator setting.



Test Setup

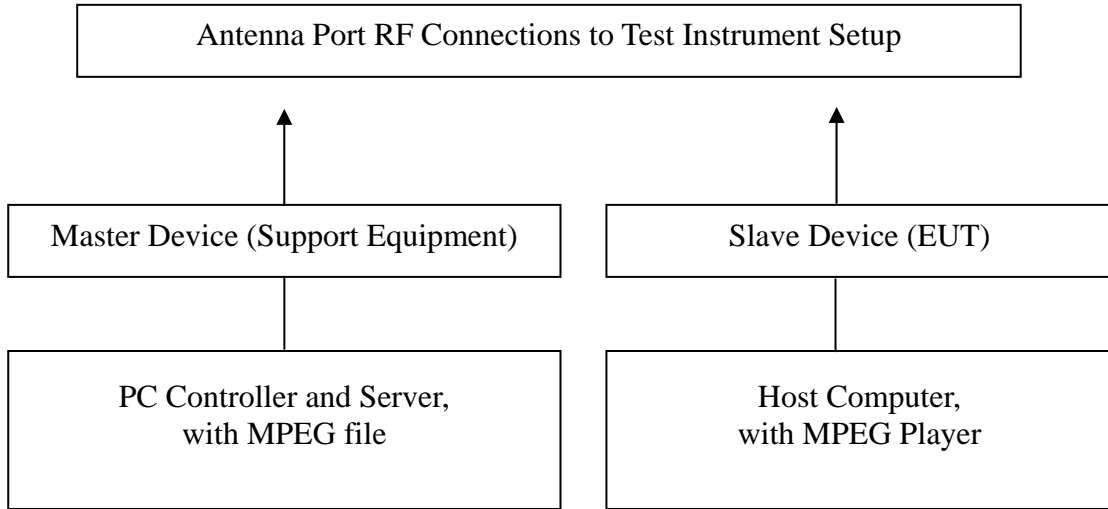

TEST RESULTS

No non-compliance noted



Test Plot

PLOTS OF RADAR WAVEFORMS

IEEE 802.11n HT 20 MHz mode

Sample of Short Pulse Radar Type 1

Agilent 10:24:43 Aug 9, 2012

R T

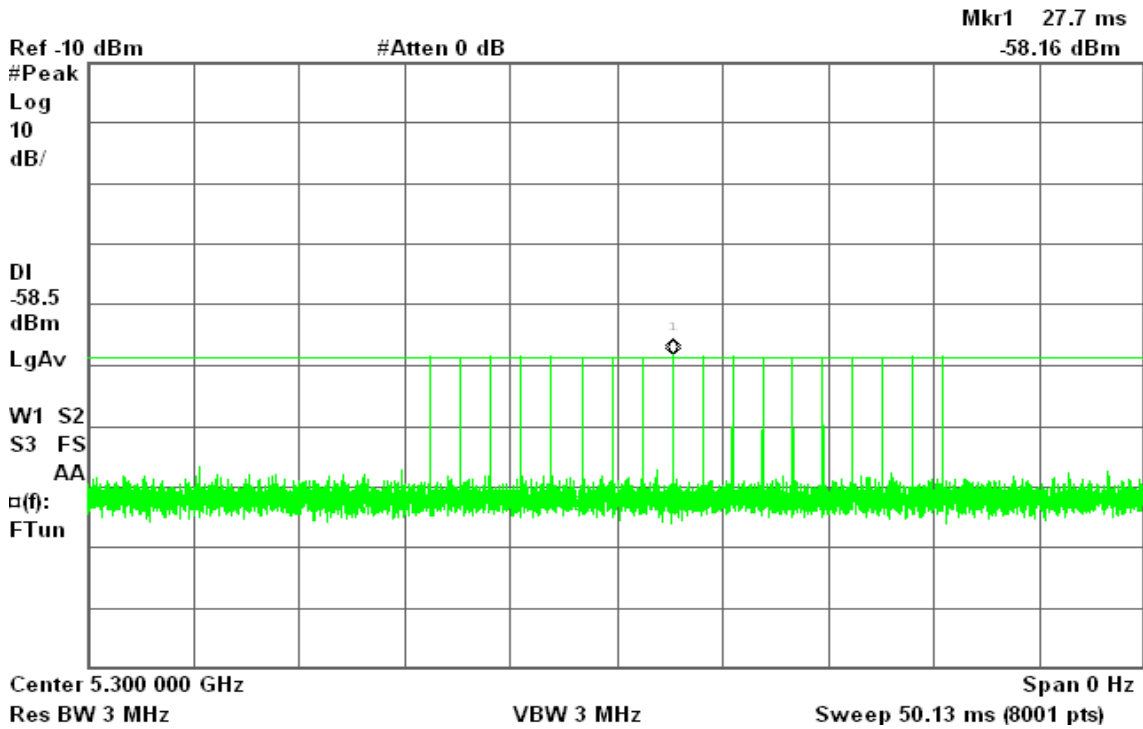

Sample of Short Pulse Radar Type 2

Agilent 10:27:10 Aug 9, 2012

R T

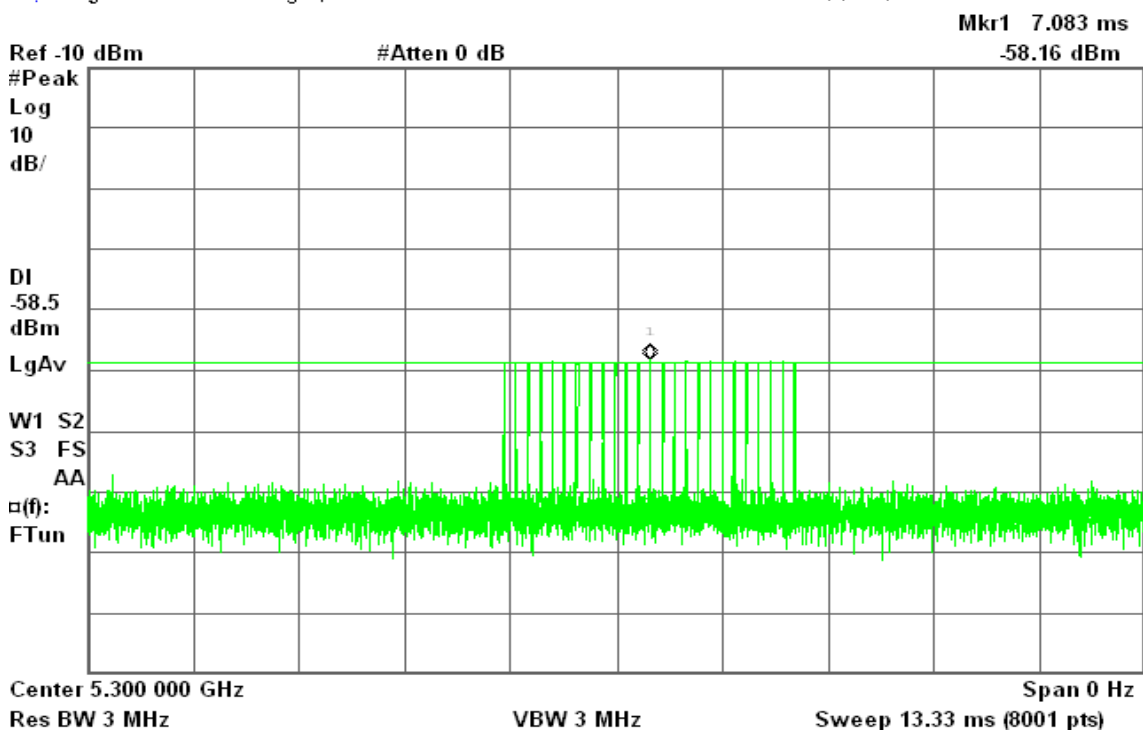



Sample of Short Pulse Radar Type 3

Agilent 10:28:52 Aug 9, 2012

R T

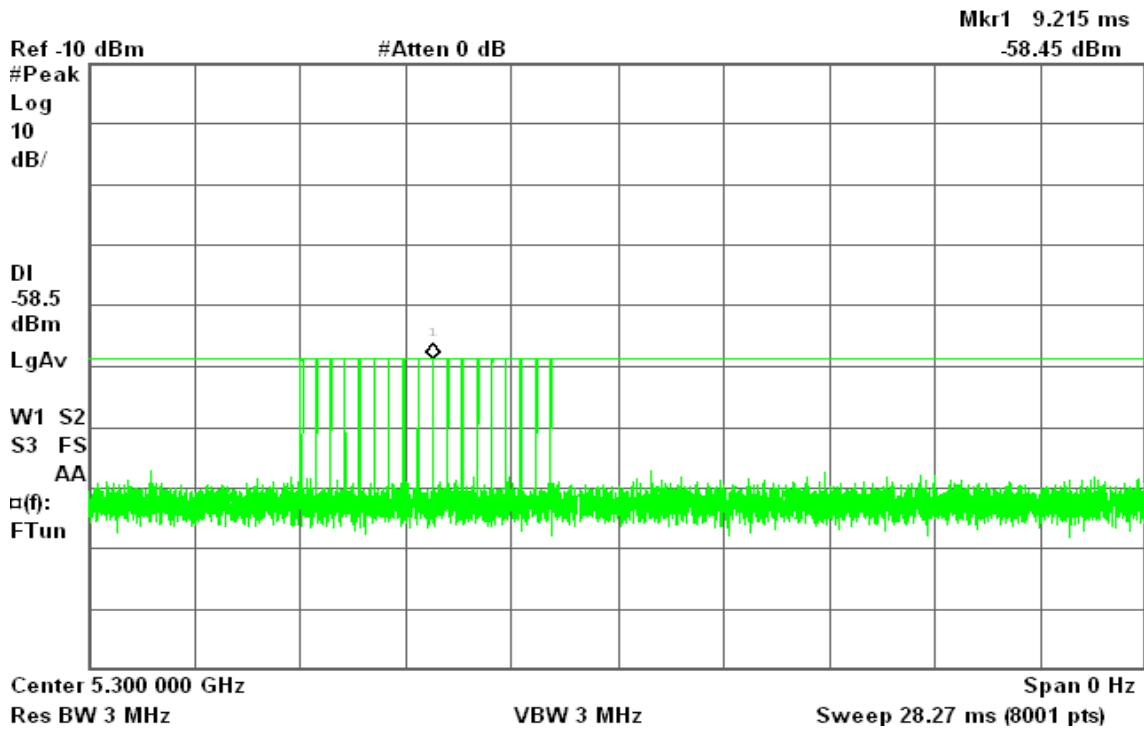

Sample of Short Pulse Radar Type 4

Agilent 10:30:07 Aug 9, 2012

R T

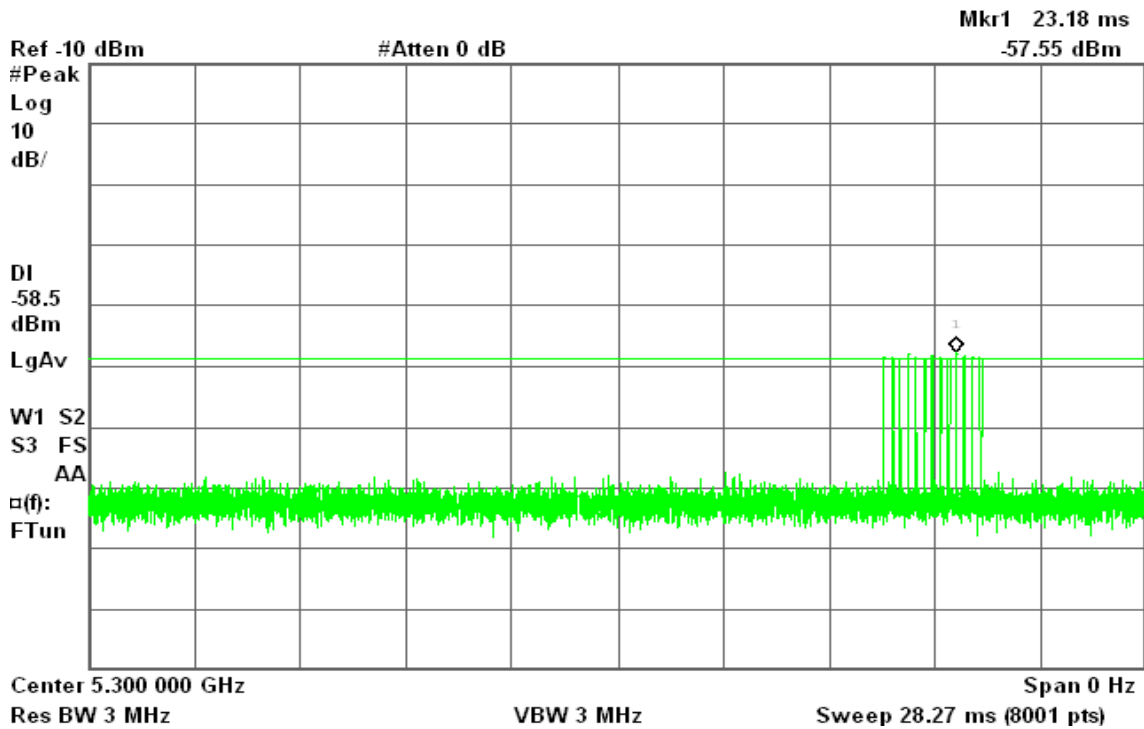



Sample of Long Pulse Radar Type 5

Agilent 12:30:15 Aug 11, 2012

R T

Mkr1 8.248 s
-57.48 dBm

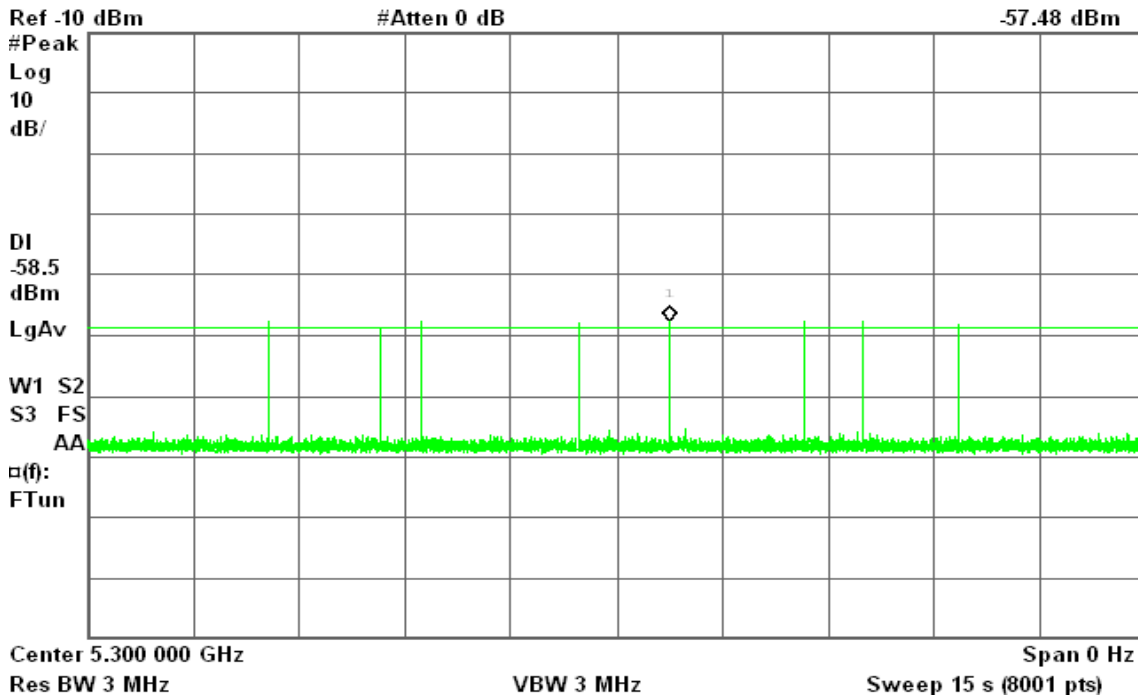

Sample of Frequency Hopping Radar Type 6

Agilent 13:49:57 Aug 11, 2012

T

Mkr1 5.29 ms
-58.35 dBm

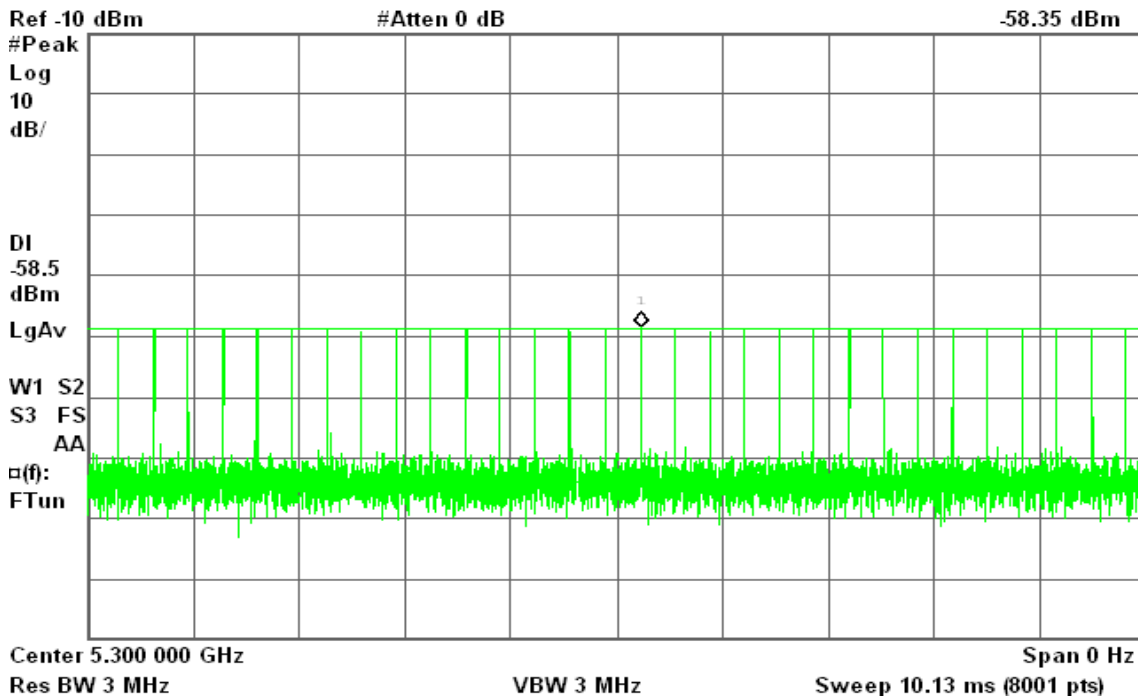



Plot of WLAN Traffic from Slave

Agilent 16:06:48 Aug 11, 2012

T

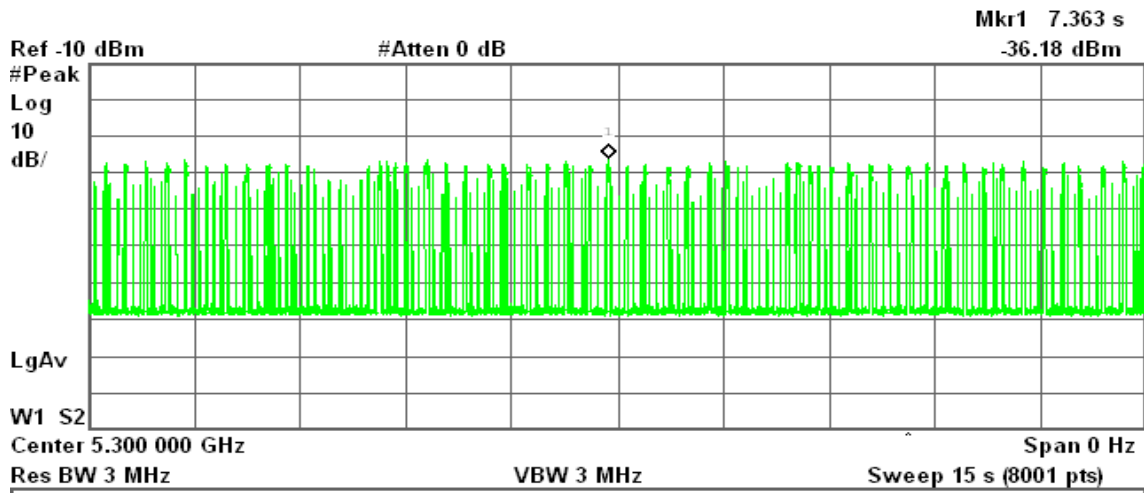

Marker	Trace	Type	X Axis	Amplitude
1	(1)	Time	7.363 s	-36.18 dBm



IEEE 802.11n HT 40 MHz mode mode

Sample of Short Pulse Radar Type 1

Agilent 10:24:43 Aug 9, 2012

R T

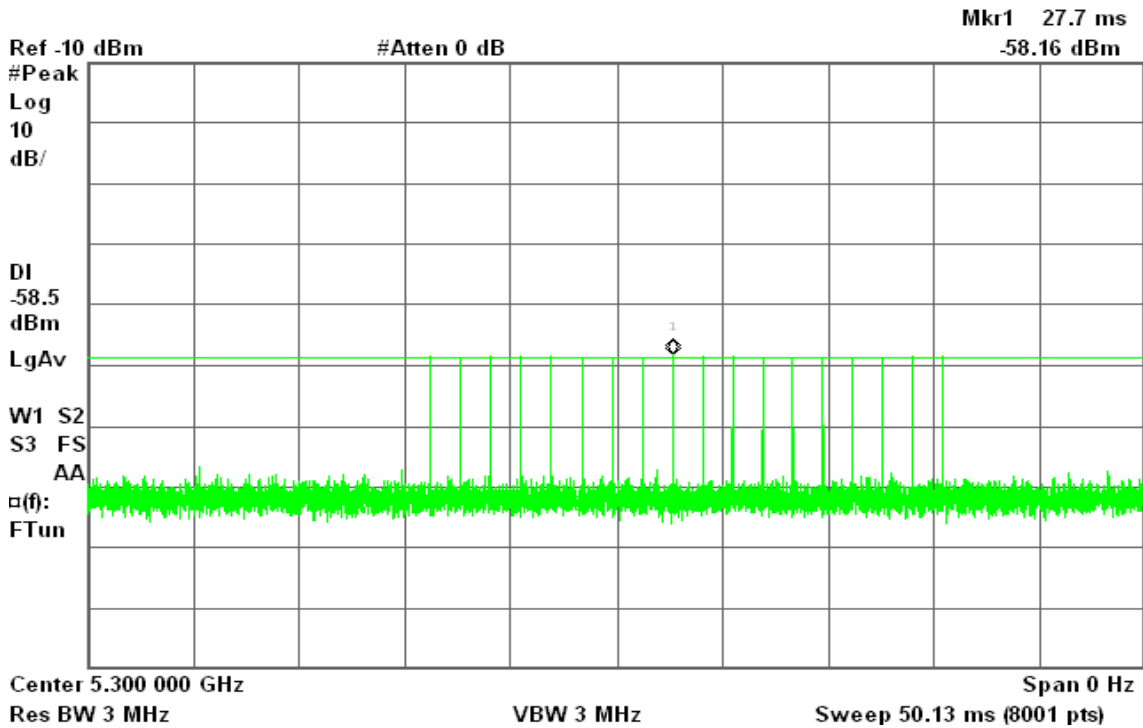

Sample of Short Pulse Radar Type 2

Agilent 10:27:10 Aug 9, 2012

R T

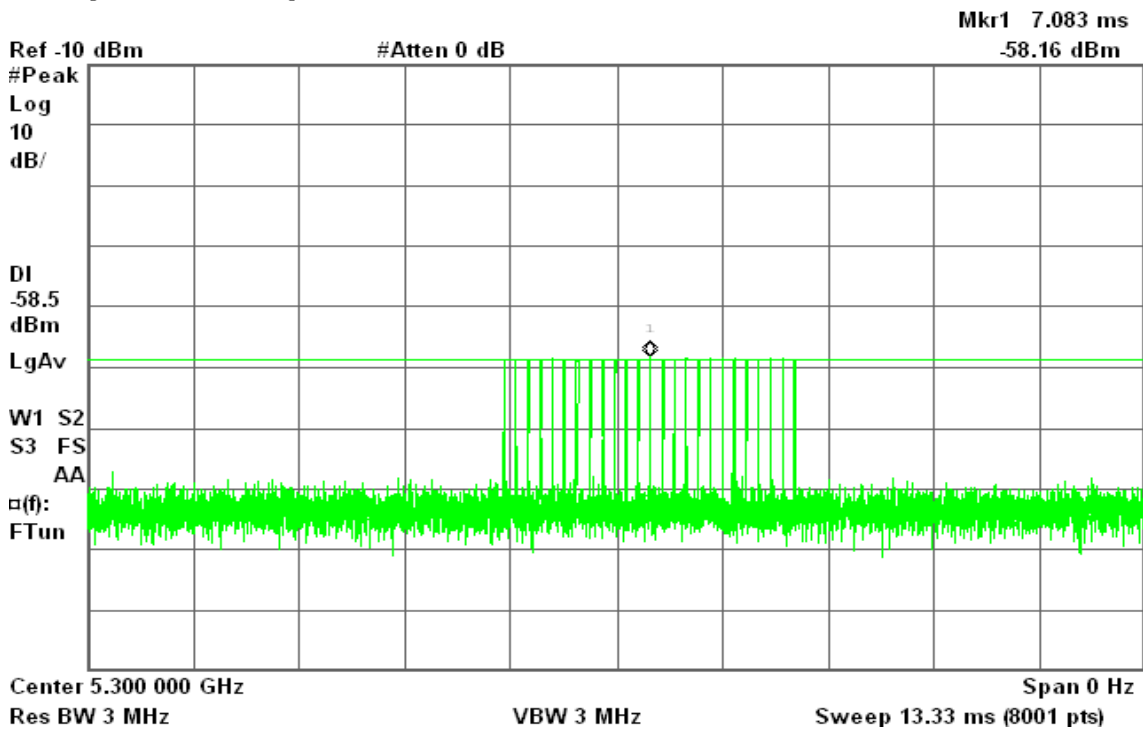



Sample of Short Pulse Radar Type 3

Agilent 10:28:52 Aug 9, 2012

R T

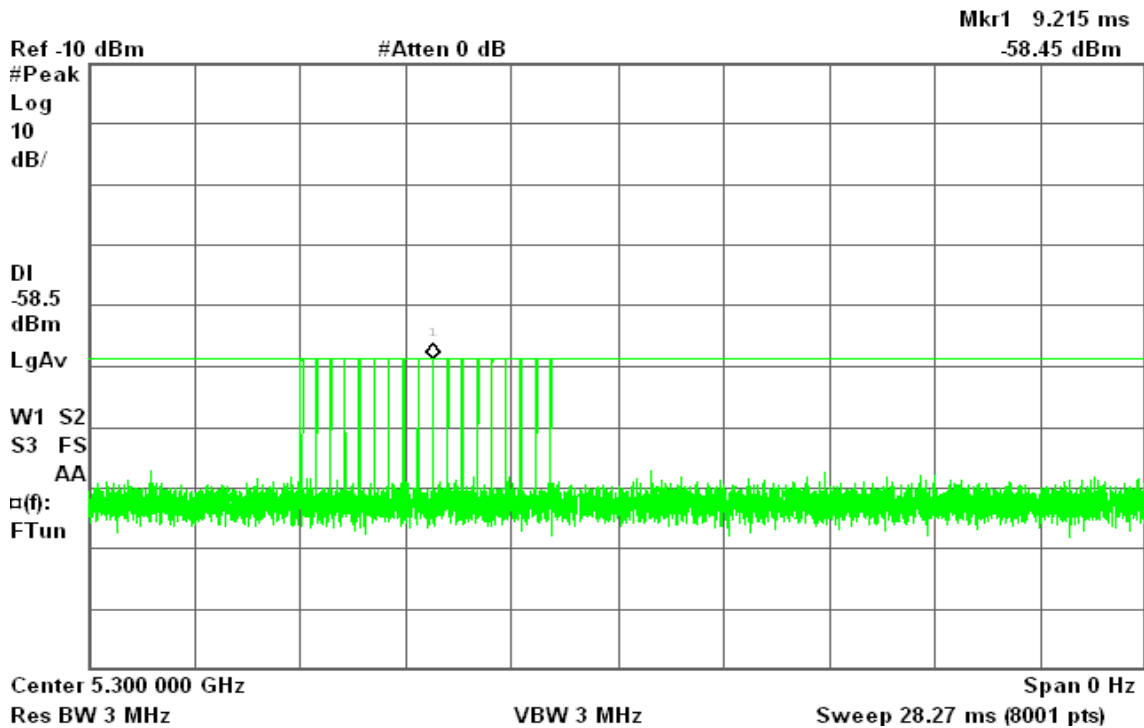

Sample of Short Pulse Radar Type 4

Agilent 10:30:07 Aug 9, 2012

R T

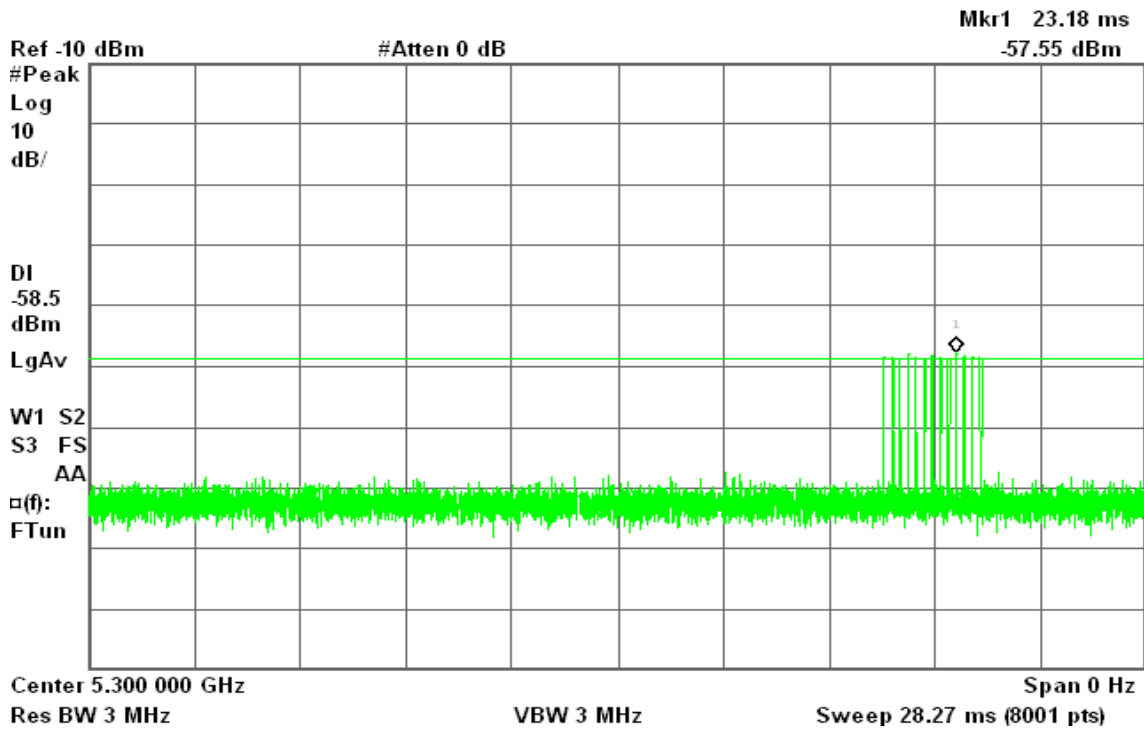



Sample of Long Pulse Radar Type 5

Agilent 12:30:15 Aug 11, 2012

R T

Mkr1 8.248 s
-57.48 dBm

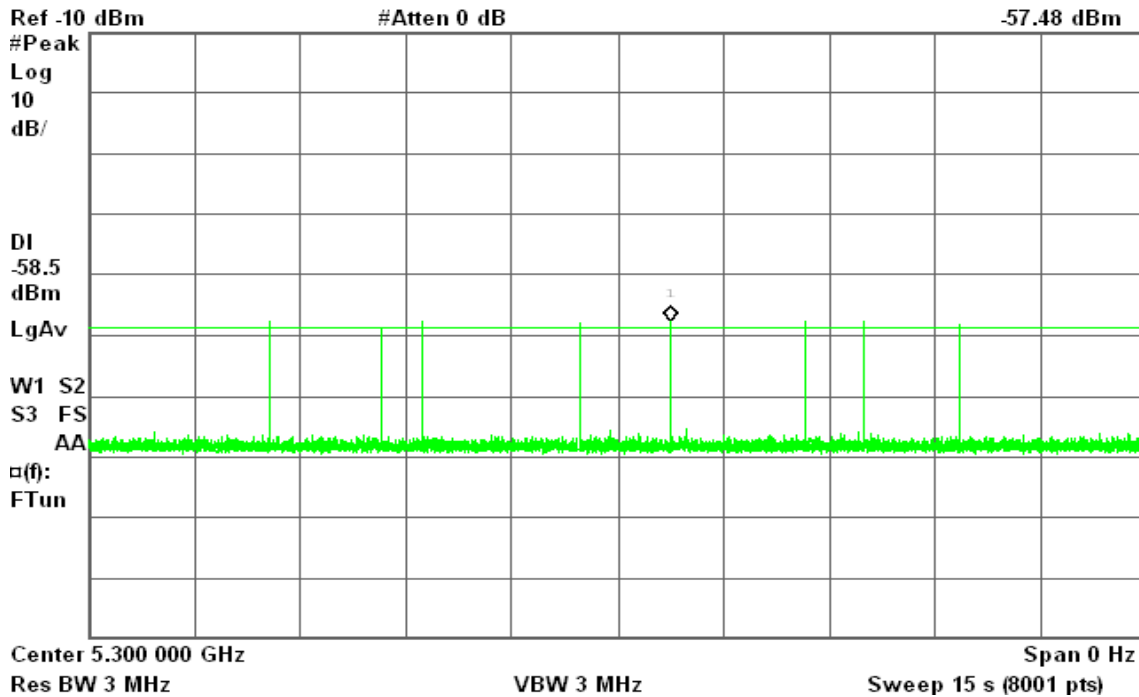

Sample of Frequency Hopping Radar Type 6

Agilent 13:49:57 Aug 11, 2012

T

Mkr1 5.29 ms
-58.35 dBm

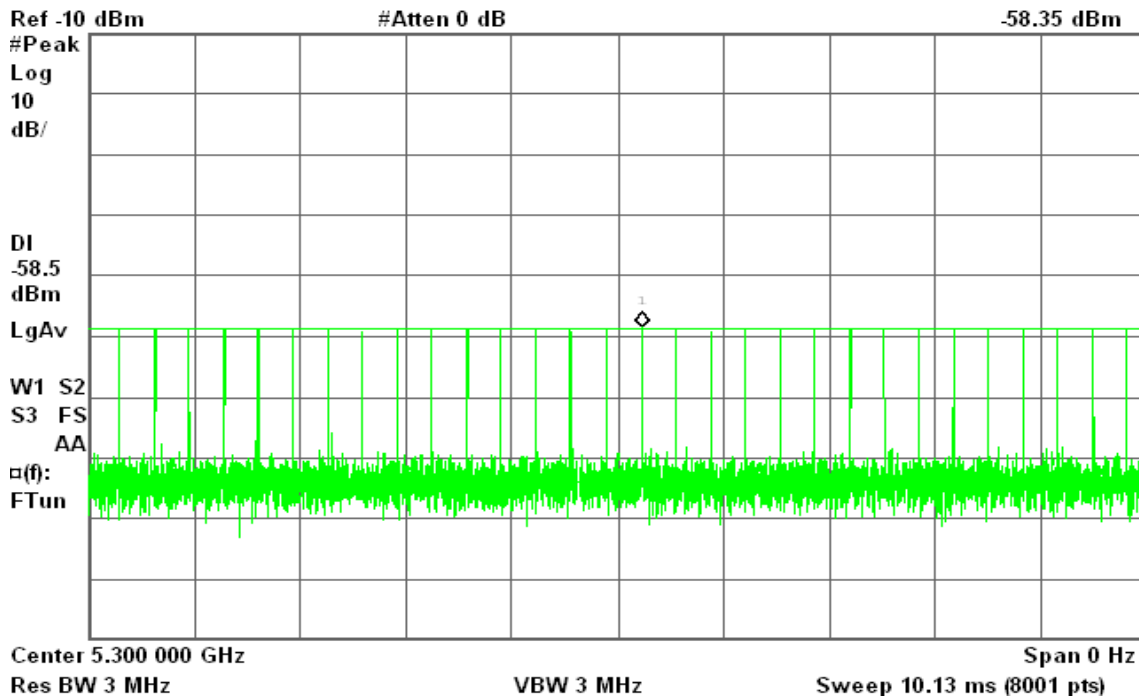



Plot of WLAN Traffic from Slave

Agilent 16:06:48 Aug 11, 2012

T

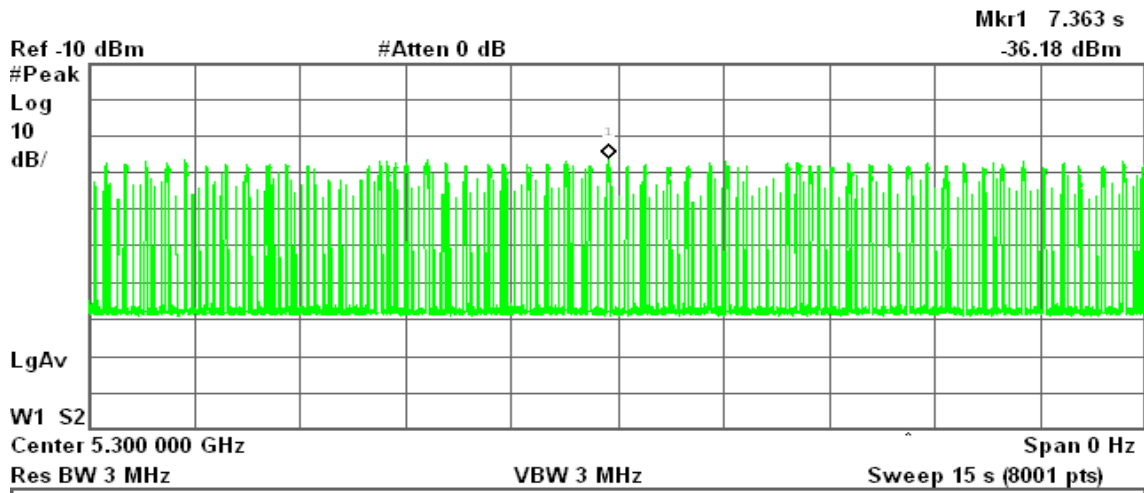

Marker	Trace	Type	X Axis	Amplitude
1	(1)	Time	7.363 s	-36.18 dBm



TEST CHANNEL AND METHOD

All tests were performed at a channel center frequency of 5500 MHz utilizing a conducted test method.

CHANNEL MOVE TIME AND CHANNEL CLOSING TRANSMISSION TIME

GENERAL REPORTING NOTES

The reference marker is set at the end of last radar pulse.

The delta marker is set at the end of the last WLAN transmission following the radar pulse. This delta is the channel move time.

The aggregate channel closing transmission time is calculated as follows:

Aggregate Transmission Time =

(Number of analyzer bins showing transmission) * (dwell time per bin)

The observation period over which the aggregate time is calculated

Begins at (Reference Marker + 200 msec) and

Ends no earlier than (Reference Marker + 10 sec).



UNII Band II

IEEE 802.11n HT 20 MHz mode

Type 1 Channel Move Time Results

No non-compliance noted.

Channel Move Time (s)	Limit (s)
1.785	10

Agilent 09:12:11 Aug 9, 2012

R T

Δ Mkr2 540 ms

-8.29 dB

Ref -10 dBm

#Atten 0 dB

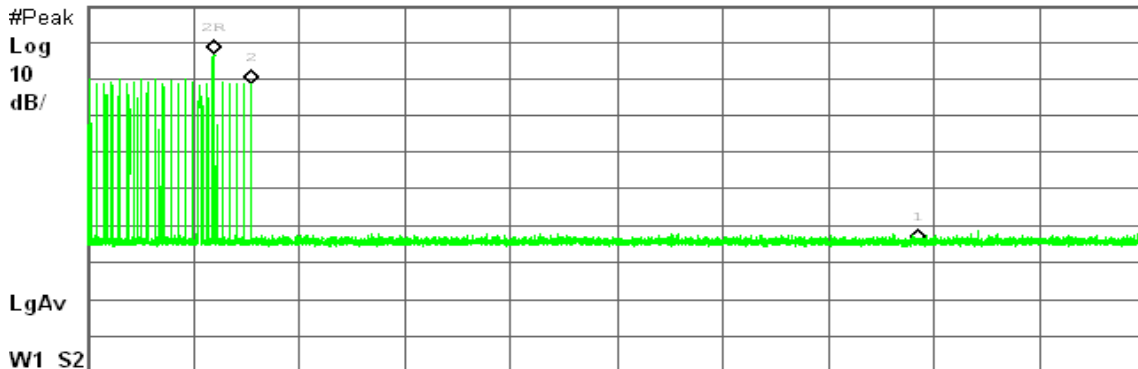

Center 5.300 000 GHz

Span 0 Hz

Res BW 3 MHz

VBW 3 MHz

Sweep 15 s (8001 pts)

Marker	Trace	Type	X Axis	Amplitude
1R	(1)	Time	1.785 s	-23.13 dBm
1Δ	(1)	Time	10 s	-51.65 dB
2R	(1)	Time	1.785 s	-23.13 dBm
2Δ	(1)	Time	540 ms	-8.29 dB



Type 5 Channel Move Time Results

Channel Move Time (s)	Limit (s)
1.522	10

Agilent 05:39:47 Aug 9, 2012

R T

Δ Mkr2 568.1 ms
-8.41 dB

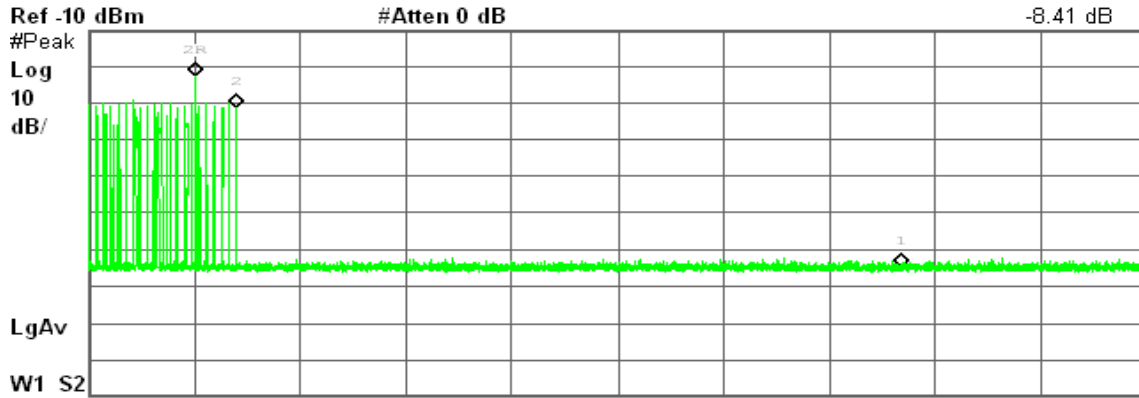

Center 5.300 000 GHz Span 0 Hz
Res BW 3 MHz VBW 3 MHz Sweep 15 s (8001 pts)

Marker	Trace	Type	X Axis	Amplitude
1R	(1)	Time	1.522 s	-22.72 dBm
1Δ	(1)	Time	10 s	-52.36 dB
2R	(1)	Time	1.522 s	-22.72 dBm
2Δ	(1)	Time	568.1 ms	-8.41 dB



IEEE 802.11n HT 40 MHz mode

Type 1 Channel Move Time Results

No non-compliance noted.

Channel Move Time (s)	Limit (s)
1.416	10

Agilent 12:13:56 Aug 9, 2012

R T

Δ Mkr2 605.6 ms
-17.76 dB

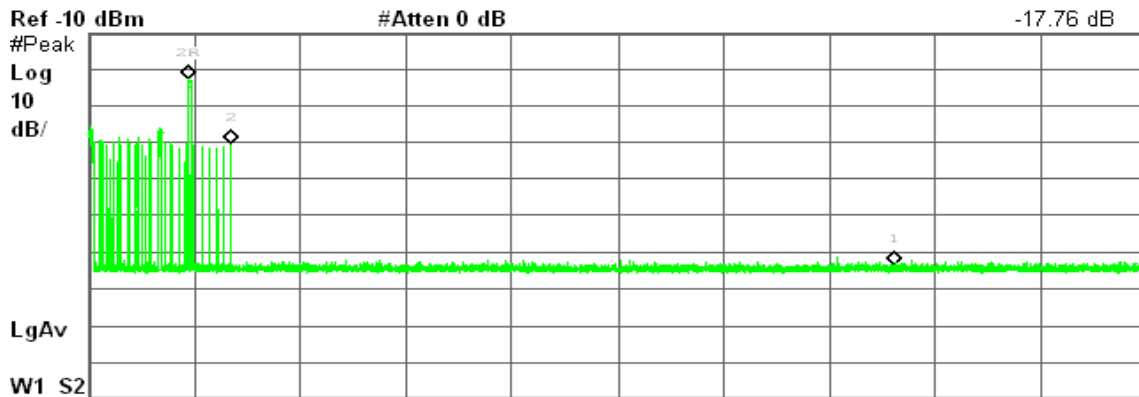

Center 5.310 000 GHz Span 0 Hz
Res BW 3 MHz VBW 3 MHz Sweep 15 s (8001 pts)

Marker	Trace	Type	X Axis	Amplitude
1R	(1)	Time	1.416 s	-22.76 dBm
1Δ	(1)	Time	10 s	-50.78 dB
2R	(1)	Time	1.416 s	-22.76 dBm
2Δ	(1)	Time	605.6 ms	-17.76 dB



Type 5 Channel Move Time Results

Channel Move Time (s)	Limit (s)
1.613	10

Agilent 08:22:31 Aug 9, 2012

R T

Δ Mkr2 575.6 ms
-23.59 dB

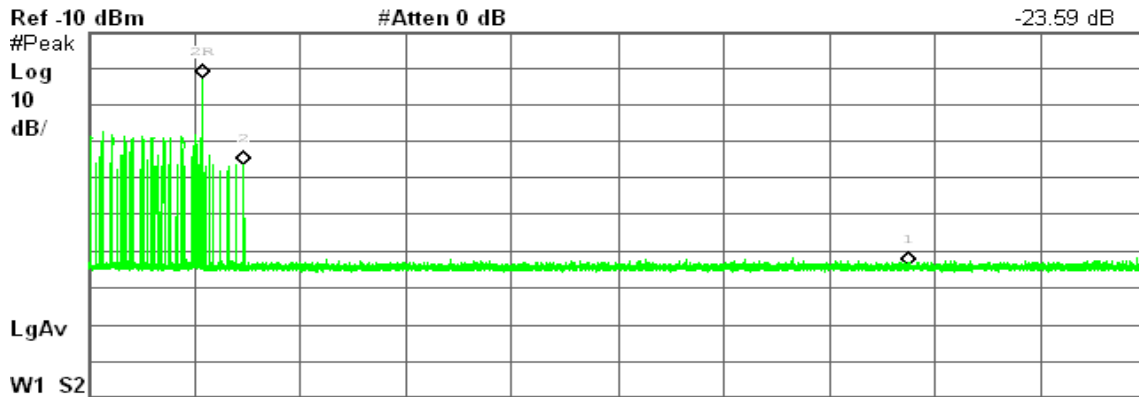

Center 5.310 000 GHz Span 0 Hz
Res BW 3 MHz VBW 3 MHz Sweep 15 s (8001 pts)

Marker	Trace	Type	X Axis	Amplitude
1R	(1)	Time	1.613 s	-22.68 dBm
1Δ	(1)	Time	10 s	-51.40 dB
2R	(1)	Time	1.613 s	-22.68 dBm
2Δ	(1)	Time	575.6 ms	-23.59 dB



IEEE 802.11n HT 20 MHz mode

Type 1 Channel Closing Transmission Time Results

No non-compliance noted.

Aggregate Transmission Time (ms)	Limit (ms)	Margin (ms)
16.87	60	-43.13

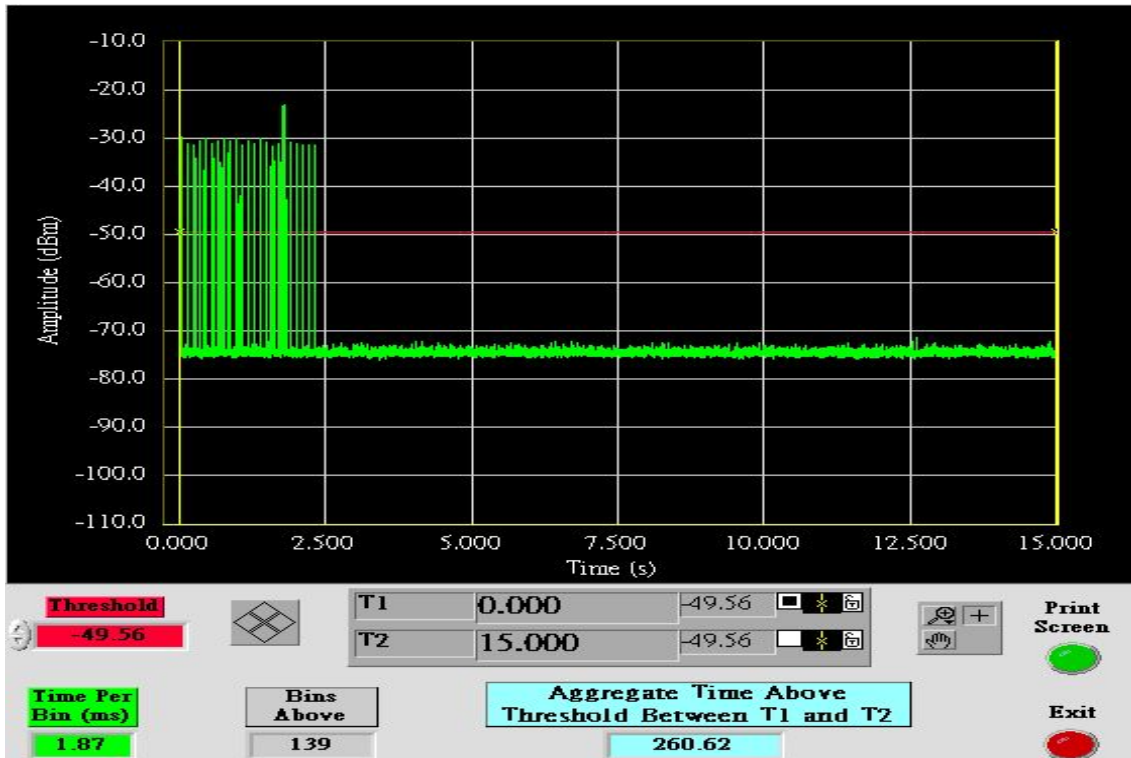

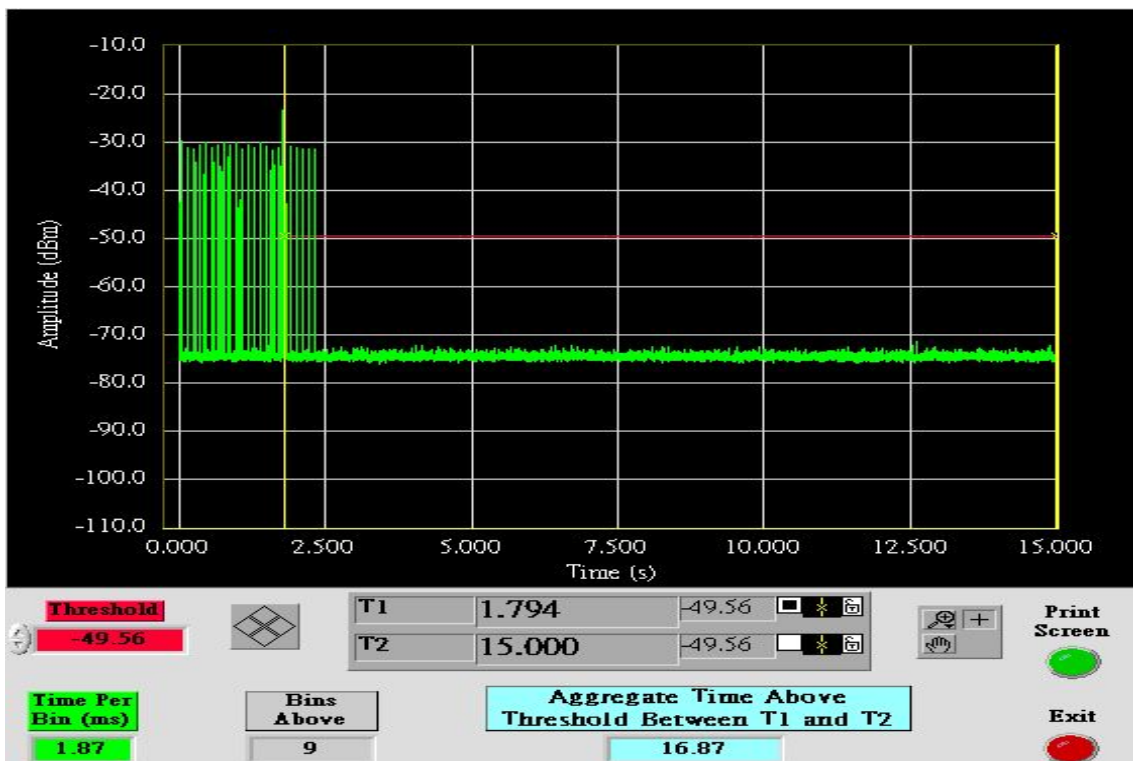
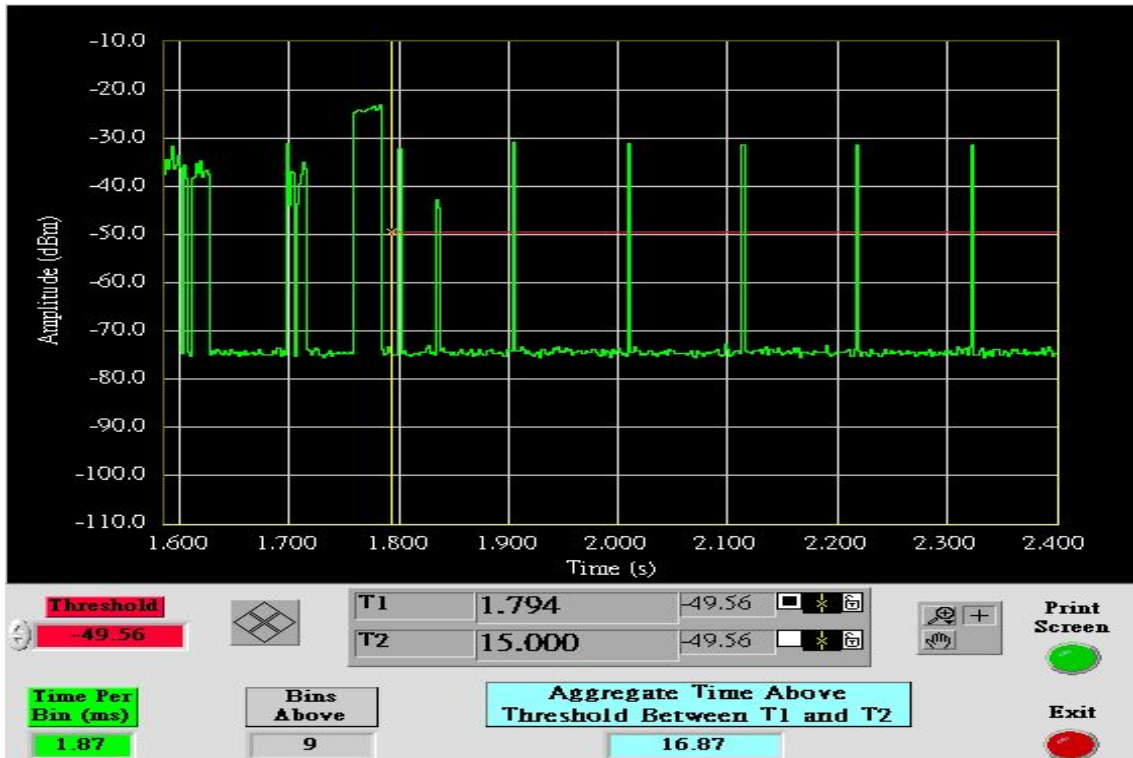



Type 5 Channel Closing Transmission Time Results

Aggregate Transmission Time (ms)	Limit (ms)	Margin (ms)
20.62	60	-39.38

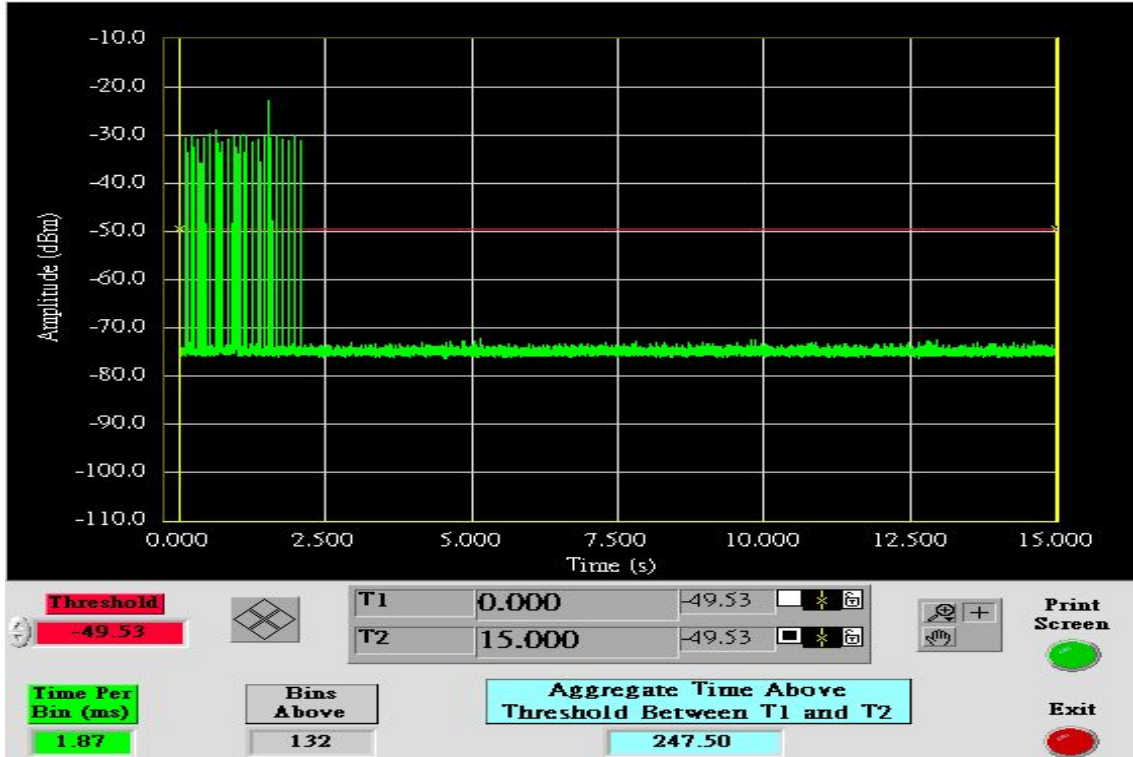

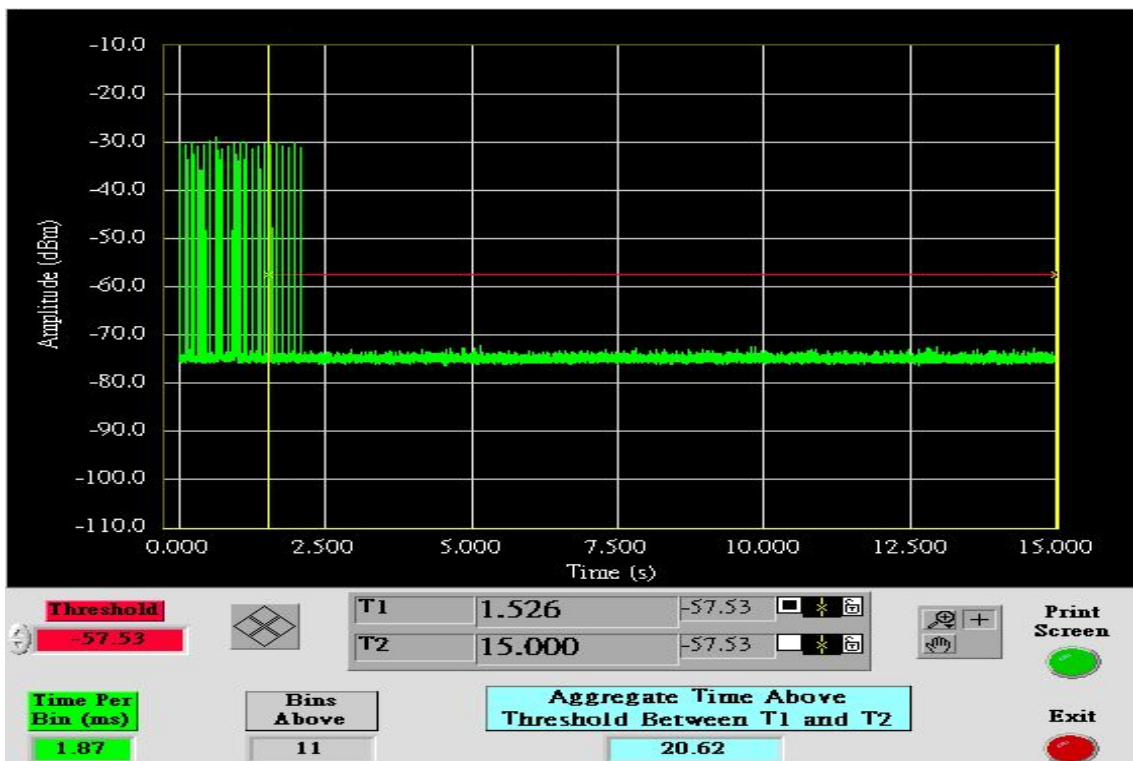
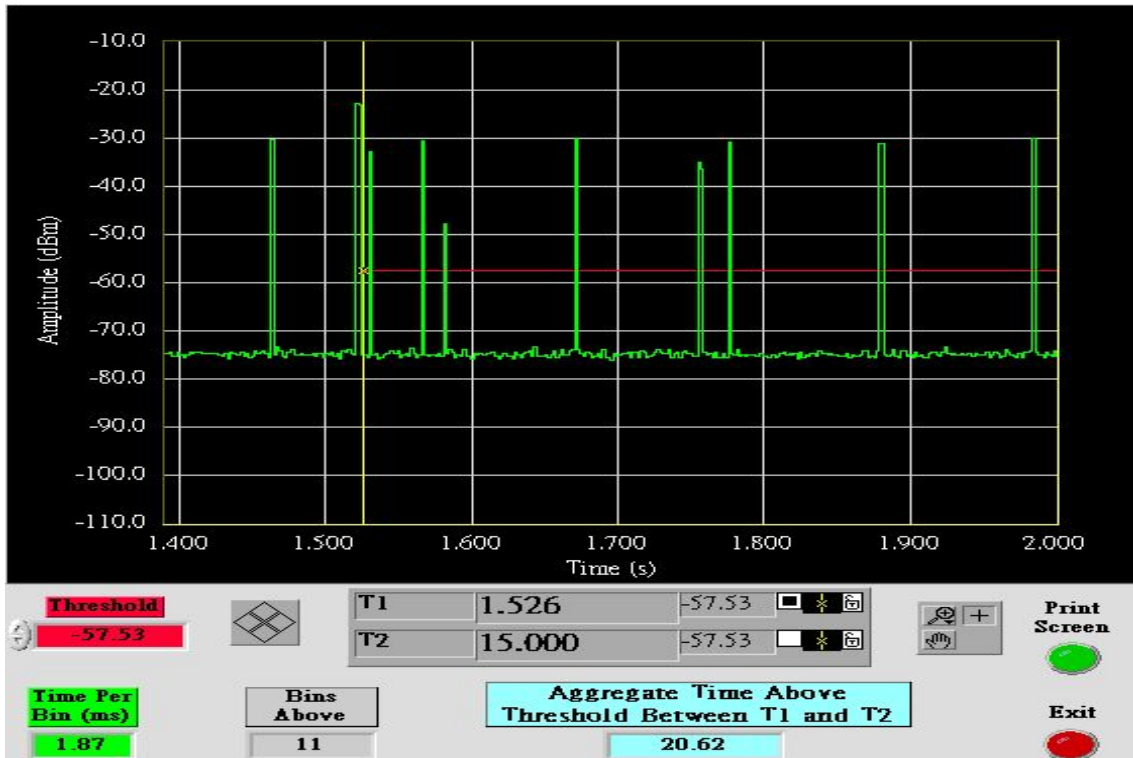



IEEE 802.11n HT 40 MHz mode

Type 1 Channel Closing Transmission Time Results

No non-compliance noted.

Aggregate Transmission Time (ms)	Limit (ms)	Margin (ms)
13.12	60	-46.88

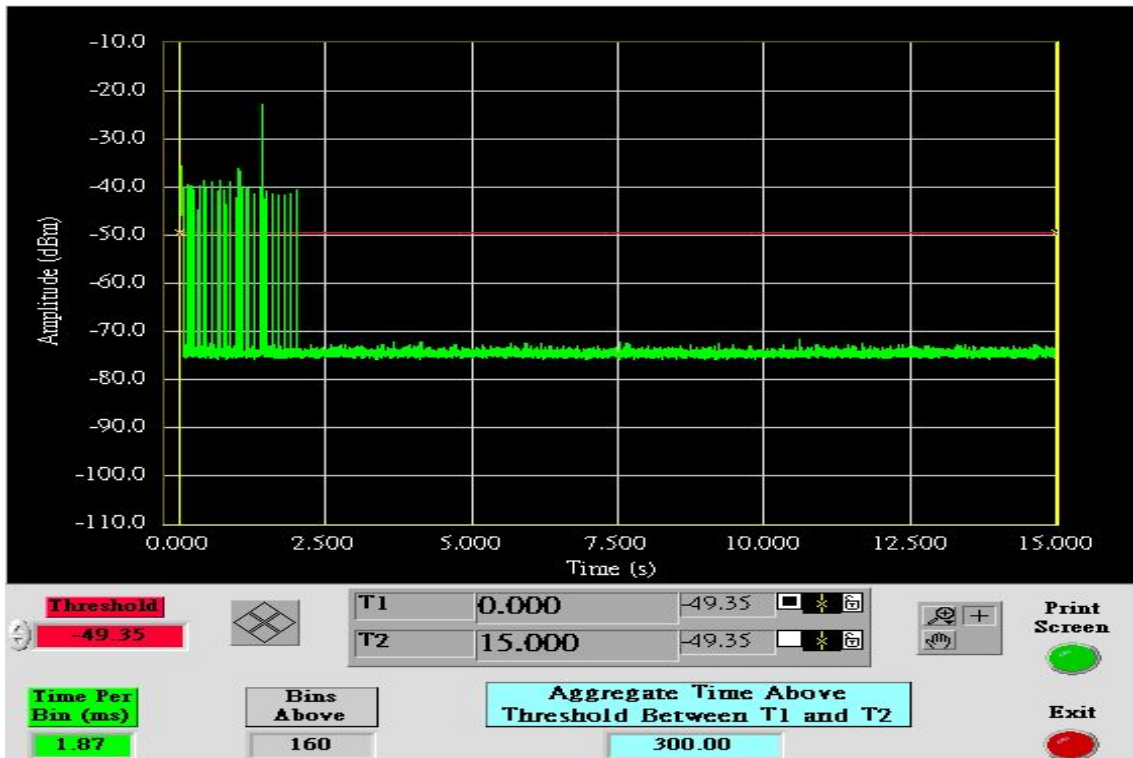

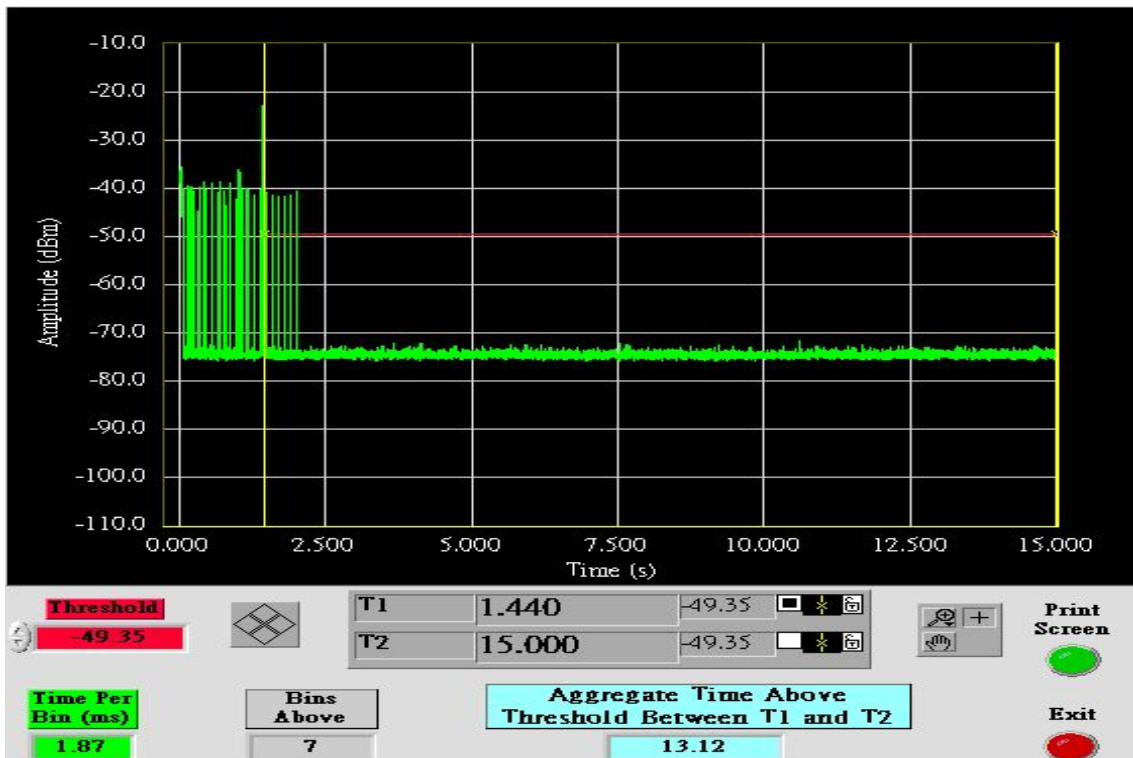
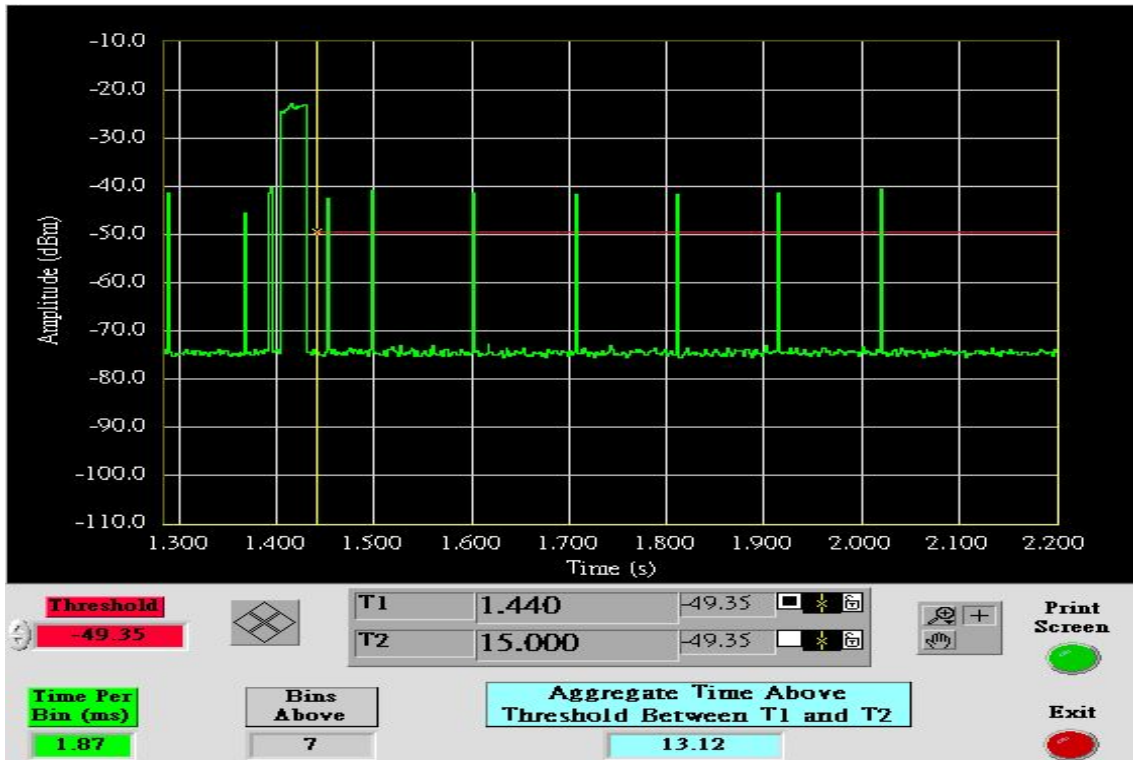



Type 5 Channel Closing Transmission Time Results

Aggregate Transmission Time (ms)	Limit (ms)	Margin (ms)
18.75	60	-41.25

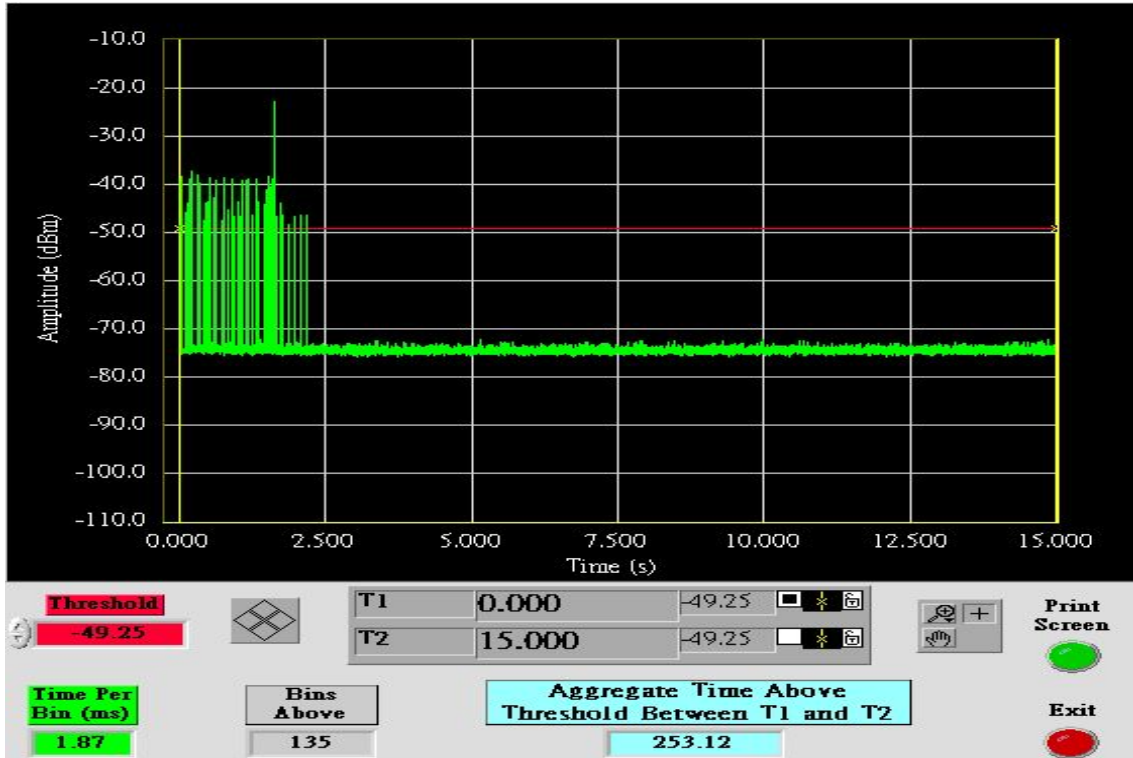

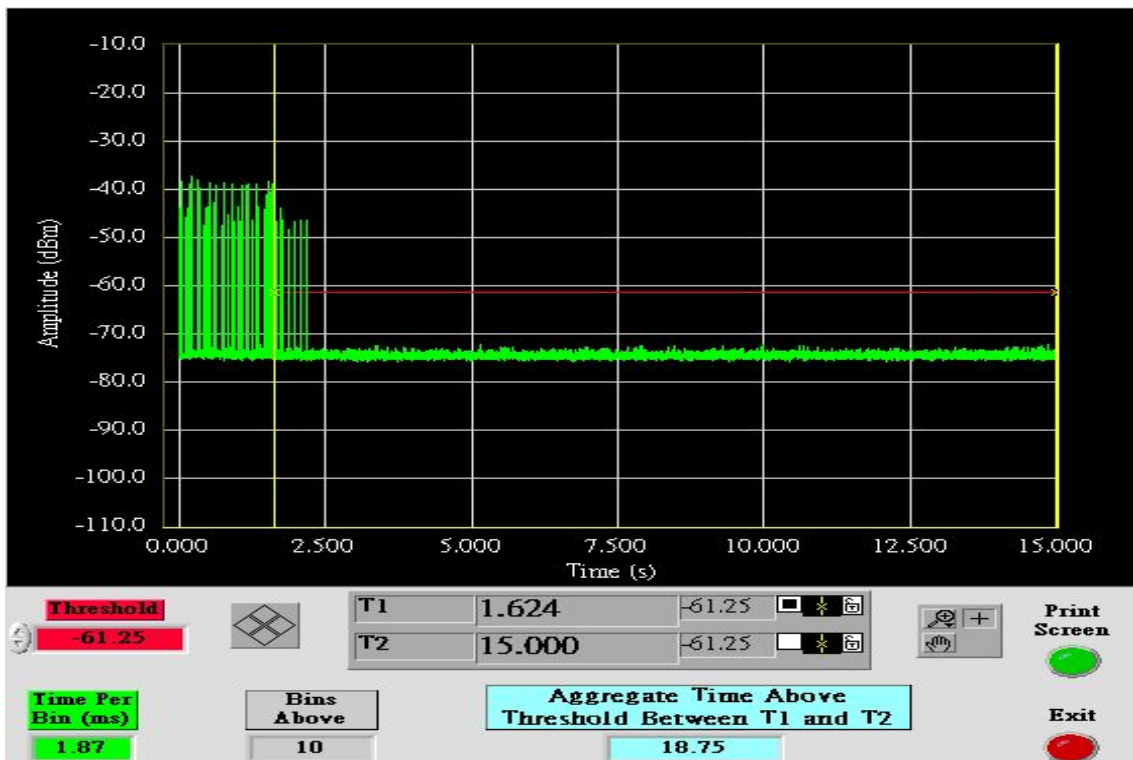
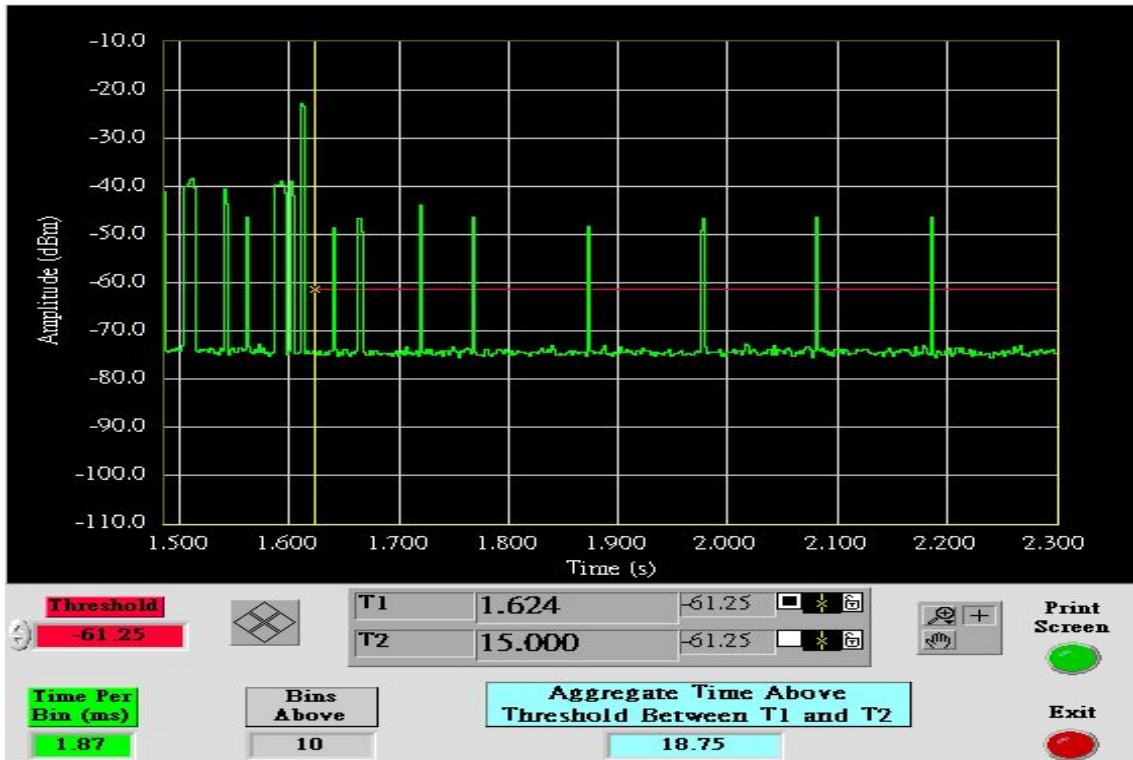



UNII Band III

IEEE 802.11n HT 20 MHz mode

Type 1 Channel Move Time Results

No non-compliance noted.

Channel Move Time (s)	Limit (s)
1.785	10

Agilent 09:12:11 Aug 9, 2012

R T

Δ Mkr2 540 ms
-8.29 dB

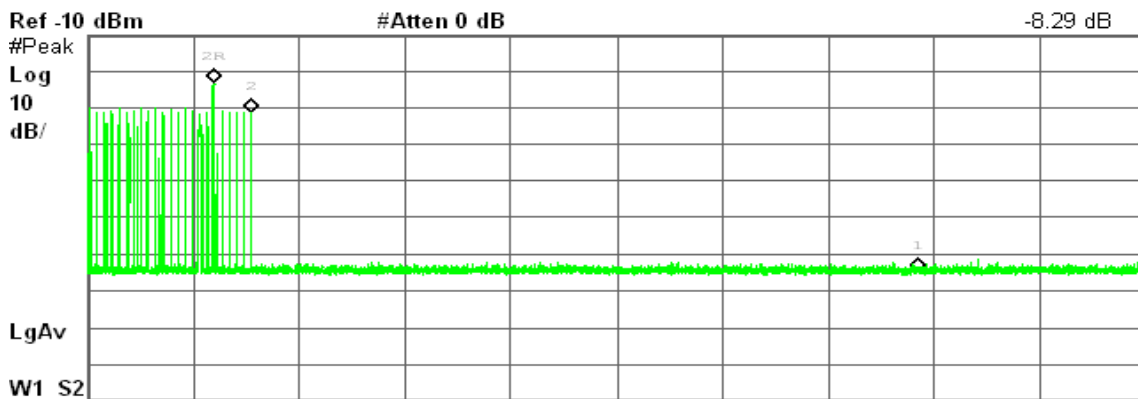

Center 5.300 000 GHz Span 0 Hz
 Res BW 3 MHz VBW 3 MHz Sweep 15 s (8001 pts)

Marker	Trace	Type	X Axis	Amplitude
1R	(1)	Time	1.785 s	-23.13 dBm
1Δ	(1)	Time	10 s	-51.65 dB
2R	(1)	Time	1.785 s	-23.13 dBm
2Δ	(1)	Time	540 ms	-8.29 dB



Type 1 Channel Move Time Results

Channel Move Time (s)	Limit (s)
1.522	10

Agilent 05:39:47 Aug 9, 2012

R T

Δ Mkr2 568.1 ms
-8.41 dB

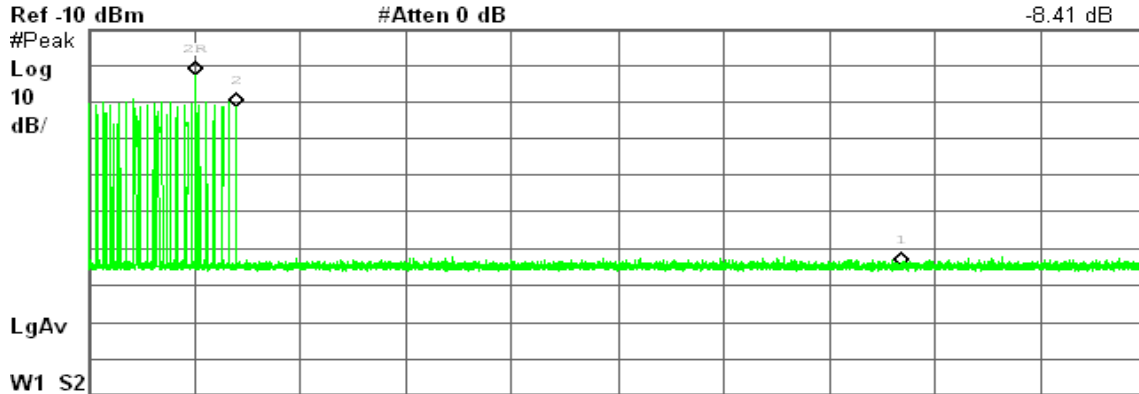

Center 5.300 000 GHz Span 0 Hz
Res BW 3 MHz VBW 3 MHz Sweep 15 s (8001 pts)

Marker	Trace	Type	X Axis	Amplitude
1R	(1)	Time	1.522 s	-22.72 dBm
1Δ	(1)	Time	10 s	-52.36 dB
2R	(1)	Time	1.522 s	-22.72 dBm
2Δ	(1)	Time	568.1 ms	-8.41 dB



IEEE 802.11n HT 40 MHz mode

Type 1 Channel Move Time Results

No non-compliance noted.

Channel Move Time (s)	Limit (s)
1.382	10

Agilent 12:03:55 Aug 9, 2012

R T

Δ Mkr2 611.3 ms

-21.04 dB

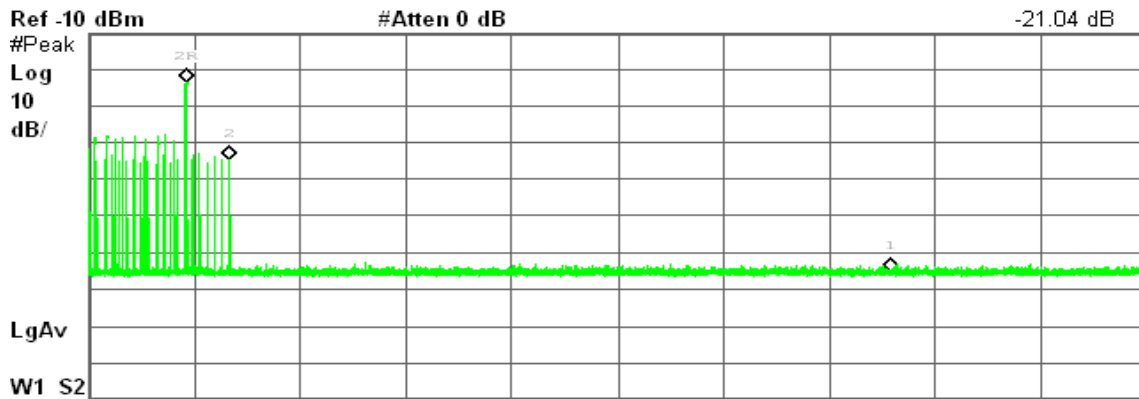

Marker	Trace	Type	X Axis	Amplitude
1R	(1)	Time	1.382 s	-23.46 dBm
1Δ	(1)	Time	10 s	-51.70 dB
2R	(1)	Time	1.382 s	-23.46 dBm
2Δ	(1)	Time	611.3 ms	-21.04 dB



Type 5 Channel Move Time Results

Channel Move Time (s)	Limit (s)
1.545	10

Agilent 07:31:57 Aug 9, 2012

R T

Δ Mkr2 601.9 ms
-19.70 dB

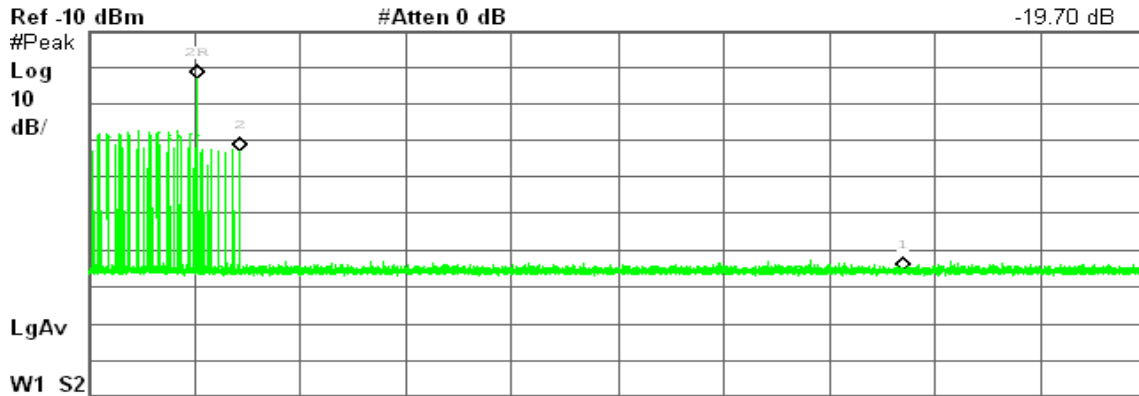

Start 5.510 000 GHz Stop 5.510 000 GHz
 Res BW 3 MHz VBW 3 MHz Sweep 15 s (8001 pts)

Marker	Trace	Type	X Axis	Amplitude
1R	(1)	Time	1.545 s	-23.10 dBm
1Δ	(1)	Time	10 s	-52.66 dB
2R	(1)	Time	1.545 s	-23.10 dBm
2Δ	(1)	Time	601.9 ms	-19.70 dB



IEEE 802.11n HT 20 MHz mode

Type 1 Channel Closing Transmission Time Results

No non-compliance noted.

Aggregate Transmission Time (ms)	Limit (ms)	Margin (ms)
18.75	60	-41.25

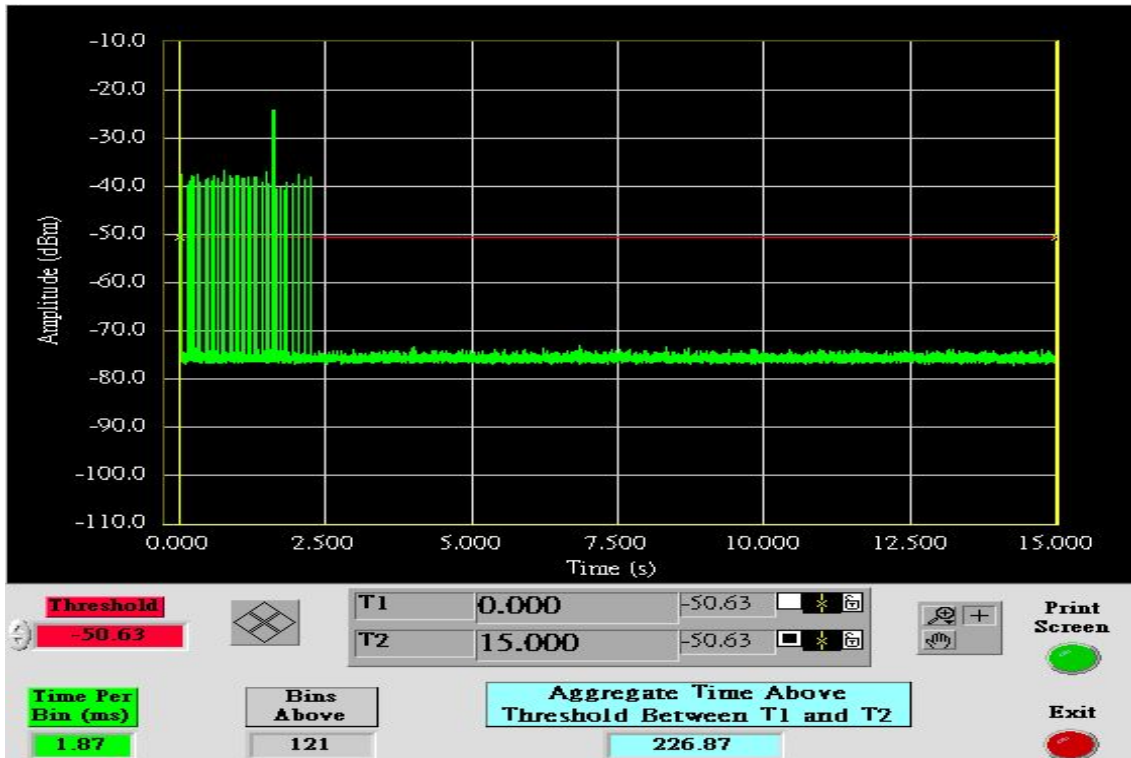

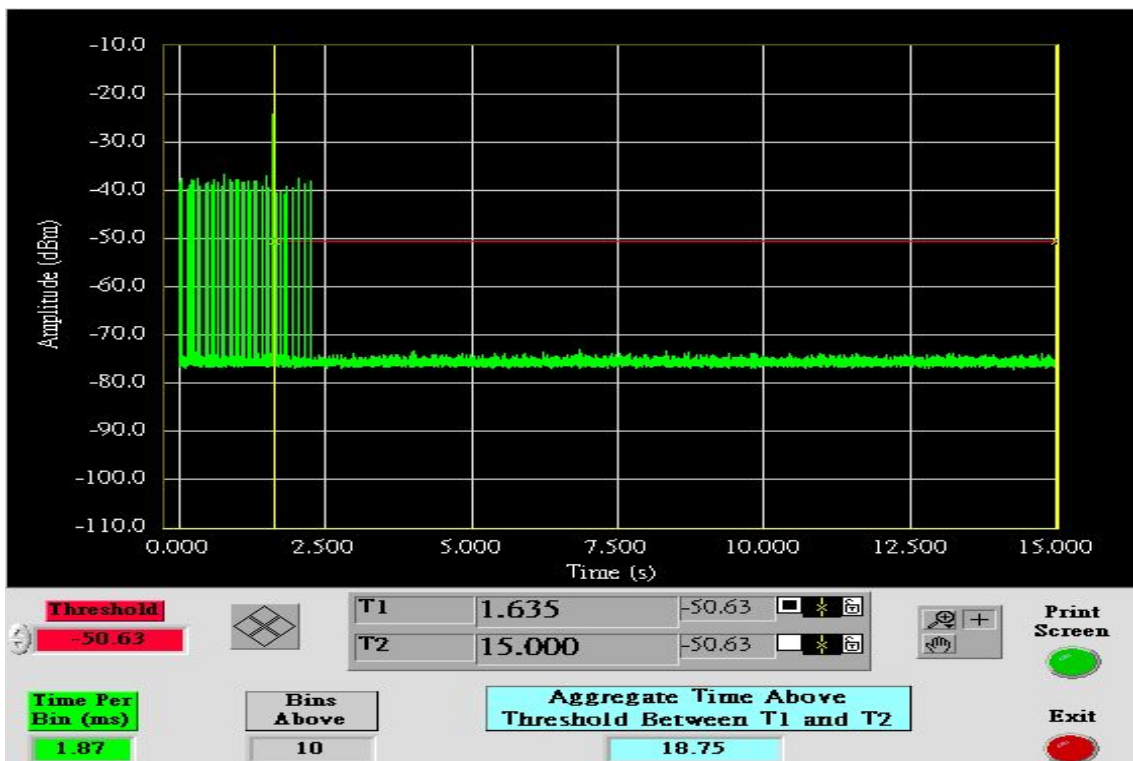
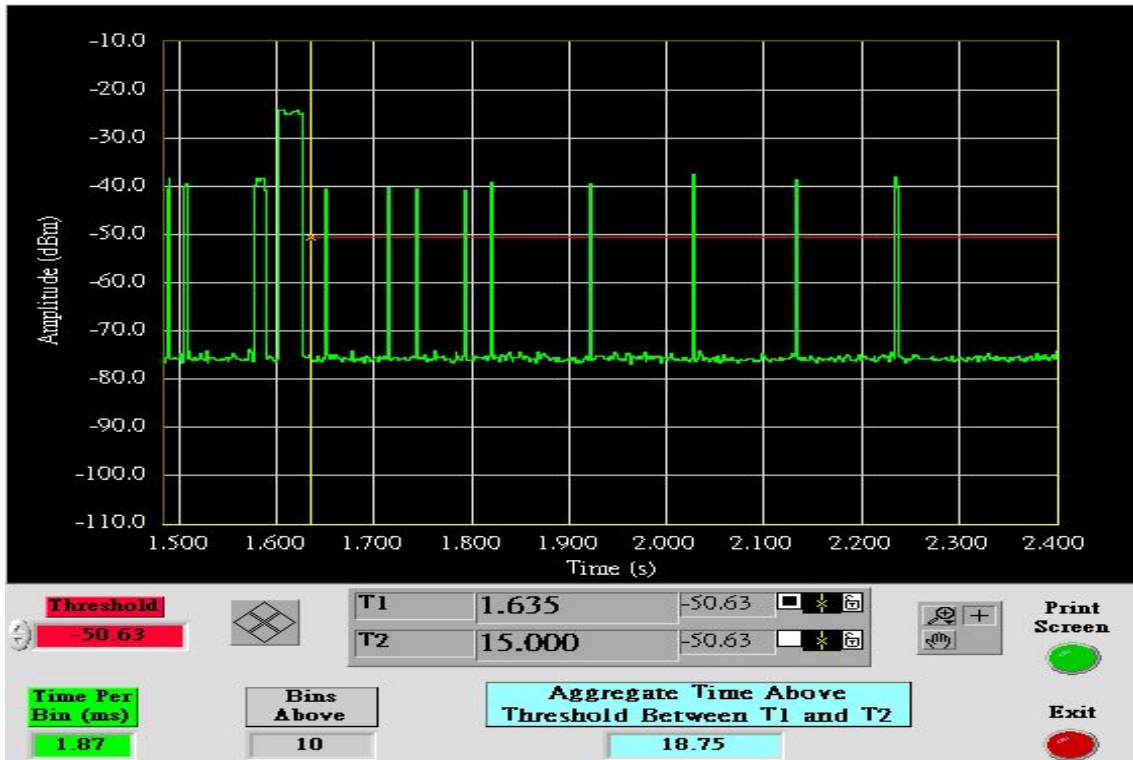



Type 5 Channel Closing Transmission Time Results

Aggregate Transmission Time (ms)	Limit (ms)	Margin (ms)
20.62	60	-39.38

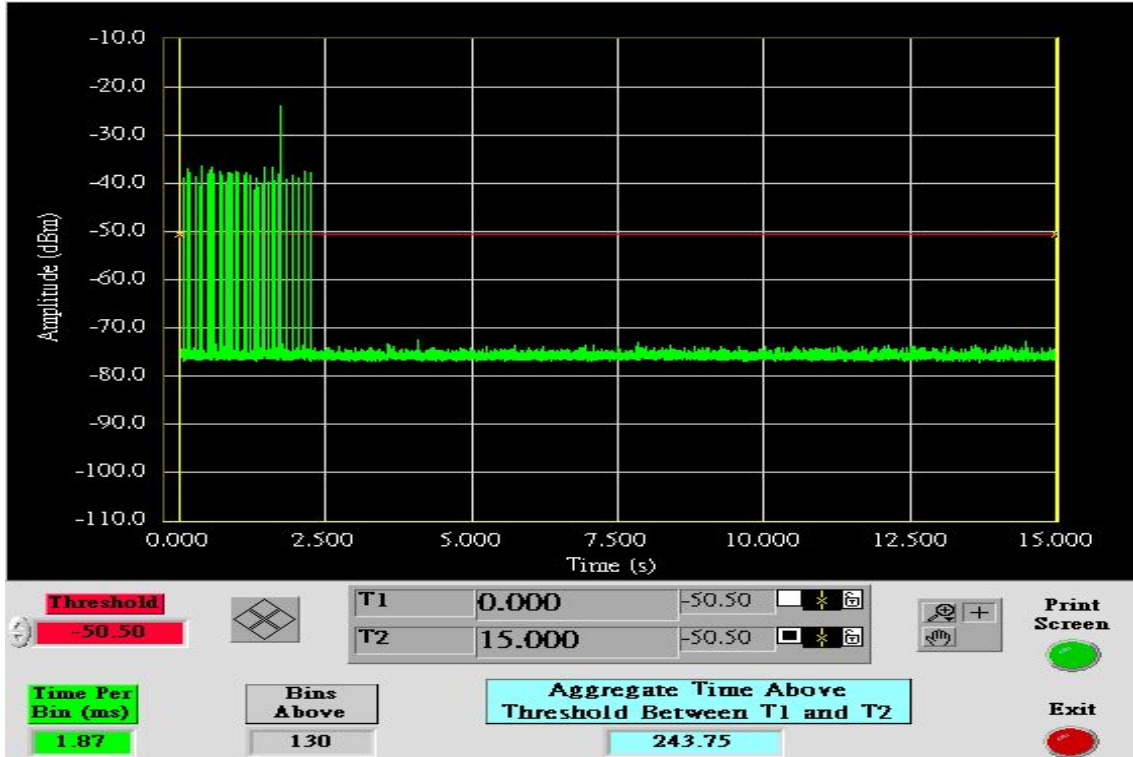

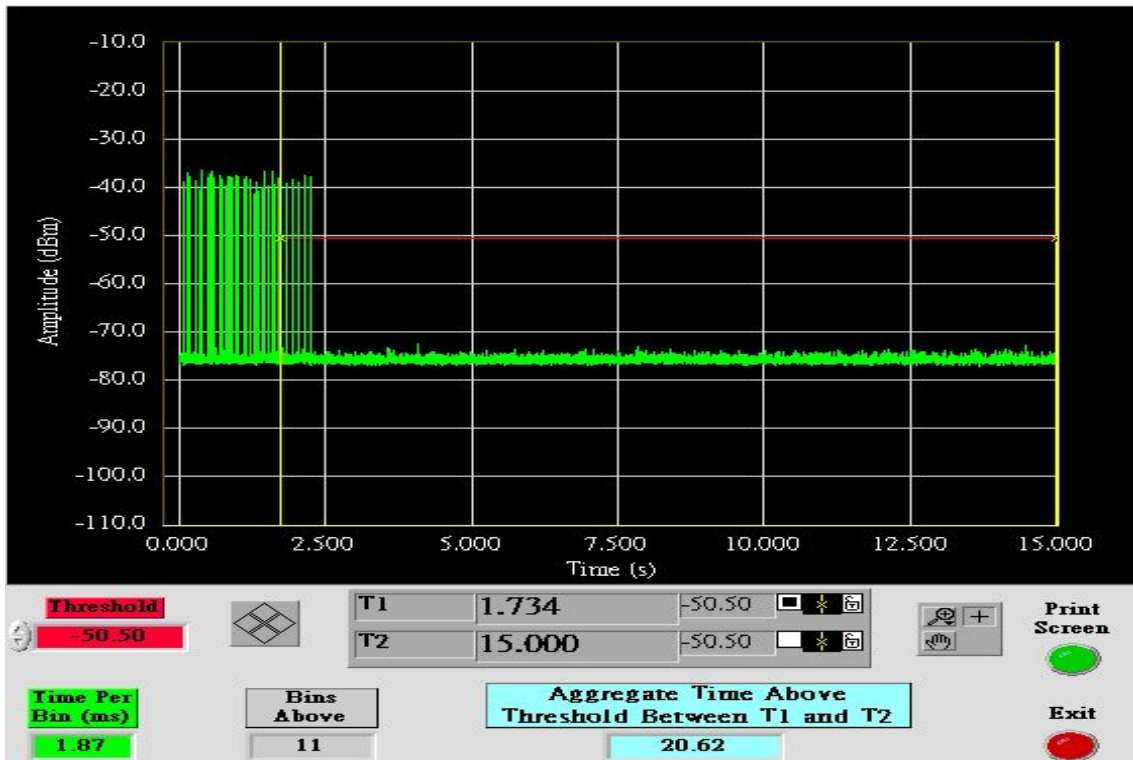
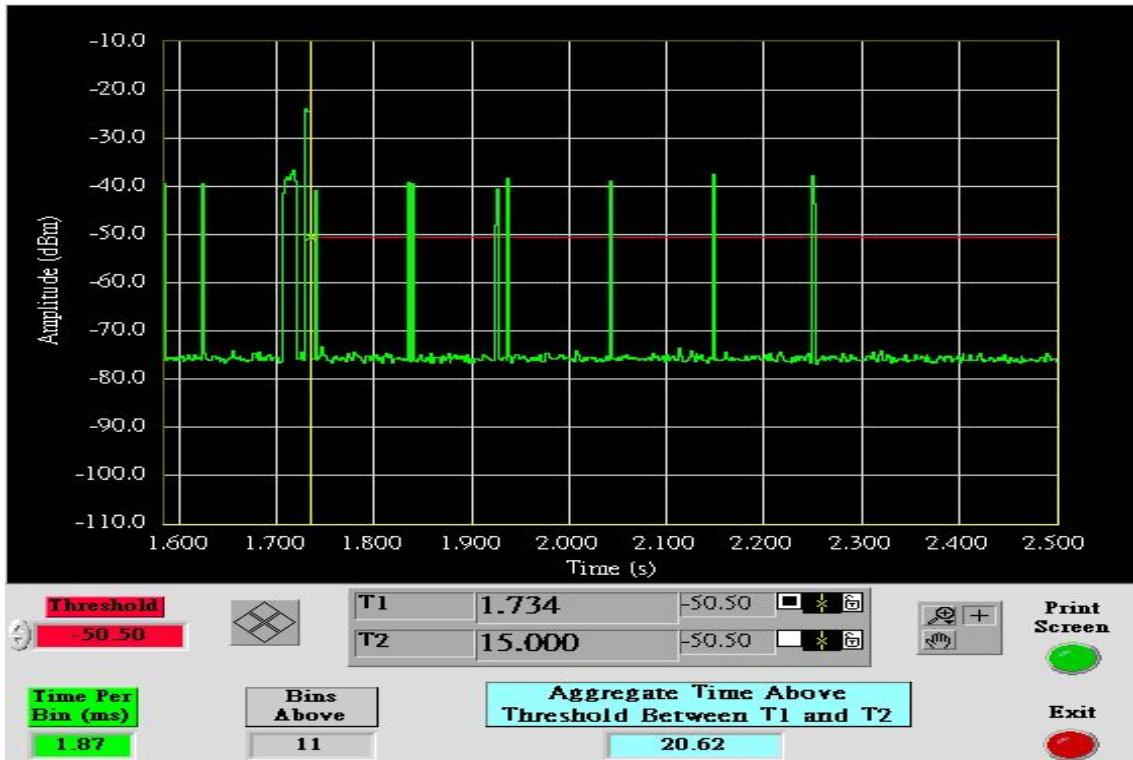



IEEE 802.11n HT 40 MHz mode

Type 1 Channel Closing Transmission Time Results

No non-compliance noted.

Aggregate Transmission Time (ms)	Limit (ms)	Margin (ms)
15	60	-45

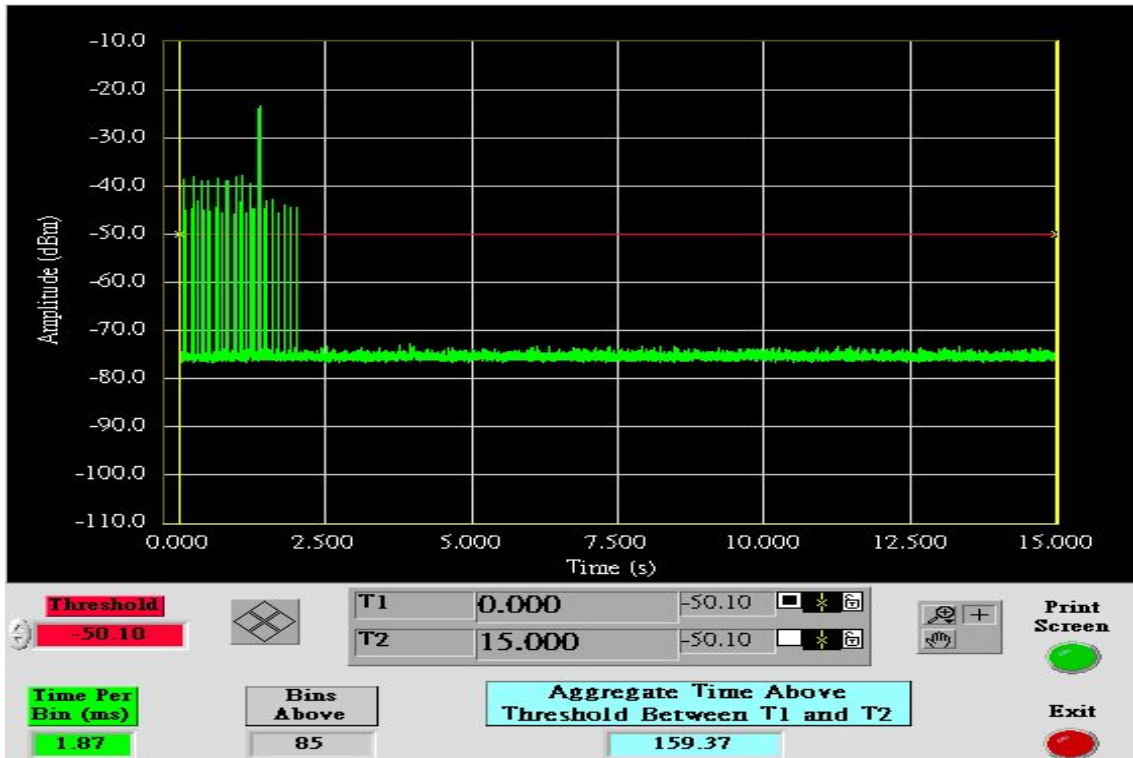

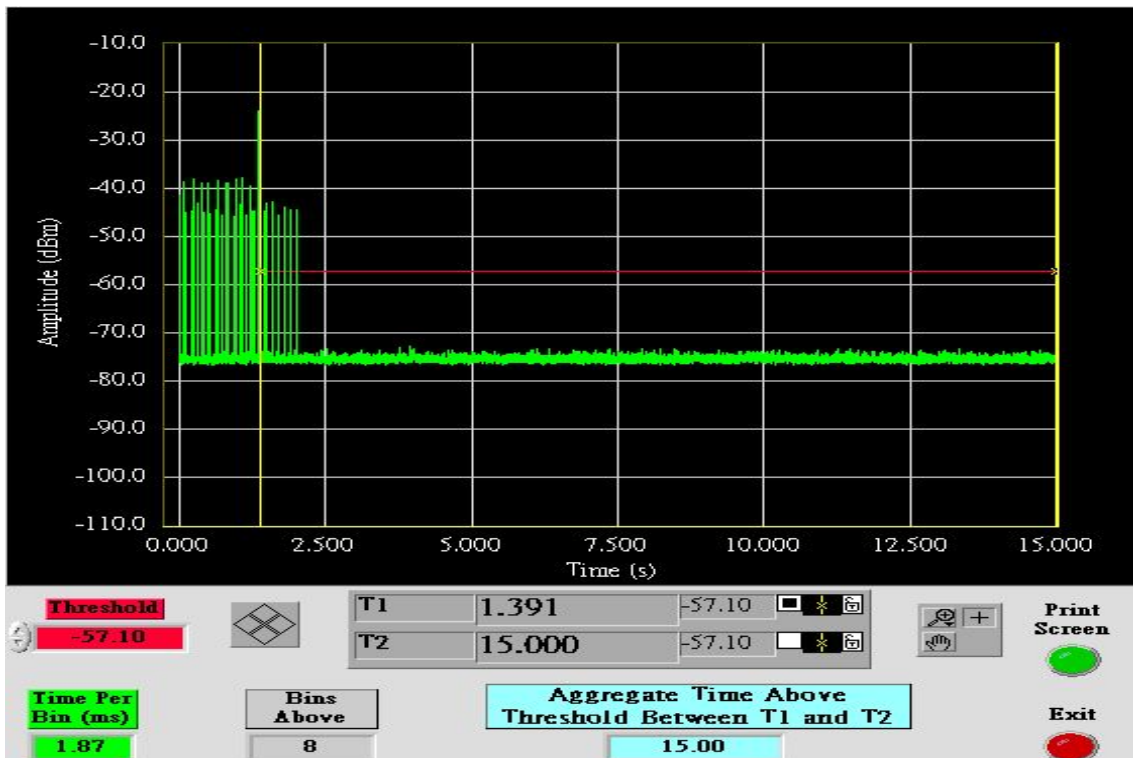
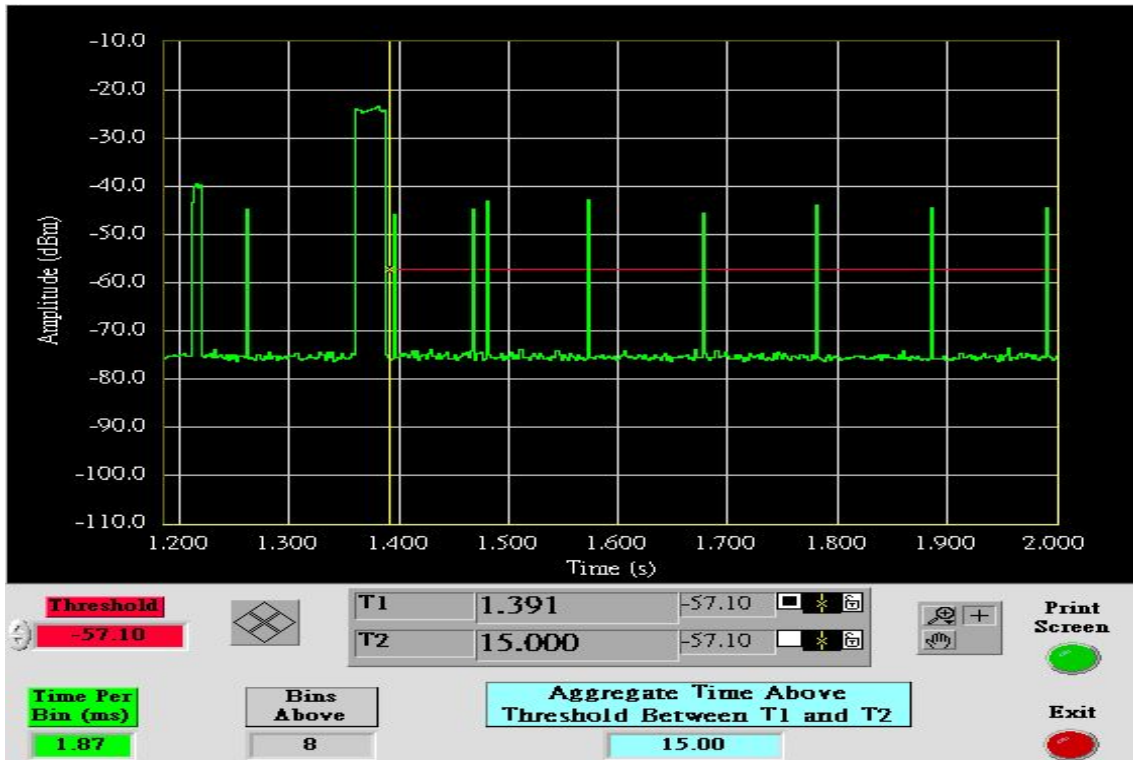



Type 5 Channel Closing Transmission Time Results

Aggregate Transmission Time (ms)	Limit (ms)	Margin (ms)
16.87	60	-43.13

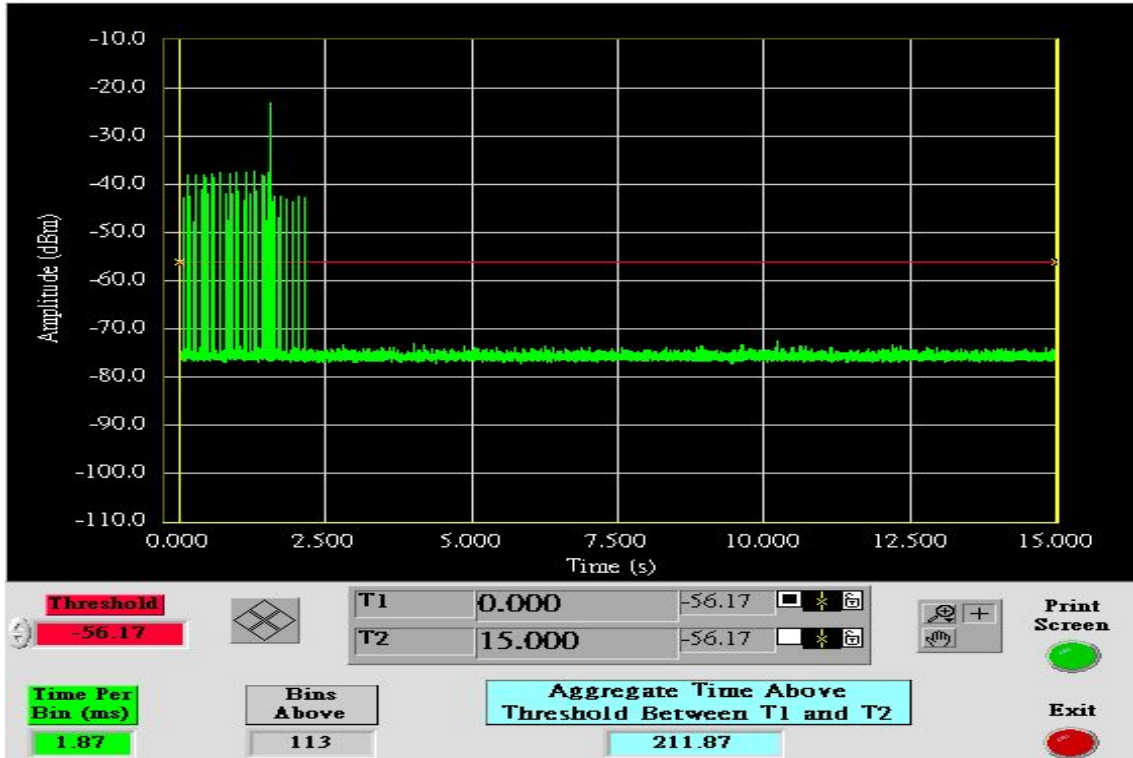

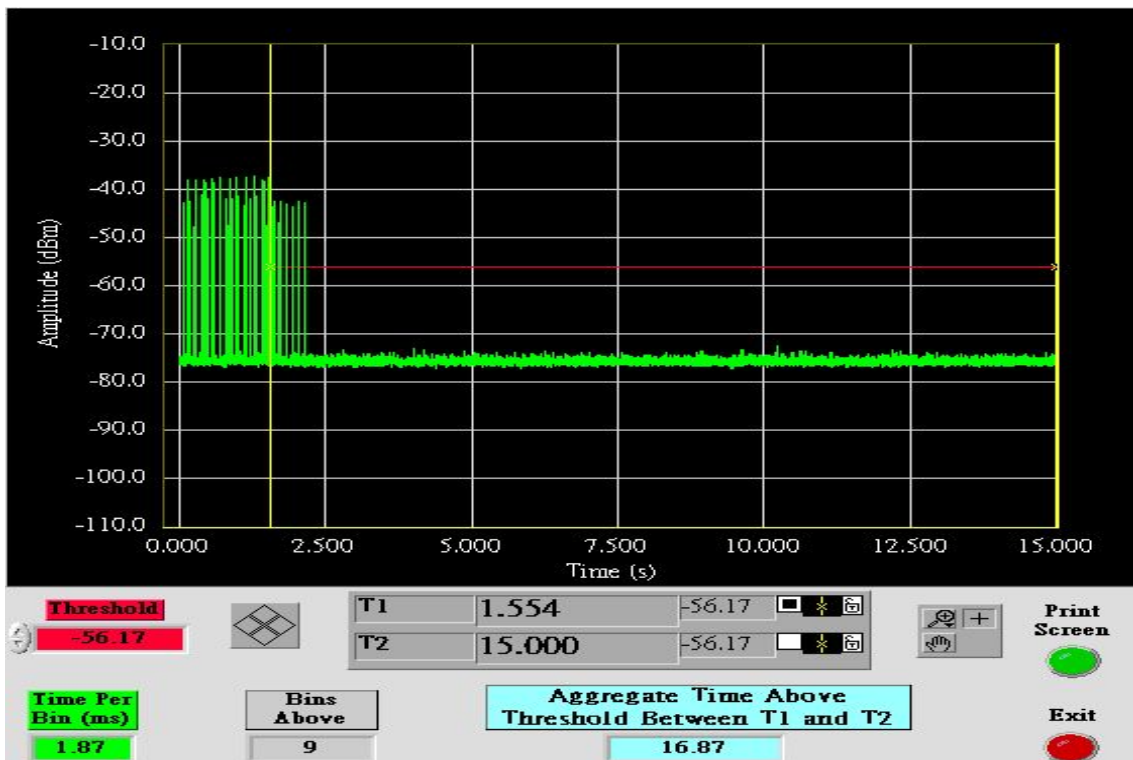
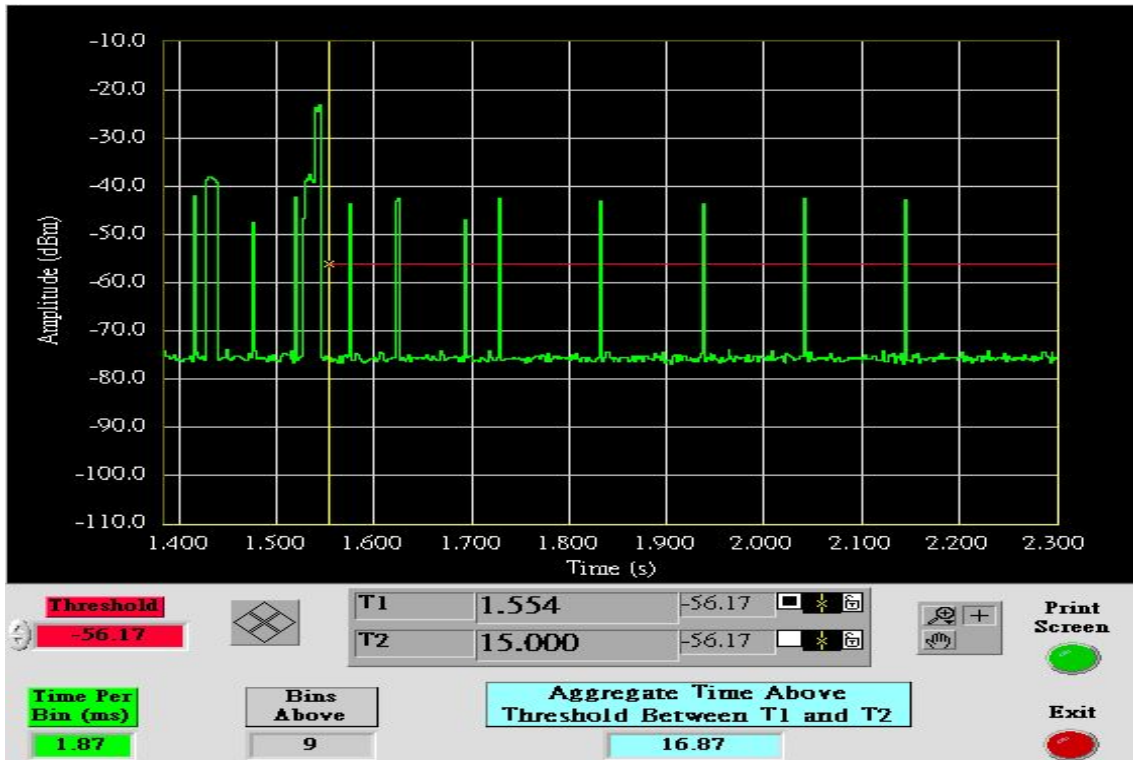



Non-Occupancy Period

UNII Band II

IEEE 802.11n HT 20 MHz mode

Type 1 Non-Occupancy Period Test Results

No non-compliance noted.

No EUT transmissions were observed on the test channel during the 30 minute observation time.

Agilent 09:58:27 Aug 9, 2012

R T

Δ Mkr1 1.8 ks

-49.80 dB

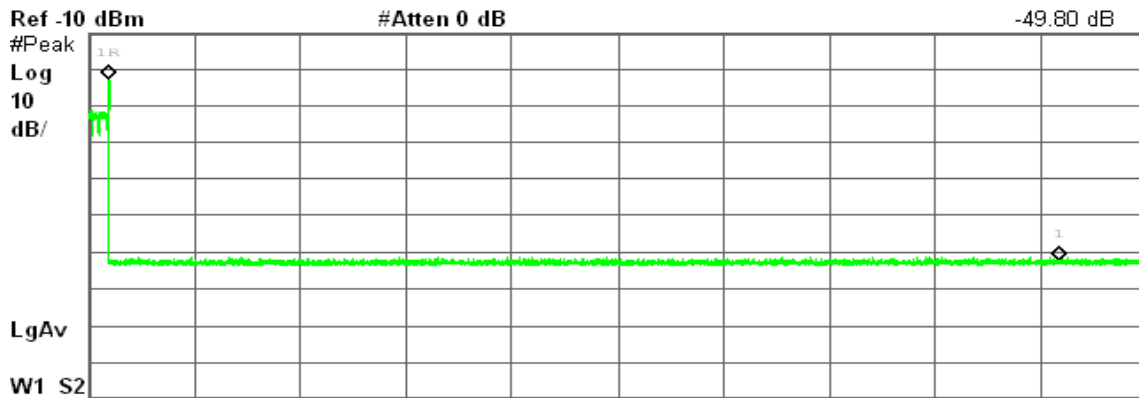

Center 5.300 000 GHz

Span 0 Hz

Res BW 3 MHz

VBW 3 MHz

Sweep 2 ks (8001 pts)

Marker	Trace	Type	X Axis	Amplitude
1R	(1)	Time	36.5 s	-22.76 dBm
1Δ	(1)	Time	1.8 ks	-49.80 dB



Type 5 Non-Occupancy Period Test Results

No non-compliance noted.

No EUT transmissions were observed on the test channel during the 30 minute observation time.

Agilent 06:20:28 Aug 9, 2012

R T

Δ Mkr1 1.8 ks

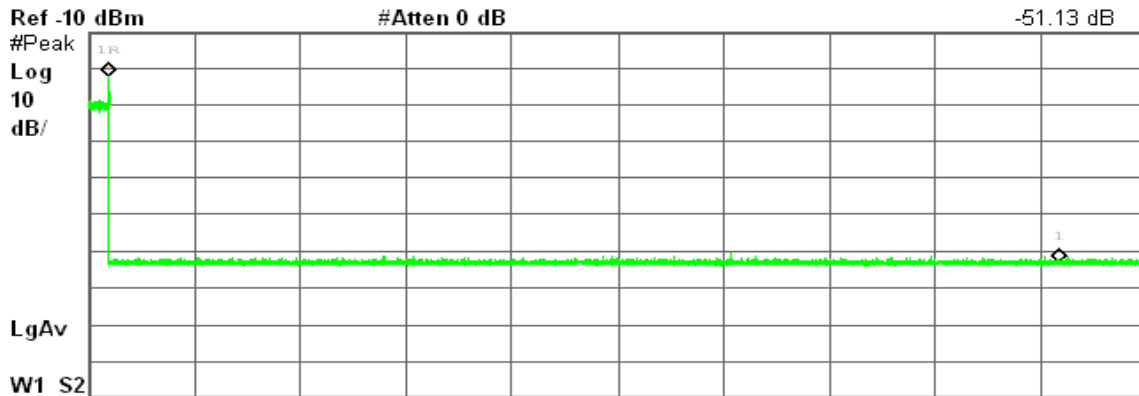

Center 5.300 000 GHz Span 0 Hz
Res BW 3 MHz VBW 3 MHz Sweep 2 ks (8001 pts)

Marker	Trace	Type	X Axis	Amplitude
1R	(1)	Time	36.25 s	-22.24 dBm
1Δ	(1)	Time	1.8 ks	-51.13 dB



IEEE 802.11n HT 40 MHz mode mode

Type 1 Non-Occupancy Period Test Results

No non-compliance noted.

No EUT transmissions were observed on the test channel during the 30 minute observation time.

Agilent 12:57:43 Aug 9, 2012

R T

Δ Mkr1 1.8 ks

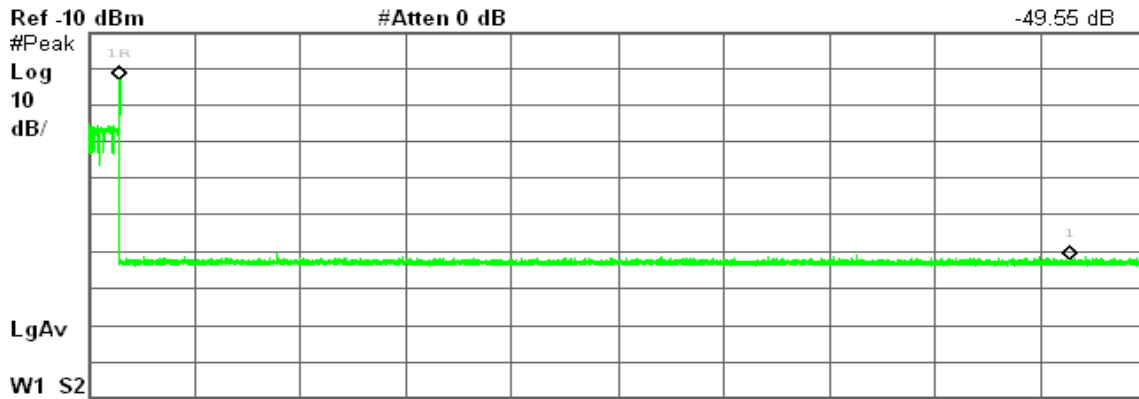

Marker	Trace	Type	X Axis	Amplitude
1R	(1)	Time	56.25 s	-22.99 dBm
1Δ	(1)	Time	1.8 ks	-49.55 dB



Type 5 Non-Occupancy Period Test Results

No non-compliance noted.

No EUT transmissions were observed on the test channel during the 30 minute observation time.

Agilent 09:07:20 Aug 9, 2012

R T

Δ Mkr1 1.8 ks

-51.42 dB

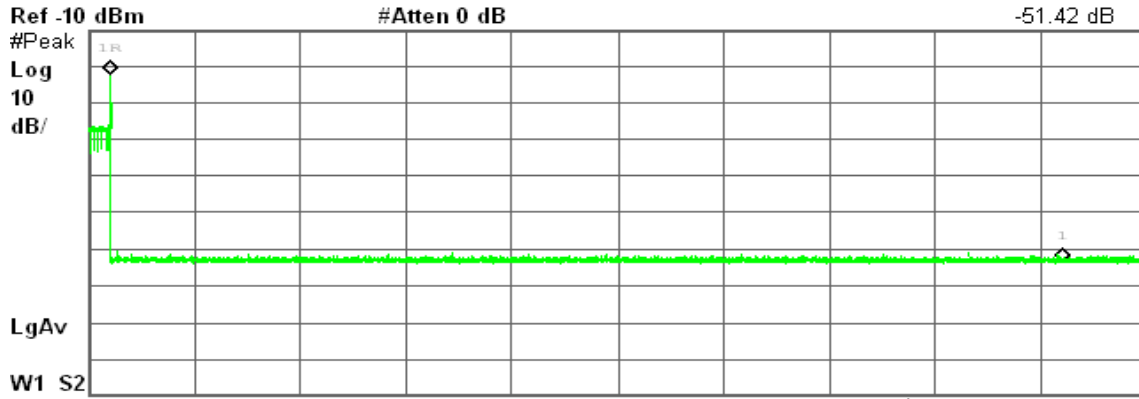

Center 5.310 000 GHz

Span 0 Hz

Res BW 3 MHz

VBW 3 MHz

Sweep 2 ks (8001 pts)

Marker	Trace	Type	X Axis	Amplitude
1R	(1)	Time	40.75 s	-22.16 dBm
1Δ	(1)	Time	1.8 ks	-51.42 dB



Non-Occupancy Period

UNII Band III

IEEE 802.11n HT 20 MHz mode

Type 1 Non-Occupancy Period Test Results

No non-compliance noted.

No EUT transmissions were observed on the test channel during the 30 minute observation time.

Agilent 10:52:47 Aug 9, 2012

R T

Δ Mkr1 1.8 ks

-50.39 dB

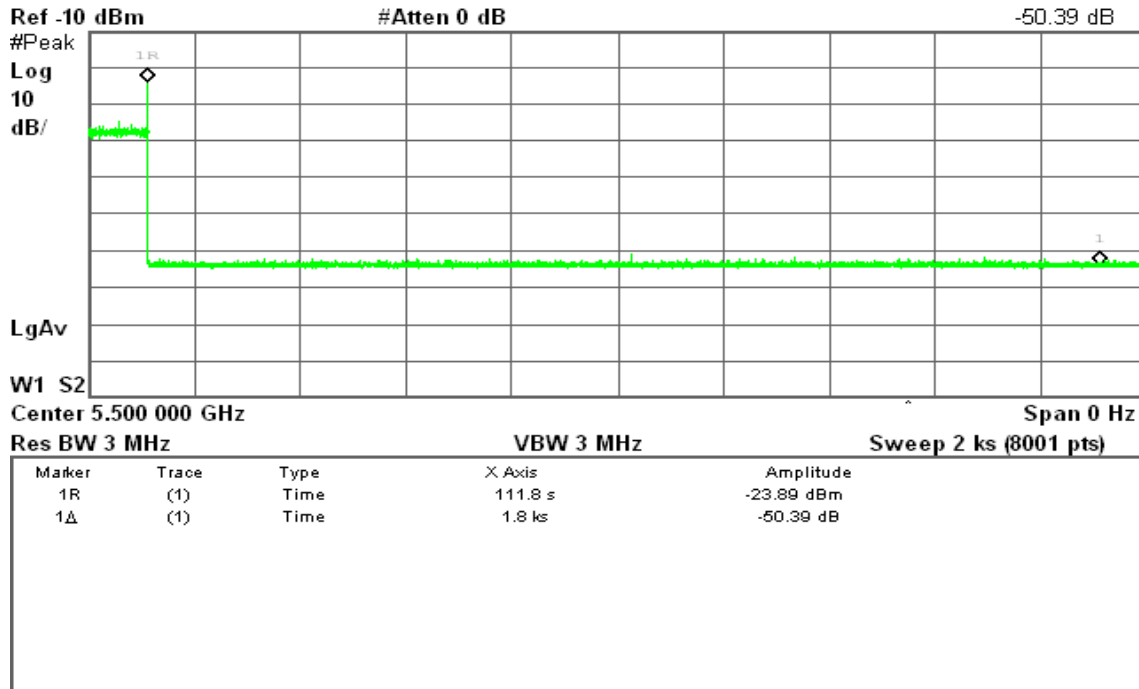



Type 5 Non-Occupancy Period Test Results

No non-compliance noted.

No EUT transmissions were observed on the test channel during the 30 minute observation time.

Agilent 07:16:45 Aug 9, 2012

R T

Δ Mkr1 1.8 ks

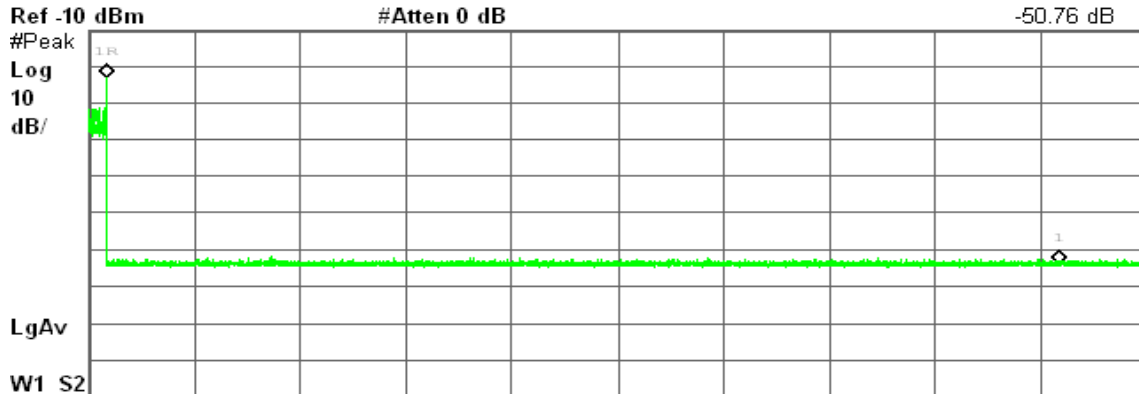

Center 5.500 000 GHz

Span 0 Hz

Res BW 3 MHz

VBW 3 MHz

Sweep 2 ks (8001 pts)

Marker	Trace	Type	X Axis	Amplitude
1R	(1)	Time	33.75 s	-23.10 dBm
1Δ	(1)	Time	1.8 ks	-50.76 dB



IEEE 802.11n HT 40 MHz mode mode

Type 1 Non-Occupancy Period Test Results

No non-compliance noted.

No EUT transmissions were observed on the test channel during the 30 minute observation time.

Agilent 11:53:24 Aug 9, 2012

R T

Δ Mkr1 1.8 ks
-50.66 dB

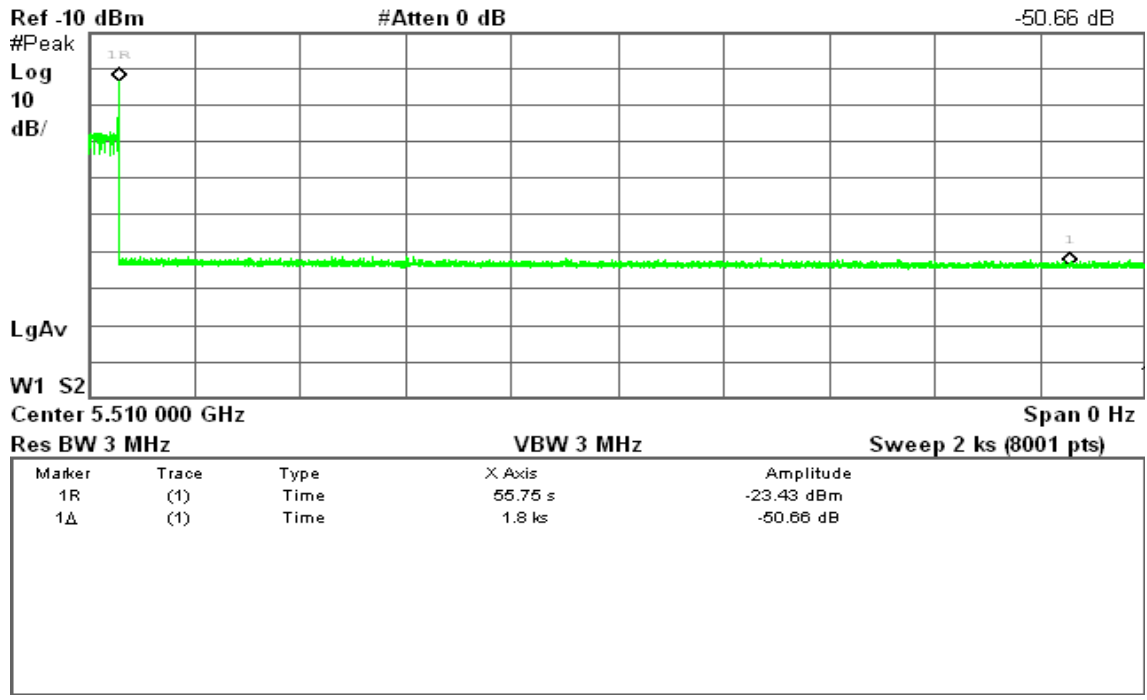



Type 5 Non-Occupancy Period Test Results

No non-compliance noted.

No EUT transmissions were observed on the test channel during the 30 minute observation time.

Agilent 08:16:42 Aug 9, 2012

R L

Δ Mkr1 1.8 ks

-49.99 dB

