



**FCC 47 CFR PART 15 SUBPART C**

**TEST REPORT**

**For**

**Notebook Computer**

**Model: V200**

**Trade Name: Getac**

*Issued to*

**Getac Technology Corp.**

**4F, No.1, R&D 2nd Road, Hsin-Chu Science-Based Industrial Park,  
Hsin-Chu Hsien, Taiwan, R.O.C.**

*Issued by*

**Compliance Certification Services Inc.**

**No.11, Wu-Gong 6th Rd., Wugu Industrial Park,  
New Taipei City 248, Taiwan (R.O.C.)**

**<http://www.ccsrf.com>**

**[service@ccsrf.com](mailto:service@ccsrf.com)**

**Issued Date: October 15, 2012**



---

*Note: This report shall not be reproduced except in full, without the written approval of Compliance Certification Services Inc. This document may be altered or revised by Compliance Certification Services Inc. personnel only, and shall be noted in the revision section of the document.*



**Revision History**

Rev.	Issue Date	Revisions	Effect Page	Revised By
00	October 15, 2012	Initial Issue	ALL	Eunice Shen



## TABLE OF CONTENTS

<b>1. TEST RESULT CERTIFICATION.....</b>	<b>4</b>
<b>2. EUT DESCRIPTION .....</b>	<b>5</b>
<b>3. TEST METHODOLOGY .....</b>	<b>6</b>
3.1 EUT CONFIGURATION .....	6
3.2 EUT EXERCISE.....	6
3.3 GENERAL TEST PROCEDURES.....	6
3.4 FCC PART 15.205 RESTRICTED BANDS OF OPERATIONS.....	7
3.5 DESCRIPTION OF TEST MODES .....	8
<b>4. INSTRUMENT CALIBRATION.....</b>	<b>9</b>
4.1 MEASURING INSTRUMENT CALIBRATION .....	9
4.2 MEASUREMENT EQUIPMENT USED .....	9
4.3 MEASUREMENT UNCERTAINTY .....	10
<b>5. FACILITIES AND ACCREDITATIONS .....</b>	<b>11</b>
5.1 FACILITIES .....	11
5.2 EQUIPMENT.....	11
5.3 TABLE OF ACCREDITATIONS AND LISTINGS.....	12
<b>6. SETUP OF EQUIPMENT UNDER TEST .....</b>	<b>13</b>
6.1 SETUP CONFIGURATION OF EUT.....	13
6.2 SUPPORT EQUIPMENT .....	13
<b>7. FCC PART 15.247 REQUIREMENTS.....</b>	<b>14</b>
7.1 20 DB BANDWIDTH.....	14
7.2 PEAK POWER.....	21
7.3 BAND EDGES MEASUREMENT .....	23
7.4 FREQUENCY SEPARATION.....	35
7.5 NUMBER OF HOPPING FREQUENCY.....	40
7.6 TIME OF OCCUPANCY (DWELL TIME) .....	45
7.7 SPURIOUS EMISSIONS .....	58
7.8 POWERLINE CONDUCTED EMISSIONS.....	76
<b>APPENDIX I RADIO FREQUENCY EXPOSURE.....</b>	<b>79</b>
<b>APPENDIX II PHOTOGRAPHS OF TEST SETUP .....</b>	<b>80</b>
<b>APPENDIX 1 - PHOTOGRAPHS OF EUT</b>	



# 1. TEST RESULT CERTIFICATION

**Applicant:** Getac Technology Corp.  
 4F, No.1, R&D 2nd Road, Hsin-Chu Science-Based Industrial  
 Park, Hsin-Chu Hsien, Taiwan, R.O.C.

**Equipment Under Test:** Notebook Computer

**Trade Name:** Getac

**Model:** V200

**Date of Test:** August 1 ~ 24, 2012

APPLICABLE STANDARDS	
STANDARD	TEST RESULT
FCC 47 CFR Part 15 Subpart C	No non-compliance noted

### We hereby certify that:

The above equipment was tested by Compliance Certification Services Inc. The test data, data evaluation, test procedures, and equipment configurations shown in this report were made in accordance with the procedures given in **ANSI C63.4: 2009** and the energy emitted by the sample EUT tested as described in this report is in compliance with the requirements of FCC Rules Part 15.207, 15.209, 15.247.

The test results of this report relate only to the tested sample EUT identified in this report.

Approved by:

Reviewed by:

---

Miller Lee  
 Section Manager  
 Compliance Certification Services Inc.

---

Gina Lo  
 Section Manager  
 Compliance Certification Services Inc.



## 2. EUT DESCRIPTION

<b>Product</b>	Notebook Computer
<b>Trade Name</b>	Getac
<b>Model Number</b>	V200
<b>Model Discrepancy</b>	N/A
<b>Received Date</b>	July 11, 2012
<b>Power Supply</b>	<ol style="list-style-type: none"><li>Powered from Power Adapter<ol style="list-style-type: none"><li>Brand: Getac / Model: ADM-6019M I/P: 100-240V, 50-60Hz, 1.5A O/P: 19V, 3.16A</li><li>Brand: Getac / Model: ADM-9019M-GTK I/P: 100-240V, 50-60Hz, 1.5A O/P: 19V, 4.74A</li><li>Brand: FSP / Model: FSP090-DMBB1 I/P: 100-240V, 50-60Hz, 1.5A O/P: 19V, 4.74A</li></ol></li><li>Powered from Battery Model: BP-LC3100/32-01P1 Rating: DC10.8V, 6100mAh, 65Wh</li></ol>
<b>Frequency Range</b>	2402 ~ 2480 MHz
<b>Transmit Power</b>	5.743 dBm
<b>Modulation Technique</b>	GFSK for 1Mbps; $\pi/4$ -DQPSK for 2Mbps; 8DPSK for 3Mbps
<b>Number of Channels</b>	79 Channels
<b>Antenna Specification</b>	Gain: 1.61 dBi
<b>Antenna Designation</b>	PIFA Antenna

**Remark:**

- The sample selected for test was production product and was provided by manufacturer.*
- This submittal(s) (test report) is intended for FCC ID: **MAU048** filing to comply with Section 15.207, 15.209 and 15.247 of the FCC Part 15, Subpart C Rules.*



### **3. TEST METHODOLOGY**

The tests documented in this report were performed in accordance with ANSI C63.4 and FCC CFR 47 Part 15.207, 15.209 and 15.247.

#### **3.1 EUT CONFIGURATION**

The EUT configuration for testing is installed on RF field strength measurement to meet the Commissions requirement and operating in a manner that intends to maximize its emission characteristics in a continuous normal application.

#### **3.2 EUT EXERCISE**

The EUT was operated in the engineering mode to fix the TX frequency that was for the purpose of the measurements.

According to its specifications, the EUT must comply with the requirements of the Section 15.207, 15.209 and 15.247 under the FCC Rules Part 15 Subpart C.

#### **3.3 GENERAL TEST PROCEDURES**

##### **Conducted Emissions**

The EUT is placed on the turntable, which is 0.8 m above ground plane. According to the requirements in Section 13.1.4.1 of ANSI C63.4 Conducted emissions from the EUT measured in the frequency range between 0.15 MHz and 30MHz using CISPR Quasi-peak and average detector modes.

##### **Radiated Emissions**

The EUT is placed on a turn table, which is 0.8 m above ground plane. The turntable shall rotate 360 degrees to determine the position of maximum emission level. EUT is set 3m away from the receiving antenna, which varied from 1m to 4m to find out the highest emission. And also, each emission was to be maximized by changing the polarization of receiving antenna both horizontal and vertical. In order to find out the maximum emissions, exploratory radiated emission measurements were made according to the requirements in Section 13.1.4.1 of ANSI C63.4.



### 3.4 FCC PART 15.205 RESTRICTED BANDS OF OPERATIONS

(a) Except as shown in paragraph (d) of this section, only spurious emissions are permitted in any of the frequency bands listed below:

MHz	MHz	MHz	GHz
0.090 - 0.110	16.42 - 16.423	399.9 - 410	4.5 - 5.15
<sup>1</sup> 0.495 - 0.505	16.69475 - 16.69525	608 - 614	5.35 - 5.46
2.1735 - 2.1905	16.80425 - 16.80475	960 - 1240	7.25 - 7.75
4.125 - 4.128	25.5 - 25.67	1300 - 1427	8.025 - 8.5
4.17725 - 4.17775	37.5 - 38.25	1435 - 1626.5	9.0 - 9.2
4.20725 - 4.20775	73 - 74.6	1645.5 - 1646.5	9.3 - 9.5
6.215 - 6.218	74.8 - 75.2	1660 - 1710	10.6 - 12.7
6.26775 - 6.26825	108 - 121.94	1718.8 - 1722.2	13.25 - 13.4
6.31175 - 6.31225	123 - 138	2200 - 2300	14.47 - 14.5
8.291 - 8.294	149.9 - 150.05	2310 - 2390	15.35 - 16.2
8.362 - 8.366	156.52475 -	2483.5 - 2500	17.7 - 21.4
8.37625 - 8.38675	156.52525	2655 - 2900	22.01 - 23.12
8.41425 - 8.41475	156.7 - 156.9	3260 - 3267	23.6 - 24.0
12.29 - 12.293	162.0125 - 167.17	3332 - 3339	31.2 - 31.8
12.51975 - 12.52025	167.72 - 173.2	3345.8 - 3358	36.43 - 36.5
12.57675 - 12.57725	240 - 285	3600 - 4400	<sup>2</sup>
13.36 - 13.41	322 - 335.4		

<sup>1</sup> Until February 1, 1999, this restricted band shall be 0.490-0.510 MHz.

<sup>2</sup> Above 38.6

(b) Except as provided in paragraphs (d) and (e), the field strength of emissions appearing within these frequency bands shall not exceed the limits shown in Section 15.209. At frequencies equal to or less than 1000 MHz, compliance with the limits in Section 15.209 shall be demonstrated using measurement instrumentation employing a CISPR quasi-peak detector. Above 1000 MHz, compliance with the emission limits in Section 15.209 shall be demonstrated based on the average value of the measured emissions. The provisions in Section 15.35 apply to these measurements.



### 3.5 DESCRIPTION OF TEST MODES

The EUT (model: V200) comes with three types of power adapter for sale. After the preliminary test, the EUT with adapter (Model: ADM-9019M-GTK) was found to emit the worst emissions and therefore had been tested under operating condition.

Software used to control the EUT for staying in continuous transmitting mode was programmed. The worst case data rate is determined as the data rate with highest output power.

After verification, all tests were carried out with the worst case test modes as shown below except radiated spurious emission below 1GHz and power line conducted emissions below 30MHz, which worst case was in normal link mode only.

Channel Low (2402MHz), Mid (2441MHz) and High (2480MHz) with 1Mbps data rate was chosen for full testing.

During the preliminary test, GFSK,  $\pi/4$ -QPSK & 8DPSK with DH1 were pre-tested and found that 8DPSK emits the highest output power. Then the tests were carried on with DH1 compare to DH3 & DH5 and found that 8DPSK with DH5 emit the highest output power, and therefore had been tested under operating condition.

Following channels were selected for the radiated emission testing only as listed below:

Tested Channel	Modulation Type	Packet Type	Data Rate
Low, Mid, High	GFSK	DH 5	1
Low, Mid, High	8DPSK	DH 5	3





## 4. INSTRUMENT CALIBRATION

### 4.1 MEASURING INSTRUMENT CALIBRATION

The measuring equipment, which was utilized in performing the tests documented herein, has been calibrated in accordance with the manufacturer's recommendations for utilizing calibration equipment, which is traceable to recognized national standards.

### 4.2 MEASUREMENT EQUIPMENT USED

#### Equipment Used for Emissions Measurement

*Remark: Each piece of equipment is scheduled for calibration once a year and Loop Antenna is scheduled for calibration once three years.*

Conducted Emissions Test Site				
Name of Equipment	Manufacturer	Model	Serial Number	Calibration Due
Spectrum Analyzer	Agilent	E4446A	MY43360132	06/14/2013
Power Meter	Anritsu	ML2495A	1149001	12/07/2012
Power Sensor	Anritsu	MA2411B	1126148	12/14/2012

966Chamber B				
Name of Equipment	Manufacturer	Model	Serial Number	Calibration Due
Spectrum Analyzer	Agilent	E4446A	MY46180323	04/22/2013
EMI Receiver	ROHDE & SCHWARZ	ESCS 30	826547/004	10/27/2012
Broadband Hybrid Bi-Log Antenna	Sunol Sciences	JB1	A100209-4	10/01/2013
Double-Ridged Waveguide Horn	ETS-LINDGREN	3117	00078733	12/06/2012
Horn Antenna	COM-POWER	AH-840	03077	12/06/2012
Pre-Amplifier	Agilent	8447D	2944A10052	07/17/2013
Pre-Amplifier	Agilent	8449B	3008A01916	07/17/2013
Notch Filters Band Reject	Micro-Tronics	BRM05702-01	026	N.C.R
Band Reject Filter	Micro-Tronics	BRC50703-01	004	N.C.R.
Band Reject Filter	Micro-Tronics	BRC50704-01	004	N.C.R.
Band Reject Filter	Micro-Tronics	BRC50705-01	007	N.C.R.
LOOP Antenna	EMCO	6502	8905-2356	06/10/2013

Conducted Emission room				
Name of Equipment	Manufacturer	Model	Serial Number	Calibration Due
L.I.S.N	SCHWARZBECK	NSLK 8127	8127-465	08/07/2013
L.I.S.N	SCHWARZBECK	NSLK 8127	8127-473	03/12/2013
EMI Receiver	ROHDE & SCHWARZ	ESCS 30	835418/008	10/20/2012
Pulse Limiter	ROHDE & SCHWARZ	ESH3-Z2	100117	07/03/2013



### 4.3 MEASUREMENT UNCERTAINTY

PARAMETER	UNCERTAINTY
Conducted Emission (Mains Terminals), 9kHz to 30MHz	+/- 2.48
Conducted Emission (Telecommunication Port), 150kHz to 30MHz	+/- 3.09
3M Semi Anechoic Chamber / 30M~1000M	+/- 3.97
3M Semi Anechoic Chamber / 1G~18G	+/- 3.58
3M Semi Anechoic Chamber / 18G~26G	+/- 3.59
3M Semi Anechoic Chamber / 26G~40G	+/- 3.81

**Remark:** This uncertainty represents an expanded uncertainty expressed at approximately the 95% confidence level using a coverage factor of  $k=2$ .



## 5. FACILITIES AND ACCREDITATIONS

### 5.1 FACILITIES

All measurement facilities used to collect the measurement data are located at

NO. 989-1 Wen Shan Rd., Shang Shan Village, Qionglin Shiang Hsinchu County 30741, Taiwan, R.O.C

No.11, Wu-Gong 6th Rd., Wugu Industrial Park, New Taipei City 248, Taiwan (R.O.C.)  
Tel: 886-2-2299-9720 / Fax: 886-2-2298-4045

No.81-1, Lane 210, Bade 2nd Rd., Lujhu Township, Taoyuan County 33841, TAIWAN, R.O.C.  
Tel: 886-3-324-0332 / Fax: 886-3-324-5235

The sites are constructed in conformance with the requirements of ANSI C63.7, ANSI C63.4 and CISPR Publication 22.

### 5.2 EQUIPMENT

Radiated emissions are measured with one or more of the following types of linearly polarized antennas: tuned dipole, biconical, log periodic, bi-log, and/or ridged waveguide, horn. Spectrum analyzers with pre-selectors and quasi-peak detectors are used to perform radiated measurements.



Conducted emissions are measured with Line Impedance Stabilization Networks and EMI Test Receivers.

Calibrated wideband preamplifiers, coaxial cables, and coaxial attenuators are also used for making measurements.

All receiving equipment conforms to CISPR Publication 16-1, "Radio Interference Measuring Apparatus and Measurement Methods."



### 5.3 TABLE OF ACCREDITATIONS AND LISTINGS

Country	Agency	Scope of Accreditation	Logo
USA	FCC	3M Semi Anechoic Chamber (FCC MRA: TW1039) to perform FCC Part 15 measurements	 FCC MRA: TW1039
Taiwan	TAF	LP0002, RTTE01, FCC Method-47 CFR Part 15 Subpart C, D, E, RSS-210, RSS-310 IDA TS SRD, AS/NZS 4268, AS/NZS 4771, TS 12.1 & 12.2, ETSI EN 300 440-1, ETSI EN 300 440-2, ETSI EN 300 328, ETSI EN 300 220-1, ETSI EN 300 220-2, ETSI EN 301 893, ETSI EN 301 489-1/3/7/17 FCC OET Bulletin 65 + Supplement C, EN 50360, EN 50361, EN 50371, RSS 102, EN 50383, EN 50385, EN 50392, IEC 62209, CNS 14958-1, CNS 14959 FCC Method -47 CFR Part 15 Subpart B IEC / EN 61000-3-2, IEC / EN 61000-3-3, IEC / EN 61000-4-2/3/4/5/6/8/11	
Canada	Industry Canada	3M Semi Anechoic Chamber (IC 2324G-1 / IC 2324G-2) to perform	 IC 2324G-1 IC 2324G-2

\* No part of this report may be used to claim or imply product endorsement by A2LA or any agency of the US Government.



## 6. SETUP OF EQUIPMENT UNDER TEST

### 6.1 SETUP CONFIGURATION OF EUT

See test photographs attached in Appendix II for the actual connections between EUT and support equipment.

### 6.2 SUPPORT EQUIPMENT

No.	Product	Manufacturer	Model No.	Serial No.	FCC ID
1	Notebook PC	HP	ProBook 4421s	CNF03242PJ	DoC
2	Notebook PC	HP	ProBook 4421s	CNF03242PM	DoC
3	Notebook PC	IBM (Lenovo)	ThinkPad T61 7663-AS6	L3F3864	DoC
4	LCD Monitor	ViewSonic	VA1918wm	R18082200388	DoC
5	Micro SD	SanDisk	SDSDM-1024	BB07251CTE	---
6	External hard drive	TeraSys	F12-U	4912A002	---
7	Modem	ZyXEL	Omni 56K	S1Z4107727	1880MNI56K
8	USB 3.0	ADATA	C103/16GB	---	---
9	CF Adaptor	iEI	1211004-0040	00082900065	---
10	USB 2.0	---	---	---	---

**Remark:**

1. All the equipment/cables were placed in the worst-case configuration to maximize the emission during the test.
2. Grounding was established in accordance with the manufacturer's requirements and conditions for the intended use.



## 7. FCC PART 15.247 REQUIREMENTS

### 7.1 20 DB BANDWIDTH

#### LIMIT

None; for reporting purposes only.

#### Test Configuration

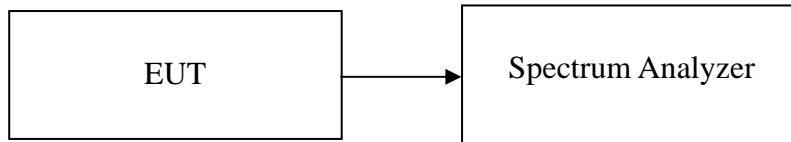

#### TEST PROCEDURE

1. Place the EUT on the table and set it in the transmitting mode.
2. Remove the antenna from the EUT and then connect a low loss RF cable from the antenna port to the spectrum analyzer.
3. Set the spectrum analyzer as RBW=30 kHz, VBW = 100 kHz, Sweep = 3.2 ms.
4. Mark the peak frequency and 20dB (upper and lower) frequency.
5. Repeat until all the rest channels are investigated.

#### TEST RESULTS

*No non-compliance noted.*

#### Test Data

##### **For GFSK / DH5**

Channel	Frequency (MHz)	20dB Bandwidth (MHz)
Low	2402	0.96
Mid	2441	0.96
High	2480	0.955

##### **For 8DPSK / DH5**

Channel	Frequency (MHz)	20dB Bandwidth (MHz)
Low	2402	1.315
Mid	2441	1.295
High	2480	1.3



**Test Plot**

**For GFSK / DH5**

**20dB Bandwidth (CH Low)**

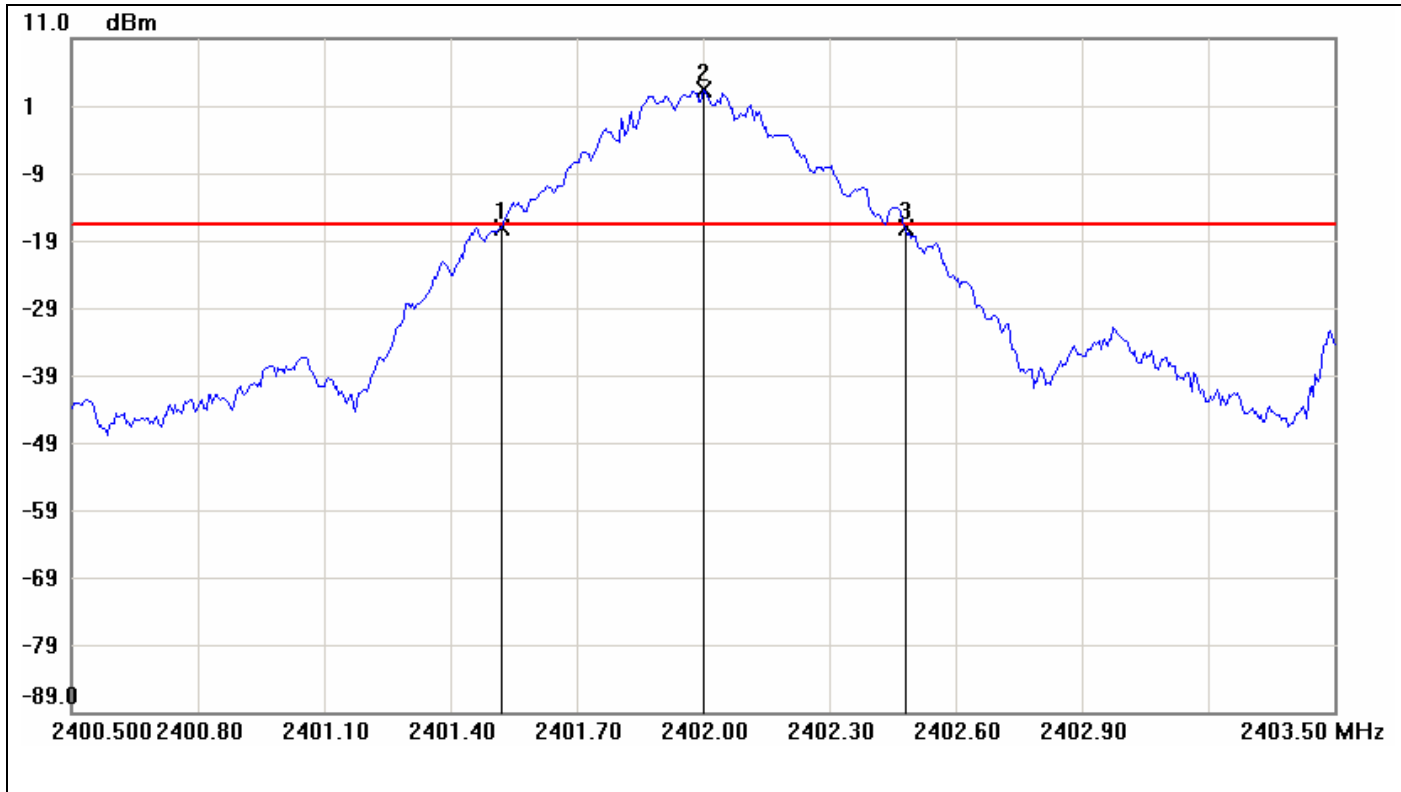

No.	Frequency(MHz)	Result(dBm)	Limit(dBm)	Margin(dBm)
1	2401.5200	-17.07	-16.59	-0.48
2	2402.0000	3.41	-16.59	20.00
3	2402.4800	-17.13	-16.59	-0.54

No.		$\Delta$ Frequency(MHz)	$\Delta$ Level(dB)
1	mk3-mk1	0.96	-0.06



20dB Bandwidth (CH Mid)

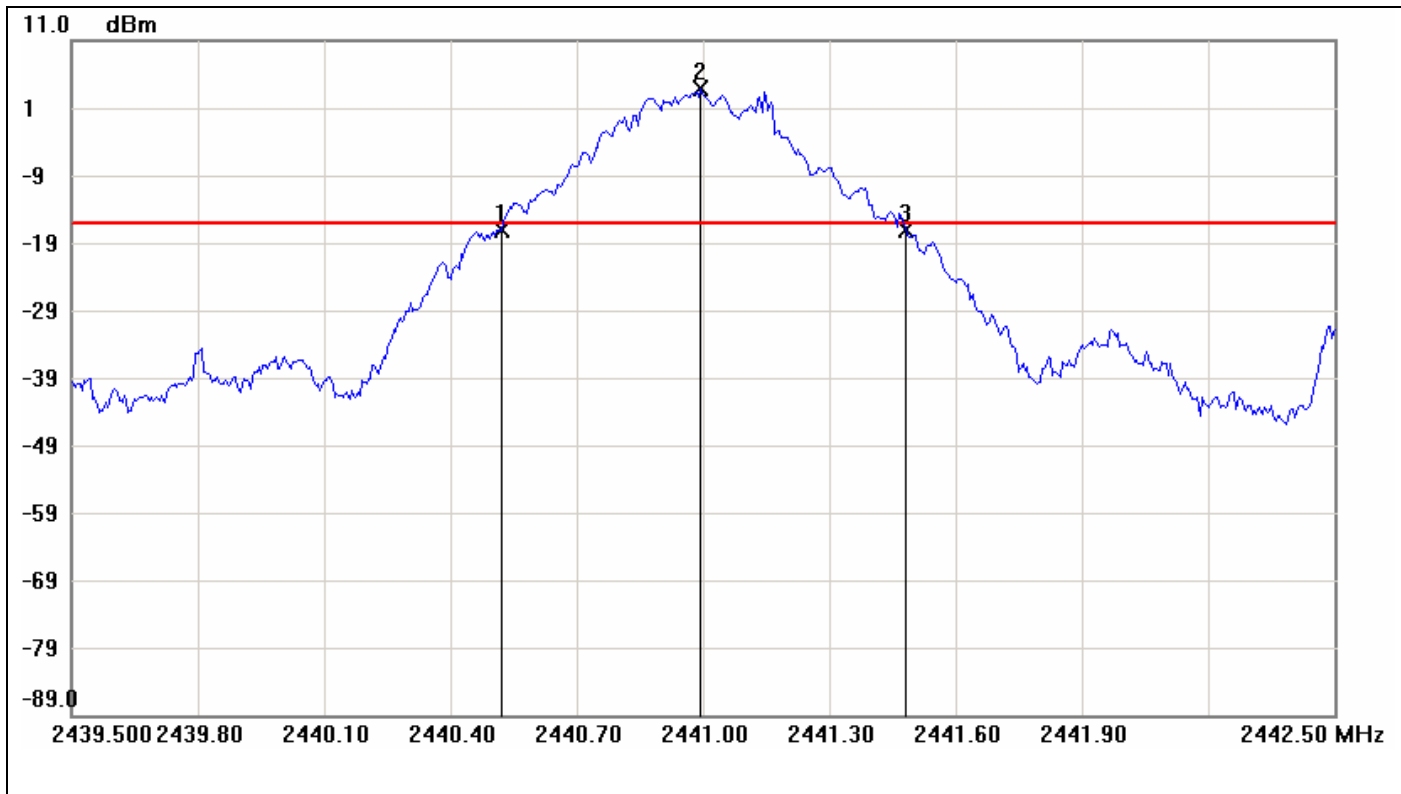

No.	Frequency(MHz)	Result(dBm)	Limit(dBm)	Margin(dBm)
1	2440.5200	-17.09	-16.19	-0.90
2	2440.9950	3.81	-16.19	20.00
3	2441.4800	-17.00	-16.19	-0.81

No.		$\Delta$ Frequency(MHz)	$\Delta$ Level(dB)
1	mk3-mk1	0.96	0.09





**20dB Bandwidth (CH High)**

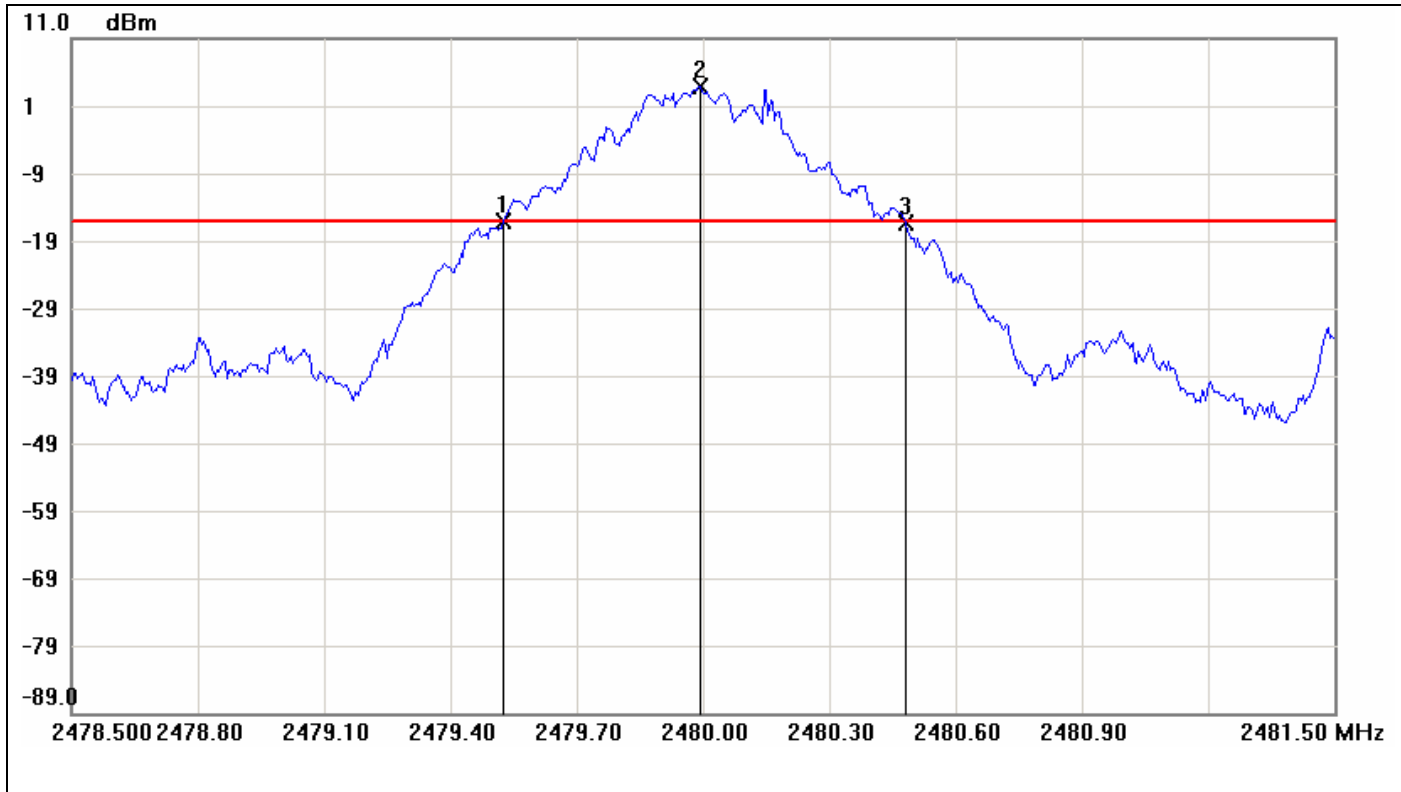

No.	Frequency(MHz)	Result(dBm)	Limit(dBm)	Margin(dBm)
1	2479.5250	-16.10	-16.08	-0.02
2	2479.9950	3.92	-16.08	20.00
3	2480.4800	-16.42	-16.08	-0.34

No.		$\Delta$ Frequency(MHz)	$\Delta$ Level(dB)
1	mk3-mk1	0.955	-0.32



For 8DPSK / DH5

20dB Bandwidth (CH Low)

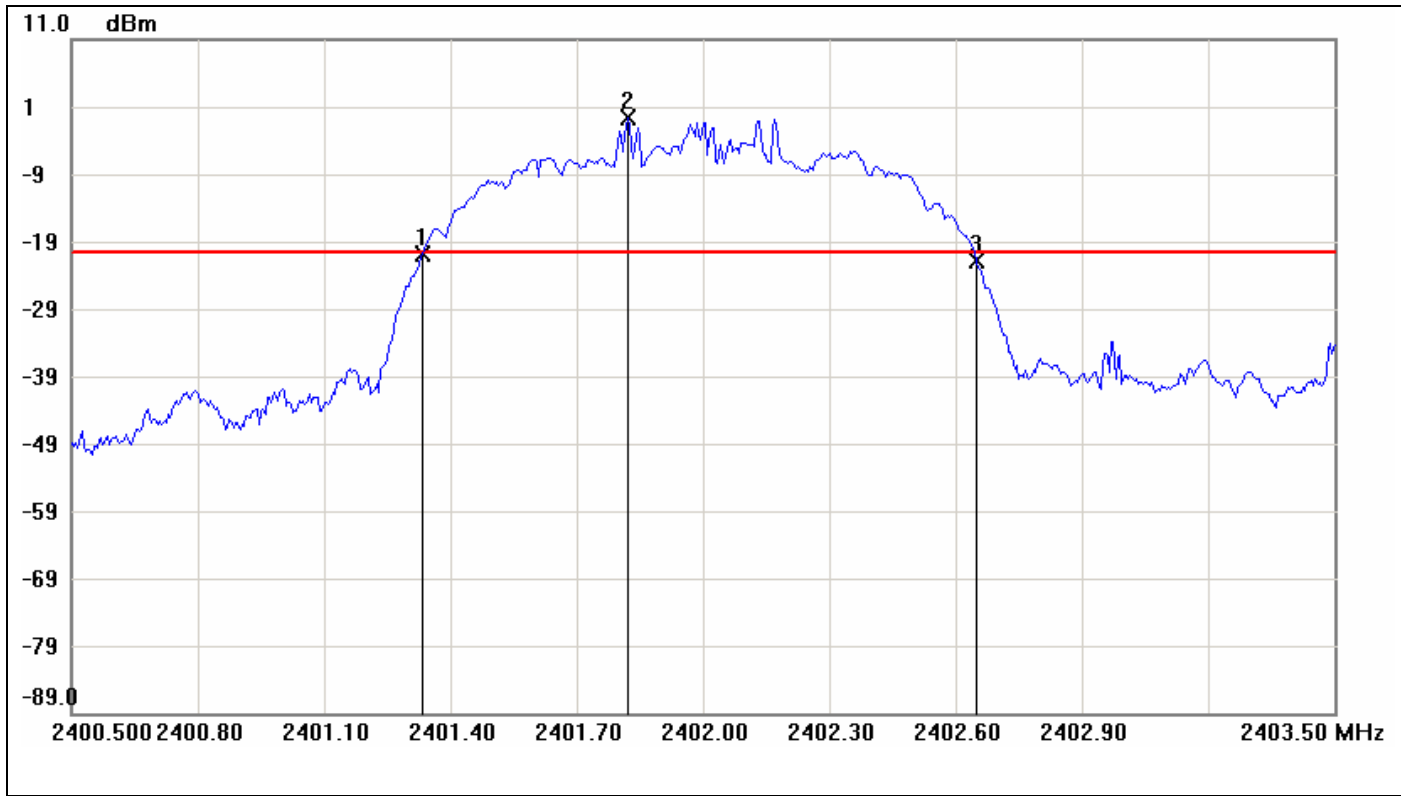

No.	Frequency(MHz)	Result(dBm)	Limit(dBm)	Margin(dBm)
1	2401.3350	-20.94	-20.61	-0.33
2	2401.8200	-0.61	-20.61	20.00
3	2402.6500	-21.97	-20.61	-1.36

No.		$\Delta$ Frequency(MHz)	$\Delta$ Level(dB)
1	mk3-mk1	1.315	-1.03



20dB Bandwidth (CH Mid)

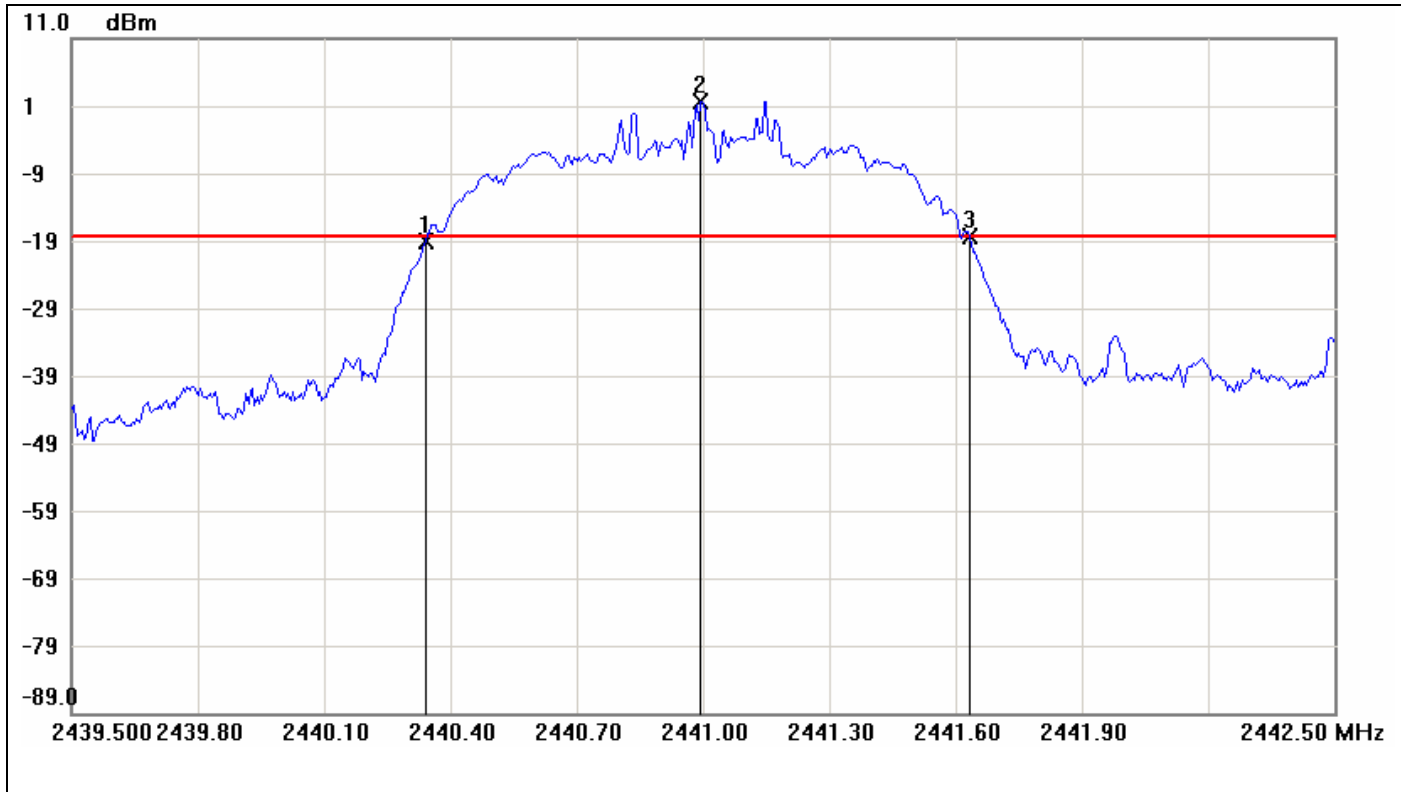

No.	Frequency(MHz)	Result(dBm)	Limit(dBm)	Margin(dBm)
1	2440.3400	-19.02	-18.39	-0.63
2	2440.9950	1.61	-18.39	20.00
3	2441.6350	-18.45	-18.39	-0.06

No.		$\Delta$ Frequency(MHz)	$\Delta$ Level(dB)
1	mk3-mk1	1.295	0.57



**20dB Bandwidth (CH High)**

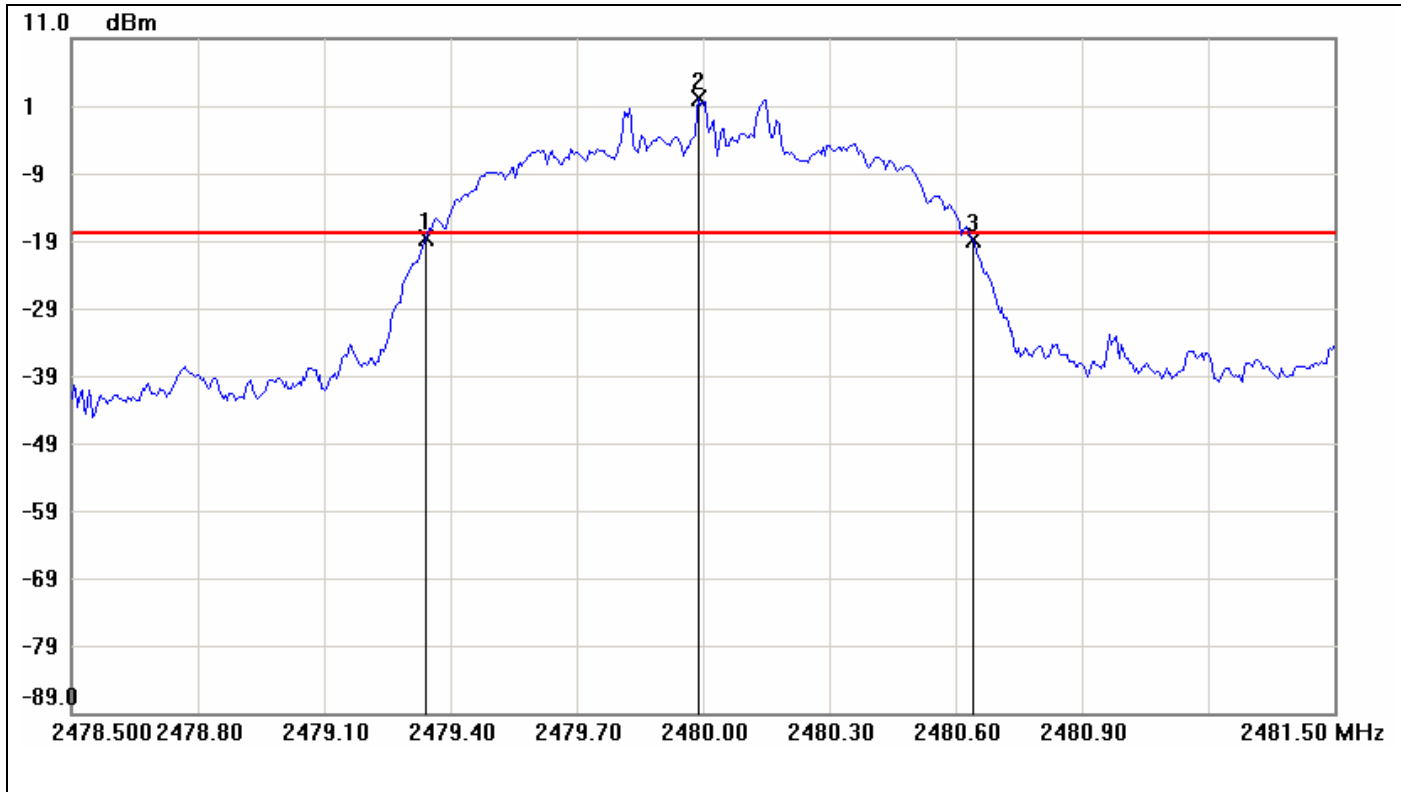

No.	Frequency(MHz)	Result(dBm)	Limit(dBm)	Margin(dBm)
1	2479.3400	-18.72	-17.99	-0.73
2	2479.9900	2.01	-17.99	20.00
3	2480.6400	-18.89	-17.99	-0.90

No.		$\Delta$ Frequency(MHz)	$\Delta$ Level(dB)
1	mk3-mk1	1.3	-0.17



## 7.2 PEAK POWER

### LIMIT

The maximum peak output power of the intentional radiator shall not exceed the following:

1. According to §15.247(a)(1), Frequency hopping systems shall have hopping channel carrier frequencies separated by a minimum of 25 kHz or the 20 dB bandwidth of the hopping channel, whichever is greater. Alternatively, frequency hopping systems operating in the 2400-2483.5 MHz band may have hopping channel carrier frequencies that are separated by 25 kHz or two-thirds of the 20 dB bandwidth of the hopping channel, whichever is greater, provided the systems operate with an output power no greater than 125 mW.
2. According to §15.247(b)(1), for frequency hopping systems operating in the 2400–2483.5 MHz band employing at least 75 nonoverlapping hopping channels, and all frequency hopping systems in the 5725–5850 MHz band: 1 watt. For all other frequency hopping systems in the 2400–2483.5 MHz band: 0.125 watts.
3. According to §15.247(b)(4), the conducted output power limit specified in paragraph (b) of this section is based on the use of antennas with directional gains that do not exceed 6 dBi. Except as shown in paragraph (c) of this section, if transmitting antennas of directional gain greater than 6 dBi are used, the conducted output power from the intentional radiator shall be reduced below the stated values in paragraphs (b)(1), (b)(2), and (b)(3) of this section, as appropriate, by the amount in dB that the directional gain of the antenna exceeds 6 dBi.

### Test Configuration

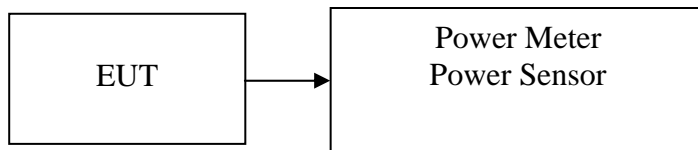

### TEST PROCEDURE

The transmitter output is connected to the Power Meter. The Power Meter is set to the peak power detection.

### TEST RESULTS

*No non-compliance noted.*



**Test Data**

**For GFSK / DH5**

Channel	Frequency (MHz)	Output Power (dBm)	Output Power (W)	Limit (W)	Result
Low	2402	5.451	0.0035	0.125	PASS
Mid	2441	5.628	0.0037		PASS
High	2480	5.743	0.0038		PASS

**For 8DPSK / DH5**

Channel	Frequency (MHz)	Output Power (dBm)	Output Power (W)	Limit (W)	Result
Low	2402	3.904	0.0025	0.125	PASS
Mid	2441	4.429	0.0028		PASS
High	2480	4.752	0.0030		PASS



### 7.3 BAND EDGES MEASUREMENT

#### LIMIT

According to §15.247(d), in any 100 kHz bandwidth outside the frequency band in which the spread spectrum or digitally modulated intentional radiator is operating, the radio frequency power that is produced by the intentional radiator shall be at least 20 dB below that in the 100 kHz bandwidth within the band that contains the highest level of the desired power, based on either an RF conducted or a radiated measurement, provided the transmitter demonstrates compliance with the peak conducted power limits. If the transmitter complies with the conducted power limits based on the use of RMS averaging over a time interval, as permitted under paragraph (b)(3) of this section, the attenuation required under this paragraph shall be 30 dB instead of 20 dB. Attenuation below the general limits specified in §15.209(a) is not required. In addition, radiated emissions which fall in the restricted bands, as defined in §15.205(a), must also comply with the radiated emission limits specified in §15.209(a) (see §15.205(c)).

#### Test Configuration

##### For Radiated

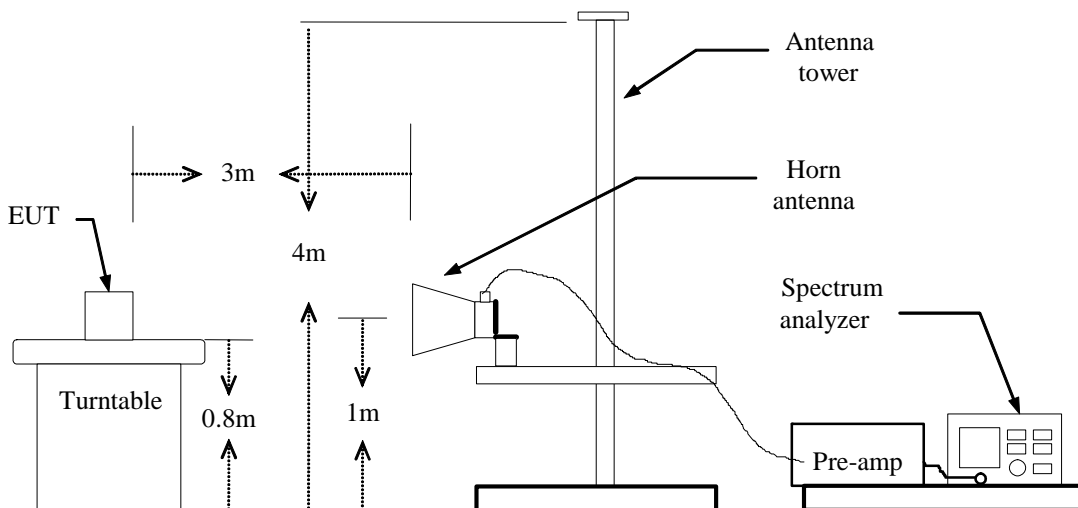

##### For Conducted

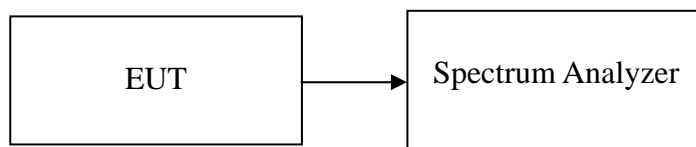



## **TEST PROCEDURE**

### **For Radiated**

1. The EUT is placed on a turntable, which is 0.8m above the ground plane.
2. The turntable shall be rotated for 360 degrees to determine the position of maximum emission level.
3. EUT is set 3m away from the receiving antenna, which is varied from 1m to 4m to find out the highest emission.
4. Set the spectrum analyzer in the following setting in order to capture the lower and upper band-edges of the emission:
  - (a) PEAK: RBW=VBW=1MHz / Sweep=AUTO
  - (b) AVERAGE: RBW=1MHz / VBW=10Hz / Sweep=AUTO
5. Repeat the procedures until all the PEAK and AVERAGE versus POLARIZATION are measured.

### **For Conducted**

Conducted RF measurements of the transmitter output were made to confirm that the EUT antenna port conducted emissions meet the specified limit and to identify any spurious signals that require further investigation or measurements on the radiated emissions site.

The transmitter output is connected to the spectrum analyzer. The resolution bandwidth is set to 100 kHz. The video bandwidth is set to 100 kHz.

## **TEST RESULTS**

Refer to attach spectrum analyzer data chart.





**For GFSK / DH5**

**Band Edges (CH Low)**

**Detector mode: Peak**

**Polarity: Vertical**

Agilent

R T

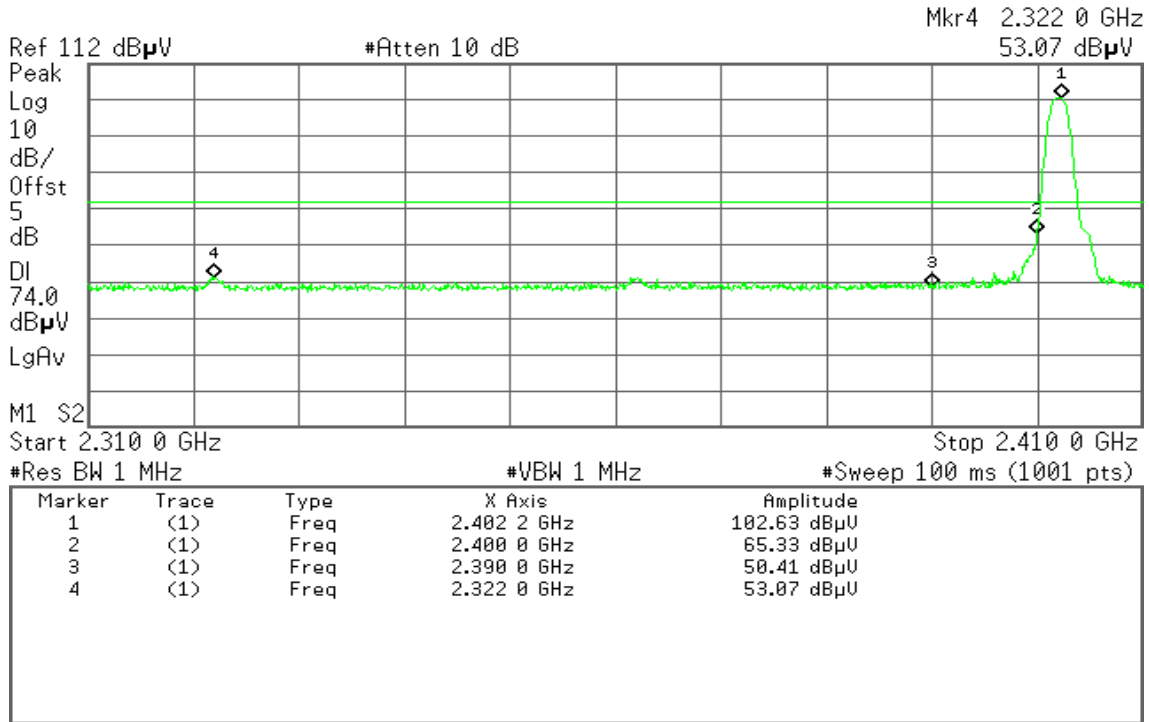

**Detector mode: Peak**

**Polarity: Horizontal**

Agilent

R T

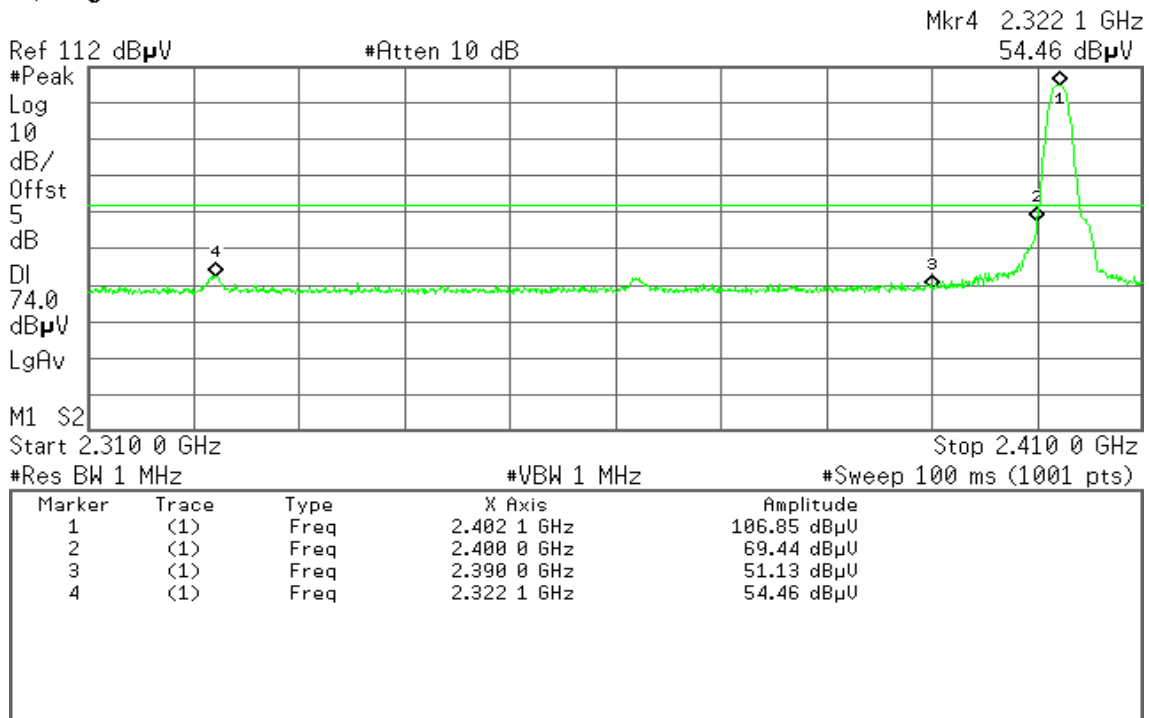



### Band Edges (CH High)

Detector mode: Peak

Polarity: Vertical

Agilent

R T

Mkr2 2.483 50 GHz  
57.40 dBμV

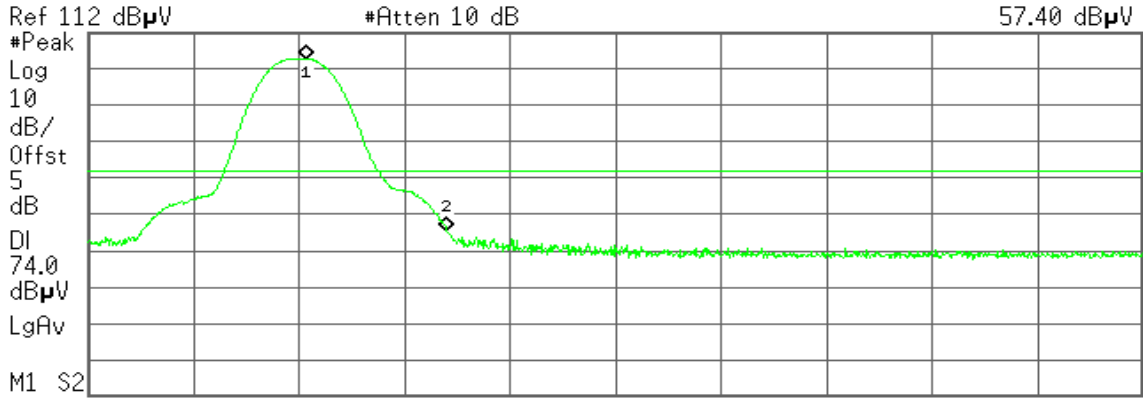

Marker	Trace	Type	X Axis	Amplitude
1	(1)	Freq	2.480 15 GHz	104.67 dBμU
2	(1)	Freq	2.483 50 GHz	57.40 dBμU

#Res BW 1 MHz #VBW 1 MHz #Sweep 100 ms (1001 pts)

Detector mode: Peak

Polarity: Horizontal

Agilent

R T

Mkr2 2.483 50 GHz  
59.85 dBμV



Marker	Trace	Type	X Axis	Amplitude
1	(1)	Freq	2.480 12 GHz	107.05 dBμU
2	(1)	Freq	2.483 50 GHz	59.85 dBμU

#Res BW 1 MHz #VBW 1 MHz #Sweep 100 ms (1001 pts)



**For 8DPSK / DH5**

**Band Edges (CH Low)**

**Detector mode: Peak**

**Polarity: Vertical**

**Agilent**

**R T**

Mkr4 2.321 9 GHz  
52.47 dBμV

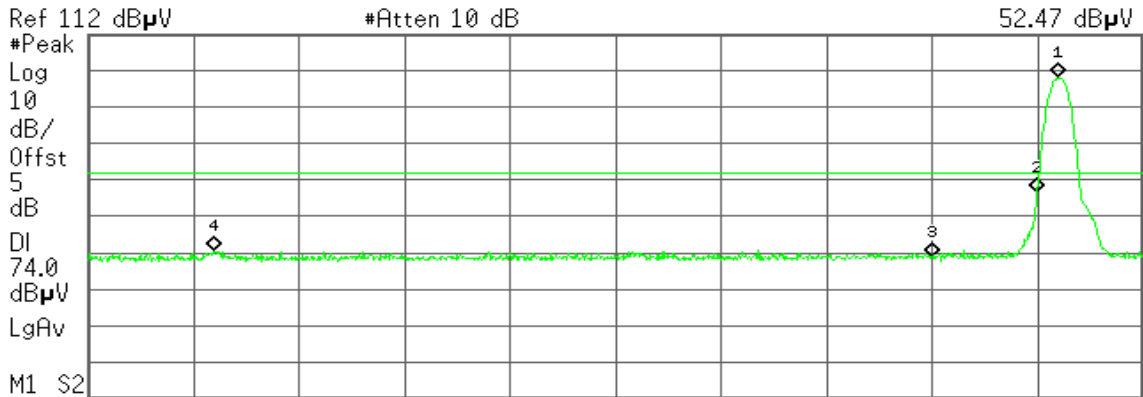

Start 2.310 0 GHz Stop 2.410 0 GHz  
#Res BW 1 MHz #VBW 1 MHz #Sweep 100 ms (1001 pts)

Marker	Trace	Type	X Axis	Amplitude
1	(1)	Freq	2.402 0 GHz	100.09 dBμV
2	(1)	Freq	2.400 0 GHz	68.82 dBμV
3	(1)	Freq	2.390 0 GHz	50.92 dBμV
4	(1)	Freq	2.321 9 GHz	52.47 dBμV

**Detector mode: Peak**

**Polarity: Horizontal**

**Agilent**

**R T**

Mkr4 2.322 0 GHz  
52.50 dBμV

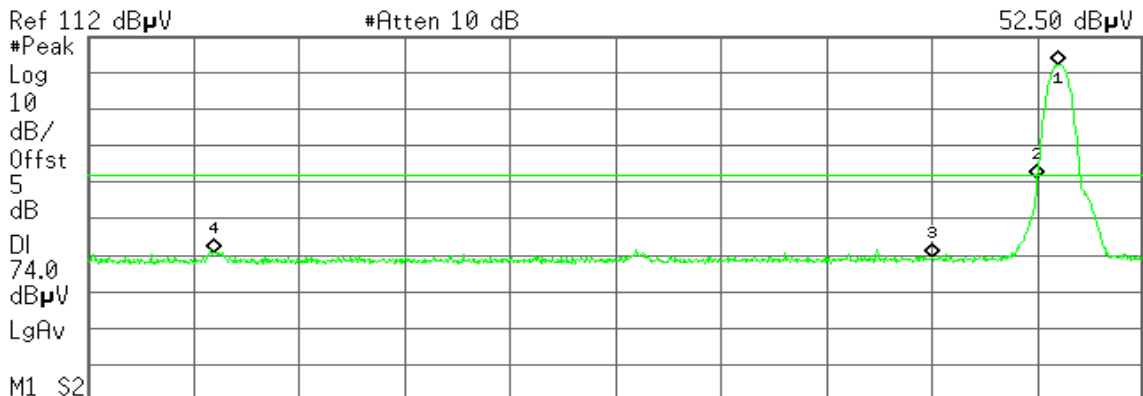

Start 2.310 0 GHz Stop 2.410 0 GHz  
#Res BW 1 MHz #VBW 1 MHz #Sweep 100 ms (1001 pts)

Marker	Trace	Type	X Axis	Amplitude
1	(1)	Freq	2.402 0 GHz	104.38 dBμV
2	(1)	Freq	2.400 0 GHz	72.82 dBμV
3	(1)	Freq	2.390 0 GHz	51.42 dBμV
4	(1)	Freq	2.322 0 GHz	52.50 dBμV



### Band Edges (CH High)

Detector mode: Peak

Polarity: Vertical

Agilent

R T

Mkr2 2.483 50 GHz  
59.91 dB $\mu$ V

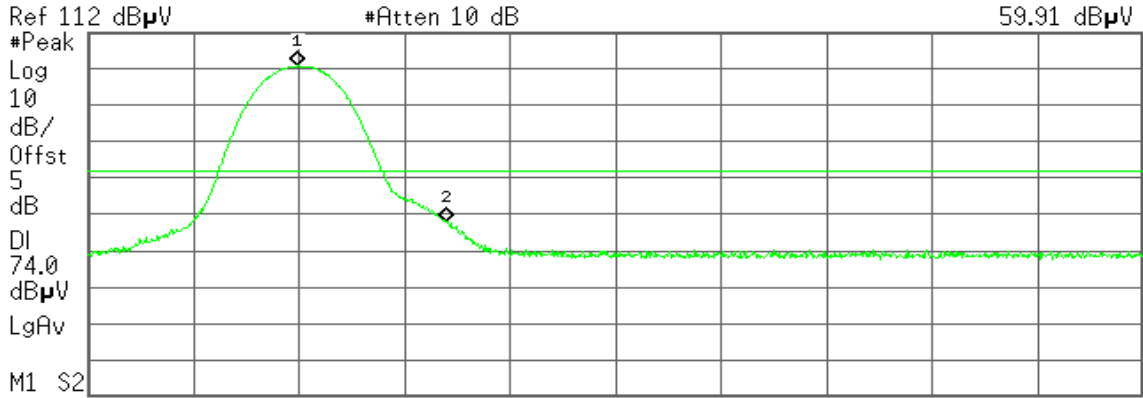

Marker	Trace	Type	X Axis	Amplitude
1	(1)	Freq	2.479 98 GHz	102.69 dB $\mu$ U
2	(1)	Freq	2.483 50 GHz	59.91 dB $\mu$ U

Detector mode: Peak

Polarity: Horizontal

Agilent

R T

Mkr2 2.483 50 GHz  
61.84 dB $\mu$ V



Marker	Trace	Type	X Axis	Amplitude
1	(1)	Freq	2.479 98 GHz	105.12 dB $\mu$ U
2	(1)	Freq	2.483 50 GHz	61.84 dB $\mu$ U



### GFSK

### Band Edges (CH Low)

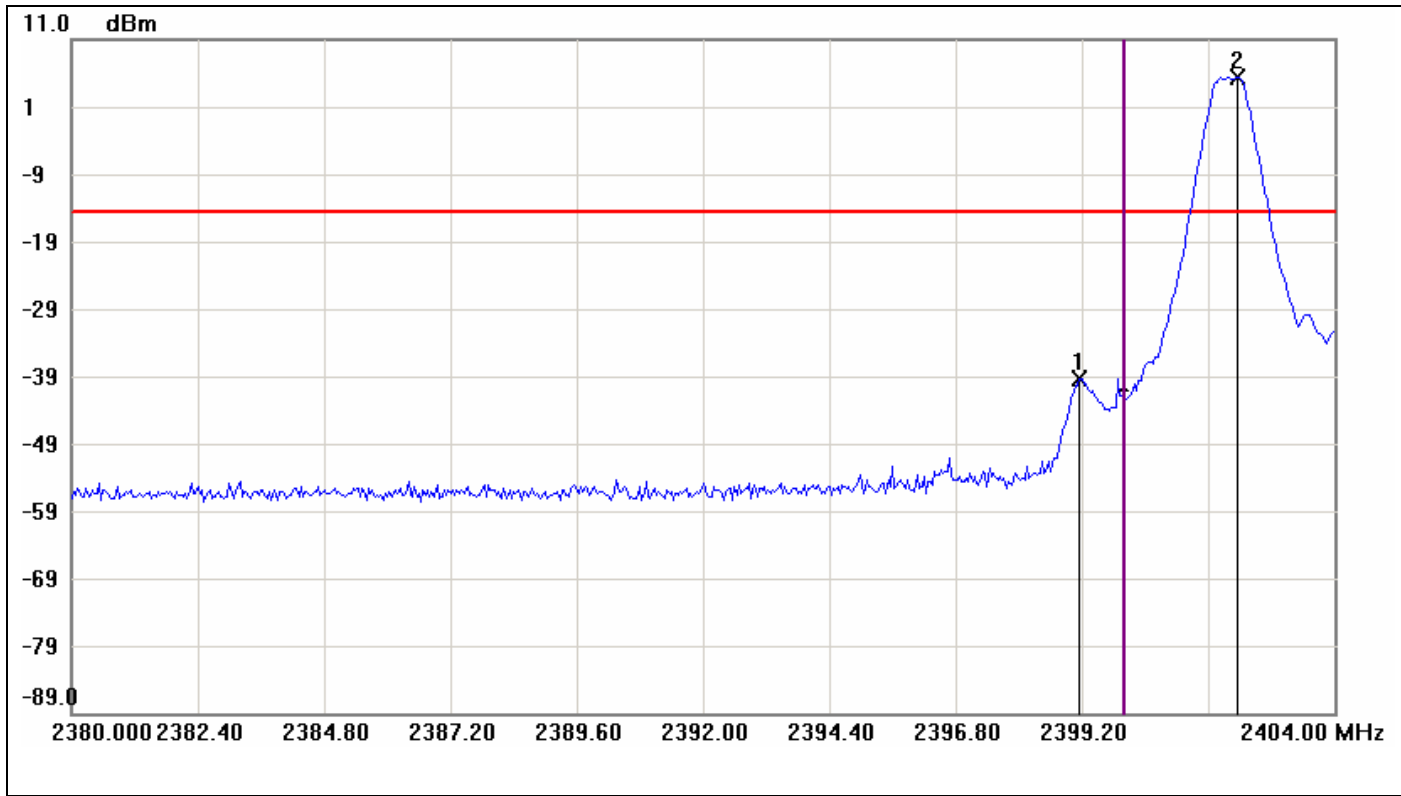

No.	Frequency(MHz)	Result(dBm)	Limit(dBm)	Margin(dBm)
1	2399.1600	-39.34	-14.54	-24.80
2	2402.1600	5.46	-14.54	20.00



### Band Edges (CH High)

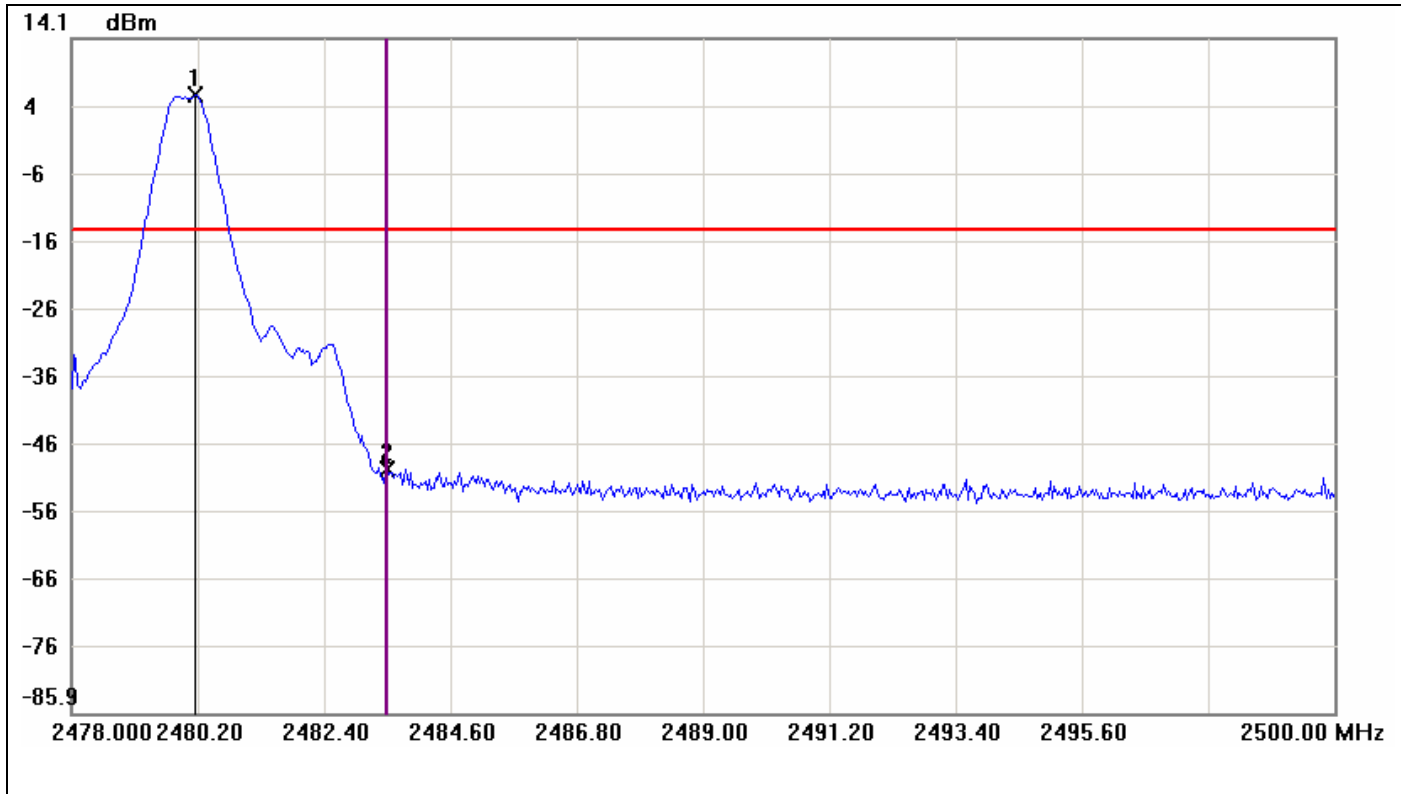

No.	Frequency(MHz)	Result(dBm)	Limit(dBm)	Margin(dBm)
1	2480.1633	5.60	-14.40	20.00
2	2483.5000	-49.75	-14.40	-35.35



### Hopping Mode

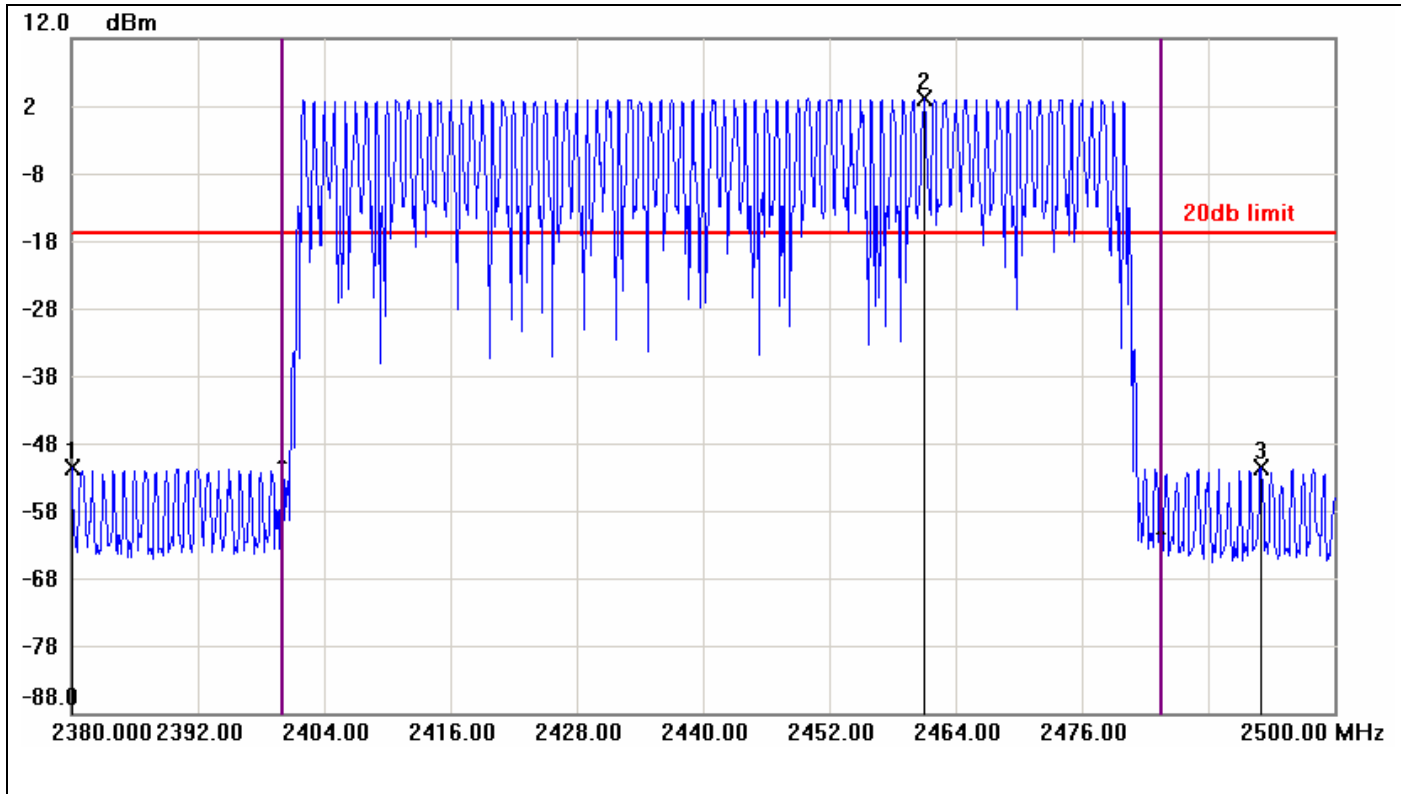

No.	Frequency(MHz)	Result(dBm)	Limit(dBm)	Margin(dBm)
1	2380.0000	-51.62	-16.88	-34.74
2	2461.0000	3.12	-16.88	20.00
3	2493.0400	-51.70	-16.88	-34.82



### 8DPSK

#### Band Edges (CH Low)

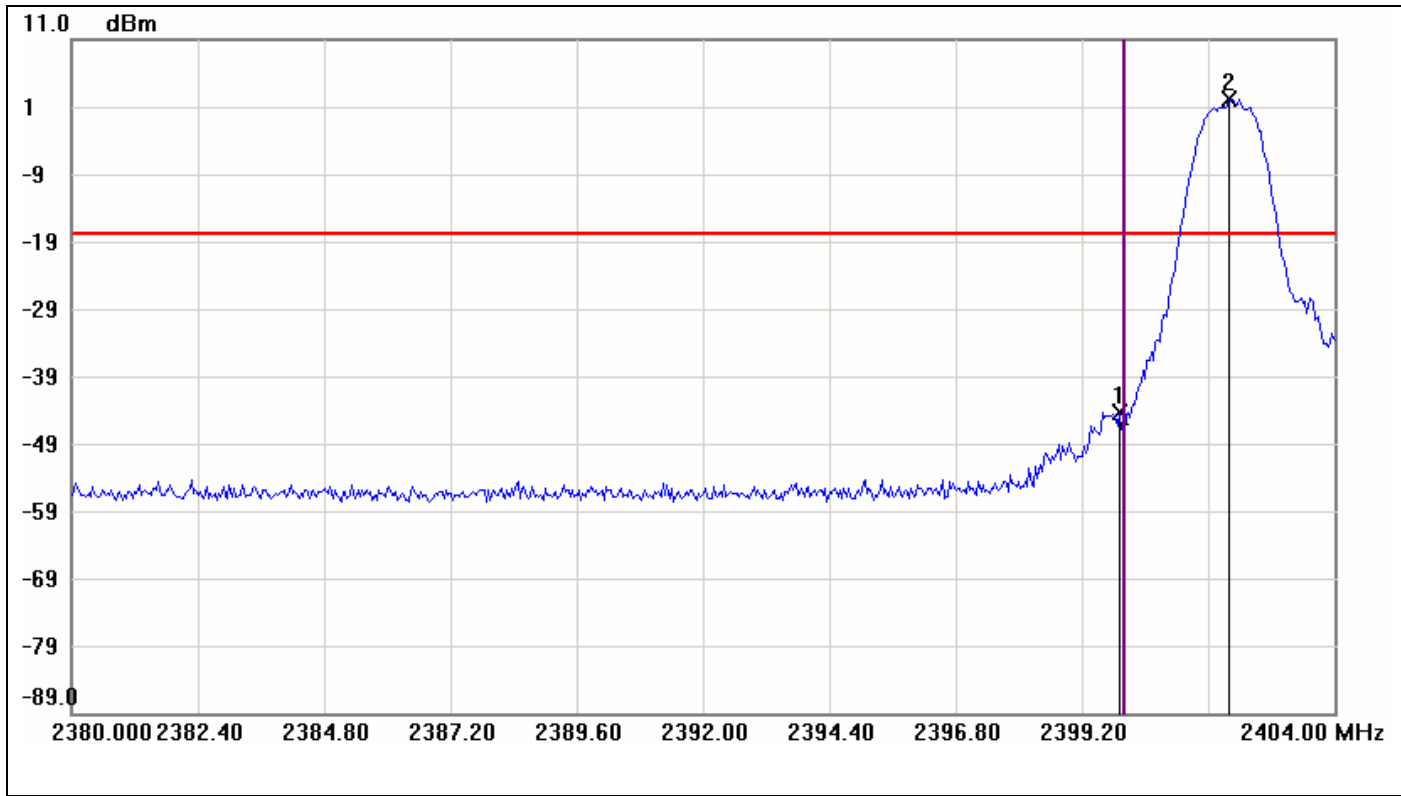

No.	Frequency(MHz)	Result(dBm)	Limit(dBm)	Margin(dBm)
1	2399.9200	-44.39	-17.79	-26.60
2	2402.0000	2.21	-17.79	20.00





### Band Edges (CH High)

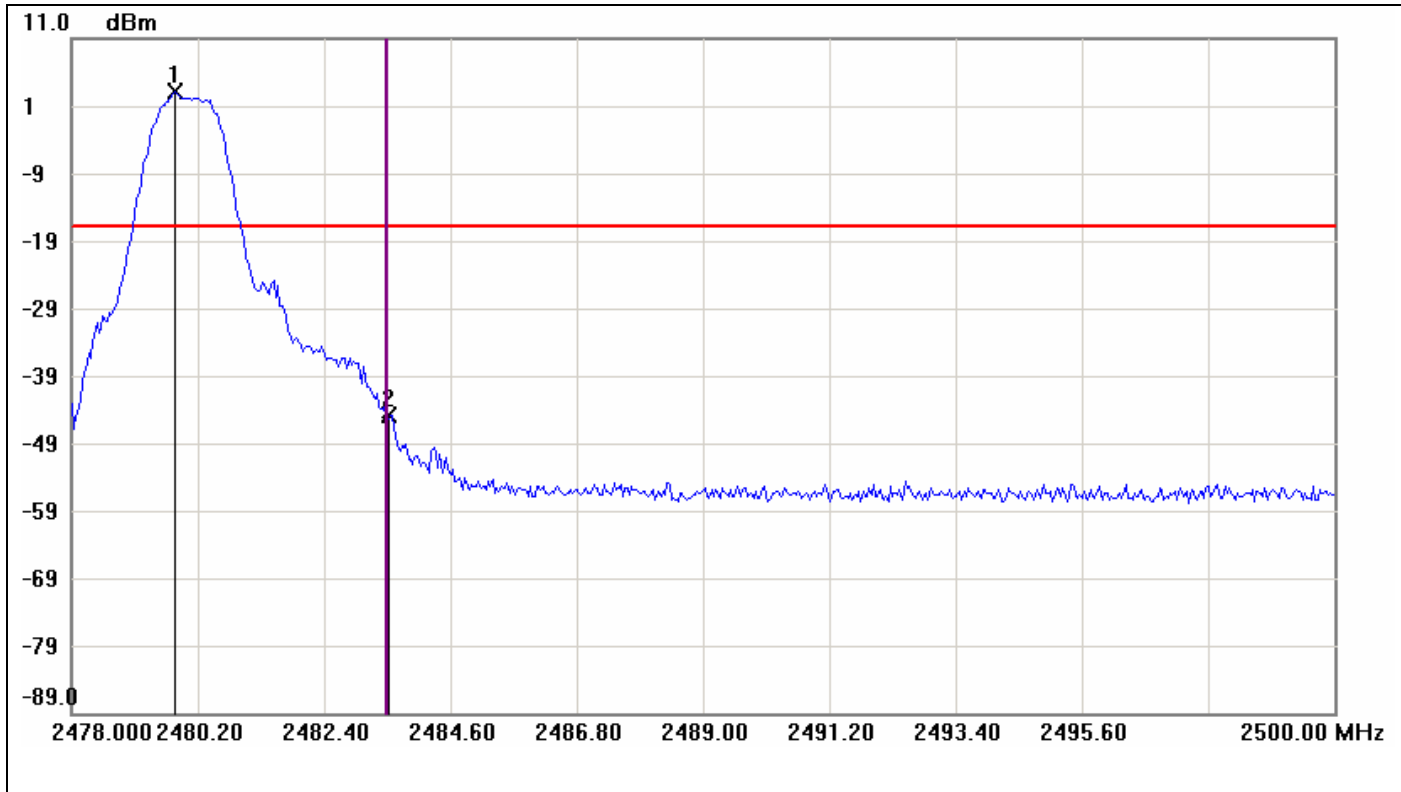

No.	Frequency(MHz)	Result(dBm)	Limit(dBm)	Margin(dBm)
1	2479.7967	3.06	-16.94	20.00
2	2483.5367	-44.81	-16.94	-27.87



### Hopping Mode

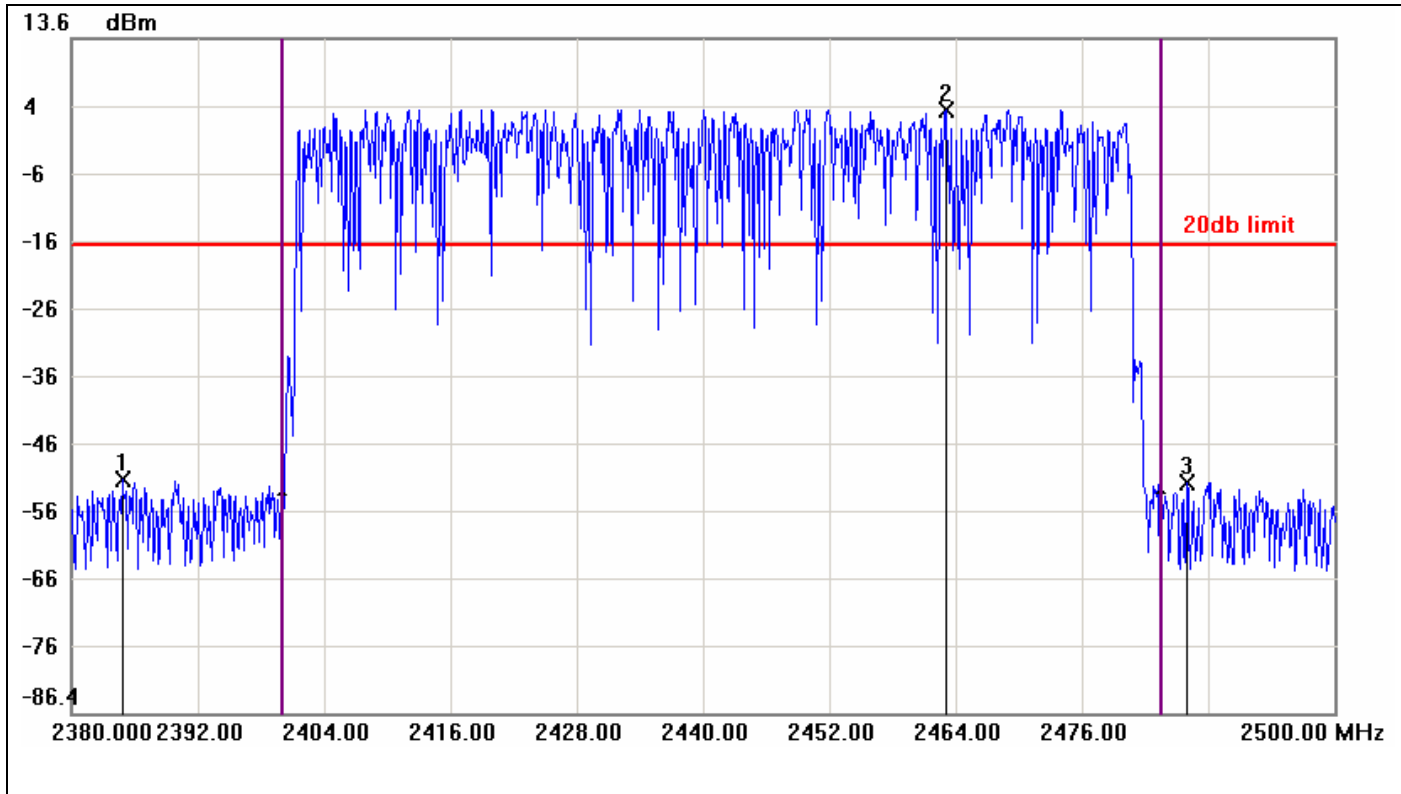

No.	Frequency(MHz)	Result(dBm)	Limit(dBm)	Margin(dBm)
1	2384.8000	-51.80	-16.96	-34.84
2	2463.0400	3.04	-16.96	20.00
3	2485.9600	-52.21	-16.96	-35.25



## 7.4 FREQUENCY SEPARATION

### LIMIT

According to §15.247(a)(1), Frequency hopping systems shall have hopping channel carrier frequencies separated by a minimum of 25 kHz or the 20 dB bandwidth of the hopping channel, whichever is greater. Alternatively, frequency hopping systems operating in the 2400-2483.5 MHz band may have hopping channel carrier frequencies that are separated by 25 kHz or two-thirds of the 20 dB bandwidth of the hopping channel, whichever is greater, provided the systems operate with an output power no greater than 125 mW.

### Test Configuration

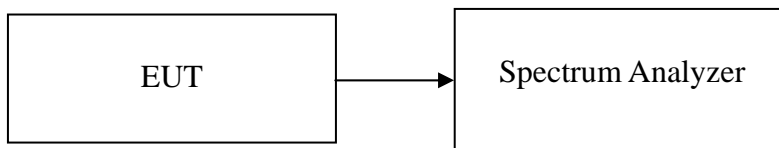

### TEST PROCEDURE

1. Place the EUT on the table and set it in transmitting mode.
2. Remove the antenna from the EUT and then connect a low loss RF cable from the antenna port to the spectrum analyzer.
3. Set center frequency of spectrum analyzer = middle of hopping channel.
4. Set the spectrum analyzer as RBW = 30kHz, VBW = 100kHz, Sweep = 3.2 ms.
5. Max hold, mark 3 peaks of hopping channel and record the 3 peaks frequency.

### TEST RESULTS

*No non-compliance noted*

#### Test Data

##### **For GFSK / DH5**

Channel Separation (MHz)	two-thirds of the 20 dB bandwidth	Channel Separation Limit	Result
1.00	640	>two-thirds of the 20 dB bandwidth	Pass

##### **For 8DPSK / DH5**

Channel Separation (MHz)	two-thirds of the 20 dB bandwidth	Channel Separation Limit	Result
0.995	876.66	>two-thirds of the 20 dB bandwidth	Pass



**Test Plot**

For GFSK / DH5

**Measurement of Channel Separation**

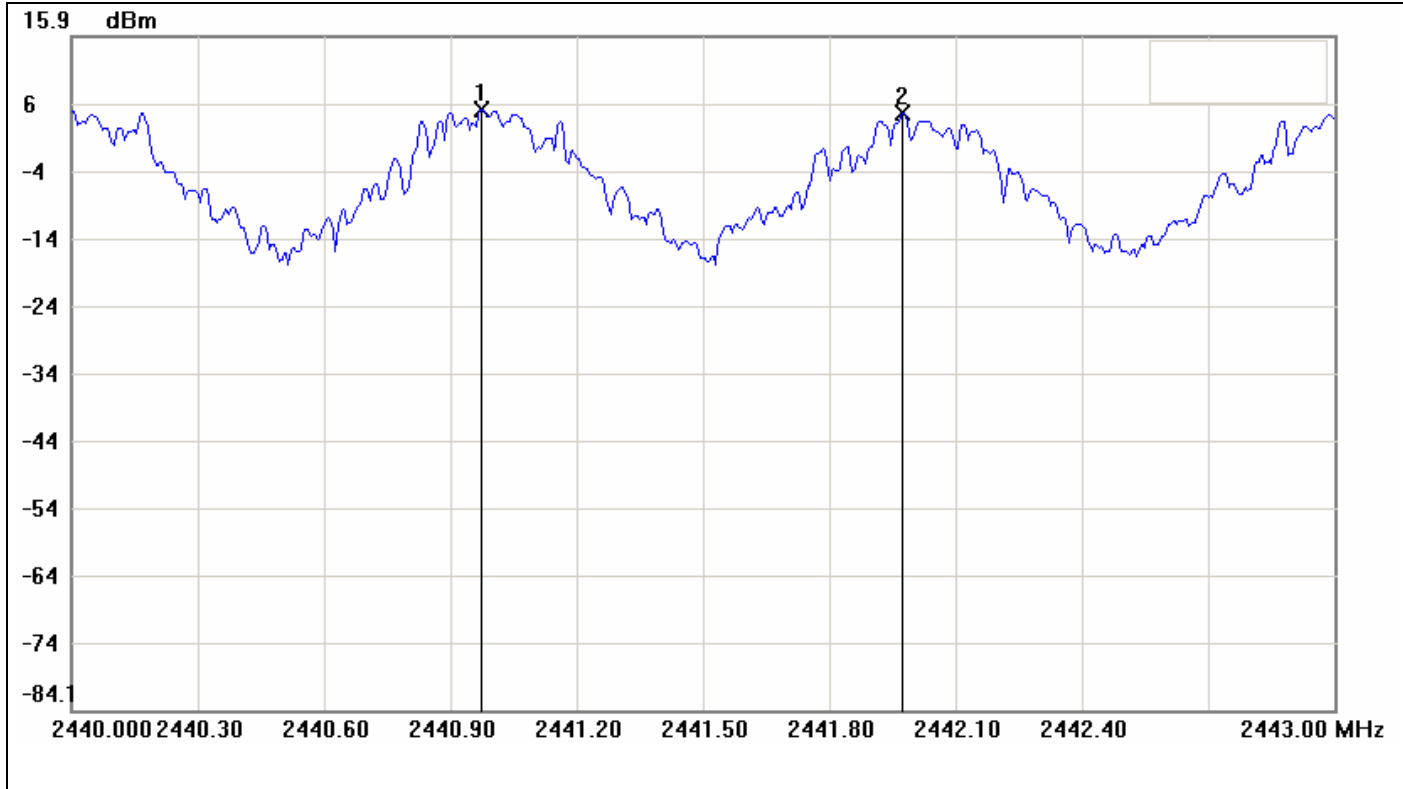

No.	Frequency(MHz)	Level(dBm)	Limit(dBm)	Margin(dBm)
1	2440.9750	5.05		
2	2441.9750	4.39		

No.		$\Delta$ Frequency(MHz)	$\Delta$ Level(dB)
1	mk2-mk1	1	-0.66



### Measurement of 20dB Bandwidth

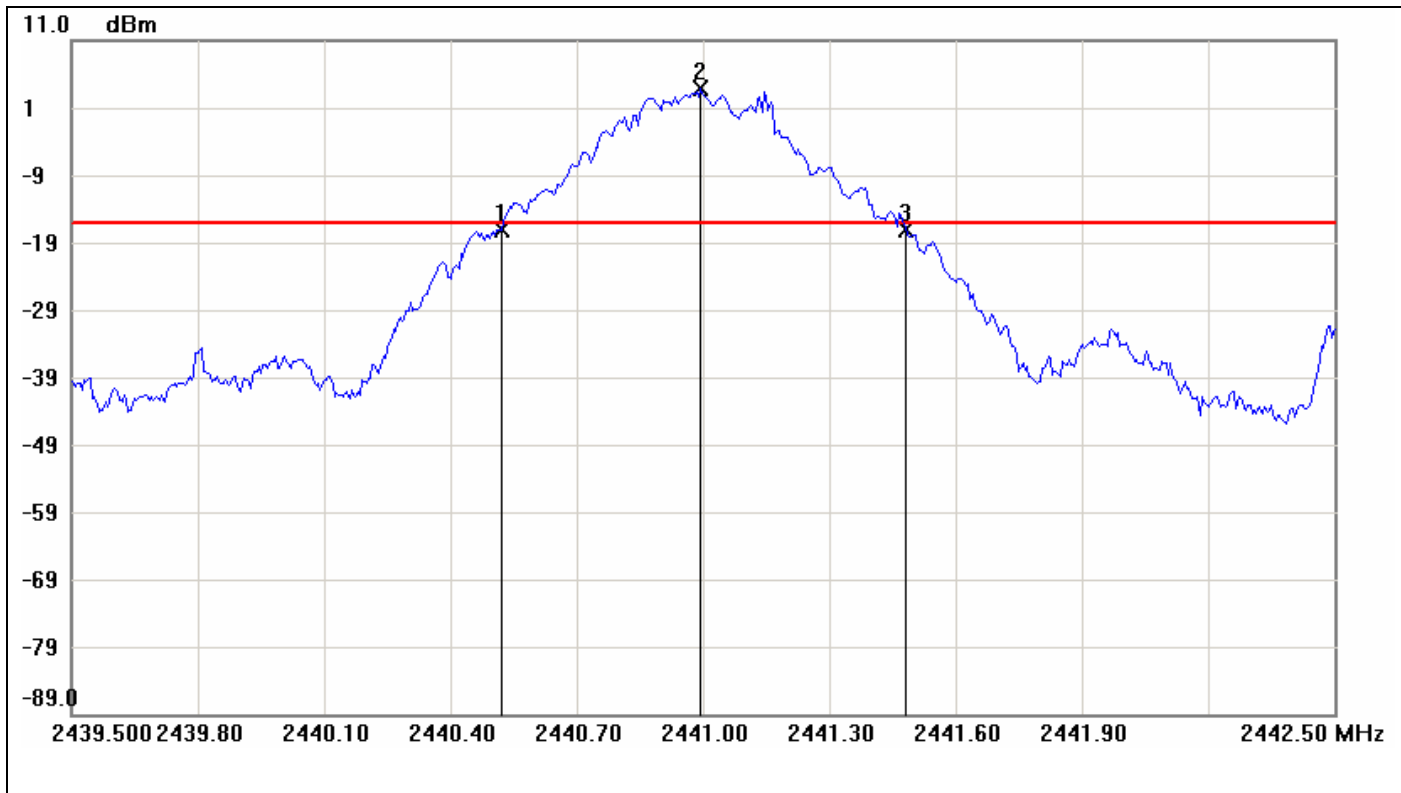

No.	Frequency(MHz)	Result(dBm)	Limit(dBm)	Margin(dBm)
1	2440.5200	-17.09	-16.19	-0.90
2	2440.9950	3.81	-16.19	20.00
3	2441.4800	-17.00	-16.19	-0.81

No.		$\Delta$ Frequency(MHz)	$\Delta$ Level(dB)
1	mk3-mk1	0.96	0.09



For 8DPSK / DH5

Measurement of Channel Separation

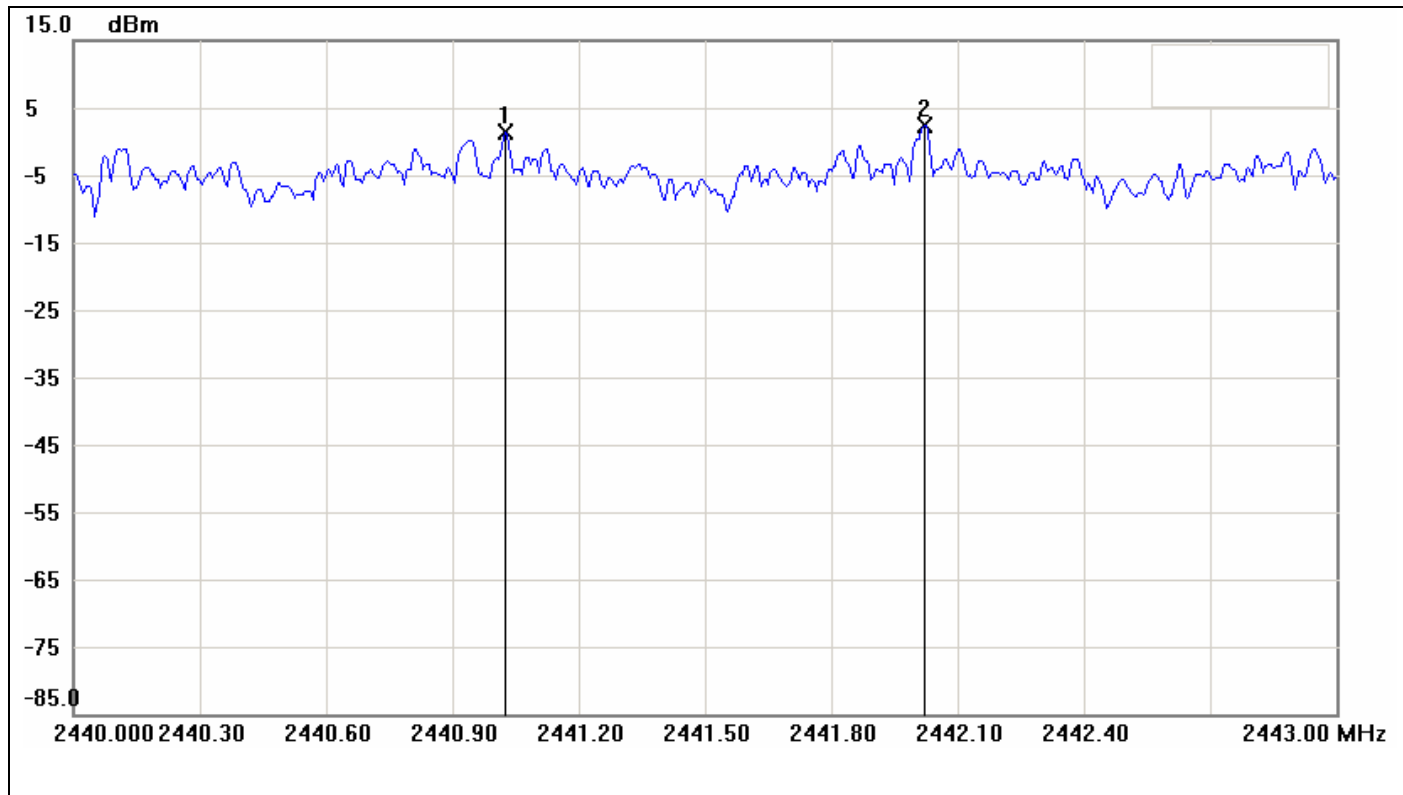

No.	Frequency(MHz)	Level(dBm)	Limit(dBm)	Margin(dBm)
1	2441.0250	1.24		
2	2442.0200	2.42		

No.		$\Delta$ Frequency(MHz)	$\Delta$ Level(dB)
1	mk2-mk1	0.995	1.18



**Measurement of 20dB Bandwidth**

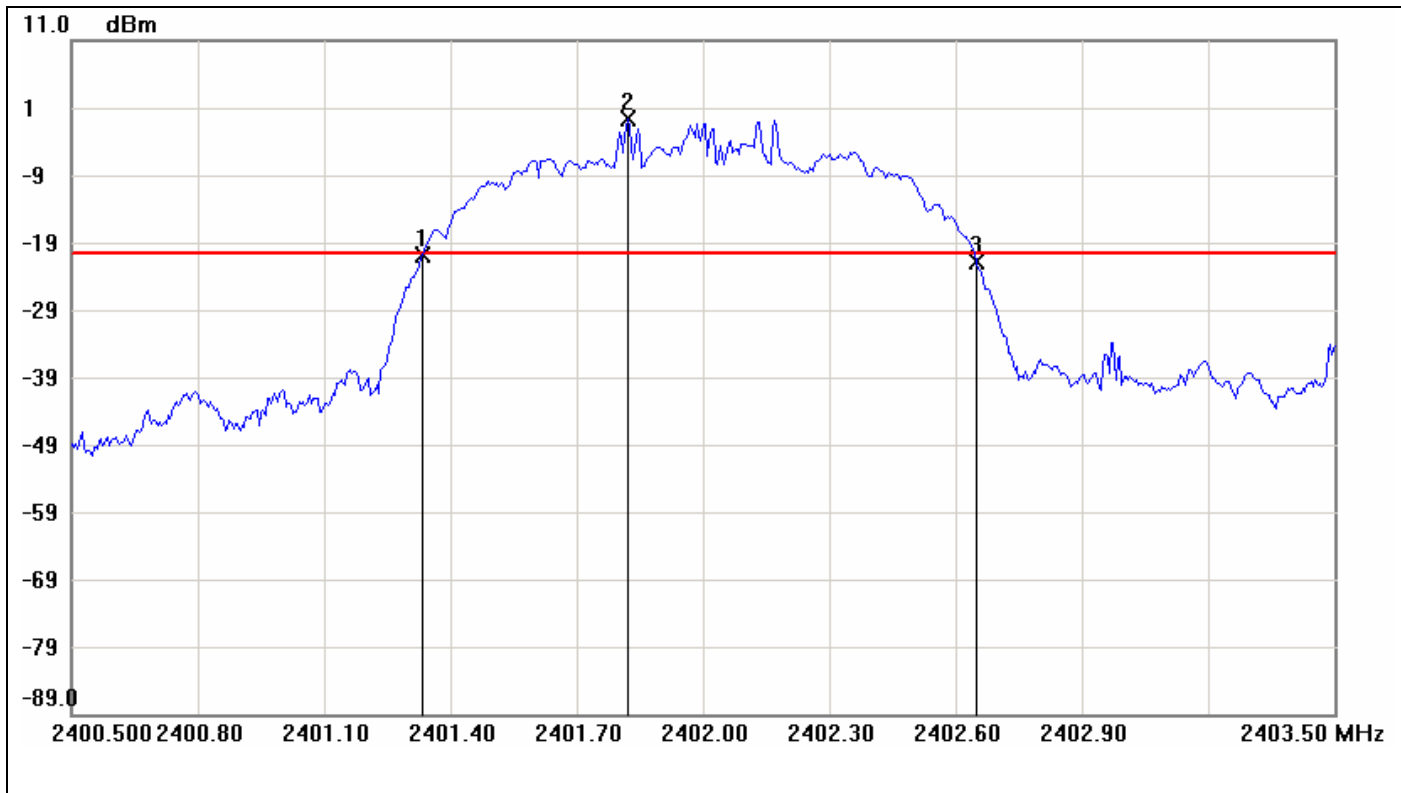

No.	Frequency(MHz)	Result(dBm)	Limit(dBm)	Margin(dBm)
1	2401.3350	-20.94	-20.61	-0.33
2	2401.8200	-0.61	-20.61	20.00
3	2402.6500	-21.97	-20.61	-1.36

No.		$\Delta$ Frequency(MHz)	$\Delta$ Level(dB)
1	mk3-mk1	1.315	-1.03



## 7.5 NUMBER OF HOPPING FREQUENCY

### LIMIT

According to §15.247(a)(1)(iii), Frequency hopping systems operating in the 2400MHz-2483.5 MHz bands shall use at least 15 hopping frequencies.

### Test Configuration

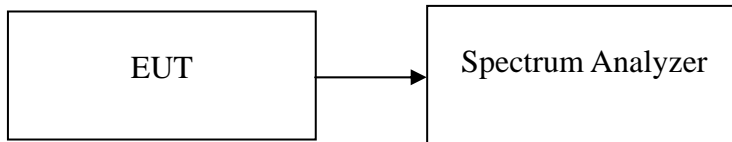

### TEST PROCEDURE

1. Place the EUT on the table and set it in transmitting mode.
2. Remove the antenna from the EUT and then connect a low loss RF cable from the antenna port to the spectrum analyzer.
3. Set spectrum analyzer Start=2400MHz, Stop = 2430.5MHz, Sweep = auto  
Start=2430.5MHz, Stop = 2460.5MHz, Sweep = auto and Start=2460.5MHz, Stop = 2485.5MHz, Sweep = auto.
4. Set the spectrum analyzer as RBW, VBW=510kHz.
5. Max hold, view and count how many channel in the band.

### TEST RESULTS

*No non-compliance noted*

#### Test Data

Result (No. of CH)	Limit (No. of CH)	Result
79	>15	PASS





**Test Plot**

**For GFSK**

**Channel Number**

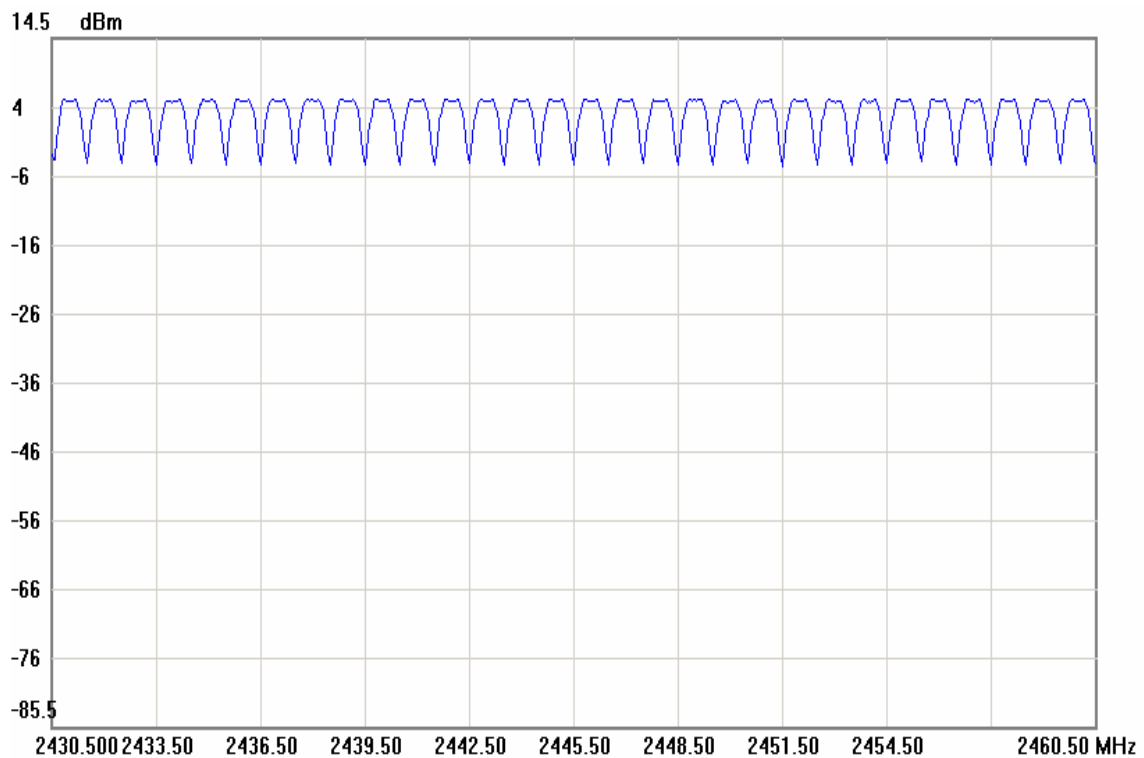
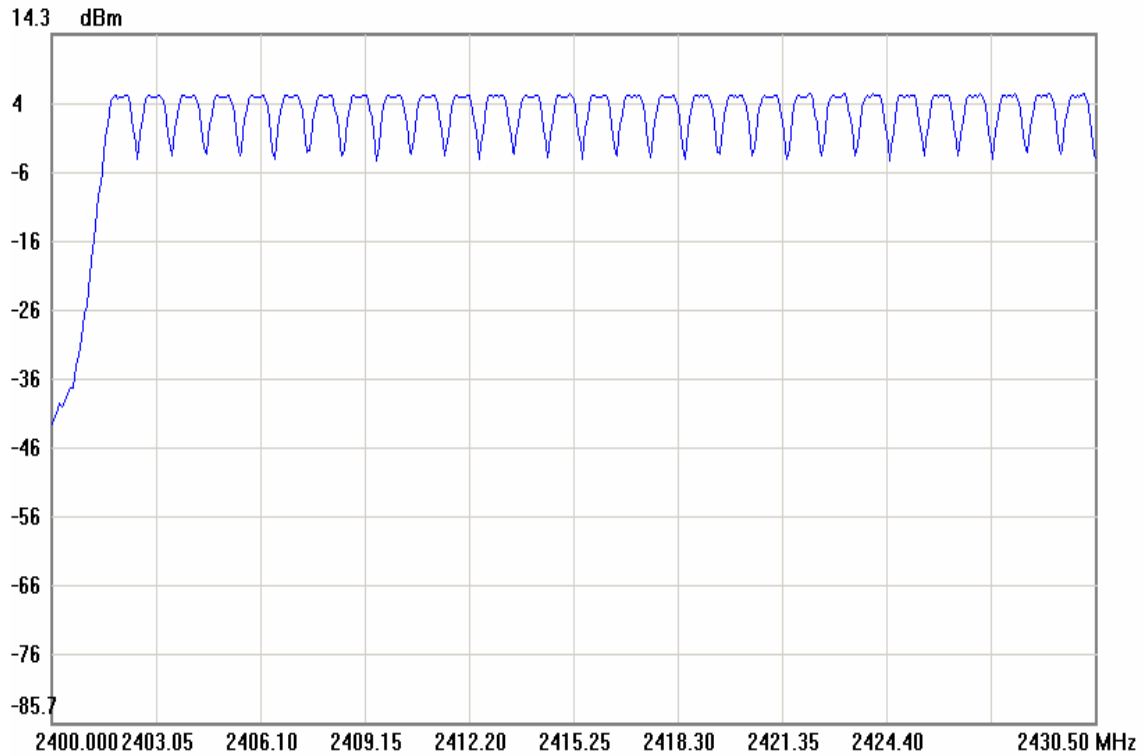

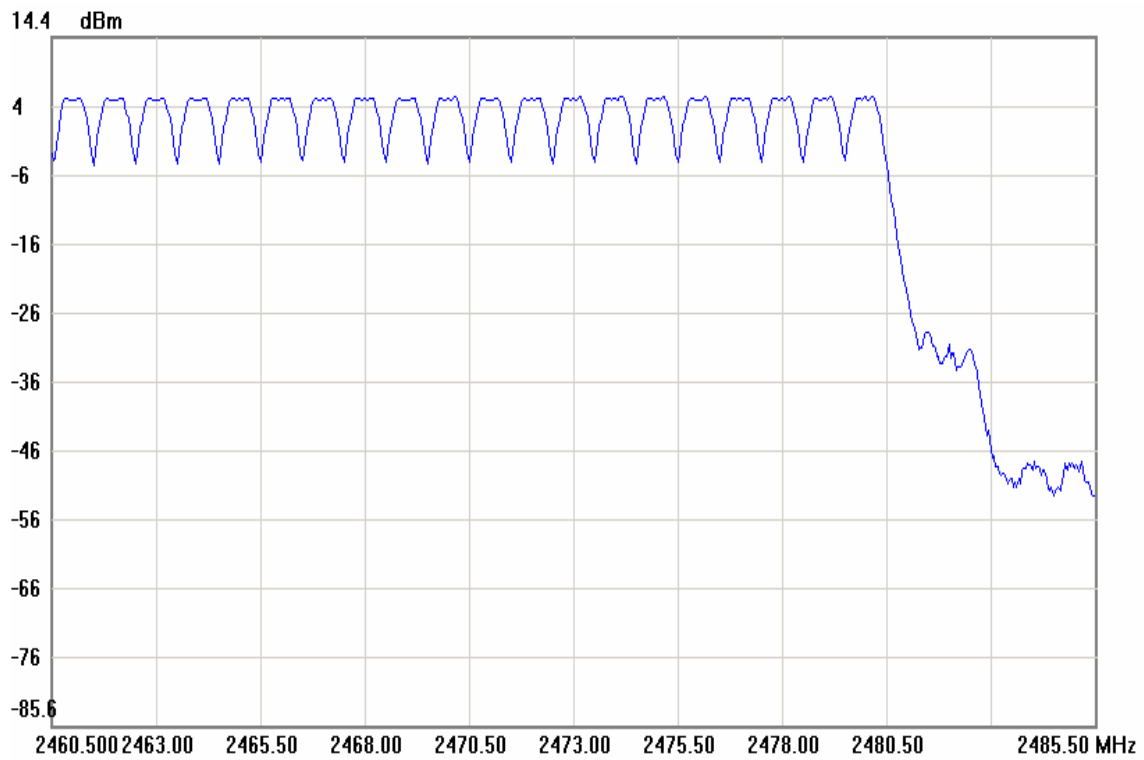



**For 8DPSK**

**Channel Number**

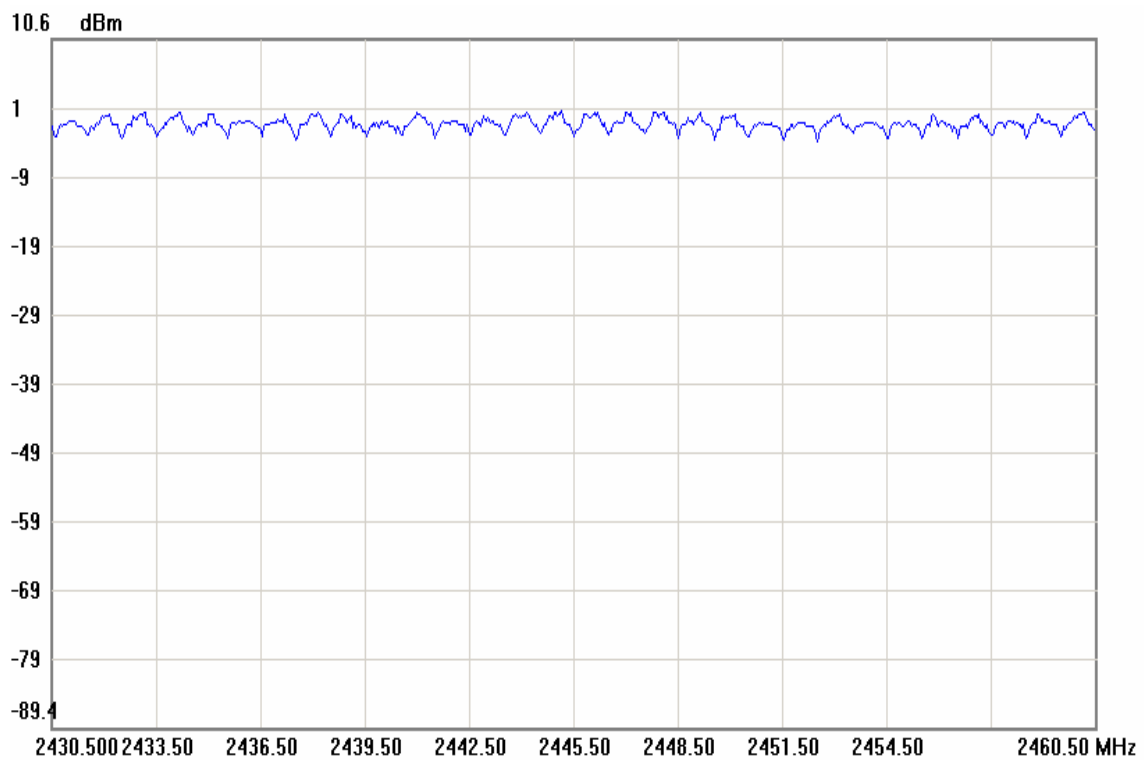
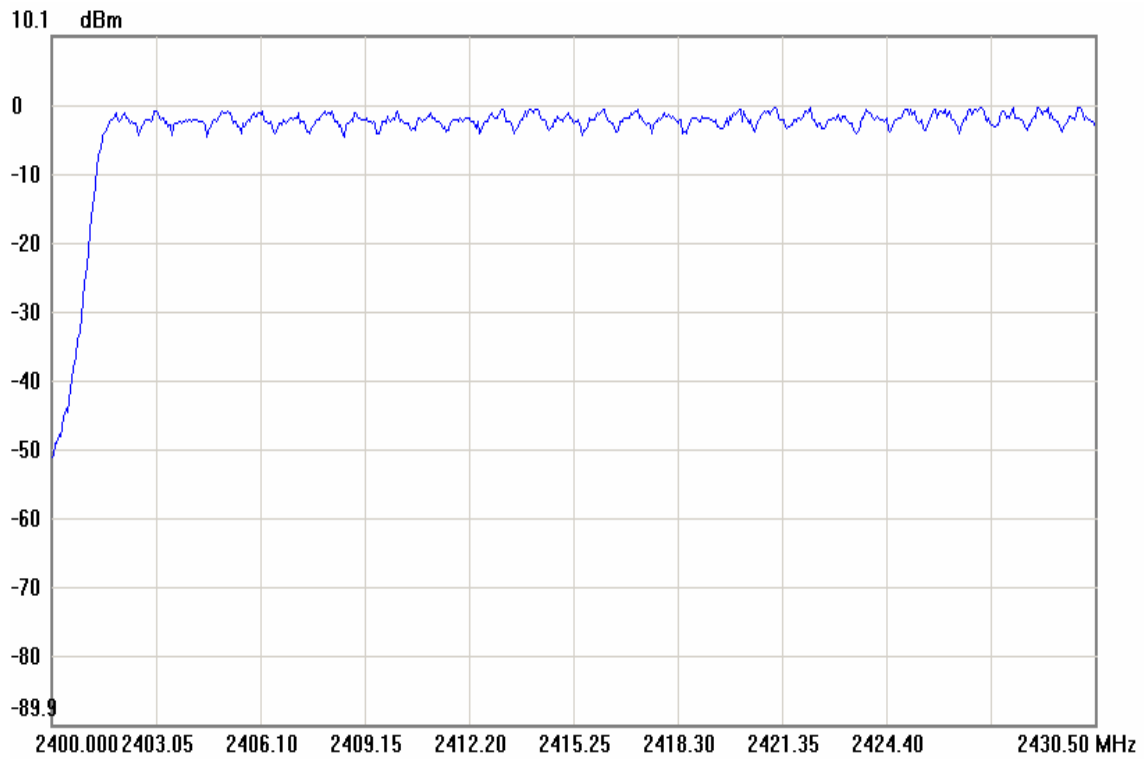

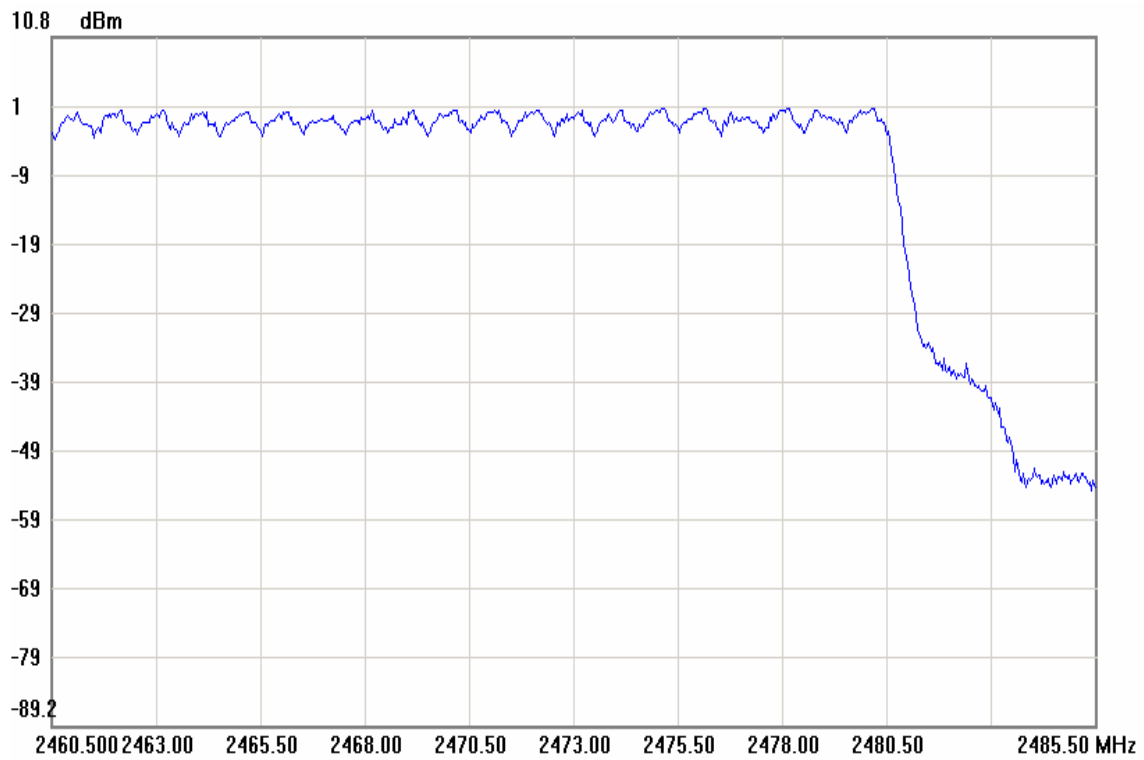



## 7.6 TIME OF OCCUPANCY (DWELL TIME)

### LIMIT

According to §15.247(a)(1)(iii), Frequency hopping systems operating in the 2400MHz-2483.5 MHz bands. The average time of occupancy on any channels shall not greater than 0.4 s within a period 0.4 s multiplied by the number of hopping channels employed.

### Test Configuration

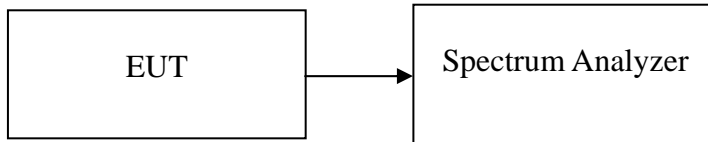

### TEST PROCEDURE

1. Place the EUT on the table and set it in transmitting mode.
2. Remove the antenna from the EUT and then connect a low loss RF cable from the antenna port to the spectrum analyzer.
3. Set center frequency of spectrum analyzer = operating frequency.
4. Set the spectrum analyzer as RBW, VBW=1MHz, Sweep = 1 ms.
5. Repeat above procedures until all frequency measured were complete.

### TEST RESULTS

*No non-compliance noted*



### For GFSK

#### Test Data

##### DH 1

CH Low:  $0.385 * (1600/2)/79 * 31.6 = 123.200$  (ms)

CH Mid:  $0.385 * (1600/2)/79 * 31.6 = 123.200$  (ms)

CH High:  $0.385 * (1600/2)/79 * 31.6 = 123.200$  (ms)

CH	Pulse Time (ms)	Total of Dwell (ms)	Period Time (s)	Limit (ms)	Result
Low	0.385	123.200	31.60	400.00	PASS
Mid	0.385	123.200	31.60		PASS
High	0.385	123.200	31.60		PASS

##### DH 3

CH Low:  $1.645 * (1600/4)/79 * 31.6 = 263.200$  (ms)

CH Mid:  $1.645 * (1600/4)/79 * 31.6 = 263.200$  (ms)

CH High:  $1.645 * (1600/4)/79 * 31.6 = 263.200$  (ms)

CH	Pulse Time (ms)	Total of Dwell (ms)	Period Time (s)	Limit (ms)	Result
Low	1.645	263.200	31.60	400.00	PASS
Mid	1.645	263.200	31.60		PASS
High	1.645	263.200	31.60		PASS

##### DH 5

CH Low:  $2.891 * (1600/6)/79 * 31.6 = 308.373$  (ms)

CH Mid:  $2.891 * (1600/6)/79 * 31.6 = 308.373$  (ms)

CH High:  $2.891 * (1600/6)/79 * 31.6 = 308.373$  (ms)

CH	Pulse Time (ms)	Total of Dwell (ms)	Period Time (s)	Limit (ms)	Result
Low	2.891	308.373	31.60	400.00	PASS
Mid	2.891	308.373	31.60		PASS
High	2.891	308.373	31.60		PASS



**Test Plot**

**DH 1**

**CH Low**

Agilent

L

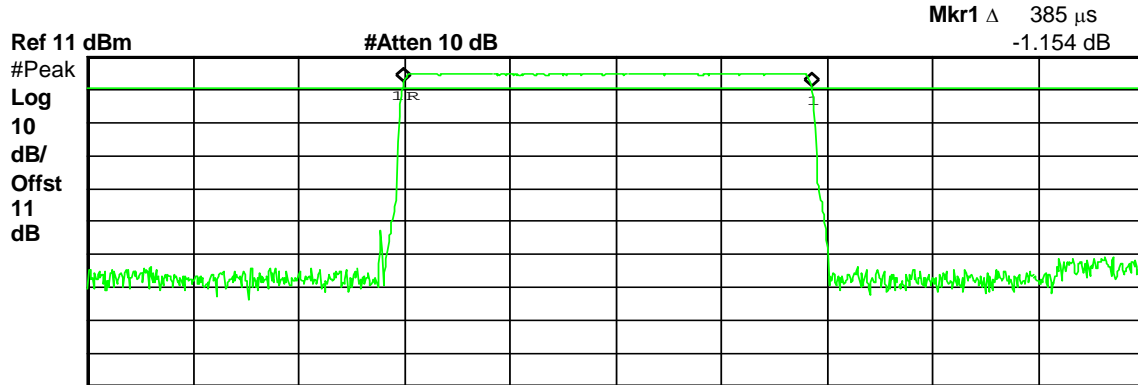

Center 2.402 GHz Span 0 Hz  
 Res BW 1 MHz #VBW 1 MHz Sweep 1 ms (1001 pts)

Marker	Trace	Type	X Axis	Amplitude
1R	(1)	Time	300 μs	3.193 dBm
1Δ	(1)	Time	385 μs	-1.154 dB

**CH Mid**

Agilent

L

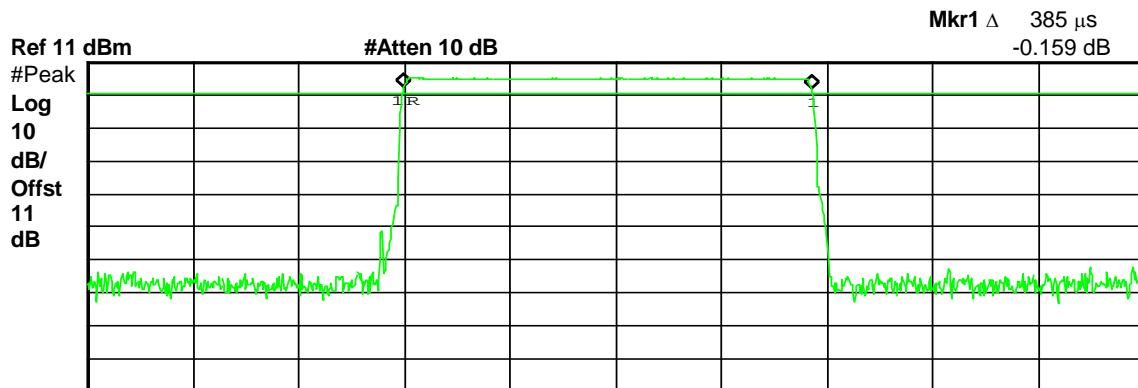

Center 2.441 GHz Span 0 Hz  
 Res BW 1 MHz #VBW 1 MHz Sweep 1 ms (1001 pts)

Marker	Trace	Type	X Axis	Amplitude
1R	(1)	Time	300 μs	3.193 dBm
1Δ	(1)	Time	385 μs	-0.159 dB



### CH High

Agilent

L

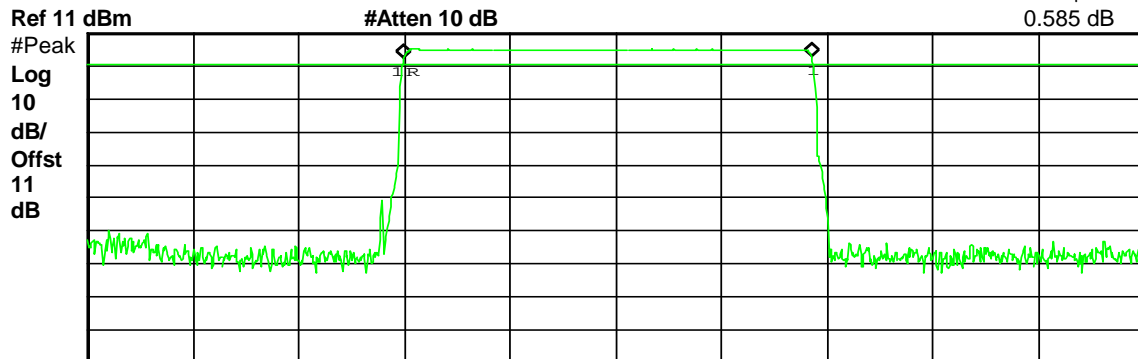

Center 2.48 GHz Span 0 Hz  
 Res BW 1 MHz #VBW 1 MHz Sweep 1 ms (1001 pts)

Marker	Trace	Type	X Axis	Amplitude
1R	(1)	Time	300 μs	3.193 dBm
1Δ	(1)	Time	385 μs	0.585 dB

### DH 3

### CH Low

Agilent

L

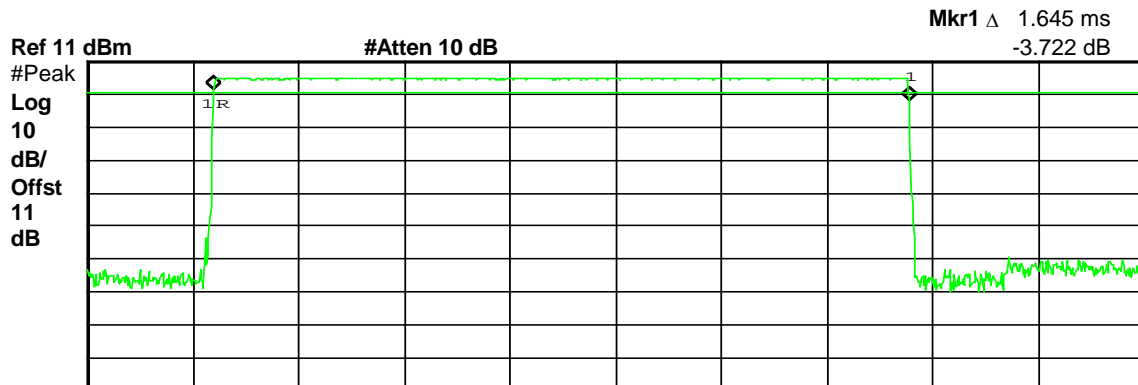

Center 2.402 GHz Span 0 Hz  
 Res BW 1 MHz #VBW 1 MHz Sweep 2.5 ms (1001 pts)

Marker	Trace	Type	X Axis	Amplitude
1R	(1)	Time	300 μs	2.562 dBm
1Δ	(1)	Time	1.645 ms	-3.722 dB





### CH Mid

Agilent

L

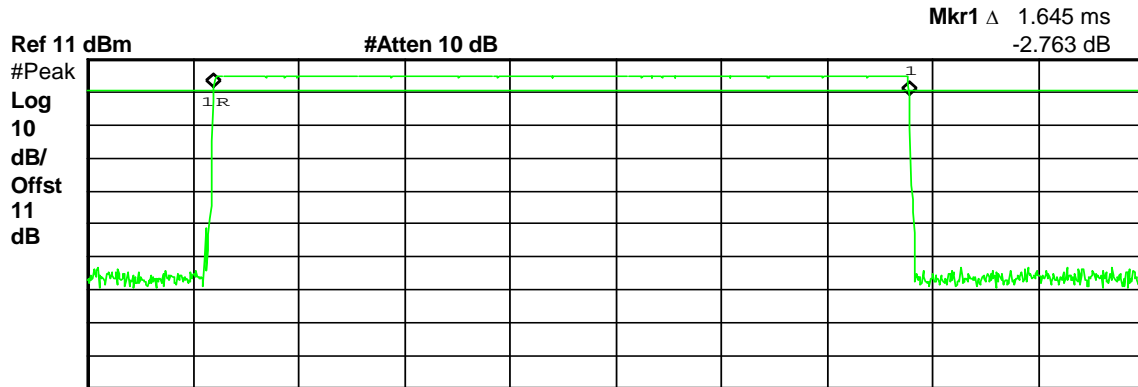

Center 2.441 GHz Res BW 1 MHz #VBW 1 MHz Sweep 2.5 ms (1001 pts) Span 0 Hz

Marker	Trace	Type	X Axis	Amplitude
1R	(1)	Time	300 μs	2.562 dBm
1Δ	(1)	Time	1.645 ms	-2.763 dB

### CH High

Agilent

L

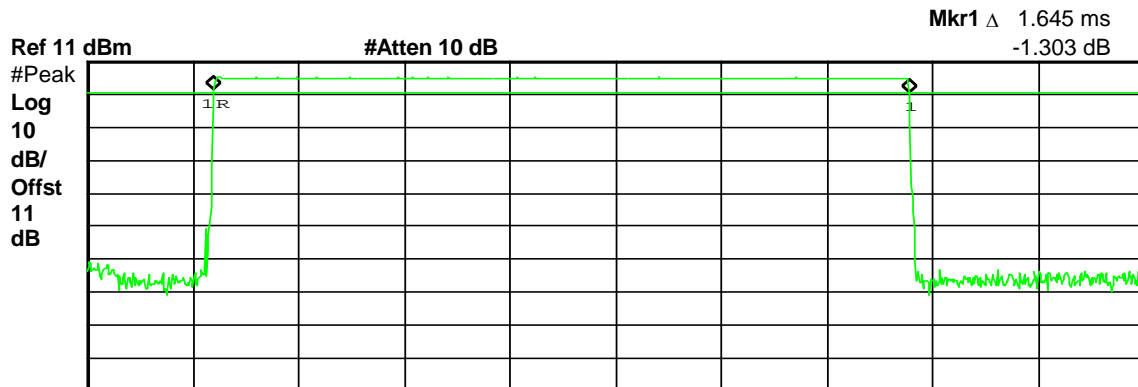

Center 2.48 GHz Res BW 1 MHz #VBW 1 MHz Sweep 2.5 ms (1001 pts) Span 0 Hz

Marker	Trace	Type	X Axis	Amplitude
1R	(1)	Time	300 μs	2.562 dBm
1Δ	(1)	Time	1.645 ms	-1.303 dB



### DH 5

#### CH Low

Agilent

L

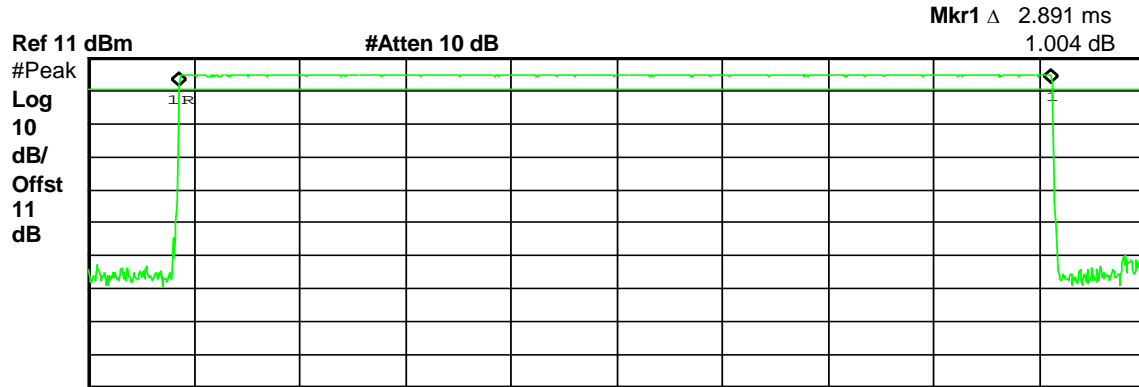

Center 2.402 GHz Res BW 1 MHz #VBW 1 MHz Sweep 3.5 ms (1001 pts) Span 0 Hz

Marker	Trace	Type	X Axis	Amplitude
1R	(1)	Time	300 μs	2.244 dBm
1Δ	(1)	Time	2.891 ms	1.004 dB

#### CH Mid

Agilent

L

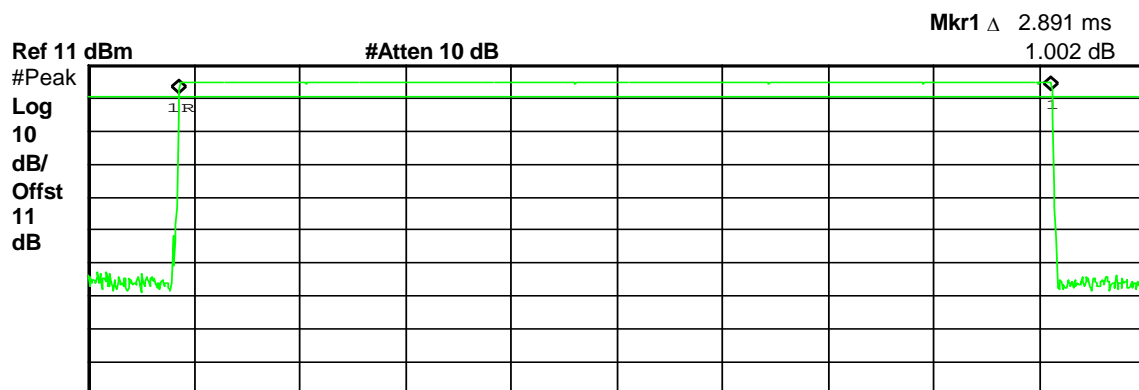

Center 2.441 GHz Res BW 1 MHz #VBW 1 MHz Sweep 3.5 ms (1001 pts) Span 0 Hz

Marker	Trace	Type	X Axis	Amplitude
1R	(1)	Time	300 μs	2.244 dBm
1Δ	(1)	Time	2.891 ms	1.002 dB



### CH High

Agilent

L

Mkr1  $\Delta$  2.891 ms  
0.296 dB

Ref 11 dBm

#Atten 10 dB

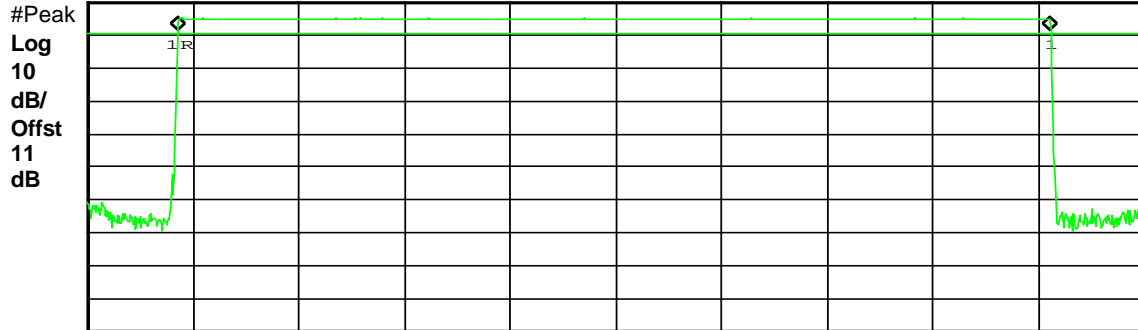

Center 2.48 GHz

Span 0 Hz

Res BW 1 MHz

#VBW 1 MHz

Sweep 3.5 ms (1001 pts)

Marker	Trace	Type	X Axis	Amplitude
1R	(1)	Time	300 $\mu$ s	2.244 dBm
1 $\Delta$	(1)	Time	2.891 ms	0.296 dB



### For 8DPSK

#### Test Data

##### DH 1

CH Low:  $0.397 * (1600/2)/79 * 31.6 = 127.040$  (ms)

CH Mid:  $0.397 * (1600/2)/79 * 31.6 = 127.040$  (ms)

CH High:  $0.397 * (1600/2)/79 * 31.6 = 127.040$  (ms)

CH	Pulse Time (ms)	Total of Dwell (ms)	Period Time (s)	Limit (ms)	Result
Low	0.397	127.040	31.60	400.00	PASS
Mid	0.397	127.040	31.60		PASS
High	0.397	127.040	31.60		PASS

##### DH 3

CH Low:  $1.648 * (1600/4)/79 * 31.6 = 263.680$  (ms)

CH Mid:  $1.648 * (1600/4)/79 * 31.6 = 263.680$  (ms)

CH High:  $1.648 * (1600/4)/79 * 31.6 = 263.680$  (ms)

CH	Pulse Time (ms)	Total of Dwell (ms)	Period Time (s)	Limit (ms)	Result
Low	1.648	263.680	31.60	400.00	PASS
Mid	1.648	263.680	31.60		PASS
High	1.648	263.680	31.60		PASS

##### DH 5

CH Low:  $2.901 * (1600/6)/79 * 31.6 = 309.440$  (ms)

CH Mid:  $2.901 * (1600/6)/79 * 31.6 = 309.440$  (ms)

CH High:  $2.901 * (1600/6)/79 * 31.6 = 309.440$  (ms)

CH	Pulse Time (ms)	Total of Dwell (ms)	Period Time (s)	Limit (ms)	Result
Low	2.901	309.440	31.60	400.00	PASS
Mid	2.901	309.440	31.60		PASS
High	2.901	309.440	31.60		PASS



**Test Plot**

**DH 1**

**CH Low**

Agilent

L

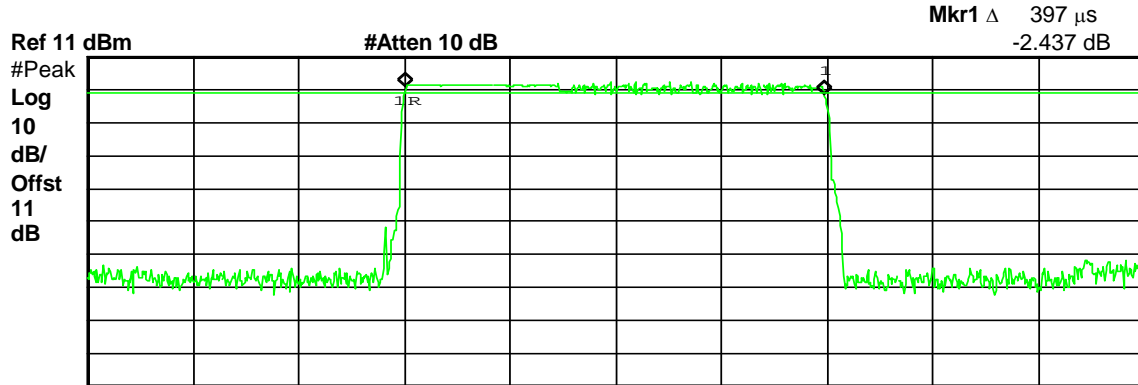

Center 2.402 GHz Span 0 Hz  
 Res BW 1 MHz #VBW 1 MHz Sweep 1 ms (1001 pts)

Marker	Trace	Type	X Axis	Amplitude
1R	(1)	Time	301 μs	1.725 dBm
1Δ	(1)	Time	397 μs	-2.437 dB

**CH Mid**

Agilent

L

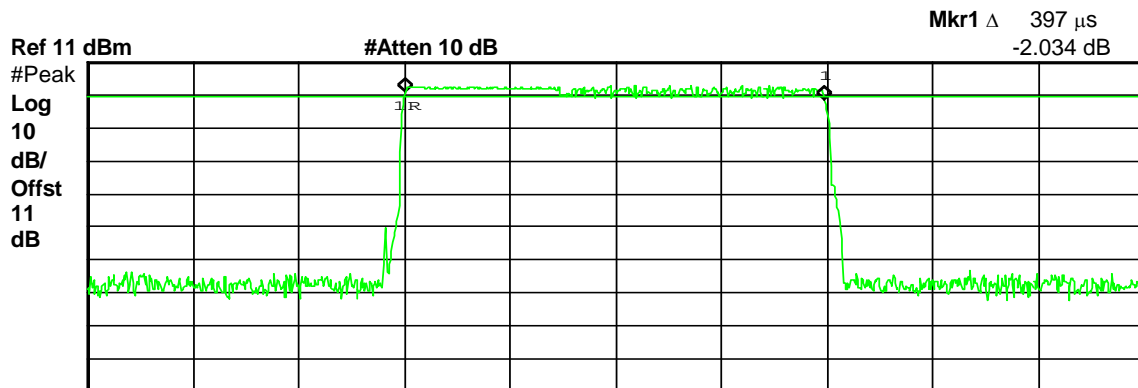

Center 2.441 GHz Span 0 Hz  
 Res BW 1 MHz #VBW 1 MHz Sweep 1 ms (1001 pts)

Marker	Trace	Type	X Axis	Amplitude
1R	(1)	Time	301 μs	1.725 dBm
1Δ	(1)	Time	397 μs	-2.034 dB



### CH High

Agilent

L

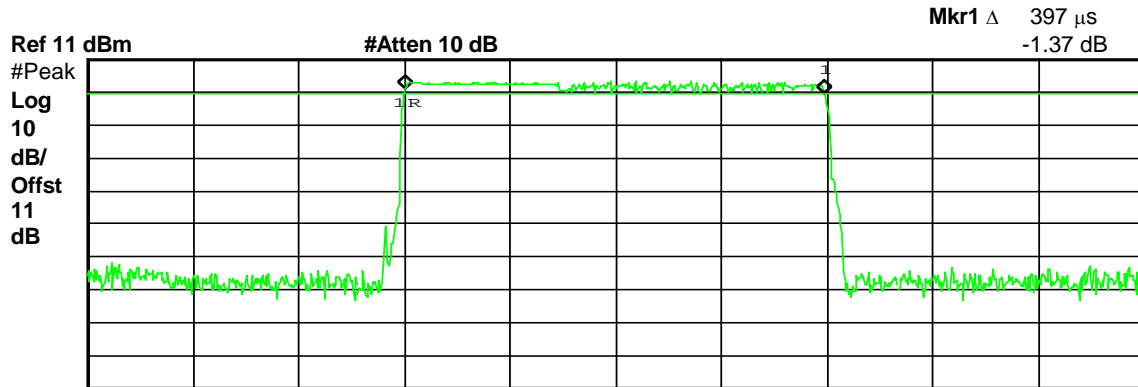

Center 2.48 GHz Res BW 1 MHz #VBW 1 MHz Sweep 1 ms (1001 pts) Span 0 Hz

Marker	Trace	Type	X Axis	Amplitude
1R	(1)	Time	301 μs	1.725 dBm
1Δ	(1)	Time	397 μs	-1.37 dB

### DH 3

### CH Low

Agilent

L

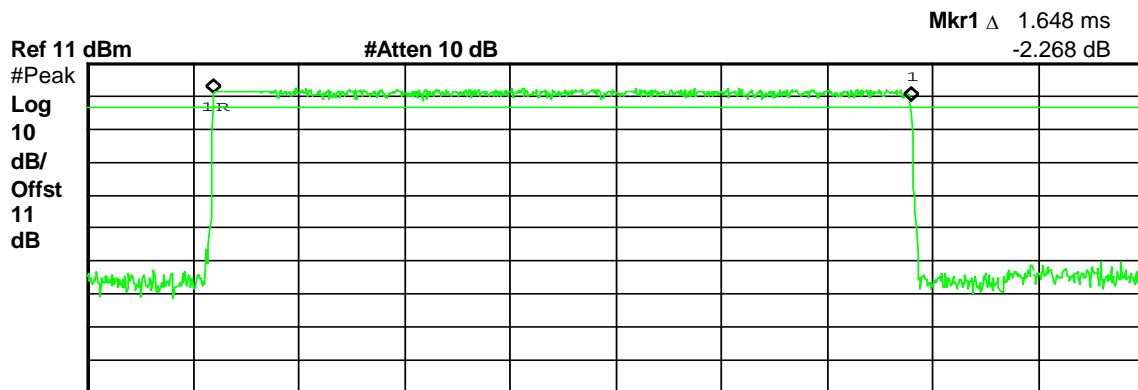

Center 2.402 GHz Res BW 1 MHz #VBW 1 MHz Sweep 2.5 ms (1001 pts) Span 0 Hz

Marker	Trace	Type	X Axis	Amplitude
1R	(1)	Time	300 μs	1.743 dBm
1Δ	(1)	Time	1.648 ms	-2.268 dB



### CH Mid

Agilent

L

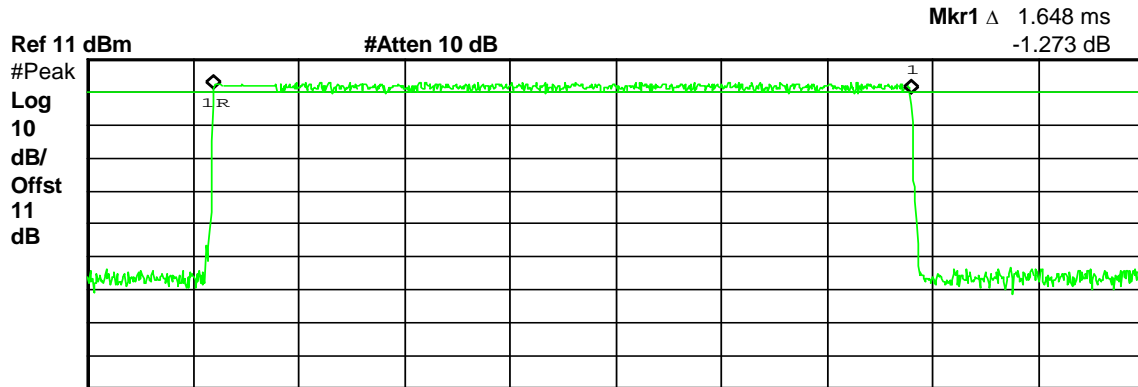

Center 2.441 GHz Res BW 1 MHz #VBW 1 MHz Sweep 2.5 ms (1001 pts) Span 0 Hz

Marker	Trace	Type	X Axis	Amplitude
1R	(1)	Time	300 μs	1.743 dBm
1Δ	(1)	Time	1.648 ms	-1.273 dB

### CH High

Agilent

L

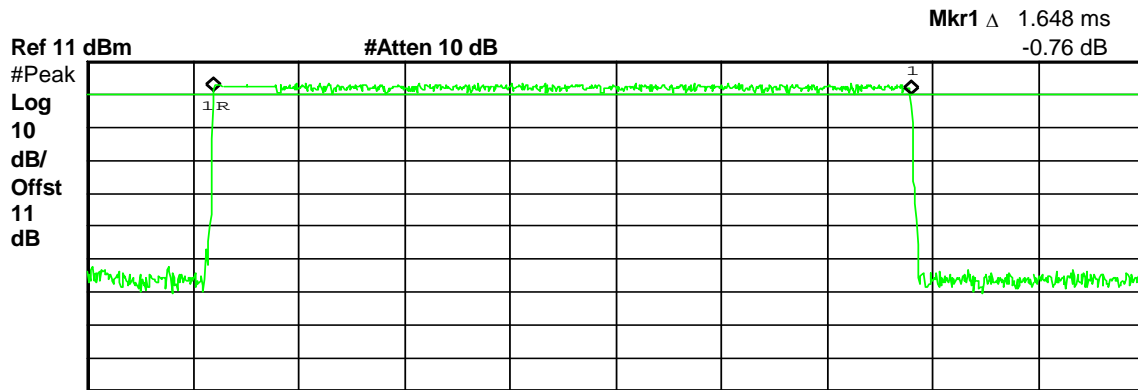

Center 2.48 GHz Res BW 1 MHz #VBW 1 MHz Sweep 2.5 ms (1001 pts) Span 0 Hz

Marker	Trace	Type	X Axis	Amplitude
1R	(1)	Time	300 μs	1.743 dBm
1Δ	(1)	Time	1.648 ms	-0.76 dB



### DH 5

#### CH Low

Agilent

L

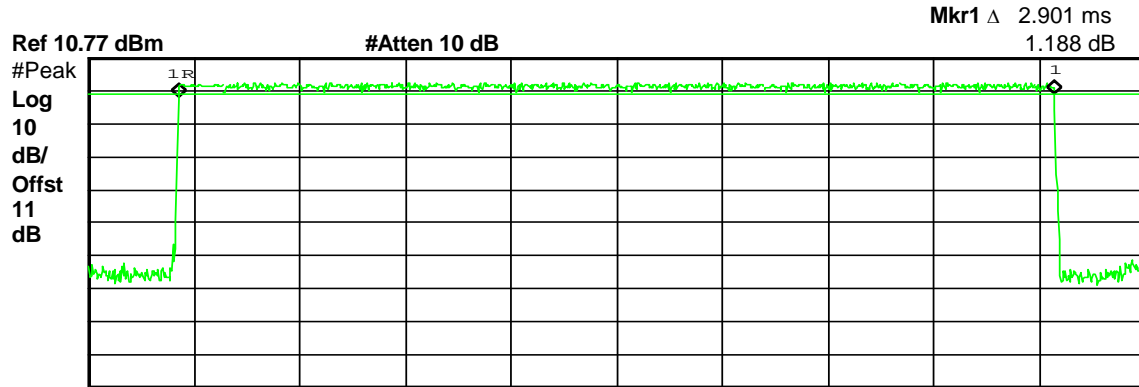

Center 2.402 GHz Span 0 Hz  
Res BW 1 MHz #VBW 1 MHz Sweep 3.5 ms (1001 pts)

Marker	Trace	Type	X Axis	Amplitude
1R	(1)	Time	298.9 μs	-1.317 dBm
1Δ	(1)	Time	2.901 ms	1.188 dB

#### CH Mid

Agilent

L

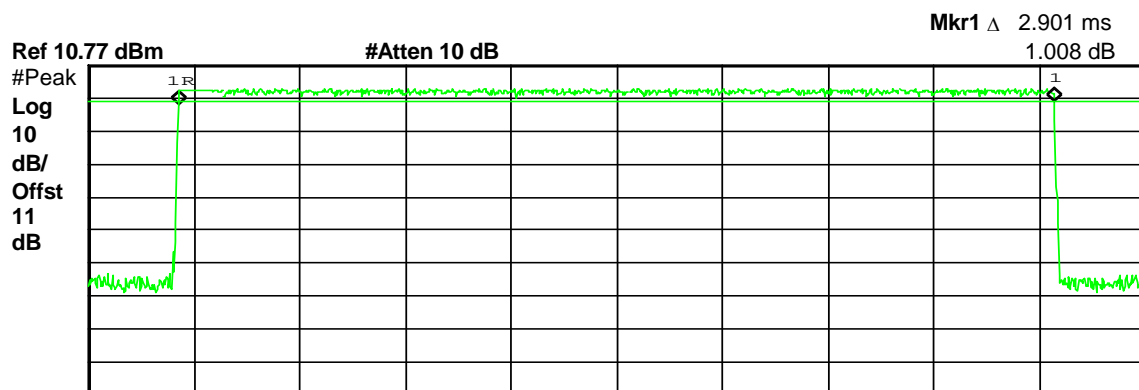

Center 2.441 GHz Span 0 Hz  
Res BW 1 MHz #VBW 1 MHz Sweep 3.5 ms (1001 pts)

Marker	Trace	Type	X Axis	Amplitude
1R	(1)	Time	298.9 μs	-1.317 dBm
1Δ	(1)	Time	2.901 ms	1.008 dB





### CH High

Agilent

L

Mkr1 Δ 2.901 ms  
2.087 dB

Ref 10.77 dBm

#Atten 10 dB

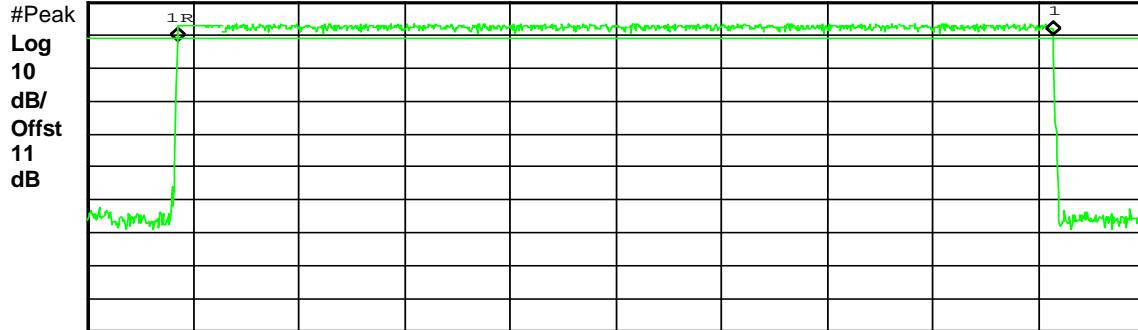

Center 2.48 GHz

Span 0 Hz

Res BW 1 MHz

#VBW 1 MHz

Sweep 3.5 ms (1001 pts)

Marker	Trace	Type	X Axis	Amplitude
1R	(1)	Time	298.9 μs	-1.317 dBm
1Δ	(1)	Time	2.901 ms	2.087 dB



## 7.7 SPURIOUS EMISSIONS

### 7.7.1 Conducted Measurement

#### **LIMIT**

According to §15.247(d), in any 100 kHz bandwidth outside the frequency bands in which the spread spectrum intentional radiator is operating, the radio frequency power that is produced by the intentional radiator shall be at least 20 dB below that in the 100 kHz bandwidth within the band that contains the highest level of the desired power, based on either an RF conducted or a radiated measurement, provided the transmitter demonstrates compliance with the peak conducted power limits. In addition, radiated emissions which fall in the restricted bands, as defined in §15.205(a), must also comply with the radiated emission limits specified in 15.209(a) (see Section 15.205(c)).

#### **Test Configuration**

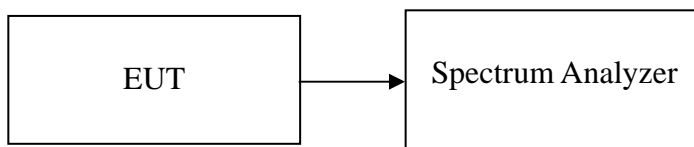

#### **TEST PROCEDURE**

Conducted RF measurements of the transmitter output were made to confirm that the EUT antenna port conducted emissions meet the specified limit and to identify any spurious signals that require further investigation or measurements on the radiated emissions site.

The transmitter output is connected to the spectrum analyzer. The resolution bandwidth is set to 100 kHz. The video bandwidth is set to 100 kHz.

Measurements are made over the 30MHz to 26GHz range with the transmitter set to the lowest, middle, and highest channels.

#### **TEST RESULTS**

*No non-compliance noted*



**Test Plot**

**For GFSK / DH5**

**CH Low**

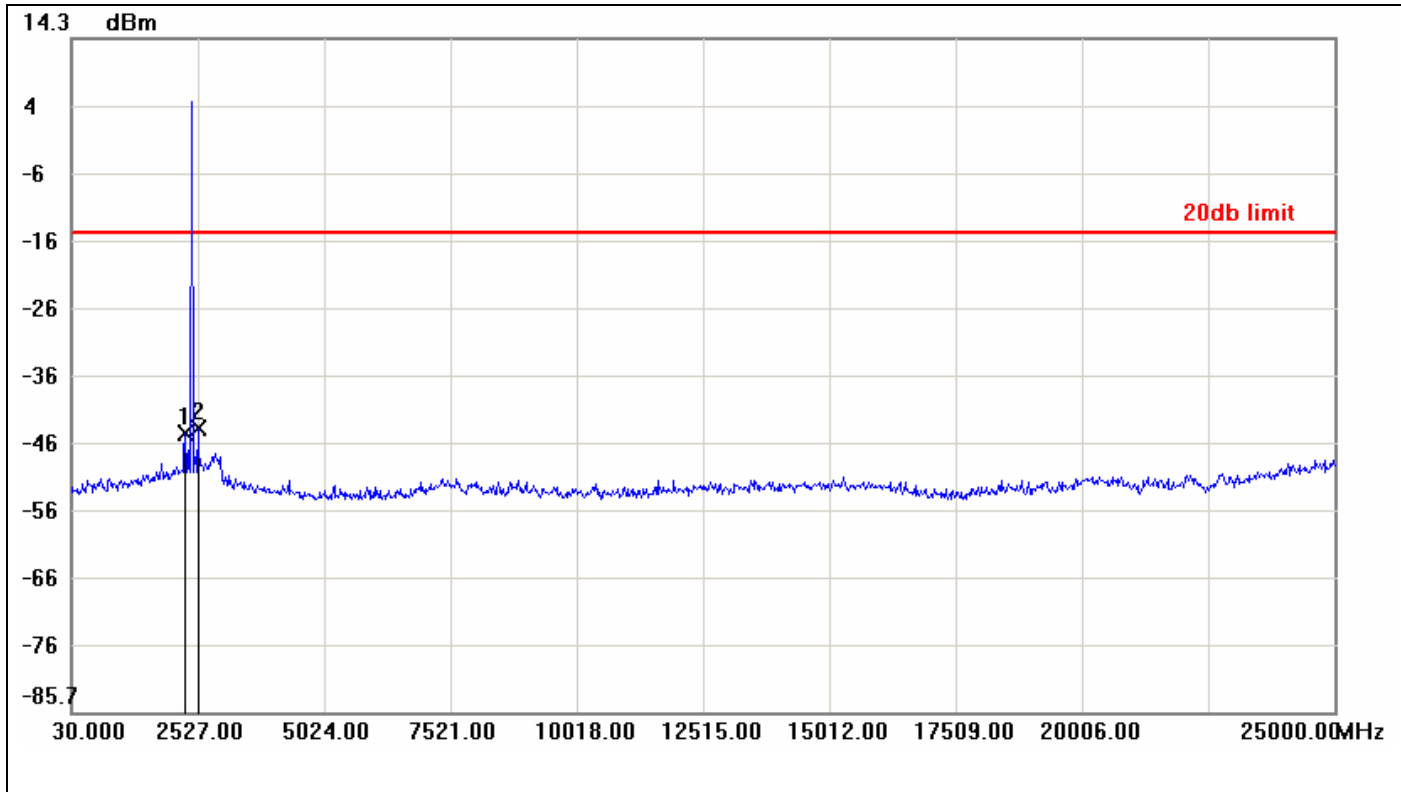

No.	Frequency(MHz)	Result(dBm)	Limit(dBm)	Margin(dBm)
1	2277.3000	-44.32	-14.56	-29.76
2	2527.0000	-43.58	-14.56	-29.02



### CH Mid

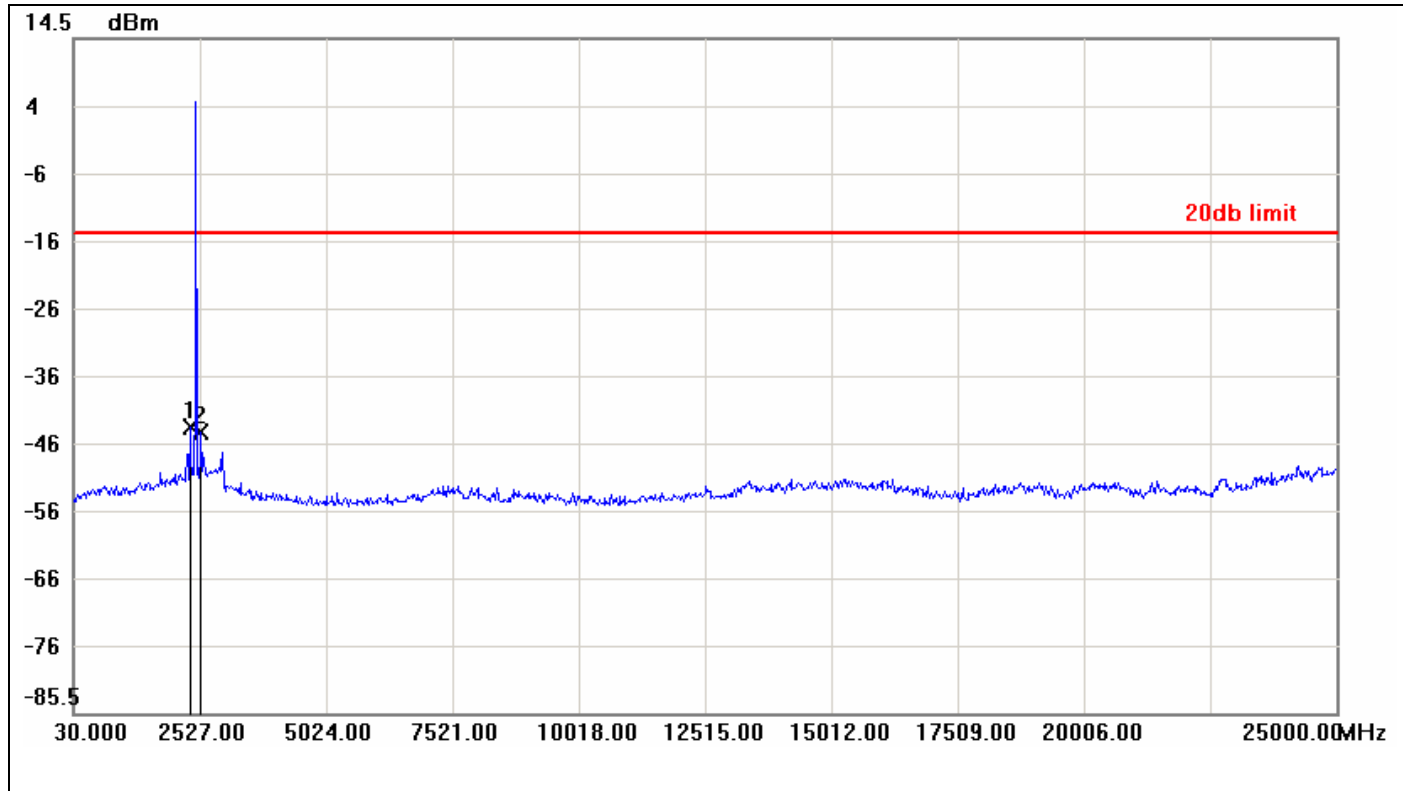

No.	Frequency(MHz)	Result(dBm)	Limit(dBm)	Margin(dBm)
1	2327.2400	-43.24	-14.45	-28.79
2	2551.9700	-44.02	-14.45	-29.57



### CH High

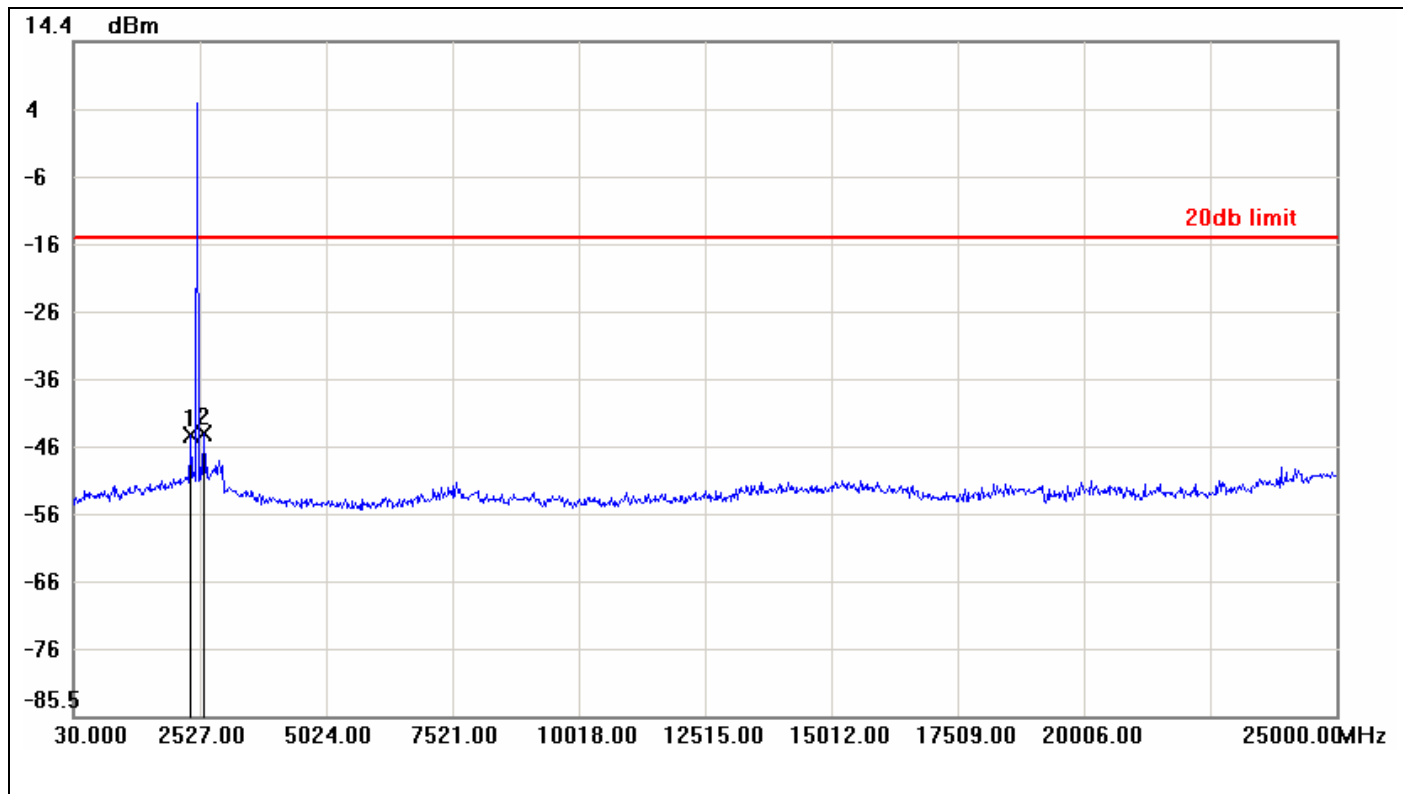

No.	Frequency(MHz)	Result(dBm)	Limit(dBm)	Margin(dBm)
1	2352.2100	-44.00	-14.60	-29.40
2	2601.9100	-43.77	-14.60	-29.17



For 8DPSK / DH5

CH Low

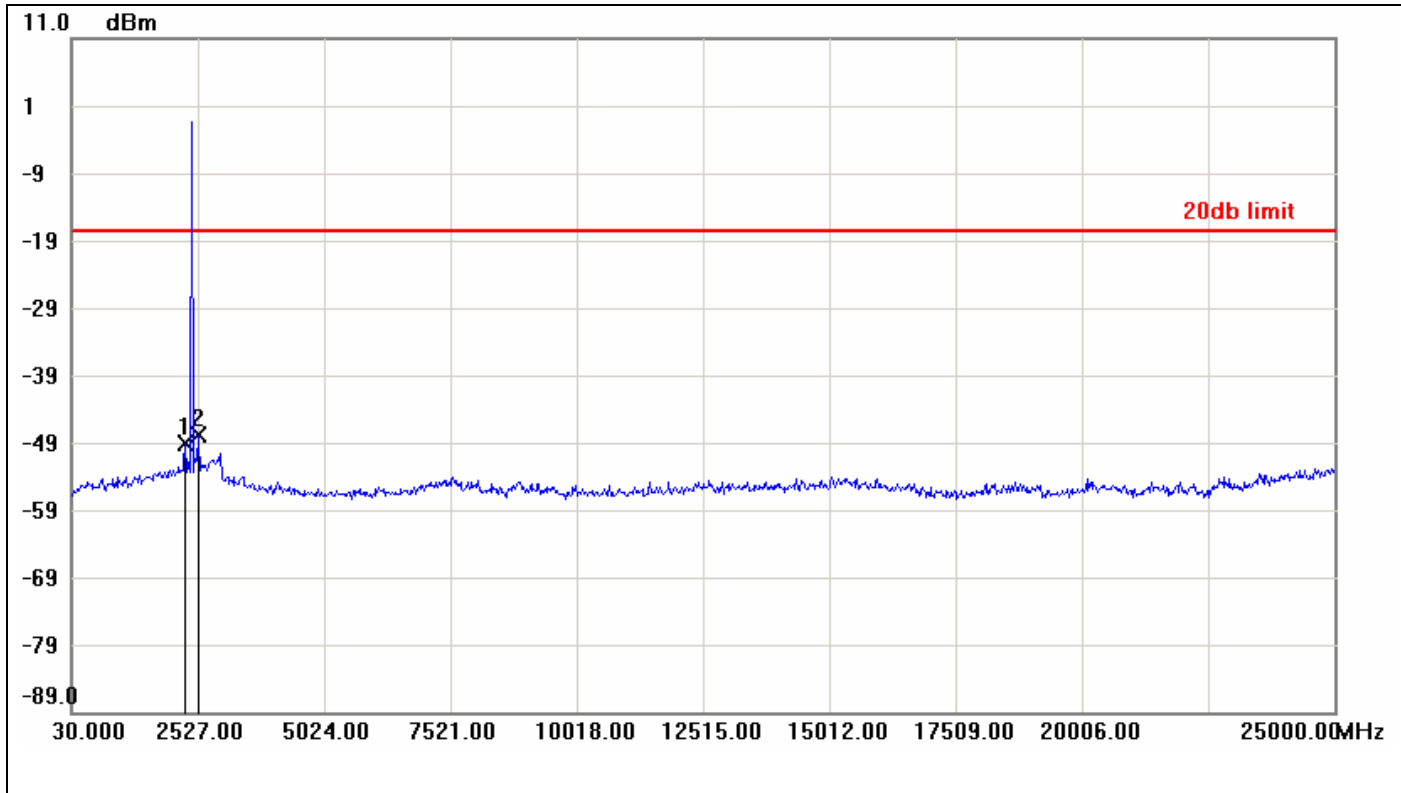

No.	Frequency(MHz)	Result(dBm)	Limit(dBm)	Margin(dBm)
1	2277.3000	-49.09	-17.59	-31.50
2	2527.0000	-47.84	-17.59	-30.25



### CH Mid

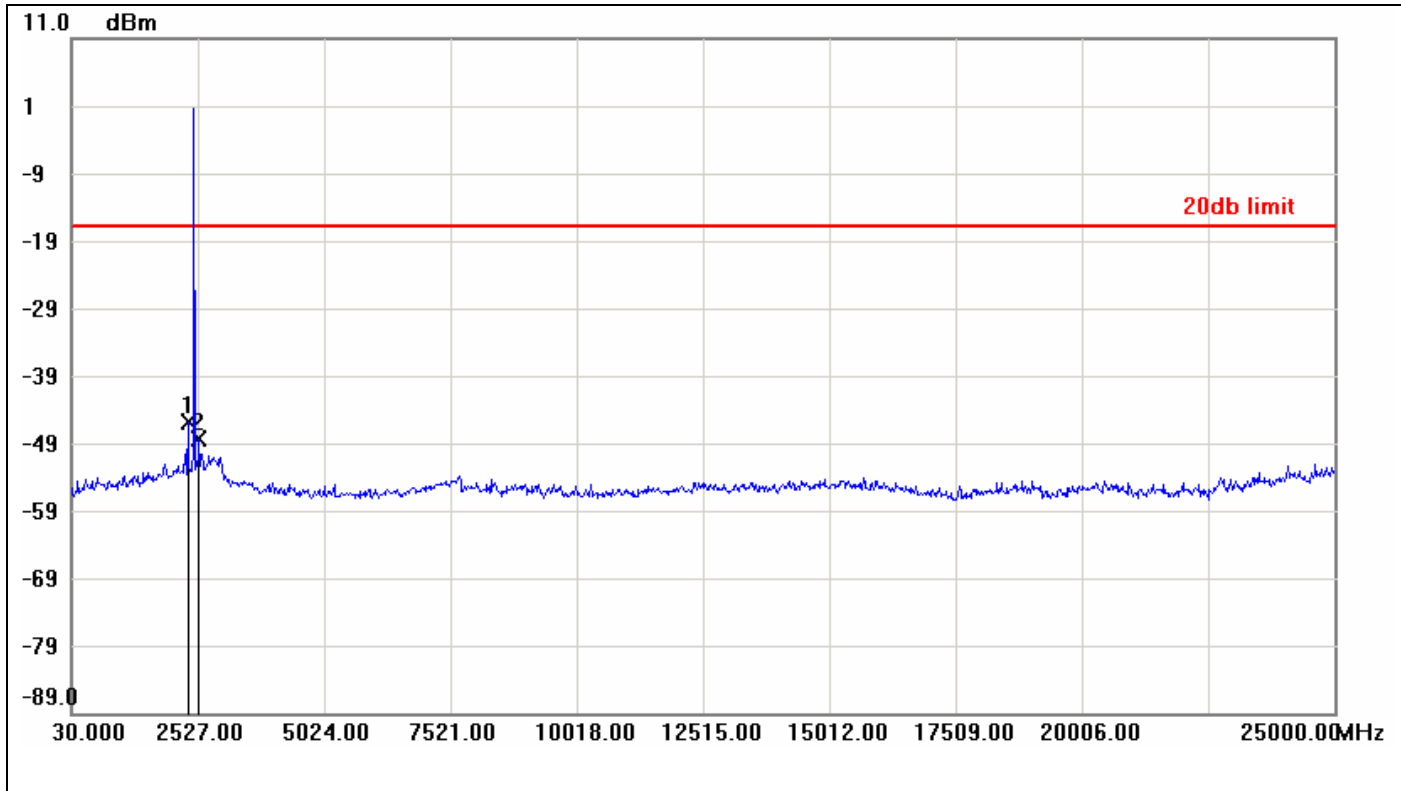

No.	Frequency(MHz)	Result(dBm)	Limit(dBm)	Margin(dBm)
1	2327.2400	-45.97	-16.83	-29.14
2	2551.9700	-48.34	-16.83	-31.51



### CH High

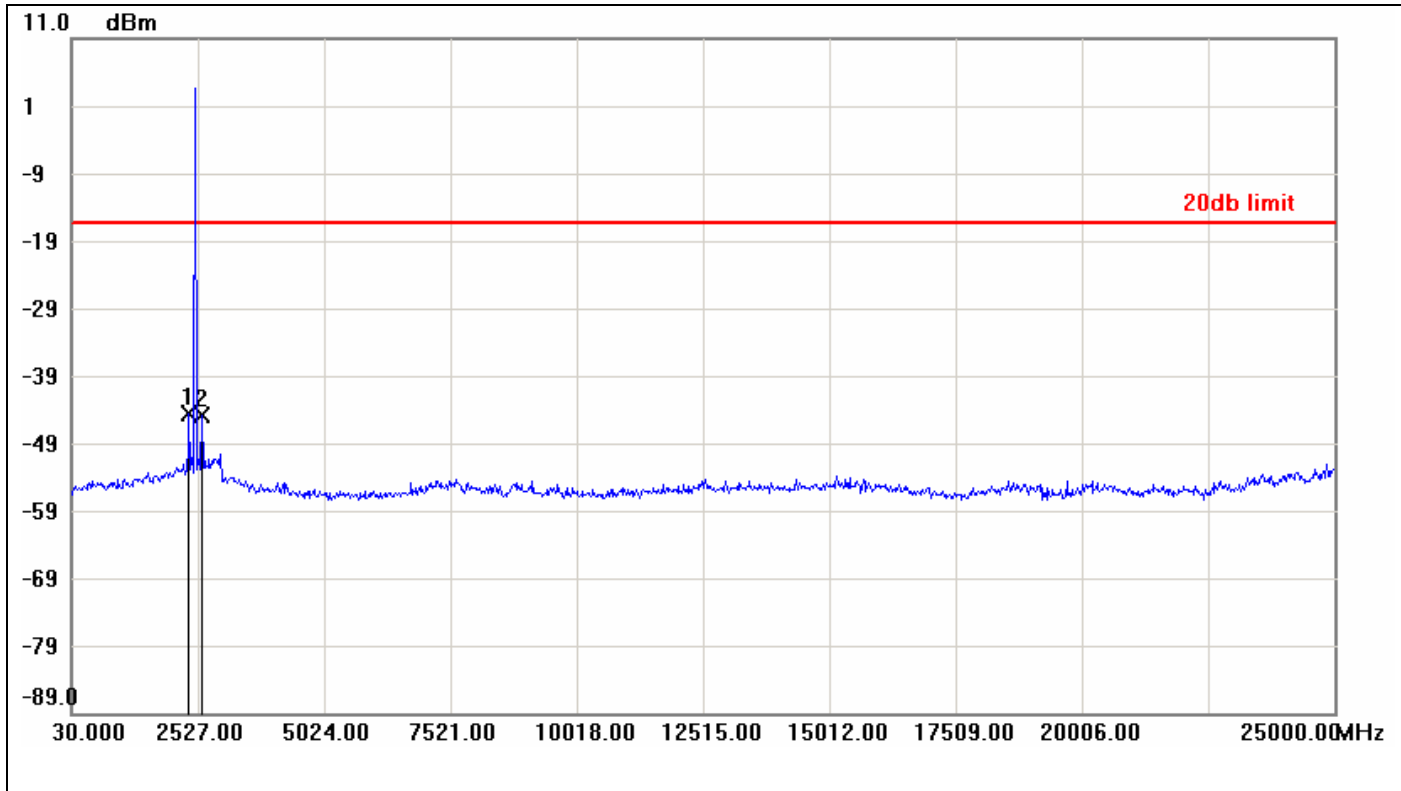

No.	Frequency(MHz)	Result(dBm)	Limit(dBm)	Margin(dBm)
1	2352.2100	-44.74	-16.39	-28.35
2	2601.9100	-44.80	-16.39	-28.41





### 7.7.2 Radiated Emissions

#### LIMIT

1. According to §15.209(a), except as provided elsewhere in this Subpart, the emissions from an intentional radiator shall not exceed the field strength levels specified in the following table:

Frequency (MHz)	Field Strength ( $\mu\text{V/m}$ )	Measurement Distance (m)
30-88	100*	3
88-216	150*	3
216-960	200*	3
Above 960	500	3

**Remark:** Except as provided in paragraph (g), fundamental emissions from intentional radiators operating under this Section shall not be located in the frequency bands 54-72 MHz, 76-88 MHz, 174-216 MHz or 470-806 MHz. However, operation within these frequency bands is permitted under other sections of this Part, e.g., Sections 15.231 and 15.241.

2. In the emission table above, the tighter limit applies at the band edges.

Frequency (MHz)	Field Strength ( $\mu\text{V/m}$ at 3-meter)	Field Strength (dB $\mu\text{V/m}$ at 3-meter)
30-88	100	40
88-216	150	43.5
216-960	200	46
Above 960	500	54



### Test Configuration

#### 9kHz ~ 30MHz

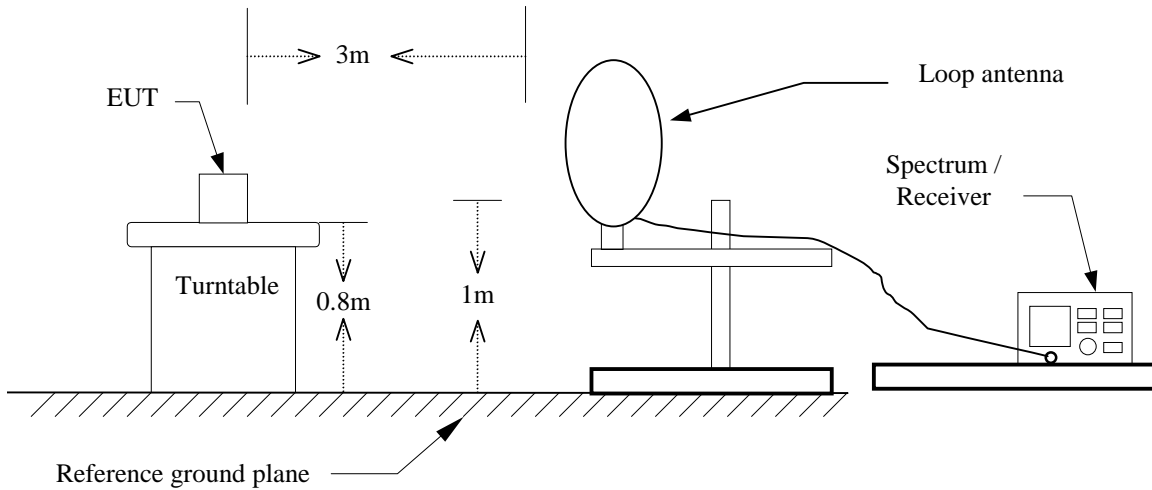

#### 30MHz ~ 1GHz

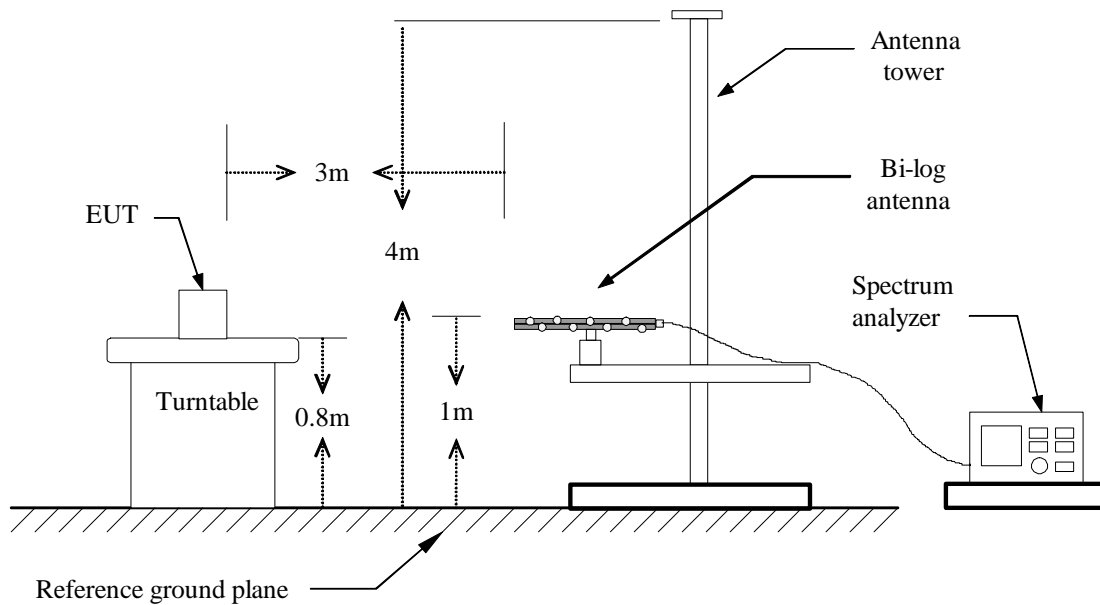



Above 1 GHz

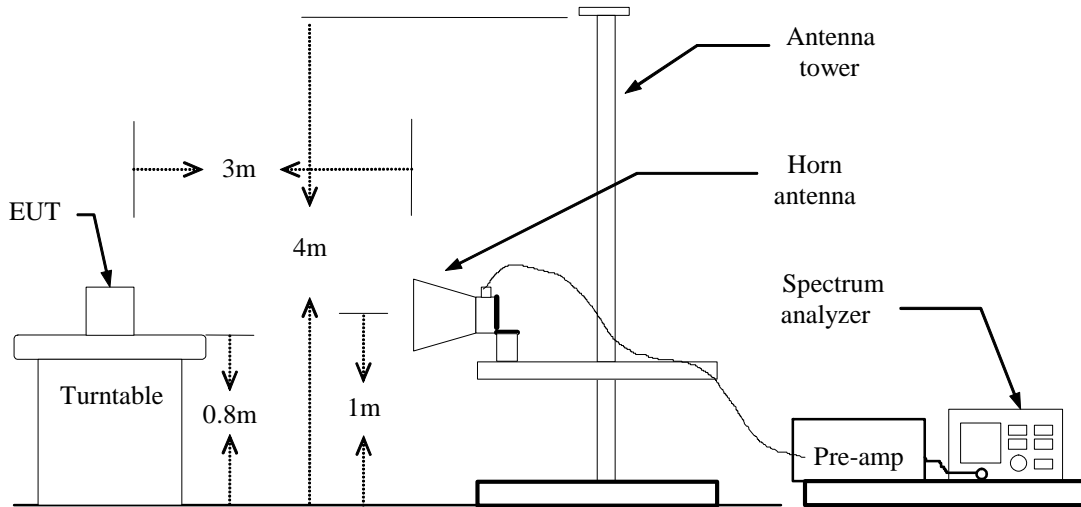



## **TEST PROCEDURE**

1. The EUT is placed on a turntable, which is 0.8m above ground plane.
2. The turntable shall be rotated for 360 degrees to determine the position of maximum emission level.
3. EUT is set 3m away from the receiving antenna, which is varied from 1m to 4m to find out the highest emissions.
4. Maximum procedure was performed on the six highest emissions to ensure EUT compliance.
5. And also, each emission was to be maximized by changing the polarization of receiving antenna both horizontal and vertical.
6. Set the spectrum analyzer in the following setting as:  
Below 1GHz:  
RBW=100kHz / VBW=300kHz / Sweep=AUTO  
Above 1GHz:  
(a) PEAK: RBW=VBW=1MHz / Sweep=AUTO  
(b) AVERAGE: RBW=1MHz / VBW=10Hz / Sweep=AUTO
7. Repeat above procedures until the measurements for all frequencies are complete.

**Below 1 GHz**

**Operation Mode:** Normal Link      **Test Date:** August 1, 2012  
**Temperature:** 28°C      **Tested by:** Waternil Guan  
**Humidity:** 62 % RH      **Polarity:** Ver. / Hor.

Frequency (MHz)	Reading (dBuV)	Correction Factor (dB/m)	Result (dBuV/m)	Limit (dBuV/m)	Margin (dB)	Remark	Ant. Pol. (H/V)
36.79	48.50	-10.64	37.86	40.00	-2.14	QP	V
150.28	52.60	-13.73	38.87	43.50	-4.63	Peak	V
348.16	54.52	-10.49	44.03	46.00	-1.97	Peak	V
474.26	50.12	-8.22	41.90	46.00	-4.10	QP	V
497.54	50.12	-7.74	42.38	46.00	-3.62	QP	V
928.22	40.84	-1.20	39.65	46.00	-6.35	Peak	V
125.06	47.91	-13.27	34.64	43.50	-8.86	Peak	H
350.10	54.26	-10.46	42.80	46.00	-2.20	QP	H
450.01	48.06	-8.72	39.34	46.00	-6.66	Peak	H
494.63	48.19	-7.80	40.39	46.00	-5.61	Peak	H
666.32	46.45	-5.26	41.18	46.00	-4.82	Peak	H
928.22	42.29	-1.20	41.10	46.00	-4.90	Peak	H

**Remark:**

1. No emission found between lowest internal used/generated frequency to 30MHz (9kHz~30MHz)
2. Radiated emissions measured in frequency range from 30 MHz to 1000MHz were made with an instrument using peak/quasi-peak detector mode.
3. Quasi-peak test would be performed if the peak result were greater than the quasi-peak limit or as required by the applicant.
4. Measurements above show only up to 6 maximum emissions noted, or would be lesser; with " N/A " remark, if no specific emissions from the EUT are recorded (ie: margin>20dB from the applicable limit) and considered that's already beyond the background noise floor.
5. Margin (dB) = Remark result (dBuV/m) – Quasi-peak limit (dBuV/m).

**Above 1 GHz****Operation Mode:** TX / GFSK / DH5 / CH Low**Test Date:** August 24, 2012**Temperature:** 30°C**Tested by:** Alan Wu**Humidity:** 45 % RH**Polarity:** Ver. / Hor.

Frequency (MHz)	Reading (Peak) (dBuV)	Reading (Average) (dBuV)	Correction Factor (dB/m)	Result (Peak) (dBuV/m)	Result (Average) (dBuV/m)	Limit (Peak) (dBuV/m)	Limit (Average) (dBuV/m)	Margin (dB)	Remark	Ant.Pol. (H/V)
1094.00	50.46	---	-3.67	46.79	---	74.00	54.00	-7.21	Peak	V
1332.00	54.33	---	-2.84	51.50	---	74.00	54.00	-2.50	Peak	V
1780.00	50.28	---	0.27	50.55	---	74.00	54.00	-3.45	Peak	V
3352.50	41.18	---	5.72	46.90	---	74.00	54.00	-7.10	Peak	V
4972.50	39.41	---	9.62	49.03	---	74.00	54.00	-4.97	Peak	V
6360.00	37.23	---	12.32	49.56	---	74.00	54.00	-4.44	Peak	V
1330.00	52.45	---	-2.85	49.61	---	74.00	54.00	-4.39	Peak	H
1684.00	50.06	---	-0.59	49.46	---	74.00	54.00	-4.54	Peak	H
2282.00	55.44	48.48	3.21	58.65	51.69	74.00	54.00	-2.31	AVG	H
2522.00	56.11	49.52	4.00	60.11	53.52	74.00	54.00	-0.48	AVG	H
4807.50	39.42	---	9.18	48.60	---	74.00	54.00	-5.40	Peak	H
6472.50	37.33	---	12.55	49.89	---	74.00	54.00	-4.11	Peak	H

**Remark:**

1. Measuring frequencies from 1 GHz to the 10th harmonic of highest fundamental frequency.
2. Radiated emissions measured in frequency above 1000MHz were made with an instrument using peak/average detector mode.
3. Average test would be performed if the peak result were greater than the average limit .
4. Data of measurement within this frequency range shown " --- " in the table above means the reading of emissions are attenuated more than 20dB below the permissible limits or the field strength is too small to be measured.
5. Measurements above show only up to 6 maximum emissions noted, or would be lesser, with " N/A " remark, if no specific emissions from the EUT are recorded (ie: margin>20dB from the applicable limit) and considered that's already beyond the background noise floor.
6. Margin (dB) = Remark result (dBuV/m) – Average limit (dBuV/m).

**Operation Mode:** TX / GFSK / DH5 / CH Mid**Test Date:** August 24, 2012**Temperature:** 30°C**Tested by:** Alan Wu**Humidity:** 45 % RH**Polarity:** Ver. / Hor.

Frequency (MHz)	Reading (Peak) (dBuV)	Reading (Average) (dBuV)	Correction Factor (dB/m)	Result (Peak) (dBuV/m)	Result (Average) (dBuV/m)	Limit (Peak) (dBuV/m)	Limit (Average) (dBuV/m)	Margin (dB)	Remark	Ant.Pol. (H/V)
1328.00	54.08	---	-2.85	51.23	---	74.00	54.00	-2.77	Peak	V
1662.00	50.78	---	-0.79	49.98	---	74.00	54.00	-4.02	Peak	V
2320.00	55.32	48.26	3.34	58.66	51.60	74.00	54.00	-2.40	AVG	V
2560.00	54.70	46.27	4.08	58.78	50.35	74.00	54.00	-3.65	AVG	V
4890.00	39.24	---	9.40	48.64	---	74.00	54.00	-5.36	Peak	V
6645.00	38.36	---	12.76	51.11	---	74.00	54.00	-2.89	Peak	V
1214.00	50.79	---	-3.25	47.54	---	74.00	54.00	-6.46	Peak	H
1788.00	49.97	---	0.34	50.31	---	74.00	54.00	-3.69	Peak	H
2320.00	51.91	48.36	3.34	55.25	51.70	74.00	54.00	-2.30	AVG	H
2562.00	55.29	48.76	4.08	59.37	52.84	74.00	54.00	-1.16	AVG	H
4860.00	39.56	---	9.32	48.88	---	74.00	54.00	-5.12	Peak	H
6540.00	37.82	---	12.65	50.47	---	74.00	54.00	-3.53	Peak	H

**Remark:**

1. Measuring frequencies from 1 GHz to the 10th harmonic of highest fundamental frequency.
2. Radiated emissions measured in frequency above 1000MHz were made with an instrument using peak/average detector mode.
3. Average test would be performed if the peak result were greater than the average limit.
4. Data of measurement within this frequency range shown " --- " in the table above means the reading of emissions are attenuated more than 20dB below the permissible limits or the field strength is too small to be measured.
5. Measurements above show only up to 6 maximum emissions noted, or would be lesser, with " N/A " remark, if no specific emissions from the EUT are recorded (ie: margin>20dB from the applicable limit) and considered that's already beyond the background noise floor.
6. Margin (dB) = Remark result (dBuV/m) – Average limit (dBuV/m).

**Operation Mode:** TX / GFSK / DH5 / CH High**Test Date:** August 24, 2012**Temperature:** 30°C**Tested by:** Alan Wu**Humidity:** 45 % RH**Polarity:** Ver. / Hor.

Frequency (MHz)	Reading (Peak) (dBuV)	Reading (Average) (dBuV)	Correction Factor (dB/m)	Result (Peak) (dBuV/m)	Result (Average) (dBuV/m)	Limit (Peak) (dBuV/m)	Limit (Average) (dBuV/m)	Margin (dB)	Remark	Ant.Pol. (H/V)
1130.00	49.52	---	-3.55	45.98	---	74.00	54.00	-8.02	Peak	V
1850.00	50.79	---	0.90	51.69	---	74.00	54.00	-2.31	Peak	V
2360.00	55.61	49.16	3.47	59.08	52.63	74.00	54.00	-1.37	AVG	V
3720.00	40.64	---	6.53	47.17	---	74.00	54.00	-6.83	Peak	V
5055.00	39.50	---	9.76	49.26	---	74.00	54.00	-4.74	Peak	V
6705.00	38.21	---	12.82	51.03	---	74.00	54.00	-2.97	Peak	V
1130.00	51.27	---	-3.55	47.73	---	74.00	54.00	-6.27	Peak	H
1366.00	51.39	---	-2.72	48.67	---	74.00	54.00	-5.33	Peak	H
1856.00	50.53	---	0.95	51.48	---	74.00	54.00	-2.52	Peak	H
2360.00	56.36	50.20	3.47	59.83	53.67	74.00	54.00	-0.33	AVG	H
4875.00	39.33	---	9.36	48.69	---	74.00	54.00	-5.31	Peak	H
6675.00	38.93	---	12.79	51.72	---	74.00	54.00	-2.28	Peak	H

**Remark:**

1. Measuring frequencies from 1 GHz to the 10th harmonic of highest fundamental frequency.
2. Radiated emissions measured in frequency above 1000MHz were made with an instrument using peak/average detector mode.
3. Average test would be performed if the peak result were greater than the average limit.
4. Data of measurement within this frequency range shown " --- " in the table above means the reading of emissions are attenuated more than 20dB below the permissible limits or the field strength is too small to be measured.
5. Measurements above show only up to 6 maximum emissions noted, or would be lesser, with " N/A " remark, if no specific emissions from the EUT are recorded (ie: margin > 20dB from the applicable limit) and considered that's already beyond the background noise floor.
6. Margin (dB) = Remark result (dBuV/m) – Average limit (dBuV/m).



**Operation Mode:** TX / 8DPSK / DH5 / CH Low**Test Date:** August 24, 2012**Temperature:** 30°C**Tested by:** Alan Wu**Humidity:** 45 % RH**Polarity:** Ver. / Hor.

Frequency (MHz)	Reading (Peak) (dBuV)	Reading (Average) (dBuV)	Correction Factor (dB/m)	Result (Peak) (dBuV/m)	Result (Average) (dBuV/m)	Limit (Peak) (dBuV/m)	Limit (Average) (dBuV/m)	Margin (dB)	Remark	Ant.Pol. (H/V)
1044.00	50.99	---	-3.85	47.15	---	74.00	54.00	-6.85	Peak	V
1332.00	59.33	43.89	-2.84	56.49	41.05	74.00	54.00	-12.95	AVG	V
1896.00	50.54	---	1.31	51.86	---	74.00	54.00	-2.14	Peak	V
3270.00	41.31	---	5.55	46.86	---	74.00	54.00	-7.14	Peak	V
4995.00	39.21	---	9.68	48.89	---	74.00	54.00	-5.11	Peak	V
6705.00	38.31	---	12.82	51.13	---	74.00	54.00	-2.87	Peak	V
1092.00	51.30	---	-3.68	47.62	---	74.00	54.00	-6.38	Peak	H
1770.00	49.89	---	0.18	50.07	---	74.00	54.00	-3.93	Peak	H
2522.00	54.67	45.82	4.00	58.67	49.82	74.00	54.00	-4.18	AVG	H
3345.00	40.89	---	5.70	46.59	---	74.00	54.00	-7.41	Peak	H
4995.00	38.51	---	9.68	48.18	---	74.00	54.00	-5.82	Peak	H
6735.00	37.06	---	12.85	49.91	---	74.00	54.00	-4.09	Peak	H

**Remark:**

1. Measuring frequencies from 1 GHz to the 10th harmonic of highest fundamental frequency.
2. Radiated emissions measured in frequency above 1000MHz were made with an instrument using peak/average detector mode.
3. Average test would be performed if the peak result were greater than the average limit.
4. Data of measurement within this frequency range shown " --- " in the table above means the reading of emissions are attenuated more than 20dB below the permissible limits or the field strength is too small to be measured.
5. Measurements above show only up to 6 maximum emissions noted, or would be lesser, with " N/A " remark, if no specific emissions from the EUT are recorded (ie: margin > 20dB from the applicable limit) and considered that's already beyond the background noise floor.
6. Margin (dB) = Remark result (dBuV/m) – Average limit (dBuV/m).

**Operation Mode:** TX / 8DPSK / DH5 / CH Mid**Test Date:** August 24, 2012**Temperature:** 30°C**Tested by:** Alan Wu**Humidity:** 45 % RH**Polarity:** Ver. / Hor.

Frequency (MHz)	Reading (Peak) (dBuV)	Reading (Average) (dBuV)	Correction Factor (dB/m)	Result (Peak) (dBuV/m)	Result (Average) (dBuV/m)	Limit (Peak) (dBuV/m)	Limit (Average) (dBuV/m)	Margin (dB)	Remark	Ant.Pol. (H/V)
1112.00	51.13	---	-3.61	47.52	---	74.00	54.00	-6.48	Peak	V
1330.00	53.55	---	-2.85	50.71	---	74.00	54.00	-3.29	Peak	V
1816.00	50.79	---	0.59	51.38	---	74.00	54.00	-2.62	Peak	V
3495.00	40.77	---	6.01	46.78	---	74.00	54.00	-7.22	Peak	V
4995.00	39.42	---	9.68	49.09	---	74.00	54.00	-4.91	Peak	V
6630.00	38.16	---	12.74	50.90	---	74.00	54.00	-3.10	Peak	V
1062.00	51.26	---	-3.78	47.48	---	74.00	54.00	-6.52	Peak	H
1488.00	51.05	---	-2.29	48.75	---	74.00	54.00	-5.25	Peak	H
1902.00	50.08	---	1.37	51.45	---	74.00	54.00	-2.55	Peak	H
3375.00	40.96	---	5.76	46.73	---	74.00	54.00	-7.27	Peak	H
4860.00	38.76	---	9.32	48.08	---	74.00	54.00	-5.92	Peak	H
6555.00	37.99	---	12.67	50.65	---	74.00	54.00	-3.35	Peak	H

**Remark:**

1. Measuring frequencies from 1 GHz to the 10th harmonic of highest fundamental frequency.
2. Radiated emissions measured in frequency above 1000MHz were made with an instrument using peak/average detector mode.
3. Average test would be performed if the peak result were greater than the average limit.
4. Data of measurement within this frequency range shown " --- " in the table above means the reading of emissions are attenuated more than 20dB below the permissible limits or the field strength is too small to be measured.
5. Measurements above show only up to 6 maximum emissions noted, or would be lesser, with " N/A " remark, if no specific emissions from the EUT are recorded (ie: margin>20dB from the applicable limit) and considered that's already beyond the background noise floor.
6. Margin (dB) = Remark result (dBuV/m) – Average limit (dBuV/m).

**Operation Mode:** TX / 8DPSK / DH5 / CH High**Test Date:** August 24, 2012**Temperature:** 30°C**Tested by:** Alan Wu**Humidity:** 45 % RH**Polarity:** Ver. / Hor.

Frequency (MHz)	Reading (Peak) (dBuV)	Reading (Average) (dBuV)	Correction Factor (dB/m)	Result (Peak) (dBuV/m)	Result (Average) (dBuV/m)	Limit (Peak) (dBuV/m)	Limit (Average) (dBuV/m)	Margin (dB)	Remark	Ant.Pol. (H/V)
1078.00	50.85	---	-3.73	47.13	---	74.00	54.00	-6.87	Peak	V
1332.00	54.64	---	-2.84	51.80	---	74.00	54.00	-2.20	Peak	V
1866.00	49.67	---	1.04	50.72	---	74.00	54.00	-3.28	Peak	V
3405.00	40.72	---	5.83	46.54	---	74.00	54.00	-7.46	Peak	V
5055.00	40.05	---	9.76	49.81	---	74.00	54.00	-4.19	Peak	V
6180.00	38.30	---	11.95	50.25	---	74.00	54.00	-3.75	Peak	V
1108.00	51.20	---	-3.62	47.58	---	74.00	54.00	-6.42	Peak	H
1474.00	50.67	---	-2.34	48.33	---	74.00	54.00	-5.67	Peak	H
1744.00	51.01	---	-0.05	50.96	---	74.00	54.00	-3.04	Peak	H
3105.00	41.41	---	5.21	46.62	---	74.00	54.00	-7.38	Peak	H
5040.00	39.17	---	9.74	48.91	---	74.00	54.00	-5.09	Peak	H
6030.00	39.02	---	11.64	50.66	---	74.00	54.00	-3.34	Peak	H

**Remark:**

1. Measuring frequencies from 1 GHz to the 10th harmonic of highest fundamental frequency.
2. Radiated emissions measured in frequency above 1000MHz were made with an instrument using peak/average detector mode.
3. Average test would be performed if the peak result were greater than the average limit.
4. Data of measurement within this frequency range shown " --- " in the table above means the reading of emissions are attenuated more than 20dB below the permissible limits or the field strength is too small to be measured.
5. Measurements above show only up to 6 maximum emissions noted, or would be lesser, with " N/A " remark, if no specific emissions from the EUT are recorded (ie: margin>20dB from the applicable limit) and considered that's already beyond the background noise floor.
6. Margin (dB) = Remark result (dBuV/m) – Average limit (dBuV/m).



## 7.8 POWERLINE CONDUCTED EMISSIONS

### LIMIT

According to §15.207(a), except as shown in paragraphs (b) and (c) of this section, for an intentional radiator that is designed to be connected to the public utility (AC) power line, the radio frequency voltage that is conducted back onto the AC power line on any frequency or frequencies within the band 150 kHz to 30 MHz shall not exceed the limits in the following table, as measured using a 50  $\mu$ H/50 ohms line impedance stabilization network (LISN). Compliance with the provisions of this paragraph shall be based on the measurement of the radio frequency voltage between each power line and ground at the power terminal. The lower limit applies at the boundary between the frequency ranges.

Frequency Range (MHz)	Limits (dB $\mu$ V)	
	Quasi-peak	Average
0.15 to 0.50	66 to 56*	56 to 46*
0.50 to 5	56	46
5 to 30	60	50

\* Decreases with the logarithm of the frequency.

### Test Configuration

See test photographs attached in Appendix II for the actual connections between EUT and support equipment.

### TEST PROCEDURE

1. The EUT was placed on a table, which is 0.8m above ground plane.
2. Maximum procedure was performed on the six highest emissions to ensure EUT compliance.
3. Repeat above procedures until all frequency measured were complete.

### TEST RESULTS

The initial step in collecting conducted data is a spectrum analyzer peak scan of the measurement range. Significant peaks are then marked as shown on the following data page, and these signals are then quasi-peaked.



**Test Data**

**Operation Mode:** Normal Link                      **Test Date:** August 20, 2012  
**Temperature:** 22°C                                      **Tested by:** Alan Wu  
**Humidity:** 58% RH

**Conducted emissions (Line 1)**

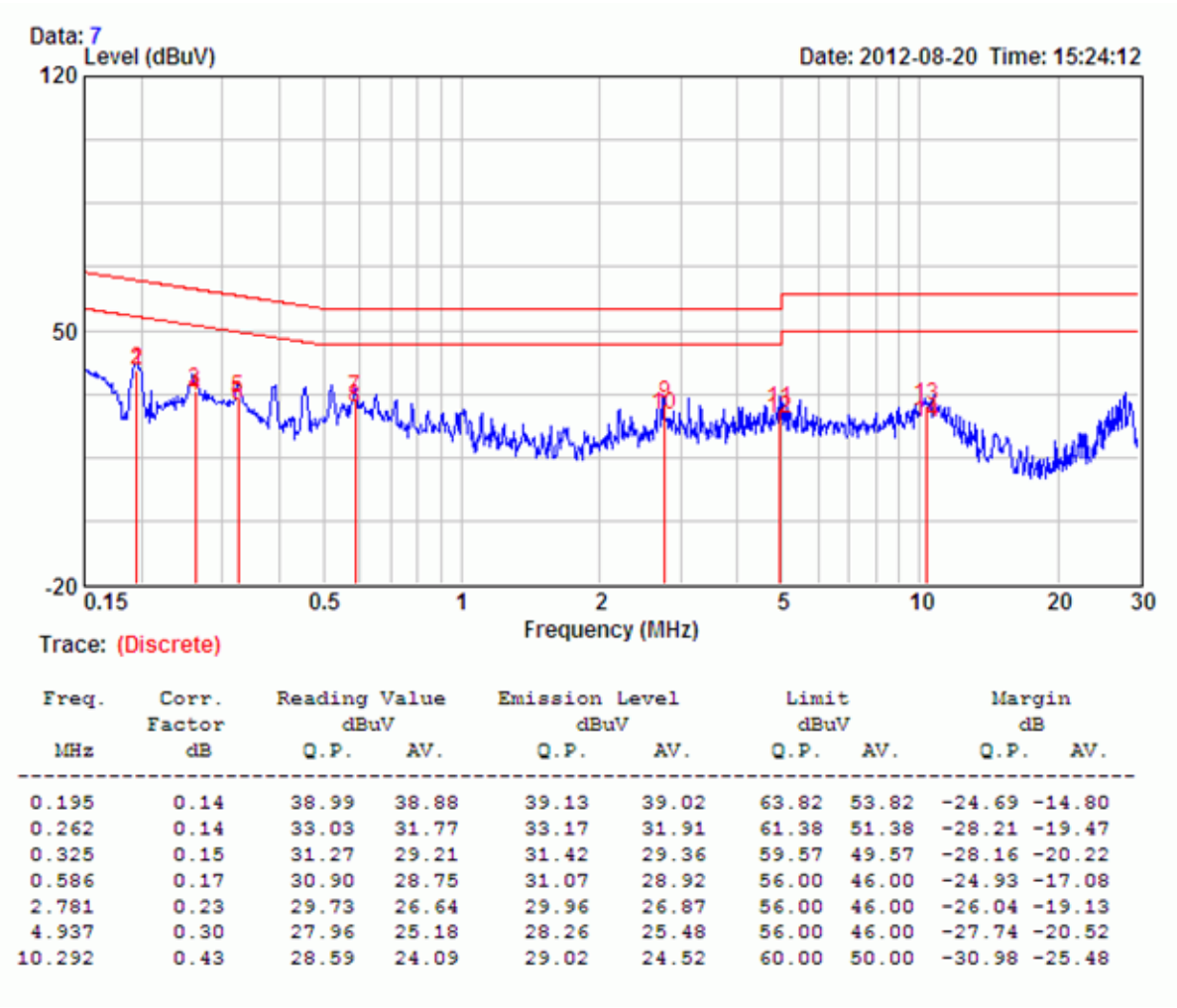

Remarks: 1. The emission levels of other frequencies were very low against the limits .  
2. Correction Factor = Insertion loss + Cable loss  
3. Margin value = Emission level - Limit value



Conducted emissions (Line 2)

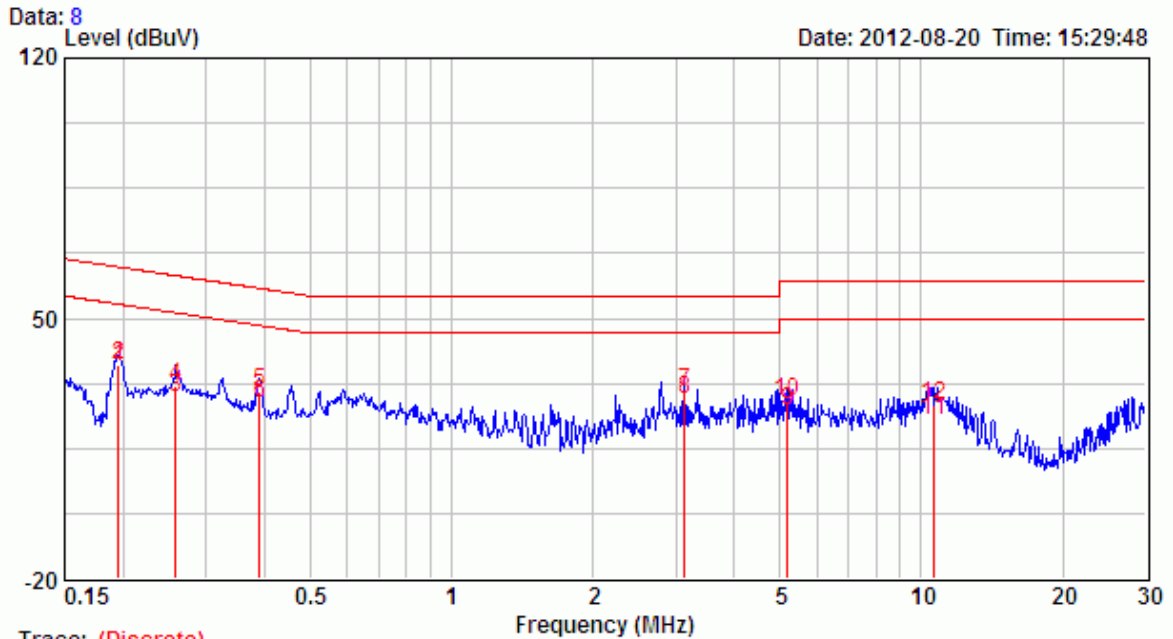

Freq. MHz	Corr. Factor dB	Reading Value dBuV		Emission Level dBuV		Limit dBuV		Margin dB	
		Q.P.	AV.	Q.P.	AV.	Q.P.	AV.	Q.P.	AV.
0.195	0.11	37.33	36.84	37.44	36.95	63.80	53.80	-26.36	-16.85
0.259	0.12	31.81	28.75	31.93	28.87	61.47	51.47	-29.54	-22.60
0.389	0.13	30.21	27.17	30.34	27.30	58.08	48.08	-27.74	-20.78
3.130	0.22	30.13	28.04	30.35	28.26	56.00	46.00	-25.65	-17.74
5.180	0.27	27.32	25.01	27.59	25.28	60.00	50.00	-32.41	-24.72
10.602	0.38	26.26	22.12	26.64	22.50	60.00	50.00	-33.36	-27.50

Remarks: 1. The emission levels of other frequencies were very low against the limits .  
 2. Correction Factor = Insertion loss + Cable loss  
 3. Margin value = Emission level - Limit value