

*Getac*

V200

USER'S MANUAL

**Rugged Mobile Computing Solutions**

Aug. 2012

## **TRADEMARKS**

The Bluetooth® word mark and logos are owned by the Bluetooth SIG, Inc. All brand and product names are trademarks or registered trademarks of their respective companies.

## **NOTE**

The information in this manual is subject to change without notice. Most screens and operating instructions in this manual are based on Windows 7. If you're using a different version of Windows, the screens and related operations

may not be the same.

For the latest version of the manual, please visit the Getac website at [www.getac.com](http://www.getac.com).



ENERGY STAR<sup>®</sup> is a government program that offers businesses and consumers energy-efficient solutions, making it easy to save money while protecting the environment for future generations.

Please reference ENERGY STAR<sup>®</sup> related information from [www.energystar.gov](http://www.energystar.gov).

As an ENERGY STAR<sup>®</sup> Partner, Getac Technology Corporation has determined that this product meets the ENERGY STAR<sup>®</sup> guidelines for energy efficiency.

An ENERGY STAR<sup>®</sup> qualified computer uses 70 % less electricity than computers without enabled power management features.

## **Earning the ENERGY STAR<sup>®</sup>**

- When every home office is powered by equipment that has earned the ENERGY STAR<sup>®</sup>, the change will keep over 289 billion pounds of greenhouse gases out of the air.
- If left inactive, ENERGY STAR<sup>®</sup> qualified computers enter a low-power mode and may use 15 watts or less. New chip technologies make power management features more reliable, dependable, and user-friendly than even just a few years ago.
- Spending a large portion of time in low-power mode not only saves energy, but helps equipment run cooler and last longer.

- Businesses that use ENERGY STAR® enabled office equipment may realize additional savings on air conditioning and maintenance.
- Over its lifetime, ENERGY STAR® qualified equipment in a single home office (e.g., computer, monitor, printer, and fax) can save enough electricity to light an entire home for more than 4 years.
- Power management (“sleep settings”) on computers and monitors can result in much savings annually.

## **Remember, saving energy prevents pollution**

Because most computer equipment is left on 24 hours a day, power management features are important for saving energy and are an easy way to reduce air pollution. By using less energy, these products help lower consumers’ utility bills, and prevent greenhouse gas emissions.



---

LEARN MORE AT  
[energystar.gov](http://energystar.gov)

# Table of Contents

<b>Chapter 1 Getting Started .....</b>	<b>1-1</b>
Getting the Computer Running.....	1-2
Unpacking.....	1-2
Connecting to AC Power .....	1-3
Opening and Closing the Cover .....	1-4
Operating in Tablet Mode .....	1-5
Turning On and Off the Computer .....	1-7
Taking a Look at the Computer .....	1-8
Front Components .....	1-8
Rear Components.....	1-10
Right-Side Components .....	1-11
Left-Side Components .....	1-12
Top-open Components .....	1-13
Bottom Components .....	1-15
Using the Accessories .....	1-17
Using the Tether .....	1-17
Attaching the Handgrip Strap.....	1-18
Attaching the Shoulder Strap .....	1-18
<b>Chapter 2 Operating Your Computer .....</b>	<b>2-1</b>
Using the Internal Keyboard.....	2-2
Typewriter Keys .....	2-2
Cursor-Control Keys .....	2-2

Numeric Keypad .....	2-3
Function Keys .....	2-4
Fn Key.....	2-4
Hot Keys .....	2-4
Using the Touchpad.....	2-7
Configuring the Touchpad.....	2-9
Navigating on the Screen.....	2-10
Using the Touchscreen.....	2-10
Using Multi-touch Gestures .....	2-11
Using the Dual Mode Display (Optional) .....	2-13
Using Landscape or Portrait View.....	2-15
Using the Input Panel .....	2-17
Using the Network Features.....	2-18
Using the Modem .....	2-18
Using the LAN.....	2-19
Using the Wireless LAN.....	2-19
Using the Bluetooth Feature .....	2-21
Turning Off/On the Bluetooth Radio .....	2-21
Connecting to another Bluetooth Device .....	2-21
Using the WWAN Feature (Optional) .....	2-23
Installing a SIM Card .....	2-23
Turning Off/On the WWAN Radio.....	2-24
Connecting to WWAN Network.....	2-25
Using the Fingerprint Scanner (Optional).....	2-27

## **Chapter 3 Managing Power..... 3-1**

AC Adapter.....	3-2
Battery Pack.....	3-3
Charging the Battery Pack .....	3-3
Initializing the Battery Pack .....	3-4

Checking the Battery Level .....	3-4
Replacing the Battery Pack .....	3-5
Battery Low Signals and Actions .....	3-6
Power Management .....	3-8
Hibernation .....	3-9
Power-Saving Tips .....	3-10

## **Chapter 4 Expanding Your Computer ..... 4-1**

Connecting an External Monitor .....	4-2
Connecting a Serial Device .....	4-3
Connecting a USB Device .....	4-4
Connecting an IEEE 1394 Device .....	4-5
Connecting Audio Devices .....	4-6
Using ExpressCards .....	4-7
Using PC Cards .....	4-9
Using Smart Cards (Optional) .....	4-11
Using Storage Cards .....	4-12
System Memory Upgrade .....	4-13

## **Chapter 5 Using BIOS Setup and System Recovery..... 5-1**

BIOS Setup .....	5-2
When and How to Use .....	5-2
Information Menu .....	5-3
Main Menu .....	5-4
Advanced Menu .....	5-5
Security Menu .....	5-12
Boot Menu .....	5-14
Exit Menu .....	5-15
System Recovery .....	5-17

## **Chapter 6 Using Getac Software ..... 6-1**

Using the OSD Control Panel .....	6-2
Quick Button Setup .....	6-6
Using Button Manager .....	6-8
Using G-Manager .....	6-10
Starting G-Manager .....	6-10
System Tab .....	6-11
Battery Tab .....	6-12
ECO Tab .....	6-14
Light Sensor Tab .....	6-16
Ignition Tab .....	6-18
Monitoring Tab .....	6-19
GPS Status Tab .....	6-20
Using Getac Camera .....	6-22
Taking Pictures .....	6-24
Shooting Videos .....	6-26
Using View Mode .....	6-27
Camera Settings .....	6-31

## **Chapter 7 Caring for the Computer ..... 7-1**

Protecting the Computer .....	7-2
Using an Anti-Virus Strategy .....	7-2
Using Action Center (for Windows 7) .....	7-2
Using the Cable Lock .....	7-3
Taking Care of the Computer .....	7-4
Location Guidelines .....	7-4
General Guidelines .....	7-5
Cleaning Guidelines .....	7-5
Battery Pack Guidelines .....	7-6
Touchscreen Guidelines .....	7-7



When Traveling .....7-9

**Chapter 8 ..... Troubleshooting  
8-1**

Preliminary Checklist.....8-2  
Solving Common Problems .....8-3  
    Battery Problems.....8-3  
    Bluetooth Problems .....8-3  
    Display Problems .....8-4  
    Hardware Device Problems.....8-5  
    Hard Disk Drive Problems .....8-5  
    Keyboard, Mouse, and Touchpad Problems .....8-6  
    LAN Problems .....8-6  
    Modem Problems .....8-7  
    Power Management Problems .....8-7  
    Software Problems.....8-8  
    Sound Problems .....8-8  
    Startup Problems.....8-9  
    WLAN Problems .....8-9  
    Other Problems .....8-11  
Resetting the Computer..... 8-12

**Appendix A Specifications ..... A-1**

**Appendix B Regulatory Information..... B-1**

On the Use of the System ..... B-2  
    Class B Regulations ..... B-2  
    UL1604 Installation Instructions..... B-3  
    Safety Notices ..... B-4  
On the Use of the RF Device ..... B-7  
    USA and Canada Safety Requirements and Notices ..... B-7  
    European Union CE Marking and Compliance Notices..... B-10



# Chapter 1

# Getting Started

Congratulations on purchasing this rugged computer.

This chapter first tells you step by step how to get the computer up and running. Then, you will find a section briefly introducing the external components of the computer.

# Getting the Computer Running

This section guides you through the procedures for getting the computer ready for operation.

## Unpacking

After unpacking the shipping carton, you should find these standard items:

- Notebook computer
- Accessories:
  - AC adapter
  - AC power cord
  - Shoulder strap
  - Handgrip strap
  - Stylus and tether
  - Digitizer pen (option)
  - Driver disc
  - Documents

Inspect all the items. If any item is damaged or missing, notify your dealer immediately.

Keep the shipping carton and packing materials in case you need to ship or store the computer in the future.

# Connecting to AC Power

The computer operates either on the external AC power or internal battery power. It is suggested that you use AC power when you start up the computer for the very first time.

**CAUTION:** Use only the AC adapter included with your computer. Using other AC adapters may damage the computer.

1. Plug the DC cord of the AC adapter to the power connector of the computer (❶).
2. Plug the female end of the AC power cord to the AC adapter and the male end to an electrical outlet (❷).

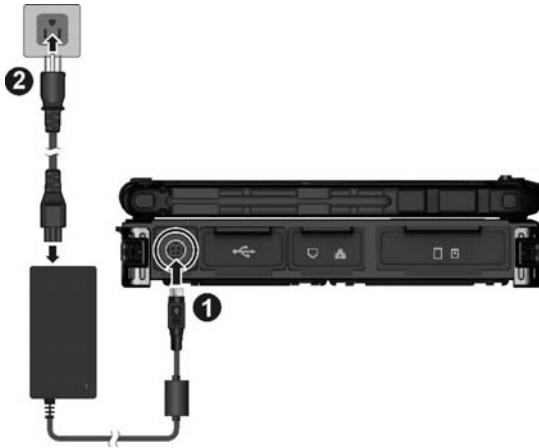

3. When the AC adapter is connected, power is being supplied from the electrical outlet to the AC adapter and onto your computer. Now, you are ready to turn on the computer.

## CAUTION:

- When you disconnect the AC adapter, disconnect from the electrical outlet first and then from the computer. A reverse procedure may damage the AC adapter or the computer.

- When unplugging the connector, always hold the plug head. Never pull on the cord.

**NOTE:** When the AC adapter is connected, it also charges the battery pack. For information on using battery power, see Chapter 3.

## Opening and Closing the Cover

To open the top cover:

1. Pull loose the cover latch (❶) and release the clamp (❷).
2. Lift up the cover (❸). You can tilt the cover forward or backward for optimal viewing clarity.



To close the top cover:

1. Close the display.

2. Lift the cover latch and engage the clamp on the display. Then, push in the cover latch to click it into place.

## Operating in Tablet Mode

In addition to being used as a regular notebook computer (Laptop mode), your computer can also be operated in Tablet mode. In Tablet mode, you operate the computer with a stylus or digitizer pen, or a fingertip, instead of a keyboard or mouse.

1. Open the top cover so that it is almost perpendicular with the keyboard of the computer.
2. Turn the display counter-clockwise by  $165^{\circ}$ .



**CAUTION:** Do not rotate the display more than  $165^{\circ}$ , or attempt to rotate the display clockwise.

3. Close the computer with the display facing up.



4. Lift the cover latch and engage the clamp on the display. Then, push in the cover latch to click it into place.

In Tablet mode, the computer can be operated while holding it as shown. A handgrip strap is supplied to help you hold the computer. (See “Attaching the Handgrip Strap” in this chapter for installation instructions.)





# Turning On and Off the Computer

## Turning On

Press the power button (  ). Each time the computer is turned on, it performs a Power-On Self Test (POST), and the operating system such as Windows should start.



## Turning Off

When you finish a working session, you can stop the system by turning off the power or leaving it in Sleep or Hibernation mode:

To...	Do this...
Power off (Shutdown)	Use the Windows Start menu in the lower left and follow the shutdown procedure.
Sleep	Press the power button*. —or— Use the Windows Start menu to put the computer in Sleep mode.
Hibernate	Use the Windows Start menu to put the computer in Hibernation mode. (See “Hibernation” in Chapter 3 for more information.)

\* “Sleep” is the default setting of the power button. You may change what the power button does in Windows Control Panel.



# Taking a Look at the Computer



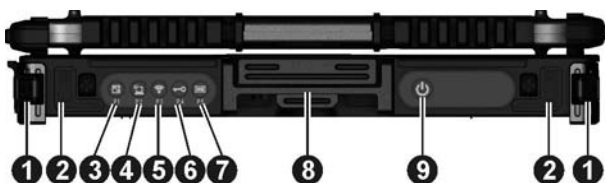

## NOTE:

- Depending on the model you purchased, the appearance of your computer may not be exactly the same as those shown in this manual.
- You need to open the protective covers to access the connectors. When not using a connector, make sure to close the cover completely for water- and dust-proof integrity. (Engage the locking mechanism if existing.)

## Front Components



Ref	Component	Description	See Also
❶	<b>Strap Holder</b>	Two buckles hold the shoulder strap.	P. 1-18
❷	<b>Stereo Speaker</b>	Sends out sound and voice from your computer.	
❸	<b>OSD Control Button</b> 	Opens or closes the OSD (On Screen Display) control panel.	P. 6-2
	<b>P1 Button</b>	Can be re-defined using the Button Manager utility.	P. 6-8
❹	<b>Sunlight-readable Button</b> 	Toggles the sunlight-readable mode on or off. In sunlight-readable mode, the display brightness is increased to the highest level.	

Ref	Component	Description	See Also
		<b>CAUTION:</b> To prevent burns to your fingers if using the computer (especially in Tablet Mode) with sunlight-readable mode turned on, do wear gloves when touching the top portion of the LCD display as it may be hot to the touch.	
	<b>P2 Button</b>	Can be re-defined using the Button Manager utility.	P. 6-8
<b>5</b>	<b>RF Button</b> 	Serves as the master on/off control of the RF radio.	
	<b>P3 Button</b>	Can be re-defined using the Button Manager utility.	P. 6-8
<b>6</b>	<b>Reset Button</b> 	Serves as the <b>Ctrl+Alt+Del</b> keyboard keys.	P. 8-12
	<b>P4 Button</b>	Can be re-defined using the Button Manager utility.	P. 6-8
<b>7</b>	<b>Software Keyboard Button</b> 	Opens or closes the software keyboard on your screen.	P. 2-17
	<b>P5 Button</b>	Can be re-defined using the Button Manager utility.	P. 6-8
<b>8</b>	<b>Top Cover Latch</b>	Locks the top cover.	P. 1-4
<b>9</b>	<b>Power Button</b> 	Turns the power on or off (Sleep mode by default).	P. 1-7

# Rear Components

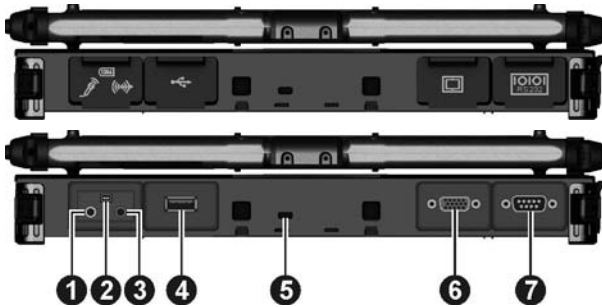

Ref	Component	Description	See Also
❶	<b>Audio Output Connector</b>	Connects a set of headphones, external speakers with amplifier, or an audio recording device.	P. 4-6
❷	<b>Mini IEEE 1394 Port</b>	Connects an IEEE 1394 device such as a scanner, printer, DVCAM, and VCR.	P. 4-5
❸	<b>Microphone Connector</b>	Connects an external microphone.	P. 4-6
❹	<b>USB 2.0 Port</b>	Connects a USB device, such as a flash disk, printer, digital camera, joystick, and more.	P. 4-4
❺	<b>Kensington Lock</b>	Locks the computer to a stationary object for security.	P. 7-3
❻	<b>VGA Connector</b>	Connects an external display monitor. (Depending on your model, this port could be a serial connector.)	P. 4-2
❼	<b>Serial Connector</b>	Connects a serial mouse or serial communication device.	P. 4-3

# Right-Side Components

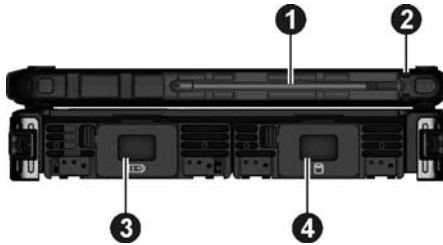

Ref	Component	Description	See Also
①	<b>Stylus</b>	Serves as the input device by tapping on the touchscreen to make selections and enter information. <b>NOTE:</b> Some models do not have the stylus slot on this side, so you can only use the slot on the left side for storing the stylus.	P. 2-10
②	<b>Tether Hole</b>	Stylus can be tethered to this hole. <b>NOTE:</b> Depending on your model, this is on both sides of the computer or on the left side only.	P. 1-17
③	<b>Battery Pack Compartment</b>	Inside is the battery pack that supplies power to your computer when external power is not connected.	P. 3-3
④	<b>Hard Disk Drive Compartment</b>	Inside is the hard disk drive.	

# Left-Side Components

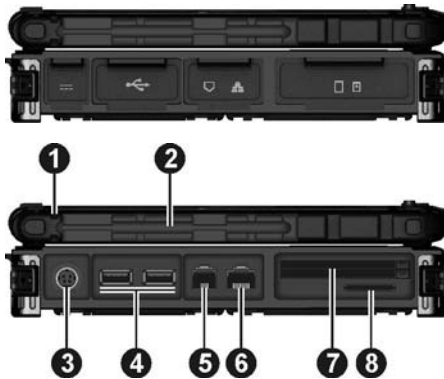



Ref	Component	Description	See Also
①	<b>Tether Hole</b>	Stylus can be tethered to this hole.	P. 1-17
②	<b>Stylus Slot</b>	Stylus can be stored in this slot.	
③	<b>Power Connector</b>	Connects the AC adapter.	P. 1-3
④	<b>USB 3.0 Port</b>	Connects a USB device, such as a flash disk, printer, digital camera, joystick, and more.	P. 4-4
⑤	<b>RJ-11 Connector</b>	Connects the telephone line.	P. 2-18
⑥	<b>RJ-45 Connector</b>	Connects the LAN cable.	P. 2-19
⑦	<b>ExpressCard Slot</b> (upper)	Accepts an ExpressCard for additional functions.	P. 4-7
	<b>PC Card Slot</b> (lower)	Accepts a PC card for additional functions.	P. 4-9
Depending on your model, the two slots could be a different combination (as below).			

	<b>Smart Card Reader</b> (upper)	Accepts a smart card for additional security feature.	P. 4-11
<b>Ref</b>	<b>Component</b>	<b>Description</b>	<b>See Also</b>
	<b>ExpressCard Slot</b> (lower)	Accepts an ExpressCard for additional functions.	P. 4-7
<b>8</b>	<b>SD Card Reader</b>	Accepts a SD/SDHC/SDXC card for removable storage media.	P. 4-12



## Top-open Components



Ref	Component	Description	See Also
<b>1</b>	<b>Camera Lens</b>	Allows you to use your computer's camera function. The lens supports 2 MP (mega pixel).	P. 6-22

Ref	Component	Description	See Also
		It can be rotated.	
②	<b>Touchscreen</b>	Displays and receives information for the computer.	P. 2-10
③	<b>Light Sensor</b>	Detects the surrounding lighting condition for automatic adjustment of the LCD brightness and optional keyboard backlight.	
④	<b>Fingerprint Scanner</b> ( optional )	Uses fingerprint verification to protect your computer against unauthorized access.	P. 2-27
⑤	<b>Keyboard</b>	Serves as the data input device.	P. 2-2
⑥	<b>Touchpad</b>	Serves as the pointing device.	P. 2-7
⑦	<b>Indicators</b>	Show the current status of the computer's devices.	
	 <b>Power</b>	Lights green when the computer is turned on.	P. 1-7
		Lights yellow when the computer is in Sleep mode.	
	 <b>Battery Charge</b>	Lights green when the battery is fully charged.	P. 3-3
		Lights yellow when the battery is being charged.	
		Blinks yellow when the battery's capacity is below 10%.	P. 3-6
		Blinks green and yellow by turns to indicate charging is suspended because the battery's temperature is either too high or too low.	
	 <b>Hard Disk Drive In-Use</b>	Lights green when the computer is accessing the hard disk drive.	



Ref	Component	Description	See Also
		Blinks red when the optional hard disk drive heater is on for low temperature operation.	P. 8-9
	 <b>RF</b>	Lights when the radio frequency is on.	
	 <b>Num Lock</b>	Lights when Num Lock is on.	P. 2-3
	 <b>Caps Lock</b>	Lights when Caps Lock is on.	P. 2-2

## Bottom Components

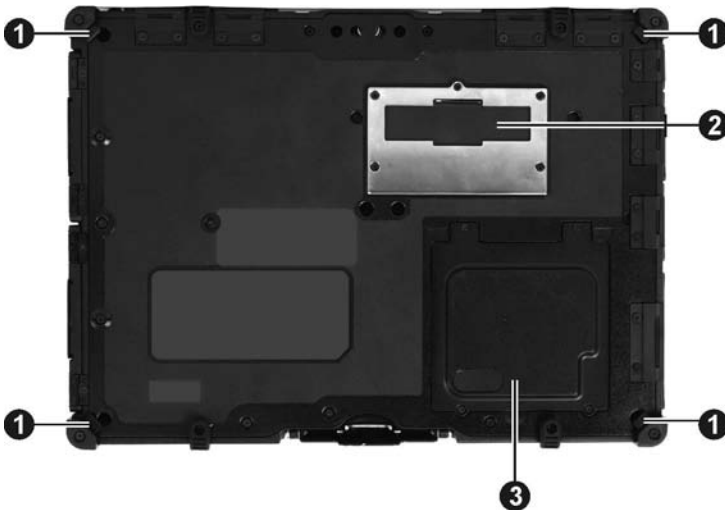

Ref	Component	Description	See Also
①	<b>Strap Holder</b>	Four bottom hooks hold the handgrip strap.	P. 1-18
②	<b>Docking Connector</b>	Inside is the docking connector for connecting an office dock or vehicle dock (purchased separately).	

<b>③</b>	<b>Memory Slots</b>	Inside are the memory slots for expanding the memory size of your computer.	P. 4-13
	<b>SIM Card Slot</b> ( optional )	Inside is the SIM card slot.	P. 2-23

# Using the Accessories

## Using the Tether

A tether is provided for attaching the stylus to your computer.

1. Insert one of the tether's loop ends through the hole of the stylus (as indicated by **1** below). Then, insert the other end through the first loop (as indicated by **2** below) and pull it tight.



2. Insert the other loop end to the tether hole on the computer (as indicated by **1** below). Then, insert the stylus end through the loop (as indicated by **2** below) and pull it tight.

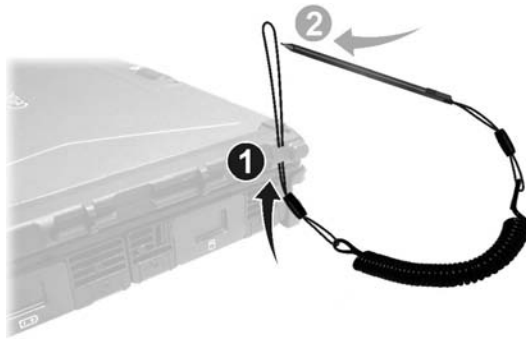

## Attaching the Handgrip Strap

To use the handgrip strap, attach its four loops to the four bottom hooks on your computer. Make sure the loops are securely hooked.



When you need to operate and hold your computer at the same time, insert your hand through the strap for a firm grip.

## Attaching the Shoulder Strap

To use the shoulder strap, secure the snap hooks to the two buckles on your computer. (Select models have four buckles for different positioning of the strap.)



**CAUTION:**

- The strap has been designed to carry only the weight of the computer. Therefore, be sure that the strap does not carry a weight that exceeds the weight of the computer. The strap may accidentally come loose from the computer.
- Do not use a strap that is damaged or about to tear.



# Chapter 2

# Operating Your Computer

This chapter provides information about the use of the computer.

If you are new to computers, reading this chapter will help you learn the operating basics. If you are already a computer user, you may choose to read only the parts containing information unique to your computer.

## **CAUTION:**

- Do not expose your skin to the computer when operating it in a very hot or cold environment.
- The computer can get uncomfortably warm when you use it in high temperatures. As a safety precaution in such a circumstance, do not place the computer on your lap or touch it with your bare hands for extended periods of time. Prolonged body contact can cause discomfort and potentially a burn.

# Using the Internal Keyboard

Your keyboard has all the standard functions of a full-sized computer keyboard plus an **Fn** key added for specific functions.

The standard functions of the keyboard can be further divided into four major categories:

- Typewriter keys
- Cursor-control keys
- Numeric keys
- Function keys

## Typewriter Keys

Typewriter keys are similar to the keys on a typewriter. Several keys are added such as the **Ctrl**, **Alt**, **Esc**, and lock keys for special purposes. When the lock keys (**Caps Lock** and **Num Lk**) are pressed, their corresponding indicators light up.

The Control (**Ctrl**) / Alternate (**Alt**) key is normally used in combination with other keys for program-specific functions. The Escape (**Esc**) key is usually used for stopping a process. Examples are exiting a program and canceling a command. The function depends on the program you are using.

## Cursor-Control Keys

Cursor-control keys are generally used for moving and editing purposes.

**NOTE:** The word “cursor” refers to the indicator on the screen that lets you know exactly where on your screen anything you type will appear. It can take the form of a vertical or horizontal line, a block, or one of many other shapes.



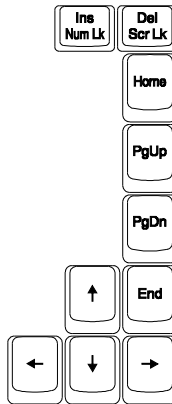

## Numeric Keypad

A 15-key numeric keypad is embedded in the typewriter keys as shown next:

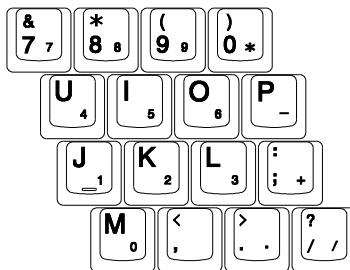

Numeric keys facilitate entering of numbers and calculations. When Num Lock is on, the numeric keys are activated; meaning you can use these keys to enter numerals.

### NOTE:

- When the numeric keypad is activated and you need to type the English letter in the keypad area, you can turn Num Lock off or you can press **Fn** and then the letter without turning Num Lock off.
- Some software may not be able to use the numeric keypad on the computer. If so, use the numeric keypad on an external keyboard instead.

# Function Keys

On the top row of the keys are the function keys: **F1** to **F12**. Function keys are multi-purpose keys that perform functions defined by individual programs.







## Fn Key



















The **Fn** key, at the lower left corner of the keyboard, is used with another key to perform the alternative function of a key. The letter “Fn” and the alternative functions are identified by the color of blue on the keytop. To perform a desired function, first press and hold **Fn**, then press the other key.

## Hot Keys



Hot keys refer to a combination of keys that can be pressed any time to activate special functions of the computer. Most hot keys operate in a cyclic way. Each time a hot key combination is pressed, it shifts the corresponding function to the other or next choice.



You can easily identify the hot keys with the icons imprinted on the keytop. The hot keys are described next.

Key	Description
 	Switches the keyboard backlight on and off (optional).
 	Switches the wireless radio on and off.
 	Decreases the sound volume.

Key	Description
 	Increases the sound volume.
 	Switches the display output when external devices are connected.
 	Decreases the LCD brightness (20 levels).
 	Increases the LCD brightness (20 levels).
 	Switches the touchscreen on and off (option).
 	Switches the touchpad on and off.
 	Switches the system sound output off (mute) and on.
 	Switches LCD backlight on and off.
 	Serves as the sleep button that you can define with Windows' <b>Power Options</b> . ( See the “Power Management” in Chapter 3. )

## Windows Keys

The keyboard has two keys that perform Windows-specific functions:  Windows Logo key and  Application key.

The  Windows Logo key opens the **Start** menu and performs software-specific functions when used in combination with other keys. The  Application key usually has the same effect as a right mouse click. (See your Windows manual for more information.)

# Using the Touchpad

**CAUTION:** Do not use a sharp object such as a pen on the touchpad. Doing so may damage the touchpad surface.

**NOTE:** For optimal performance of the touchpad, keep your fingers and the pads clean and dry. When tapping on the pad, tap lightly. Do not use excessive force.

The touchpad is a pointing device that allows you to communicate with the computer by controlling the location of the pointer on the screen and making selection with the buttons.



The touchpad consists of a rectangular pad (work surface) and a left and right buttons. To use the touchpad, place your forefinger or thumb on the pad. The rectangular pad acts like a miniature duplicate of your display. As you slide your fingertip across the pad, the pointer (also called cursor) on the screen moves accordingly. When your finger reaches

the edge of the pad, simply relocate yourself by lifting the finger and placing it on the other side of the pad.

Here are some common terms that you should know when using the touchpad:

Term	Action
Point	Move your finger on the pad until the cursor points to the selection on the screen.
Click	Press and release the left button. -or- Tap gently anywhere on the pad.
Double-click	Press and release the left button twice in quick succession. -or- Tap twice on the pad rapidly.
Drag and drop	Press and hold the left button, then move your finger until you reach your destination (drag). Finally, release the button (drop) when you finish dragging your selection to the destination. The object will drop into the new location. -or- Gently tap twice on the pad and on the second tap, keep your finger in contact with the pad. Then, move your finger across the pad to drag the selected object to your destination. When you lift your finger from the pad, the selected object will drop into place.
Scroll	To scroll is to move up and down or left and right in the working area on the screen.  To move vertically, place your finger on the right or left edge of the pad and slide your finger up and down along the edge. To move horizontally, place your finger on the top or bottom edge of the pad and slide your finger left and right.  This function works only after you install the touchpad driver supplied with the computer and it may not work for all applications.

**TABLE NOTE:** If you swap the left and right buttons, “tapping” on the touchpad as an alternative method of pressing the left button will no longer be valid.

## Configuring the Touchpad

You may want to configure the touchpad to suit your needs. For example, if you are a left-handed user, you can swap the two buttons so that you can use the right button as the left button and vice versa. You can also change the size of the on-screen pointer, the speed of the pointer, and so on.

To configure the touchpad, go to **Control Panel** → **Mouse Properties**.

# Navigating on the Screen

The screen of your computer is touch-sensitive. You can control the location of the cursor/pointer on the screen using your finger or the included stylus or digitizer pen to communicate with the computer.

**CAUTION:** Do not use sharp objects on the LCD display. Doing so may damage the display surface. Use your finger or the included stylus or digitizer pen.

## Using the Touchscreen

If your computer is equipped with the touchscreen feature, you can use your finger or the included stylus to navigate and select objects on the screen.

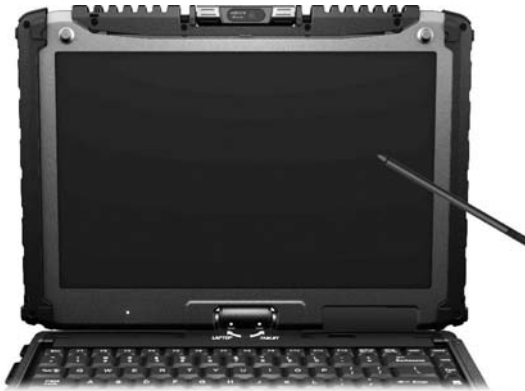

The following table shows how you use the touchscreen to obtain equivalent mouse functions.

Term/Action	Equivalent Mouse Function
<b>Tap:</b> Touch the screen once.	Click/Point
<b>Double-tap:</b> Touch the screen twice rapidly.	Double-click









Term/Action	Equivalent Mouse Function
<b>Tap and hold:</b> Tap and hold until a popup menu appears.	Right-click
<b>Drag:</b> Hold the stylus (or finger) on the screen and drag across the screen until reaching your destination.	Drag

## Using Multi-touch Gestures

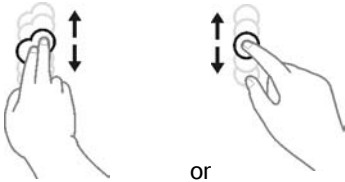
If your computer model comes with multi-touch-capable screen and Windows 7, you can interact with your computer by placing two fingers on the screen. The movement of the fingers across the screen creates “gestures,” which send commands to the computer.

Here are the multi-touch gestures that you can use:

Gestures	Actions  = finger down;  = finger up)	Descriptions
Pan (Scroll)	 <p>Drag 1 or 2 fingers up or down.</p>	Use panning to see another part of a page that has scroll bars.
Zoom (Pinch)	 <p>Move two fingers apart/toward each other.</p>	Use zooming to make an item (a photo for example) on the screen larger or smaller. The gesture works in applications that support mouse wheel zooming.

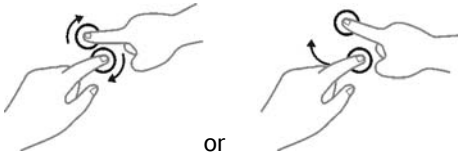
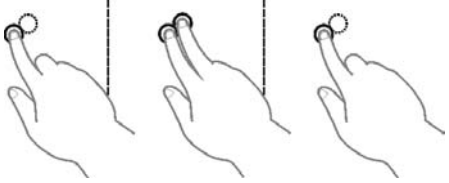
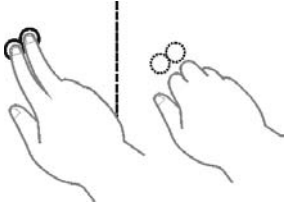
<b>Gestures</b>	<b>Actions</b>  = finger down;  = finger up)	<b>Descriptions</b>
Rotate	 <p>or</p> <p>Move two fingers in opposing directions.            -or-            Use one finger to pivot around another.</p>	<p>Use rotating to move a picture or other item on the screen in a circular direction (clockwise or counter-clockwise). The gesture works in applications that support the specific gesture.</p>
Press and Tap	 <p>Press on target and tap using a second finger.</p>	<p>Use press and tap to access the shortcut menu.</p>
Two-finger Tap	 <p>Tap two fingers at the same time (where the target is in the midpoint between the fingers).</p>	<p>The function is defined by applications that support the specific gesture.</p>

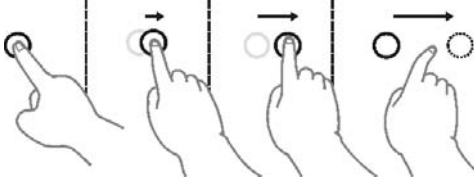
Gestures	Actions (= finger down; ⇨ finger up)	Descriptions
Flicks	 <p data-bbox="244 448 706 512">Make quick drag gestures in the desired direction.</p>	Flick left or right to navigate back and forward in a browser and other applications. The gesture works in most applications that support back and forward.



## Using the Dual Mode Display (Optional)

Dual mode display incorporates both touchscreen and digitizer functions.

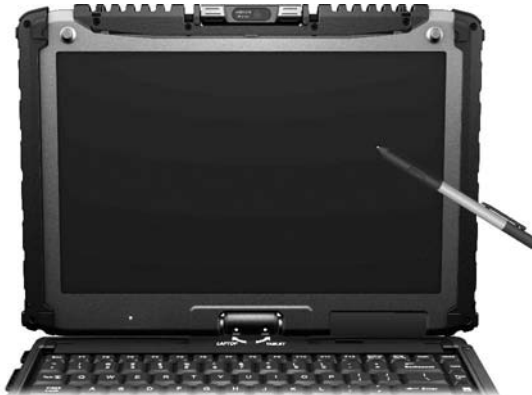
The display is set to Touchscreen mode by default. Touchscreen mode provides all the functionalities that an ordinary touchscreen has. When the computer receives signals from the digitizer pen, the display automatically switches to Digitizer mode.

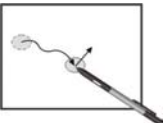
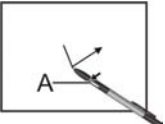

Here are some common terms that you should know when using the digitizer feature:

Term		Action
Move		Move the cursor pointed by the digitizer pen.
Click/Point		Tap gently on the display.
Double-click		Tap twice on the display rapidly.
Drag and drop		Tap lightly on the display and move your digitizer pen until you reach your destination (drag). Finally, release your digitizer pen (drop) when you finish dragging your selection to the destination. The object will drop into the new location.
Right-click		Press and hold down the digitizer pen button (A), then tap gently the object.

**CAUTION:**

- When the LCD display is used alone or with an external display simultaneously, the digitizer function cannot be used when the area of either display is set larger than the default setting of the display resolution.
- Even when only an external display is in use, the cursor will move on the external display if you touch the surface of the LCD display with the pen or bring the pen close to the surface of the LCD display when the digitizer driver is active. Therefore, do not touch the LCD display when only an external display is in use.
- The active digitizer feature cannot be used in the BIOS Setup program or when using the full screen in DOS mode.

**NOTE:**

- You can move the cursor by bringing the digitizer pen close to the screen, without actually touching the screen's surface.
- Do not move the digitizer pen too quickly. If the pen moves too quickly, the cursor may be unable to follow its movement.
- If you cannot click on the edge of the screen, hold the digitizer pen perpendicular to the display and try clicking again.

## Using Landscape or Portrait View

To rotate the display, press the button  located on the front of your computer to open the OSD Control Panel and click . Each time this Rotate button is clicked, the screen display rotates counter-clockwise by 90°.

### For a Model without WWAN Module

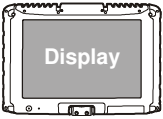
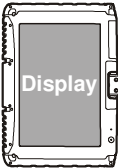
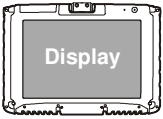
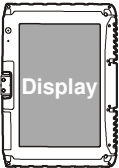
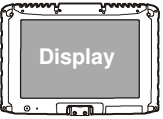
Primary Landscape	Primary Portrait	Secondary Landscape	Secondary Portrait	Primary Landscape
				

### For a Model with WWAN Module

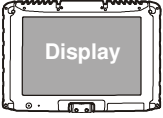
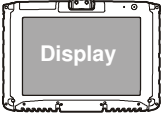
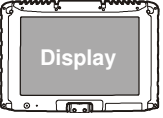
Primary Landscape	Secondary Landscape	Primary Landscape
		

**NOTE:**

- If the screen display resolution has been set to 800×600 pixels, you can rotate the display to Primary Landscape and Secondary Landscape only.
- While the display is rotated:
  - Do not set the display resolution larger than the resolution of the LCD display.
  - If you exit Windows, the next time Windows is started up, the operation of the touchpad will not match the display angle for a few seconds.
  - The computer’s performance will decrease slightly.
  - If a video is played, the picture may not be displayed properly or the sound may be broken up. This problem can be corrected by rotating the display to Primary Landscape.
  - The touchpad’s scroll function does not work.
- The display cannot be rotated when DOS mode is set to “Full Screen.”

# Using the Input Panel



Use the Input Panel to enter text and perform various keyboard functions. There are two types of Input Panels for you to use in Windows 7:

- **Touch Keyboard** allows you to enter text by tapping the keys with your stylus, like pressing the keys on a standard keyboard.

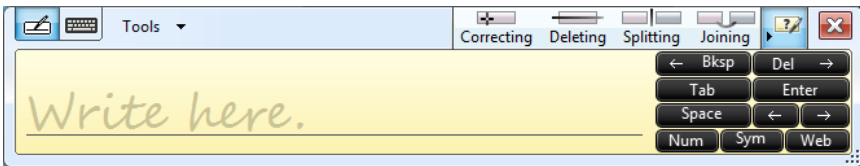

- **Writing Pad** allows you to write on the writing pad, like writing on a piece of paper. Your handwriting will be converted into typed text.



To open the Input Panel, tap the Input Panel tab, which appears by default on the left edge of the screen. (You can also press the  button on the front of the computer to open or close the Input Panel.) To switch between the two types, tap  or  at the upper left corner of the Input Panel.

**NOTE:** For more information on using the Input Panel, see [Windows' online help](#).

# Using the Network Features

## Using the Modem

The internal 56 K fax/data modem allows you to use the telephone line to communicate with others by fax, email, or connect to an online service or bulletin board.

To connect the telephone line to the modem, connect one end of the modem cable to the RJ-11 connector on the computer and the other end to the phone line.



### NOTE:

- When using the communication software, you may have to disable power management. Do not enter the Sleep mode when using the communication software.
- Set parameters such as modem speed (baud rate) and line type (pulse dialing or tone dialing).



## Using the LAN

The internal 10/100/1000Base-T LAN (Local Area Network) module allows you to connect your computer to a network. It supports data transfer rate up to 1000 Mbps.

To connect the network cable to the LAN module, connect one end of the LAN cable to the RJ-45 connector on the computer and the other end to the network hub.



## Using the Wireless LAN

The WLAN module of your computer supports IEEE 802.11a/g/n.

### Turning On/Off the WLAN Radio

**NOTE:** The FAA (Federal Aviation Agency) has deemed it unsafe to operate wireless devices in aircraft as this may interfere with flight safety. Remember to turn off wireless LAN when using your computer in the airplane.



#### FOR WIFI 5G BAND STATEMENT

The device for operation in the band 5150-5250 MHz is only for indoor use to reduce the potential for harmful interference to co-channel mobile satellite systems.

To turn on or off the wireless radio (including the WLAN radio), press the button  located on the front of your computer or spress **Fn+F1**. A small window pops up on the screen to indicate the status.

# Connecting to a Wireless Network

To connect to a wireless network:

1. Make sure that the WLAN function is enabled ( as described above ). The Wireless Network icon  on the taskbar should appear without a red **X**.
2. Tap the Wireless Network icon  on the taskbar. (An orange light in the icon  indicates connections are available.)
3. In the list of available wireless networks, tap a network, and then tap **Connect**.



4. Some networks require a network security key or passphrase. To connect to one of those networks, ask your network administrator or Internet service provider (ISP) for the security key or passphrase.

For more information on setting a wireless network connection, refer to Windows online help.

**NOTE:** You can use Intel® PROSet Wireless to take full advantage of the WiFi capabilities of your computer. See the Help of the utility for instructions.

# Using the Bluetooth Feature

Your computer incorporates the Bluetooth 4.0 capability for short-range (about 50 meters) wireless communications between devices without requiring a cable connection. With Bluetooth, data can be transmitted through walls, pockets and briefcases as long as two devices are within range.

## Turning Off/On the Bluetooth Radio

To turn on or off the wireless radio (including the Bluetooth radio), press the button  located on the front of your computer or press **Fn+F1**. A small window pops up on the screen to indicate the status.

When the Bluetooth radio is on, the Bluetooth icon  appears on the Windows taskbar.

## Connecting to another Bluetooth Device

1. Make sure that the Bluetooth function is enabled (as described above).
2. Make sure that the target Bluetooth device is turned on, discoverable and within close range. (See the documentation that came with the Bluetooth device.)
3. To search for Bluetooth devices, right click the Bluetooth icon  and select **Add a Device**.

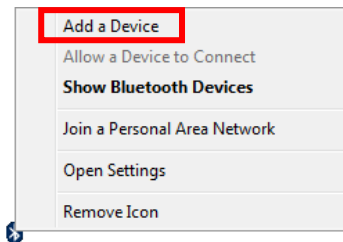

4. Select the device you want to connect from the search results.

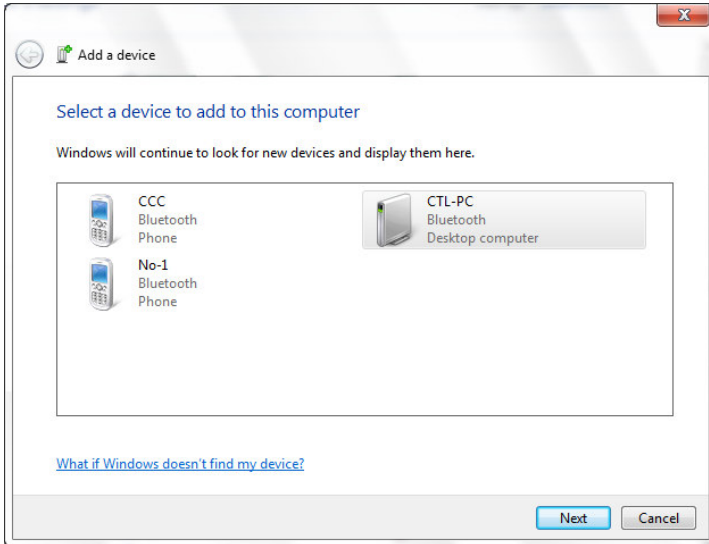

5. Depending on the type of Bluetooth device that you want to connect to, you will need to enter the pertinent information.

For detailed information on using the Bluetooth feature, see Windows' online Help.

# Using the WWAN Feature (Optional)

A WWAN (Wireless Wide Area Network) uses mobile telecommunication cellular network technologies to transfer data. The WWAN module of your computer supports 3G or 4G LTE depending on your model.

**NOTE:** Your computer only supports data transmission; voice transmission is not supported.

## Installing a SIM Card

To use the WWAN feature to connect to the Internet, you need to subscribe to the service and acquire a SIM card from a mobile phone network service provider.

To install the SIM card, follow these steps:

1. Turn off the computer and disconnect the AC adapter.
2. Carefully place the computer upside down.
3. Remove the four screws to open the compartment cover.



4. Locate the SIM card slot.

Slide the locking tab of the SIM card slot inward to unlock. Lift the slot up and, noting the orientation, insert the SIM card into the slot. Close the slot and slide the locking tab outward to secure the card in place.

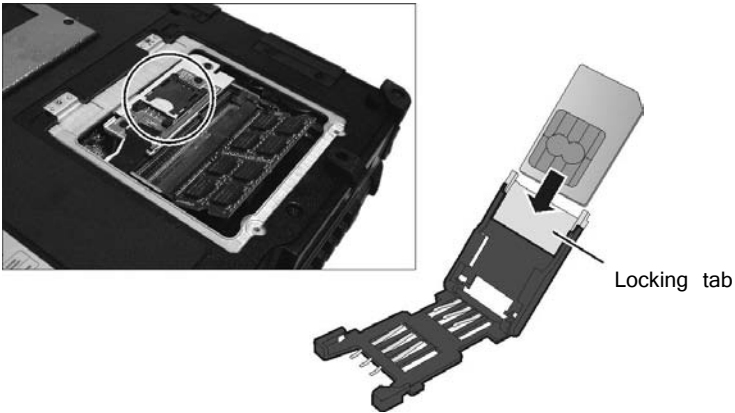

5. Slide the locking tab outward to secure the SIM card in place.
6. Close the compartment cover and secure with four screws.

## Turning Off/On the WWAN Radio

### CAUTION:

For SAR STATEMENT

FCC RF Radiation Exposure Statement

For body worn operation, this device has been tested and meets FCC RF exposure guidelines that positions the EUT a minimum of 0 cm from the body SAR information:

- 1.WWAN transmitter : 0.142W/kg (1g)
- 2.WLAN transmitter: 0.376 W/kg (1g)

To turn on or off the wireless radio (including the WWAN radio), press the button  located on the front of your computer. A small window pops up on the screen to indicate the status.

## Connecting to WWAN Network

1. Make sure that the SIM card is inserted and WWAN function is enabled (as described above).
2. On Windows desktop, double-click the **AirCard Watcher** shortcut. The screen as below appears.



3. If the radio is currently off, click **Turn Radio On** to turn on the radio.
4. Use AirCard Watcher to manage your broadband wireless network connections such as:
  - Connect to the Internet
  - Configure user options
  - Send and receive SMS messages

- Manage profiles
- Use GPS to track your position (for models having the GPS module)

**NOTE:** For detailed information on using **AirCard Watcher**, see the program's online help.



# Using the Fingerprint Scanner (Optional)

## CAUTION:

- We shall not be liable for any loss or damage whatsoever resulting from your use of the fingerprint scanner or neglect of fingerprint scanner use, or any data loss resulting from such developments as fingerprint authentication malfunctioning.
- It is not recommended that you use the fingerprint scanner in a below-freezing temperature. The moisture on your finger can freeze to the scanner's metal surface when you touch it, resulting in a failed operation.

The fingerprint scanner provides a strong authentication mechanism based on fingerprint recognition. It features:

- **Website Log On**  
Logon to your web accounts like banks, webmail, and more with a simple swipe of your finger.
- **Windows Log On**  
Logon to Microsoft® Windows® with a simple swipe of your finger every time you turn on your computer or log onto your desktop.
- **QuickLaunch**  
Quickly launch all your favorite websites, open files and folders, and log in to your accounts with a simple swipe of your finger.
- **KeepSafe**  
Protect your pictures, personal files, and folders using your fingerprint so only you can access them.

**NOTE:** You can register a fingerprint only after creating a password for the Windows user account.

To register your fingerprint, click **Start → All Programs → AuthenTec TrueSuite → AuthenTec TrueSuite**. Click the finger you want to register and follow the onscreen instructions to complete.



You can then use the Fingerprint Software to set up how the fingerprint authentication works.



For detailed information, click the Help button of the software.



## Chapter 3

# Managing Power

Your computer operates either on external AC power or on internal battery power.

This chapter tells you how you can effectively manage power. To maintain optimal battery performance, it is important that you use the battery in the proper way.

# AC Adapter

## CAUTION:

- The AC adapter is designed for use with your computer only. Connecting the AC adapter to another device can damage the adapter.
- The AC power cord supplied with your computer is for use in the country where you purchased your computer. If you plan to go overseas with the computer, consult your dealer for the appropriate power cord.
- When you disconnect the AC adapter, disconnect from the electrical outlet first and then from the computer. A reverse procedure may damage the AC adapter or computer.
- When unplugging the connector, always hold the plug head. Never pull on the cord.

The AC adapter serves as a converter from AC (Alternating Current) to DC (Direct Current) power because your computer runs on DC power, but an electrical outlet usually provides AC power. It also charges the battery pack when connected to AC power.

The adapter operates on any voltage in the range of 100~240 V AC.

# Battery Pack

The battery pack is the internal power source for the computer. It is rechargeable using the AC adapter.

The operating time of a fully charged battery pack depends on how you are using the computer. When your applications often access peripherals, you will experience a shorter operating time.

**NOTE:** Care and maintenance information for the battery is provided in the “Battery Pack” section in Chapter 7.

## Charging the Battery Pack

### NOTE:

- Charging will not start if the battery’s temperature is below 0 °C (32 °F) or above 40 °C (104 °F); the charging process will stop if the battery’s temperature gets above 60 °C (140 °F). To avoid damaging the battery under this situation, disconnect the AC adapter and wait for the battery to return to room temperature before charging again.
- During charging, do not disconnect the AC adapter before the battery has been fully charged; otherwise you will get a prematurely charged battery.

To charge the battery pack, connect the AC adapter to the computer and an electrical outlet. The Battery Charge Indicator (  ) on the computer glows yellow to indicate that charging is in progress. You are advised to keep the computer power off while the battery is being charged. When the battery is fully charged, the Battery Charge Indicator lights green.

It takes approximately 3 hours to fully charge the Li-Ion battery pack when the computer is off, and approximately 6 hours to fully charge the Li-Ion battery pack when the computer is on.

**CAUTION:** After the computer has been fully recharged, do not immediately disconnect and reconnect the AC adapter to charge it again. Doing so may damage the battery.

**NOTE:** The battery level may automatically lessen due to the self-discharge process (0.21 % per day), even when the battery pack is fully charged (100 %). This happens no matter if the battery pack is installed in the computer.

## Initializing the Battery Pack

You need to initialize a new battery pack before using it for the first time or when the actual operating time of a battery pack is much less than expected. Initializing is the process of fully charging, discharging, and then charging. It can take several hours.

A tool called “Gauge Reset” is provided for the purpose. See “Gauge Reset” in Chapter 6 for information on using the tool.

## Checking the Battery Level

**NOTE:** Any battery level indication is an estimated result. The actual operating time can be different from the estimated time, depending on how you are using the computer.

### By Operating System

You can check the approximate battery level using the battery meter function of the operating system. To read the battery level in Windows, click the battery icon on the taskbar.

### By Gas Gauge

On the exterior side of the battery pack is a gas gauge for displaying the estimated battery charge. When the battery pack is not installed in the computer and you want



to know the battery charge, you can press the switch with a pointed device to see the corresponding value of indicator segment that light green.



The value of the corresponding green segment indicates the relative percentage of the battery charge. The battery pack is fully discharged when you see no segment glowing green.

## Replacing the Battery Pack

### CAUTION:

- There is danger of explosion if the battery is incorrectly replaced. Replace the battery only with the computer manufacturer's optional battery packs. Discard used batteries according to the dealer's instructions.
- Do not attempt to disassemble the battery pack.

If you often rely on battery power for a long period of time while traveling, you may consider the purchase of an additional battery pack from your dealer and keep it with you in a fully charged state as a backup.

To replace the battery pack, follow these steps:

1. Make sure that the computer is not turned on or connected to AC power.
2. Locate the battery compartment on the right side of the computer.
3. Slide the door lock toward the left to unlock (❶). Then slide the door latch downward to open the door (❷).







4. Pull the ribbon strip to remove the battery pack.



5. With the ribbon strip facing outward, slide the new battery pack all the way into the slot.
6. Close the door. Make sure the door latch clicks into place. Then, slide the door lock toward the right.

## Battery Low Signals and Actions

The battery icon  changes appearance to display the current state of the battery.

Battery Icon	Battery Level	Description
	Discharging	The icon shows the charge remaining in 10-percent increments until the charge reaches the low-battery level.
	Low	The battery charge has reached the low-battery level (10% by default).
	Critically low	The battery charge has reached the critical battery level (5% by default). By default, Windows will display a notification and put your computer into Hibernation.

When the battery is low, the computer's Battery Charge Indicator (  ) also blinks red to alert you to take actions.

Always respond to low-battery by connecting the AC adapter, placing your computer in Hibernation mode, or turning off the computer.

# Power Management

Your computer supports ACPI (Advanced Configuration and Power Interface) for power management. The power management feature allows you to reduce the power consumption for energy saving.

With an ACPI-compliant operating system such as Windows, power supply to different computer components is controlled on an as-needed basis. This allows maximum power conservation and performance at the same time.

In general, Windows' power management works in this way:

What...	When...
Power to the hard disk is turned off	When the hard disk has been idle for a set period.
Power to the display is turned off	When the display has been idle for a set period.
The computer enters the Sleep mode. The hard disk and display are turned off and the entire system consumes less power.	When the entire system has been idle for a set period.
	When you manually activate the mode.
The computer enters the Hibernation mode. (See the next subsection for more information.)	When the entire system has been idle for a set period.
	When you manually activate the mode.

For detailed information on power management, see Windows' Help.

# Hibernation

Hibernation is a very useful feature. People frequently open many applications when they use computers. It takes some time to get all these applications open and running, and normally they all have to be closed before the computer can be turned off.

When you use the hibernation feature, you do not have to close the applications. The computer stores the state of your computer to a file on the hard disk and then shuts down. The next time you turn on your computer, you return to exactly where you left off.

# Power-Saving Tips

Aside from enabling your computer's power saving mode (see previous section), you can do your part to maximize the battery's operating time by following these suggestions.

- Enter power saving mode when using battery power.
- Do not disable automatic power management features.
- Decrease the LCD brightness to the lowest comfortable level.
- Shorten the length of time before Windows turn off the display.
- Many USB devices use power just by being connected. If you use a USB mouse, you can save power by disconnecting the mouse and using the touchpad. If you use a USB flash drive, unplug it when you are not using it.
- Remove the card (such as PC card, ExpressCard, and Smart Card) if not using it.
- Turn off the wireless radio if you are not using the wireless module (such as WLAN, Bluetooth, or WWAN).
- Turn off the computer when you are not using it.

## Chapter 4

# Expanding Your Computer

You can expand the capabilities of your computer by connecting other peripheral devices.

When using a device, be sure to read the instructions accompanying the device together with the relevant section in this chapter.

# Connecting an External Monitor

If you want the benefits of a larger display screen with higher resolution, you can connect an external display monitor to your computer. Follow this procedure to connect an external monitor:

1. Make sure that the computer is not turned on.
2. Plug the monitor's D-type signal connector to the computer's VGA connector.

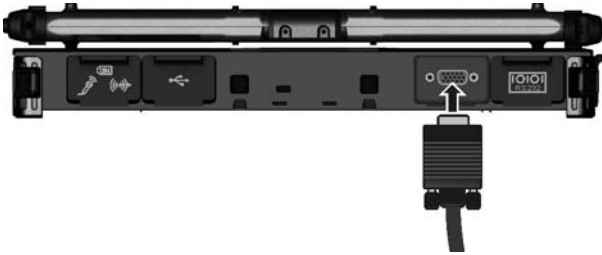

3. Plug one end of the monitor's power cord into the power socket on the monitor and the other end to an electrical outlet.
4. To use the monitor, turn on the monitor before turning on the computer.
5. The monitor should respond by default. If not, you can switch the display to the monitor or to both (simultaneous display), or to multi-display by pressing the **Fn+F5** hot key. In Windows, you can also change the display through the settings in **Display** Properties.
6. You can change display settings through your operating system. See your operating system documentation or online help for specific information.

**CAUTION:** Do not disconnect the external monitor while the computer is in the Sleep mode or Hibernation mode. If no external monitor is connected when the computer resumes, the LCD might not display properly.



# Connecting a Serial Device

Your computer has one or two serial port (depending on model) for connecting a serial device such as a serial mouse or serial communication device (modem).

Follow this procedure to connect a serial device:

1. Make sure the computer is not turned on
2. Plug the device cable to the serial port on the rear of the computer.

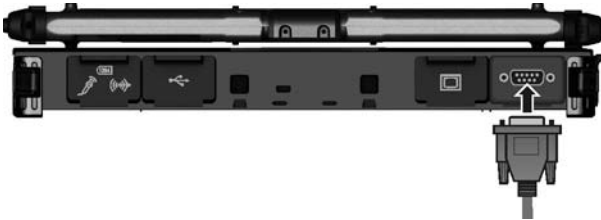

3. Turn on the computer.

**NOTE:** Portable modems that derive power through the serial port cannot be used with the computer. Instead, use a modem that is powered by its own internal battery or external AC power.

# Connecting a USB Device

Your computer has three USB ports (two USB 3.0 ports at the left side and one USB 2.0 port at the back) for connecting USB devices, such as a digital camera, scanner, printer, modem, and mouse.

USB 3.0 supports a transfer rate up to 5 Gbit/s and USB 2.0 a transfer rate up to 12 MB/s.

To connect a USB device, plug the device cable to a matching USB port.

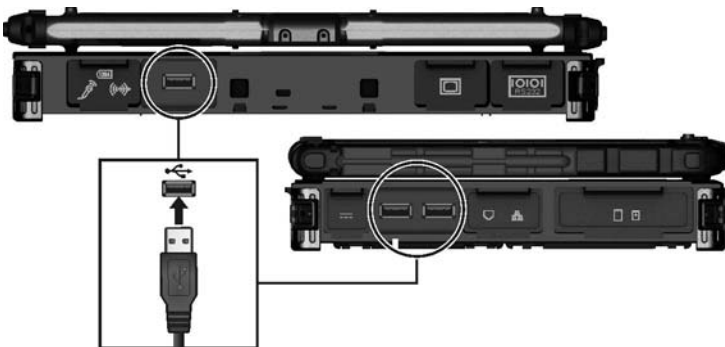

# Connecting an IEEE 1394 Device

Your computer has a mini IEEE 1394a port for connecting IEEE 1394 devices that include not only computer peripheral devices such as scanner, printer and high-quality CCD, but also consumer electronic equipment such as DVCAM and VCR.



To connect an IEEE 1394 device, prepare an IEEE 1394 cable. Plug the appropriate end of the cable to the computer's mini IEEE 1394 connector and the other end to the device's corresponding connector.

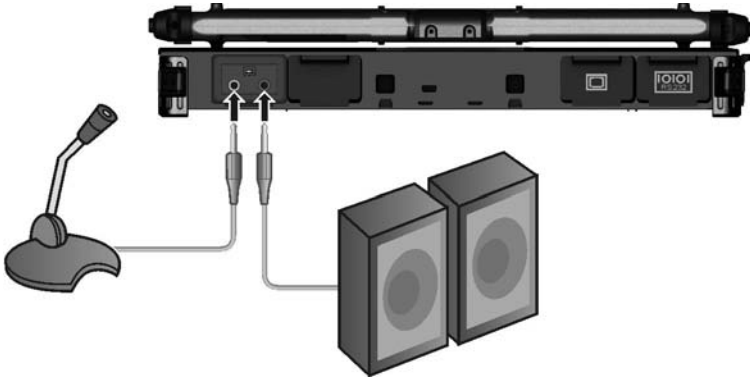

# Connecting Audio Devices

For higher audio quality, you can send or receive sound through external audio devices.



- **Audio Output Connector** (  ) can be connected to speakers, headphones, or earphone set.
- **Microphone Connector** (  ) can be connected to an external microphone for recording voice or sound.

## NOTE:

- After connecting an external audio device, make sure that you specify the use of the correct audio device in Windows.
- When using the external speakers/headphones or microphone, you cannot use the internal one.

# Using ExpressCards

Your computer has an ExpressCard slot.

The ExpressCard slot can accommodate a 54 mm (ExpressCard/54) or 34 mm (ExpressCard/34) wide ExpressCard. Typical ExpressCards support a very extensive range of applications including memory, wired and wireless communication cards, and security devices.

Shown next are the appearances of ExpressCards for your reference.



**ExpressCard/54**



**ExpressCard/34**

To insert an ExpressCard:

1. Locate the ExpressCard slot on the left side of the computer. It can be the upper slot (standard configuration) or lower slot depending on your model.
2. Slide the ExpressCard, with its label facing up, all the way into the slot until the rear connectors click into place.



3. When a new card is seated, the computer will detect it and try to install the appropriate driver. Follow the on-screen instructions to complete the process.

To remove an ExpressCard:

1. Double-click on the **Safely Remove Hardware** icon (  ) found on the Windows taskbar and the **Safely Remove Hardware** window appears on screen.
2. Select (highlight) the ExpressCard from the list to disable the card.
3. Push the eject button and the card will slide out slightly.
4. Pull the card out of the slot.

# Using PC Cards

## NOTE:

- Some PC cards require additional system resources. Before using such PC card, you may have to free other system resources for the PC card.
- Although some PC cards can be inserted and removed without turning off the computer, you cannot remove or install PC cards during Sleep mode.

Your computer (standard configuration) has one PC card slot that support CardBus specifications. The slots can accommodate a type II card. Typical type II cards are flash memory, SRAM, modem, LAN, and SCSI cards.

To insert a PC card:

1. Locate the PC card slot (the lower slot) on the left side of the computer.
2. Slide the PC card, with its label facing up, into the slot until the eject button pops out.



3. When a new card is seated, the computer will detect it and try to install the appropriate driver. Follow the on-screen instructions to complete the process.

To remove a PC card:

1. Double-click the **Safely Remove Hardware**  icon found on the Windows taskbar and the **Safely Remove Hardware** window appears on screen.
2. Select (highlight) the PC card from the list to disable the card.

3. Push the eject button and the card will slide out slightly.
4. Pull the card out of the slot.



# Using Smart Cards (Optional)

Your computer may have a smart card reader.

With an embedded microcontroller, smart cards have the unique ability to store large amounts of data, carry out their own on-card functions (e.g., encryption and mutual authentication), and interact intelligently with a smart card reader.

To insert a smart card:

1. Locate the smart card slot.
2. Slide the smart card, with its label and embedded computer chip facing up into the slot.



3. When a new card is seated, use the third-party smart card software to allow your computer to read it.

To remove a smart card:

1. Make sure that the third-party smart card software is not accessing the smart card.
2. Pull the card out of the slot.

# Using Storage Cards

**NOTE:** You can use only storage cards. Your SD card reader does not support cards with I/O (input/output) functions such as a wireless network card or Bluetooth card.

Your computer has an SD card reader. The card reader is a small drive for reading from and writing to removable storage cards (or called memory cards). The card reader supports SD (Secure Digital), SDHC (Secure Digital High Capacity), and SDXC (Secure Digital eXtended Capacity) cards.

To insert a storage card:

1. Locate the SD card reader on the left side of the computer.
2. Align the card with its connector pointing to the slot and its label facing up. Slide the card into the slot until it reaches the end.



3. Windows will detect the card and assign it a drive name.

To remove a storage card:

1. Double-click **My Computer**.
2. Right-click the drive with the card and select **Eject**.
3. Push the card to release and then pull the card out of the slot.

# System Memory Upgrade

You can upgrade your computer by expanding system memory.

## CAUTION:

- It is not recommended that you buy and install RAM modules by yourself. If you want to expand system memory, please ask Getac service center to install DRAM modules for you so that full compatibility can be guaranteed.
- RAM modules are extremely sensitive to static electricity. There are cases where static electricity generated by the human body has adversely affected such modules. When inserting or removing a RAM module, do not touch the terminals or internal components, insert objects other than the module, or allow foreign particles to enter. Doing so has been known to cause damage, fire, or electrical shock.

To install the RAM module:

1. Remove the battery pack (see chapter 3) and make sure that the computer is not connected to AC power.
2. Carefully place the computer upside down.
3. Remove the four screws to open the compartment cover.



4. To install the RAM module, match the module's notched part with the socket's projected part and firmly insert the module into the socket at a 20-degree angle. Then push down until the retaining clips lock the module into position.



**CAUTION:** If the RAM module is difficult to insert or difficult to push down, do not force it. Check once more to ensure that the module is positioned correctly.

5. Close the compartment cover and secure with four screws.

## Chapter 5

# Using BIOS Setup and System Recovery

BIOS Setup Utility is a program for configuring the BIOS (Basic Input/ Output System) settings of the computer. BIOS is a layer of software, called firmware, that translates instructions from other layers of software into instructions that the computer hardware can understand. The BIOS settings are needed by your computer to identify the types of installed devices and establish special features.

System Recovery reinstalls Windows to your computer and restores it to the factory default status.

This chapter tells you how to use the BIOS Setup and System Recovery.

# BIOS Setup

## When and How to Use

You need to run BIOS Setup Utility when:

- You see an error message on the screen requesting you to run BIOS Setup Utility.
- You want to restore the factory default BIOS settings.
- You want to modify some specific settings according to the hardware.
- You want to modify some specific settings to optimize the system performance.

To run BIOS Setup Utility, press the **F2** key when the prompt appears on the screen during the system startup. The prompt shows up on the screen for only a few seconds. You must press the **F2** key quickly. The BIOS Setup Utility main screen appears as shown next.

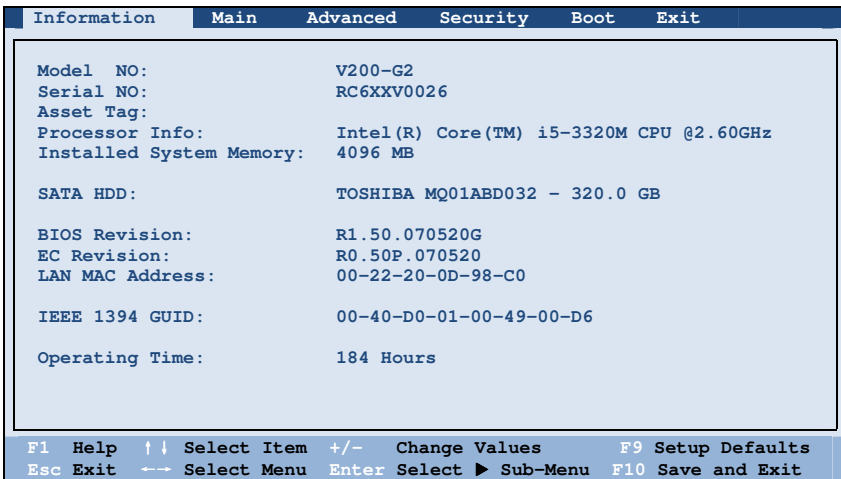

In general, you can use the arrow keys to move around and + / - keys to change the setup values. Keyboard information can be found at the bottom of the screen.

**NOTE:**

- The BIOS Setup Utility screens shown in this chapter are for your reference only. The actual items or settings on your computer may differ.
- The BIOS Setup Utility program may have been updated after the publication of this manual.
- The settings you select in your operating system might override similar settings in BIOS Setup Utility.

## Information Menu

The Information menu contains the basic configuration information of the system. There are no user-definable items in this menu.

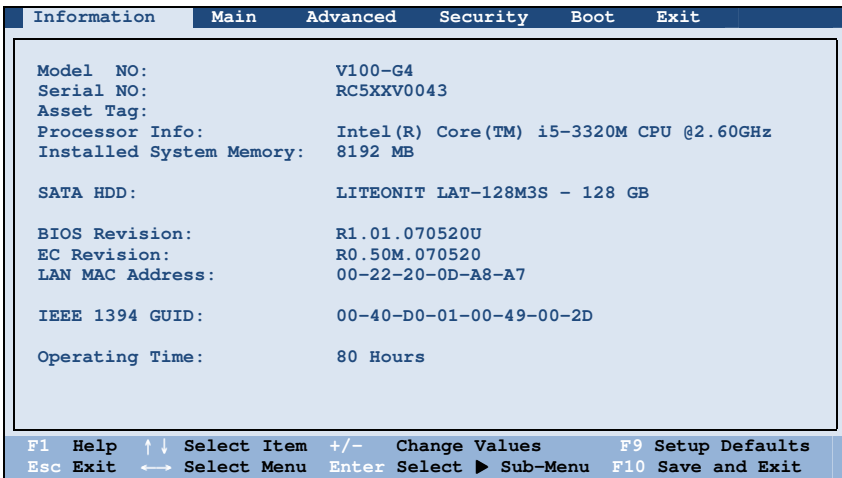

**NOTE:** The “Asset Tag” information appears when you have entered the asset number for this computer using the asset management program. The program is provided in the **Asset tag** folder of the Driver disc.

# Main Menu

The Main menu contains various system settings.

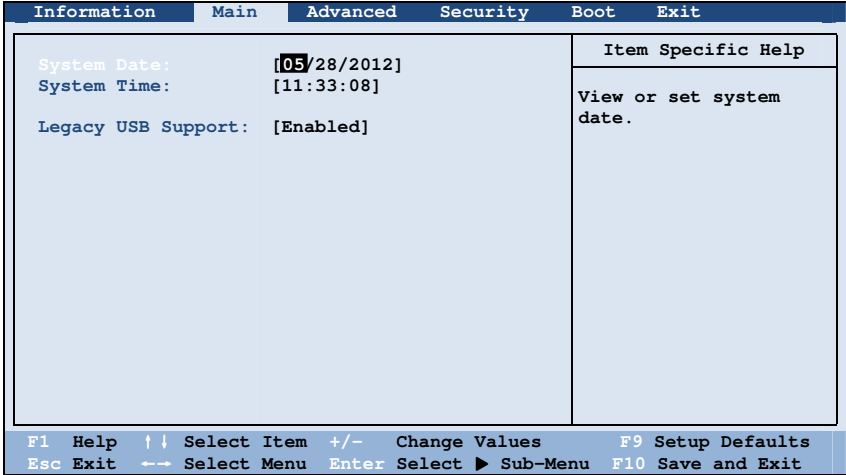

**System Time** sets the system time.

**System Date** sets the system date.

**Legacy USB Support** enables or disables the system's support for Legacy USB device in DOS mode.



# Advanced Menu

The Advanced menu contains the advanced settings as shown next.

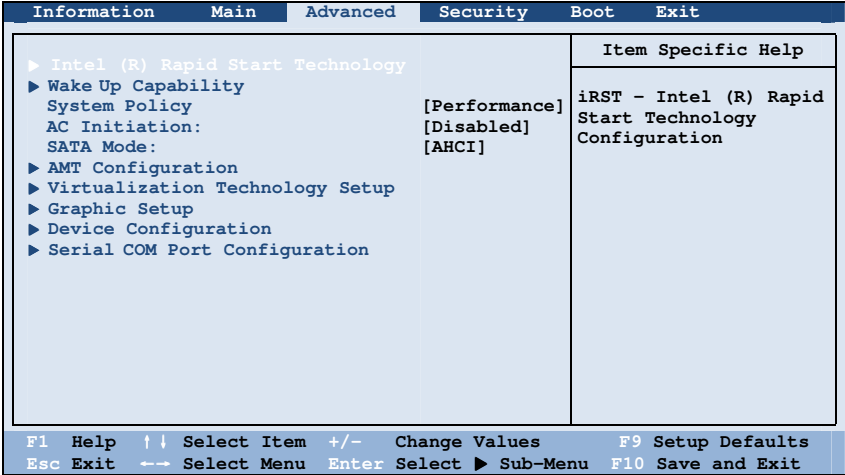

**Intel (R) Rapid Start Technology** configures iRST. Press **Enter** to access the submenu as shown below.

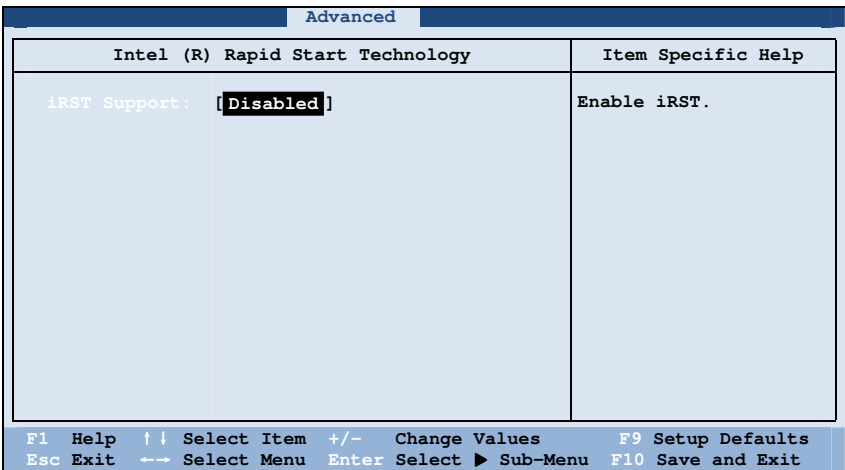

**iRST Support** enables or disables iRST, which gets your system up and running faster.

**Wake Up Capability** specifies events for waking up the system. Press **Enter** to access the submenu as shown below.

Advanced	
Wake Up Capability	Item Specific Help
Ring Wake Up From S3: [Disabled]	Allow a modem activity to wake up the system from S3(Sleep) state.
USB Wake Up From S3: [Disabled]	
Wake on PCH LAN: [Disabled]	
F1 Help ↑↓ Select Item +/- Change Values F9 Setup Defaults Esc Exit ↔ Select Menu Enter Select ► Sub-Menu F10 Save and Exit	

**Ring Wake Up From S3** allows a modem device activity to wake up the system from S3 (Sleep) state.

**USB Wake Up From S3** allows a USB device activity to wake up the system from S3 (Sleep) state.

**Wake on PCH LAN** allows a LAN activity to wake up the system from S3 (Sleep) state.

**System Policy** sets if the system always runs at full speed (*Performance*) or lowers down when its temperature is too high (*Balance*).

**AC Initiation** sets if connecting AC power will automatically start or resume your computer.

**SATA Mode** set to *AHCI* if your hard disk supports AHCI. AHCI allows you to take advantage of Advanced Host Controller Interface features. The options are *IDE* and *AHCI*.

**CAUTION:** Incorrect SATA mode settings can result in hard disk drive boot failure.

**AMT Configuration** configures Active Management Technology parameters. Press **Enter** to access the submenu as shown below.

Advanced	
AMT Configuration	Item Specific Help
Intel AMT: <b>[Enabled]</b> Intel AMT Setup Prompt: <b>[Disabled]</b>	Enable/Disable Intel (R) Active Management Technology BIOS Extension. Note: iAMT H/W is always enabled. This option just controls the BIOS extension execution. If enabled this requires additional firmware in the SPI device
F1 Help ↑↓ Select Item +/- Change Values F9 Setup Defaults Esc Exit ←→ Select Menu Enter Select ► Sub-Menu F10 Save and Exit	

**Intel AMT** enables or disables Intel® Active Management Technology BIOS extension execution. AMT allows the system administrator to access an AMT featured computer remotely.

**Intel AMT Setup Prompt** determines whether the prompt for entering Intel AMT Setup appears or not during POST. If disabled, users cannot enter Intel AMT Setup.

**Virtualization Technology Setup** sets Virtualization Technology parameters. Press **Enter** to access the submenu as shown below.

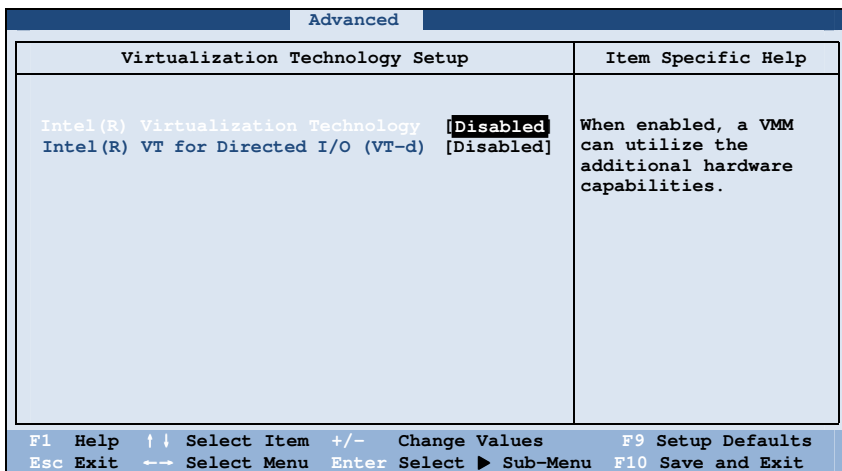

**Intel(R) Virtualization Technology** enables or disables Intel® VT (Intel Virtualization Technology) feature which provides hardware support for processor virtualization. When enabled, a VMM (Virtual Machine Monitor) can utilize the additional hardware virtualization capabilities provided by this technology.

**Intel(R) VT for Directed I/O (VT-d)** enables or disables VT-d (Intel® Virtualization Technology for Directed I/O). When enabled, VT-d helps enhance Intel platforms for efficient virtualization of I/O devices.

**Graphics Setup** sets graphics related options. Press **Enter** to access the submenu as shown below.

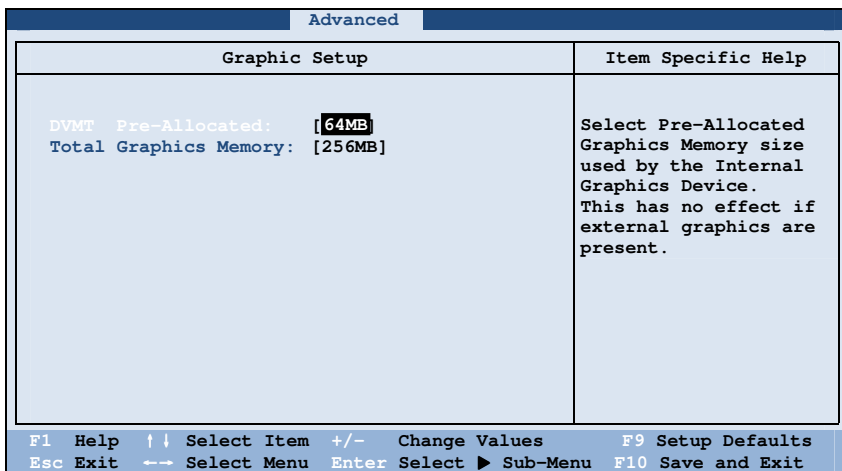

**NOTE:** Graphic Setup parameters apply to the internal graphics device only.

**DVMT Pre-Allocated** sets the amount of pre-allocated (fixed) graphics memory for use by the internal graphics device.

**Total Graphics Memory** sets the amount of total graphics memory (pre-allocated + fixed + DVMT) for use by the internal graphics device.

**Device Configuration** enables or disables several hardware components. Press **Enter** to access the submenu as shown below.

Advanced	
Device Configuration	Item Specific Help
Wireless LAN: <b>[Enabled]</b>	Set WLAN device to enable/disable.
WWAN: <b>[Enabled]</b>	
Bluetooth: <b>[Enabled]</b>	
Media Card Reader: <b>[Enabled]</b>	
Smart Card Reader: <b>[Enabled]</b>	
HD Audio: <b>[Enabled]</b>	
Modem: <b>[Enabled]</b>	
Fingerprint Scanner: <b>[Enabled]</b>	
1394 Port: <b>[Enabled]</b>	
Touch Screen: <b>[Enabled]</b>	
GPS: <b>[Enabled]</b>	
F1 Help ↑↓ Select Item +/- Change Values F9 Setup Defaults Esc Exit ←→ Select Menu Enter Select ► Sub-Menu F10 Save and Exit	

You can enable or disable the following items:

- **Wireless LAN**
- **WWAN**
- **Bluetooth**
- **Media Card Reader** (SD)
- **Smart Card Reader**
- **HD Audio** (High Definition Audio)
- **Modem**
- **Fingerprint Scanner**
- **1394 Port**
- **Touch Screen**
- **GPS**

**Serial COM Port Configuration** enables or disables the serial port. Press **Enter** to access the submenu as shown below.

Advanced	
COM PORT Configuration	Item Specific Help
Serial COM PORT1 [Enabled]	This option controls the Onboard COM1 Address. When enabled, COM1 uses address 0x3F8h and IRQ4.
Serial COM PORT2 [Enabled]	
Serial COM PORT3 [Enabled]	
F1 Help ↑↓ Select Item +/- Change Values F9 Setup Defaults Esc Exit ←→ Select Menu Enter Select ► Sub-Menu F10 Save and Exit	

# Security Menu

The Security menu contains the security settings, which safeguard your system against unauthorized use.

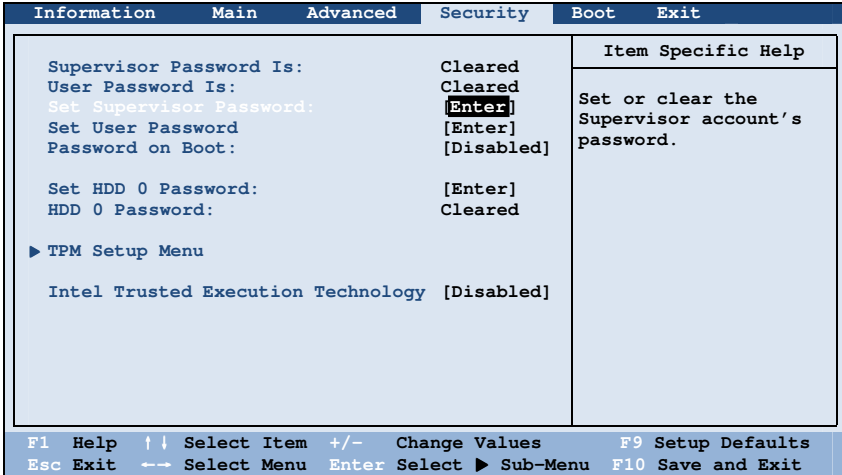

## NOTE:

- You can set the user password only when the supervisor password has been set.
- If both the administrator and user passwords are set, you can enter any of them for starting up the system and/or entering BIOS Setup. However, the user password only allows you to view/change the settings of certain items.
- A password setting is applied right after it is confirmed. To cancel a password, leave the password empty by pressing the **Enter** key.

**Supervisor/User Password Is** shows whether you have set the supervisor/user password or not for the system.

**Set Supervisor/User Password** sets the supervisor/user password. When typing the password, first make sure that Num Lock is off, and then type the password in the entry fields and press **Enter**. Confirm your password by typing it again and pressing



**Enter.** You can set the supervisor/user password to be required for starting up the system and/or entering BIOS Setup.

**Password on Boot** allows you to enable or disable the entering of password for booting up your system. Once the password is successfully set and this item is enabled, it is required for booting up the system.

**Set HDD 0 Password** sets the password for locking the Primary Master hard disk drive. After setting a password, the hard disk drive can only be unlocked by the password no matter where it is installed.

**HDD 0 Password Is** shows whether you have set the hard disk password or not.

**TPM Setup Menu** sets various TPM parameters. Press **Enter** to access the submenu as shown below.

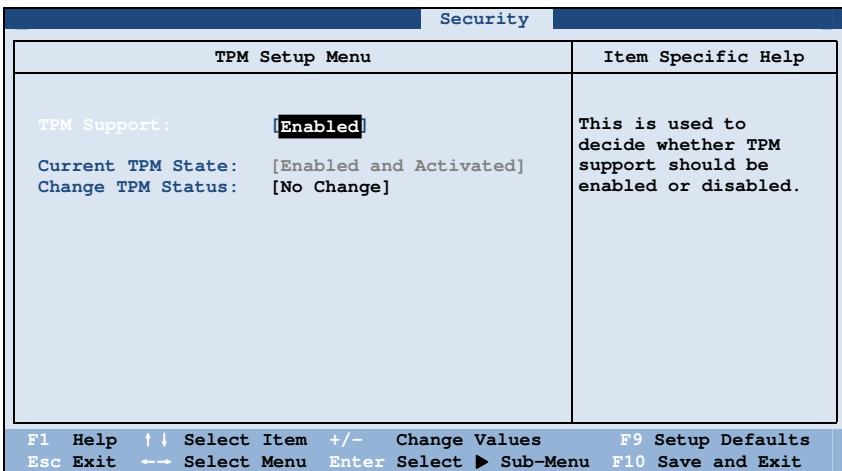

**TPM Support** enables or disables TPM (Trusted Platform Module) support. TPM (Trusted Platform Module) is a component on your computer's mainboard that is specifically designed to enhance platform security by providing a protected space for key operations and other security critical tasks.

**Current TPM State** shows the current TPM state.

**Change TPM State** allows you to select between *No Change*, *Clear*, *Deactivate & Disable*, and *Enable & Activate*.

**Intel Trusted Execution Technology** enables utilization of additional hardware capabilities provided by Intel® Trusted Execution Technology.

## Boot Menu

The Boot menu sets the sequence of the devices to be searched for the operating system.

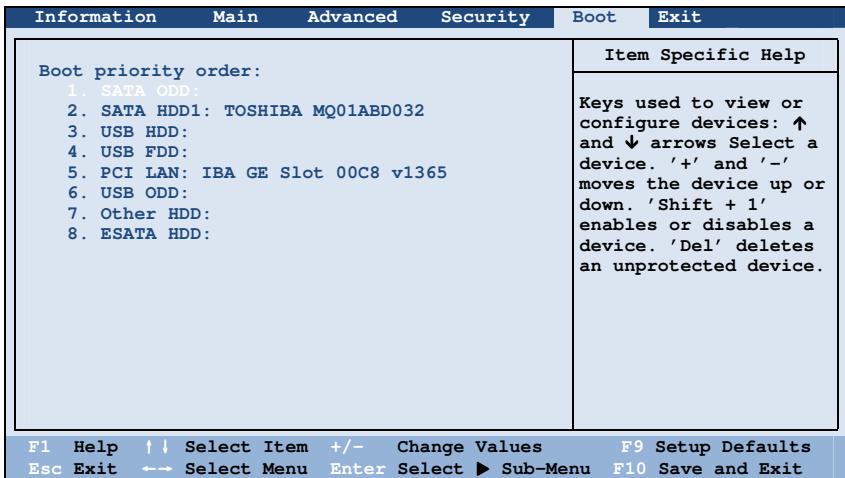

The bootable devices will be automatically detected during POST and shown here, allowing you to set the sequence that the BIOS uses to look for a device from which to load the OS.

Below is a brief description of keyboard usage:

Key	Function
↑, ↓	Selects (highlight) a boot device.
+, -	Changes the boot sequence.
<b>1</b> to <b>4</b>	Loads the default boot sequence.
Key	Function
<b>f</b> or <b>r</b>	Specifies if the boot device is fixed ( <b>f</b> ) or removable ( <b>r</b> ).
<b>X</b>	Moves the highlighted boot device from the “Boot priority order” list to the “Excluded from boot order” list, and vice versa.
<b>Shift+1</b>	Deactivates/activates the highlighted boot device on the “Boot priority order” list. When a device has been deactivated, an “!” (exclamation) symbol appears beside the item and system will bypass it when detecting boot device during POST.

## Exit Menu

The Exit menu provides ways of exiting BIOS Setup. After finishing with your settings, you must save and exit so that the changes can take effect.

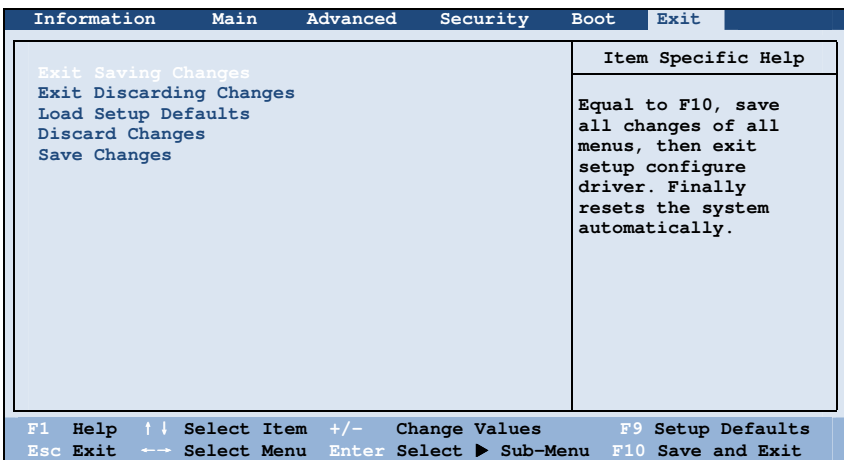

**Exit Saving Changes** saves the changes you have made and exits BIOS Setup Utility.

**Exit Discarding Changes** exits BIOS Setup Utility without saving the changes you have made.

**Load Setup Defaults** loads the factory default values for all the items.

**Discard Changes** restores the previous values for all the items.

**Saves Changes** saves the changes you have made.

# System Recovery

Use System Recovery when:

- Your Windows operating system does not start at all.
- You want to restore the system to the factory state.

## WARNING:

- Using this feature will reinstall Windows to your system and configure it to the system's factory default settings. All data on the hard disk drive will be lost.
- Make sure that power is not interrupted during the recovery process. An unsuccessful recovery may result in Windows startup problems.

To run System Recovery:

1. Connect the AC adapter.
2. During system startup when the following screen appears, press **Ctrl + Alt + F2** keys for four seconds.

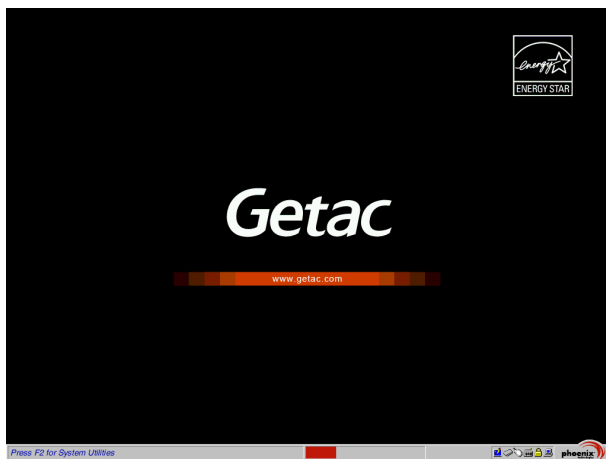

3. In the screen that appears, select **Recovery** to start the recovery process.



4. The progress bar shows the percentage completed. When it reaches 100%, the system turns off.
5. Turn on the computer. The Windows setup wizard starts. Follow the onscreen prompts to continue.
6. When the system restarts, the installer screen appears. The installer will perform system hardware detection and driver installation.

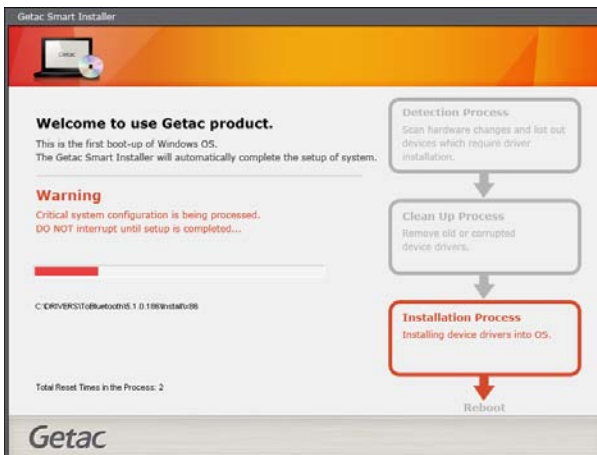

7. When completed, the system restarts and displays Windows desktop.





# Chapter 6

# Using Getac Software

Getac software includes application programs for specific computer components and utility programs for overall management.

This chapter describes how to use the software.



# Using the OSD Control Panel





The OSD (On Screen Display) Control Panel provides a user-friendly interface for you to quickly activate or operate certain functions on your computer with a simple tap of the screen.







To open the OSD Control Panel, press the button  on the front of your computer. The following screen appears.







The following table shows the various functions on the OSD Control Panel.

Icon	Function
	Opens the Help file explaining the OSD Control Panel.
	Opens the Quick Button Setup menu (refer to the next section for details).
	Closes the OSD Control Panel.

Icon	Function
	<p>Serves as the master ON/OFF control of the RF radio. The word on the button indicates the current status.</p> <p>The on/off status will persist through Sleep/Hibernation mode but it will always be on upon restarting.</p>
	<p>Enables or disables the G-Rotate function. When enabled, the LCD display will rotate itself to match the direction the computer is held.</p> <p>This button is available for use only when the computer is in Tablet mode. The function is automatically enabled whenever you change the LCD display position to the Tablet style.</p>
	<p>Rotates the orientation from default landscape to <b>90°</b> portrait, <b>180°</b> landscape, or <b>270°</b> portrait.</p> <p>The status will persist through Sleep/Hibernation mode or system power off.</p>
	<p>Switches the ECO mode to the next choice (<b>MAX</b>, <b>QUICK</b>, <b>WORK</b>, or <b>OFF</b>). The word on the button indicates the current status. (For information on ECO modes, see “ECO Tab” later in this chapter.)</p> <p>This button works only when using battery power. The ECO mode will return to the default <b>OFF</b> setting whenever AC power is connected, backlight status is changed, the system resumes from Sleep/Hibernation mode, or the system is restarted.</p>
	<p>Switches the LCD backlight to the next choice (<b>MAX</b>, <b>AUTO</b>, or <b>MANUAL</b>.) The word on the button indicates the current status.</p>

Icon	Function
	<p>When set to <b>MAX</b>, the backlight is adjusted to the highest brightness level. When set to <b>AUTO</b>, the brightness will be automatically adjusted according to the current ambient light.</p> <p>The backlight will return to the default <b>MANUAL</b> setting whenever the system resumes from Sleep/Hibernation mode or the system is restarted.</p>
	<p>Switches the display output to the next choice: <b>VGA</b> (external monitor), <b>BOTH</b> (LCD and external monitor), or <b>LCD</b>.</p> <p>This button works only when an external display is connected.</p>
	<p>Starts Microsoft Internet Explorer by default.</p> <p>You can assign a different function to this button (refer to the next section for details).</p>
	<p>Starts Windows Mobility Center by default.</p> <p>You can assign a different function to this button (refer to the next section for details).</p>
	<p>Starts the touchscreen calibration tool by default.</p> <p>You can assign a different function to this button (refer to the next section for details).</p>
	<p>Starts the Bluetooth Setup utility by default.</p> <p>You can assign a different function to this button (refer to the next section for details).</p>
	<p>Opens the Input Panel by default.</p> <p>You can assign a different function to this button (refer to the next section for details).</p>

Icon	Function
	<p>Allows you to adjust the sound volume by dragging the knob along the bar.</p>
	<p>Switches the system sound output OFF (mute) and ON.</p>
	<p>Allows you to adjust the LCD brightness level by dragging the knob along the bar.</p>
	<p>System enters “black-out” mode by turning off the LCD display, LED indicators, touchscreen, and sound.</p> <p>Press the power button (  ) to wake up the system from “black-out” mode.</p>

# Quick Button Setup

By default, the five quick buttons on the OSD Control Panel have pre-assigned functions. You can re-define the buttons:

1. Click the Quick Button Setup button (  ) on the OSD control panel and the **Quick Button Setup** window appears.
2. At the bottom of the screen are the five quick buttons. Click the button you want to change.



3. Depending on the type of task to be associated with the button, click the Open button  of the **Executed Program** or **Open Folder** type.
4. A dialog box appears. Select the desired program or folder and click **Open** or **Select**. After your selection, the entry field will display the program or folder information.

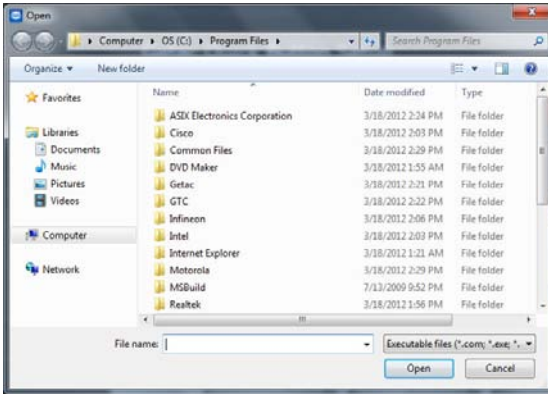

OR

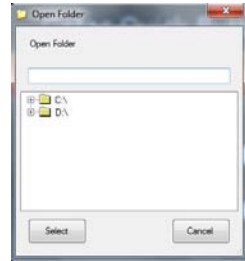

5. You can change the image appearing on the button by clicking the **Select Image** button. After selecting the image file, the original image on the button will be replaced.
6. Click **Set** to complete the changes.

**NOTE:** You can restore the quick buttons to the default settings by clicking **Reset All**.

# Using Button Manager

The five quick buttons located on the front of your computer come with predefined functions. You can use Button Manager to re-define the buttons.

1. Click **Start → Programs → Button Manager → Button Manager**. The following screen appears.



2. Select the button to re-define.
3. Under the **Update Button Function** click the **Key Name** dropdown list to see the available options and select the option you want.



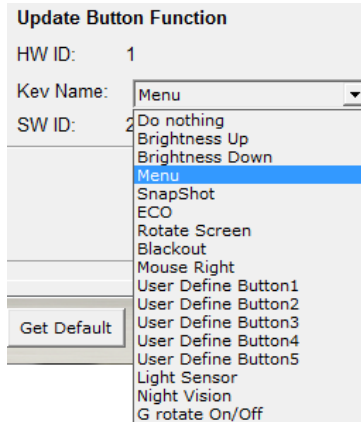

The option *User Define Button* ( 1 to 5 ) means the Quick Button in the OSC Control Panel.

4. Repeat the steps for the other buttons that you want to re-define.
5. For the changes to take effect immediately, click **Start Flash**.
6. If you intend to save the configurations for later retrieval, click **SAVE**. Select a location, enter a filename, and click **Save** to save the current configurations as a .bfh file.

Click **Load** the next time you use Button Manager to load any previously saved configurations.

**NOTE:** You can restore to the default settings by clicking **Get Default**.

# Using G-Manager

G-Manager is a unified user interface utility that allows you to manage and configure the following:

- System
- Battery
- ECO (economic mode)
- Light Sensor
- Ignition
- Monitoring
- GPS Status

## Starting G-Manager

You can start up G-Manager by any of the following methods:

- Click **Start** → **All Programs** → **Getac Utility** → **G-Manager**, or
- Click and hold the  icon located on the taskbar until a ring appears. From the small menu that pops up, click **G-Manager**.

The G-Manager window appears, containing 7 tabs as described later.

**NOTE:** Depending on your model, the actual items appearing on the screen may differ from those shown in this manual.

# System Tab

The **System** tab provides system information.

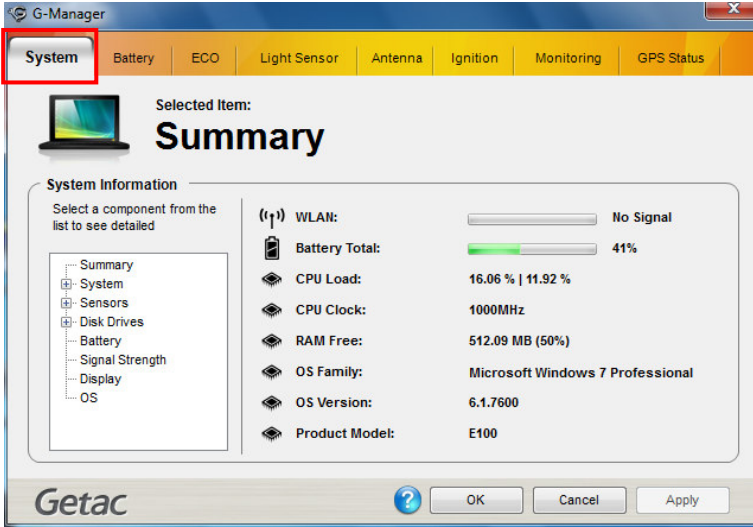

To view specific information, select the component from the list on the left side of the screen. The information of the selected component will be displayed on the right side of the screen.

# Battery Tab

The **Battery** tab allows you to check the battery status and configure the battery.

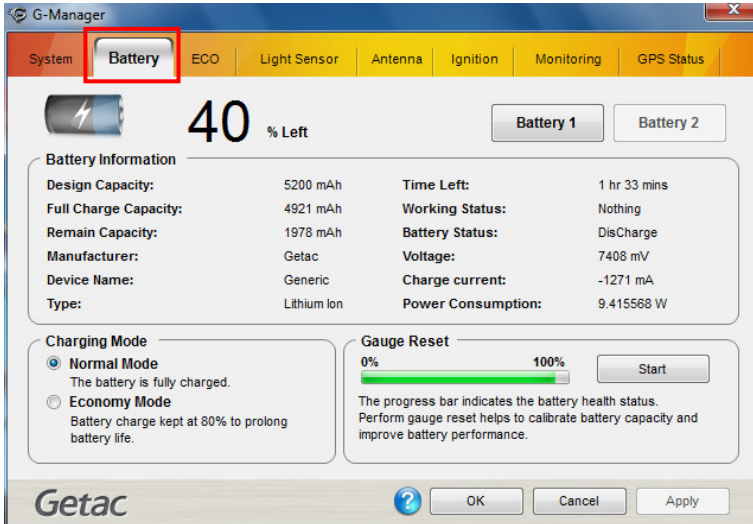

At most two batteries may be supported. Click **Battery 1** or **Battery 2** to view the information of each battery (if your model has a second battery).

## NOTE:

- When the percentage **% Left** is less than 10% then the value will be displayed in red.
- When an abnormal battery condition is detected **Battery Status** value will be displayed in red.

## Battery Information

The upper portion of the screen displays the current status of the selected battery.

## Charging Mode

The lower left portion of the screen allows you to select the charging mode.

- **Normal Mode** – The battery will be fully charged. When remaining charge reaches below 95%, then charging will start until it is fully charged.
- **Economy Mode** – This mode helps prolong battery life by charging up to 80% of its total capacity only. It is highly recommended if you are using AC power most of the time.

## Gauge Reset

The lower right portion of the screen contains the battery health bar and provides the battery calibration function.

The health bar shows the battery's health by percentage. A low percentage indicates poor health and therefore the need to perform a gauge reset to calibrate the battery's capacity and improve the battery's performance. The gauge reset process includes discharging and then fully recharging the battery in two cycles. It can take several hours.

To perform a gauge reset:

1. Connect the AC adapter.
2. Click **Start**, located next to the health bar
3. In the pop-up dialog box, click **Yes** to start the process. The window as below appears displaying the progress bar.

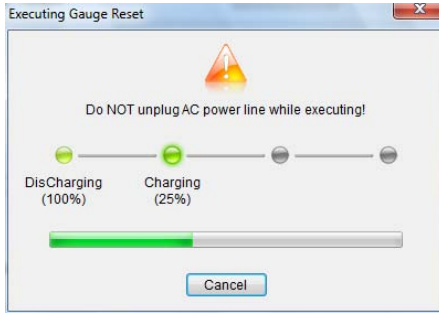

4. Wait till the process is completed. Click **Exit** when finished.

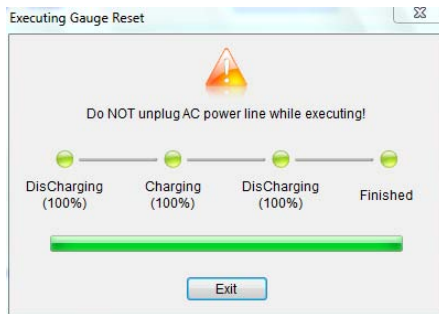

## ECO Tab

The **ECO** tab allows you to configure ECO modes (or called power profiles).

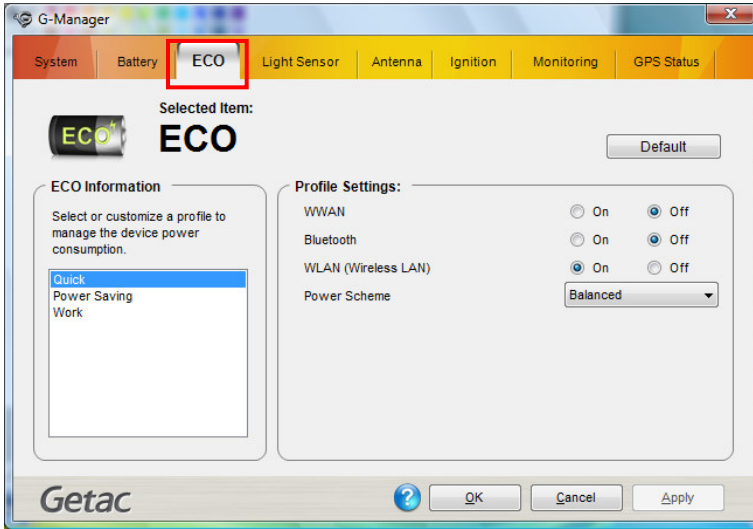

To put the system into an ECO mode, use the **ECO** button (one of the buttons in the OSD Control Panel). (See “Using the OSD Control Panel” earlier in this chapter for information.)

## ECO Information

The left portion of the screen lists the available power profiles (**Quick**, **Power Saving**, and **Work**). Each profile is a combination of power settings that results in different power consumptions. To change the settings of a profile, select (highlight) the profile name in the list.

## Profile Settings

The right portion of the screen displays the settings of the current selected profile. You can set up the following items:

- **WWAN**, **Bluetooth**, **Touchscreen**, and **WLAN** – can be on or off.

- **Power Scheme** – can be **Balanced**, **High Performance** or **Power Saver**. The settings here correspond to the settings in Windows. (See Windows Help for the description to each of the power scheme.)

After changing the settings, click **Apply** or **OK** to save the changes. To restore the settings to the default values, click **Default**.

## Light Sensor Tab

The **Light Sensor** tab allows you configure how the light sensor works.



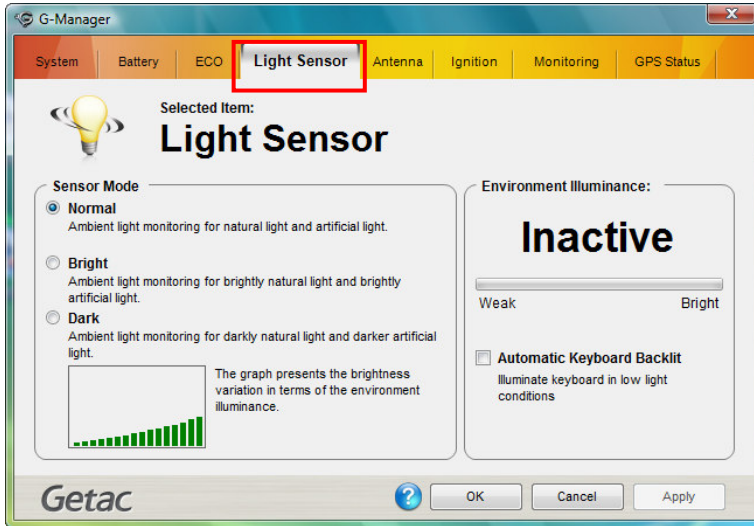

## Sensor Mode

The left portion of the screen lists the sensor modes:

- **Normal** – Light sensor sensitivity is set at normal environment lighting condition.
- **Bright** – Light sensor sensitivity is set at bright environment lighting condition (e.g. outdoors).
- **Dark** – Light sensor sensitivity is set at dark environment lighting condition (e.g. indoors, storage warehouse, etc.).

Click to select a mode. Click **Apply** or **OK** to save the changes.

## Environment Illuminance

To have the keypad backlight automatically turn on in poor lighting environment, click the checkbox **Automatic Keyboard Backlit**. Click **Apply** or **OK** to save the changes.

# Ignition Tab

The **Ignition** tab allows you to configure how your system works with the vehicle ignition.

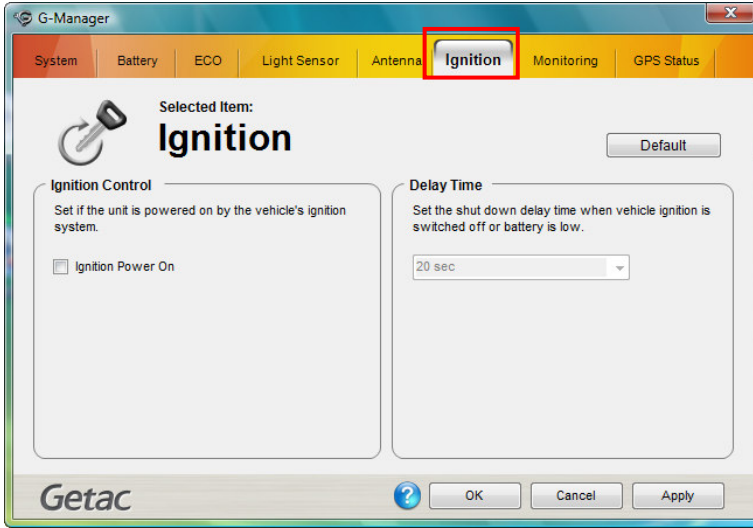

## Ignition Control

When your system is connected to the Vehicle Dock (available as an option), you can have your system derive power from the vehicle and have the on/off of the vehicle ignition turn on/off your system. To enable the feature, select the checkbox **Ignition Power On**. Click **Apply** or **OK** to save the changes.

## Delay Time

When the **Ignition Power On** feature is enabled, the system will automatically shut down after the vehicle ignition is turned off or the battery is low. You can set the amount of time (20 seconds, 30 seconds, 45 seconds, 1 minute, or 2 minute) the system waits before shutting down. Click **Apply** or **OK** to save the changes.

# Monitoring Tab

The **Monitoring** tab allows you to configure the monitoring function of G-Manager.

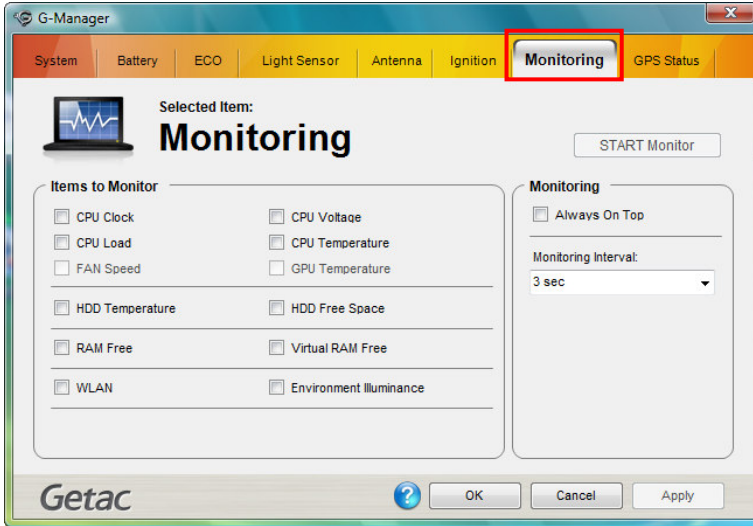

## Items to Monitor

The left portion of the screen lists the items. Click the checkbox before an item to include it as a monitored component. Click **Apply** or **OK** to save the changes.

**NOTE:** Different models have different supported monitoring items; non-supported items cannot be selected (grayed out items).

## Monitoring Options

The right portion of the screen allows you to set how the monitored items are displayed and how often the monitoring is updated.

- **Always On Top** – allows the monitoring window to remain on top of your display.

- **Monitoring Interval** – sets the frequency of updates on the monitoring window (1/3/5/10/30 seconds or 1/5/30 minutes).

Click **Apply** or **OK** to save the changes.

## Starting and Stopping the Monitoring

To start monitoring, click **START Monitor**. The monitoring window similar to the one below appears displaying requested information at specified intervals.

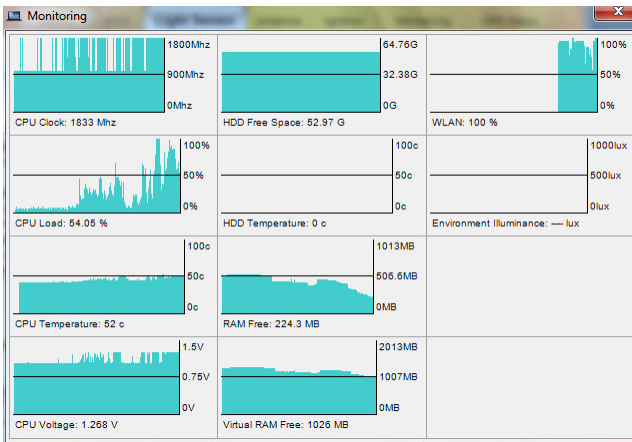

To stop monitoring, click the Close button at the upper right corner of the monitoring window or click **Stop Monitor** on the **Monitoring** tab page of G-Manager.

## GPS Status Tab

The **GPS Status** tab shows the GPS status for models having the GPS module.

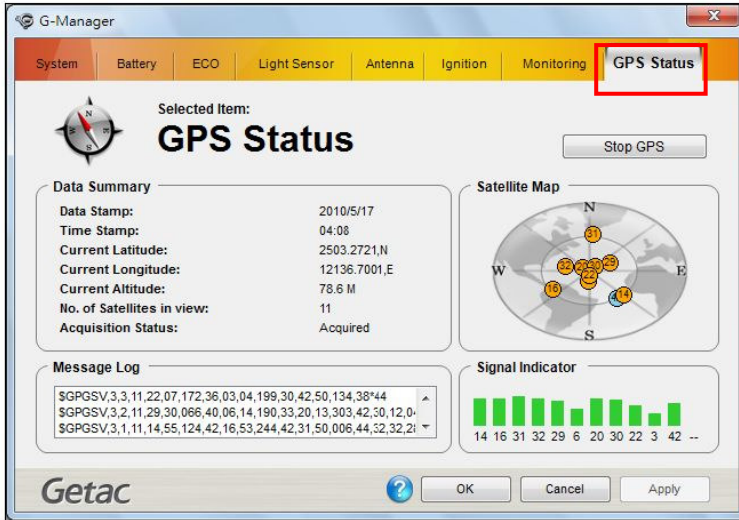

To start GPS positioning, click **Start GPS**. The screen displays:

- Ongoing raw data strings in the **Message Log** section
- Overhead satellite positions in the **Satellite Map** section
- Signal strength of the satellites in the **Signal Indicator** section

When GPS positioning is completed, the **Data Summary** section shows the GPS information of the current location.

To stop GPS positioning, click **Stop GPS**.

# Using Getac Camera

Getac Camera is a geo-tagging camera program, which allows you to stamp geographical information on photos as watermarks and embed such information into JPEG files as EXIF 2.2 metadata.















## NOTE:





- Getac Camera works with Virtual-GPS (a separate application program). Make sure that Virtual-GPS is installed in your computer.
- Before starting Getac Camera, close any other program that uses the camera; otherwise, Getac Camera can only provide limited functions.
- The instructions in this document are based on touchscreen operations though there are equivalent touchpad and mouse operations.

To start the program, tap the Getac Camera program icon on Windows desktop. The Getac Camera window appears as shown below.

The GPS positioning will be automatically activated. When the GPS positioning is completed, you will see the geographical information in the watermark area on the image.



No.	Screen Elements	Descriptions	
①	<b>Preview/Display Window</b>	Displays the live image in Camera mode and the selected image in View mode.	
②	<b>Status Display</b>		Indicates the use of a feature.
			GPS Lock in use
		 / 	Front/Bottom camera in use (depending on your model)
			Night mode in use
		 / 	Continuous/Timer mode in use
③	<b>GPS Status</b>	Indicates if the GPS positioning is completed (  ) or not (  ).	
④	<b>Window Control Buttons</b>		Minimizes the program window.
			Closes the program.
⑤	<b>Control Buttons</b>	Perform immediate tasks on the current image.	
⑥	<b>Watermark</b>	Displays the GPS information such as direction, longitude, latitude, GPS status, date, and time.	
⑦	<b>Thumbnail Tray</b>	<p>Displays up to 7 pictures in a thumbnail view. The middle is the picture last taken or selected.</p> <p>You can drag toward the right or left to scroll through the thumbnail view.</p> <p>The  /  button hides/shows the Thumbnail Tray.</p>	
⑧	<b>Command Buttons</b>		Switches to Camera Mode.
			Switches to Camcorder mode.

		 <b>View</b>	Switches to View Mode.
		 <b>GPS</b>	Switches to GPS view.
		 <b>Settings</b>	Switches to the Settings screen.
<b>No.</b>	<b>Screen Elements</b>	<b>Descriptions</b>	
		 <b>About</b>	Provides copyright, licensing, and help information.

## Taking Pictures

1. Start the Getac Camera program. You will be in Camera Mode.
2. You can use the buttons on the right and left side of the preview window for immediate controls. (See “Camera Controls Buttons” for detailed information.)

For overall settings, tap  **Settings**. (See “Camera Settings” for detailed information.)

3. Aim the camera lens at your subject.







4. When ready, you can shoot the picture in either of the two methods:

- **Method 1:** Tap the  button.
- **Method 2:** Drag the preview image and drop it into Thumbnail Tray.



5. The picture will appear in the middle of the Thumbnail View and be saved to the predefined storage location.

## Camera Controls Buttons

Control Buttons	Descriptions
	<p>Flips the image vertically.</p>
	<p>Flips the image horizontally.</p>
	<p>Turns on/off GPS lock. The icon in the button shows the current status.</p> <p>GPS lock allows you record the exact location of the object you are shooting instead of where you are using the computer to shoot the picture. First, put the computer near your object and tap this button to lock the GPS information; then, you can go farther away to where you can have a good view of the object for the shooting.</p> <p>Remember to turn off GPS lock when the feature is not needed for the next picture. The GPS lock is always off whenever you start the program.</p>



Turns off/on watermark. The icon in the button shows the current status.

You can turn off watermark if you do not want the watermark to show in the picture. Your setting remains effective until you change it again.

## Shooting Videos

1. Start the Getac Camera program. You will be in Camera mode. Tap



to switch to Camcorder mode.

2. You can use the buttons on the right and left side of the preview window for immediate controls. (See “Camcorder Control Buttons” for detailed information.)

For overall settings, tap . (See “Camera Settings” for detailed information.)



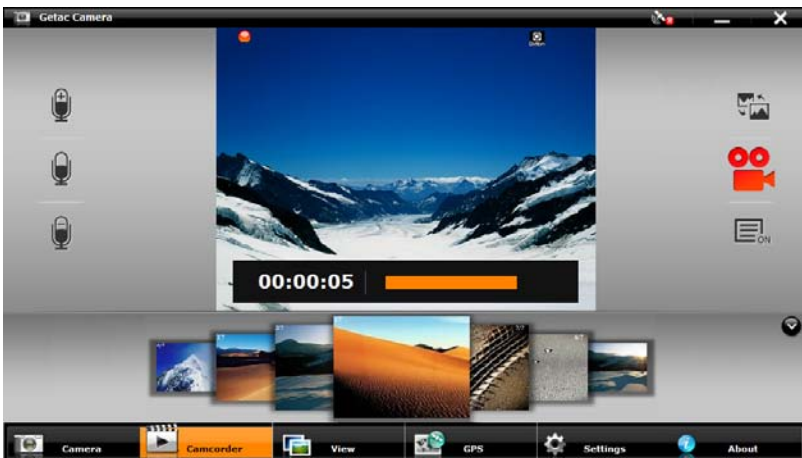

3. Aim the camera lens at your subject.

To start shooting the video, tap the  button.



4. To stop, tap the same button again.
5. An image from the video will appear in the middle of the Thumbnail Tray. The file is saved to the predefined storage location.

## Camcorder Control Buttons

Control Buttons	Descriptions
	Increases the recording sound volume.
	Disables/enables the microphone.
	Decreases the recording sound volume.
	Flips the image vertically.
	Turns on/off the display of elapsed recording time and current volume.

## Using View Mode

Tap  at the bottom of the screen to switch to View mode.

While in Camera or Camcorder mode, you can also switch to View mode by either of the two methods:

- **Method 1:** Double-tap the thumbnail in the Thumbnail Tray.
- **Method 2:** Drag the thumbnail and drop into the preview window.

# Selecting an Image or Video

To scroll through the Thumbnail Tray, drag the tray toward the left or right.



To select an image or video, use either of the two methods:







- **Method 1:** Double-tap the thumbnail in the Thumbnail Tray.
- **Method 2:** Drag the thumbnail and drop into the display window.





# Image Viewing Controls



When you select an image to view, you can perform the following tasks.

To	Via Control Buttons	Via Multi-touch Operations
Zoom in/out (up to four scales)		 <p data-bbox="639 496 944 560">Drag two fingers apart/ towards to zoom in/out.</p>
	<p data-bbox="356 635 1029 699">When zoomed in, you can drag to view another portion of the image.</p>	
Restore to the 100% scale		<p data-bbox="639 730 650 746">—</p>
Rotate to the right/left by 90°		 <p data-bbox="639 1027 944 1131">Drag two fingers in a clockwise/counterclockwise circular motion.</p>
View image properties		<p data-bbox="639 1166 650 1182">—</p>

## Adding Notes to an Image

1. Switch to View mode, select the image, and tap .
2. In properties view, tap .

3. Type your notes in the entry field.
4. When completed, tap  .

The first three lines of the notes show on the screen.

## Video Playback Controls



When you select a video to playback, you can perform the following tasks.

To	Via Control Buttons
Start/pause the playback	 / 
Skip backwards/forwards	 / 
Increase/decrease volume	 / 

---

Turn on/off the status display















## Camera Settings

To change camera settings, tap  at the bottom of the screen.











Along the left of the window are all the setting items. You can drag this area up or down to scroll through the items. The middle of the window displays the current item and setting value. To the right is the adjustment bar where you can tap or drag to change the setting value.

All changes (except for **Camera Mode**) remain effective until you change them again.

Items	Name	Descriptions
	<b>White Balance</b>	Five choices from which you can select one that matches the current light source: <b>Automatic</b> (default), <b>Sunshine</b> , <b>Cloudy</b> , <b>Fluorescence</b> , and <b>Incandescence</b> .
	<b>Brightness</b>	Adjusts the brightness level. The range of levels depends on computer models. You can tap  to restore to the default level.
Items	Name	Descriptions
	<b>Contrast</b>	Adjusts the contrast level. The range of levels depends on computer models. You can tap  to restore to the default level.
	<b>Hue</b>	Adjusts the hue level. The range of levels depends on computer models. You can tap  to restore to the default level.
	<b>Flicker</b>	Sets the frequency to match the local electrical system for flicker free shooting under electric light. Choices are: <b>60Hz</b> (default) and <b>50Hz</b> .
	<b>LED Light</b>	Turns <b>On</b> (default) or <b>Off</b> the LED light. This item is available for setting only on models with the LED light.
	<b>Night Mode</b>	Turns <b>On</b> or <b>Off</b> (default) night mode. You can turn on the feature for shooting in low light situations.
	<b>Image Size</b>	Sets the image resolution. <b>1600 x 1200</b> , <b>1024 x 768</b> , <b>800 x 600</b> , or <b>640 x 480</b> for 2.0MP Camera.
	<b>Video Size</b>	Sets the video size to <b>640x480</b> or <b>320x240</b> .



	<b>Camera Mode</b>	Three choices for the shooting mode:	
		<b>Normal</b>	This is the default setting whenever the program is started.
		<b>Continuous</b>	Continuous shooting of 3 pictures (one shot per second).
		<b>Timer</b>	5-second countdown before shooting.
	<b>Status Display</b>	Turns <b>On</b> (default) or <b>Off</b> the display of the status indicators.	
<b>Items</b>	<b>Name</b>	<b>Descriptions</b>	
	<b>Watermark</b>	Turns <b>On</b> (default) or <b>Off</b> the display of watermark in the image. (Turning off does not affect the embedded EXIF 2.2 metadata.)	
	<b>Shutter Sound</b>	Turns <b>On</b> (default) or <b>Off</b> the sound played upon photo shooting.	
	<b>Power Saving</b>	Sets if power saving works for the program.	
		<b>System</b> (default)	The Camera program enters power saving mode according to the settings of Windows' Power Options.
		<b>Never</b>	The Camera program will not enter power saving mode while the program window is open. But when the program window is minimized, the <b>System</b> setting overrides.
	<b>Camera Switch</b>	Switches to the <b>Front</b> (default) or <b>Bottom</b> camera lens. The latter is available for selection only on computer models with two cameras.	
	<b>Folder Path</b>	Sets the storage location of the images. To change to a different folder, tap <b>Browse</b> and select the folder.	

		<p>The default location is <b>Users\user name\Pictures</b> folder that contains the original images. A subfolder named <b>Thumbs</b> contains a copy of the same images (with filename prefix <b>Thumb_</b>) for the thumbnail view.</p> <p><b>NOTE:</b> If you are adding or deleting images using File Explorer, make sure to work on both the correct folder and its <b>Thumbs</b> subfolder.</p>	
Items	Name	Descriptions	
	<b>Time Option</b>	<p>Displays the time throughout the program according to one of the two choices:</p>	
		<p><b>System time zone</b> (default)</p>	<p>The time zone setting of the computer is taken into consideration. If the current location is in daylight saving time, the time will be adjusted accordingly.</p>
		<p><b>UTC</b></p>	<p>The time is based on Coordinated Universal Time.</p>
	<b>Filename Prefix</b>	<p>The default filename prefix is <b>IMG</b>. The complete filename is <b>IMG_XXXXXX.jpg</b> (where <b>XXXXXX</b> = sequential number). When the sequential number has reached 999999 and you are taking the next picture, a message will pop up to ask you to change the prefix.</p> <p>You can change the prefix by typing the characters (limited to <b>A~Z</b>, <b>a~z</b>, <b>0~9</b>, <b>-</b> and <b>_</b>) in the entry field. Maximum number of characters allowed is 10.</p>	

# Chapter 7

# Caring for the Computer

Taking good care of your computer will ensure a trouble-free operation and reduce the risk of damage to your computer.

This chapter gives you guidelines covering areas such as protecting, storing, cleaning, and traveling.

# Protecting the Computer

To safeguard the integrity of your computer data as well as the computer itself, you can protect the computer in several ways as described in this section.

## Using an Anti-Virus Strategy

You can install a virus-detecting program to monitor potential viruses that could damage your files.

## Using Action Center (for Windows 7)

Action Center alerts you to take action on the following security essentials:

- Windows Firewall
- Windows Update
- Malware Protection (anti-virus, anti-spyware)
- Others (Internet security, user account control)

For detailed information, see Windows' Help.

# Using the Cable Lock

You can use a Kensington-type cable lock to protect your computer against theft. The cable lock is available in most computer stores.

To use the lock, loop the lock cable around a stationary object such as a table. Insert the lock to the Kensington lock hole and turn the key to secure the lock. Store the key in a safe place.

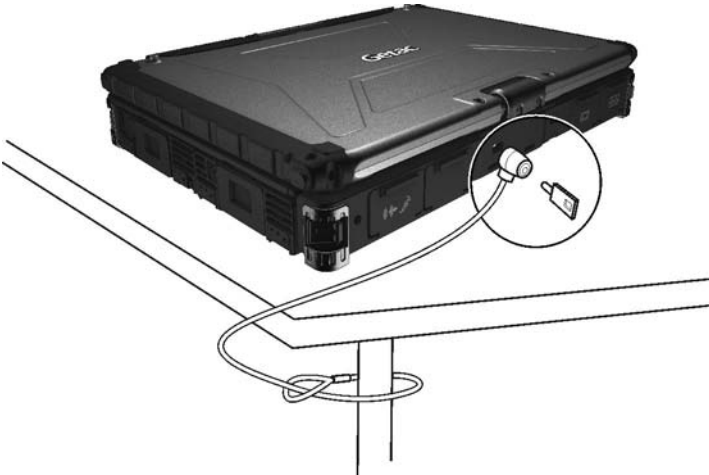

# Taking Care of the Computer

## Location Guidelines

- For optimal performance, use the computer where the recommended temperature is between 0°C (32°F) and 55°C (131°F) – actual operating temperature depending on product specifications.
- Avoid placing the computer in a location subject to high humidity, extreme temperatures, mechanical vibration, direct sunlight, or heavy dust. Using the computer in extreme environments for long periods can result in product deterioration and a shortened product life.
- Operating in an environment with metallic dust is not allowed.
- Place the computer on a flat and steady surface. Do not stand the computer on its side or store it in an upside-down position. A strong impact by dropping or hitting may damage the computer.
- Do not cover or block any ventilation openings on the computer. For example, do not place the computer on a bed, sofa, rug, or other similar surface. Otherwise, overheating may occur that results in damage to the computer.
- As the computer can become very hot during operation, keep it away from objects that are vulnerable to heat.
- Keep the computer at least 13 cm (5 inches) away from electrical appliances that can generate a strong magnetic field such as a TV, refrigerator, motor, or a large audio speaker.
- Avoid moving the computer abruptly from a cold to a warm place. A temperature difference of more than 10°C (18°F) may cause condensation inside the unit, which may damage the storage media.

# General Guidelines

- Do not place heavy objects on top of the computer when it is closed as this may damage the display.
- The screen surface is easily scratched. Avoid touching it with a sharp object such as a pen or pencil.
- To maximize the life of the backlight in the display, allow the backlight to automatically turn off as a result of power management. Avoid using a screen saver or other software that prevents the power management from working.

# Cleaning Guidelines

- Never clean the computer with its power on.
- Use a soft cloth moistened with water or a non-alkaline detergent to wipe the exterior of the computer.
- Gently wipe the display with a soft, lint-free cloth. Do not use alcohol or detergent on the display.
- Dust or grease on the touchpad can affect its sensitivity. Clean the pad by using adhesive tape to remove the dust and grease on its surface.
- If water or liquid is split onto the computer, wipe it dry and clean when possible. Though your computer is water-proof, do not leave the computer wet when you can dry it.
- If the computer gets wet where the temperature is 0 °C (32 °F) or below, freeze damage may occur. Make sure to dry the wet computer.

# Battery Pack Guidelines

- Recharge the battery pack when it is nearly discharged. When recharging, make sure that the battery pack is fully charged. Doing so may avoid harm to the battery pack.
- The battery pack is a consumable product and the following conditions will shorten its life:
  - when frequently charging the battery pack
  - when using, charging, or storing the battery in high temperature condition
- To avoid hastening the deterioration of the battery pack thereby prolonging its useful life, minimize the number of times you charge it so as not to frequently increase its internal temperature.
- Charge the battery pack between 10°C ~ 30°C (50°F ~ 86°F) temperature range.

A higher environment temperature will cause the battery pack's temperature to rise. Avoid charging the battery pack inside a closed vehicle and in hot weather condition.

Also, charging will not start if the battery pack is not within the allowed temperature range.
- It is recommended that you do not charge the battery pack more than once a day.
- It is recommended that you charge the battery pack with the computer's power off.
- To maintain the battery pack's operating efficiency, store it in a cool dark place removed from the computer and with 30% ~ 40% charge remaining.
- Important guidelines when using the battery pack.

When installing or removing the battery pack take note of the following:



- avoid installing or removing the battery pack when the computer is in Sleep mode. Abruptly removing the battery pack may cause loss of data or the computer may become unstable.
- avoid touching the battery pack terminals or damage may occur, thereby causing improper operation to it or the computer.

The computer's input voltage and surrounding temperature will directly affect the battery pack's charge and discharge time:

- charging time will be prolonged when the computer is turned on. To shorten the charging time, it is recommended that you place the computer in sleep or hibernation mode.
  - a low temperature will prolong the charging time as well as hasten the discharge time.
- When using battery power in an extremely low temperature environment, you may experience shortened operating time and incorrect battery level reading. This phenomenon comes from the chemical characteristics of batteries. The appropriate operating temperature for the battery is  $-10\text{ }^{\circ}\text{C} \sim 50\text{ }^{\circ}\text{C}$  ( $14\text{ }^{\circ}\text{F} \sim 122\text{ }^{\circ}\text{F}$ ).

## Touchscreen Guidelines

- Use the finger or the included touchscreen pen on the display. Using a sharp or metallic object other than your finger or touchscreen pen may cause scratches and damage the display, thereby causing errors.
- Avoid using excessive force that may cause damage to the display.
- Use a soft cloth to remove dirt on the display. The touchscreen surface has a special protective coating that prevents dirt from sticking to it. Not using a soft cloth may cause damage to the special protective coating on the touchscreen surface.
- Turn off the computer power when cleaning the display. Cleaning the display with the power on may cause improper operation.

- Do not use excessive force on the display. Avoid moving the computer while holding the display or twisting the display. Avoid placing objects on top of the display as this may cause the glass to break thereby damaging the display.
- Using the touchscreen during low temperature (less than 5°C) may cause a slower response time, this is normal. A normal response time may be restored upon returning to room temperature.
- When there is a noticeable discrepancy in the placement of the stylus on the screen and the indicated position of the onscreen pointer, use the calibration utility to recalibrate the touchscreen display.

# When Traveling

- Before traveling with your computer, make a backup of your hard disk data into flash disks or other storage devices. As an added precaution, bring along an extra copy of your important data.
- Make sure that the battery pack is fully charged.
- Make sure that the computer is turned off and the top cover is securely closed.
- Do not leave objects in between the keyboard and closed display.
- Disconnect the AC adapter from the computer and take it with you. Use the AC adapter as the power source and as a battery-charger.
- Hand-carry the computer. Do not check it in as luggage.
- If you need to leave the computer in the car, put it in the trunk of the car to avoid exposing the computer to excessive heat.
- When going through airport security, it is recommended that you send the computer and flash disks through the X-ray machine (the device you set your bags on). Avoid the magnetic detector (the device you walk through) or the magnetic wand (the handheld device used by security personnel).
- If you plan to travel abroad with your computer, consult your dealer for the appropriate AC power cord for use in your country of destination.



# Chapter 8

# Troubleshooting

Computer problems can be caused by hardware, software, or both. When you encounter any problem, it might be a typical problem that can easily be solved.

This chapter tells you what actions to take when solving common computer problems.

# Preliminary Checklist

Here are helpful hints to follow before you take further actions when you encounter any problem:

- Try to isolate which part of the computer is causing the problem.
- Make sure that you turn on all peripheral devices before turning on the computer.
- If an external device has a problem, make sure that the cable connections are correct and secure.
- Make sure that the configuration information is properly set in the BIOS Setup program.
- Make sure that all the device drivers are correctly installed.
- Make notes of your observations. Are there any messages on the screen? Do any indicators light? Do you hear any beeps? Detailed descriptions are useful to the service personnel when you need to consult one for assistance.

If any problem persists after you follow the instructions in this chapter, contact an authorized dealer for help.

# Solving Common Problems

## Battery Problems

### **The battery does not charge (Battery Charge indicator does not light yellow).**

- Make sure that the AC adapter is properly connected.
- Make sure that the battery is not too hot or cold. Allow time for the battery pack to return to room temperature.
- Make sure that the battery pack is installed correctly.
- Make sure that the battery terminals are clean.

### **The operating time of a fully charged battery becomes shorter.**

- If you often partially recharge and discharge, the battery might not be charged to its full potential. Initialize the battery to solve the problem.

### **The battery operating time indicated by the battery meter does not match the actual operating time.**

- The actual operating time can be different from the estimated time, depending on how you are using the computer. If the actual operating time is much less than the estimated time, initialize the battery.

## Bluetooth Problems

### **I cannot connect to another Bluetooth-enabled device.**

- Make sure that both devices have activated Bluetooth.
- Make sure that the distance between the two devices is within the limit and that there are no walls or other obstructions between the devices.
- Make sure that the other device is not in “Hidden” mode.
- Make sure that both devices are compatible.

# Display Problems

## **Nothing appears on the screen.**

- During operation, the screen may automatically turn off as a result of power management. Press any key to see if the screen comes back.
- The brightness level might be too low. Increase brightness.
- The display output might be set to an external device. To switch the display back to the LCD, press the **Fn+F5** hot key or change the display through the settings in **Display** Properties.

## **The characters on the screen are dim.**

- Adjust the brightness and/or contrast.

## **The display brightness cannot be increased.**

- As a protection, the display brightness will be fixed at a low level when the surrounding temperature is too high or too low. It is not a malfunction in this situation.

## **Bad dots appear on the display at all times.**

- A small number of missing, discolored, or bright dots on the screen are an intrinsic characteristic of TFT LCD technology. It is not regarded as a LCD defect.

## **Resolution cannot be adjusted to desired setting.**

- Make sure that the VGA driver is installed correctly.

## **The external monitor displays nothing.**

- Make sure that the monitor is turned on.
- Make sure that the monitor's signal cable is properly connected.
- Switch the display to the monitor by pressing the **Fn+F5** hot key or change the display through the settings in **Display** Properties.



### **Simultaneous display/multi-display does not work.**

- Make sure that you turn on the external monitor before turning on the computer.
- Press the **Fn+F5** hot key to toggle through the display options or change the settings in **Display** Properties in Windows.

## **Hardware Device Problems**

### **The computer does not recognize a newly installed device.**

- The device may not be correctly configured in the BIOS Setup program. Run the BIOS Setup program to identify the new type.
- Make sure if any device driver needs to be installed. (Refer to the documentation that came with the device.)
- Make sure if the device needs any jumper or switch settings. (Refer to the documentation that came with the device.)
- Check the cables or power cords for correct connections.
- For an external device that has its own power switch, make sure that the power is turned on.

## **Hard Disk Drive Problems**

### **The hard disk drive error message appears on the screen.**

- The hard disk drive has defects. Ask your dealer for help.

### **The hard disk drive operations seem slow.**

- The data files stored on the hard disk drive may be fragmented. Use a tool such as Window's **Disk Defragmenter** to defragment the files.

### **The hard disk drive in-use indicator glows without blinking.**

- The data files stored on the hard disk drive may be fragmented. Use a tool such as Window's **Disk Defragmenter** to defragment the files.

# Keyboard, Mouse, and Touchpad Problems

## The keyboard does not respond.

- Try connecting an external keyboard. If it works, contact an authorized dealer, as the internal keyboard cable might be loose.

## Water or liquid is spilt into the keyboard.

- Immediately turn off the computer and unplug the AC adapter. Then turn the keyboard upside down to drain the liquid out of the keyboard. Make sure to clean up any part of the spill you can get to. Though the keyboard of your computer is spill-proof, liquid will remain in the keyboard enclosure if you don't remove it. Wait for the keyboard to air dry before using the computer again.

## The numeric keypad is disabled.

- Make sure that the **Num Lock** is switched on. (Check if the Num Lock Indicator glows or not.)

## The touchpad does not work, or the pointer is difficult to control with the touchpad.

- Make sure that the touchpad is clean.

# LAN Problems

## I cannot access the network.

- Make sure that the LAN driver is correctly installed.
- Make sure that the LAN cable is properly connected to the RJ-45 connector and the network hub.
- Make sure that the network configuration is appropriate.
- Make sure that the user name or password is correct.

# Modem Problems

## **The modem does not work.**

- Make sure that the modem driver is correctly installed.
- Make sure that the telephone line is properly connected.
- Make sure that the COM port in the communication software is correctly set.
- Turn off power management.

# Power Management Problems

## **The computer does not enter Sleep or Hibernation mode automatically.**

- If you have a connection to another computer, the computer does not enter Sleep or Hibernation mode if the connection is actively in use.
- Make sure that the Sleep or Hibernation time-out is enabled.

## **The computer does not enter Sleep or Hibernation mode immediately.**

- If the computer is performing an operation, it normally waits for the operation to finish.

## **The computer does not resume from Sleep or Hibernation mode.**

- The computer automatically enters Sleep or Hibernation mode when the battery pack is empty. Do any one of the following:
  - Connect the AC adapter to the computer.
  - Replace the empty battery pack with a fully charged one.

## **The computer does not enter Hibernation mode with the Fn+F12 hot keys.**

- Make sure that the Hibernation function is specified for the sleep button.
- You might be using a PC card that prevents the computer from entering Hibernation mode. To enter the mode, stop the communication program and then remove the card or stop the card.

# Software Problems

## **An application program does not work correctly.**

- Make sure that the software is correctly installed.
- If an error message appears on the screen, consult the software program's documentation for further information.
- If you are sure the operation has stop, reset the computer. (See "Resetting the Computer" later in this chapter.)

# Sound Problems

## **No sound is produced.**

- Make sure that the volume control is not set too low.
- Make sure that the audio driver is correctly installed.
- Make sure that the computer is not in Sleep mode.
- If using an external speaker, make sure that the speaker is properly connected.

## **Distorted sound is produced.**

- Make sure that the volume control is not set too high or too low. In most cases, a high setting can cause the audio electronics to distort the sound.

## **The sound system does not record.**

- Adjust the playback or recording sound levels.

## **The external microphone or audio device does not work.**

- Make sure that the microphone is connected to the proper connector on the computer.
- Make sure that your computer is equipped with the driver needed.
- Click the speaker symbol on the taskbar and check the Windows volume control.

- Check the volume control of your computer.

## Startup Problems

### **When you turn on the computer, it does not seem to respond.**

- Make sure that either the AC adapter is connected or the battery has power.
- **For models with the HDD heater option:** When turning on the computer in an extremely low temperature environment, the computer will heat up the hard disk before starting up. The hard disk drive in-use indicator blinks red to indicate the heater is on. (In conditions where the AC adapter is connected and the temperature is above an acceptable range, the computer will display messages on the screen informing you of the heating process; in other conditions, the screen is simply blank.) Wait till the heating is finished. However, if external AC power is not available and the remaining battery power is too low for the heating to complete, the computer may not start up. In case the computer fails to start up, turn off the computer and leave it in room temperature for about an hour before trying to turn it on again.

### **When you turn on the computer, it stops after POST.**

- Restart your computer.

## WLAN Problems

### **I cannot use the WLAN feature.**

- Make sure that the mini PCI-E WLAN card is correctly installed.
- Make sure that the necessary driver(s) is correctly installed.
- Make sure that the WLAN feature is turned on.

### **Transmission quality is poor.**

- Your computer may be in an out-of-range situation. Move your computer closer to the Access Point or another WLAN device it is associated with.

- Check if there is high interference around the environment and solve the problem as described next.

### **Radio interference exists.**

- Move your computer away from the device causing the radio interference such as microwave oven and large metal objects.
- Plug your computer into an outlet on a different branch circuit from that used by the affecting device.
- Consult your dealer or an experienced radio technician for help.

### **I cannot connect to another WLAN device.**

- Make sure that the WLAN feature is turned on.
- Make sure that the SSID setting is the same for every WLAN device in the network.
- Your computer is not recognizing changes. Restart the computer.
- Make sure that the IP address or subnet mask setting is correct.

### **I cannot communicate with the computer in the network when Infrastructure mode is configured.**

- Make sure that the Access Point your computer is associated with is powered on and all the LEDs are working properly.
- If the operating radio channel is in poor quality, change the Access Point and all the wireless station(s) within the BSSID to another radio channel.
- Your computer may be in an out-of-range situation. Move your computer closer to the Access Point it is associated with.
- Make sure that your computer is configured with the same security option (encryption) to the Access Point.
- Use the Web Manager/Telnet of the Access Point to check whether it is connected to the network.

- Reconfigure and reset the Access Point.

### **I cannot access the network.**

- Make sure that the necessary driver(s) is correctly installed.
- Make sure that the network configuration is appropriate.
- Make sure that the user name or password is correct.
- You have moved out of range of the network.
- Turn off power management.

## **Other Problems**

### **The date/time is incorrect.**

- Correct the date and time via the operating system or BIOS Setup program.
- After you have performed everything as described above and still have the incorrect date and time every time you turn on the computer, the RTC (Real-Time Clock) battery is at the end of its life. Call an authorized dealer to replace the RTC battery.

# Resetting the Computer

You may have to reset (reboot) your computer on some occasions when an error occurs and the program you are using hangs up.

If the computer operation seems to hang up, first wait. It is possible that the computer is processing data. Periodically check the hard disk drive in-use indicator, if it flashes irregularly, the program may be accessing data and preventing you from using the keyboard. If you are sure the operation has stopped and you cannot use the “restart” function of the operating system, reset the computer.

Reset the computer by any one of these methods:

- Press **Ctrl+Alt+Del** on your built-in keyboard.
- Press the Reset button  on the front panel of your computer.
- If the above action does not work, press and hold the power button for more than 5 seconds to force the system to turn off. Then turn on the power again.

**CAUTION:** Resetting will cause any unsaved data to be lost.



# Appendix A

# Specifications

**NOTE:** Specifications are subject to change without any prior notice.

Parts		Specifications
CPU		Intel® Ivy Bridge i5-3320M, 2.6G, 35W
Chipset		Intel® Panther Point QM77
Memory		Up to 8 GB, 240-pin × 2, DDRIII 1333MHz SO-DIMM
BIOS		8 MB EEPROM, system and VGA BIOS, Plug-and-Play, ACPI 2.0 capability
Display	Panel	12.1-inch TFT LCD, resolution up to 1280×800 WXGA, Touchscreen function and/or Digitizer feature (option) , Sunlight-readable with 1200 nits brightness after touchscreen, Ultra low brightness (option)
	Video controller	Integrated in Intel® Ivy Bridge
Audio	Features	Azalia interface, left/right-channel analog output for line-out connector
	Speaker	One built-in
Keyboard		Standard keys with numeric pad keys, 12 function keys, special Fn (Function) key and Windows keys Water-proof and dust-proof membrane, large character printing, water-proof rubber (option), membrane backlight (option)
Pointing device		Glide touchpad with 2 buttons, capacitance-type Resistive (Glove) touchpad (option)
Hard disk drive		SATA 3 interface, 320GB, HDD heater for -20 °C low temperature (option), 128GB solid state disk (option)
PC Card /ExpressCard/Smart card support		Standard: ExpressCard/54 + PC card Option: Smart card + ExpressCard/54

Parts		Specifications
Memory card reader		SD/SDHC/SDXC
I/O ports		USB 3.0 x 2, USB 2.0, Mini 1394a, serial (RS-232), RJ-45, RJ-11, headphone out, microphone, VGA, docking (100-pin)
Antenna	Wi-Fi 802.11a/b/g/n + Bluetooth 2.4G	2 internal (pass-through for external antenna – option)
	WCDMA/HSDPA	2 internal (pass-through for external antenna – option)
	GPS 1.5G (option)	1 internal
Modem		Azalia interface, 56 Kbps, ITU V.90 MDC 1.5 internal fax modem
LAN		IEEE 802.3i 10Base-T, IEEE 802.3u 100Base-T, IEEE 802.3ab 1000Base-T Ethernet
Wireless LAN + Bluetooth		Intel® Centrino Advanced-N 6235, 802.11 a/b/g/n WLAN booster (option) Bluetooth 4.0 class 1 + EDR
Camera		2M pixel (EDOF), 225-degree rotation
GPS (option)		EB-5318RF
WWAN (option)		WCDMA/HSDPA
Security		Kensington lock TPM 1.2 Fingerprint scanner (option)
Handle		Grip and cross-type hand strap
Power	AC adapter	Universal 90 W; input: 100~240 V, 50/60 Hz; output: 19 V
	Battery	Li-ion smart 9-cell battery 8700 mAh / 10.8 V Li-ion smart 6-cell battery 6140 mAh / 10.8V (option) user-swappable, under -20 °C combined with hard drive low temperature solution
Dimension (L×W×H)		314×227×49 mm (12.4×8.74×1.93 inch)
Weight		2.8 kg (5.95 lb)

Parts		Specifications
Environment	Temperature	Operating: 0 °C (32 °F) to 60 °C (140 °F) -20 °C (-4 °F) to 60 °C (140 °F) – low temperature option Non-operating: -51 °C (-60 °F) to 71 °C (160 °F)
	Humidity	5 % to 95 % relative, non-condensing
	Altitude	Operating: 15,000 ft Non-operating: 40,000 ft
	Shock	Operating: 40 g, 11 ms, sawtooth pulse
Environment	Vibration	Integrity: MIL-STD-810G, Method 514.6, E-1, Category 24, minimum integrity Vehicle: MIL-STD-810G, Method 514.6, C-1, Category 4, Secured Cargo MIL-STD-810G, Method 514.6, C-1, Category 20, Ground Vehicle
	Drop	100 cm drop 26 times onto plywood plate surface
	Enclosure	IP65 (with input/output doors closed)
	ESD	Air discharge: 0~8 KV (included) no error; 9~15 KV allow soft error Contact discharge: 0~6 KV (included) no error; 7~8 KV allow soft error
Regulation	EMC	FCC part 15, subpart B, class B, CE, CCC
	Safety	UL, TUV, TUV/CB, E-mark
Green Product Coverage	RoHS	6 European union banned materials, EPEAT
	Other	12 universal GP product banned materials, ENERGY STAR, WEEE



# Appendix B

## Regulatory Information

This appendix provides regulatory statements and safety notices on your computer.

**NOTE:** Marking labels located on the exterior of your computer indicate the regulations that your model complies with. Please check the marking labels and refer to the corresponding statements in this appendix. Some notices apply to specific models only.

# On the Use of the System

## Class B Regulations

### USA

#### **Federal Communications Commission Radio Frequency Interference Statement**

##### **NOTE:**

This equipment has been tested and found to comply with the limits for a Class B digital device pursuant to Part 15 of the FCC Rules. These limits are designed to provide reasonable protection against harmful interference in a residential installation. This equipment generates, uses, and can radiate radio frequency energy and, if not installed and used in accordance with the instructions, may cause harmful interference to radio communications. However, there is no guarantee that interference will not occur in a particular installation. If this equipment does cause harmful interference to radio or television reception, which can be determined by turning the equipment off and on, the user is encouraged to try to correct the interference by one or more of the following measures:

- Reorient or relocate the receiving antenna.
- Increase the separation between the equipment and receiver.
- Connect the equipment into an outlet on a circuit different from that to which the receiver is connected.
- Consult the dealer or an experienced radio/TV technician for help.

Any changes or modifications not expressly approved by the manufacturer could void the user's authority to operate the equipment.

##### **Please note:**

The use of a non-shielded interface cable with this equipment is prohibited.

# Canada

## Canadian Department of Communications Radio Interference Regulations Class B Compliance Notice

This Class B digital apparatus meets all requirements of the Canada Interference-Causing equipment regulations.

Cet appareil numérique de Classe B respecte toutes les exigences du Règlement Canadien sur le matériel brouilleur.

This digital apparatus does not exceed the Class B limits for radio noise emissions from digital apparatus set out in the Radio Interference Regulations of the Canadian Department of Communications.

Le présent appareil numérique n'émet pas de bruits radioélectriques dépassant les limites applicables aux appareils numériques de la classe B prescrites dans le Règlement sur le brouillage radioélectrique édicté par le ministère des Communications du Canada.

## UL1604 Installation Instructions

- This equipment is suitable for use in Class I, Division 2, Groups A, B, C and D OR non-hazardous locations only.
- WARNING – EXPLOSION HAZARD – Do not disconnect equipment unless power has been removed or the area is known to be non-hazardous.
- WARNING – EXPLOSION HAZARD – Substitution of components may impair suitability for Class I, Division 2.
- Non-LPS or TNV output connectors identify the type of circuit, intended cable type or relevant circuit characteristics.
- "IMPORTANT SAFETY INSTRUCTIONS – When using your telephone equipment, basic safety precautions should always be followed to reduce the risk of fire, electric shock and injury to persons, including the following:
  - Do not use this product near water for example, near a bathtub,

washbowl, kitchen sink or laundry tub, in a wet basement or near a swimming pool.

- Avoid using a telephone (other than a cordless type) during an electrical storm. There may be a remote risk of electric shock from lightning.
- Do not use the telephone to report a gas leak in the vicinity of the leak.
- Use only the power cord and batteries indicated in this manual. Do not dispose of batteries in a fire. They may explode. Check with local codes for possible special disposal instructions.

“SAVE THESE INSTRUCTIONS”

## **Safety Notices**

### **About the Battery**

#### **Caution Texts Concerning Lithium Batteries**

##### **DANISH**

ADVARSEL! Lithiumbatteri – Eksplosionsfare ved fejlagtig håndtering. Udskiftning må kun ske med batteri af samme fabrikat og type. Levér det brugte batteri tilbage til leverandøren.

##### **NORWEGIAN**

ADVARSEL: Eksplosjonsfare ved feilaktig skifte av batteri. Benytt samme batteritype eller en tilsvarende type anbefalt av apparatfabrikanten. Brukte batterier kasseres i henhold til fabrikantens instruksjoner.

##### **SWEDISH**

VARNING: Explosionsfara vid felaktigt batteribyte. Använd samma batterityp eller en ekvivalent typ som rekommenderas av apparattillverkaren. Kassera använt batteri enligt fabrikantens instruktion.

##### **FINNISH**

VAROITUS: Paristo voi räjähtää, jos se on virheellisesti asennettu. Vaihda paristo



ainoastaan valmistajan suosittelemaan tyyppiin. Hävitä käytetty paristo valmistajan ohjeiden mukaisesti.

### **ENGLISH**

CAUTION: Danger of explosion if battery is incorrectly replaced. Replace only with the same or equivalent type recommended by the equipment manufacturer. Discard used batteries according to manufacturer's instructions.

### **DEUTSCH**

VORSICHT: Explosionsgefahr bei unsachgemäßem Austausch der Batterie. Ersatz nur durch denselben oder einen vom Hersteller empfohlenen gleichwertigen Typ. Entsorgung gebrauchter Batterien nach Angaben des Herstellers.

### **FRENCH**

ATTENTION: Il y a danger d'explosion s'il y a un remplacement incorrect de la batterie. Remplacer uniquement avec une batterie du même type ou d'un type équivalent recommandé par le constructeur. Mettre au rebut les batteries usagées conformément aux instructions du fabricant.

### **Attention (for USA Users)**

The product that you have purchased contains a rechargeable battery. The battery is recyclable. At the end of its useful life, under various state and local laws, it may be illegal to dispose of this battery into the municipal waste stream. Check with your local solid waste officials for details in your area for recycling options or proper disposal.

## **About the AC Adapter**

- Use only the AC adapter supplied with your computer. Use of another type of AC adapter will result in malfunction and/or danger.
- Do not use the adapter in a high moisture environment. Never touch the adapter when your hands or feet are wet.
- Allow adequate ventilation around the adapter when using it to operate the device or charge the battery. Do not cover the AC adapter with paper or other objects

that will reduce cooling. Do not use the AC adapter while it is inside a carrying case.

- Connect the adapter to a proper power source. The voltage requirements are found on the product case and/or packaging.
- Do not use the adapter if the cord becomes damaged.
- Do not attempt to service the unit. There are no serviceable parts inside. Replace the unit if it is damaged or exposed to excess moisture.

## **About the Modem**

### **Caution**

- Never install telephone wiring during a lightning storm.
- Never install telephone jacks in wet locations unless the jack is specifically designed for wet locations.
- Never touch non-insulated telephone wires or terminals unless the telephone line has been disconnected at the network interface.
- Use caution when installing or modifying telephone lines.
- Avoid using the telephone function (other than a cordless type) during an electrical storm. There may be a remote risk of electric shock from lightning.
- Do not use the telephone function to report a gas leak in the vicinity of the leak.
- Do not use this product near water, for example near a bathtub, wash bowl, kitchen sink or laundry tub, in a wet basement or near a swimming pool.

### **Caution (for USA Users)**

To reduce the risk of fire, use only No.26 AWG or larger telecommunication line cord.

# On the Use of the RF Device

**NOTE:** The information in this section applies to models with the wireless LAN module.

## USA and Canada Safety Requirements and Notices

**IMPORTANT NOTE:** To comply with FCC RF exposure compliance requirements, the antenna used for this transmitter must be installed to provide a separation distance of at least 0 cm from all persons and must not be co-located or operating in conjunction with any other antenna or transmitter.

## Radio Frequency Interference Requirements and SAR

The FCC with its action in ET Docket 93-62 has adopted a safety standard for human exposure to Radio Frequency (RF) electromagnetic energy emitted by FCC certified equipment. The wireless LAN module meets the Human Exposure limits found in OET Bulletin 65, 2001, and ANSI/IEEE C95.1, 1992. Proper operation of this radio according to the instructions found in this manual will result in exposure substantially below the FCC's recommended limits. The following safety precautions should be observed:

- Do not touch or move antenna while the unit is transmitting or receiving.
- Do not hold any component containing the radio such that the antenna is very close or touching any exposed parts of the body, especially the face or eyes, while transmitting.
- Do not operate the radio or attempt to transmit data unless the antenna is connected; if not, the radio may be damaged.

### Use in specific environments:

- The use of wireless devices in hazardous locations is limited by the constraints posed by the safety directors of such environments.

- The use of wireless devices on airplanes is governed by the Federal Aviation Administration (FAA).
- The use of wireless devices in hospitals is restricted to the limits set forth by each hospital.

### **Use on Aircraft Caution**

**CAUTION:** Regulations of the FCC and FAA prohibit airborne operation of radio-frequency wireless devices because their signals could interfere with critical aircraft instruments.

## EMC Requirements

This device uses, generates and radiates radio frequency energy. The radio frequency energy produced by this device is well below the maximum exposure allowed by the Federal Communications Commission (FCC).

This device complies with the limits for a Class B digital device pursuant to Part 15 subpart C of the FCC Rules and Regulations. Operation is subject to the following two conditions:

- (1) This device may not cause harmful interference.
- (2) This device must accept any interference received, including interference that may cause undesired operation.

The FCC limits are designed to provide reasonable protection against harmful interference when the equipment is installed and used in accordance with the instruction manual and operated in a commercial environment. However, there is no guarantee that interference will not occur in a particular commercial installation, or if operated in a residential area.

If harmful interference with radio or television reception occurs when the device is turned on, the user must correct the situation at the user's own expense. The user is encouraged to try one or more of the following corrective measures:

- Reorient or relocate the receiving antenna.
- Increase the separation between the equipment and receiver.
- Connect the equipment into an outlet on a circuit different from that to which the receiver is connected.
- Consult the dealer or an experienced radio/TV technician for help.

**CAUTION:** The Part 15 radio device operates on a non-interference basis with other devices operating at this frequency. Any changes or modification to said product not expressly approved by the manufacturer could void the user's authority to operate this device.

## **Canada Radio Frequency Interference Requirements**

To prevent radio interference to the licensed service, this device is intended to be operated indoors and away from windows to provide maximum shielding. Equipment (or its transmit antenna) that is installed outdoors is subject to licensing.

Pour empêcher que cet appareil cause du brouillage au service faisant l'objet d'une licence, il doit être utilisé à l'intérieur et devrait être placé loin des fenêtres afin de fournir un écran de blindage maximal. Si le matériel (ou son antenne d'émission) est installé à l'extérieur, il doit faire l'objet d'une licence.

## **European Union CE Marking and Compliance Notices**

### **Statements of Compliance**

#### **English**

This product follows the provisions of the European Directive 1999/5/EC.

#### **Danish**

Dette produkt er i overensstemmelse med det europæiske direktiv 1999/5/EC.

#### **Dutch**

Dit product is in navolging van de bepalingen van Europees Directief 1999/5/EC.

#### **Finnish**

Tämä tuote noudattaa EU-direktiivin 1999/5/EC määräyksiä.

#### **French**

Ce produit est conforme aux exigences de la Directive Européenne 1999/5/EC.

#### **German**

Dieses Produkt entspricht den Bestimmungen der Europäischen Richtlinie 1999/5/EC.

#### **Greek**

Το προϊόν αυτό πληροί τις προβλέψεις της Ευρωπαϊκής Οδηγίας 1999/5/EC.

### **Icelandic**

Þessi vara stenst reglugerð Evrópska Efnahags Bandalagsins númer 1999/5/EC.

### **Italian**

Questo prodotto è conforme alla Direttiva Europea 1999/5/EC.

### **Norwegian**

Dette produktet er i henhold til bestemmelsene i det europeiske direktivet 1999/5/EC.

### **Portuguese**

Este produto cumpre com as normas da Diretiva Européia 1999/5/EC.

### **Spanish**

Este producto cumple con las normas del Directivo Europeo 1999/5/EC.

### **Swedish**

Denna produkt har tillverkats i enlighet med EG-direktiv 1999/5/EC.

## **Local Restrictions of 802.11a/g/n Radio Usage**

**CAUTION:** Due to the fact that the frequencies used by 802.11a/g/n wireless LAN devices may not yet be harmonized in all countries, 802.11a/g/n products are designed for use only in specific countries or regions, and is not allowed to be operated in countries or regions other than those of designated use. As a user of these products, you are responsible for ensuring that the products are used only in the countries or regions for which they were intended and for verifying that they are configured with the correct selection of frequency and channel for the country or region of use. Any deviation from permissible settings and restrictions in the country or region of use could be an infringement of local law and may be punished as such.

The European variant is intended for use throughout the European Economic Area. However, authorization for use is further restricted in particular countries or regions within countries, as follows:

## General

European standards dictate maximum radiated transmit power of 100 mW Effective Isotropic Radiated Power (EIRP) and the frequency range 2400 – 2483.5 MHz.

## Belgium and the Netherlands

In Belgium and the Netherlands, the product may not be used outdoors. See the instructions next under the heading “Turning Off the Wireless LAN Radio”.

## France

### Departments in Which the Wireless LAN Module Can Be Used (Indoors Only)

The wireless LAN module can currently be used indoors only in the following 38 departments of mainland France. Please turn off your wireless LAN radio when operating the device in areas/places other than the 38 departments listed:

01	Ain Orientales	36	Indre	66	Pyrénées
02	Aisne	37	Indre et Loire	67	Bas Rhin
03	Allier	41	Loir et Cher	68	Haut Rhin
05	Hautes Alpes	42	Loire	70	Haute Saône
08	Ardennes	45	Loiret	71	Saône et Loire
09	Ariège	50	Manche	75	Paris
11	Aude	55	Meuse	82	Tarn et Garonne
12	Aveyron	58	Nièvre	84	Vaucluse
16	Charente	59	Nord	88	Vosges
24	Dordogne	60	Oise	89	Yonne
25	Doubs	61	Orne	90	Territoire de Belfort
26	Drôme	63	Puy du Dôme	94	Val de Marne
32	Gers	64	Pyrénées Atlantique		



Departments in Which the Wireless LAN Module's Maximum EIRP Not Shown in the Previous Table

Frequency Ranges (MHz)	Indoors	Outdoors
2400 – 2446.5	10 mW	Not permitted
2446.5 – 2483.5	100 mW	100 mW on private property with Ministry of Defense approval

## Turning Off the Wireless LAN Radio

**NOTE:** Turning the wireless LAN radio off is not the same as disabling the wireless LAN card. It is not necessary to disable the card to meet the regulatory requirements.

While operating the computer in those French departments that do not allow use of the wireless LAN equipment, the user of the equipment must turn off the wireless LAN radio in order to comply with local regulations.