



*EMC Test Report  
Application for Grant of Equipment Authorization  
Industry Canada RSS-Gen Issue 2 / RSS 210 Issue 7  
FCC Part 15 Subpart C*

*Intel Centrino Advanced-N 6235, models 6235ANHMMW and  
6235ANHU*

IC CERTIFICATION #: 1000M-6235ANH and 1000M-6235ANHU  
FCC ID: PD96235ANH and PD96235ANHU

APPLICANT: Intel Corporation  
100 Center Point Circle Suite 200  
Columbia, SC 29210

TEST SITE(S): Elliott Laboratories  
41039 Boyce Road.  
Fremont, CA. 94538-2435

IC SITE REGISTRATION #: 2845B-4, 2845B-7

REPORT DATE: September 27, 2011

FINAL TEST DATES: September 20, 21, 28, and 30, 2010

TOTAL NUMBER OF PAGES: 85

PROGRAM MGR /  
TECHNICAL REVIEWER:

David W. Bare  
Chief Engineer

QUALITY ASSURANCE DELEGATE /  
FINAL REPORT PREPARER:

David Guidotti  
Senior Technical Writer



Testing Cert #2016.01

Elliott Laboratories is accredited by the A2LA, certificate number 2016.01, to perform the test(s) listed in this report, except where noted otherwise. This report and the information contained herein represent the results of testing test articles identified and selected by the client performed to specifications and/or procedures selected by the client. National Technical Systems (NTS) makes no representations, expressed or implied, that such testing is adequate (or inadequate) to demonstrate efficiency, performance, reliability, or any other characteristic of the articles being tested, or similar products. This report should not be relied upon as an endorsement or certification by NTS of the equipment tested, nor does it represent any statement whatsoever as to its merchantability or fitness of the test article, or similar products, for a particular purpose. This report shall not be reproduced except in full

**REVISION HISTORY**

Rev#	Date	Comments	Modified By
-	09-27-2011	First release	

**TABLE OF CONTENTS**

<b>REVISION HISTORY .....</b>	<b>2</b>
<b>TABLE OF CONTENTS .....</b>	<b>3</b>
<b>SCOPE.....</b>	<b>4</b>
<b>OBJECTIVE .....</b>	<b>4</b>
<b>STATEMENT OF COMPLIANCE.....</b>	<b>5</b>
<b>DEVIATIONS FROM THE STANDARDS.....</b>	<b>5</b>
<b>TEST RESULTS SUMMARY .....</b>	<b>6</b>
FREQUENCY HOPPING SPREAD SPECTRUM (2400 – 2483.5 MHZ, LESS THAN 75 CHANNELS) .....	6
GENERAL REQUIREMENTS APPLICABLE TO ALL BANDS.....	6
ADDITIONAL MEASUREMENTS.....	7
<b>MEASUREMENT UNCERTAINTIES.....</b>	<b>7</b>
<b>EQUIPMENT UNDER TEST (EUT) DETAILS.....</b>	<b>8</b>
GENERAL.....	8
ANTENNA SYSTEM .....	8
ENCLOSURE.....	8
MODIFICATIONS.....	8
SUPPORT EQUIPMENT.....	9
EUT INTERFACE PORTS .....	9
EUT OPERATION .....	9
<b>TEST SITE.....</b>	<b>11</b>
GENERAL INFORMATION.....	11
CONDUCTED EMISSIONS CONSIDERATIONS .....	11
RADIATED EMISSIONS CONSIDERATIONS .....	11
<b>MEASUREMENT INSTRUMENTATION .....</b>	<b>12</b>
RECEIVER SYSTEM .....	12
INSTRUMENT CONTROL COMPUTER .....	12
LINE IMPEDANCE STABILIZATION NETWORK (LISN).....	12
FILTERS/ATTENUATORS .....	13
ANTENNAS.....	13
ANTENNA MAST AND EQUIPMENT TURNTABLE.....	13
INSTRUMENT CALIBRATION.....	13
<b>TEST PROCEDURES .....</b>	<b>14</b>
EUT AND CABLE PLACEMENT .....	14
CONDUCTED EMISSIONS.....	14
RADIATED EMISSIONS.....	14
RADIATED EMISSIONS.....	15
BANDWIDTH MEASUREMENTS.....	18
SPECIFICATION LIMITS AND SAMPLE CALCULATIONS .....	18
CONDUCTED EMISSIONS SPECIFICATION LIMITS: FCC 15.207; FCC 15.107(A), RSS GEN .....	18
GENERAL TRANSMITTER RADIATED EMISSIONS SPECIFICATION LIMITS .....	19
RECEIVER RADIATED SPURIOUS EMISSIONS SPECIFICATION LIMITS.....	19
OUTPUT POWER LIMITS – FHSS SYSTEMS .....	20
TRANSMIT MODE SPURIOUS RADIATED EMISSIONS LIMITS – FHSS AND DTS SYSTEMS.....	20
SAMPLE CALCULATIONS - CONDUCTED EMISSIONS .....	20
SAMPLE CALCULATIONS - RADIATED EMISSIONS.....	21
<b>APPENDIX A TEST EQUIPMENT CALIBRATION DATA .....</b>	<b>22</b>
<b>APPENDIX B TEST DATA .....</b>	<b>24</b>
<b>END OF REPORT .....</b>	<b>85</b>

## SCOPE

An electromagnetic emissions test has been performed on the Intel Corporation model Intel Centrino Advanced-N 6235, models 6235ANHMW and 6235ANHU, pursuant to the following rules:

- Industry Canada RSS-Gen Issue 3
- RSS 210 Issue 8 "Low-power Licence-exempt Radiocommunication Devices (All Frequency Bands): Category I Equipment"
- FCC Part 15 Subpart C

Conducted and radiated emissions data has been collected, reduced, and analyzed within this report in accordance with measurement guidelines set forth in the following reference standards and as outlined in Elliott Laboratories test procedures:

- ANSI C63.4:2003
- FHSS test procedure DA 00-0705A1, March 2000

The intentional radiator above has been tested in a simulated typical installation to demonstrate compliance with the relevant Industry Canada performance and procedural standards.

Final system data was gathered in a mode that tended to maximize emissions by varying orientation of EUT, orientation of power and I/O cabling, antenna search height, and antenna polarization.

Every practical effort was made to perform an impartial test using appropriate test equipment of known calibration. All pertinent factors have been applied to reach the determination of compliance.

## OBJECTIVE

The primary objective of the manufacturer is compliance with the regulations outlined in the previous section.

Prior to marketing in the USA, all unlicensed transmitters and transceivers require certification. Receive-only devices operating between 30 MHz and 960 MHz are subject to either certification or a manufacturer's declaration of conformity, with all other receive-only devices exempt from the technical requirements.

Prior to marketing in Canada, Class I transmitters, receivers and transceivers require certification. Class II devices are required to meet the appropriate technical requirements but are exempt from certification requirements.

Certification is a procedure where the manufacturer submits test data and technical information to a certification body and receives a certificate or grant of equipment authorization upon successful completion of the certification body's review of the submitted documents. Once the equipment authorization has been obtained, the label indicating compliance must be attached to all identical units, which are subsequently manufactured.

Maintenance of compliance is the responsibility of the manufacturer. Any modification of the product which may result in increased emissions should be checked to ensure compliance has been maintained (i.e., printed circuit board layout changes, different line filter, different power supply, harnessing or I/O cable changes, etc.).

#### **STATEMENT OF COMPLIANCE**

The tested sample of the Intel Centrino Advanced-N 6235, models 6235ANHMW and 6235ANHU complied with the requirements of the following regulations:

Industry Canada RSS-Gen Issue 3

RSS 210 Issue 8 "Low-power Licence-exempt Radiocommunication Devices (All Frequency Bands): Category I Equipment"

FCC Part 15 Subpart C

Maintenance of compliance is the responsibility of the manufacturer. Any modifications to the product should be assessed to determine their potential impact on the compliance status of the device with respect to the standards detailed in this test report.

The test results recorded herein are based on a single type test of the Intel Centrino Advanced-N 6235, models 6235ANHMW and 6235ANHU and therefore apply only to the tested sample. The sample was selected and prepared by Steve Hackett of Intel Corporation.

#### **DEVIATIONS FROM THE STANDARDS**

No deviations were made from the published requirements listed in the scope of this report.

**TEST RESULTS SUMMARY****FREQUENCY HOPPING SPREAD SPECTRUM (2400 – 2483.5 MHz, less than 75 channels)**

FCC Rule Part	RSS Rule Part	Description	Measured Value / Comments	Limit / Requirement	Result
15.247 (a) (1)	RSS 210 A8.1 (1)	20dB Bandwidth	1358 kHz	Channel spacing > 2/3rds 20dB BW	Complies
		Channel Separation	1000 kHz		
15.247 (a) (1) (ii)	RSS 210 A8.1 (4)	Number of Channels	Min: 20 Max: 79	15 or more	Complies
15.247 (a) (1) (ii)	RSS 210 A8.1 (4)	Channel Dwell Time ( <i>average time of occupancy</i> )	<0.4 second within a period of 0.4 x number of channels	<0.4 second within a period of 0.4 x number of channels	Complies
15.247 (a) (1)	RSS 210 A8.1 (1)	Channel Utilization	The system uses the Bluetooth algorithm and, therefore, meets all requirements for channel utilization.	All channels shall, on average, be used equally	Complies
15.247 (b) (3)	RSS 210 A8.4 (2)	Output Power	Basic rate: 0.004W EDR: 0.003W EIRP = 0.009 W <sup>Note 1</sup>	0.125 Watts	Complies
15.247(c)	RSS 210 A8.5	Spurious Emissions – 30MHz – 25GHz	All spurious emissions < -20dBc	< -20dBc	Complies
15.247(c) / 15.209	RSS 210 A8.5 Table 2, 3	Radiated Spurious Emissions 30MHz – 25GHz	51.3dB $\mu$ V/m @ 2483.5MHz	15.207 in restricted bands, all others < -20dBc	Complies (-2.7dB)
15.247 (a) (1)	RSS 210 A8.1(2)	Receiver bandwidth	Refer to operational description, page 2	Shall match the channel bandwidth	Complies

Note 1: EIRP calculated using antenna gain of 3.2dBi.

**GENERAL REQUIREMENTS APPLICABLE TO ALL BANDS**

FCC Rule Part	RSS Rule part	Description	Measured Value / Comments	Limit / Requirement	Result (margin)
15.203	-	RF Connector	Unique	Integral or unique connector required	Complies
15.109	RSS GEN 6.1 Table 2	Receiver spurious emissions	41.2dB $\mu$ V/m @ 662.52MHz	Refer to page 19	Complies (-4.8dB)
15.207	RSS GEN Table 4	AC Conducted Emissions	40.6dB $\mu$ V @ 14.758MHz	Refer to page 18	Complies (-9.4dB)
15.247 (b) (5) 15.407 (f)	RSS-GEN 5.6 RSS 102	RF Exposure Requirements	Not applicable – the output power is below the 60/f threshold.		
-	RSP 100 RSS GEN 7.1	User Manual	Refer to page 11 of the user's manual	Statement required regarding non- interference	Complies
-	RSP 100 RSS GEN 7.1	User Manual	Not applicable, antenna is integral to host systems.	Statement for products with detachable antenna	N/A
-	RSP 100 RSS GEN 4.6.1	99% Bandwidth	Basic Rate: 957 kHz EDR: 1231 kHz	Information only	N/A

**ADDITIONAL MEASUREMENTS**

As both Bluetooth and 802.11 transmissions can occur simultaneously, radiated spurious measurements were made with both Bluetooth and 802.11 devices transmitting simultaneously.

DTS (Wi-Fi in 2.4GHz and 5.7GHz bands) and Bluetooth					
FCC Rule Part	RSS Rule part	Description	Measured Value / Comments	Limit / Requirement	Result (margin)
15.209	RSS 210	Spurious emissions	49.3dB $\mu$ V/m @ 2320.0MHz	15.209 in restricted bands, all others < -20dBc	Complies (-4.7dB)

LELAN/NII (Wi-Fi in 5150-5350/5470-5725MHz bands) and Bluetooth					
FCC Rule Part	RSS Rule part	Description	Measured Value / Comments	Limit / Requirement	Result (margin)
15.209	RSS 210	Spurious emissions	45.1dB $\mu$ V/m @ 11199.8MHz	15.209 in restricted bands, all others < -20dBc	Complies (-8.9dB)
Signal was actually second harmonic of 802.11 signal and not an inter-modulation product, but this was the highest level signal observed with both Bluetooth and Wi-Fi transmitters operational simultaneously.					

**MEASUREMENT UNCERTAINTIES**

ISO/IEC 17025 requires that an estimate of the measurement uncertainties associated with the emissions test results be included in the report. The measurement uncertainties given below are based on a 95% confidence level and were calculated in accordance with UKAS document LAB 34.

Measurement Type	Measurement Unit	Frequency Range	Expanded Uncertainty
RF power, conducted (power meter)	dBm	25 to 7000 MHz	$\pm 0.52$ dB
RF power, conducted (Spectrum analyzer)	dBm	25 to 7000 MHz	$\pm 0.7$ dB
Conducted emission of transmitter	dBm	25 to 26500 MHz	$\pm 0.7$ dB
Conducted emission of receiver	dBm	25 to 26500 MHz	$\pm 0.7$ dB
Radiated emission (substitution method)	dBm	25 to 26500 MHz	$\pm 2.5$ dB
Radiated emission (field strength)	dB $\mu$ V/m	25 to 1000 MHz	$\pm 3.6$ dB
		1000 to 40000 MHz	$\pm 6.0$ dB
Conducted Emissions (AC Power)	dB $\mu$ V	0.15 to 30 MHz	$\pm 2.4$ dB

**EQUIPMENT UNDER TEST (EUT) DETAILS****GENERAL**

The Intel Centrino Advanced-N 6235, models 6235ANHMW and 6235ANHU are PCIe half mini card form factor Bluetooth/IEEE 802.11a/b/g/n wireless network adapters. The card supports MIMO (2x2) for 802.11n modes and MISO (1x2) for 802.11a/b/g modes. Bluetooth only operation mode is a 1x1. When Bluetooth is operational then 802.11b/g/n modes operate as SISO (1x1). 802.11a/n modes still operate as MIMO (2x2) with Bluetooth operational.

The card is sold using two different FCC/IC ID numbers and two different model numbers (see table below). The models/ID's ending in "U" are intended to allow user install conditions and host systems must be provided with a BIOS locking feature that prevents installation of unauthorized devices.

For radio testing purposes the card was installed in a test fixture that exposed all sides of the card. For digital device testing for certification under equipment code JBP the card was installed inside a laptop PC.

The sample was received on September 13, 2010 and tested on September 20, 21, 28, and 30, 2010. The EUT consisted of the following component(s):

Manufacturer	Model	Description	MAC Address	FCC ID and Canada UPN
Intel Corporation	6235ANHMW	PCIe Half Mini Card form factor Bluetooth / IEEE 802.11a/b/g/n wireless network adapter	00150079AD10	PD96235ANH PD96235ANHU 1000M-6235ANH
	6235ANHU			1000M-6235ANHU

**ANTENNA SYSTEM**

The EUT antenna is a two-antenna PIFA antenna system – Shanghai Universe Communication Electron Co., Ltd. The antenna connects to the EUT via a non-standard antenna connector, thereby meeting the requirements of FCC 15.203.

**ENCLOSURE**

The EUT does not have an enclosure as it is designed to be installed within the enclosure of a host computer or system.

**MODIFICATIONS**

No modifications were made to the EUT during the time the product was at Elliott.



**SUPPORT EQUIPMENT**

The following equipment was used as support equipment for testing:

Company	Model	Description	Serial Number	FCC ID
Intel Corporation	-	Test Fixture	D9164573K0B0	N/A
DELL	Latitude D520	Laptop PC	HM9383J	N/A
Agilent	E3610A	DC Supply	MY4001740	N/A

**EUT INTERFACE PORTS**

The I/O cabling configuration during testing was as follows:

Port	Connected To	Description	Cable(s)	
			Shielded or Unshielded	Length(m)
Laptop USB	Fixture USB	USB cable	Shielded	
Laptop Mini PCI	Fixture PCIe	Ribbon	unshielded	
DC Power	Fixture DC power	2-wire	unshielded	

**EUT OPERATION**

The EUT was installed into a test fixture that exposed all sides of the card. The test fixture interfaced to a laptop computer and dc power supply. The laptop computer was used to configure the EUT to continuously transmit at a specified output power or continuously receive on the channel specified in the test data. For transmit mode measurements the system was configured to operate in each of the available operating modes –Bluetooth 1Mb/s and Bluetooth 3Mb/s. In addition radiated spurious tests were repeated with the device operating in both Bluetooth and 802.11 modes to determine if any spurious emissions due to inter-modulation products were created.

The field strength at the band edges was evaluated for each mode and on each chain individually on the lowest and highest channels at the rated power for the channel under test. Where the power at the edge channels was lower than the power at the center channels additional measurements were made at the adjacent channels. MIMO and SISO modes were fully evaluated.

Spurious emissions measurements at frequencies away from the band edges were made at the highest power rating for the band in each mode.

Bluetooth operation was evaluated at both 1Mb/s and 3Mb/s data rates. 2Mb/s data rate was found, through preliminary testing, to produce emissions similar to those for 3Mb/s.

Bluetooth receiver spurious emissions were evaluated for single chain only as MISO is not supported for Bluetooth.

The PC was using the Intel test utility DRTU Version 1.2.12-0197 and the device driver was version 14.0.0.39.

**TEST SITE****GENERAL INFORMATION**

Final test measurements were taken at the test sites listed below. Pursuant to section 2.948 of the FCC's Rules and section 3.3 of RSP-100, construction, calibration, and equipment data has been filed with the Commission and with industry Canada.

Site	Registration Numbers		Location
	FCC	Canada	
Chamber 4	211948	2845B-4	41039 Boyce Road Fremont, CA 94538-2435
Chamber 7	A2LA accreditation	2845B-7	

ANSI C63.4:2003 recommends that ambient noise at the test site be at least 6 dB below the allowable limits. Ambient levels are below this requirement. The test site(s) contain separate areas for radiated and conducted emissions testing. Considerable engineering effort has been expended to ensure that the facilities conform to all pertinent requirements of ANSI C63.4:2003.

**CONDUCTED EMISSIONS CONSIDERATIONS**

Conducted emissions testing is performed in conformance with ANSI C63.4:2003. Measurements are made with the EUT connected to the public power network through a nominal, standardized RF impedance, which is provided by a line impedance stabilization network, known as a LISN. A LISN is inserted in series with each current-carrying conductor in the EUT power cord.

**RADIATED EMISSIONS CONSIDERATIONS**

The FCC has determined that radiation measurements made in a shielded enclosure are not suitable for determining levels of radiated emissions. Radiated measurements are performed in an open field environment or in a semi-anechoic chamber. The test sites are maintained free of conductive objects within the CISPR defined elliptical area incorporated in ANSI C63.4:2003 guidelines and meet the Normalized Site Attenuation (NSA) requirements of ANSI C63.4:2003.

## **MEASUREMENT INSTRUMENTATION**

### **RECEIVER SYSTEM**

An EMI receiver as specified in CISPR 16-1-1 is used for emissions measurements. The receivers used can measure over the frequency range of 9 kHz up to 2000 MHz. These receivers allow both ease of measurement and high accuracy to be achieved. The receivers have Peak, Average, and CISPR (Quasi-peak) detectors built into their design so no external adapters are necessary. The receiver automatically sets the required bandwidth for the CISPR detector used during measurements. If the repetition frequency of the signal being measured is below 20Hz, peak measurements are made in lieu of Quasi-Peak measurements.

For measurements above the frequency range of the receivers, a spectrum analyzer is utilized because it provides visibility of the entire spectrum along with the precision and versatility required to support engineering analysis. Average measurements above 1000MHz are performed on the spectrum analyzer using the linear-average method with a resolution bandwidth of 1 MHz and a video bandwidth of 10 Hz, unless the signal is pulsed in which case the average (or video) bandwidth of the measuring instrument is reduced to onset of pulse desensitization and then increased.

### **INSTRUMENT CONTROL COMPUTER**

The receivers utilize either a Rohde & Schwarz EZM Spectrum Monitor/Controller or contain an internal Spectrum Monitor/Controller to view and convert the receiver measurements to the field strength at an antenna or voltage developed at the LISN measurement port, which is then compared directly with the appropriate specification limit. This provides faster, more accurate readings by performing the conversions described under Sample Calculations within the Test Procedures section of this report. Results are printed in a graphic and/or tabular format, as appropriate. A personal computer is used to record all measurements made with the receivers.

The Spectrum Monitor provides a visual display of the signal being measured. In addition, the controller or a personal computer run automated data collection programs which control the receivers. This provides added accuracy since all site correction factors, such as cable loss and antenna factors are added automatically.

### **LINE IMPEDANCE STABILIZATION NETWORK (LISN)**

Line conducted measurements utilize a fifty microhenry Line Impedance Stabilization Network as the monitoring point. The LISN used also contains a 250 uH CISPR adapter. This network provides for calibrated radio frequency noise measurements by the design of the internal low pass and high pass filters on the EUT and measurement ports, respectively.

### *FILTERS/ATTENUATORS*

External filters and precision attenuators are often connected between the receiving antenna or LISN and the receiver. This eliminates saturation effects and non-linear operation due to high amplitude transient events.

### *ANTENNAS*

A loop antenna is used below 30 MHz. For the measurement range 30 MHz to 1000 MHz either a combination of a biconical antenna and a log periodic or a bi-log antenna is used. Above 1000 MHz, horn antennas are used. The antenna calibration factors to convert the received voltage to an electric field strength are included with appropriate cable loss and amplifier gain factors to determine an overall site factor, which is then programmed into the test receivers or incorporated into the test software.

### *ANTENNA MAST AND EQUIPMENT TURNTABLE*

The antennas used to measure the radiated electric field strength are mounted on a non-conductive antenna mast equipped with a motor-drive to vary the antenna height. Measurements below 30 MHz are made with the loop antenna at a fixed height of 1m above the ground plane.

ANSI C63.4:2003 specifies that the test height above ground for table mounted devices shall be 80 centimeters. Floor mounted equipment shall be placed on the ground plane if the device is normally used on a conductive floor or separated from the ground plane by insulating material from 3 to 12 mm if the device is normally used on a non-conductive floor. During radiated measurements, the EUT is positioned on a motorized turntable in conformance with this requirement.

### *INSTRUMENT CALIBRATION*

All test equipment is regularly checked to ensure that performance is maintained in accordance with the manufacturer's specifications. All antennas are calibrated at regular intervals with respect to tuned half-wave dipoles. An exhibit of this report contains the list of test equipment used and calibration information.

## TEST PROCEDURES

### EUT AND CABLE PLACEMENT

The regulations require that interconnecting cables be connected to the available ports of the unit and that the placement of the unit and the attached cables simulate the worst case orientation that can be expected from a typical installation, so far as practicable. To this end, the position of the unit and associated cabling is varied within the guidelines of ANSI C63.4:2003, and the worst-case orientation is used for final measurements.

### CONDUCTED EMISSIONS

Conducted emissions are measured at the plug end of the power cord supplied with the EUT. Excess power cord length is wrapped in a bundle between 30 and 40 centimeters in length near the center of the cord. Preliminary measurements are made to determine the highest amplitude emission relative to the specification limit for all the modes of operation. Placement of system components and varying of cable positions are performed in each mode. A final peak mode scan is then performed in the position and mode for which the highest emission was noted on all current carrying conductors of the power cord.

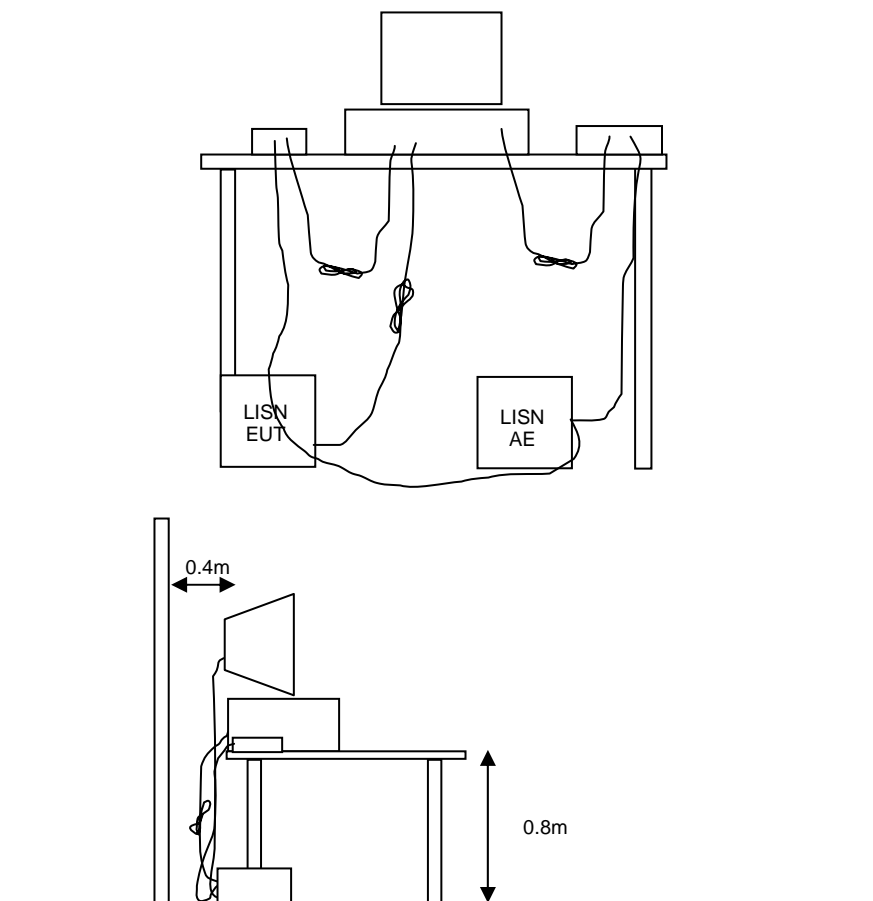

**Figure 1 Typical Conducted Emissions Test Configuration**

---

**RADIATED EMISSIONS**

A preliminary scan of the radiated emissions is performed in which all significant EUT frequencies are identified with the system in a nominal configuration. At least two scans are performed, one scan for each antenna polarization (horizontal and vertical; loop parallel and perpendicular to the EUT). During the preliminary scans, the EUT is rotated through 360°, the antenna height is varied (for measurements above 30 MHz) and cable positions are varied to determine the highest emission relative to the limit. Preliminary scans may be performed in a fully anechoic chamber for the purposes of identifying the frequencies of the highest emissions from the EUT.

A speaker is provided in the receiver to aid in discriminating between EUT and ambient emissions. Other methods used during the preliminary scan for EUT emissions involve scanning with near field magnetic loops, monitoring I/O cables with RF current clamps, and cycling power to the EUT.

Final maximization is a phase in which the highest amplitude emissions identified in the spectral search are viewed while the EUT azimuth angle is varied from 0 to 360 degrees relative to the receiving antenna. The azimuth, which results in the highest emission is then maintained while varying the antenna height from one to four meters (for measurements above 30 MHz, measurements below 30 MHz are made with the loop antenna at a fixed height of 1m). The result is the identification of the highest amplitude for each of the highest peaks. Each recorded level is corrected in the receiver using appropriate factors for cables, connectors, antennas, and preamplifier gain.

When testing above 18 GHz, the receive antenna is located at 1 meter from the EUT and the antenna height is restricted to a maximum of 2.5 meters.

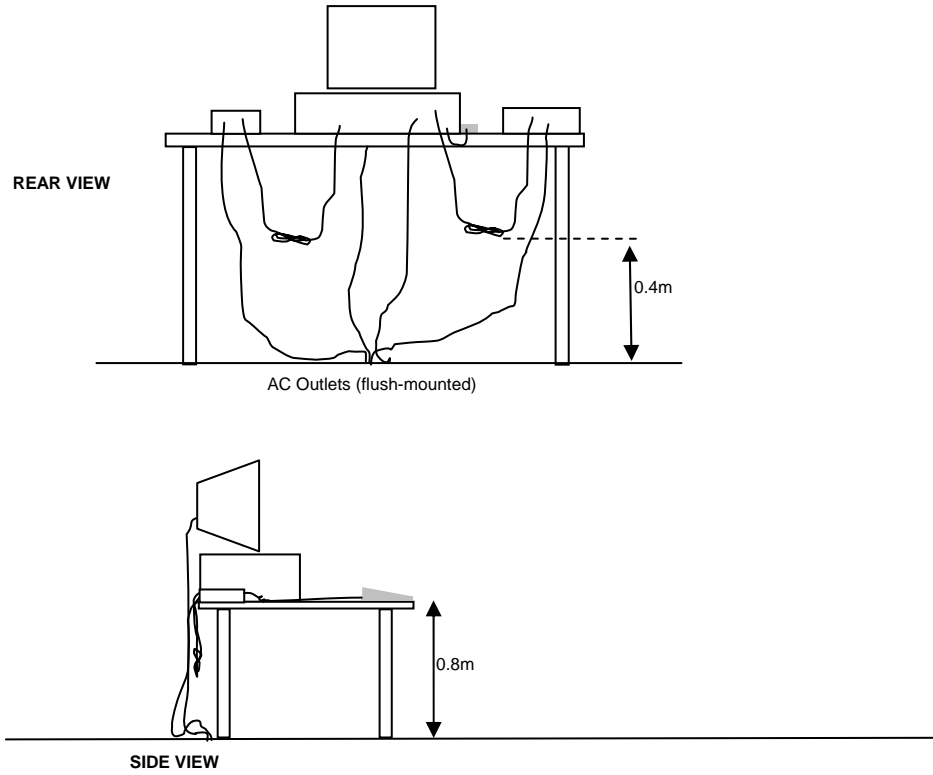

Typical Test Configuration for Radiated Field Strength Measurements



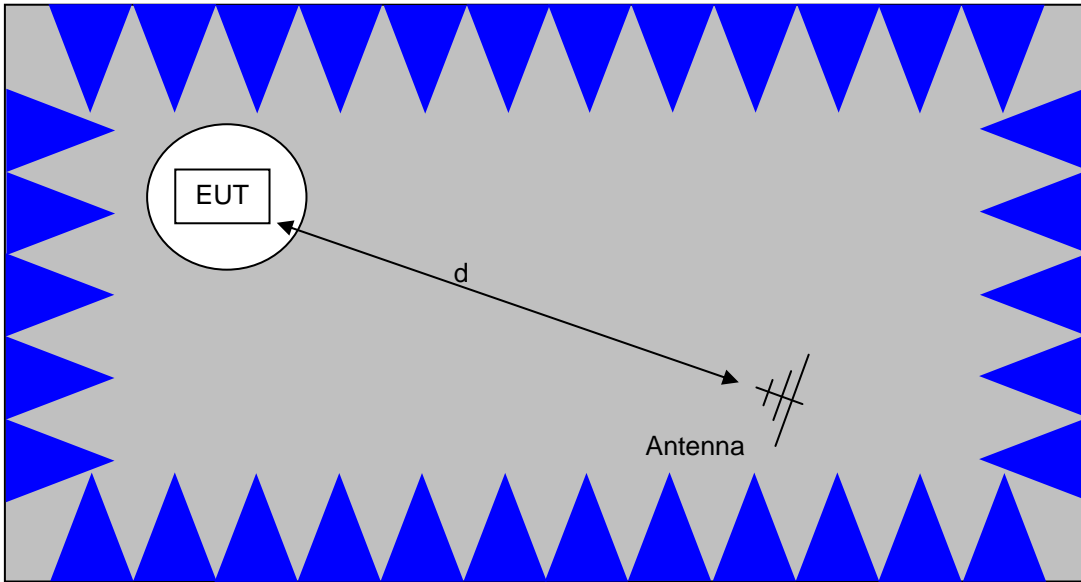

The anechoic materials on the walls and ceiling ensure compliance with the normalized site attenuation requirements of CISPR 16 / CISPR 22 / ANSI C63.4 for an alternate test site at the measurement distances used.

Floor-standing equipment is placed on the floor with insulating supports between the unit and the ground plane.

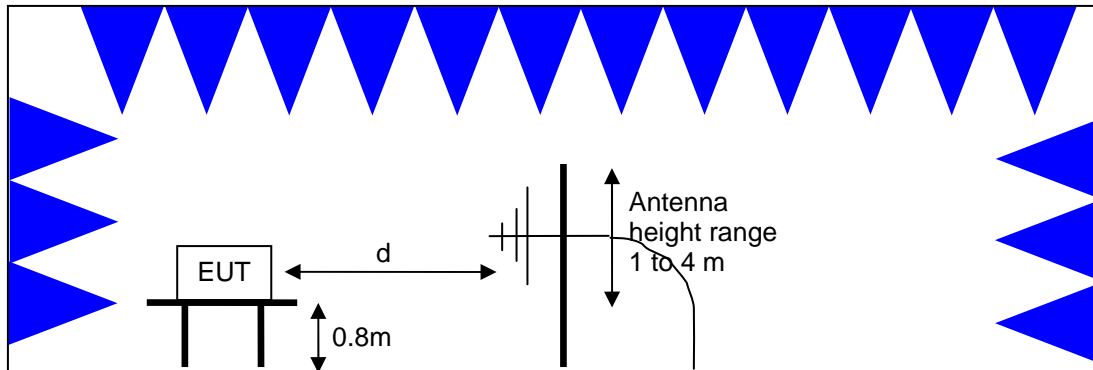

Test Configuration for Radiated Field Strength Measurements  
Semi-Anechoic Chamber, Plan and Side Views

**BANDWIDTH MEASUREMENTS**

The 6dB, 20dB and/or 26dB signal bandwidth is measured in using the bandwidths recommended by ANSI C63.4. When required, the 99% bandwidth is measured using the methods detailed in RSS GEN.

**SPECIFICATION LIMITS AND SAMPLE CALCULATIONS**

The limits for conducted emissions are given in units of microvolts, and the limits for radiated emissions are given in units of microvolts per meter at a specified test distance. Data is measured in the logarithmic form of decibels relative to one microvolt, or dB microvolts (dBuV). For radiated emissions, the measured data is converted to the field strength at the antenna in dB microvolts per meter (dBuV/m). The results are then converted to the linear forms of uV and uV/m for comparison to published specifications.

For reference, converting the specification limits from linear to decibel form is accomplished by taking the base ten logarithm, then multiplying by 20. These limits in both linear and logarithmic form are as follows:

**CONDUCTED EMISSIONS SPECIFICATION LIMITS: FCC 15.207; FCC 15.107(a), RSS GEN**

The table below shows the limits for the emissions on the AC power line from an intentional radiator and a receiver.

Frequency (MHz)	Average Limit (dBuV)	Quasi Peak Limit (dBuV)
0.150 to 0.500	Linear decrease on logarithmic frequency axis between 56.0 and 46.0	Linear decrease on logarithmic frequency axis between 66.0 and 56.0
0.500 to 5.000	46.0	56.0
5.000 to 30.000	50.0	60.0

**GENERAL TRANSMITTER RADIATED EMISSIONS SPECIFICATION LIMITS**

The table below shows the limits for the spurious emissions from transmitters that fall in restricted bands<sup>1</sup> (with the exception of transmitters operating under FCC Part 15 Subpart D and RSS 210 Annex 9), the limits for all emissions from a low power device operating under the general rules of RSS 310 (tables 3 and 4), RSS 210 (table 2) and FCC Part 15 Subpart C section 15.209.

Frequency Range (MHz)	Limit (uV/m)	Limit (dBuV/m @ 3m)
0.009-0.490	2400/F <sub>KHz</sub> @ 300m	67.6-20*log <sub>10</sub> (F <sub>KHz</sub> ) @ 300m
0.490-1.705	24000/F <sub>KHz</sub> @ 30m	87.6-20*log <sub>10</sub> (F <sub>KHz</sub> ) @ 30m
1.705 to 30	30 @ 30m	29.5 @ 30m
30 to 88	100 @ 3m	40 @ 3m
88 to 216	150 @ 3m	43.5 @ 3m
216 to 960	200 @ 3m	46.0 @ 3m
Above 960	500 @ 3m	54.0 @ 3m

**RECEIVER RADIATED SPURIOUS EMISSIONS SPECIFICATION LIMITS**

The table below shows the limits for the spurious emissions from receivers as detailed in FCC Part 15.109, RSS 210 Table 2, RSS GEN Table 1 and RSS 310 Table 3. Note that receivers operating outside of the frequency range 30 MHz – 960 MHz are exempt from the requirements of 15.109.

Frequency Range (MHz)	Limit (uV/m @ 3m)	Limit (dBuV/m @ 3m)
30 to 88	100	40
88 to 216	150	43.5
216 to 960	200	46.0
Above 960	500	54.0

<sup>1</sup> The restricted bands are detailed in FCC 15.203, RSS 210 Table 1 and RSS 310 Table 2

**OUTPUT POWER LIMITS – FHSS SYSTEMS**

The table below shows the limits for output power based on the number of channels available for the hopping system.

Operating Frequency (MHz)	Number of Channels	Output Power
902 – 928	≥ 50	1 Watt (30 dBm)
902 – 928	25 to 49	0.25 Watts (24 dBm)
2400 – 2483.5	≥ 75	1 Watt (30 dBm)
2400 – 2483.5	< 75	0.125 Watts (21 dBm)
5725 – 5850	75	1 Watt (30 dBm)

The maximum permitted output power is reduced by 1dB for every dB the antenna gain exceeds 6dBi. Fixed point-to-point applications using the 5725 – 5850 MHz band are not subject to this restriction.

**TRANSMIT MODE SPURIOUS RADIATED EMISSIONS LIMITS – FHSS and DTS SYSTEMS**

The limits for unwanted (spurious) emissions from the transmitter falling in the restricted bands are those specified in the general limits sections of FCC Part 15 and RSS 210. All other unwanted (spurious) emissions shall be at least 20dB below the level of the highest in-band signal level (30dB if the power is measured using the sample detector/power averaging method).

**SAMPLE CALCULATIONS - CONDUCTED EMISSIONS**

Receiver readings are compared directly to the conducted emissions specification limit (decibel form) as follows:

$$R_r - S = M$$

where:

$R_r$  = Receiver Reading in dBuV

S = Specification Limit in dBuV

M = Margin to Specification in +/- dB

**SAMPLE CALCULATIONS - RADIATED EMISSIONS**

Receiver readings are compared directly to the specification limit (decibel form). The receiver internally corrects for cable loss, preamplifier gain, and antenna factor. The calculations are in the reverse direction of the actual signal flow, thus cable loss is added and the amplifier gain is subtracted. The Antenna Factor converts the voltage at the antenna coaxial connector to the field strength at the antenna elements.

A distance factor, when used for electric field measurements above 30MHz, is calculated by using the following formula:

$$F_d = 20 * \text{LOG}_{10} (D_m/D_s)$$

where:

$$F_d = \text{Distance Factor in dB}$$

$$D_m = \text{Measurement Distance in meters}$$

$$D_s = \text{Specification Distance in meters}$$

For electric field measurements below 30MHz the extrapolation factor is either determined by making measurements at multiple distances or a theoretical value is calculated using the formula:

$$F_d = 40 * \text{LOG}_{10} (D_m/D_s)$$

Measurement Distance is the distance at which the measurements were taken and Specification Distance is the distance at which the specification limits are based. The antenna factor converts the voltage at the antenna coaxial connector to the field strength at the antenna elements.

The margin of a given emission peak relative to the limit is calculated as follows:

$$R_c = R_r + F_d$$

and

$$M = R_c - L_s$$

where:

$$R_r = \text{Receiver Reading in dBuV/m}$$

$$F_d = \text{Distance Factor in dB}$$

$$R_c = \text{Corrected Reading in dBuV/m}$$

$$L_s = \text{Specification Limit in dBuV/m}$$

$$M = \text{Margin in dB Relative to Spec}$$

**Appendix A Test Equipment Calibration Data****DTS Spurs, 20-Sep-10**

<u>Manufacturer</u>	<u>Description</u>	<u>Model</u>	<u>Asset #</u>	<u>Cal Due</u>
EMCO	Antenna, Horn, 1-18 GHz	3115	487	7/6/2012
Hewlett Packard	Microwave Preamplifier, 1-26.5GHz	8449B	870	6/25/2011
Micro-Tronics	Band Reject Filter, 2400-2500 MHz	BRM50702-02	1683	8/10/2011
Hewlett Packard	SpecAn 9 kHz - 40 GHz, (SA40) Purple	8564E (84125C)	1771	8/26/2011

**Radiated Emissions, 1000 - 26,500 MHz, 20-Sep-10**

<u>Manufacturer</u>	<u>Description</u>	<u>Model</u>	<u>Asset #</u>	<u>Cal Due</u>
EMCO	Antenna, Horn, 1-18 GHz	3115	487	7/6/2012
Hewlett Packard	Microwave Preamplifier, 1-26.5GHz	8449B	870	6/25/2011
Rohde & Schwarz	Power Sensor 100 uW - 10 Watts	NRV-Z53	1555	2/5/2011
Rohde & Schwarz	Attenuator, 20 dB , 50 ohm, 10W, DC-18 GHz	20dB, 10W, Type N	1556	2/5/2011
Micro-Tronics	Band Reject Filter, 2400-2500 MHz	BRM50702-02	1683	8/10/2011
Hewlett Packard	SpecAn 9 kHz - 40 GHz, (SA40) Purple	8564E (84125C)	1771	8/26/2011
Hewlett Packard	Head (Inc W1-W4, 1946, 1947) Purple	84125C	1772	5/6/2011
Rohde & Schwarz	Power Meter, Dual Channel	NRVD	1787	12/4/2010
A.H. Systems	Blue System Horn, 18-40GHz	SAS-574, p/n: 2581	2159	3/18/2011

**Radiated Emissions, 1000 - 40,000 MHz, 21-Sep-10**

<u>Manufacturer</u>	<u>Description</u>	<u>Model</u>	<u>Asset #</u>	<u>Cal Due</u>
EMCO	Antenna, Horn, 1-18 GHz	3115	487	7/6/2012
Hewlett Packard	Microwave Preamplifier, 1-26.5GHz	8449B	870	6/25/2011
Micro-Tronics	Band Reject Filter, 5725-5875 MHz	BRC50705-02	1728	2/1/2011
Hewlett Packard	SpecAn 9 kHz - 40 GHz, (SA40) Purple	8564E (84125C)	1771	8/26/2011
Hewlett Packard	Head (Inc W1-W4, 1946, 1947) Purple	84125C	1772	5/6/2011
A.H. Systems	Blue System Horn, 18-40GHz	SAS-574, p/n: 2581	2159	3/18/2011

**Conducted Emissions - AC Power Ports, 28-Sep-10**

<u>Manufacturer</u>	<u>Description</u>	<u>Model</u>	<u>Asset #</u>	<u>Cal Due</u>
Rohde & Schwarz	Pulse Limiter	ESH3 Z2	372	2/3/2011
Solar Electronics	LISN	8028-50-TS-24-BNC support	904	3/2/2011
EMCO	LISN, 10 kHz-100 MHz	3825/2	1292	3/12/2011
Hewlett Packard	EMC Spectrum Analyzer, 9 KHz - 22 GHz	8593EM	1319	10/19/2010
Rohde & Schwarz	Test Receiver, 9 kHz-2750 MHz	ESCS 30	1337	11/11/2010

**Radiated Emissions, 30 - 1,000 MHz, 28-Sep-10**

<u>Manufacturer</u>	<u>Description</u>	<u>Model</u>	<u>Asset #</u>	<u>Cal Due</u>
Hewlett Packard	EMC Spectrum Analyzer, 9 KHz - 22 GHz	8593EM	1319	10/19/2010
Rohde & Schwarz	Test Receiver, 9 kHz-2750 MHz	ESCS 30	1337	11/11/2010
Sunol Sciences	Biconilog, 30-3000 MHz	JB3	1548	6/24/2012
Com-Power Corp.	Preamplifier, 30-1000 MHz	PAM-103	2234	5/19/2011

**Radio Antenna Port (Power and Spurious Emissions), 28-Sep-10**

<u>Manufacturer</u>	<u>Description</u>	<u>Model</u>	<u>Asset #</u>	<u>Cal Due</u>
Rohde & Schwarz	Power Meter, Single Channel	NRVS	1290	10/22/2010
Hewlett Packard	SpecAn 9 kHz - 40 GHz, FT (SA40) Blue	8564E (84125C)	1393	4/14/2011
Rohde & Schwarz	Power Sensor 100 uW - 2 Watts (w/ 20 dB pad, SN BJ5155)	NRV-Z32	1536	9/13/2011
Rohde & Schwarz	Power Sensor 100 uW - 10 Watts	NRV-Z53	1555	2/5/2011
Rohde & Schwarz	Attenuator, 20 dB , 50 ohm, 10W, DC-18 GHz	20dB, 10W, Type N	1556	2/5/2011

**RE, Wi-Fi & BT Simultaneous Tx, 30-Sep-10**

<u>Manufacturer</u>	<u>Description</u>	<u>Model</u>	<u>Asset #</u>	<u>Cal Due</u>
Hewlett Packard	Microwave Preamplifier, 1-26.5GHz	8449B	263	12/15/2010
EMCO	Antenna, Horn, 1-18 GHz	3115	786	12/11/2011
Rohde & Schwarz	Power Meter, Single Channel	NRVS	1290	10/22/2010
Hewlett Packard	SpecAn 9 kHz - 40 GHz, FT (SA40) Blue	8564E (84125C)	1393	4/14/2011
Rohde & Schwarz	Power Sensor 100 uW - 10 Watts	NRV-Z53	1555	2/5/2011
Rohde & Schwarz	Attenuator, 20 dB , 50 ohm, 10W, DC-18 GHz	20dB, 10W, Type N	1556	2/5/2011
Micro-Tronics	Band Reject Filter, 2400-2500 MHz	BRM50702-02	1683	8/10/2011

## *Appendix B Test Data*

T80540.2

AC Conducted Emissions  
Radiated Spurious Emissions  
Antenna Port Measurements

Pages 25 - 54

T80540.2

Radiated Spurious Emissions –  
simultaneous transmissions from  
Bluetooth and Wi-Fi transceivers

Pages 55 - 84





## EMC Test Data

Client:	Intel Corporation	Job Number:	J84365
Model:	Intel® Centrino® Advanced-N 6235	T-Log Number:	T80540.2
		Account Manager:	Christine Krebill
Contact:	Steve Hackett		-
Emissions Standard(s):	FCC 15.247	Class:	B
Immunity Standard(s):	-	Environment:	-

# EMC Test Data

For The

## Intel Corporation

Model

Intel® Centrino® Advanced-N 6235

Date of Last Test: 10/6/2010

Client:	Intel Corporation	Job Number:	J84365
Model:	Intel® Centrino® Advanced-N 6235	T-Log Number:	T80540.2
		Account Manager:	Christine Krebill
Contact:	Steve Hackett		
Standard:	FCC 15.247	Class:	B

## Conducted Emissions

*(Elliott Laboratories Fremont Facility, Semi-Anechoic Chamber)*

### Test Specific Details

Objective: The objective of this test session is to perform final qualification testing of the EUT with respect to the specification listed above.

Date of Test: 9/28/2010	Config. Used: Modular Test
Test Engineer: Rafael Varelas	Config Change: None
Test Location: FT Chamber #7	Host Unit Voltage 120V/60Hz

### General Test Configuration

The test fixture was located on a wooden table inside the semi-anechoic chamber, 40 cm from a vertical coupling plane and 80cm from the LISN. A second LISN was used for all local support equipment.

**Ambient Conditions:**

Temperature:	21.9 °C
Rel. Humidity:	42 %

### Summary of Results

MAC Address: 00150079AD1A DRTU Tool Version 1.2.12-0197 Driver version 14.0.0.39

Run #	Test Performed	Limit	Result	Margin
1	CE, AC Power, 120V/60Hz	RSS 210 / 15.207	Pass	40.6dBµV @ 14.758MHz (-9.4dB)

### Modifications Made During Testing

No modifications were made to the EUT during testing

### Deviations From The Standard

No deviations were made from the requirements of the standard.

Client:	Intel Corporation	Job Number:	J84365
Model:	Intel® Centrino® Advanced-N 6235	T-Log Number:	T80540.2
Contact:	Steve Hackett	Account Manager:	Christine Krebill
Standard:	FCC 15.247	Class:	B

Run #1: AC Power Port Conducted Emissions, 0.15 - 30MHz, 120V/50Hz

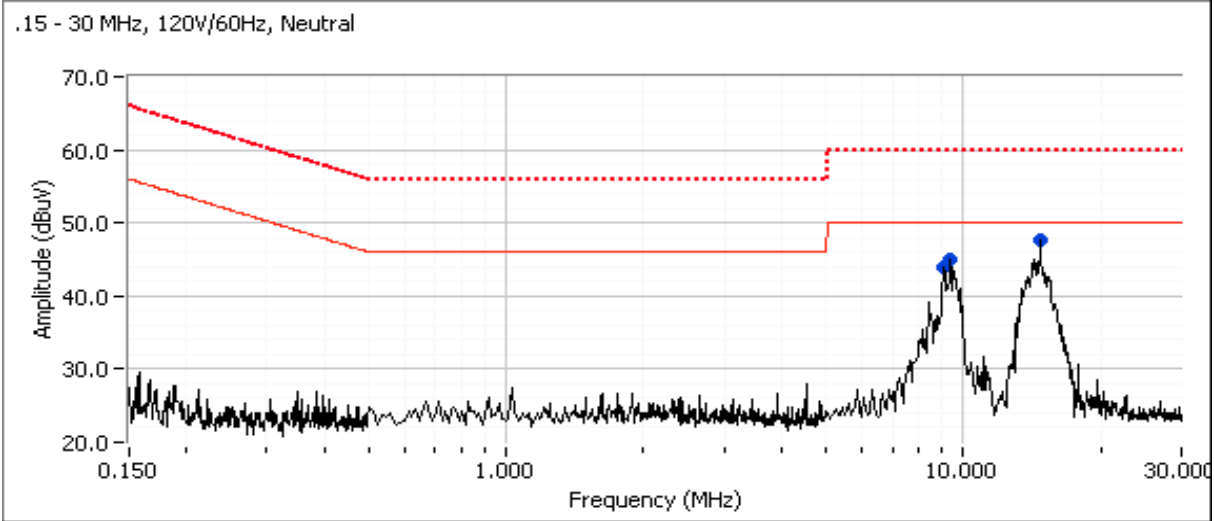
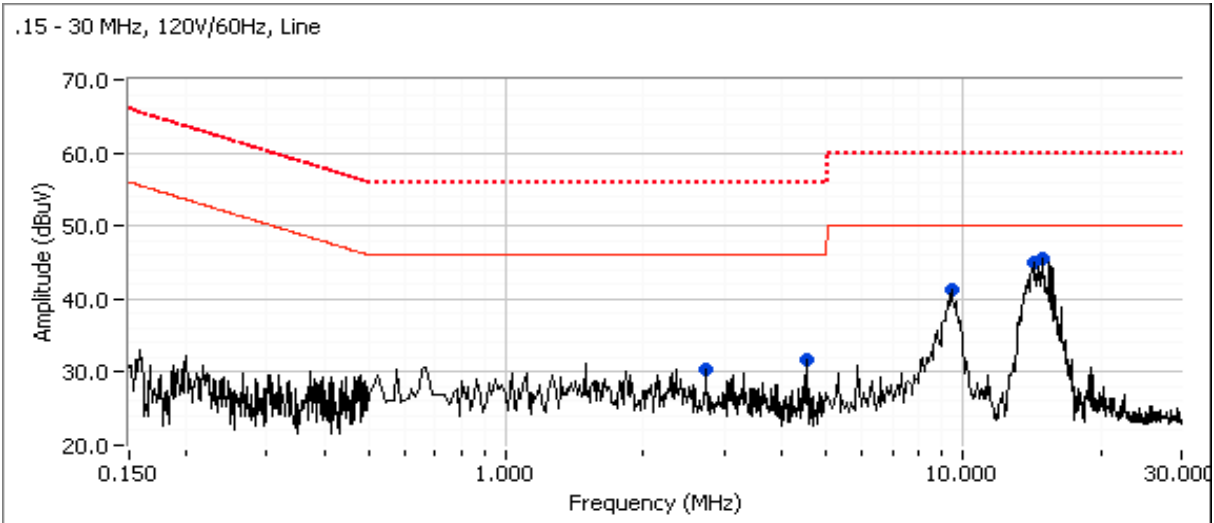

Client:	Intel Corporation	Job Number:	J84365
Model:	Intel® Centrino® Advanced-N 6235	T-Log Number:	T80540.2
Contact:	Steve Hackett	Account Manager:	Christine Krebill
Standard:	FCC 15.247	Class:	B

### Preliminary peak readings captured during pre-scan (peak readings vs. average limit)

Frequency MHz	Level dB $\mu$ V	AC Line	Class B		Detector QP/Ave	Comments
			Limit	Margin		
2.739	30.4	Line 1	46.0	-15.6	Peak	
4.528	31.8	Line 1	46.0	-14.2	Peak	
9.571	41.2	Line 1	50.0	-8.8	Peak	
14.272	44.9	Line 1	50.0	-5.1	Peak	
14.925	45.4	Line 1	50.0	-4.6	Peak	
9.073	44.0	Neutral	50.0	-6.0	Peak	
9.336	44.9	Neutral	50.0	-5.1	Peak	
14.758	47.7	Neutral	50.0	-2.3	Peak	

### Final quasi-peak and average readings

Frequency MHz	Level dB $\mu$ V	AC Line	Class B		Detector QP/Ave	Comments
			Limit	Margin		
14.758	40.6	Neutral	50.0	-9.4	AVG	AVG (0.100s)
14.272	40.1	Line 1	50.0	-9.9	AVG	AVG (0.100s)
14.925	35.7	Line 1	50.0	-14.3	AVG	AVG (0.100s)
14.272	44.8	Line 1	60.0	-15.2	QP	QP (1.000s)
9.336	34.6	Neutral	50.0	-15.4	AVG	AVG (0.100s)
14.758	44.6	Neutral	60.0	-15.4	QP	QP (1.000s)
9.073	32.7	Neutral	50.0	-17.3	AVG	AVG (0.100s)
9.571	32.6	Line 1	50.0	-17.4	AVG	AVG (0.100s)
14.925	42.4	Line 1	60.0	-17.6	QP	QP (1.000s)
9.073	39.9	Neutral	60.0	-20.1	QP	QP (1.000s)
9.336	39.7	Neutral	60.0	-20.3	QP	QP (1.000s)
9.571	37.9	Line 1	60.0	-22.1	QP	QP (1.000s)

Client:	Intel Corporation	Job Number:	J84365
Model:	Intel® Centrino® Advanced-N 6235	T-Log Number:	T80540.2
Contact:	Steve Hackett	Account Manager:	Christine Krebill
Standard:	FCC 15.247	Class:	B

## Radiated Emissions 30-1000 MHz, Wireless Module (FCC 15.247/RSS 210)

*(Elliott Laboratories Fremont Facility, Semi-Anechoic Chamber)*

### Test Specific Details

Objective: The objective of this test session is to perform final qualification testing of the EUT with respect to the specification listed above.

Date of Test: 9/28/2010	Config. Used: Modular Test
Test Engineer: Rafael Varelas	Config Change: None
Test Location: FT Chamber #7	Host Unit Voltage 120V/60Hz

### General Test Configuration

The EUT and any local support equipment were located on the turntable for radiated emissions testing.

The test distance and extrapolation factor (if applicable) are detailed under each run description.

Note, preliminary testing indicates that the emissions were maximized by orientation of the EUT and elevation of the measurement antenna. Maximized testing indicated that the emissions were maximized by orientation of the EUT, elevation of the measurement antenna, and manipulation of the EUT's interface cables.

### Ambient Conditions:

Temperature:	21.9 °C
Rel. Humidity:	42 %

### Summary of Results

MAC Address: 00150079AD1A DRTU Tool Version 1.2.12-0197 Driver version 14.0.0.39

Run #	Test Performed	Limit	Result	Margin
1	Radiated Emissions 30 - 1000 MHz	FCC 15.209 / RSS 210	Pass	41.2dBµV/m @ 662.52MHz (-4.8dB)

Note - preliminary measurements indicated that the radiated emissions from the combination of test fixture and EUT were not affected by the modules operating frequency or mode (transmit versus receive mode). The system was therefore evaluated against the most stringent set of limits from FCC 15.247, FCC 15E and RSS 210 with the device operating at max power (16.5dBm) on Chain A at 2437MHz, 802.11b mode and max power (7dBm) on the top channel in Bluetooth mode (1Mb/s data

### Modifications Made During Testing

No modifications were made to the EUT during testing

### Deviations From The Standard

No deviations were made from the requirements of the standard.

Client:	Intel Corporation	Job Number:	J84365
Model:	Intel® Centrino® Advanced-N 6235	T-Log Number:	T80540.2
Contact:	Steve Hackett	Account Manager:	Christine Krebill
Standard:	FCC 15.247	Class:	B

Run #1: Preliminary Radiated Emissions, 30 - 1000 MHz  
 Configured to TX , 802.11b 16.5dBm on each chain (settings 23.5) on channel 6, Bluetooth 7dBm, 1Mb/s (settings 8.0)

Frequency Range	Test Distance	Limit Distance	Extrapolation Factor
30 - 1000 MHz	3	3	0.0

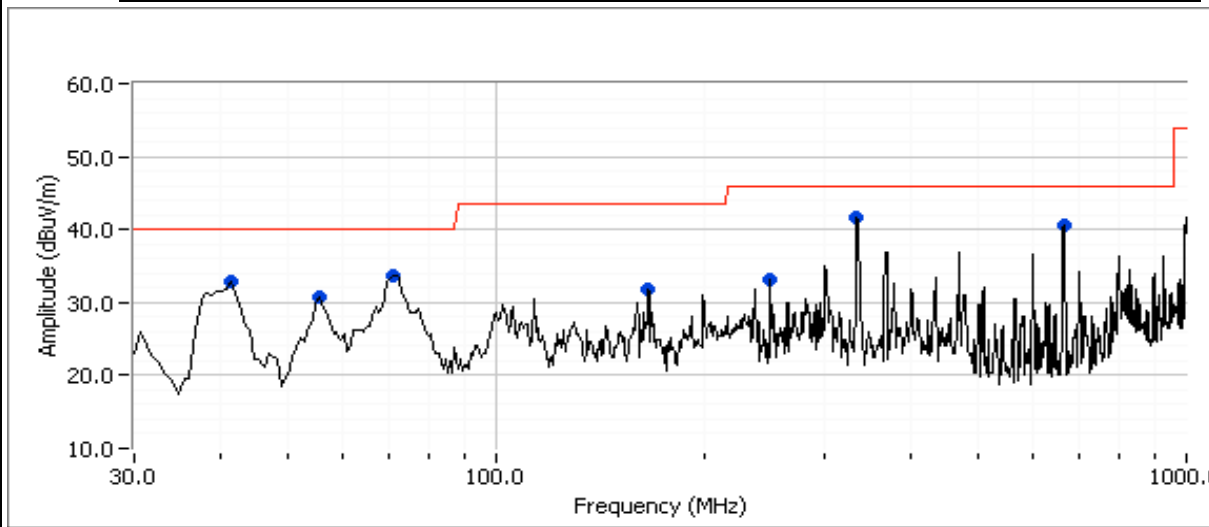

**Preliminary peak readings captured during pre-scan**

Frequency	Level	Pol	FCC 15.209 / RSS 210		Detector	Azimuth	Height	Comments
MHz	dBμV/m	v/h	Limit	Margin	Pk/QP/Avg	degrees	meters	
39.869	33.0	V	40.0	-7.0	Peak	185	2.5	
55.317	30.8	V	40.0	-9.2	Peak	333	1.0	
70.276	33.6	V	40.0	-6.4	Peak	40	1.0	
166.249	31.8	V	43.5	-11.7	Peak	202	1.0	
250.000	33.1	H	46.0	-12.9	Peak	154	1.5	
299.217	36.3	H	46.0	-9.7	Peak	172	1.0	
332.857	41.7	H	46.0	-4.3	Peak	116	1.0	
662.560	40.5	V	46.0	-5.5	Peak	44	1.0	

**Maximized quasi-peak readings (includes manipulation of EUT interface cables)**

Frequency	Level	Pol	FCC 15.209 / RSS 210		Detector	Azimuth	Height	Comments
MHz	dBμV/m	v/h	Limit	Margin	Pk/QP/Avg	degrees	meters	
662.515	41.2	V	46.0	-4.8	QP	44	1.0	QP (1.000s)
332.857	36.9	H	46.0	-9.1	QP	116	1.0	QP (1.000s)
39.869	29.7	V	40.0	-10.3	QP	185	2.5	QP (1.000s)
70.276	29.3	V	40.0	-10.7	QP	40	1.0	QP (1.000s)
55.317	27.1	V	40.0	-12.9	QP	333	1.0	QP (1.000s)
166.249	27.3	V	43.5	-16.2	QP	202	1.0	QP (1.000s)

Client:	Intel Corporation	Job Number:	J84365
Model:	Intel® Centrino® Advanced-N 6235	T-Log Number:	T80540.2
		Account Manager:	Christine Krebill
Contact:	Steve Hackett		
Standard:	FCC 15.247	Class:	N/A

## RSS 210 and FCC 15.247 (DSS) Radiated Spurious Emissions Bluetooth - Transmitter and Receiver Mode

### Summary of Results - Device Operating in the 2400-2483.5 MHz Band

Record results for target power and also for the passing power if it fails at target.

**For Bluetooth:** Tx is chain B, Rx is chain B

Bluetooth uses a frequency hopping algorithm that means that the device, during normal operation, is only on a specific channel for a short period of time. The average correction factor is calculated as follows:

A maximum length packet has a duration of 5 time slots.

The hopping rate is 1600 hops/second so the maximum dwell time is 5/1600 seconds, or 3.125ms.

With a minimum of 20 hopping channels a channel will not be used more than 4 times in any 100ms period.

The maximum dwell time in a 100m period is  $4 \times 3.125\text{ms} = 12.5\text{ms}$ .

The average correction factor is, therefore,  $20\log(12.5/100) = -18\text{dB}$

As this is a hopping radio the correction factor can be applied to the average value of the signal provided the average value was measured with the device continuously transmitting. DA 00-0705 permits the use of the average correction on the **measured average** value for frequency hopping radios.

**Use the gain control option for setting output power**

Run #	Mode	Channel	Target Power	Measured Power	Test Performed	Limit	Result / Margin
1a	Bluetooth basic rate (1Mb/s)	2402	7.5dBm	4.5dBm	Restricted Band Edge (2390 MHz)	FCC Part 15.209 / 15.247( c)	47.5dBµV/m @ 2388.1MHz (-6.5dB)
					Radiated Emissions, 1 - 26 GHz	FCC Part 15.209 / 15.247( c)	45.8dBµV/m @ 4803.9MHz (-8.2dB)
1b		2440	7.5dBm	5.8dBm	Radiated Emissions, 1 - 26 GHz	FCC Part 15.209 / 15.247( c)	48.2dBµV/m @ 7319.9MHz (-5.8dB)
1c		2480	7.5dBm	5.5dBm	Restricted Band Edge (2483.5 MHz)	FCC Part 15.209 / 15.247( c)	49.2dBµV/m @ 2483.5MHz (-4.8dB)
					Radiated Emissions, 1 - 26 GHz	FCC Part 15.209 / 15.247( c)	48.0dBµV/m @ 7440.0MHz (-6.0dB)
2a		Bluetooth EDR (3 Mb/s)	2402	7.5dBm	-0.8dBm	Restricted Band Edge (2390 MHz)	FCC Part 15.209 / 15.247( c)
2b	Radiated Emissions, 1 - 26 GHz					FCC Part 15.209 / 15.247( c)	39.1dBµV/m @ 4804.1MHz (-14.9dB)
	2c		2440	7.5dBm	1.8dBm	Radiated Emissions, 1 - 26 GHz	FCC Part 15.209 / 15.247( c)
3	Bluetooth Receive	2480	7.5dBm	1.3dBm	Restricted Band Edge (2483.5 MHz)	FCC Part 15.209 / 15.247( c)	51.3dBµV/m @ 2483.5MHz (-2.7dB)
					Radiated Emissions, 1 - 26 GHz	FCC Part 15.209 / 15.247( c)	37.8dBµV/m @ 4960.1MHz (-16.2dB)
3	Bluetooth Receive	2440	-	-	Radiated Emissions, 1 - 7.5 GHz	RSS 210	35.7dBµV/m @ 2987.9MHz (-18.3dB)

Client:	Intel Corporation	Job Number:	J84365
Model:	Intel® Centrino® Advanced-N 6235	T-Log Number:	T80540.2
		Account Manager:	Christine Krebill
Contact:	Steve Hackett		
Standard:	FCC 15.247	Class:	N/A

**Test Specific Details**

Objective: The objective of this test session is to perform final qualification testing of the EUT with respect to the specification listed above.

**General Test Configuration**

The EUT and all local support equipment were located on the turntable for radiated spurious emissions testing. For radiated emissions testing the measurement antenna was located 3 meters from the EUT.

**Ambient Conditions:**

Temperature: 21.4 °C  
Rel. Humidity: 39 %

**Modifications Made During Testing**

No modifications were made to the EUT during testing

**Deviations From The Standard**

No deviations were made from the requirements of the standard.

**Run #1: Radiated Spurious Emissions, 1000-26000 MHz. Operating Mode: Basic data rate (1Mb/s)**

Date of Test: 9/20/2010  
Test Engineer: Rafael Varelas  
Test Location: FT Chamber #7

**Run #1a: Low Channel @ 2402 MHz**

	Target (dBm)	Power Settings	
		Measured (dBm)	Software Setting
Chain B	7.5	4.5	8.0

**Fundamental Signal Field Strength:** Peak value measured in 100kHz

Frequency	Level	Pol	15.209 / 15.247		Detector	Azimuth	Height	Comments
MHz	dBµV/m	v/h	Limit	Margin	Pk/QP/Avg	degrees	meters	
2401.990	101.7	V	-	-	PK	39	1.0	RB 100 kHz;VB 100 kHz;Pk
2402.010	105.0	H	-	-	PK	237	1.0	RB 100 kHz;VB 100 kHz;Pk

Fundamental emission level @ 3m in 100kHz RBW:	105	dBµV/m
Limit for emissions outside of restricted bands:	85	dBµV/m

Limit is -20dBc (Peak power measurement)



Client:	Intel Corporation	Job Number:	J84365
Model:	Intel® Centrino® Advanced-N 6235	T-Log Number:	T80540.2
Contact:	Steve Hackett	Account Manager:	Christine Krebill
Standard:	FCC 15.247	Class:	N/A

### Band Edge Signal Field Strength - Direct measurement of field strength

Frequency MHz	Level dB $\mu$ V/m	Pol v/h	15.209 / 15.247		Detector PK/QP/Avg	Azimuth degrees	Height meters	Comments
			Limit	Margin				
2388.070	47.5	H	54.0	-6.5	AVG	1	1.0	RB 1 MHz;VB 10 Hz;Pk
2388.040	58.7	H	74.0	-15.3	PK	1	1.0	RB 1 MHz;VB 3 MHz;Pk
2387.140	47.5	V	54.0	-6.5	AVG	216	1.0	RB 1 MHz;VB 10 Hz;Pk
2388.400	58.7	V	74.0	-15.3	PK	216	1.0	RB 1 MHz;VB 3 MHz;Pk

RB 1 MHz; VB 10 Hz, BE @ 2390 MHz, Blue Trace = PK, Black Trace = Avg, Horizontal

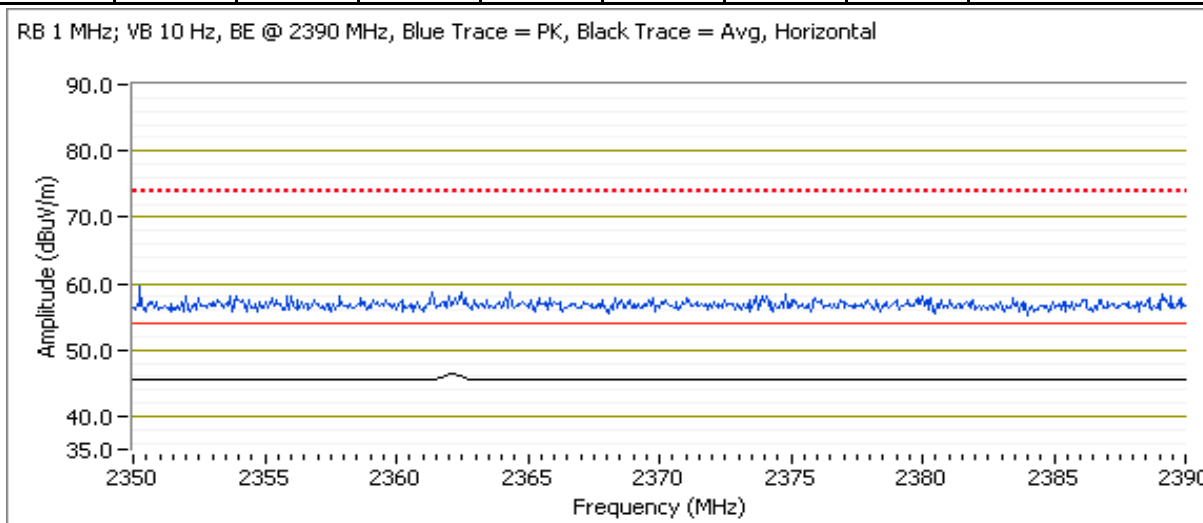

Client:	Intel Corporation	Job Number:	J84365
Model:	Intel® Centrino® Advanced-N 6235	T-Log Number:	T80540.2
Contact:	Steve Hackett	Account Manager:	Christine Krebill
Standard:	FCC 15.247	Class:	N/A

**Other Spurious Emissions**

Frequency MHz	Level dB $\mu$ V/m	Pol v/h	15.209 / 15.247		Detector PK/QP/Avg	Azimuth degrees	Height meters	Comments
			Limit	Margin				
4803.940	45.8	H	54.0	-8.2	AVG	83	1.1	RB 1 MHz;VB 10 Hz;Pk
4803.690	50.6	H	74.0	-23.4	PK	83	1.1	RB 1 MHz;VB 3 MHz;Pk
7206.000	47.7	V	70.0	-22.3	Peak	202	1.3	

Note 1: For emissions in restricted bands, the limit of 15.209 was used. For all other emissions, the limit was set 20dB below the level of the fundamental and measured in 100kHz.

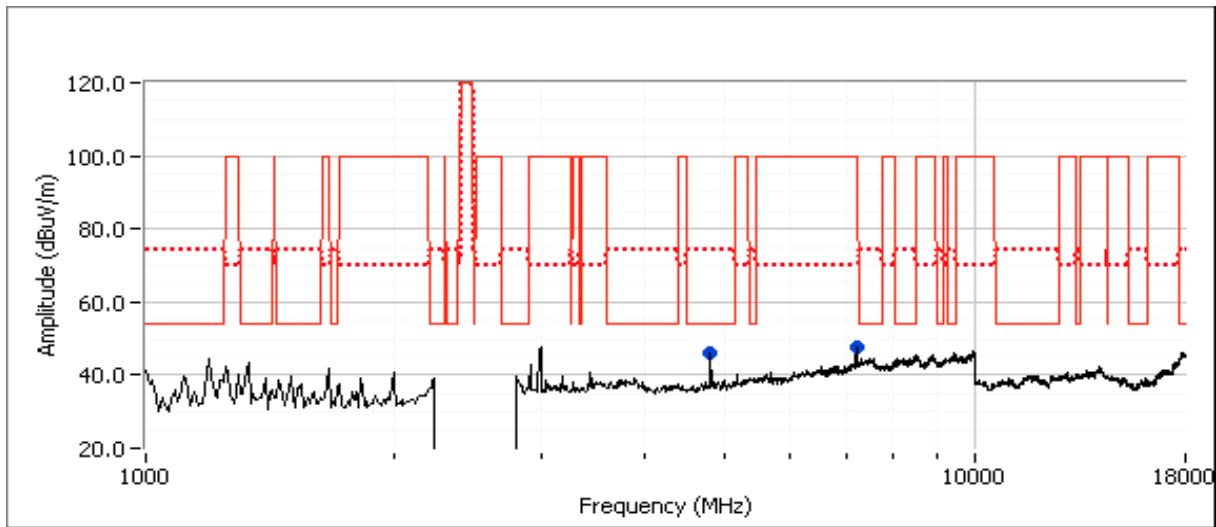

Client:	Intel Corporation	Job Number:	J84365
Model:	Intel® Centrino® Advanced-N 6235	T-Log Number:	T80540.2
Contact:	Steve Hackett	Account Manager:	Christine Krebill
Standard:	FCC 15.247	Class:	N/A

**Run #1b: Center Channel @ 2440 MHz**

	Target (dBm)	Power Settings Measured (dBm)	Software Setting
Chain B	7.5	5.8	8.0

**Fundamental Signal Field Strength:** Peak value measured in 100kHz

Frequency	Level	Pol	15.209 / 15.247		Detector	Azimuth	Height	Comments
MHz	dB $\mu$ V/m	v/h	Limit	Margin	PK/QP/Avg	degrees	meters	
2440.000	101.4	V	-	-	PK	216	1.3	RB 100 kHz;VB 100 kHz;Pk
2440.070	104.9	H	-	-	PK	232	1.0	RB 100 kHz;VB 100 kHz;Pk

Fundamental emission level @ 3m in 100kHz RBW:	104.9	dB $\mu$ V/m
Limit for emissions outside of restricted bands:	84.9	dB $\mu$ V/m

Limit is -20dBc (Peak power measurement)

Frequency	Level	Pol	15.209 / 15.247		Detector	Azimuth	Height	Comments
MHz	dB $\mu$ V/m	v/h	Limit	Margin	PK/QP/Avg	degrees	meters	
7319.910	48.2	V	54.0	-5.8	AVG	188	1.2	RB 1 MHz;VB 10 Hz;Pk
7320.430	55.5	V	74.0	-18.5	PK	188	1.2	RB 1 MHz;VB 3 MHz;Pk
4880.000	46.0	V	54.0	-8.0	AVG	184	1.0	RB 1 MHz;VB 10 Hz;Pk
4879.630	51.2	V	74.0	-22.8	PK	184	1.0	RB 1 MHz;VB 3 MHz;Pk

Note 1: For emissions in restricted bands, the limit of 15.209 was used. For all other emissions, the limit was set 20dB below the level of the fundamental and measured in 100kHz.

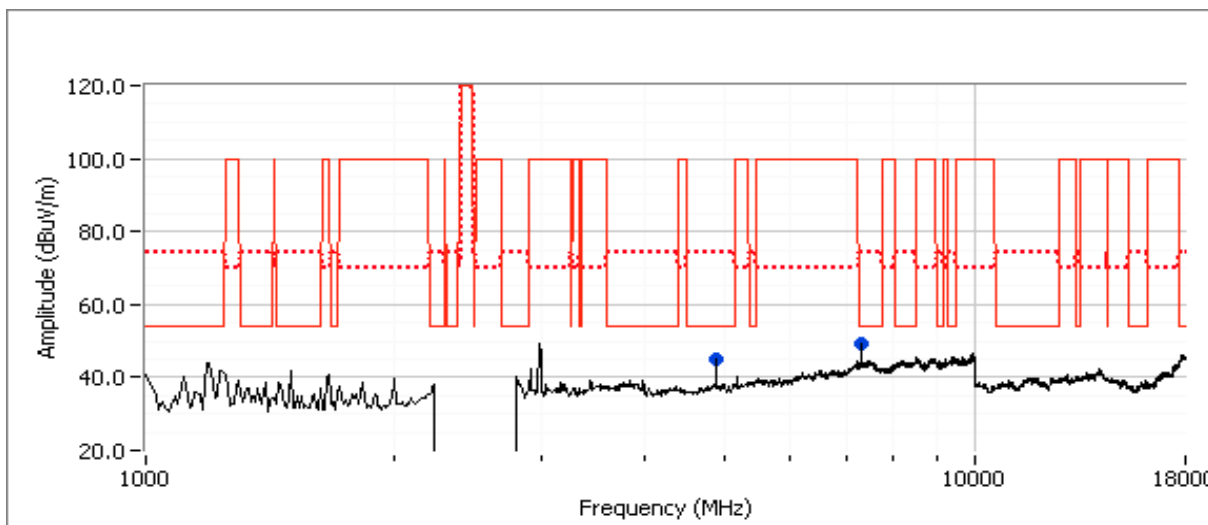

Client:	Intel Corporation	Job Number:	J84365
Model:	Intel® Centrino® Advanced-N 6235	T-Log Number:	T80540.2
Contact:	Steve Hackett	Account Manager:	Christine Krebill
Standard:	FCC 15.247	Class:	N/A

### Run #1c: High Channel @ 2480 MHz

	Target (dBm)	Power Settings Measured (dBm)	Software Setting
Chain B	7.5	5.5	8.0

### Fundamental Signal Field Strength: Peak value measured in 100kHz

Frequency	Level	Pol	15.209 / 15.247		Detector	Azimuth	Height	Comments
MHz	dB $\mu$ V/m	v/h	Limit	Margin	Pk/QP/Avg	degrees	meters	
2480.170	98.6	V	-	-	PK	66	1.0	RB 100 kHz;VB 100 kHz;Pk
2480.000	102.8	H	-	-	PK	218	1.0	RB 100 kHz;VB 100 kHz;Pk

Fundamental emission level @ 3m in 100kHz RBW:	102.8	dB $\mu$ V/m
Limit for emissions outside of restricted bands:	82.8	dB $\mu$ V/m

Limit is -20dBc (Peak power measurement)

### Band Edge Signal Field Strength - Direct measurement of field strength

Frequency	Level	Pol	15.209 / 15.247		Detector	Azimuth	Height	Comments
MHz	dB $\mu$ V/m	v/h	Limit	Margin	Pk/QP/Avg	degrees	meters	
2483.500	49.2	H	54.0	-4.8	AVG	81	1.1	RB 1 MHz;VB 10 Hz;Pk
2483.540	59.9	H	74.0	-14.1	PK	81	1.1	RB 1 MHz;VB 3 MHz;Pk
2483.520	48.7	V	54.0	-5.3	AVG	217	1.2	RB 1 MHz;VB 10 Hz;Pk
2483.660	60.3	V	74.0	-13.7	PK	217	1.2	RB 1 MHz;VB 3 MHz;Pk

RB 1 MHz; VB 10 Hz, BE @ 2483.5 MHz, Blue Trace = PK, Black Trace = Avg, Horizontal

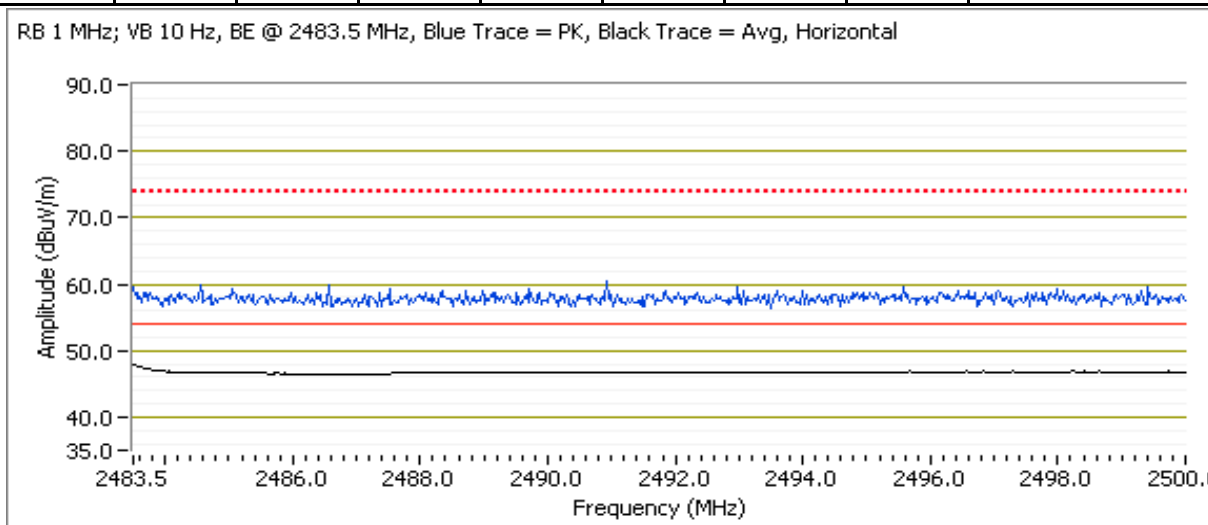

Client:	Intel Corporation	Job Number:	J84365
Model:	Intel® Centrino® Advanced-N 6235	T-Log Number:	T80540.2
Contact:	Steve Hackett	Account Manager:	Christine Krebill
Standard:	FCC 15.247	Class:	N/A

### Other Spurious Emissions

Frequency MHz	Level dB $\mu$ V/m	Pol v/h	15.209 / 15.247		Detector PK/QP/Avg	Azimuth degrees	Height meters	Comments
			Limit	Margin				
7440.000	48.0	V	54.0	-6.0	AVG	214	1.3	RB 1 MHz;VB 10 Hz;Pk
7439.390	55.1	V	74.0	-18.9	PK	214	1.3	RB 1 MHz;VB 3 MHz;Pk
4959.970	44.6	V	54.0	-9.4	AVG	315	1.1	RB 1 MHz;VB 10 Hz;Pk
4959.670	50.0	V	74.0	-24.0	PK	315	1.1	RB 1 MHz;VB 3 MHz;Pk

Note 1: For emissions in restricted bands, the limit of 15.209 was used. For all other emissions, the limit was set 20dB below the level of the fundamental and measured in 100kHz.

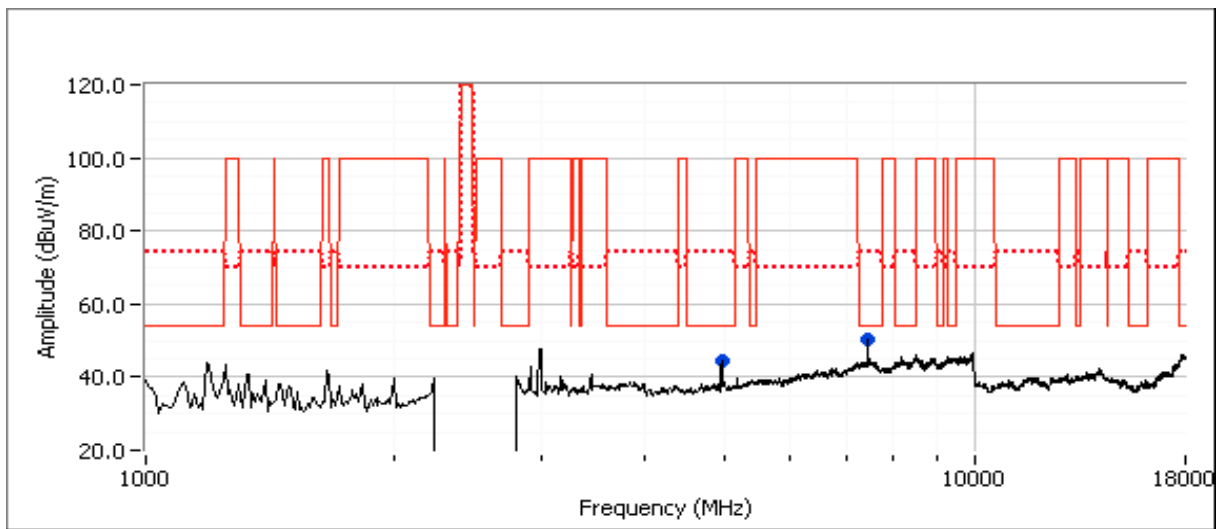

Client:	Intel Corporation	Job Number:	J84365
Model:	Intel® Centrino® Advanced-N 6235	T-Log Number:	T80540.2
Contact:	Steve Hackett	Account Manager:	Christine Krebill
Standard:	FCC 15.247	Class:	N/A

**Run #2: Radiated Spurious Emissions, 1000-26000 MHz. Operating Mode: EDR (3Mb/s)**

Date of Test: 9/20/2010  
 Test Engineer: Rafael Varelas  
 Test Location: FT Chamber #7

**Run #2a: Low Channel @ 2402 MHz**

	Target (dBm)	Power Settings Measured (dBm)	Software Setting
Chain B	7.5	-0.8	8.0

**Fundamental Signal Field Strength: Peak value measured in 100kHz**

Frequency	Level	Pol	15.209 / 15.247		Detector	Azimuth	Height	Comments
MHz	dB $\mu$ V/m	v/h	Limit	Margin	Pk/QP/Avg	degrees	meters	
2402.090	97.9	V	-	-	PK	201	1.0	RB 100 kHz;VB 100 kHz;Pk
2402.180	100.9	H	-	-	PK	211	1.0	RB 100 kHz;VB 100 kHz;Pk

Fundamental emission level @ 3m in 100kHz RBW:	100.9	dB $\mu$ V/m
Limit for emissions outside of restricted bands:	80.9	dB $\mu$ V/m

Limit is -20dBc (Peak power measurement)

**Band Edge Signal Field Strength - Direct measurement of field strength**

Frequency	Level	Pol	15.209 / 15.247		Detector	Azimuth	Height	Comments
MHz	dB $\mu$ V/m	v/h	Limit	Margin	Pk/QP/Avg	degrees	meters	
2388.040	47.5	H	54.0	-6.5	AVG	212	1.0	RB 1 MHz;VB 10 Hz;Pk
2387.170	59.0	H	74.0	-15.0	PK	212	1.0	RB 1 MHz;VB 3 MHz;Pk
2387.690	47.5	V	54.0	-6.5	AVG	202	1.0	RB 1 MHz;VB 10 Hz;Pk
2389.560	59.0	V	74.0	-15.0	PK	202	1.0	RB 1 MHz;VB 3 MHz;Pk

RB 1 MHz; VB 10 Hz, BE @ 2390 MHz, Blue Trace = PK, Black Trace = Avg, Horizontal

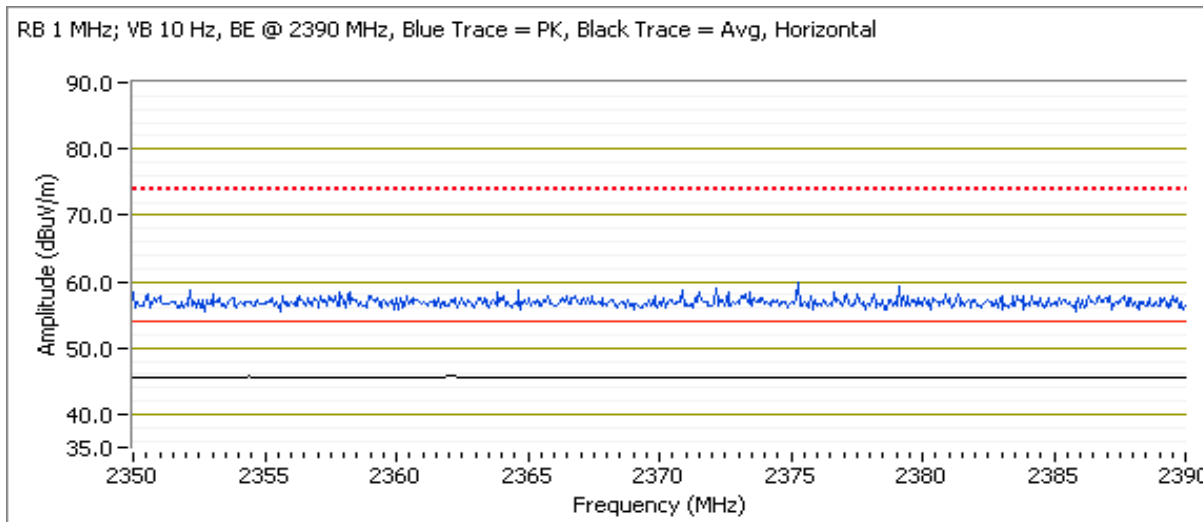

Client:	Intel Corporation	Job Number:	J84365
Model:	Intel® Centrino® Advanced-N 6235	T-Log Number:	T80540.2
Contact:	Steve Hackett	Account Manager:	Christine Krebill
Standard:	FCC 15.247	Class:	N/A

### Other Spurious Emissions

Frequency	Level	Pol	15.209 / 15.247		Detector	Azimuth	Height	Comments
MHz	dB $\mu$ V/m	v/h	Limit	Margin	PK/QP/Avg	degrees	meters	
4804.050	39.1	H	54.0	-14.9	AVG	83	1.0	RB 1 MHz;VB 10 Hz;Pk
4803.960	47.9	H	74.0	-26.1	PK	83	1.0	RB 1 MHz;VB 3 MHz;Pk

Note 1: For emissions in restricted bands, the limit of 15.209 was used. For all other emissions, the limit was set 20dB below the level of the fundamental and measured in 100kHz.

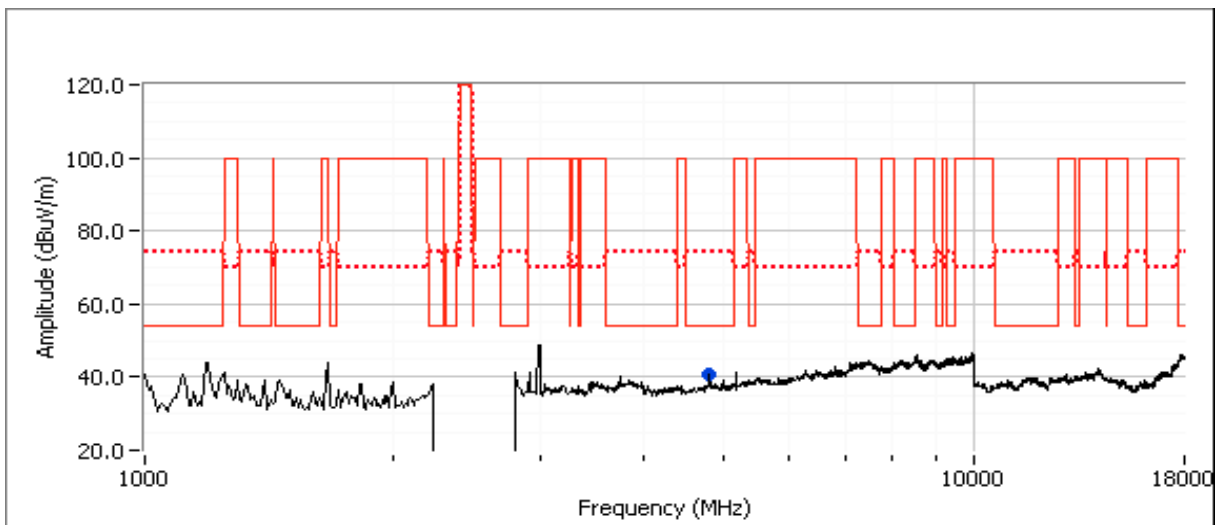

Client:	Intel Corporation	Job Number:	J84365
Model:	Intel® Centrino® Advanced-N 6235	T-Log Number:	T80540.2
Contact:	Steve Hackett	Account Manager:	Christine Krebill
Standard:	FCC 15.247	Class:	N/A

**Run #2b: Center Channel @ 2440 MHz**

Date of Test: 9/21/2010  
 Test Engineer: David Bare  
 Test Location: FT Chamber #4

	Target (dBm)	Power Settings Measured (dBm)	Software Setting
Chain B	7.5	1.8	8.0

**Fundamental Signal Field Strength:** Peak value measured in 100kHz

Frequency	Level	Pol	15.209 / 15.247		Detector	Azimuth	Height	Comments
MHz	dB $\mu$ V/m	v/h	Limit	Margin	Pk/QP/Avg	degrees	meters	
2440.100	99.1	V	-	-	PK	198	1.0	RB 100 kHz;VB 100 kHz;Pk
2440.010	101.7	H	-	-	PK	210	1.0	RB 100 kHz;VB 100 kHz;Pk

Fundamental emission level @ 3m in 100kHz RBW:	101.7	dB $\mu$ V/m
Limit for emissions outside of restricted bands:	81.7	dB $\mu$ V/m

Limit is -20dBc (Peak power measurement)

Frequency	Level	Pol	15.209 / 15.247		Detector	Azimuth	Height	Comments
MHz	dB $\mu$ V/m	v/h	Limit	Margin	Pk/QP/Avg	degrees	meters	
4879.970	40.5	H	54.0	-13.5	AVG	56	1.3	RB 1 MHz;VB 10 Hz;Pk
4880.340	49.0	H	74.0	-25.0	PK	56	1.3	RB 1 MHz;VB 3 MHz;Pk

Note 1: For emissions in restricted bands, the limit of 15.209 was used. For all other emissions, the limit was set 20dB below the level of the fundamental and measured in 100kHz.

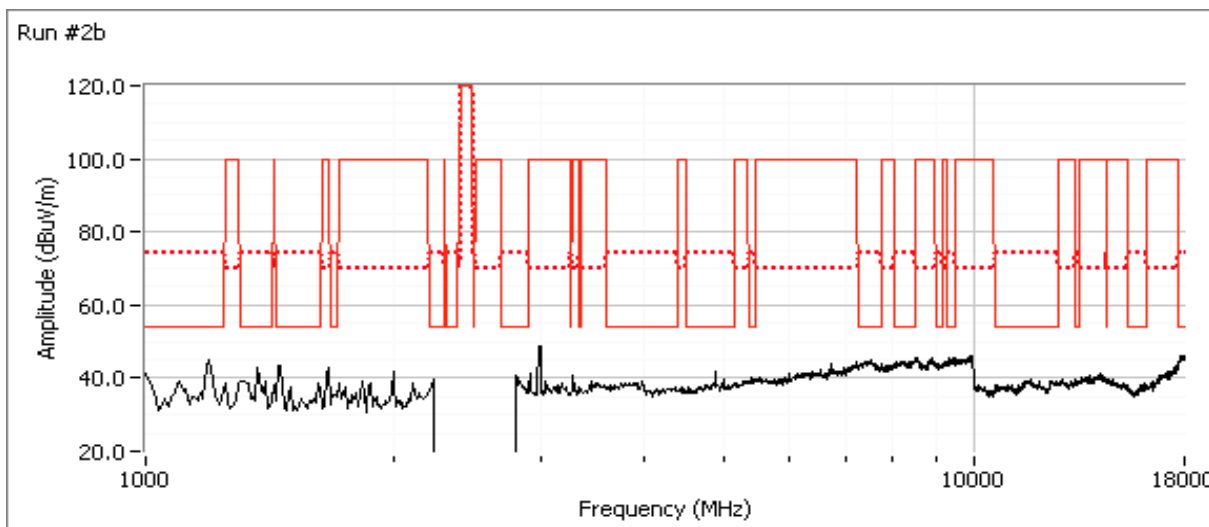



Client:	Intel Corporation	Job Number:	J84365
Model:	Intel® Centrino® Advanced-N 6235	T-Log Number:	T80540.2
Contact:	Steve Hackett	Account Manager:	Christine Krebill
Standard:	FCC 15.247	Class:	N/A

### Run #2c: High Channel @ 2480 MHz

	Target (dBm)	Power Settings Measured (dBm)	Software Setting
Chain B	7.5	1.3	8.0

### Fundamental Signal Field Strength: Peak value measured in 100kHz

Frequency	Level	Pol	15.209 / 15.247		Detector	Azimuth	Height	Comments
MHz	dB $\mu$ V/m	v/h	Limit	Margin	Pk/QP/Avg	degrees	meters	
2480.140	98.1	V	-	-	PK	195	1.0	RB 100 kHz;VB 100 kHz;Pk
2479.870	102.1	H	-	-	PK	207	1.0	RB 100 kHz;VB 100 kHz;Pk

Fundamental emission level @ 3m in 100kHz RBW:	102.1	dB $\mu$ V/m
Limit for emissions outside of restricted bands:	82.1	dB $\mu$ V/m

Limit is -20dBc (Peak power measurement)

### Band Edge Signal Field Strength - Direct measurement of field strength

Frequency	Level	Pol	15.209 / 15.247		Detector	Azimuth	Height	Comments
MHz	dB $\mu$ V/m	v/h	Limit	Margin	Pk/QP/Avg	degrees	meters	
2483.500	51.2	H	54.0	-2.8	AVG	208	1.0	RB 1 MHz;VB 10 Hz;Pk
2483.640	62.2	H	74.0	-11.8	PK	208	1.0	RB 1 MHz;VB 3 MHz;Pk
2483.500	51.3	V	54.0	-2.7	AVG	205	1.0	RB 1 MHz;VB 10 Hz;Pk
2483.770	60.6	V	74.0	-13.4	PK	205	1.0	RB 1 MHz;VB 3 MHz;Pk

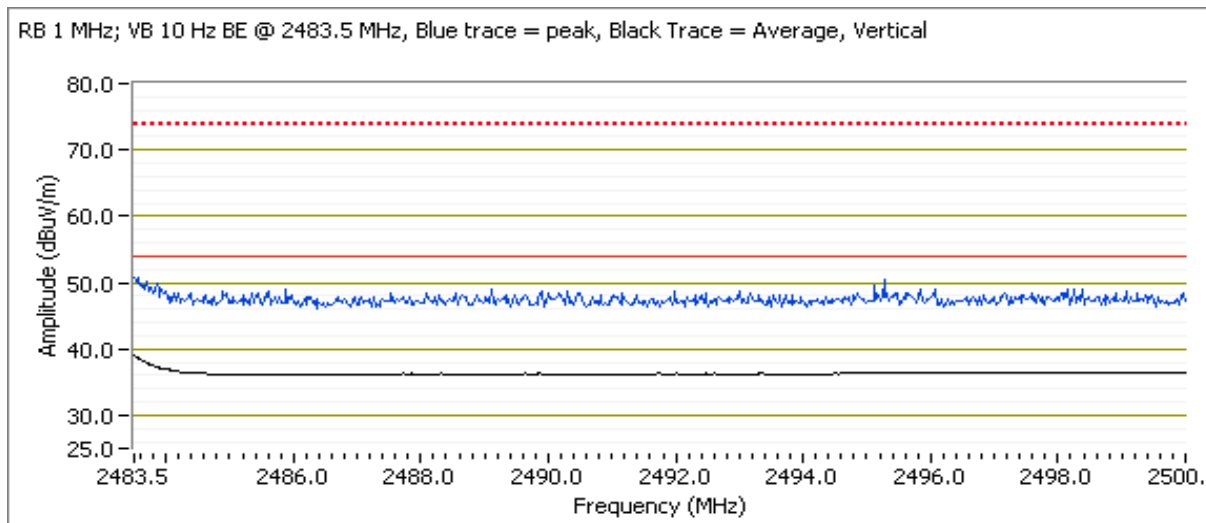

Note: Plot includes a 10.5dB offset for distance that was incorrectly applied for the bandedge measurement. Tabular data is correct.

Client:	Intel Corporation	Job Number:	J84365
Model:	Intel® Centrino® Advanced-N 6235	T-Log Number:	T80540.2
Contact:	Steve Hackett	Account Manager:	Christine Krebill
Standard:	FCC 15.247	Class:	N/A

### Other Spurious Emissions

Frequency	Level	Pol	15.209 / 15.247		Detector	Azimuth	Height	Comments
MHz	dB $\mu$ V/m	v/h	Limit	Margin	PK/QP/Avg	degrees	meters	
4960.070	37.8	V	54.0	-16.2	AVG	188	1.0	RB 1 MHz;VB 10 Hz;Pk
4960.140	46.1	V	74.0	-27.9	PK	188	1.0	RB 1 MHz;VB 3 MHz;Pk

Note 1: For emissions in restricted bands, the limit of 15.209 was used. For all other emissions, the limit was set 20dB below the level of the fundamental and measured in 100kHz.

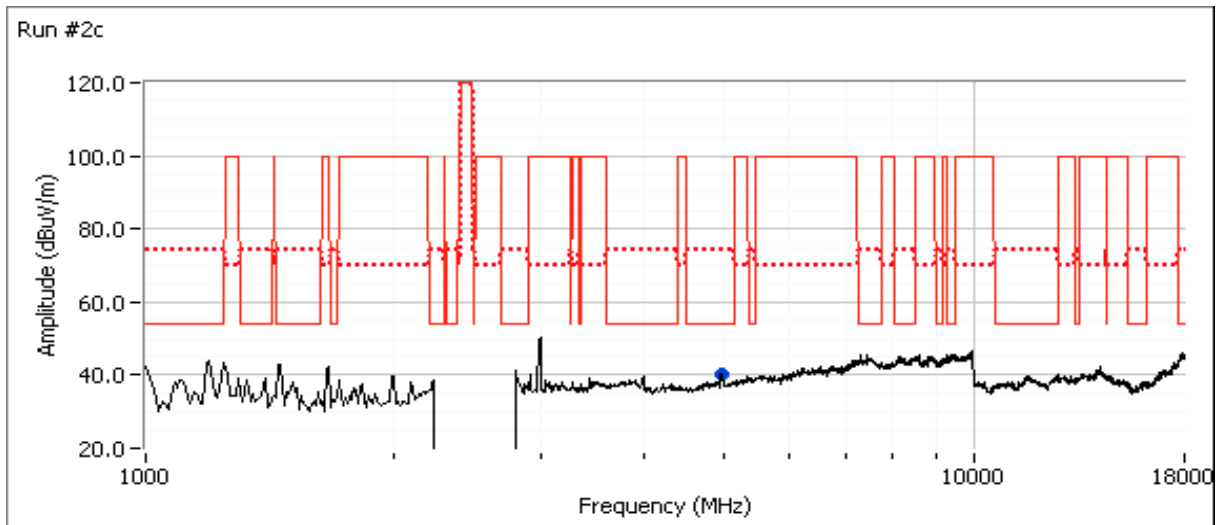

Client:	Intel Corporation	Job Number:	J84365
Model:	Intel® Centrino® Advanced-N 6235	T-Log Number:	T80540.2
Contact:	Steve Hackett	Account Manager:	Christine Krebill
Standard:	FCC 15.247	Class:	N/A

**Run #3: Radiated Emissions Receive Mode, Center Channel @ 2440 MHz**

Date of Test: 9/21/2010  
 Test Engineer: Mark Hill  
 Test Location: FT Chamber #4

Frequency MHz	Level dB $\mu$ V/m	Pol v/h	15.109		Detector Pk/QP/Avg	Azimuth degrees	Height meters	Comments
			Limit	Margin				
2987.890	35.7	H	54.0	-18.3	AVG	99	1.0	RB 1 MHz;VB 10 Hz;Pk
2322.790	33.2	H	54.0	-20.8	AVG	160	1.3	RB 1 MHz;VB 10 Hz;Pk
2990.430	52.7	H	74.0	-21.3	PK	99	1.0	RB 1 MHz;VB 3 MHz;Pk
2328.920	49.4	H	74.0	-24.6	PK	160	1.3	RB 1 MHz;VB 3 MHz;Pk

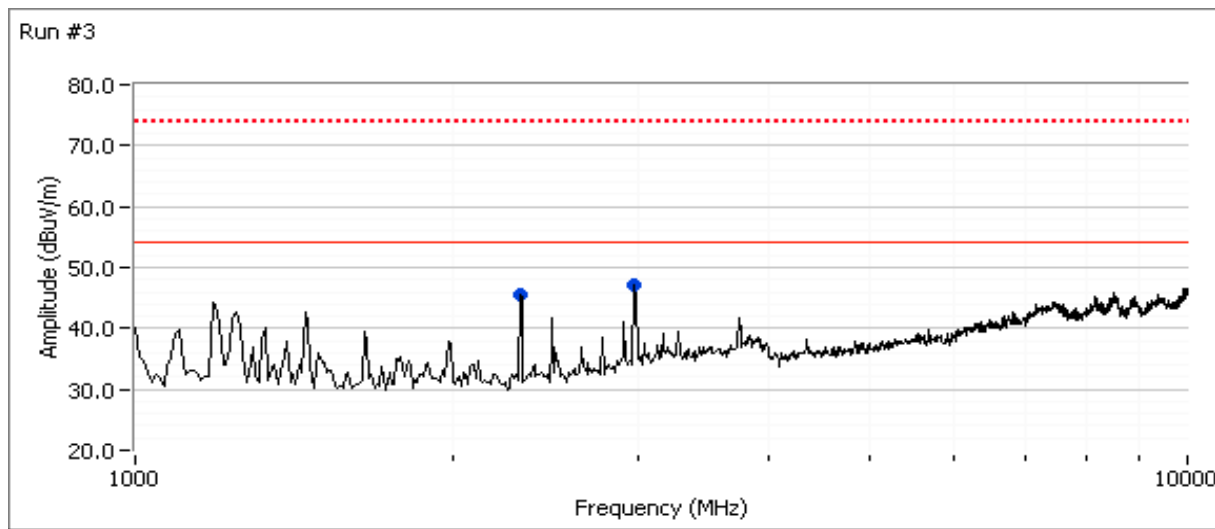

Client:	Intel Corporation	Job Number:	J84365
Model:	Intel® Centrino® Advanced-N 6235	T-Log Number:	T80540.2
Contact:	Steve Hackett	Account Manager:	Christine Krebill
Standard:	FCC 15.247	Class:	N/A

## FCC 15.247 FHSS - Power, Bandwidth and Spurious Emissions

### Test Specific Details

Objective: The objective of this test session is to perform final qualification testing of the EUT with respect to the specification listed above.

Date of Test: 9/28/2010 19:11  
 Test Engineer: Rafael Varelas  
 Test Location: Fremont Chamber #7

Config. Used: 1  
 Config Change: none  
 EUT Voltage: 120V/60Hz

### General Test Configuration

When measuring the conducted emissions from the EUT's antenna port, the antenna port of the EUT was connected to the spectrum analyzer or power meter via a suitable attenuator to prevent overloading the measurement system. All measurements are corrected to allow for the external attenuators used.

Unless stated otherwise the EUT was operating such that it constantly hopped on either the low, center or high channels.

### Ambient Conditions:

Temperature: 21.9 °C  
 Rel. Humidity: 42 %

### Summary of Results

MAC Address: 00150079AD1A DRTU Tool Version 1.2.12-0197 Driver version 14.0.0.39

Run #	Test Performed	Limit	Pass / Fail	Result / Margin
1	Spurious Emissions	FCC Part 15.247(b)	Pass	All emissions below -20dBc
2	Output Power	15.247(b)	Pass	Basic Rate: 6.5 dBm ( 0.004 W) EDR: 4.6 dBm ( 0.003 W)
3	20dB Bandwidth	15.247(a)	Pass	Basic Rate: 1.092 MHz EDR: 1.358 MHz
3	99% bandwidth	15.247(a)	Pass	Basic Rate: 957 kHz EDR: 1.231 MHz
3	Channel Occupancy	15.247(a)	Pass	Complies with Bluetooth protocol
3	Number of Channels	15.247(a)	Pass	20 - 79 channels

### Modifications Made During Testing:

No modifications were made to the EUT during testing

### Deviations From The Standard

No deviations were made from the requirements of the standard.

Client:	Intel Corporation	Job Number:	J84365
Model:	Intel® Centrino® Advanced-N 6235	T-Log Number:	T80540.2
Contact:	Steve Hackett	Account Manager:	Christine Krebill
Standard:	FCC 15.247	Class:	N/A

**Run #1: Antenna Conducted Spurious Emissions, 30 - 26,500 MHz.**

Date of Test: 9/28/2010

Test Engineer: Rafael Varelas

Test Location: FT Chamber #7

Refer to plots below. Scans made using RBW=VB=100 KHz with the limit line set at 20dB below the highest in-band signal level.

**Basic rate (1Mb/s)**

Basic Rate @ 2402 MHz

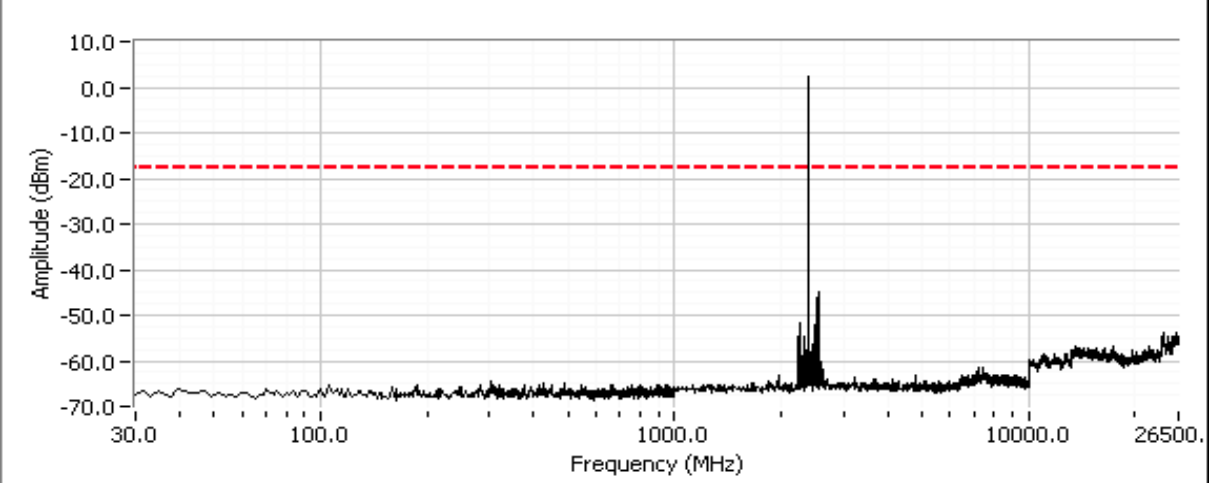

Basic Rate @ 2440 MHz

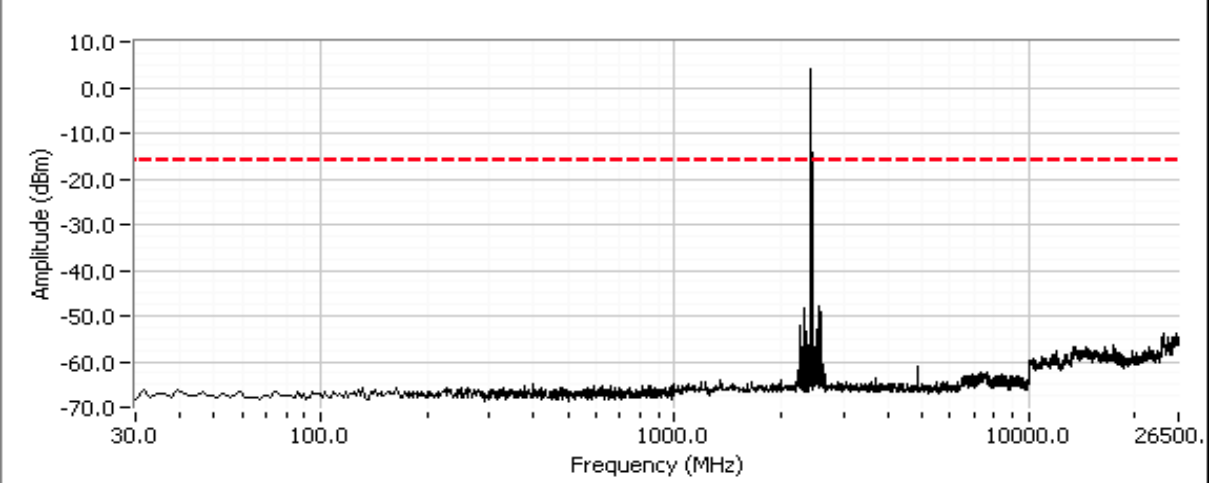

Client:	Intel Corporation	Job Number:	J84365
Model:	Intel® Centrino® Advanced-N 6235	T-Log Number:	T80540.2
Contact:	Steve Hackett	Account Manager:	Christine Krebill
Standard:	FCC 15.247	Class:	N/A

Basic Rate @ 2480 MHz

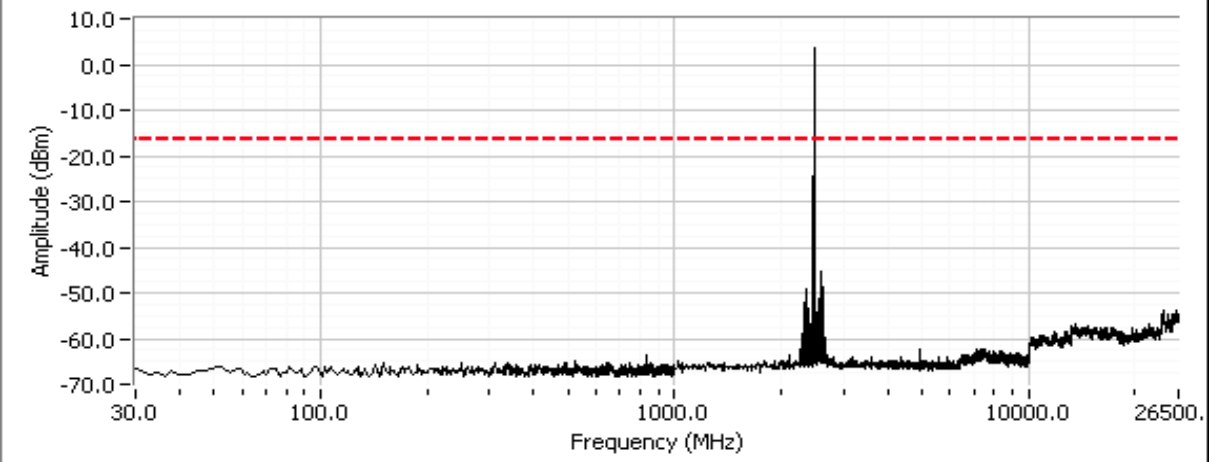

EDR (3Mb/s)

EDR Mode @ 2402 MHz

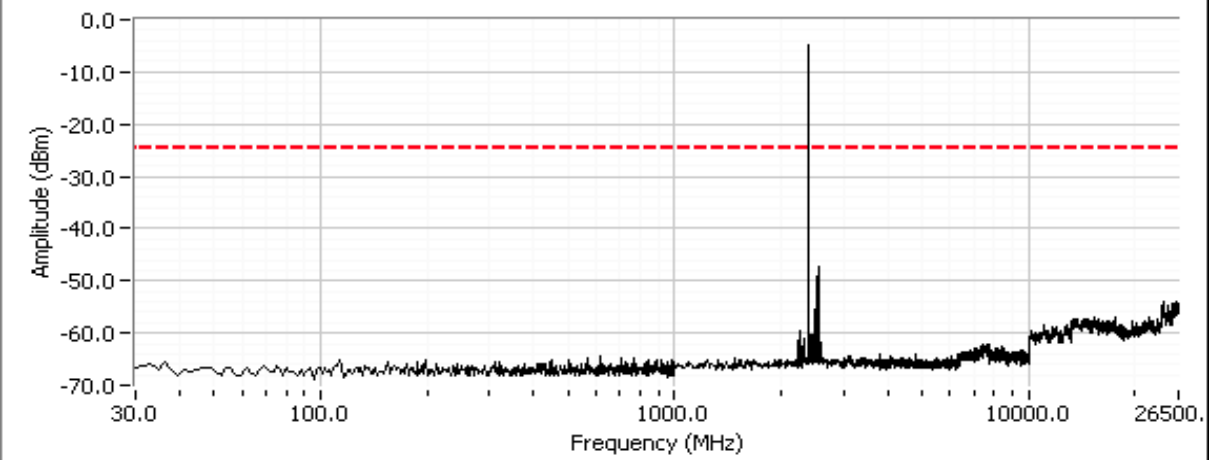

Client:	Intel Corporation	Job Number:	J84365
Model:	Intel® Centrino® Advanced-N 6235	T-Log Number:	T80540.2
Contact:	Steve Hackett	Account Manager:	Christine Krebill
Standard:	FCC 15.247	Class:	N/A

EDR Mode @ 2440 MHz

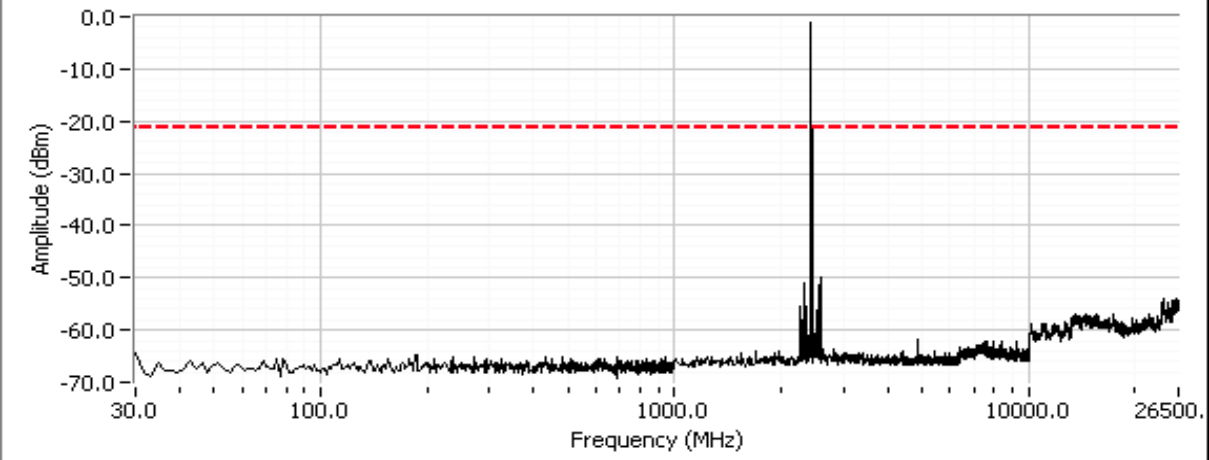

EDR Mode @ 2480 MHz

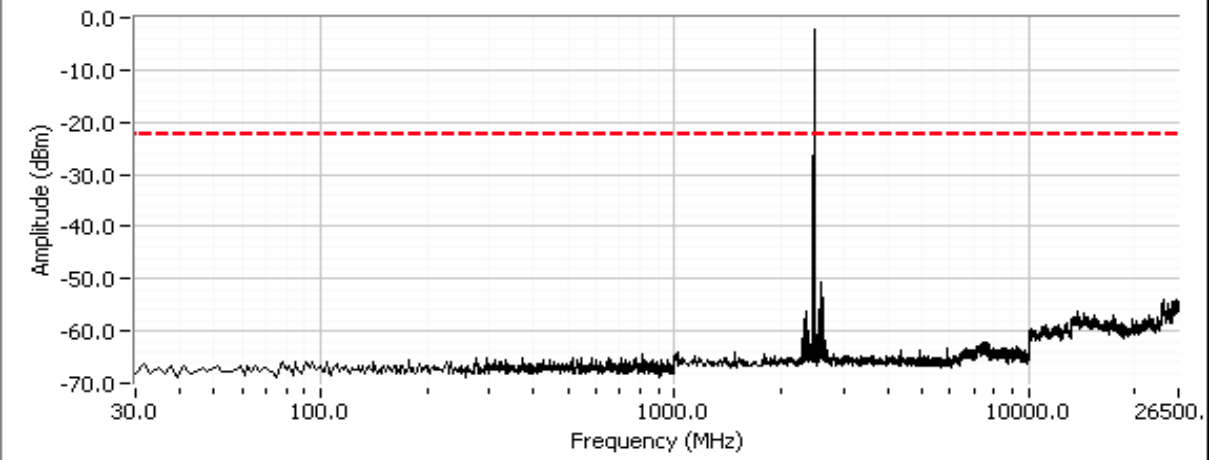

Client:	Intel Corporation	Job Number:	J84365
Model:	Intel® Centrino® Advanced-N 6235	T-Log Number:	T80540.2
		Account Manager:	Christine Krebill
Contact:	Steve Hackett		
Standard:	FCC 15.247	Class:	N/A

**Run #2: Output Power**  
 Date of Test: 9/28/2010  
 Test Engineer: Rafael Varelas  
 Test Location: FT Chamber #7

For frequency hopping systems operating in the 2400-2483.5 MHz band employing less than 75 channels or overlapping hopping channels: 0.125 watts.

Maximum antenna gain:            3.2 dBi

Mode	Frequency (MHz)	Setting	Pavg	Output Power (dBm)	Output Power (W)	EIRP (W)
Basic rate	2402	8	4.6	5.2	0.0033	0.0069
	2440	8	5.8	6.5	0.0044	0.0092
	2480	8	5.6	6.5	0.0044	0.0092
EDR (3Mb/s)	2402	8	-0.2	2.2	0.0017	0.0035
	2440	8	1.9	4.6	0.0029	0.0060
	2480	8	1.2	4.1	0.0026	0.0054

- Note 1: Output power is measured as a peak power using either a peak power meter or with a spectrum analyzer and VB > 3 x RB and RB > 20dB bandwidth. The actual method used was a peak power meter.
- Note 2: Setting is the test utility software setting and used for reference only. Pavg is the average output power measured with an average power meter and is provided for reference only.



Client:	Intel Corporation	Job Number:	J84365
Model:	Intel® Centrino® Advanced-N 6235	T-Log Number:	T80540.2
Contact:	Steve Hackett	Account Manager:	Christine Krebill
Standard:	FCC 15.247	Class:	N/A

**Run #3: Bandwidth and Channel Spacing**

Date of Test: 9/28/2010  
 Test Engineer: Rafael Varelas  
 Test Location: FT Chamber #7

**Bandwidth**

Mode	Frequency (MHz)	20dB Bandwidth (kHz)	99% Bandwidth (kHz)
Basic rate	2402	1072	957
	2440	1092	957
	2480	1083	957
EDR (3Mb/s)	2402	1350	1231
	2440	1358	1231
	2480	1350	1231

Note 1: 20dB bandwidth measured using RB = 100kHz, VB = 300kHz (VB > RB)

Note 2: 99% bandwidth measured using RB = 100kHz, VB = 300kHz (VB >= 3RB)

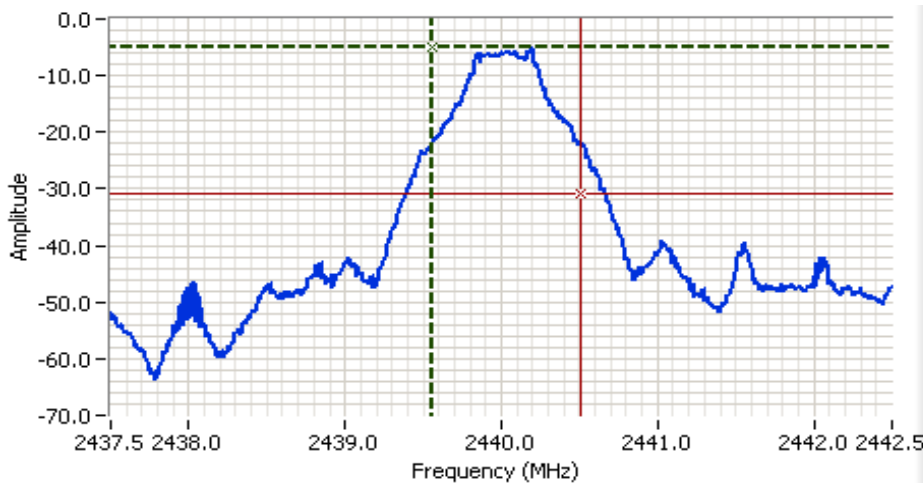

**Analyzer Settings**

HP8564E,EMICF: 2440.000  
 MHz  
 SPAN: 5.000 MHz  
 RB: 100 kHz  
 VB: 300 kHz  
 Detector: POS  
 Attn: 10 DB  
 RL Offset: 0.0 DB  
 Sweep Time: 50.0ms  
 Ref Lvl: -2.0 DBM

**Comments**

99% BW: 957 kHz  
 Basic Rate

Cursor 1	2439.5549	-5.00	+	-	+	-	Delta Freq.	957 kHz
Cursor 2	2440.5116	-31.00	+	-	+	-	Delta Amplitude	26.00



Client:	Intel Corporation	Job Number:	J84365
Model:	Intel® Centrino® Advanced-N 6235	T-Log Number:	T80540.2
Contact:	Steve Hackett	Account Manager:	Christine Krebill
Standard:	FCC 15.247	Class:	N/A

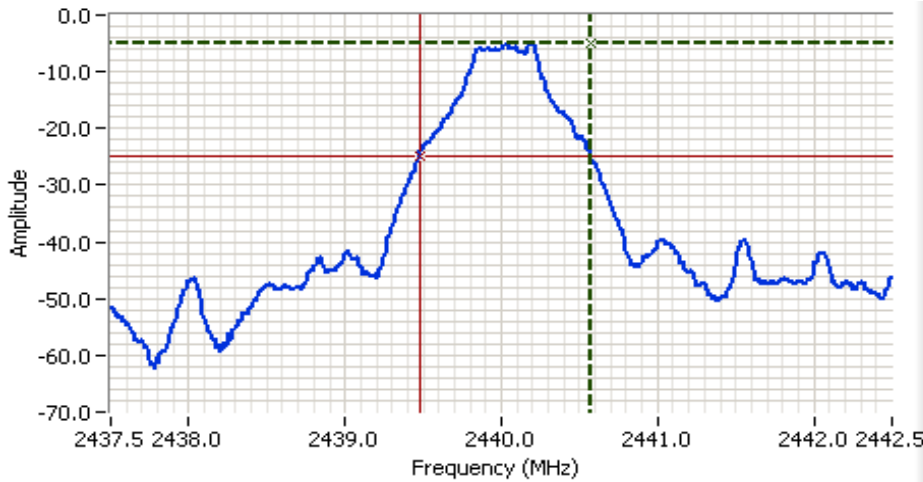

**Analyzer Settings**  
 HP8564E,EMICF: 2440.000 MHz  
 SPAN: 5.000 MHz  
 RB: 100 kHz  
 VB: 300 kHz  
 Detector: POS  
 Attn: 10 DB  
 RL Offset: 0.0 DB  
 Sweep Time: 50.0ms  
 Ref Lvl: -2.0 DBM

**Comments**  
 20dB BW: 1.092 MHz  
 Basic Rate

Cursor 1 2440.5667 -4.83  
 Cursor 2 2439.4750 -24.83

Delta Freq. 1.092  
 Delta Amplitude 20.00

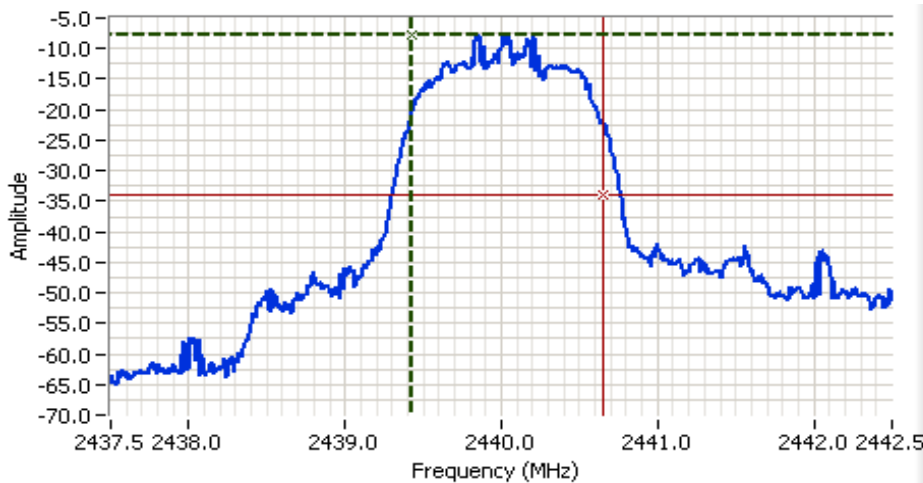

**Analyzer Settings**  
 HP8564E,EMICF: 2440.000 MHz  
 SPAN: 5.000 MHz  
 RB: 100 kHz  
 VB: 300 kHz  
 Detector: POS  
 Attn: 10 DB  
 RL Offset: 0.0 DB  
 Sweep Time: 50.0ms  
 Ref Lvl: -2.0 DBM

**Comments**  
 99% BW: 1.231 MHz  
 EDR Mode

Cursor 1 2439.4218 -7.83  
 Cursor 2 2440.6531 -33.83

Delta Freq. 1.231  
 Delta Amplitude 26.00



Client:	Intel Corporation	Job Number:	J84365
Model:	Intel® Centrino® Advanced-N 6235	T-Log Number:	T80540.2
Contact:	Steve Hackett	Account Manager:	Christine Krebill
Standard:	FCC 15.247	Class:	N/A

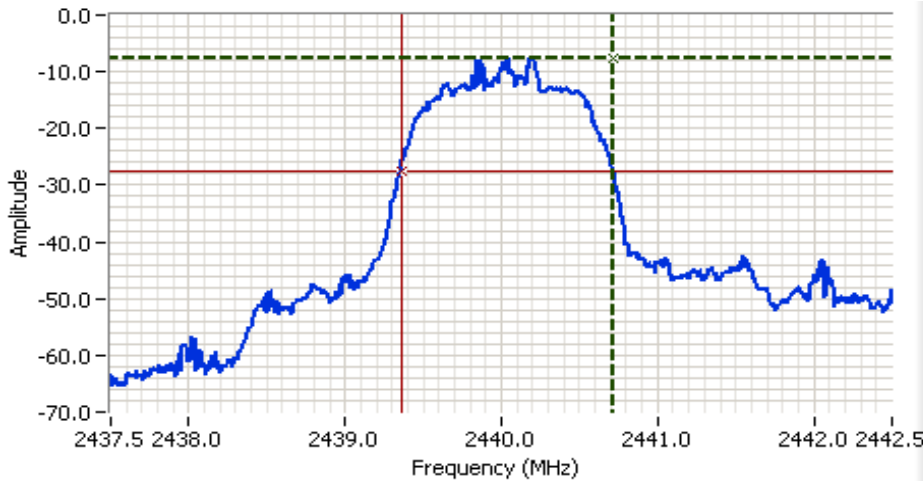

**Analyzer Settings**  
 HP8564E,EMICF: 2440.000 MHz  
 SPAN: 5.000 MHz  
 RB: 100 kHz  
 VB: 300 kHz  
 Detector: POS  
 Attn: 10 DB  
 RL Offset: 0.0 DB  
 Sweep Time: 50.0ms  
 Ref Lvl: -2.0 DBM

**Comments**  
 20dB BW: 1.358 MHz  
 EDR Mode

Cursor 1 2440.7167 -7.50  Delta Freq. 1.358  
 Cursor 2 2439.3583 -27.50  Delta Amplitude 20.00



### Channel Spacing / Number of Channels

The channel spacing is 1MHz with a minimum of 20 channels and a maximum of 79 channels used. See plots below showing all 79 channels, with first channel at 2402 Mhz and last channel at 2480 MHz

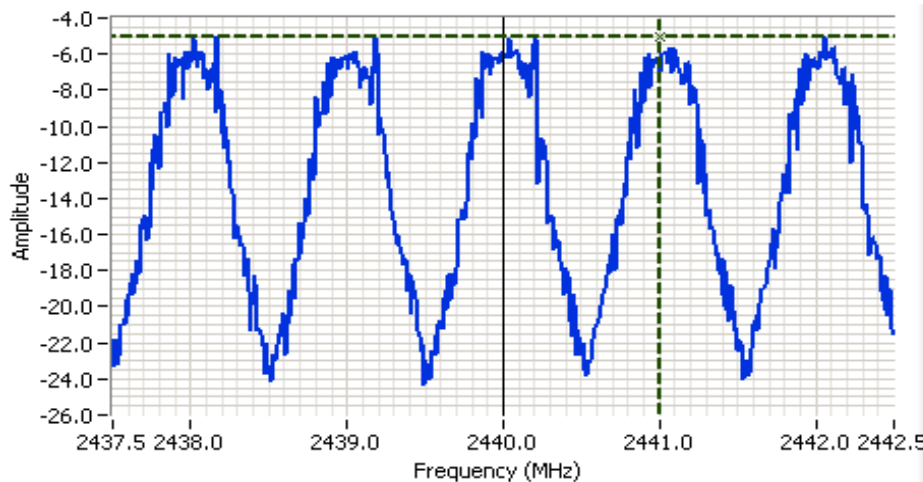

**Analyzer Settings**  
 HP8564E,EMICF: 2440.000 MHz  
 SPAN: 5.000 MHz  
 RB: 100 kHz  
 VB: 300 kHz  
 Detector: POS  
 Attn: 10 DB  
 RL Offset: 0.0 DB  
 Sweep Time: 50.0ms  
 Ref Lvl: -2.0 DBM

**Comments**  
 Channel Spacing 1 MHz

Cursor 1 2441.0000 -5.00  Delta Freq. 1.000  
 Cursor 1 2440.0000 0.00  Delta Amplitude 5.00



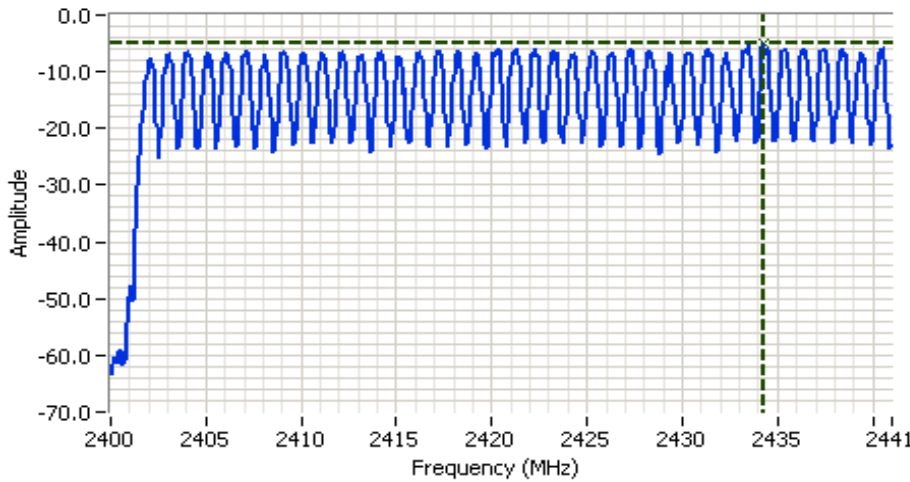

Client:	Intel Corporation	Job Number:	J84365
Model:	Intel® Centrino® Advanced-N 6235	T-Log Number:	T80540.2
Contact:	Steve Hackett	Account Manager:	Christine Krebill
Standard:	FCC 15.247	Class:	N/A



**Analyzer Settings**  
 HP8564E,EMICF: 2420.500 MHz  
 SPAN: 41.000 MHz  
 RB: 100 kHz  
 VB: 300 kHz  
 Detector: POS  
 Attn: 10 DB  
 RL Offset: 0.0 DB  
 Sweep Time: 50.0ms  
 Ref Lvl: -2.0 DBM

**Comments**  
 Basic Rate  
 2400-2441 MHz  
 39 Channels

Cursor 1 2434.2350 -5.00 

0.0000 0.00 

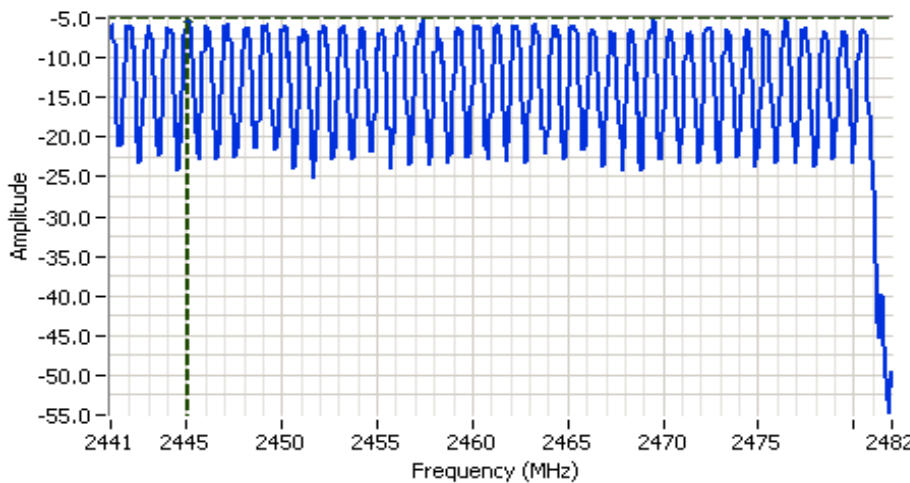

**Analyzer Settings**  
 HP8564E,EMICF: 2461.500 MHz  
 SPAN: 41.000 MHz  
 RB: 100 kHz  
 VB: 300 kHz  
 Detector: POS  
 Attn: 10 DB  
 RL Offset: 0.0 DB  
 Sweep Time: 50.0ms  
 Ref Lvl: -2.0 DBM

**Comments**  
 Basic Rate  
 2441-2482 MHz  
 40 Channels

Cursor 1 2445.1000 -5.00 

0.0000 0.00 



Client:	Intel Corporation	Job Number:	J84365
Model:	Intel® Centrino® Advanced-N 6235	T-Log Number:	T80540.2
Contact:	Steve Hackett	Account Manager:	Christine Krebill
Standard:	FCC 15.247	Class:	N/A

**Run #4: Channel Occupancy and Number of Channels**

**Requirement:** Frequency hopping systems in the 2400-2483.5 MHz band shall use at least 15 channels.

The average time of occupancy on any channel shall not be greater than 0.4 seconds within a period of 0.4 seconds multiplied by the number of hopping channels employed. (Frequency hopping systems may avoid or suppress transmissions on a particular hopping frequency provided that a minimum of 15 channels are used.)

The device complies with the Bluetooth protocol and employs a minimum of 20 of the available 79 hopping channels when employing adaptive frequency hopping and all 79 channels when not. Channels are selected in a pseudo random manner to ensure, on average, all channels are used equally.

The hopping rate is 1600 hops per second although any one channel may be used for a single hop slot, 3 hop slots or 5 hop slots. The dwell time per channel is, therefore either 0.625ms (single slot), 1.875ms (three slot) or 3.125ms (five slot). The average time of occupancy will not exceed 0.4s in any time interval of 0.4s multiplied by the number of channels being used.

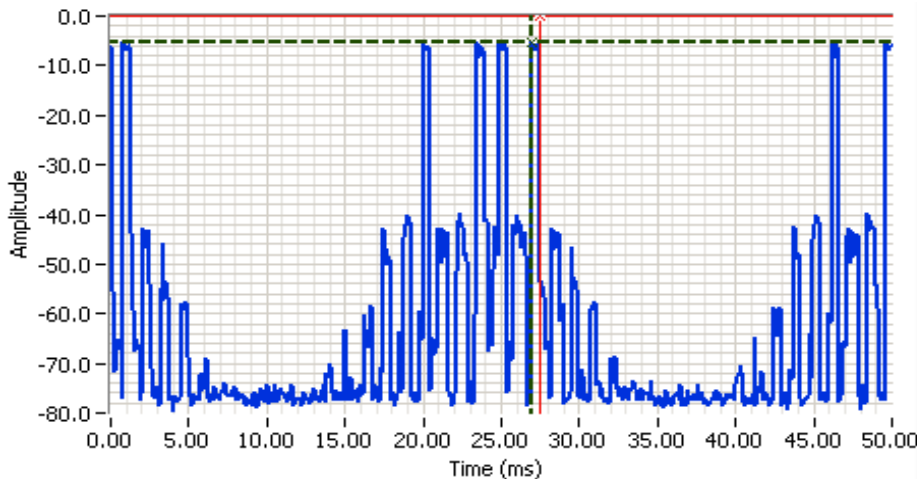

**Analyzer Settings**

HP8564E,EMICF: 2440.000 MHz
SPAN: 0.000 MHz
RB: 100 kHz
VB: 300 kHz
Detector: POS
Attn: 10 DB
RL Offset: 0.0 DB
Sweep Time: 50.0ms
Ref Lvl: -2.0 DBM

**Comments**

Basic Rate Mode  
DH1 Packets

Cursor 1	26.9531	-5.17	+	-	Delta Time (ms)	0.52
Cursor 1	27.4740	0.00	+	-	Delta Amplitude	5.17



Client:	Intel Corporation	Job Number:	J84365
Model:	Intel® Centrino® Advanced-N 6235	T-Log Number:	T80540.2
Contact:	Steve Hackett	Account Manager:	Christine Krebill
Standard:	FCC 15.247	Class:	N/A

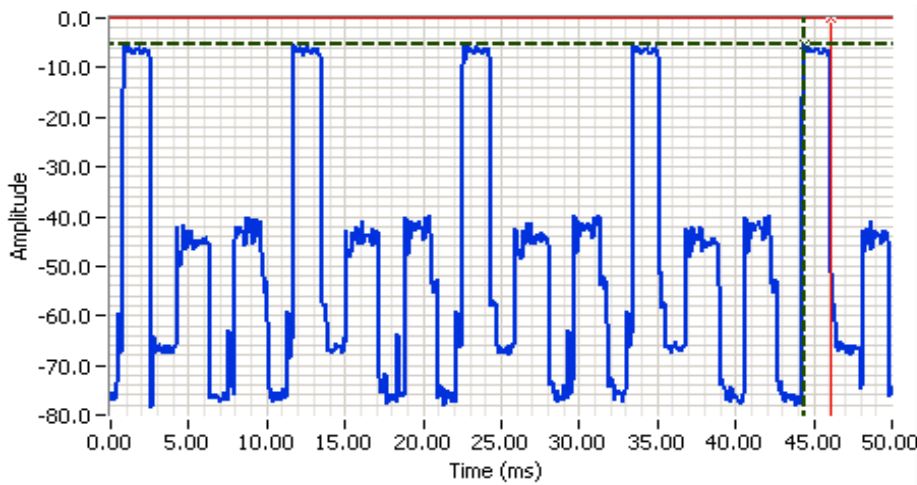

**Analyzer Settings**  
 HP8564E,EMICF: 2440.000 MHz  
 SPAN: 0.000 MHz  
 RB: 100 kHz  
 VB: 300 kHz  
 Detector: POS  
 Attn: 10 DB  
 RL Offset: 0.0 DB  
 Sweep Time: 50.0ms  
 Ref Lvl: -2.0 DBM

**Comments**  
 Basic Rate Mode  
 DH3 Packets

Cursor 1 44.4167 -5.17  Delta Time (ms) 1.68  
 Cursor 1 46.0937 0.00  Delta Amplitude 5.17

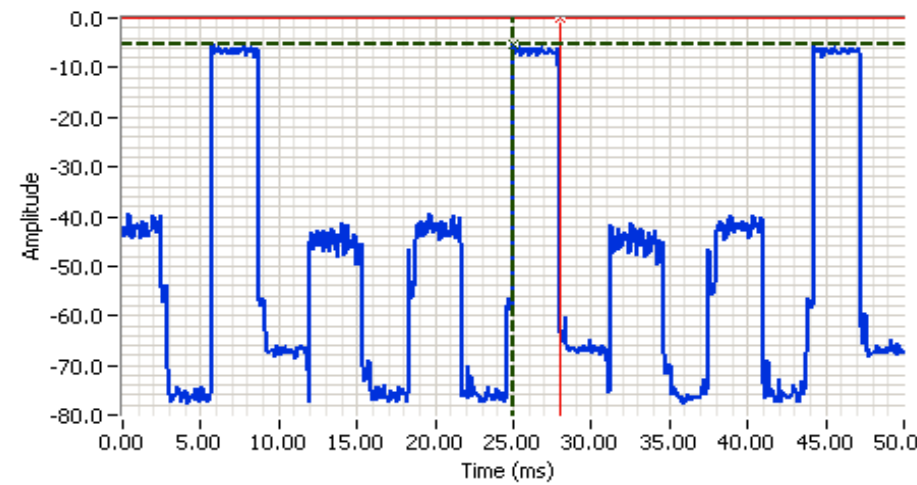

**Analyzer Settings**  
 HP8564E,EMICF: 2440.000 MHz  
 SPAN: 0.000 MHz  
 RB: 100 kHz  
 VB: 300 kHz  
 Detector: POS  
 Attn: 10 DB  
 RL Offset: 0.0 DB  
 Sweep Time: 50.0ms  
 Ref Lvl: -2.0 DBM

**Comments**  
 Basic Rate Mode  
 DH5 Packets

Cursor 1 25.0000 -5.17  Delta Time (ms) 2.99  
 Cursor 1 27.9948 0.00  Delta Amplitude 5.17





## EMC Test Data

Client:	Intel Corporation	Job Number:	J84365
Model:	Intel® Centrino® Advanced-N 6235	T-Log Number:	T80540.2
		Account Manager:	Christine Krebill
Contact:	Steve Hackett		-
Emissions Standard(s):	FCC 15.247	Class:	B
Immunity Standard(s):	-	Environment:	-

# EMC Test Data

For The

## Intel Corporation

Model

Intel® Centrino® Advanced-N 6235

Date of Last Test: 10/6/2010

Client:	Intel Corporation	Job Number:	J84365
Model:	Intel® Centrino® Advanced-N 6235	T-Log Number:	T80540.2
Contact:	Steve Hackett	Account Manager:	Christine Krebill
Standard:	FCC 15.247	Class:	N/A

**RSS 210 and FCC 15.247 (DSS) Radiated Spurious Emissions  
802.11bgn and Bluetooth - Transmitter Mode**

**Test Specific Details**

Objective: The objective of this test session is to perform engineering evaluation testing of the EUT with respect to the specification listed above.

**General Test Configuration**

The EUT was installed into a test fixture such that the EUT was exposed (i.e. outside of a host PC).  
For conducted emissions testing the measurement antenna port.

**Summary of Results**

For Bluetooth: Tx is chain B, Rx is chain B. For WiFi, only Chain A is used for transmit in the 2.4GHz band, both chains used in 5GHz bands.

MAC Address: 00150079AD1A DRTU Tool Version 1.2.12-0197 New tool from 9/14 Driver version 14.0.0.39

Run #	Mode	Channel	Target Power	Measured Power	Test Performed	Limit	Result / Margin
1	BT 1Mb/s 802.11b	2402MHz 2412MHz	7dBm 16.5dBm	4.4 16.5	Radiated Emissions 1- 10 GHz	FCC 15.247	48.0dBµV/m @ 4824.0MHz (-6.0dB)
2	BT 1Mb/s 802.11b	2480MHz 2462MHz	7dBm 16.5dBm	5.3 16.6		FCC 15.247	<b>48.4dBµV/m @ 2360.0MHz (-5.6dB)</b>
3	BT 1Mb/s 802.11g	2402MHz 2412MHz	7dBm 16.5dBm	4.4 16.3		FCC 15.247	46.0dBµV/m @ 2281.9MHz (-8.0dB)
4	BT 1Mb/s 802.11g	2480MHz 2462MHz	7dBm 16.5dBm	5.3 16.9		FCC 15.247	46.6dBµV/m @ 2360.0MHz (-7.4dB)

WiFi mode for the following runs based on worst case mode from runs 1 through 4

5	BT 1Mb/s 802.11b	2402MHz 2437MHz	7dBm 16.5dBm	4.3 16.6	Radiated Emissions 1- 10 GHz	FCC 15.247	46.8dBµV/m @ 2282.0MHz (-7.2dB)
6	BT 1Mb/s 802.11b	2440MHz 2412MHz	7dBm 16.5dBm	5.4 16.5		FCC 15.247	<b>49.3dBµV/m @ 2320.0MHz (-4.7dB)</b>
7	BT 1Mb/s 802.11b	2440MHz 2462MHz	7dBm 16.5dBm	5.4 16.6	Radiated Emissions 1- 10 GHz	FCC 15.247	47.8dBµV/m @ 2320.0MHz (-6.2dB)
8	BT 1Mb/s 802.11b	2480MHz 2437MHz	7dBm 16.5dBm	5.1 16.6		FCC 15.247	48.9dBµV/m @ 2360.0MHz (-5.1dB)

WiFi mode and channel and Bluetooth channel based on the worst case mode from runs 1 through 8

9	BT 3Mb/s 802.11b	2440 MHz 2412 MHz	7dBm 16.5dBm	1.4 16.5	Radiated Emissions 1- 10 GHz	FCC 15.247	<b>46.4dBµV/m @ 2383.9MHz (-7.6dB)</b>
---	---------------------	----------------------	-----------------	-------------	---------------------------------	------------	--



Client:	Intel Corporation	Job Number:	J84365
Model:	Intel® Centrino® Advanced-N 6235	T-Log Number:	T80540.2
Contact:	Steve Hackett	Account Manager:	Christine Krebill
Standard:	FCC 15.247	Class:	N/A

WiFi mode - 802.11n 20MHz with both chains active at 16.5dBm per chain, center channel in each 5GHz band. Bluetooth on center channel, 1Mb/s mode

Run #	Mode	Channel	Target Power	Measured Power	Test Performed	Limit	Result / Margin
10	BT 1Mb/s 802.11n20	2440MHz 5200MHz	7dBm 16.5/16.5	5.4 16.6/16.7	Radiated Emissions 1- 15 GHz	FCC 15.247	41.9dBμV/m @ 2280.0MHz (-12.1dB)
11	BT 1Mb/s 802.11n20	2440MHz 5300MHz	7dBm 16.5/16.5	5.4 16.7/16.5		FCC 15.247	37.2dBμV/m @ 10600.0MHz (-16.8dB)
12	BT 1Mb/s 802.11n20	2440MHz 5600MHz	7dBm 16.5/16.5	5.4 16.5/16.5		FCC 15.247	<b>45.1dBμV/m @ 11199.8MHz (-8.9dB)</b>
13	BT 1Mb/s 802.11n20	2440MHz 5785MHz	7dBm 16.5/16.5	5.4 16.5/16.7		FCC 15.247	44.7dBμV/m @ 11570.7MHz (-9.3dB)

### Modifications Made During Testing

No modifications were made to the EUT during testing

### Deviations From The Standard

No deviations were made from the requirements of the standard.

### Notes:

Bluetooth uses a frequency hopping algorithm that means that the device, during normal operation, is only on a specific channel for a short period of time. The average correction factor is calculated as follows:

A maximum length packet has a duration of 5 time slots.

The hopping rate is 1600 hops/second so the maximum dwell time is 5/1600 seconds, or 3.125ms.

With a minimum of 20 hopping channels a channel will not be used more than 4 times in any 100ms period.

The maximum dwell time in a 100ms period is  $4 \times 3.125\text{ms} = 12.5\text{ms}$ .

The average correction factor is, therefore,  $20\log(12.5/100) = -18\text{dB}$

As this is a hopping radio the correction factor can be applied to the average value of the signal provided the average value was measured with the device continuously transmitting. DA 00-0705 permits the use of the average correction on the **measured average** value for frequency hopping radios.

All measurements in this data sheet do not include the average correction factor.

Client:	Intel Corporation	Job Number:	J84365
Model:	Intel® Centrino® Advanced-N 6235	T-Log Number:	T80540.2
Contact:	Steve Hackett	Account Manager:	Christine Krebill
Standard:	FCC 15.247	Class:	N/A

Run # 1, Rainbow Peak 2x2: 1-10GHz, 802.11b @ 2412 MHz Chain A, BT Basic Rate @ 2402 MHz Chain B

	Target (dBm)	Power Settings Measured (dBm)	Software Setting
Chain A	16.5	16.5	24.5
Chain B	7.0	4.4	8.0

Spurious Radiated Emissions, 1 - 10GHz excluding the allocated band:

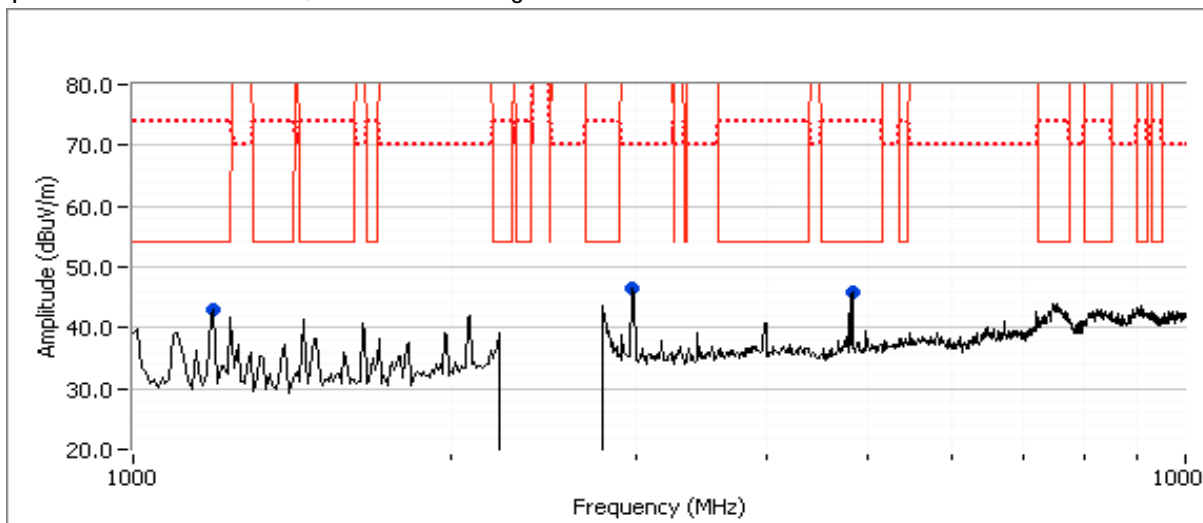

**Preliminary Measurements (Peak versus average limit)**

Frequency	Level	Pol	15.209/15.247		Detector	Azimuth	Height	Comments
MHz	dBuV/m	v/h	Limit	Margin	Pk/QP/Avg	degrees	meters	
4822.500	46.0	V	54.0	-8.0	Peak	154	1.0	
1192.500	42.9	V	54.0	-11.1	Peak	82	1.5	
2980.000	46.4	V	70.0	-23.6	Peak	154	1.0	

**Final measurements at 3m**

Frequency	Level	Pol	15.209/15.247		Detector	Azimuth	Height	Comments
MHz	dBuV/m	v/h	Limit	Margin	Pk/QP/Avg	degrees	meters	
4824.000	48.0	V	54.0	-6.0	AVG	153	1.16	
4823.900	50.8	V	74.0	-23.2	PK	153	1.16	
1192.530	42.9	V	54.0	-11.1	AVG	92	1.64	
1192.550	45.6	V	74.0	-28.4	PK	92	1.64	

Client:	Intel Corporation	Job Number:	J84365
Model:	Intel® Centrino® Advanced-N 6235	T-Log Number:	T80540.2
Contact:	Steve Hackett	Account Manager:	Christine Krebill
Standard:	FCC 15.247	Class:	N/A

### Spurious Radiated Emissions, 2 - 3GHz

*Preliminary Scan at ~ 20cm from the product to identify potential signals (Peak versus average limit)*

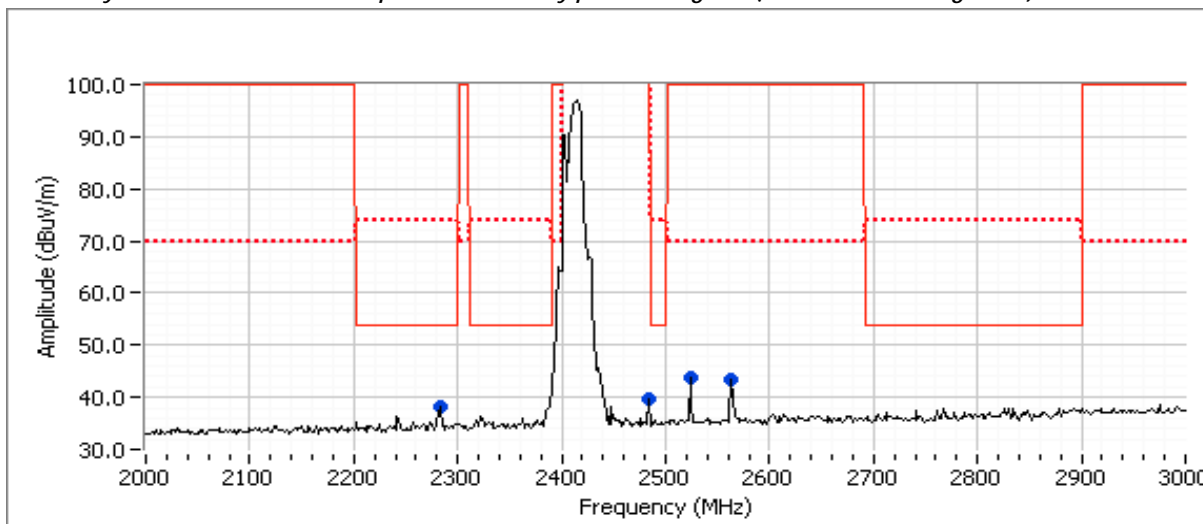

### Preliminary measurements at ~ 20cm, RB=1MHz, VB=100kHz

Frequency	Level	Pol	15.209/15.247		Detector	Azimuth	Height	Comments
MHz	dBµV/m	v/h	Limit	Margin	PK/QP/Avg	degrees	meters	
2283.330	38.3	H	54.0	-15.7	Peak	321	1.0	
2483.330	39.8	H	120.0	-80.2	Peak	4	1.0	In band
2523.330	43.6	H	70.0	-26.4	Peak	0	1.0	Non-restricted band
2563.330	43.4	H	70.0	-26.6	Peak	212	1.0	Non-restricted band

### Final measurements at 3m

Frequency	Level	Pol	15.209/15.247		Detector	Azimuth	Height	Comments
MHz	dBµV/m	v/h	Limit	Margin	PK/QP/Avg	degrees	meters	
2281.900	46.0	H	54.0	-8.0	AVG	69	2.18	Note 2
2282.130	55.6	H	74.0	-18.4	PK	69	2.18	Note 2

Note 1: For emissions in restricted bands, the limit of 15.209 was used. For all other emissions, the limit is -30dBc for peak measurements in a measurement bandwidth of 100kHz.

Note 2: Signal is only present when Bluetooth is enabled, average correction for hopping occupancy could be applied

Client:	Intel Corporation	Job Number:	J84365
Model:	Intel® Centrino® Advanced-N 6235	T-Log Number:	T80540.2
Contact:	Steve Hackett	Account Manager:	Christine Krebill
Standard:	FCC 15.247	Class:	N/A

Run # 2, Rainbow Peak 2x2: 1-10GHz, 802.11b @ 2462 MHz Chain A, BT Basic Rate @ 2480 MHz Chain B

	Target (dBm)	Power Settings	
		Measured (dBm)	Software Setting
Chain A	16.5	16.6	23.5
Chain B	7.0	5.3	8.0

Spurious Radiated Emissions, 1 - 10GHz excluding the allocated band:

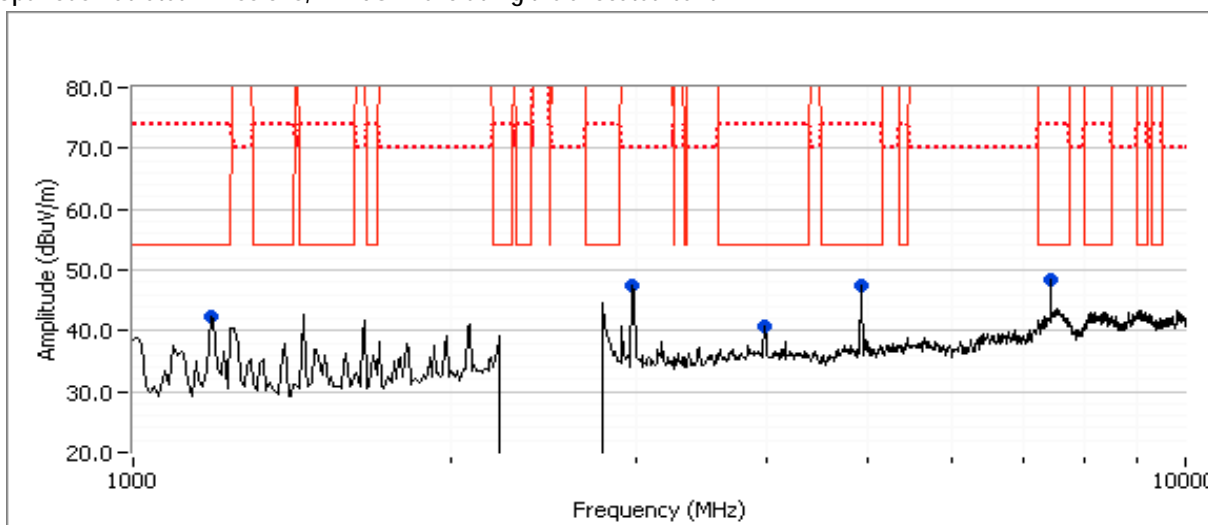

**Preliminary Measurements (Peak versus average limit)**

Frequency	Level	Pol	15.209/15.247		Detector	Azimuth	Height	Comments
MHz	dBuV/m	v/h	Limit	Margin	Pk/QP/Avg	degrees	meters	
7439.170	48.3	V	54.0	-5.7	Peak	167	2.0	
4974.170	47.5	V	54.0	-6.5	Peak	209	2.5	
1183.330	42.3	V	54.0	-11.7	Peak	97	2.0	
3979.170	40.8	V	54.0	-13.2	Peak	146	1.0	
2980.000	47.4	V	70.0	-22.6	Peak	153	1.0	

**Final measurements at 3m**

Frequency	Level	Pol	15.209/15.247		Detector	Azimuth	Height	Comments
MHz	dBuV/m	v/h	Limit	Margin	PK/QP/Avg	degrees	meters	
4924.000	46.8	V	54.0	-7.2	AVG	212	2.48	
7439.940	46.5	V	54.0	-7.5	AVG	166	2.00	
4923.890	50.0	V	74.0	-24.0	PK	212	2.48	
7440.500	53.1	V	74.0	-20.9	PK	166	2.00	

Client:	Intel Corporation	Job Number:	J84365
Model:	Intel® Centrino® Advanced-N 6235	T-Log Number:	T80540.2
Contact:	Steve Hackett	Account Manager:	Christine Krebill
Standard:	FCC 15.247	Class:	N/A

### Spurious Radiated Emissions, 2 - 3GHz

Preliminary Scan at ~ 20cm from the product to identify potential signals (Peak versus average limit)

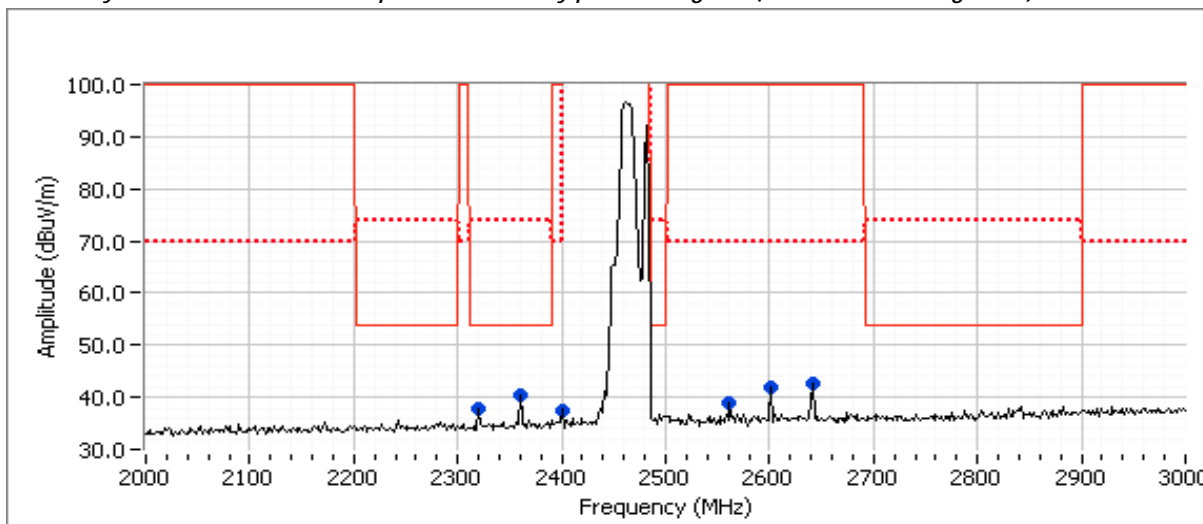

### Preliminary measurements at ~ 20cm, RB=1MHz, VB=100kHz

Frequency	Level	Pol	15.209/15.247		Detector	Azimuth	Height	Comments
MHz	dBµV/m	v/h	Limit	Margin	Pk/QP/Avg	degrees	meters	
2320.000	37.9	H	54.0	-16.1	Peak	185	1.0	
2360.000	40.3	H	54.0	-13.7	Peak	338	1.0	
2400.000	37.4	H	70.0	-32.6	Peak	352	1.0	Non-restricted band
2561.670	39.1	H	70.0	-30.9	Peak	75	1.0	Non-restricted band
2601.670	42.1	H	70.0	-27.9	Peak	144	1.0	Non-restricted band
2641.670	42.5	H	70.0	-27.5	Peak	147	1.0	Non-restricted band

### Final measurements at 3m

Frequency	Level	Pol	15.209/15.247		Detector	Azimuth	Height	Comments
MHz	dBµV/m	v/h	Limit	Margin	Pk/QP/Avg	degrees	meters	
2320.070	46.3	H	54.0	-7.7	AVG	345	1.25	Note 2
2319.830	56.6	H	74.0	-17.4	PK	345	1.25	Note 2
2360.020	48.4	H	54.0	-5.6	AVG	70	1.27	Note 2
2360.000	57.2	H	74.0	-16.8	PK	70	1.27	Note 2

Note 1: For emissions in restricted bands, the limit of 15.209 was used. For all other emissions, the limit is -30dBc for peak measurements in a measurement bandwidth of 100kHz.

Note 2: Signal is only present when Bluetooth is enabled, average correction for hopping occupancy could be applied

Client:	Intel Corporation	Job Number:	J84365
Model:	Intel® Centrino® Advanced-N 6235	T-Log Number:	T80540.2
Contact:	Steve Hackett	Account Manager:	Christine Krebill
Standard:	FCC 15.247	Class:	N/A

Run # 3, Rainbow Peak 2x2: 1-10GHz, 802.11g @ 2412 MHz Chain A, BT Basic Rate @ 2402 MHz Chain B  
 Spurious Radiated Emissions, 1 - 10GHz excluding the allocated band:

	Target (dBm)	Power Settings Measured (dBm)	Software Setting
Chain A	16.5	16.3	31.0
Chain B	7.0	4.4	8.0

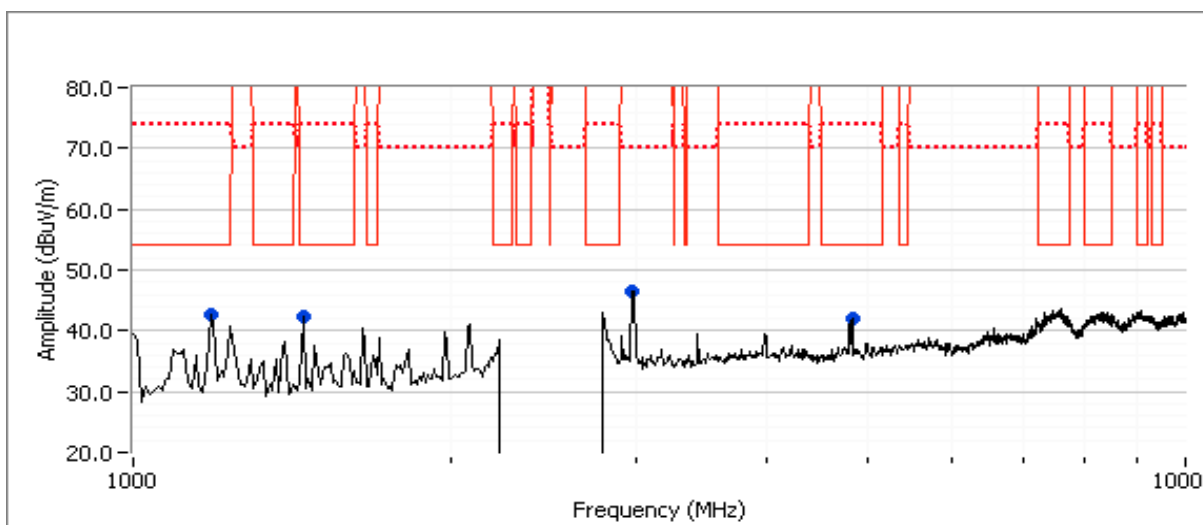

**Preliminary Measurements (Peak versus average limit)**

Frequency	Level	Pol	15.209/15.247		Detector	Azimuth	Height	Comments
MHz	dBuV/m	v/h	Limit	Margin	Pk/QP/Avg	degrees	meters	
1183.330	42.8	V	54.0	-11.2	Peak	102	2.0	
1449.170	42.5	H	54.0	-11.5	Peak	138	1.5	
4822.500	42.1	V	54.0	-11.9	Peak	283	2.0	
2980.000	46.4	V	70.0	-23.6	Peak	153	1.0	

**Final measurements at 3m**

Frequency	Level	Pol	15.209/15.247		Detector	Azimuth	Height	Comments
MHz	dBuV/m	v/h	Limit	Margin	Pk/QP/Avg	degrees	meters	
1457.590	43.2	H	54.0	-10.8	AVG	132	1.33	
1457.600	45.4	H	74.0	-28.6	PK	132	1.33	
1192.560	42.5	V	54.0	-11.5	AVG	89	1.99	
1192.600	44.8	V	74.0	-29.2	PK	89	1.99	
4823.900	40.7	V	54.0	-13.3	AVG	153	1.18	
4826.970	52.1	V	74.0	-21.9	PK	153	1.18	

Client:	Intel Corporation	Job Number:	J84365
Model:	Intel® Centrino® Advanced-N 6235	T-Log Number:	T80540.2
Contact:	Steve Hackett	Account Manager:	Christine Krebill
Standard:	FCC 15.247	Class:	N/A

### Spurious Radiated Emissions, 2 - 3GHz

Preliminary Scan at ~ 20cm from the product to identify potential signals (Peak versus average limit)

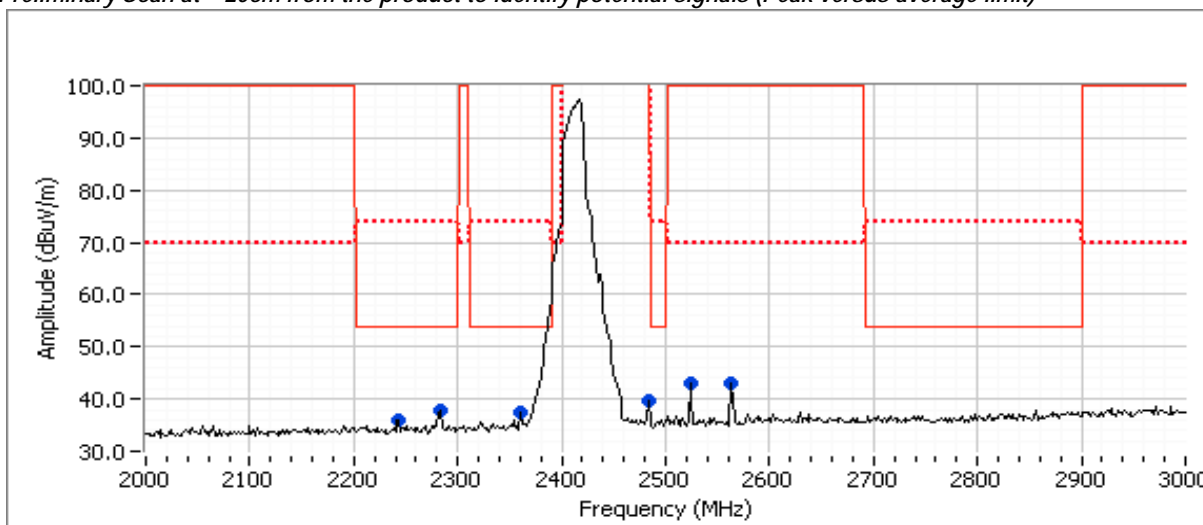

Preliminary measurements at ~ 20cm, RB=1MHz, VB=100kHz

Frequency	Level	Pol	15.209/15.247		Detector	Azimuth	Height	Comments
MHz	dBµV/m	v/h	Limit	Margin	PK/QP/Avg	degrees	meters	
2243.330	36.1	V	54.0	-17.9	Peak	42	1.0	
2283.330	37.7	H	54.0	-16.3	Peak	306	1.0	
2360.000	37.3	H	54.0	-16.7	Peak	358	1.0	
2483.330	39.6	H	120.0	-80.4	Peak	10	1.0	In-band
2523.330	43.2	H	70.0	-26.8	Peak	31	1.0	Non-restricted band
2563.330	43.1	H	70.0	-26.9	Peak	20	1.0	Non-restricted band

Final measurements at 3m

Frequency	Level	Pol	15.209/15.247		Detector	Azimuth	Height	Comments
MHz	dBµV/m	v/h	Limit	Margin	PK/QP/Avg	degrees	meters	
2241.910	45.2	V	54.0	-8.8	AVG	163	1.42	Note 2
2241.860	55.3	V	74.0	-18.7	PK	163	1.42	Note 2
2281.910	46.0	H	54.0	-8.0	AVG	70	2.27	Note 2
2281.960	55.5	H	74.0	-18.5	PK	70	2.27	Note 2
2362.170	44.9	H	54.0	-9.1	AVG	66	1.19	Note 2
2361.080	55.1	H	74.0	-18.9	PK	66	1.19	Note 2

Note 1: For emissions in restricted bands, the limit of 15.209 was used. For all other emissions, the limit is -30dBc for peak measurements in a measurement bandwidth of 100kHz.

Note 2: Signal is only present when Bluetooth is enabled, average correction for hopping occupancy could be applied

Client:	Intel Corporation	Job Number:	J84365
Model:	Intel® Centrino® Advanced-N 6235	T-Log Number:	T80540.2
Contact:	Steve Hackett	Account Manager:	Christine Krebill
Standard:	FCC 15.247	Class:	N/A

Run # 4, Rainbow Peak 2x2: 1-10GHz, 802.11g @ 2462 MHz Chain A, BT Basic Rate @ 2480 MHz Chain B

	Target (dBm)	Power Settings Measured (dBm)	Software Setting
Chain A	16.5	16.9	29.5
Chain B	7.0	5.3	8.0

Spurious Radiated Emissions, 1 - 10GHz excluding the allocated band:

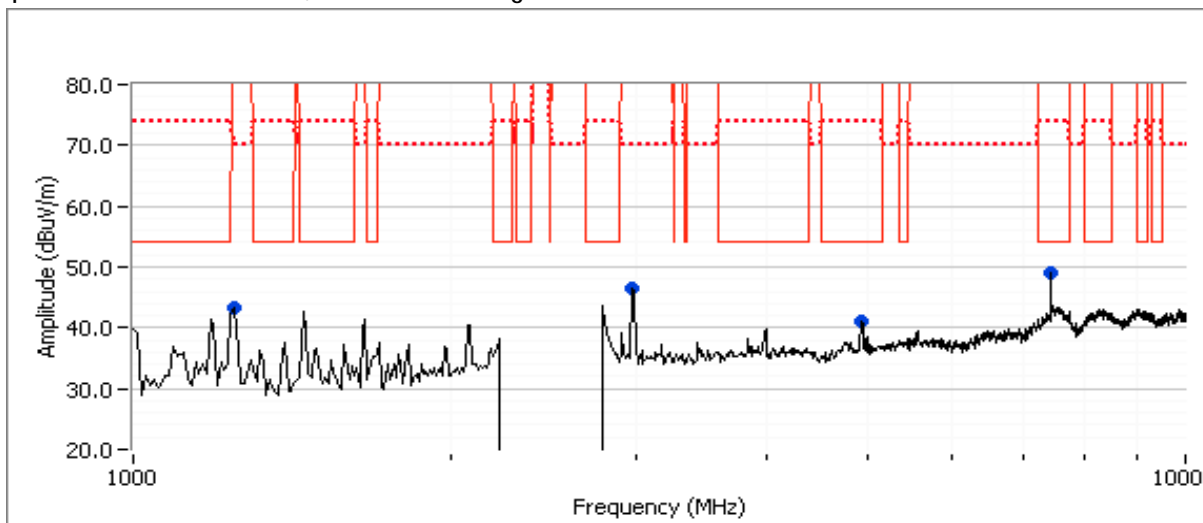

*Preliminary Measurements (Peak versus average limit)*

Frequency	Level	Pol	15.209/15.247		Detector	Azimuth	Height	Comments
MHz	dBuV/m	v/h	Limit	Margin	Pk/QP/Avg	degrees	meters	
7439.170	49.2	V	54.0	-4.8	Peak	174	1.5	
4923.330	41.1	V	54.0	-12.9	Peak	181	2.5	
2980.000	46.6	V	70.0	-23.4	Peak	160	1.0	
1247.500	43.4	H	70.0	-26.6	Peak	152	1.5	

**Final measurements at 3m**

Frequency	Level	Pol	15.209/15.247		Detector	Azimuth	Height	Comments
MHz	dBuV/m	v/h	Limit	Margin	PK/QP/Avg	degrees	meters	
7440.020	45.8	V	54.0	-8.2	AVG	178	1.52	
7439.570	52.7	V	74.0	-21.3	PK	178	1.52	

Note: 7440MHz is directly related to the Bluetooth signal and was observed during the Bluetooth only **spurious measurements**.



Client:	Intel Corporation	Job Number:	J84365
Model:	Intel® Centrino® Advanced-N 6235	T-Log Number:	T80540.2
Contact:	Steve Hackett	Account Manager:	Christine Krebill
Standard:	FCC 15.247	Class:	N/A

### Spurious Radiated Emissions, 2 - 3GHz

*Preliminary Scan at ~ 20cm from the product to identify potential signals (Peak versus average limit)*

No preamplifier used for these scans

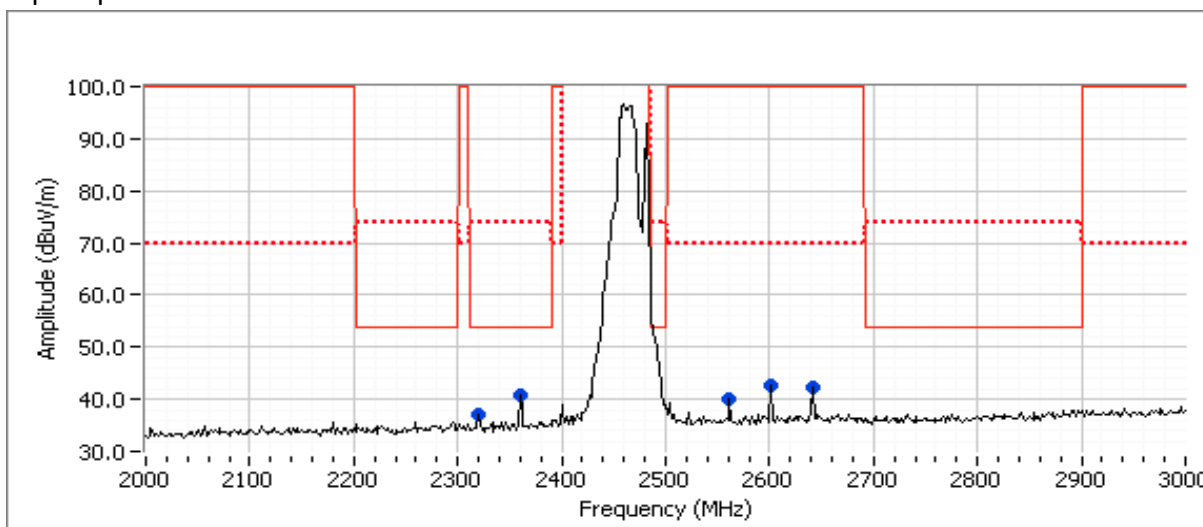

### Preliminary measurements at ~ 20cm, RB=1MHz, VB=100kHz

Frequency MHz	Level dBµV/m	Pol v/h	15.209/15.247		Detector Pk/QP/Avg	Azimuth degrees	Height meters	Comments
			Limit	Margin				
2320.000	37.2	H	54.0	-16.8	Peak	317	1.0	
2360.000	40.7	H	54.0	-13.3	Peak	347	1.0	
2561.670	39.9	H	70.0	-30.1	Peak	205	1.0	Non-restricted band
2601.670	42.6	H	70.0	-27.4	Peak	144	1.0	Non-restricted band
2641.670	42.4	H	70.0	-27.6	Peak	173	1.0	Non-restricted band

### Final measurements at 3m

Frequency MHz	Level dBµV/m	Pol v/h	15.209/15.247		Detector Pk/QP/Avg	Azimuth degrees	Height meters	Comments
			Limit	Margin				
2324.470	44.5	H	54.0	-9.5	AVG	236	1.0	
<b>2360.040</b>	<b>46.6</b>	H	54.0	-7.4	AVG	326	1.0	
2323.600	57.6	H	74.0	-16.4	PK	236	1.0	
2359.450	56.2	H	74.0	-17.8	PK	326	1.0	

Note 1: For emissions in restricted bands, the limit of 15.209 was used. For all other emissions, the limit is -30dBc for peak measurements in a measurement bandwidth of 100kHz.

Note 2: Signal is only present when Bluetooth is enabled, average correction for hopping occupancy could be applied

Note 3: Signal is present when Bluetooth is disabled (powered off)

Client:	Intel Corporation	Job Number:	J84365
Model:	Intel® Centrino® Advanced-N 6235	T-Log Number:	T80540.2
Contact:	Steve Hackett	Account Manager:	Christine Krebill
Standard:	FCC 15.247	Class:	N/A

Run # 5, Rainbow Peak 2x2: 1-10GHz, 802.11b @ 2437 MHz Chain A, BT Basic Rate @ 2402 MHz Chain B

	Target (dBm)	Power Settings Measured (dBm)	Software Setting
Chain A	16.5	16.6	23.5
Chain B	7.0	4.3	8.0

Spurious Radiated Emissions, 1 - 10GHz excluding the allocated band:  
Preamplifier and notch filter used for these scans

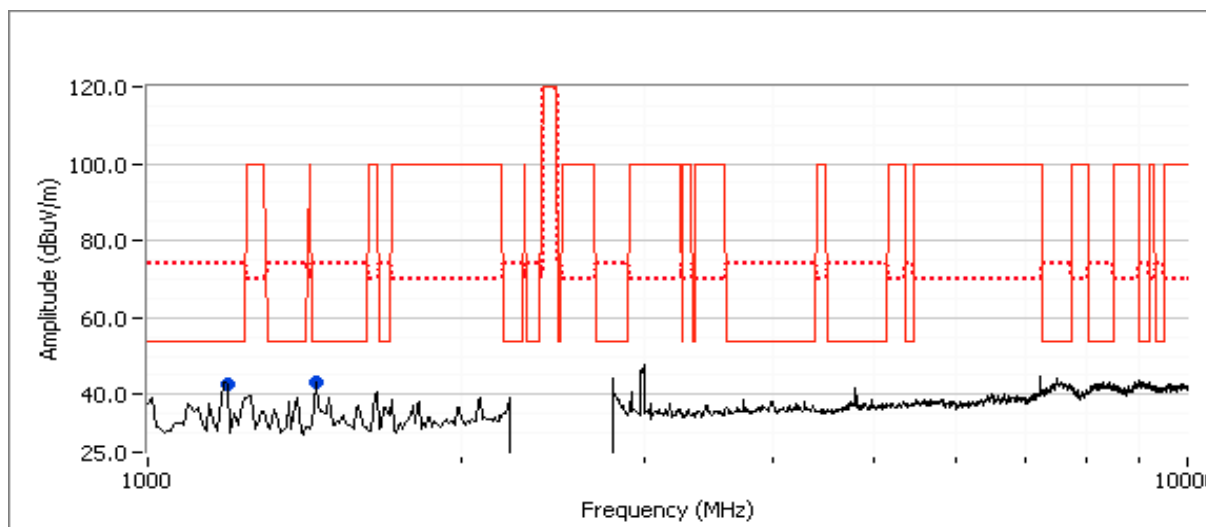

**Preliminary Measurements (Peak versus average limit)**

Frequency	Level	Pol	15.209/15.247		Detector	Azimuth	Height	Comments
MHz	dBμV/m	v/h	Limit	Margin	PK/QP/Avg	degrees	meters	
1457.620	43.2	H	54.0	-10.8	Peak	130	1.5	
1199.820	42.6	V	54.0	-11.4	Peak	96	2.0	

**Final measurements at 3m**

Frequency	Level	Pol	15.209/15.247		Detector	Azimuth	Height	Comments
MHz	dBμV/m	v/h	Limit	Margin	PK/QP/Avg	degrees	meters	
1200.140	40.1	V	54.0	-13.9	AVG	100	2.0	
<b>1457.570</b>	<b>43.0</b>	H	54.0	<b>-11.0</b>	AVG	127	1.4	
1199.950	44.7	V	74.0	-29.3	PK	100	2.0	
1457.490	45.1	H	74.0	-28.9	PK	127	1.4	

Note: 4804MHz is directly related to the Bluetooth signal and was observed during the Bluetooth only **spurious measurements**.

Client:	Intel Corporation	Job Number:	J84365
Model:	Intel® Centrino® Advanced-N 6235	T-Log Number:	T80540.2
Contact:	Steve Hackett	Account Manager:	Christine Krebill
Standard:	FCC 15.247	Class:	N/A

### Spurious Radiated Emissions, 2 - 3GHz

*Preliminary Scan at ~ 20cm from the product to identify potential signals (Peak versus average limit)*

No preamplifier used for these scans

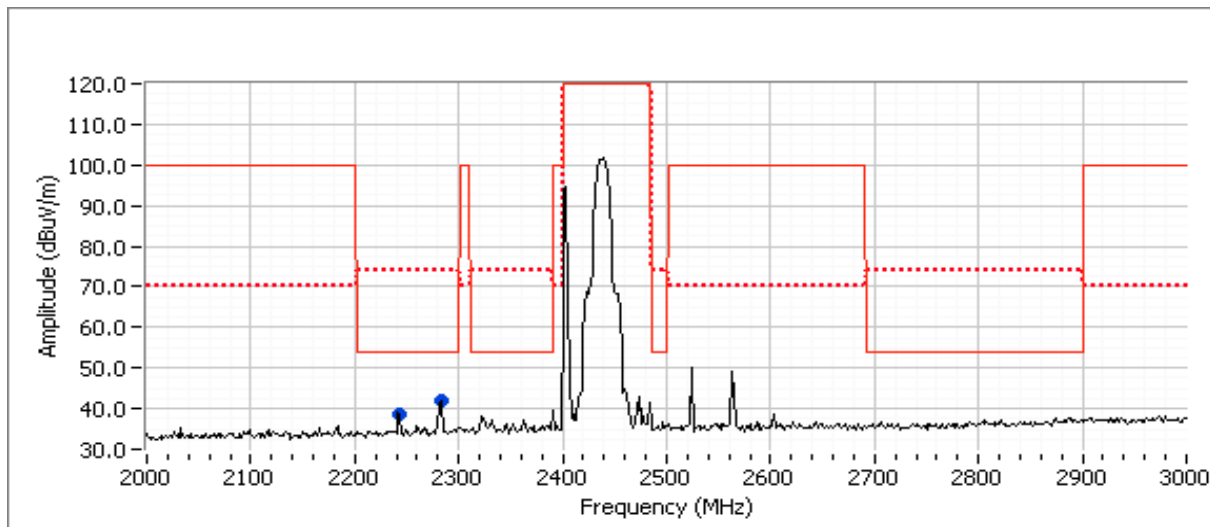

### Preliminary measurements at ~ 20cm, RB=1MHz, VB=100kHz

Frequency	Level	Pol	15.209/15.247		Detector	Azimuth	Height	Comments
MHz	dBµV/m	v/h	Limit	Margin	Pk/QP/Avg	degrees	meters	
2283.330	41.8	V	54.0	-12.2	Peak	180	1.0	5
2243.330	38.7	V	54.0	-15.3	Peak	180	1.0	5

### Final measurements at 3m

Frequency	Level	Pol	15.209/15.247		Detector	Azimuth	Height	Comments
MHz	dBµV/m	v/h	Limit	Margin	Pk/QP/Avg	degrees	meters	
2281.990	46.8	H	54.0	-7.2	AVG	70	1.0	RB 1 MHz;VB 10 Hz;Pk
2282.150	56.7	H	74.0	-17.3	PK	70	1.0	RB 1 MHz;VB 3 MHz;Pk
2242.060	46.7	H	54.0	-7.3	AVG	68	1.0	RB 1 MHz;VB 10 Hz;Pk
2241.580	56.3	H	74.0	-17.7	PK	68	1.0	RB 1 MHz;VB 3 MHz;Pk
2282.000	45.9	V	54.0	-8.1	AVG	105	1.2	RB 1 MHz;VB 10 Hz;Pk
2282.210	56.1	V	74.0	-17.9	PK	105	1.2	RB 1 MHz;VB 3 MHz;Pk

Note 1: For emissions in restricted bands, the limit of 15.209 was used. For all other emissions, the limit is -30dBc for peak measurements in a measurement bandwidth of 100kHz.

Note 2: Signal is only present when Bluetooth is enabled, average correction for hopping occupancy could be applied

Note 3: Signal is present when Bluetooth is disabled (powered off)

Client:	Intel Corporation	Job Number:	J84365
Model:	Intel® Centrino® Advanced-N 6235	T-Log Number:	T80540.2
Contact:	Steve Hackett	Account Manager:	Christine Krebill
Standard:	FCC 15.247	Class:	N/A

Run # 6, Rainbow Peak 2x2: 1-10GHz, 802.11b @ 2412 MHz Chain A, BT Basic Rate @ 2440 MHz Chain B

	Target (dBm)	Power Settings Measured (dBm)	Software Setting
Chain A	16.5	16.5	23.5
Chain B	7.0	5.4	8.0

Spurious Radiated Emissions, 1 - 10GHz excluding the allocated band:  
Preamplifier and notch filter used for these scans

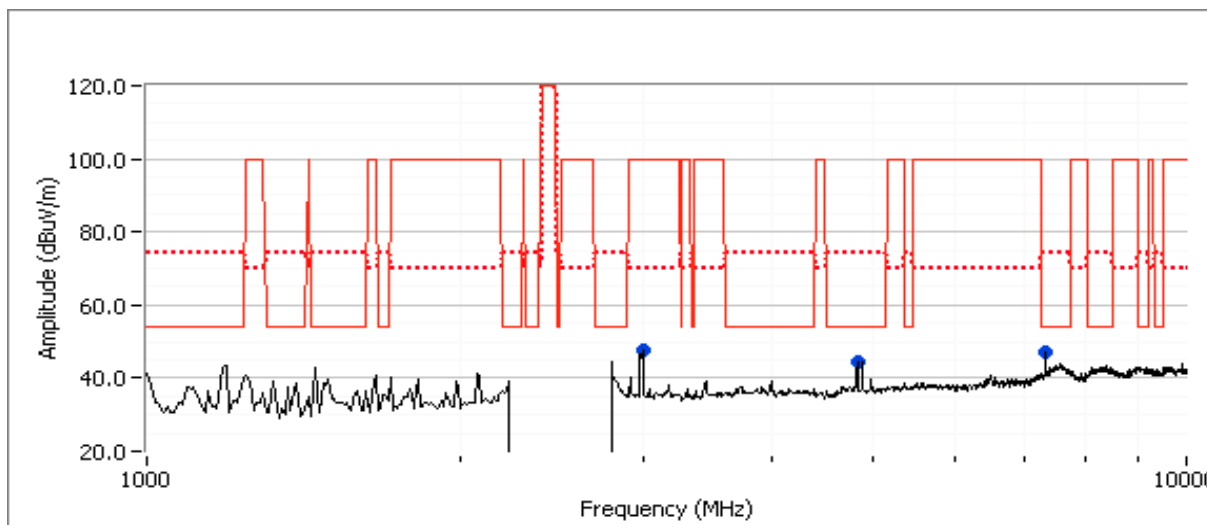

**Preliminary Measurements (Peak versus average limit)**

Frequency	Level	Pol	15.209/15.247		Detector	Azimuth	Height	Comments
MHz	dBµV/m	v/h	Limit	Margin	Pk/QP/Avg	degrees	meters	
2998.330	47.9	V	70.0	-22.1	Peak	141	1.0	
4823.990	44.6	V	54.0	-9.4	Peak	149	1.0	
7316.670	47.1	V	54.0	-6.9	Peak	165	1.9	

**Final measurements at 3m**

Frequency	Level	Pol	15.209/15.247		Detector	Azimuth	Height	Comments
MHz	dBµV/m	v/h	Limit	Margin	Pk/QP/Avg	degrees	meters	
4823.980	44.9	V	54.0	-9.1	AVG	149	1.3	RB 1 MHz;VB 10 Hz;Pk
4823.900	48.4	V	74.0	-25.6	PK	149	1.3	RB 1 MHz;VB 3 MHz;Pk
7319.940	43.6	V	54.0	-10.4	AVG	170	2.0	RB 1 MHz;VB 10 Hz;Pk
7319.350	51.4	V	74.0	-22.6	PK	170	2.0	RB 1 MHz;VB 3 MHz;Pk

Note: 7320 MHz is directly related to the Bluetooth signal and was observed during the Bluetooth only spurio us measurements.

Client:	Intel Corporation	Job Number:	J84365
Model:	Intel® Centrino® Advanced-N 6235	T-Log Number:	T80540.2
Contact:	Steve Hackett	Account Manager:	Christine Krebill
Standard:	FCC 15.247	Class:	N/A

### Spurious Radiated Emissions, 2 - 3GHz

*Preliminary Scan at ~ 20cm from the product to identify potential signals (Peak versus average limit)*

No preamplifier used for these scans

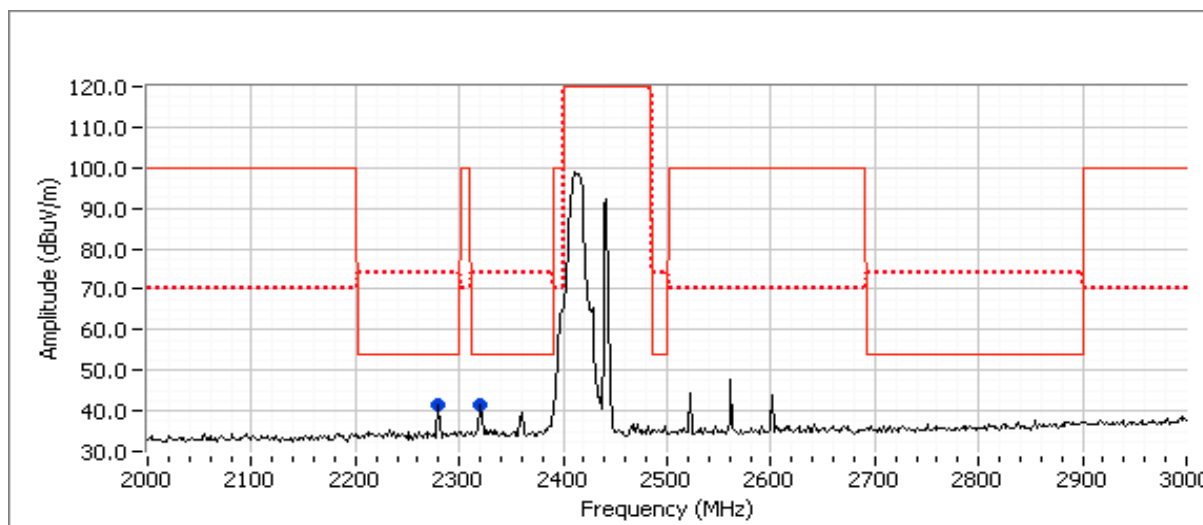

### Preliminary measurements at ~ 20cm, RB=1MHz, VB=100kHz

Frequency MHz	Level dBµV/m	Pol v/h	15.209/15.247		Detector Pk/QP/Avg	Azimuth degrees	Height meters	Comments
			Limit	Margin				
2320.000	40.1	-	54.0	-13.9	Peak	180	1.0	
2280.000	39.0	-	54.0	-15.0	Peak	180	1.0	

### Final measurements at 3m

Frequency MHz	Level dBµV/m	Pol v/h	15.209/15.247		Detector Pk/QP/Avg	Azimuth degrees	Height meters	Comments
			Limit	Margin				
2319.970	49.3	H	54.0	-4.7	AVG	70	1.2	RB 1 MHz;VB 10 Hz;Pk
2319.990	57.3	H	74.0	-16.7	PK	70	1.2	RB 1 MHz;VB 3 MHz;Pk
2279.960	46.8	H	54.0	-7.2	AVG	70	1.9	RB 1 MHz;VB 10 Hz;Pk
2279.780	55.9	H	74.0	-18.1	PK	70	1.9	RB 1 MHz;VB 3 MHz;Pk
2319.980	46.7	V	54.0	-7.3	AVG	104	1.0	RB 1 MHz;VB 10 Hz;Pk
2319.800	56.2	V	74.0	-17.8	PK	104	1.0	RB 1 MHz;VB 3 MHz;Pk

Note 1:	For emissions in restricted bands, the limit of 15.209 was used. For all other emissions, the limit is -30dBc for peak measurements in a measurement bandwidth of 100kHz.
Note 2:	Signal is only present when Bluetooth is enabled, average correction for hopping occupancy could be applied
Note 3:	Signal is present when Bluetooth is disabled (powered off)

Client:	Intel Corporation	Job Number:	J84365
Model:	Intel® Centrino® Advanced-N 6235	T-Log Number:	T80540.2
Contact:	Steve Hackett	Account Manager:	Christine Krebill
Standard:	FCC 15.247	Class:	N/A

Run # 7, Rainbow Peak 2x2: 1-10GHz, 802.11b @ 2462 MHz Chain A, BT Basic Rate @ 2440 MHz Chain B

	Target (dBm)	Power Settings Measured (dBm)	Software Setting
Chain A	16.5	16.6	23.5
Chain B	7.0	5.4	8.0

Spurious Radiated Emissions, 1 - 10GHz excluding the allocated band:  
Preamplifier and notch filter used for these scans

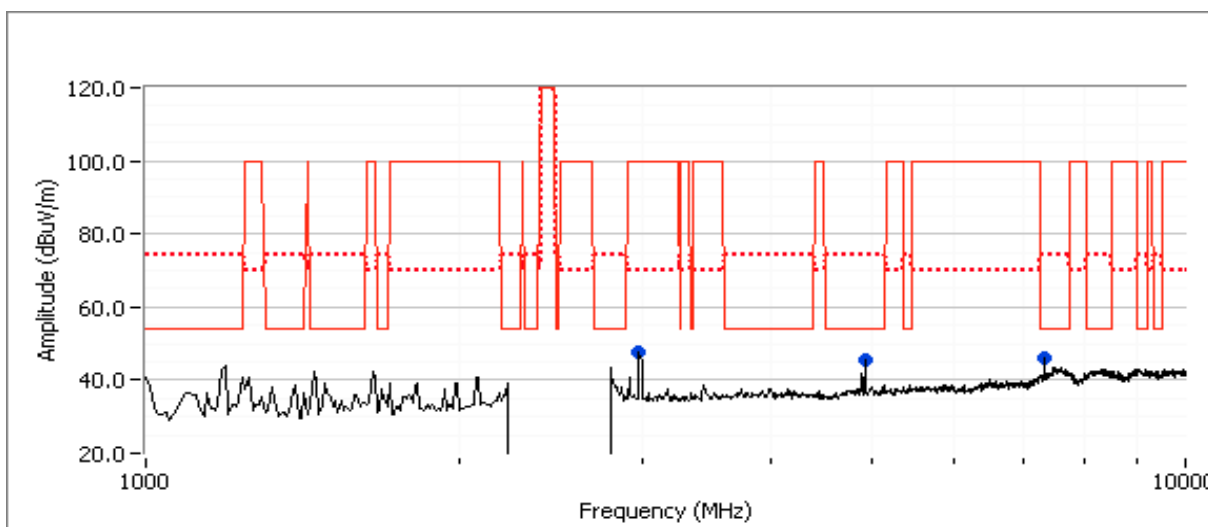

**Preliminary Measurements (Peak versus average limit)**

Frequency	Level	Pol	15.209/15.247		Detector	Azimuth	Height	Comments
MHz	dBuV/m	v/h	Limit	Margin	Pk/QP/Avg	degrees	meters	
2980.000	47.7	V	70.0	-22.3	Peak	141	1.0	
4923.860	45.3	V	54.0	-8.7	Peak	166	1.6	
7322.500	46.3	V	54.0	-7.7	Peak	182	1.6	

**Final measurements at 3m**

Frequency	Level	Pol	15.209/15.247		Detector	Azimuth	Height	Comments
MHz	dBuV/m	v/h	Limit	Margin	Pk/QP/Avg	degrees	meters	
4923.980	47.6	V	54.0	-6.4	AVG	166	1.7	RB 1 MHz;VB 10 Hz;Pk
4923.940	50.3	V	74.0	-23.7	PK	166	1.7	RB 1 MHz;VB 3 MHz;Pk
7320.050	41.2	V	54.0	-12.8	AVG	201	2.0	RB 1 MHz;VB 10 Hz;Pk
7320.180	49.5	V	74.0	-24.5	PK	201	2.0	RB 1 MHz;VB 3 MHz;Pk

Note: 7320 MHz is directly related to the Bluetooth signal and was observed during the Bluetooth only spurio us measurements.

Client:	Intel Corporation	Job Number:	J84365
Model:	Intel® Centrino® Advanced-N 6235	T-Log Number:	T80540.2
Contact:	Steve Hackett	Account Manager:	Christine Krebill
Standard:	FCC 15.247	Class:	N/A

### Spurious Radiated Emissions, 2 - 3GHz

*Preliminary Scan at ~ 20cm from the product to identify potential signals (Peak versus average limit)*

No preamplifier used for these scans

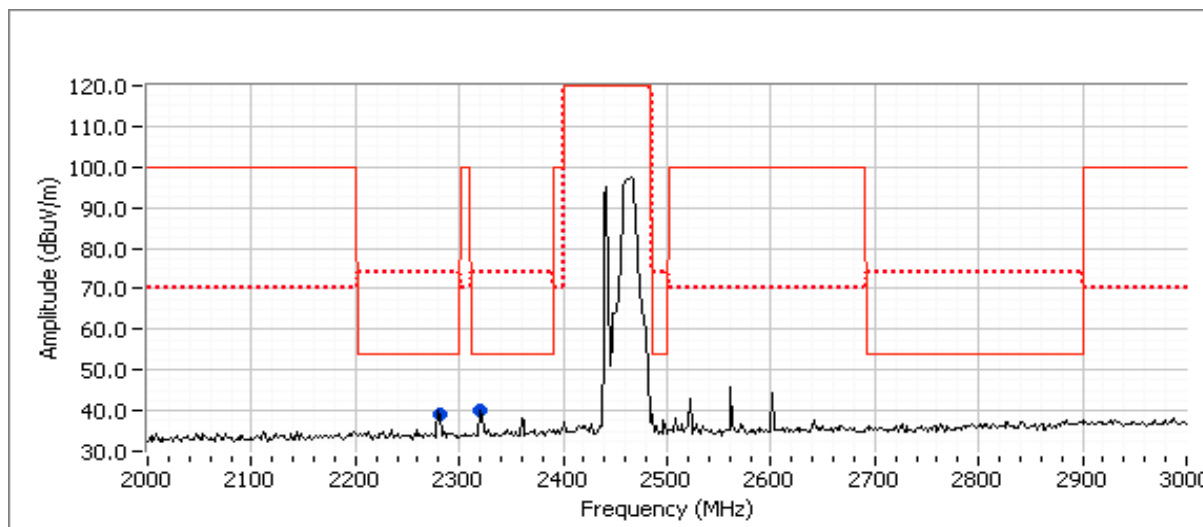

### Preliminary measurements at ~ 20cm, RB=1MHz, VB=100kHz

Frequency MHz	Level dB $\mu$ V/m	Pol v/h	15.209/15.247		Detector Pk/QP/Avg	Azimuth degrees	Height meters	Comments
			Limit	Margin				
2320.000	40.1	H	54.0	-13.9	Peak	180	1.0	
2288.500	39.0	H	54.0	-15.0	Peak	180	1.0	

### Final measurements at 3m

Frequency MHz	Level dB $\mu$ V/m	Pol v/h	15.209/15.247		Detector Pk/QP/Avg	Azimuth degrees	Height meters	Comments
			Limit	Margin				
2319.980	47.8	H	54.0	-6.2	AVG	72	1.2	
2279.930	46.7	H	54.0	-7.3	AVG	69	1.0	
2320.040	45.8	V	54.0	-8.2	AVG	100	1.0	
2279.930	45.2	V	54.0	-8.8	AVG	101	1.0	
2320.230	57.3	H	74.0	-16.7	PK	72	1.2	
2284.230	56.0	H	74.0	-18.0	PK	69	1.0	
2324.580	55.8	V	74.0	-18.2	PK	100	1.0	
2280.470	55.3	V	74.0	-18.7	PK	101	1.0	

Note 1: For emissions in restricted bands, the limit of 15.209 was used. For all other emissions, the limit is -30dBc for peak measurements in a measurement bandwidth of 100kHz.

Note 2: Signal is only present when Bluetooth is enabled, average correction for hopping occupancy could be applied

Note 3: Signal is present when Bluetooth is disabled (powered off)

Client:	Intel Corporation	Job Number:	J84365
Model:	Intel® Centrino® Advanced-N 6235	T-Log Number:	T80540.2
Contact:	Steve Hackett	Account Manager:	Christine Krebill
Standard:	FCC 15.247	Class:	N/A

Run # 8, Rainbow Peak 2x2: 1-10GHz, 802.11b @ 2437 MHz Chain A, BT Basic Rate @ 2480 MHz Chain B

	Target (dBm)	Power Settings Measured (dBm)	Software Setting
Chain A	16.5	16.6	23.5
Chain B	7.0	5.1	8.0

Spurious Radiated Emissions, 1 - 10GHz excluding the allocated band:  
Preamplifier and notch filter used for these scans

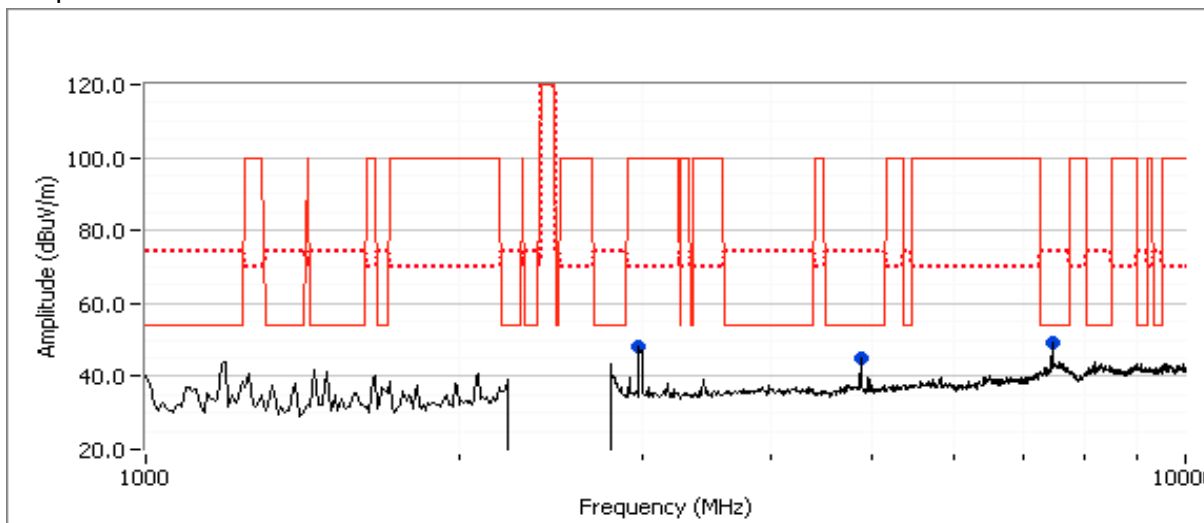

**Preliminary Measurements (Peak versus average limit)**

Frequency	Level	Pol	15.209/15.247		Detector	Azimuth	Height	Comments
MHz	dBuV/m	v/h	Limit	Margin	Pk/QP/Avg	degrees	meters	
2980.000	48.4	V	70.0	-21.6	Peak	148	1.0	
4873.880	45.0	V	54.0	-9.0	Peak	148	1.3	
7439.170	49.5	V	54.0	-4.5	Peak	166	2.2	

**Final measurements at 3m**

Frequency	Level	Pol	15.209/15.247		Detector	Azimuth	Height	Comments
MHz	dBuV/m	v/h	Limit	Margin	Pk/QP/Avg	degrees	meters	
4874.020	45.2	V	54.0	-8.8	AVG	146	1.2	RB 1 MHz;VB 10 Hz;Pk
4874.030	49.0	V	74.0	-25.0	PK	146	1.2	RB 1 MHz;VB 3 MHz;Pk
7440.000	44.9	V	54.0	-9.1	AVG	167	1.5	RB 1 MHz;VB 10 Hz;Pk
7440.270	52.2	V	74.0	-21.8	PK	167	1.5	RB 1 MHz;VB 3 MHz;Pk

Note: 7320 MHz is directly related to the Bluetooth signal and was observed during the Bluetooth only spurio us measurements.



Client:	Intel Corporation	Job Number:	J84365
Model:	Intel® Centrino® Advanced-N 6235	T-Log Number:	T80540.2
Contact:	Steve Hackett	Account Manager:	Christine Krebill
Standard:	FCC 15.247	Class:	N/A

**Spurious Radiated Emissions, 2 - 3GHz**

*Preliminary Scan at ~ 20cm from the product to identify potential signals (Peak versus average limit)*

No preamplifier used for these scans

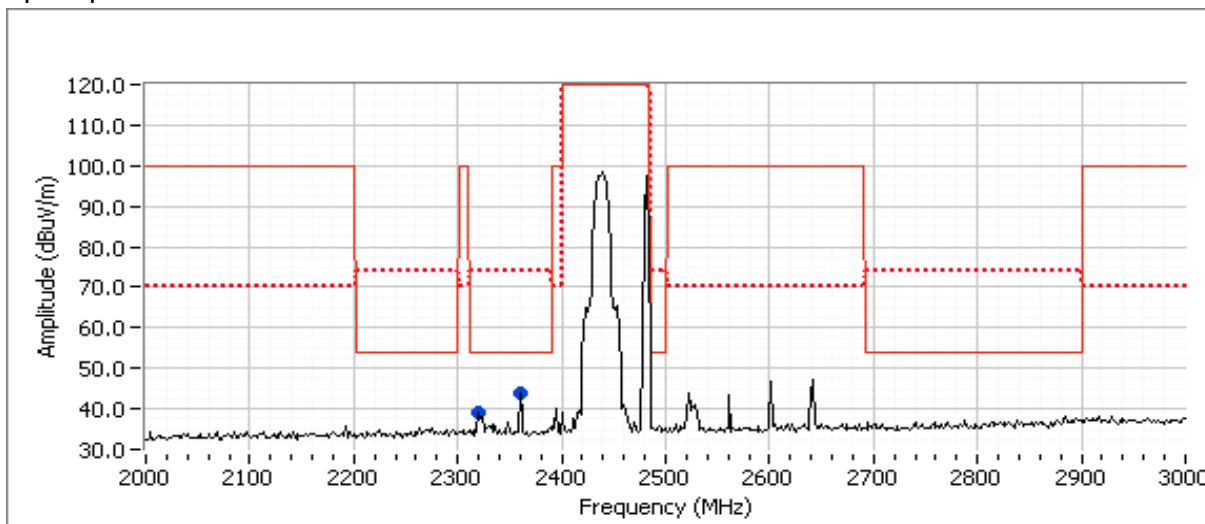

**Preliminary measurements at ~ 20cm, RB=1MHz, VB=100kHz**

Frequency MHz	Level dBµV/m	Pol v/h	15.209/15.247		Detector Pk/QP/Avg	Azimuth degrees	Height meters	Comments
			Limit	Margin				
2360.000	43.8	-	54.0	-10.2	Peak	180	1.0	
2320.000	39.2	-	54.0	-14.8	Peak	180	1.0	

**Final measurements at 3m**

Frequency MHz	Level dBµV/m	Pol v/h	15.209/15.247		Detector Pk/QP/Avg	Azimuth degrees	Height meters	Comments
			Limit	Margin				
2360.020	48.9	H	54.0	-5.1	AVG	328	1.0	
2319.980	47.9	H	54.0	-6.1	AVG	69	1.3	
2359.980	46.7	V	54.0	-7.3	AVG	107	1.0	
2320.040	45.7	V	54.0	-8.3	AVG	104	1.0	
2320.230	57.3	H	74.0	-16.7	PK	69	1.3	
2360.430	56.7	V	74.0	-17.3	PK	107	1.0	
2360.100	56.6	H	74.0	-17.4	PK	328	1.0	
2324.580	55.6	V	74.0	-18.4	PK	104	1.0	

Note 1: For emissions in restricted bands, the limit of 15.209 was used. For all other emissions, the limit is -30dBc for peak measurements in a measurement bandwidth of 100kHz.

Note 2: Signal is only present when Bluetooth is enabled, average correction for hopping occupancy could be applied

Note 3: Signal is present when Bluetooth is disabled (powered off)

Client:	Intel Corporation	Job Number:	J84365
Model:	Intel® Centrino® Advanced-N 6235	T-Log Number:	T80540.2
Contact:	Steve Hackett	Account Manager:	Christine Krebill
Standard:	FCC 15.247	Class:	N/A

Run # 9, Rainbow Peak 2x2: 1-10GHz, 802.11b @ 2412 MHz Chain A, BT EDR @ 2440 MHz Chain B

	Target (dBm)	Power Settings Measured (dBm)	Software Setting
Chain A	16.5	16.5	23.5
Chain B	7.0	1.4	8.0

Spurious Radiated Emissions, 1 - 10GHz excluding the allocated band:  
Preamplifier and notch filter used for these scans

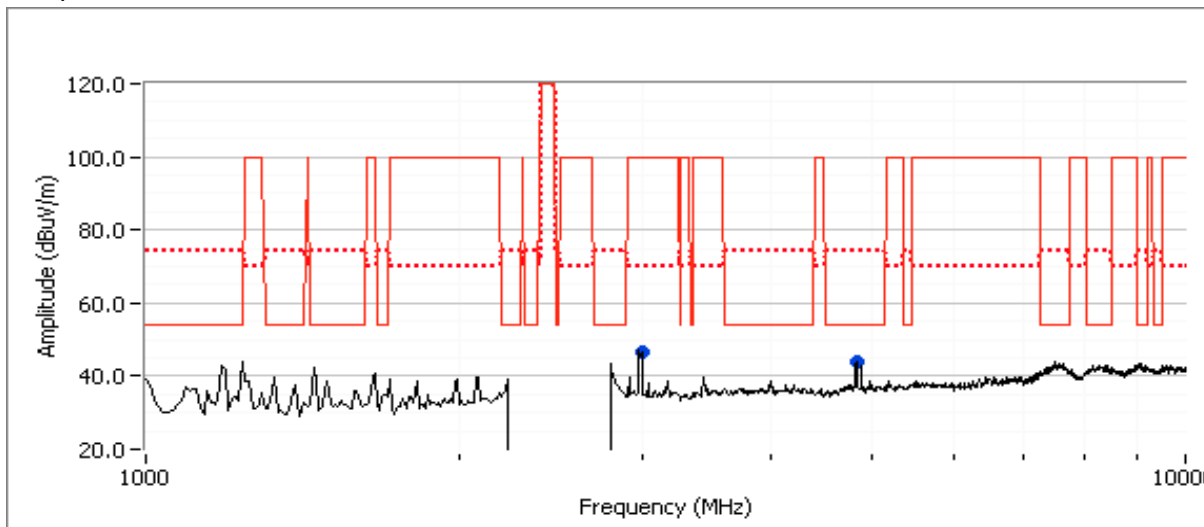

**Preliminary Measurements (Peak versus average limit)**

Frequency	Level	Pol	15.209/15.247		Detector	Azimuth	Height	Comments
MHz	dBμV/m	v/h	Limit	Margin	Pk/QP/Avg	degrees	meters	
2998.330	46.7	V	70.0	-23.3	Peak	130	1.0	
4823.990	44.0	V	54.0	-10.0	Peak	134	1.6	

**Final measurements at 3m**

Frequency	Level	Pol	15.209/15.247		Detector	Azimuth	Height	Comments
MHz	dBμV/m	v/h	Limit	Margin	Pk/QP/Avg	degrees	meters	
4824.030	43.1	V	54.0	-10.9	AVG	131	1.0	RB 1 MHz;VB 10 Hz;Pk
4823.990	47.7	V	74.0	-26.3	PK	131	1.0	RB 1 MHz;VB 3 MHz;Pk

Note: 4924 MHz is directly related to the WiFi (802.11b) signal and was observed during the 802.11b mode spurious measurements.

Client:	Intel Corporation	Job Number:	J84365
Model:	Intel® Centrino® Advanced-N 6235	T-Log Number:	T80540.2
Contact:	Steve Hackett	Account Manager:	Christine Krebill
Standard:	FCC 15.247	Class:	N/A

### Spurious Radiated Emissions, 2 - 3GHz

*Preliminary Scan at ~ 20cm from the product to identify potential signals (Peak versus average limit)*

No preamplifier used for these scans

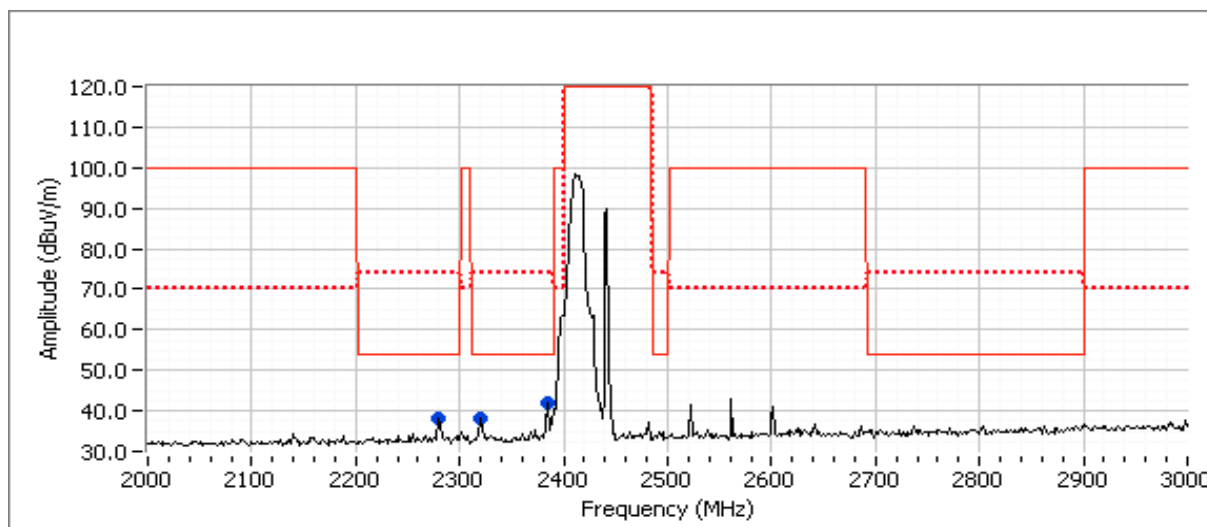

### Preliminary measurements at ~ 20cm, RB=1MHz, VB=100kHz

Frequency	Level	Pol	15.209/15.247		Detector	Azimuth	Height	Comments
MHz	dBuV/m	v/h	Limit	Margin	Pk/QP/Avg	degrees	meters	
2385.000	42.2	V	54.0	-11.8	Peak	192	1.0	
2320.000	38.2	V	54.0	-15.8	Peak	192	1.0	
2280.000	38.2	V	54.0	-15.8	Peak	192	1.0	

### Final measurements at 3m

Frequency	Level	Pol	15.209/15.247		Detector	Azimuth	Height	Comments
MHz	dBuV/m	v/h	Limit	Margin	Pk/QP/Avg	degrees	meters	
2383.860	46.4	H	54.0	-7.6	AVG	350	1.0	RB 1 MHz;VB 10 Hz;Pk
2384.460	59.4	H	74.0	-14.6	PK	350	1.0	RB 1 MHz;VB 3 MHz;Pk
2319.970	46.4	H	54.0	-7.6	AVG	3	1.1	RB 1 MHz;VB 10 Hz;Pk
2320.330	56.0	H	74.0	-18.0	PK	3	1.1	RB 1 MHz;VB 3 MHz;Pk
2279.900	44.6	H	54.0	-9.4	AVG	68	1.0	RB 1 MHz;VB 10 Hz;Pk
2279.060	55.4	H	74.0	-18.6	PK	68	1.0	RB 1 MHz;VB 3 MHz;Pk
2384.170	45.9	V	54.0	-8.1	AVG	205	1.5	RB 1 MHz;VB 10 Hz;Pk
2386.600	59.7	V	74.0	-14.3	PK	205	1.5	RB 1 MHz;VB 3 MHz;Pk

Note 1: For emissions in restricted bands, the limit of 15.209 was used. For all other emissions, the limit is -30dBc for peak measurements in a measurement bandwidth of 100kHz.

Note 2: Signal is only present when Bluetooth is enabled, average correction for hopping occupancy could be applied

Note 3: Signal is present when Bluetooth is disabled (powered off)

Client:	Intel Corporation	Job Number:	J84365
Model:	Intel® Centrino® Advanced-N 6235	T-Log Number:	T80540.2
Contact:	Steve Hackett	Account Manager:	Christine Krebill
Standard:	FCC 15.247	Class:	N/A

Run # 10, Rainbow Peak 2x2: 1-15GHz, 802.11n20 @ 5200 MHz Chain A and B, BT Basic Rate @ 2440 MHz Chain B

	Target (dBm)	Power Settings Measured (dBm)	Software Setting
WiFi A	16.5	16.6	31.5
WiFi B	16.5	16.7	30.5
Bluetooth	7.0	5.4	8.0

Spurious Radiated Emissions, 7 - 15GHz:  
Preamplifier and high pass filter used for these scans

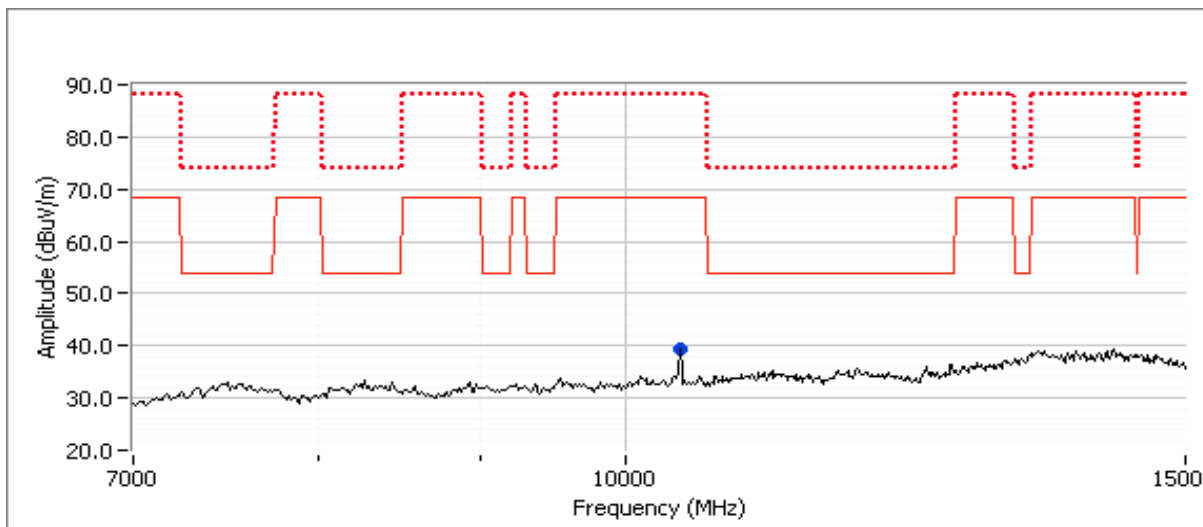

**Preliminary Measurements (Peak versus average limit)**

Frequency	Level	Pol	15.209/15.247/15E		Detector	Azimuth	Height	Comments
MHz	dB $\mu$ V/m	v/h	Limit	Margin	Pk/QP/Avg	degrees	meters	
10400.000	39.4	V	68.3	-28.9	Peak	198	1.3	

Client:	Intel Corporation	Job Number:	J84365
Model:	Intel® Centrino® Advanced-N 6235	T-Log Number:	T80540.2
Contact:	Steve Hackett	Account Manager:	Christine Krebill
Standard:	FCC 15.247	Class:	N/A

### Spurious Radiated Emissions, 1 - 7GHz (Scans from 1 - 3.5GHz and 3.5 - 7GHz)

*Preliminary Scan at ~ 20cm from the product (card and antenna) to identify potential signals (Peak versus average limit)*

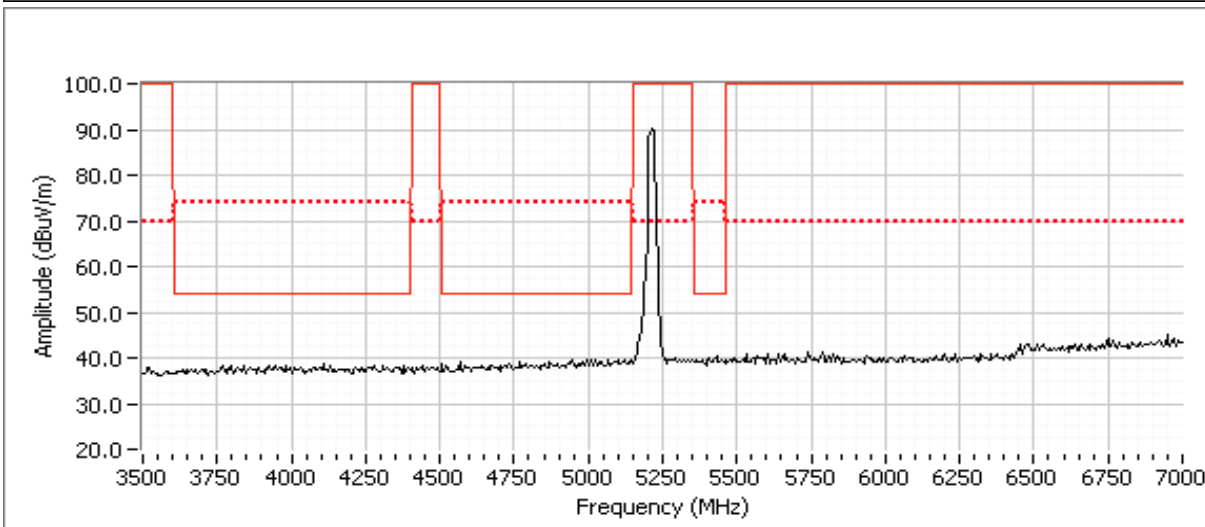
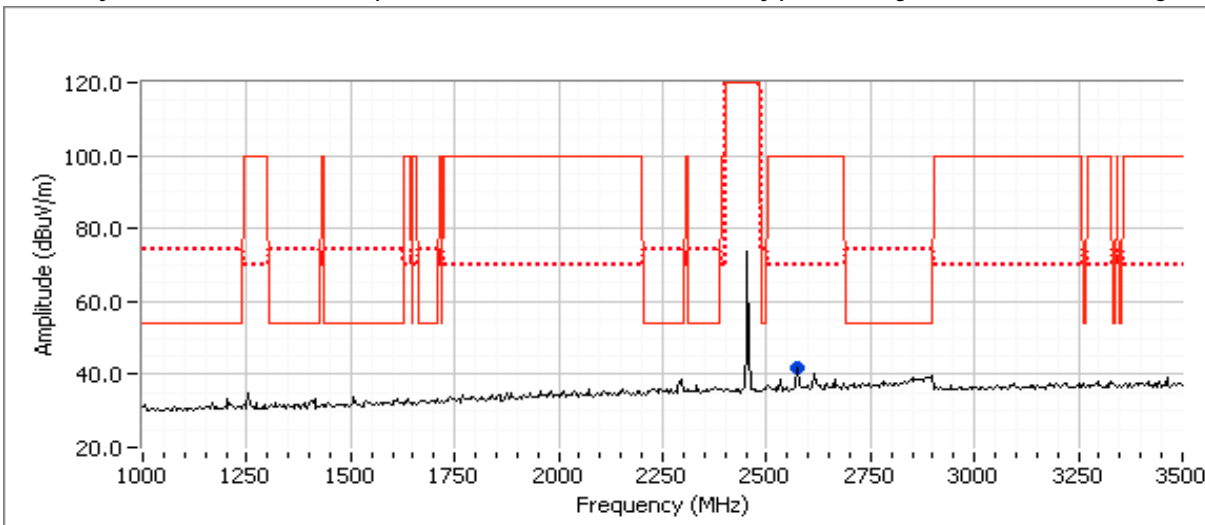

Client:	Intel Corporation	Job Number:	J84365
Model:	Intel® Centrino® Advanced-N 6235	T-Log Number:	T80540.2
Contact:	Steve Hackett	Account Manager:	Christine Krebill
Standard:	FCC 15.247	Class:	N/A

**Spurious Radiated Emissions, 1 - 7GHz (Scans from 1 - 3.5GHz and 3.5 - 7GHz)**

**Preliminary measurements at ~ 20cm, RB=1MHz, VB=100kHz**

Frequency	Level	Pol	15.209/15.247		Detector	Azimuth	Height	Comments
MHz	dB $\mu$ V/m	v/h	Limit	Margin	Pk/QP/Avg	degrees	meters	
2560.000	40.1	V	100.0	-59.9	Peak	360	1.0	

**Final measurements at 3m**

Frequency	Level	Pol	15.209/15.247		Detector	Azimuth	Height	Comments
MHz	dB $\mu$ V/m	v/h	Limit	Margin	Pk/QP/Avg	degrees	meters	
2280.000	41.9	H	54.0	-12.1	AVG	0	1.2	RB 1 MHz;VB 10 Hz;Pk Note 2
2320.000	41.7	V	54.0	-12.3	AVG	77	1.3	RB 1 MHz;VB 10 Hz;Pk Note 2
2360.000	39.6	V	54.0	-14.4	AVG	77	1.2	RB 1 MHz;VB 10 Hz;Pk Note 2
2320.000	39.4	H	54.0	-14.6	AVG	206	1.3	RB 1 MHz;VB 10 Hz;Pk Note 2
2360.000	38.1	H	54.0	-15.9	AVG	39	1.2	RB 1 MHz;VB 10 Hz;Pk Note 2
2280.000	37.8	V	54.0	-16.2	AVG	140	1.0	RB 1 MHz;VB 10 Hz;Pk Note 2
2320.000	55.0	V	74.0	-19.0	PK	77	1.3	RB 1 MHz;VB 3 MHz;Pk Note 2
2560.000	50.6	H	70.0	-19.4	PK	168	1.4	RB 1 MHz;VB 3 MHz;Pk Note 2
2560.000	46.9	V	70.0	-23.1	PK	216	1.9	RB 1 MHz;VB 3 MHz;Pk Note 2
2280.000	46.8	H	74.0	-27.2	PK	0	1.2	RB 1 MHz;VB 3 MHz;Pk Note 2
2320.000	46.2	H	74.0	-27.8	PK	206	1.3	RB 1 MHz;VB 3 MHz;Pk Note 2
2360.000	45.4	V	74.0	-28.6	PK	77	1.2	RB 1 MHz;VB 3 MHz;Pk Note 2
2360.000	44.3	H	74.0	-29.7	PK	39	1.2	RB 1 MHz;VB 3 MHz;Pk Note 2
2280.000	44.0	V	74.0	-30.0	PK	140	1.0	RB 1 MHz;VB 3 MHz;Pk Note 2
2560.000	46.3	H	100.0	-53.7	AVG	168	1.4	RB 1 MHz;VB 10 Hz;Pk Note 2
2560.000	40.5	V	100.0	-59.5	AVG	216	1.9	RB 1 MHz;VB 10 Hz;Pk Note 2

Note 1: For emissions in restricted bands, the limit of 15.209 was used. For all other emissions, the limit is -30dBc for peak measurements in a measurement bandwidth of 100kHz.

Note 2: Signal is only present when Bluetooth is enabled, average correction for hopping occupancy could be applied

Client:	Intel Corporation	Job Number:	J84365
Model:	Intel® Centrino® Advanced-N 6235	T-Log Number:	T80540.2
Contact:	Steve Hackett	Account Manager:	Christine Krebill
Standard:	FCC 15.247	Class:	N/A

Run # 11, Rainbow Peak 2x2: 1-15GHz, 802.11n20 @ 5300 MHz Chain A and B, BT Basic Rate @ 2440 MHz Chain B

	Target (dBm)	Power Settings Measured (dBm)	Software Setting
WiFi A	16.5	16.7	32.0
WiFi B	16.5	16.5	31.0
Bluetooth	7.0	5.4	8.0

Spurious Radiated Emissions, 7 - 15GHz:  
Preamplifier and high pass filter used for these scans

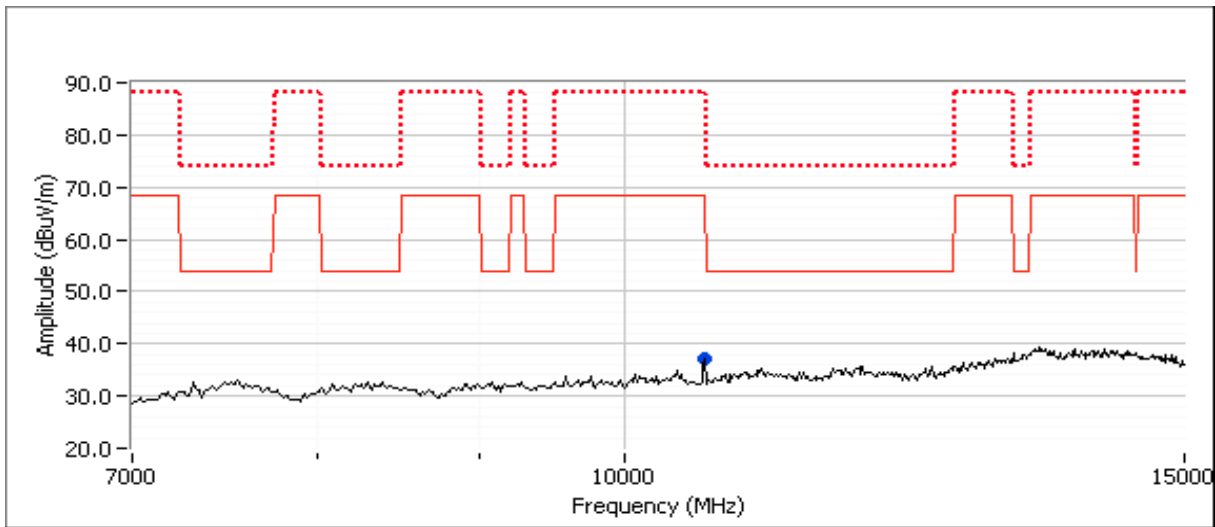

**Preliminary Measurements (Peak versus average limit)**

Frequency	Level	Pol	15.209/15.247/15E	Detector	Azimuth	Height	Comments
MHz	dB $\mu$ V/m	v/h	Limit	Margin	Pk/QP/Avg	degrees	meters
10600.000	37.2	V	54.0	-16.8	Peak	182	1.0

Client:	Intel Corporation	Job Number:	J84365
Model:	Intel® Centrino® Advanced-N 6235	T-Log Number:	T80540.2
Contact:	Steve Hackett	Account Manager:	Christine Krebill
Standard:	FCC 15.247	Class:	N/A

**Spurious Radiated Emissions, 1 - 7GHz (Scans from 1 - 3.5GHz and 3.5 - 7GHz)**

*Preliminary Scan at ~ 20cm from the product (card and antenna) to identify potential signals (Peak versus average limit)*

No preamplifier used for these scans

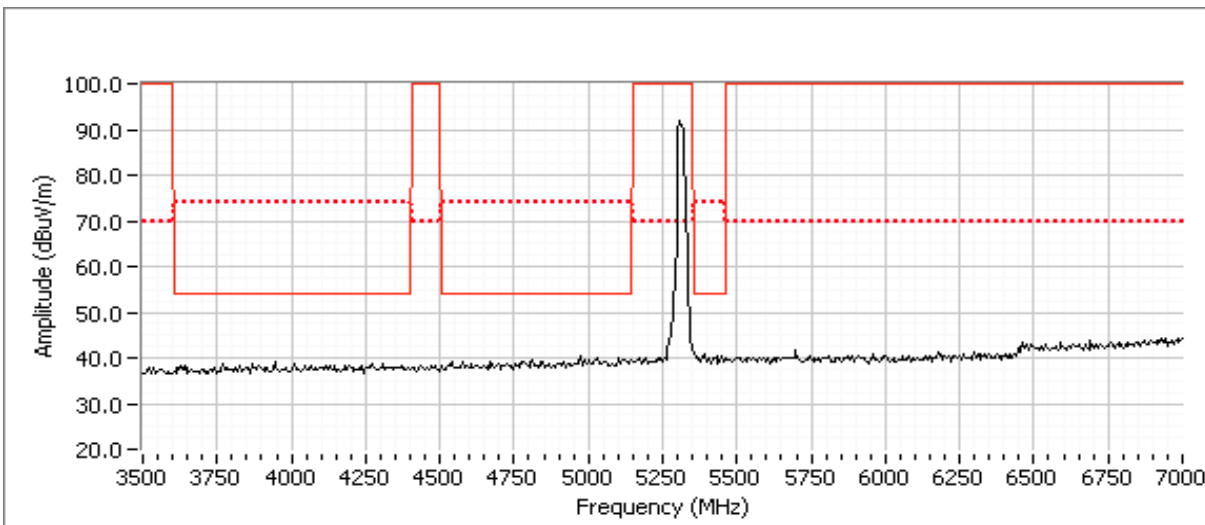
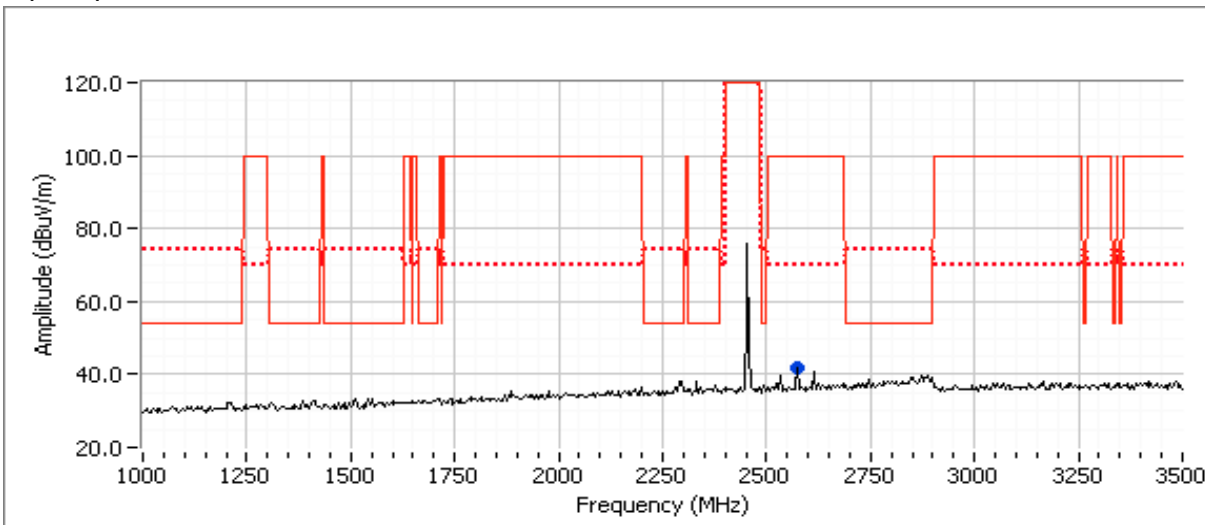

Note 1: The emissions observed above the noise floor are the same as those observed with the Wi-Fi radio at 5200 MHz (Run 10) and are unaffected when the Wi-Fi radio is disabled (powered off). Additional measurements were therefore not necessary.



Client:	Intel Corporation	Job Number:	J84365
Model:	Intel® Centrino® Advanced-N 6235	T-Log Number:	T80540.2
Contact:	Steve Hackett	Account Manager:	Christine Krebill
Standard:	FCC 15.247	Class:	N/A

Run # 12, Rainbow Peak 2x2: 1-15GHz, 802.11n20 @ 5600 MHz Chain A and B, BT Basic Rate @ 2440 MHz Chain B

	Target (dBm)	Power Settings Measured (dBm)	Software Setting
WiFi A	16.5	16.5	34.0
WiFi B	16.5	16.5	34.0
Bluetooth	7.0	5.4	8.0

Spurious Radiated Emissions, 7 - 15GHz:  
Preamplifier and high pass filter used for these scans

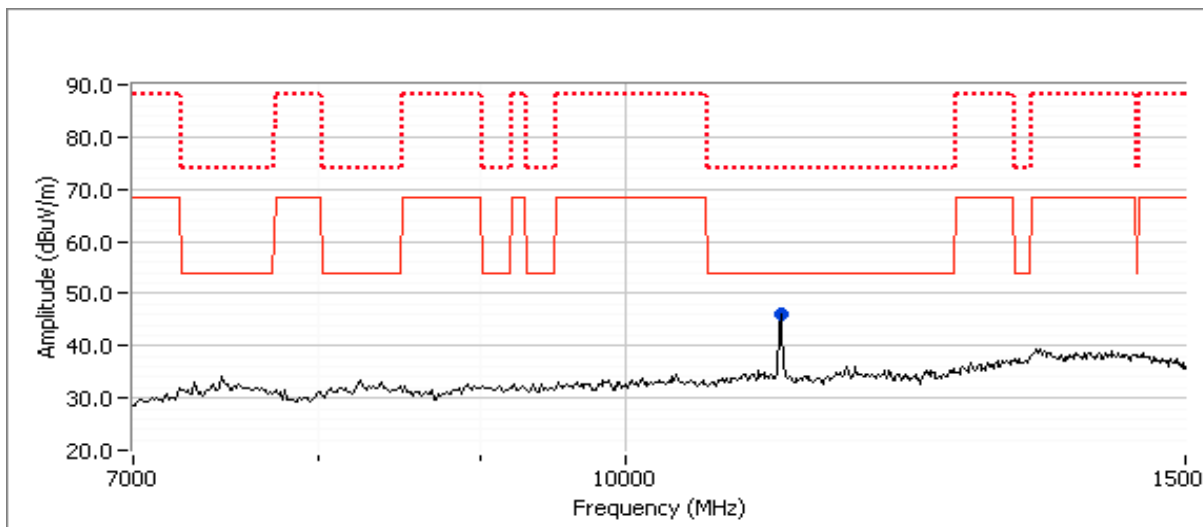

**Preliminary Measurements (Peak versus average limit)**

Frequency	Level	Pol	15.209/15.247/15E		Detector	Azimuth	Height	Comments
MHz	dBμV/m	v/h	Limit	Margin	Pk/QP/Avg	degrees	meters	
11200.340	46.0	V	54.0	-8.0	Peak	188	1.0	

**Final measurements at 3m**

Frequency	Level	Pol	15.209/15.247/15E		Detector	Azimuth	Height	Comments
MHz	dBμV/m	v/h	Limit	Margin	Pk/QP/Avg	degrees	meters	
11199.810	45.1	V	54.0	-8.9	AVG	157	1.9	RB 1 MHz;VB 10 Hz;Pk
11200.110	61.2	V	74.0	-12.8	PK	157	1.9	RB 1 MHz;VB 3 MHz;Pk

Client:	Intel Corporation	Job Number:	J84365
Model:	Intel® Centrino® Advanced-N 6235	T-Log Number:	T80540.2
Contact:	Steve Hackett	Account Manager:	Christine Krebill
Standard:	FCC 15.247	Class:	N/A

**Spurious Radiated Emissions, 1 - 7GHz (Scans from 1 - 3.5GHz and 3.5 - 7GHz)**

*Preliminary Scan at ~ 20cm from the product (card and antenna) to identify potential signals (Peak versus average limit)*

No preamplifier used for these scans

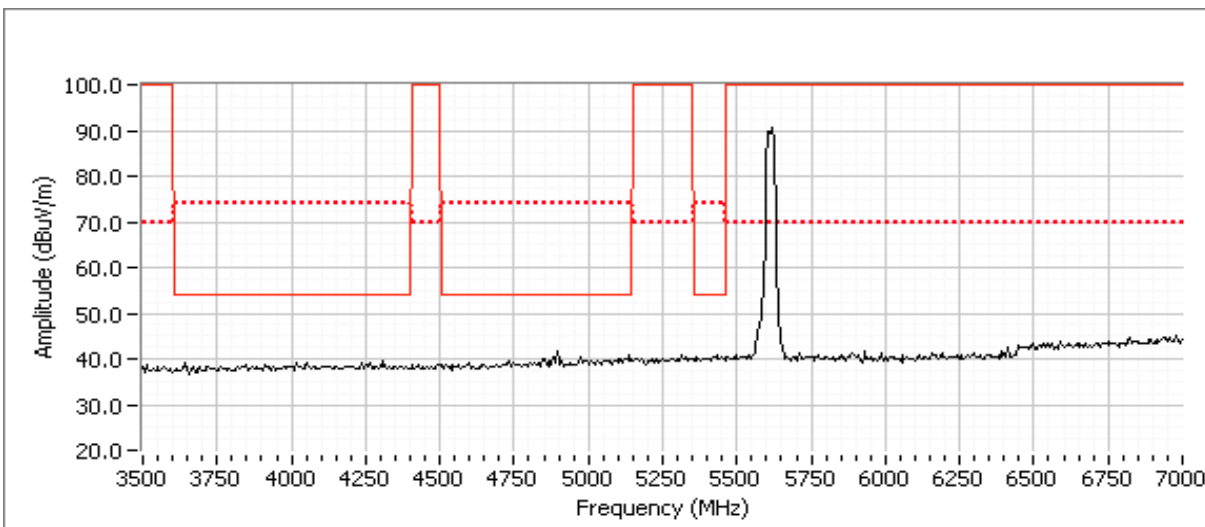
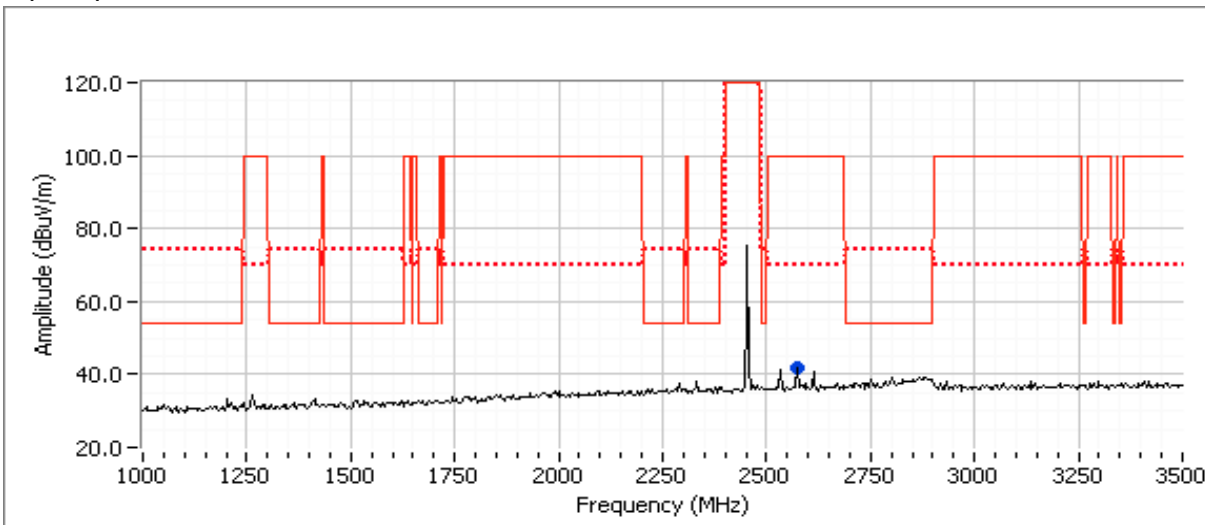

Note 1: The emissions observed above the noise floor are the same as those observed with the Wi-Fi radio at 5200 MHz (Run 10) and are unaffected when the Wi-Fi radio is disabled (powered off). Additional measurements were therefore not necessary.

Client:	Intel Corporation	Job Number:	J84365
Model:	Intel® Centrino® Advanced-N 6235	T-Log Number:	T80540.2
Contact:	Steve Hackett	Account Manager:	Christine Krebill
Standard:	FCC 15.247	Class:	N/A

Run # 13, Rainbow Peak 2x2: 1-15GHz, 802.11n20 @ 5785 MHz Chain A and B, BT Basic Rate @ 2440 MHz Chain B

	Target (dBm)	Power Settings Measured (dBm)	Software Setting
WiFi A	16.5	16.5	35.0
WiFi B	16.5	16.7	34.5
Bluetooth	7.0	5.4	8.0

Spurious Radiated Emissions, 7 - 15GHz:  
Preamplifier and high pass filter used for these scans

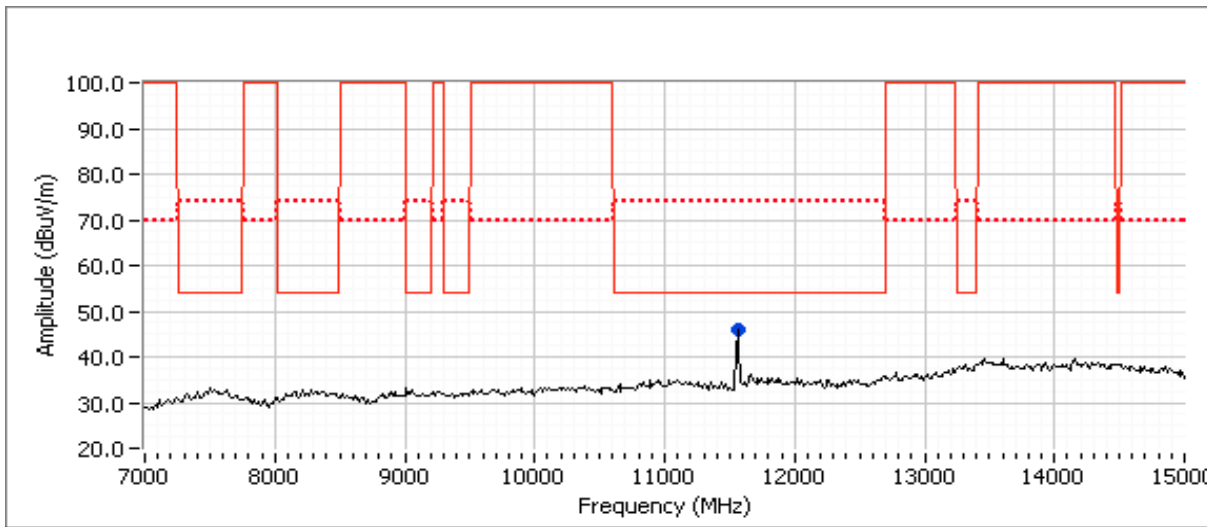

**Preliminary Measurements (Peak versus average limit)**

Frequency	Level	Pol	15.209/15.247/15E		Detector	Azimuth	Height	Comments
MHz	dB $\mu$ V/m	v/h	Limit	Margin	PK/QP/Avg	degrees	meters	
11570.410	45.9	V	54.0	-8.1	Peak	187	1.0	

**Final measurements at 3m**

Frequency	Level	Pol	15.209/15.247/15E		Detector	Azimuth	Height	Comments
MHz	dB $\mu$ V/m	v/h	Limit	Margin	PK/QP/Avg	degrees	meters	
11570.680	44.7	V	54.0	-9.3	AVG	192	1.4	RB 1 MHz;VB 10 Hz;Pk
11570.280	57.8	V	74.0	-16.2	PK	192	1.4	RB 1 MHz;VB 3 MHz;Pk

Client:	Intel Corporation	Job Number:	J84365
Model:	Intel® Centrino® Advanced-N 6235	T-Log Number:	T80540.2
Contact:	Steve Hackett	Account Manager:	Christine Krebill
Standard:	FCC 15.247	Class:	N/A

### Spurious Radiated Emissions, 1 - 7GHz (Scans from 1 - 3.5GHz and 3.5 - 7GHz)

*Preliminary Scan at ~ 20cm from the product (card and antenna) to identify potential signals (Peak versus average limit)*

No preamplifier used for these scans

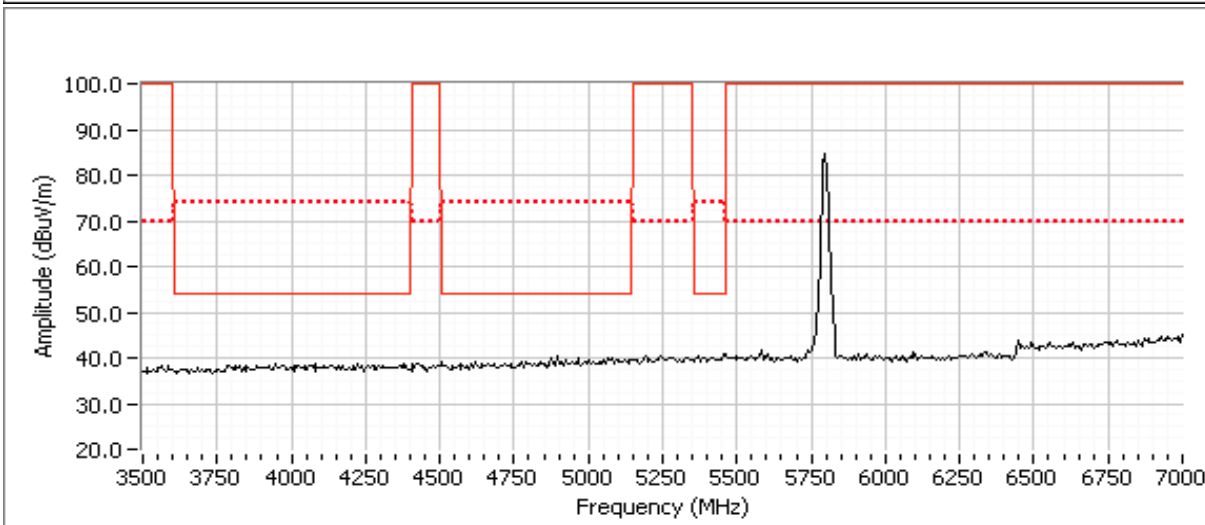
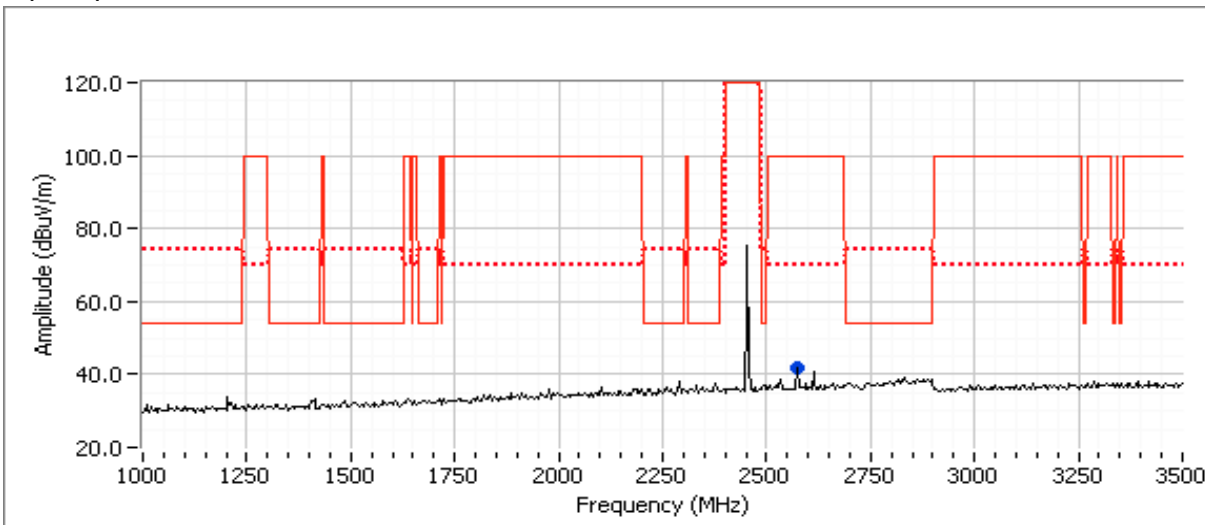

Note 1: The emissions observed above the noise floor are the same as those observed with the Wi-Fi radio at 5200 MHz (Run 10) and are unaffected when the Wi-Fi radio is disabled (powered off). Additional measurements were therefore not necessary.

*End of Report*

This page is intentionally blank and marks the last page of this test report.