

*Getac*

V100  
USER'S MANUAL

Rugged Mobile Computing Solutions

July 2010

**TRADEMARKS**

All brand and product names are trademarks or registered trademarks of their respective companies.

**NOTE**

The information in this manual is subject to change without notice.



For the latest version of the manual, please visit the Getac website at [www.getac.com](http://www.getac.com).



ENERGY STAR® is a government program that offers businesses and consumers energy-efficient solutions, making it easy to save money while protecting the environment for future generations.

Please reference ENERGY STAR® related information from **[www.energystar.gov](http://www.energystar.gov)**.

As an ENERGY STAR® Partner, Getac Technology Corporation has determined that this product meets the ENERGY STAR® guidelines for energy efficiency.

An ENERGY STAR® qualified computer uses 70 % less electricity than computers without enabled power management features.

### **Earning the ENERGY STAR®**

- When every home office is powered by equipment that has earned the ENERGY STAR®, the change will keep over 289 billion pounds of greenhouse gases out of the air.
- If left inactive, ENERGY STAR® qualified computers enter a low-power mode and may use 15 watts or less. New chip technologies make power management features more reliable, dependable, and user-friendly than even just a few years ago.



- Spending a large portion of time in low-power mode not only saves energy, but helps equipment run cooler and last longer.
- Businesses that use ENERGY STAR® enabled office equipment may realize additional savings on air conditioning and maintenance.
- Over its lifetime, ENERGY STAR® qualified equipment in a single home office (e.g., computer, monitor, printer, and fax) can save enough electricity to light an entire home for more than 4 years.
- Power management (“sleep settings”) on computers and monitors can result in much savings annually.

## **Remember, saving energy prevents pollution**

Because most computer equipment is left on 24 hours a day, power management features are important for saving energy and are an easy way to reduce air pollution. By using less energy, these products help lower consumers’ utility bills, and prevent greenhouse gas emissions.



LEARN MORE AT  
[energystar.gov](http://energystar.gov)

# Table of Contents

|  |            |
|--|------------|
| <b>Chapter 1 Getting Started.....</b>          | <b>1-1</b> |
| Getting the Computer Running .....             | 1-2        |
| Unpacking .....                                | 1-2        |
| Connecting to AC Power .....                   | 1-3        |
| Opening and Closing the Cover.....             | 1-4        |
| Operating in Tablet Mode.....                  | 1-6        |
| Turning On and Off the Computer.....           | 1-8        |
| Attaching the Hand Strap .....                 | 1-9        |
| Taking a Look at the Computer .....            | 1-11       |
| Front Components .....                         | 1-11       |
| Rear Components.....                           | 1-13       |
| Right-Side Components.....                     | 1-14       |
| Left-Side Components.....                      | 1-14       |
| Bottom Components.....                         | 1-16       |
| Top-open Components .....                      | 1-17       |
| <b>Chapter 2 Operating Your Computer .....</b> | <b>2-1</b> |
| Starting and Stopping the Computer .....       | 2-2        |
| Starting the Computer .....                    | 2-2        |
| Stopping the Computer.....                     | 2-2        |
| Using the Internal Keyboard .....              | 2-4        |
| Typewriter Keys.....                           | 2-4        |
| Cursor-Control Keys .....                      | 2-4        |
| Numeric Keypad .....                           | 2-5        |



|   |            |
|---|------------|
| Function Keys .....                               | 2-6        |
| Fn Key .....                                      | 2-6        |
| Hot Keys .....                                    | 2-6        |
| Using the Software Keyboard .....                 | 2-8        |
| Using the Touchpad .....                          | 2-9        |
| Configuring the Touchpad .....                    | 2-11       |
| Navigating on the Screen .....                    | 2-12       |
| Using the Touchscreen .....                       | 2-12       |
| Using Multi-touch Gestures (Windows 7 Only) ..... | 2-13       |
| Using the Dual Mode Display (Optional) .....      | 2-16       |
| Using the Hard Disk Drive .....                   | 2-19       |
| Using OSD Control Panel .....                     | 2-20       |
| Using the Fingerprint Scanner (Optional) .....    | 2-21       |
| Using the Video Features.....                     | 2-23       |
| Configuring the Display Modes .....               | 2-24       |
| Using Landscape or Portrait View.....             | 2-24       |
| Using the Audio Features.....                     | 2-26       |
| Connecting Audio Devices.....                     | 2-27       |
| Using G-Camera Lite.....                          | 2-28       |
| Using the Communication Features .....            | 2-29       |
| Using the Modem.....                              | 2-29       |
| Using the LAN.....                                | 2-30       |
| Using the Wireless LAN .....                      | 2-31       |
| Using the Bluetooth Feature (Optional).....       | 2-33       |
| Using the GPS .....                               | 2-37       |
| <b>Chapter 3 Managing Power .....</b>             | <b>3-1</b> |
| AC Adapter .....                                  | 3-2        |
| Battery Pack .....                                | 3-3        |
| Charging the Battery Pack.....                    | 3-3        |
| Checking the Battery Level.....                   | 3-4        |
| Replacing the Battery Pack .....                  | 3-5        |
| Battery Low Signals and Actions.....              | 3-7        |

|  |            |
|--|------------|
| Power Management .....   | 3-8        |
| Hibernation.....   | 3-9        |
| Power-Saving Tips .....  | 3-10       |
| <b>Chapter 4 Expanding Your Computer .....</b>                   | <b>4-1</b> |
| Connecting an External Monitor (Optional) .....                  | 4-2        |
| Connecting a Serial Device .....                                 | 4-4        |
| Connecting a USB Device .....                                    | 4-5        |
| Connecting an eSATA Device .....                                 | 4-6        |
| Using Smart Cards (Optional) .....                               | 4-7        |
| Inserting and Removing a Smart Card .....                        | 4-7        |
| Using PC Cards.....  | 4-9        |
| Inserting and Removing a PC Card .....                           | 4-9        |
| Using ExpressCards (Optional).....                               | 4-11       |
| ExpressCard Type .....   | 4-11       |
| Inserting and Removing an ExpressCard .....                      | 4-12       |
| Using the Card Reader .....                                      | 4-13       |
| Using the Port Replicator (Optional).....                        | 4-15       |
| System Memory Upgrade.....                                       | 4-17       |
| <b>Chapter 5 Using BIOS Setup and System Recovery .....</b>      | <b>5-1</b> |
| BIOS Setup .....   | 5-2        |
| When to Use .....  | 5-2        |
| How to Use .....   | 5-2        |
| Main Menu .....  | 5-5        |
| Advanced Menu.....   | 5-6        |
| Security Menu .....  | 5-7        |
| Boot Menu.....   | 5-9        |
| Exit Menu .....  | 5-10       |
| System Recovery .....  | 5-12       |
| <b>Chapter 6 Installing Software Drivers and Utilities .....</b> | <b>6-1</b> |
| How to Use the Driver Disc .....                                 | 6-2        |
| Installation for Windows XP.....                                 | 6-3        |



|   |            |
|---|------------|
| Drivers on the First Page .....   | 6-3        |
| Drivers on the Second Page .....  | 6-4        |
| Drivers on the Third Page .....   | 6-5        |
| Installation for Windows Vista .....  | 6-8        |
| Drivers on the First Page .....   | 6-8        |
| Drivers on the Second Page .....  | 6-9        |
| Drivers on the Third Page .....   | 6-10       |
| Installation for Windows 7 .....  | 6-13       |
| Drivers on the First Page .....   | 6-13       |
| Drivers on the Second Page .....  | 6-14       |
| Drivers on the Third Page .....   | 6-15       |
| <b>Chapter 7 Using Getac Software.....</b>  | <b>7-1</b> |
| Using G-Manager .....   | 7-2        |
| Using Button Manager .....  | 7-4        |
| Using Getac Camera (Optional) .....   | 7-6        |
| Taking Pictures .....   | 7-8        |
| Viewing Images .....  | 7-10       |
| Viewing Image Properties .....  | 7-13       |
| Adding Notes to an Image .....  | 7-14       |
| Camera Settings .....   | 7-15       |
| Using Getac Barcode Reader (Optionl) .....  | 7-21       |
| Reading Barcodes .....  | 7-21       |
| Toolbar .....   | 7-24       |
| Floating Button and Shortcut Menu .....   | 7-25       |
| Barcode Reader Settings .....   | 7-26       |
| <b>Chapter 8 Caring for the Computer.....</b>                                       | <b>8-1</b> |
| Protecting the Computer .....   | 8-2        |
| Using an Anti-Virus Strategy .....  | 8-2        |
| Using Security Center (for Windows Vista) or Action Center<br>(for Windows 7) ..... | 8-2        |
| Using the Cable Lock .....  | 8-3        |
| Taking Care of the Computer .....   | 8-4        |

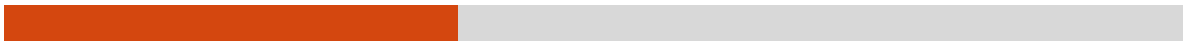



|   |            |
|---|------------|
| Location Guidelines.....                      | 8-4        |
| General Guidelines.....                       | 8-4        |
| Cleaning Guidelines.....                      | 8-5        |
| Battery Pack Guidelines.....                  | 8-5        |
| Touchscreen Guidelines.....                   | 8-6        |
| When Traveling.....                           | 8-8        |
| <b>Chapter 9 Troubleshooting.....</b>         | <b>9-1</b> |
| Preliminary Checklist.....                    | 9-2        |
| Solving Common Problems.....                  | 9-3        |
| Battery Problems.....                         | 9-3        |
| Bluetooth Problems.....                       | 9-3        |
| Display Problems.....                         | 9-4        |
| Hardware Device Problems.....                 | 9-5        |
| Hard Disk Drive Problems.....                 | 9-5        |
| Keyboard, Mouse, and Touchpad Problems.....   | 9-6        |
| LAN Problems.....                             | 9-6        |
| Modem Problems.....                           | 9-7        |
| PC Card Problems.....                         | 9-7        |
| Power Management Problems.....                | 9-7        |
| Software Problems.....                        | 9-8        |
| Sound Problems.....                           | 9-8        |
| Startup Problems.....                         | 9-9        |
| WLAN Problems.....                            | 9-10       |
| Other Problems.....                           | 9-11       |
| Resetting the Computer.....                   | 9-12       |
| <b>Appendix A Specifications.....</b>         | <b>A-1</b> |
| <b>Appendix B Regulatory Information.....</b> | <b>B-1</b> |
| On the Use of the System.....                 | B-2        |
| Class B Regulations.....                      | B-2        |
| UL1604 Installation Instructions.....         | B-3        |
| Safety Notices.....                           | B-4        |



On the Use of the RF Device.....B-7  
USA and Canada Safety Requirements and Notices...B-7  
European Union CE Marking and Compliance NoticesB-9



# Chapter 1

# Getting Started

Congratulations on purchasing this rugged computer.

This chapter first tells you step by step how to get the computer up and running. Then, you will find a section briefly introducing the external components of the computer.



# Getting the Computer Running

This section guides you through the procedures for getting the computer ready for operation.

## Unpacking

After unpacking the shipping carton, you should find these standard items:

- Notebook computer
- Accessories:
  - AC adapter
  - AC power cord
  - Grid-type hand strap
  - Driver disc
  - Stylus (option)
  - Digitizer pen and size "AAAA" battery (option)

Inspect all the items. If any item is damaged or missing, notify your dealer immediately.

Keep the shipping carton and packing materials in case you need to ship or store the computer in the future.

## Connecting to AC Power

The computer operates either on the external AC power or internal battery power. It is suggested that you use AC power when you start up the computer for the very first time.

**CAUTION:** Use only the AC adapter included with your computer. Using other AC adapters may damage the computer.

1. Make sure that the computer is turned off.
2. Plug the DC cord of the AC adapter to the power connector of the computer (❶).
3. Plug the female end of the AC power cord to the AC adapter and the male end to an electrical outlet (❷).

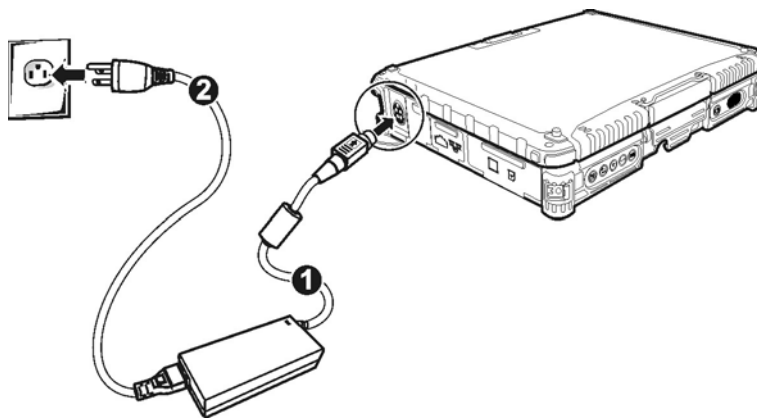

4. When the AC adapter is connected, power is being supplied from the electrical outlet to the AC adapter and onto your computer. Now, you are ready to turn on the computer.

**CAUTION:**

- When you disconnect the AC adapter, disconnect from the electrical outlet first and then from the computer. A reverse procedure may damage the AC adapter or the computer.
- When unplugging the connector, always hold the plug head. Never pull on the cord.

**NOTE:** When the AC adapter is connected, it also charges the battery pack. For information on using battery power, see Chapter 3.

## Opening and Closing the Cover

Open the top cover by pulling up on latch A and releasing latch B (❶) and lifting up the cover (❷). You can tilt the cover forward or backward for optimal viewing clarity.

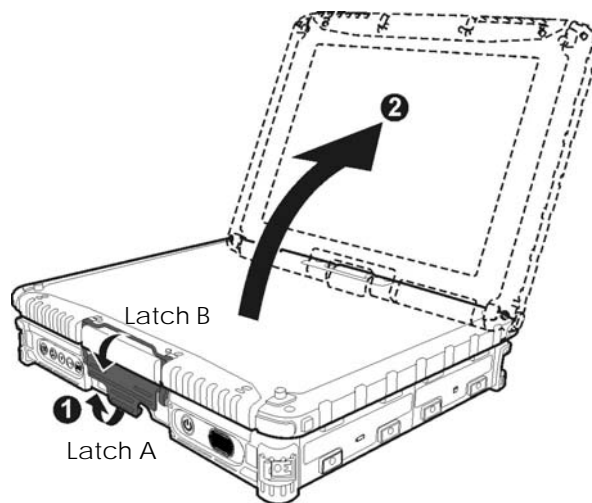

Close the top cover by closing the display (❶). Then position latch B on the display side and bring latch A down (❷) to fix the display in place.

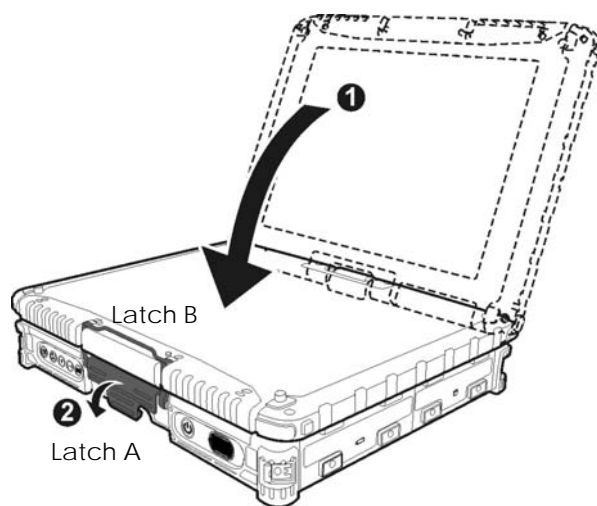

## Operating in Tablet Mode

In addition to being used as a regular notebook computer (Laptop mode), your computer can also be operated in Tablet mode. In Tablet mode, you operate the computer with a stylus or digitizer pen, or a fingertip, instead of a keyboard or mouse.

1. Open the top cover so that it is almost perpendicular with the keyboard of the computer.
2. Turn the display counter-clockwise by 165°.

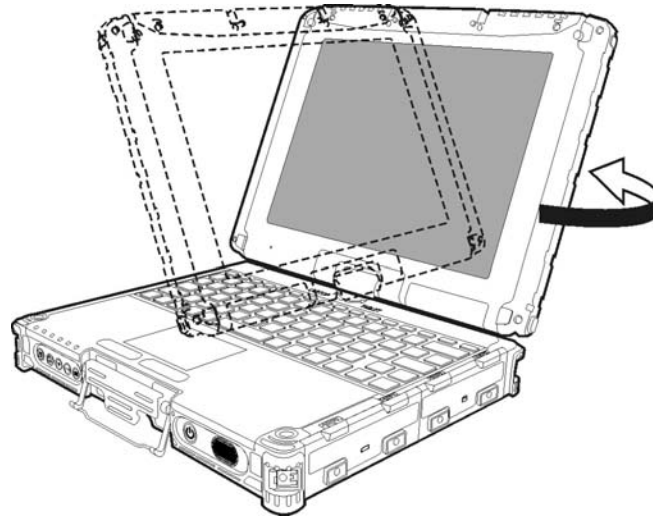

**CAUTION:** Do not rotate the display more than 165°, or attempt to rotate the display clockwise.

1. Close the computer with the display facing up (●). Then pull up on the latch A.



2. Position the latch B on the display side, then bring latch A down (2) to fix the display in place.

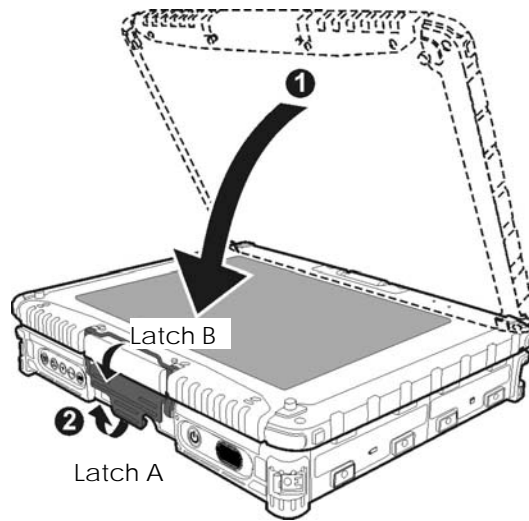

In Tablet mode, the computer can be operated while holding it as shown.

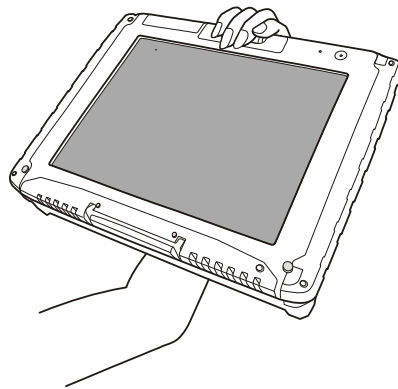

To return to Laptop mode, perform the steps for changing the computer into Tablet mode in reverse order.

# Turning On and Off the Computer

## Turning On

1. Make sure that the computer is connected to AC power.
2. Press the power button (  ).

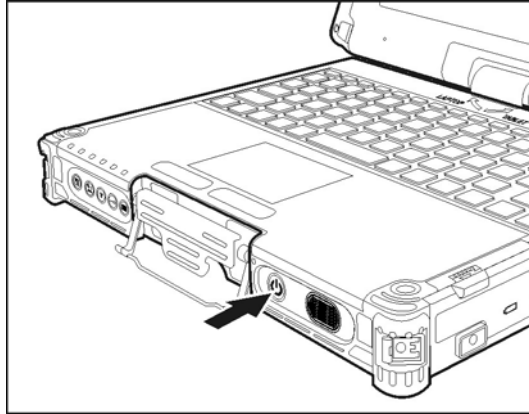

3. Each time the computer is turned on, it performs a Power-On Self Test (POST), and the operating system such as Windows should start.

## Turning Off

To turn off the computer power, use the “Shut Down” command of your operating system.

**NOTE:** There are other ways you can stop the computer so that you will be back to where you left off when you next turn on the computer. (See “Stopping the Computer” in Chapter 2 for information.)

**CAUTION:** If you have to turn the computer on again immediately after turning it off, wait for at least five seconds. Turning the computer off and on rapidly can damage it.

## Attaching the Hand Strap

The hand strap can be attached to any two sides of the four (option) corners of your computer.

Standard setup: two buckles on the left/right front side of your computer.

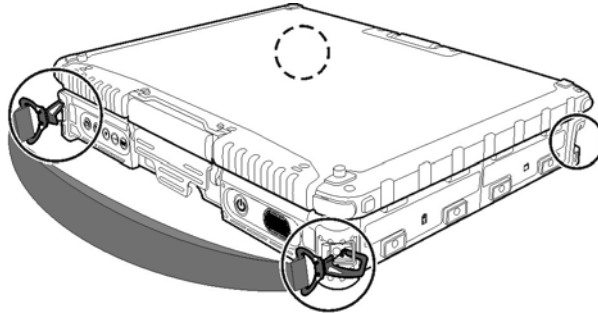

To release, press on the right spring latch first to detach the right side. Then release the left side.

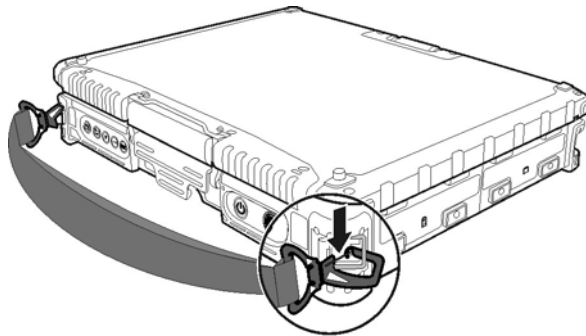

Optional setup: buckles on four corners of your computer.

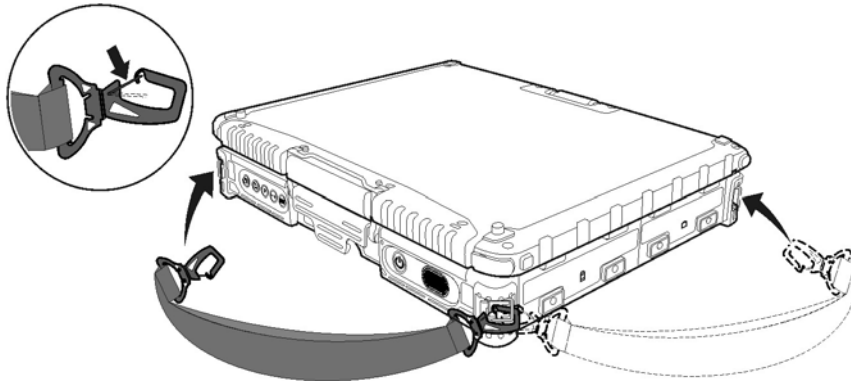

**CAUTION:**

- The strap has been designed to carry only the weight of the computer. Therefore, be sure that the strap does not carry a weight that exceeds the weight of the computer. The strap may accidentally come loose from the computer.
- Do not use a strap that is damaged or about to tear.







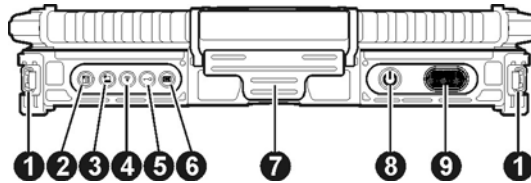

# Taking a Look at the Computer

**NOTE:** Depending on the model you purchased, the appearance of your computer may not be exactly the same as those shown in this manual.

## Front Components





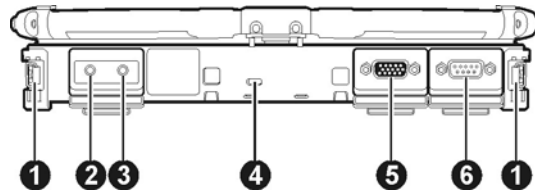

| Ref | Component   | Description  |
|-----|---|--|
| ①   | <b>Hand Strap Holder</b>  | The hand strap can be attached to the two holders for convenient handling of your computer.  |
| ②   | <b>OSD Control Button</b>          | Toggles the OSD (On Screen Display) control panel ON and OFF.  |
|     | <b>P1</b>   | Can be re-defined using the Button Manager utility. (See "Using Button Manager" in Chapter 7 for information.)   |
| ③   | <b>Sunlight-readable Button</b>  | Toggles the sunlight-readable function ON and OFF.<br><b>IMPORTANT:</b> To prevent burns to your fingers if using the computer (especially in Tablet Mode) with sunlight-readable mode turned on, do wear gloves when touching the top portion of the LCD display as it may be hot to the touch. |
|     | <b>P2</b>   | Can be re-defined using the Button Manager utility. (See "Using Button Manager" in Chapter 7 for information.)   |

| Ref | Component   | Description  |
|-----|---|--|
| ④   | <b>RF Button</b>                 | Toggles the wireless LAN /Bluetooth/3G radio frequency ON and OFF.   |
|     | <b>P3</b>   | Can be re-defined using the Button Manager utility. (See "Using Button Manager" in Chapter 7 for information.) |
| ⑤   | <b>Reset Button</b><br>          | Serves as the <b>Ctrl+Alt+Del</b> keyboard keys.   |
|     | <b>P4</b>   | Can be re-defined using the Button Manager utility. (See "Using Button Manager" in Chapter 7 for information.) |
| ⑥   | <b>Software Keyboard Button</b>  | Shows or hides the software keyboard on your LCD display.  |
|     | <b>P5</b>   | Can be re-defined using the Button Manager utility. (See "Using Button Manager" in Chapter 7 for information.) |
| ⑦   | <b>Top Cover Latch</b>  | Locks the top cover.   |
| ⑧   | <b>Power Button</b><br>          | Turns the computer power ON and OFF.   |
| ⑨   | <b>Speaker</b>  | Sends out sound and voice from your computer.  |



## Rear Components

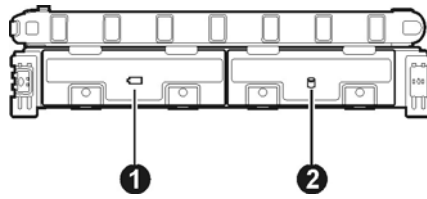

| Ref | Component   | Description   |
|-----|---|---|
| ①   | <b>Hand Strap Holder</b>  | The hand strap can be attached to the two holders for convenient handling of your computer.                           |
| ②   | <b>Audio Output Connector</b>  | Connects a set of headphones, external speakers with amplifier, or an audio recording device.                         |
| ③   | <b>Microphone Connector</b>    | Connects an external microphone.  |
| ④   | <b>Kensington Lock</b>  | Locks the computer to a stationary object for security.   |
| ⑤   | <b>VGA Connector</b><br>       | Connects an external display monitor.<br><b>NOTE:</b> Depending on your model, this port could be a serial connector. |
| ⑥   | <b>Serial Connector</b><br>  | Connects a serial mouse or serial communication device.   |

## Right-Side Components





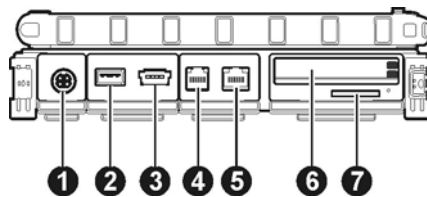

| Ref | Component  | Description   |
|-----|--|---|
| ①   | <b>Battery Pack Compartment</b>     | Inside is the battery pack that supplies power to your computer when external power is not connected. |
| ②   | <b>Hard Disk Drive Compartment</b>  | Inside is the hard disk drive.  |

## Left-Side Components



| Ref | Component  | Description              |
|-----|--|--------------------------|
| ①   | <b>Power Connector</b>  | Connects the AC adapter. |



|            |  |   |
|------------|--|---|
| <b>2</b>   | <b>USB Port</b>         | Connects a USB device, such as a flash disk, printer, digital camera, joystick, and more.                     |
| <b>Ref</b> | <b>Component</b>   | <b>Description</b>  |
| <b>3</b>   | <b>eSATA/USB Combo Port</b>  | Connects an eSATA device such as an external hard drive or optical drive.<br>Can also function as a USB port. |
| <b>4</b>   | <b>RJ-11 Connector</b>  | Connects the telephone line.  |
| <b>5</b>   | <b>RJ-45 Connector</b>  | Connects the LAN cable.   |
| <b>6</b>   | <b>ExpressCard Slot</b><br>(upper)   | Accepts an ExpressCard for additional functions (option).   |
|            | <b>PCMCIA Slot</b><br>(lower)  | Accepts a PC card for additional functions.   |
|            | or   |   |
|            | <b>PCMCIA Slot</b><br>(upper)  | Accepts a PC card for additional functions.   |
|            | <b>Smart Card Reader</b><br>(lower)  | Accepts a smart card for additional security feature (option).  |
| <b>7</b>   | <b>Card Reader</b>      | Accepts a SD (Secure Digital) card for removable storage media.   |

## Bottom Components

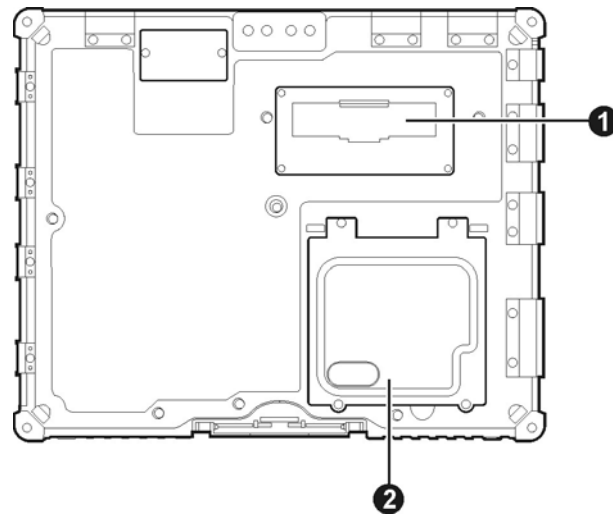





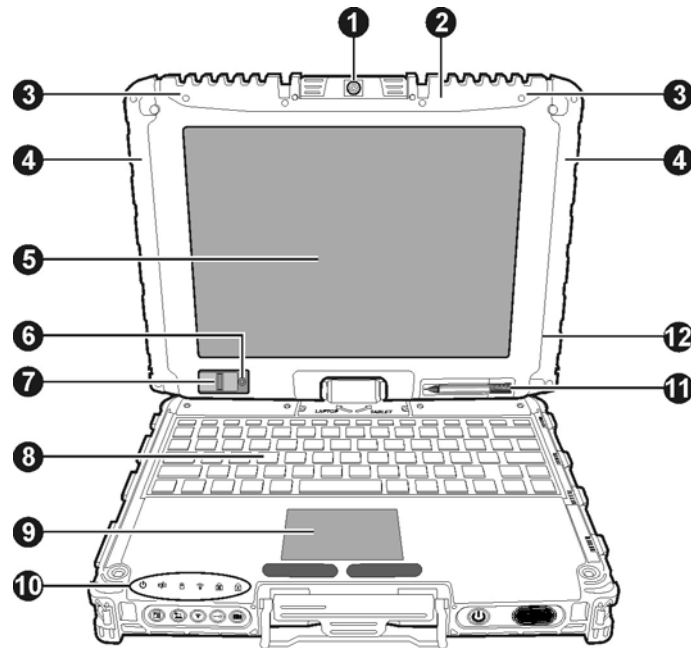

| Ref | Component                      | Description   |
|-----|--------------------------------|---|
| ❶   | <b>Expansion Bus Connector</b> | Inside is the expansion bus connector for using the Port Replicator option. |
| ❷   | <b>Memory Slots</b>            | Inside are the memory slots for expanding the memory size of your computer. |

## Top-open Components



| Ref | Component                          | Description  |
|-----|------------------------------------|--|
| ①   | <b>Webcam Lens</b><br>(option)     | Allows you to use your computer's camera function.                                   |
| ②   | <b>GPS Antenna</b><br>(option)     | Inside is the antenna for receiving GPS signals.                                     |
| ③   | <b>WLAN Antenna</b>                | Inside is the antenna for wireless LAN (local area network) transmission.            |
| ④   | <b>WWAN 3G Antenna</b><br>(option) | Inside is the antenna for optional wireless WAN (wide area network) 3G transmission. |
| ⑤   | <b>LCD Screen</b>                  | Displays the output of the computer.   |

| Ref | Component   | Description  |
|-----|---|--|
| ⑥   | <b>Light Sensor</b>   | Detects the surrounding lighting condition for automatic adjustment of the LCD brightness and optional keyboard backlight. |
| ⑦   | <b>Fingerprint Scanner</b> (option)   | Uses fingerprint verification to protect your computer against unauthorized access.  |
| ⑧   | <b>Keyboard</b>   | Serves as the data input device.   |
| ⑨   | <b>Touchpad</b>   | Serves as the pointing device.   |
| ⑩   | <b>Indicators</b>   | Show the current status of the computer's devices.   |
|     |  <b>AC Power</b>               | Lights green when the computer is turned on and using AC power.  |
|     |  <b>Battery Charge</b>         | Lights green when the battery is fully charged.  |
|     |   | Lights yellow when the battery is being charged.   |
|     |   | Blinks yellow when the battery's capacity is below 10%.  |
|     |   | Blinks green and yellow by turns when battery's temperature is too high (over 60°C).                                       |
|     |  <b>Hard Disk Drive In-Use</b> | Lights green when the computer is accessing the hard disk drive.   |
|     |   | Lights red when the optional hard disk drive heater is on for low temperature operation.                                   |
|     |  <b>RF</b>                   | Lights when the wireless LAN/Bluetooth/3G radio frequency is on.   |
|     |  <b>Num Lock</b>             | Lights when Num Lock is on.  |
|     |  <b>Caps Lock</b>            | Lights when Caps Lock is on.   |
| ⑪   | <b>Stylus/Digitizer Pen</b>   | Serves as the input device by tapping on the screen to make selections and enter information.                              |
| ⑫   | <b>Bluetooth Antenna</b>  | Inside is the antenna for optional Bluetooth feature   |

| Ref | Component | Description   |
|-----|-----------|---------------|
|     | (option)  | transmission. |





## Chapter 2

# Operating Your Computer

This chapter provides information about the use of the computer.

If you are new to computers, reading this chapter will help you learn the operating basics. If you are already a computer user, you may choose to read only the parts containing information unique to your computer.

**CAUTION:** The computer can get uncomfortably warm when you use it in high temperatures. As a safety precaution in such a circumstance, do not place the computer on your lap or touch it with your bare hands for extended periods of time. Prolonged body contact can cause discomfort and potentially a burn.

# Starting and Stopping the Computer

There are a number of ways to start and stop the computer.

## Starting the Computer

You always start the computer using the power button.

A computer starts up with an operating system (OS) existing on the storage device such as the hard disk. The computer will automatically load the OS after you turn it on. This process is called booting.

**NOTE:** An operating system is the platform for all your software application programs to run on. Your computer uses the Microsoft Windows operating system.

## Stopping the Computer

When you finish a working session, you can stop the computer by turning off the power or leaving the computer in Standby/Sleep or Hibernation mode:

| To stop in this mode... | Do this...  | To start up or resume again |
|-------------------------|---|-----------------------------|
| Off                     | Follow the shutdown procedure of your operating system. This can prevent loss of unsaved data or damage to your software programs.<br>If the system is locked up because of hardware or software problems, press the power button to turn off the computer. | Press the power button.     |
| Standby/Sleep           | Depending on your settings in Windows, you can place the  | Press any key.              |



| To stop in this mode... | Do this...   | To start up or resume again |
|-------------------------|--|-----------------------------|
|                         | computer in Standby/Sleep mode by: <ul style="list-style-type: none"> <li>• Closing the display cover</li> <li>• Pressing the <b>Fn+F10</b> hot key</li> <li>• Pressing the power button</li> </ul>          |                             |
| Hibernation             | Depending on your settings in Windows, you can place the computer in Hibernation mode by: <ul style="list-style-type: none"> <li>• Closing the display cover</li> <li>• Pressing the power button</li> </ul> | Press the power button.     |

If you choose to stop in Standby/Sleep or Hibernation mode, you can return to where you left off the next time you start up the computer. (See “Power Management” in Chapter 3 for more information.)

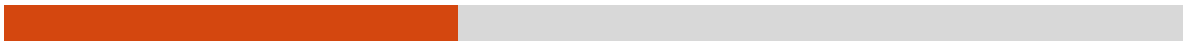

# Using the Internal Keyboard

Your keyboard has all the standard functions of a full-sized computer keyboard plus an **Fn** key added for specific functions.

The standard functions of the keyboard can be further divided into four major categories:

- Typewriter keys
- Cursor-control keys
- Numeric keys
- Function keys

## Typewriter Keys

Typewriter keys are similar to the keys on a typewriter. Several keys are added such as the **Ctrl**, **Alt**, **Esc**, and lock keys for special purposes. When the lock keys (**Caps Lock** and **Num Lk**) are pressed, their corresponding indicators light up.

The Control (**Ctrl**) / Alternate (**Alt**) key is normally used in combination with other keys for program-specific functions. The Escape (**Esc**) key is usually used for stopping a process. Examples are exiting a program and canceling a command. The function depends on the program you are using.

## Cursor-Control Keys

Cursor-control keys are generally used for moving and editing purposes. They are Home, End, Page Up, and Page Down. When used with **Fn** key, they become Left, Right, Up, and Down arrow keys.

**NOTE:** The word “cursor” refers to the indicator on the screen that lets you know exactly where on your screen anything you type will appear. It can take the form of a vertical or horizontal line, a block, or one of many other shapes.



## Numeric Keypad

A 15-key numeric keypad is embedded in the typewriter keys as shown next:



Numeric keys facilitate entering of numbers and calculations. When Num Lock is on, the numeric keys are activated; meaning you can use these keys to enter numerals.

### NOTE:

- When the numeric keypad is activated and you need to type the English letter in the keypad area, you can turn Num Lock off or you can press **Fn** and then the letter without turning Num Lock off.

- Some software may not be able to use the numeric keypad on the computer. If so, use the numeric keypad on an external keyboard instead.

## Function Keys

On the top row of the keys are the function keys: **F1** to **F12**. Function keys are multi-purpose keys that perform functions defined by individual programs.





## Fn Key

















The **Fn** key, at the lower left corner of the keyboard, is used with another key to perform the alternative function of a key. The letter “Fn” and the alternative functions are identified by the color of blue on the keytop. To perform a desired function, first press and hold **Fn**, then press the other key.

## Hot Keys



Hot keys refer to a combination of keys that can be pressed any time to activate special functions of the computer. Most hot keys operate in a cyclic way. Each time a hot key combination is pressed, it shifts the corresponding function to the other or next choice.



You can easily identify the hot keys with the icons imprinted on the keytop. The hot keys are described next.

| Key   | Description  |
|---|--|
|   | Switches the keyboard backlight on and off (optional).   |
|   | Switches the wireless LAN radio on and off.<br><b>NOTE:</b> This function works only if an optional mini PCI-E wireless LAN card is installed. |

| Key   | Description   |
|---|---|
|   | Decreases the sound volume.   |
|   | Increases the sound volume.   |
|   | Decreases the LCD brightness (20 levels).   |
|   | Increases the LCD brightness (20 levels).   |
|   | Switches the system sound output off (mute) and on.   |
|   | Switches LCD backlight on and off.  |
|   | Switches the display output when external devices are connected.<br><b>NOTE:</b> This function only applies to Plug & Play display devices. |
|   | Serves as the sleep button that you can define with Windows' <b>Power Options</b> . (See the "Power Management" in Chapter 3.)              |

## Windows Keys

The keyboard has two keys that perform Windows-specific functions:  Windows Logo key and  Application key.

The  Windows Logo key opens the **Start** menu and performs software-specific functions when used in combination with other keys. The  Application key usually has the same effect as a right mouse click. (See your Windows manual for more information.)

# Using the Software Keyboard

When using the computer in Tablet mode, you can use the software keyboard.

1. Press the software keyboard button (  ) and the software keyboard will appear onscreen.



(The above is for reference only. The actual one depends on your Windows version.)

2. Enter the characters with the stylus.

**NOTE:** To protect the LCD display, use the included stylus or digitizer pen on your touchscreen.

# Using the Touchpad

**CAUTION:** Do not use a sharp object such as a pen on the touchpad. Doing so may damage the touchpad surface.

**NOTE:** For optimal performance of the touchpad, keep your fingers and the pads clean and dry. When tapping on the pad, tap lightly. Do not use excessive force.

The touchpad is a pointing device that allows you to communicate with the computer by controlling the location of the pointer on the screen and making selection with the buttons.

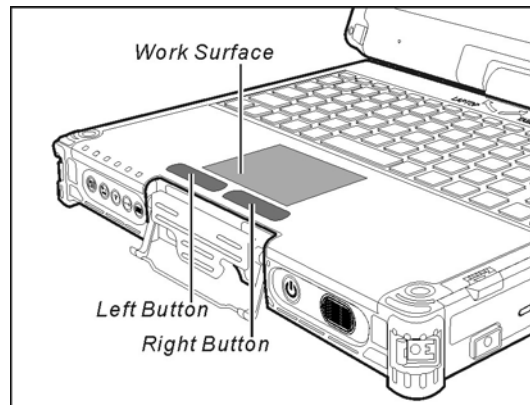

The touchpad consists of a rectangular pad (work surface) and a left and right buttons. To use the touchpad, place your forefinger or thumb on the pad. The rectangular pad acts like a miniature duplicate of your display. As you slide your fingertip across the pad, the pointer (also called cursor) on the screen moves accordingly. When your finger reaches the edge of the pad, simply relocate yourself by lifting the finger and placing it on the other side of the pad.

Here are some common terms that you should know when using the touchpad:

| Term          | Action   |
|---------------|--|
| Point         | Move your finger on the pad until the cursor points to the selection on the screen.  |
| Click         | Press and release the left button.<br>-or-<br>Tap gently anywhere on the pad.  |
| Double-click  | Press and release the left button twice in quick succession.<br>-or-<br>Tap twice on the pad rapidly.  |
| Drag and drop | Press and hold the left button, then move your finger until you reach your destination (drag). Finally, release the button (drop) when you finish dragging your selection to the destination. The object will drop into the new location.<br>-or-<br>Gently tap twice on the pad and on the second tap, keep your finger in contact with the pad. Then, move your finger across the pad to drag the selected object to your destination. When you lift your finger from the pad, the selected object will drop into place. |
| Scroll        | To scroll is to move up and down or left and right in the working area on the screen.<br>To move vertically, place your finger on the right or left edge of the pad and slide your finger up and down along the edge. To move horizontally, place your finger on the top or bottom edge of the pad and slide your finger left and right.<br>This function works only after you install the touchpad driver supplied with the computer and it may not work for all applications.  |





**TABLE NOTE:** If you swap the left and right buttons, “tapping” on the touchpad as an alternative method of pressing the left button will no longer be valid.

## Configuring the Touchpad

You may want to configure the touchpad to suit your needs. For example, if you are a left-handed user, you can swap the two buttons so that you can use the right button as the left button and vice versa. You can also change the size of the on-screen pointer, the speed of the pointer, and so on.

To configure the touchpad, go to **Control Panel → Mouse Properties**.

# Navigating on the Screen

The screen of your computer is touch-sensitive. You can control the location of the cursor/pointer on the screen using your finger or the included stylus or digitizer pen to communicate with the computer.

**CAUTION:** Do not use sharp objects on the LCD display. Doing so may damage the display surface. Use your finger or the included stylus or digitizer pen.

**NOTE:** When there is a noticeable discrepancy in the placement of the stylus on the screen and the indicated position of the onscreen pointer, calibrate the touchscreen using the calibration utility called **IdeaCom Calibration** on Windows XP/Vista or **CalTouch** on Windows 7.

## Using the Touchscreen

**NOTE:** Make sure the touchscreen driver has been installed properly.

If your computer is equipped with the touchscreen feature, you can use your finger or the included stylus to navigate and select objects on the screen.

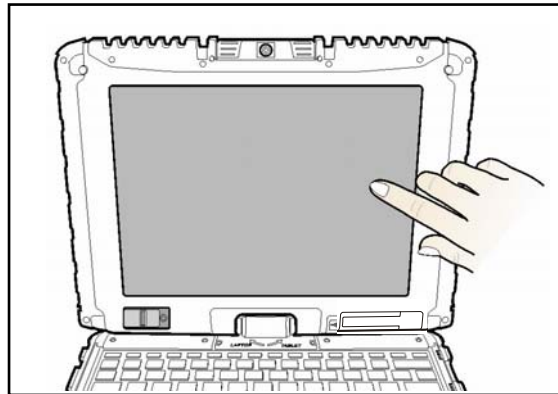

Here are some common terms that you should know when using the touchscreen:

| Term          | Action   |
|---------------|--|
| Click/Point   | Tap gently on the touchscreen.   |
| Double-click  | Tap twice on the touchscreen rapidly.  |
| Drag and drop | Tap lightly on the touchscreen and move your finger until you reach your destination (drag). Finally, release your finger (drop) when you finish dragging your selection to the destination. The object will drop into the new location. |

## Using Multi-touch Gestures (Windows 7 Only)

If your computer model comes with multi-touch-capable screen and Windows 7, you can interact with your computer by placing two fingers on the screen. The movement of the fingers across the screen creates "gestures," which send commands to the computer.

Here are the multi-touch gestures that you can use:

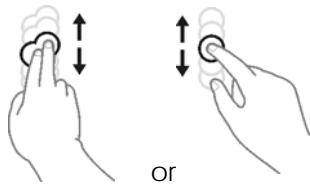
| Gestures        | Actions<br>☞ = finger down; ☺ = finger up  | Descriptions  |
|-----------------|--|---|
| Pan<br>(Scroll) |  <p>Drag 1 or 2 fingers up or down.</p> | Use panning to see another part of a page that has scroll bars. |

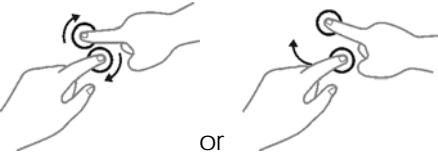
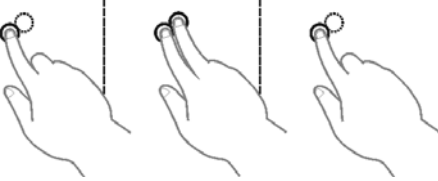
| Gestures        | Actions<br>☞ = finger down; ☺ = finger up)   | Descriptions  |
|-----------------|--|---|
| Zoom<br>(Pinch) |  <p data-bbox="486 448 893 510">Move two fingers apart/toward each other.</p>   | Use zooming to make an item (a photo for example) on the screen larger or smaller. The gesture works in applications that support mouse wheel zooming.                                    |
| Rotate          |  <p data-bbox="486 716 869 779">Move two fingers in opposing directions.</p> <p data-bbox="486 790 534 817">-or-</p> <p data-bbox="486 828 885 891">Use one finger to pivot around another.</p> | Use rotating to move a picture or other item on the screen in a circular direction (clockwise or counter-clockwise). The gesture works in applications that support the specific gesture. |
| Press and Tap   |  <p data-bbox="486 1108 885 1171">Press on target and tap using a second finger.</p>   | Use press and tap to access the shortcut menu.  |

| Gestures       | Actions<br>(☐ = finger down; ☐ = finger up)  | Descriptions  |
|----------------|--|---|
| Two-finger Tap | <p>Tap two fingers at the same time (where the target is in the midpoint between the fingers).</p> | The function is defined by applications that support the specific gesture.  |
| Flicks         | <p>Make quick drag gestures in the desired direction.</p>  | Flick left or right to navigate back and forward in a browser and other applications. The gesture works in most applications that support back and forward. |

## Using the Dual Mode Display (Optional)

**NOTE:** Make sure both the touchscreen driver and digitizer driver have been installed properly.

Dual mode display incorporates both touchscreen and digitizer functions.



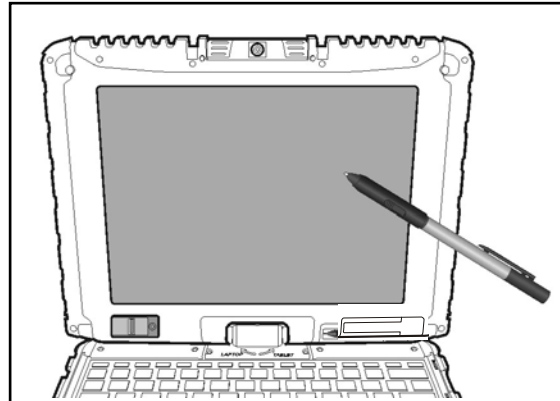

The display is set to Touchscreen mode by default. Touchscreen mode provides all the functionalities that an ordinary touchscreen has. When the computer receives signals from the active digitizer pen, the display automatically switches to Digitizer mode.



When using the digitizer pen, be sure to install the included size “AAAA” battery.

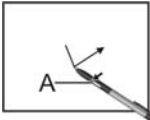

Here are some common terms that you should know when using the active digitizer feature:

| Term          |   | Action   |
|---------------|---|--|
| Wake up       |   | The digitizer pen automatically enters Sleep mode after 30 seconds of inactivity. To start using the pen, tap the tip of the pen to activate it.   |
| Move          |    | Move the cursor pointed by the digitizer pen.  |
| Click/Point   |    | Tap gently on the display.   |
| Double-click  |    | Tap twice on the display rapidly.  |
| Drag and drop |    | Tap lightly on the display and move your digitizer pen until you reach your destination (drag). Finally, release your digitizer pen (drop) when you finish dragging your selection to the destination. The object will drop into the new location. |
| Right-click   |  | Press and hold down the digitizer pen button (A), then tap gently the object.  |

**CAUTION:**

- When the LCD display is used alone or with an external display simultaneously, the digitizer function cannot be used when the area of either display is set larger than the default setting of the display resolution.

- Even when only an external display is in use, the cursor will move on the external display if you touch the surface of the LCD display with the pen or bring the pen close to the surface of the LCD display when the digitizer driver is active. Therefore, do not touch the LCD display when only an external display is in use.
- The active digitizer feature cannot be used in the BIOS Setup program or when using the full screen in DOS mode.

**NOTE:**

- You can move the cursor by bringing the digitizer pen close to the screen, without actually touching the screen's surface.
- Do not move the digitizer pen too quickly. If the pen moves too quickly, the cursor may be unable to follow its movement.
- If you cannot click on the edge of the screen, hold the digitizer pen perpendicular to the display and try clicking again.



# Using the Hard Disk Drive

**WARNING:** DO NOT replace the hard disk drive by yourself. Refer all servicing to qualified personnel or your dealer.

Your computer comes with a removable 2.5-inch SATA (serial ATA) hard disk drive.

You can enable AHCI (Advanced Host Controller Interface), a programming interface for SATA host controllers. AHCI defines transactions between the SATA controller and software and enables advanced performance and usability with SATA. When the SATA AHCI mode is enabled, your system can support SATA native command queuing, aggressive power management, and so on.

Select models are equipped with a hard disk heater that automatically turns on for low temperature operation.

**CAUTION:**

- Make regular backups of your data files from your hard disk drive to USB flash disks or other storage media.
- Never turn off or reset the computer while the hard disk drive in-use indicator is on.

# Using OSD Control Panel

The OSD Control Panel allows you to easily activate or operate certain functions on your computer.

To use the OSD Control Panel:

1. Press the button  on the front of your computer.

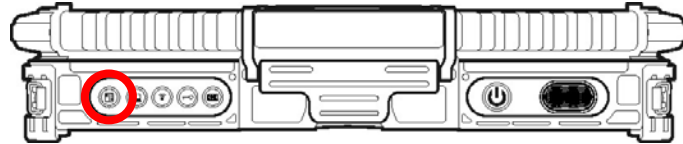

2. The following screen appears, providing several control buttons.



For detailed descriptions of the Control Panel, click the  button.

3. To close the Control Panel, either press the button  on your computer again or click the  button .

# Using the Fingerprint Scanner (Optional)

The fingerprint scanner provides a strong authentication mechanism based on fingerprint recognition. You can log on to your computer or sign in to a web site with your fingerprint instead of a password. You can also encrypt files and folders with your fingerprint.

**NOTE:** You can register a fingerprint only after creating a password for the Windows user account.

**CAUTION:** For the fingerprint file/folder encryption feature, the maximum file/folder size allowed is 2GB.

To register your fingerprint, click **Start → All Programs → Fingerprint Software → Fingerprint Registration**. Click the finger you want to register and follow the onscreen instructions to complete.



You can then use the Fingerprint Software to set up how the fingerprint authentication works.



For detailed information, click **Start → All Programs → Fingerprint Software → Help**.



# Using the Video Features

The video subsystem of your computer features:

- 12.1-inch wide TFT (Thin-Film Transistor) color LCD display with 1024×768 XGA resolution
- Simultaneous display on LCD and external monitor, which is useful when you have a presentation as you can control the screen from your computer and face the audience at the same time (option)
- Multi-display capability, which allows you to expand your desktop on the screen to another display device so that you have more desktop space to work on
- Built-in light sensor to automatically adjust the LCD brightness and optional keyboard backlight
- Power Management
- Sunlight-readable LCD display

**NOTE:**

- Before using the multi-display capability or taking advantage of the enhanced video capabilities, the VGA driver supplied with your computer must be installed.
- The computer enters the Standby/Sleep or Hibernation mode when the LCD is closed. If you want to use the computer with the LCD closed, set according in Windows Control Panel so the computer does not enter the Standby/Sleep or Hibernation mode when the LCD is closed.

## Configuring the Display Modes

**NOTE:** When using an external CRT monitor, the resolution depends on the CRT monitor's supported resolution.

Your computer has been set to a default resolution and number of colors before shipment. You can view and change display settings through your operating system. See your operating system documentation or online help for specific information.

For displaying in higher resolutions, you can connect an external monitor that supports higher resolutions. (See "Connecting an External Monitor" in Chapter 4 for more information.)

## Using Landscape or Portrait View

After Windows is started up, you can rotate the display and perform the touchscreen and active digitizer operations in the rotated mode.

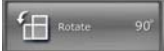
To rotate the display, press the button  located on the front of your computer to open the OSD control panel and click . Each time this Rotate button is clicked, the screen display rotates counter-clockwise by 90°.

### **NOTE:**

- If the screen display resolution has been set to 800×600 pixels, you can rotate the display to Primary Landscape and Secondary Landscape only.
- While the display is rotated:
  - Do not set the display resolution larger than the resolution of the LCD display.
  - If you exit Windows, the next time Windows is started up, the operation of the touchpad will not match the display angle for a few seconds.
  - The computer's performance will decrease slightly.
  - If a video is played, the picture may not be displayed properly or the sound may be broken up. This problem can be corrected by rotating the display to Primary Landscape.
  - The touchpad's scroll function does not work.
- The display cannot be rotated when DOS mode is set to "Full Screen."

### For a Model without 3G Module

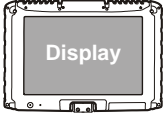
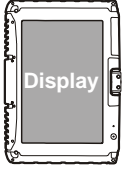
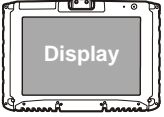
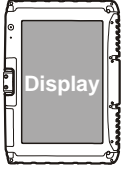
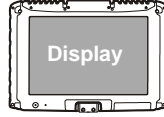
| Primary Landscape   | Primary Portrait  | Secondary Landscape   | Secondary Portrait   | Primary Landscape   |
|---|---|---|--|---|
|  |  |  |  |  |

### For a Model with 3G Module

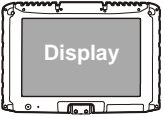
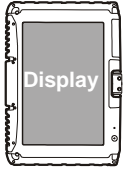
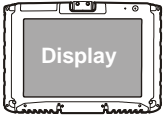
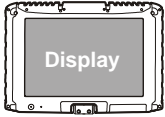
| Primary Landscape   | Primary Portrait  | Secondary Landscape   | Primary Landscape   |
|---|---|---|---|
|  |  |  |  |



# Using the Audio Features

## NOTE:

- To take advantage of the enhanced audio capabilities, the audio driver supplied with your computer must be installed.
- If you experience interference while recording, try lowering the microphone recording volume.

The audio subsystem of your computer features:

- Built-in sound system for recording and playing sound on your computer
- Azalia interface (high density audio codec)
- Built-in Speaker
- External audio connectors

Ways of playing and recording sound vary with the operating system used. See your operating system documentation or online help for specific information.



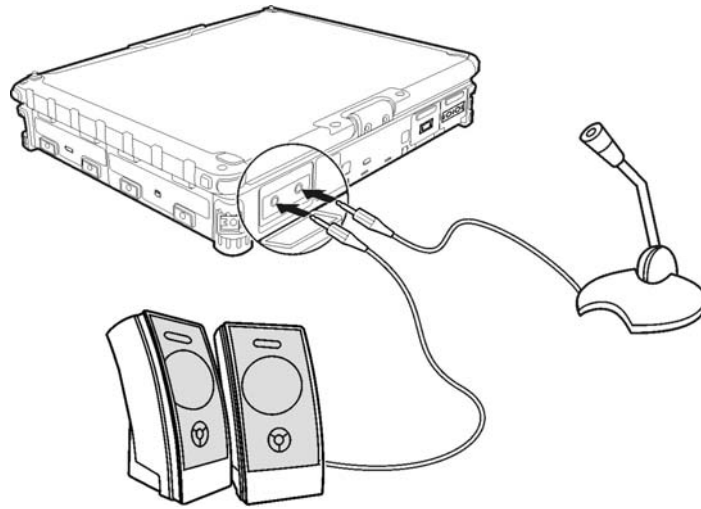

## Connecting Audio Devices

For higher audio quality, you can send or receive sound through external audio devices.



**NOTE:** After connecting an external audio device, make sure that you specify the use of the correct audio device in Windows.

- **Audio Output Connector** (  ) can be connected to speakers, headphones, or earphone set.
- **Microphone Connector** (  ) can be connected to an external microphone for recording voice or sound.

**NOTE:** When using the external speakers/headphones or microphone, you cannot use the internal one.

# Using G-Camera Lite

**G-Camera Lite** allows you to take pictures with the Webcam, if supplied with your computer.

To start G-Camera Lite, click **Start** → **All Programs** → **G-Camera Lite** → **G-Camera Lite**. The camera control panel appears.

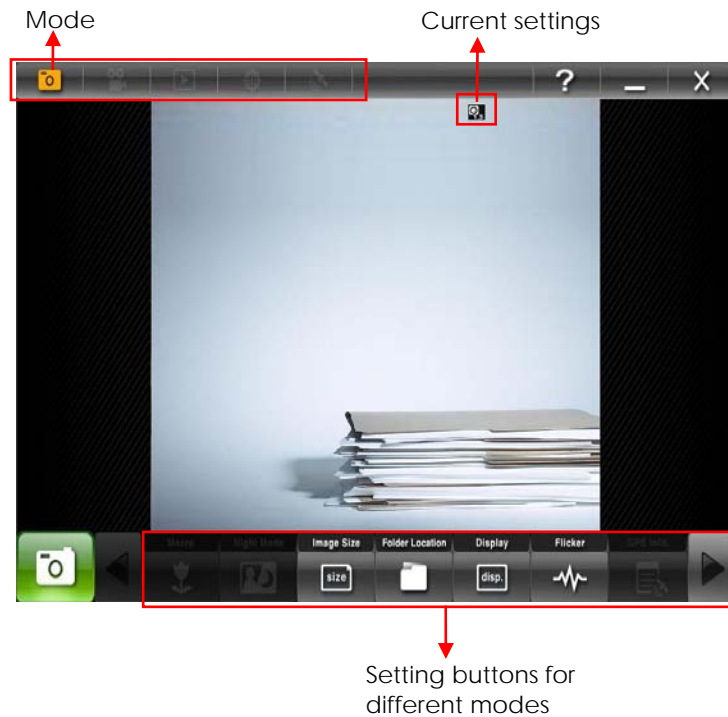

Click the **Shutter** button  or press **Enter** to take photos.

For detailed descriptions of G-Camera Lite, click the button .

# Using the Communication Features

## Using the Modem

**NOTE:** To take advantage of the modem feature, the modem driver supplied with your computer must be installed.

The internal 56 K fax/data modem allows you to use the telephone line to communicate with others by fax, email, or connect to an online service or bulletin board.

To connect the telephone line to the modem, connect one end of the modem cable to the RJ-11 connector on the computer and the other end to the phone line.

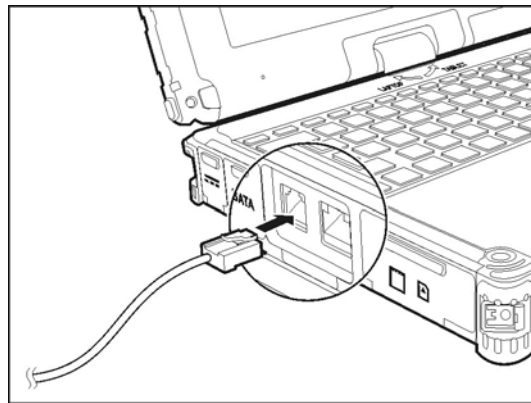

**NOTE:**

- When using the communication software, you may have to disable power management.
- Set parameters such as modem speed (baud rate) and line type (pulse dialing or tone dialing).
- Do not enter the Standby/Sleep mode when using the communication software.

## Using the LAN

**NOTE:** To take advantage of the LAN feature, the LAN driver supplied with your computer must be installed.

The internal 10/100/1000Base-T LAN (Local Area Network) module allows you to connect your computer to a network. It supports data transfer rate up to 1000 Mbps.

To connect the network cable to the LAN module, connect one end of the LAN cable to the RJ-45 connector on the computer and the other end to the network hub.

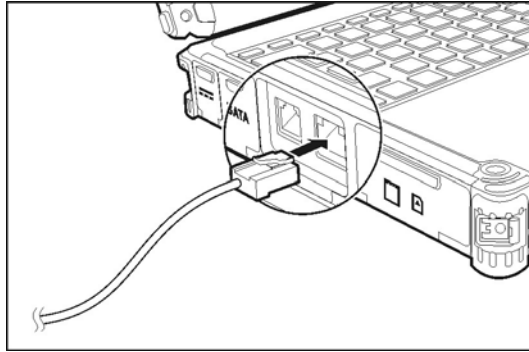

## Using the Wireless LAN

Depending on your model, an internal mini PCI-E wireless LAN (WLAN) card may have been pre-installed by your computer manufacturer at the factory. This card allows you to access corporate networks or the Internet in a wireless environment.

The WLAN features include:

- Peer-to-Peer (Ad-Hoc) and Access Point (Infrastructure) modes support
- WEP (Wired Equivalent Privacy) 64/128-bit data encryption
- IEEE 802.11a/g/n standard compliance

| Technology                       | 802.11a   | 802.11g   | 802.11n  |
|----------------------------------|---|---|--|
| Stated Maximum Throughput (Mbps) | 54  | 54  | 100 Mbps or more   |
| Data Rates (Mbps)                | 54, 48, 36, 24, 18, 12, 9, 6                      | 54, 36, 18, 9                                     | 100 ~ 210  |
| Band (GHz)                       | 5.15 ~ 5.35                                       | 2.4   | 2.4 / 5  |
| Modulation Technology            | OFDM (Orthogonal Frequency Division Multiplexing) | OFDM (Orthogonal Frequency Division Multiplexing) | Spatial multiplexing, uses MIMO (multiple-input multiple-output) |

To take advantage of the WLAN feature, make sure that the WLAN driver is installed correctly. If your WLAN card was provided by your dealer instead of the computer manufacturer, contact your dealer for the correct driver to use.

## Turning Off/On the WLAN Radio

**NOTE:** The FAA (Federal Aviation Agency) has deemed it unsafe to operate wireless devices in aircraft as this may interfere with flight safety. Remember to turn off wireless LAN when using your computer in the airplane.

Your computer has a built-in **Fn+F2** WLAN hot key to switch the WLAN on/off. If you need to temporarily turn off the radio, press **Fn+F2**. To resume network connection, press **Fn+F2** again.

It takes approximately 30 seconds for your computer to make a successful WLAN connection and approximately 10 seconds to disconnect.

## Connecting to a Wireless Network

To connect to a wireless network:

1. Make sure that the WLAN radio is on (controlled by **Fn+F2**).
2. Click **Start → Programs → Intel PROSet Wireless → Intel PROSet Wireless**.
3. If any wireless network is detected, the following window appears on screen.



4. Click to select a wireless network to connect to, and then click **Connect**.
5. Depending on the settings, you may be asked to enter a wireless security password (encryption key).

For more information on the Intel PROSet Wireless utility, click **Help?** in the **Intel(R) PROSet/Wireless** window.



## Using the Bluetooth Feature (Optional)

**NOTE:** To take advantage of the Bluetooth feature, the Bluetooth driver supplied with your computer must be installed.

Depending on your model, your computer may incorporate the Bluetooth capability for short-range (about 10 meters) wireless communications between devices without requiring a cable connection.

With Bluetooth, data can be transmitted through walls, pockets and briefcases as long as two devices are within range. By default, your computer's Bluetooth feature is active (always ON) upon booting your computer and is in the general discoverable and pairable mode.

The status of the Bluetooth connection is indicated by the Bluetooth icon located in the taskbar in the lower-right part of the screen.

| Status    | Icon  |
|-----------|---|
| On        |  (blue with white logo). |
| Connected |  (blue with green logo)  |

You can use the Bluetooth Utility to configure Bluetooth connection settings and transfer files.

## Connecting to another Bluetooth Device

1. Make sure that the target Bluetooth device is turned on, discoverable and within close range. (See the documentation that came with the Bluetooth device.)



2. To search for Bluetooth devices, use any of the following three methods:

**Method 1:**

Right click the Bluetooth icon  located in the taskbar in the lower-right part of the screen. Select **Explore Bluetooth Places**.



**Method 2:**

Right click the Bluetooth icon  located in the taskbar in the lower-right part of the screen. Select **Display Classic View**. The Bluetooth utility screen appears. Right click the central icon (the yellow sun) and select **Search Devices**.



### Method 3:

Use Windows File Manager to browse to **Bluetooth Places** and select **Search Devices**.

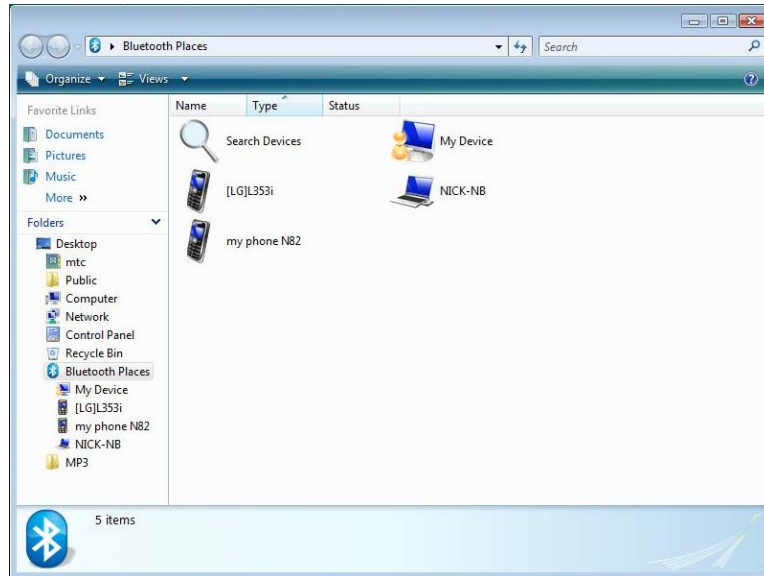

3. Select the device you want to connect from the search results.
4. Depending on the type of Bluetooth device that you want to connect to, you will need to enter the pertinent information.

For detailed information on using the Bluetooth Utility, see the Bluetooth Utility Help.

# Using the GPS

**NOTE:** To take advantage of the GPS feature, the GPS and GPS filter driver supplied with your computer must be installed.

GPS (Global Positioning System) is a constellation of 24 well-spaced satellites that orbit the Earth and make it possible for devices enabled with GPS receivers to pinpoint their location.

You need to install third-party GPS navigation software to take advantage of the GPS feature.



## Chapter 3

# Managing Power

Your computer operates either on external AC power or on internal battery power.

This chapter tells you how you can effectively manage power. To maintain optimal battery performance, it is important that you use the battery in the proper way.



# AC Adapter

## CAUTION:

- The AC adapter is designed for use with your computer only. Connecting the AC adapter to another device can damage the adapter.
- The AC power cord supplied with your computer is for use in the country where you purchased your computer. If you plan to go overseas with the computer, consult your dealer for the appropriate power cord.
- When you disconnect the AC adapter, disconnect from the electrical outlet first and then from the computer. A reverse procedure may damage the AC adapter or computer.
- When unplugging the connector, always hold the plug head. Never pull on the cord.

The AC adapter serves as a converter from AC (Alternating Current) to DC (Direct Current) power because your computer runs on DC power, but an electrical outlet usually provides AC power. It also charges the battery pack when connected to AC power.

The adapter operates on any voltage in the range of 100–240 V AC.

# Battery Pack

The battery pack is the internal power source for the computer. It is rechargeable using the AC adapter.

The operating time of a fully charged battery pack depends on how you are using the computer. When your applications often access peripherals, you will experience a shorter operating time.

**NOTE:** Care and maintenance information for the battery is provided in the “Battery Pack Guidelines” section in Chapter 7.

## Charging the Battery Pack

**NOTE:**

- Charging will not start if the battery’s temperature is below 0°C (32°F) or above 30°C (86°F).
- The charging process will stop and the Battery Charge Indicator flashes green and yellow by turns when the battery’s temperature gets above 60°C (140°F). If this happens, the battery pack may be damaged. Please contact your dealer.
- During charging, do not disconnect the AC adapter before the battery has been fully charged; otherwise you will get a prematurely charged battery.

To charge the battery pack, connect the AC adapter to the computer and an electrical outlet. The Battery Charge Indicator (  ) on the computer glows yellow to indicate that charging is in progress. You are advised to keep the computer power off while the battery is being charged. When the battery is fully charged, the Battery Charge Indicator is off.

It takes approximately 3 hours to fully charge the Li-Ion battery pack when the computer is off, and approximately 6 hours to fully charge the Li-Ion battery pack when the computer is on.

**CAUTION:** After the computer has been fully recharged, do not immediately disconnect and reconnect the AC adapter to charge it again. Doing so may damage the battery.

**NOTE:** The battery level may automatically lessen due to the self-discharge process (0.21 % per day), even when the battery pack is fully charged (100 %). This happens no matter if the battery pack is installed in the computer.

## Checking the Battery Level

**NOTE:** Any battery level indication is an estimated result. The actual operating time can be different from the estimated time, depending on how you are using the computer.

### By Operating System

You can check the approximate battery level using the battery meter function of the operating system. To read the battery level in Windows, click the battery icon on the taskbar.

### By Gas Gauge

On the exterior side of the battery pack is a gas gauge for displaying the estimated battery charge. When the battery pack is not installed in the computer and you want to know the battery charge, you can press the switch with a pointed device to see the corresponding value of indicator segment that light green.

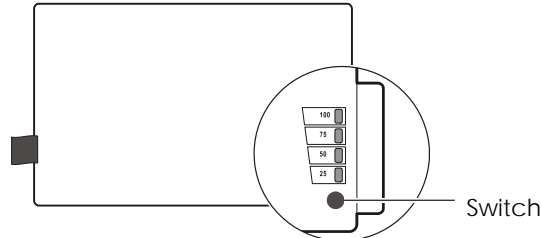



The value of the corresponding green segment indicates the relative percentage of the battery charge. The battery pack is fully discharged when you see no segment glowing green.

## Replacing the Battery Pack

### CAUTION:

- There is danger of explosion if the battery is incorrectly replaced. Replace the battery only with the computer manufacturer's optional battery packs. Discard used batteries according to the dealer's instructions.
- Do not attempt to disassemble the battery pack.

If you often rely on battery power for a long period of time while traveling, you may consider the purchase of an additional battery pack from your dealer and keep it with you in a fully charged state as a backup.

To replace the battery pack, follow these steps:

1. Make sure that the computer is not turned on or connected to AC power.
2. Locate the battery compartment on the right side of the computer.
3. Open the compartment cover by pressing on both sides of the release latch using your thumb and index fingers.

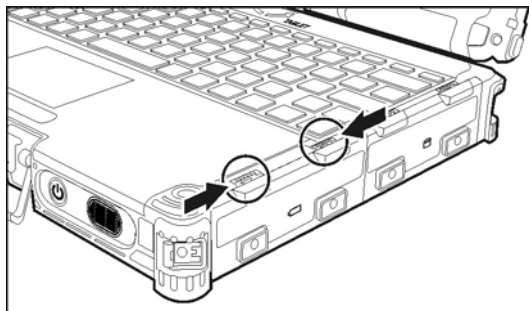

4. Pull on the ribbon strip to remove the battery pack.

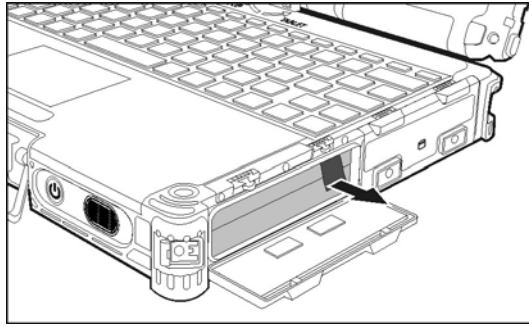

5. Slide the new battery pack all the way into the slot. Make sure to observe the correct orientation (the ribbon strip must face outward for future battery back removal).

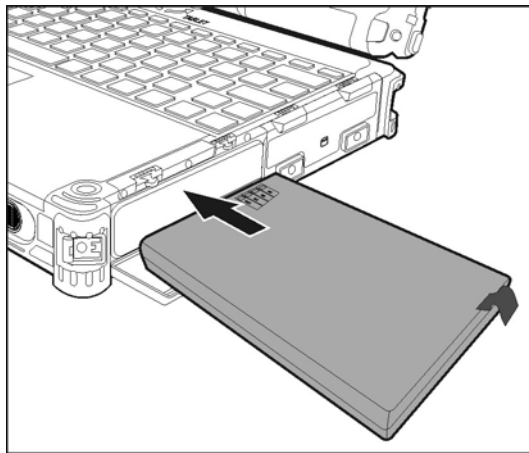

6. Close the compartment cover to secure the battery pack.



## Battery Low Signals and Actions

When the battery is low, Windows gives warning messages and the Battery Charge Indicator (  ) blinks yellow to alert you.

Immediately save your data upon Battery Low. The remaining operating time depends on how you are using the computer. If you are using the audio subsystem, PC card, hard or USB flash disk, the battery might run out of charge very quickly.

Always respond to Battery Low by connecting the AC adapter, turning off the computer, or placing your computer in Hibernation mode. If you do not take any action, the computer will automatically hibernate and turn off.

**NOTE:** You can set up the threshold of Battery Low and actions for Windows to take with Windows **Power Options**. (For more information, see Windows' Help.)

### **CAUTION:**

- If you are using a PC card, do not access the card during battery low periods. This is because the access may take longer than the time it takes the battery to run out of charge, thus making your access to the card unsuccessful.
- If you fail to save your data when the battery completely runs out of charge, then you lose your data.

# Power Management

Your computer supports ACPI (Advanced Configuration and Power Interface) for power management. The power management feature allows you to reduce the power consumption for energy saving.

With an ACPI-compliant operating system such as Windows, power supply to different computer components is controlled on an as-needed basis. This allows maximum power conservation and performance at the same time.

In general, Windows' power management works in this way:

| What...   | When...  |
|---|--|
| Power to the hard disk is turned off  | When the hard disk has been idle for a set period.     |
| Power to the display is turned off  | When the display has been idle for a set period.       |
| The computer enters the Standby/Sleep mode. The hard disk and display are turned off and the entire system consumes less power. | When the entire system has been idle for a set period. |
|   | When you press the <b>Fn+F10</b> hot key. *            |
|   | When you close the cover. *                            |
| The computer enters the Hibernation mode. (See the next subsection for more information.)                                       | When you press the power button. *                     |
|   | When you press the <b>Fn+F10</b> hot key. *            |
|   | When you close the cover. *                            |
|   | When you press the power button. *                     |

\* Depends on your settings in Windows.

For detailed information on power management, see Windows' Help.



## Hibernation

Hibernation is a very useful feature. People frequently open many applications when they use computers. It takes some time to get all these applications open and running, and normally they all have to be closed before the computer can be turned off.

When you use the hibernation feature, you do not have to close the applications. The computer stores the state of your computer to a file on the hard disk and then shuts down. The next time you turn on your computer, you return to exactly where you left off.

# Power-Saving Tips

Aside from enabling your computer's power saving mode (see previous section), you can do your part to maximize the battery's operating time by following these suggestions.

- Do not disable Power Management.
- Decrease the LCD brightness to the lowest comfortable level.
- Shorten the length of time before Windows turn off the display.
- Many USB devices use power just by being connected. If you use a USB mouse, you can save power by disconnecting the mouse and using the touchpad. If you use a USB flash drive, unplug it when you are not using it.
- If you work with an application that uses a PC card, exit the application when you finish using it.
- If you have a PC card installed, remove it when not in use. Some PC cards drain power even while they are inactive.
- Turn off the wireless radio if you are not using the wireless module.
- Turn off the computer when you are not using it.

## Chapter 4

# Expanding Your Computer

You can expand the capabilities of your computer by connecting other peripheral devices. When using a device, be sure to read the instructions accompanying the device together with the relevant section in this chapter.

# Connecting an External Monitor (Optional)

If you want the benefits of a larger display screen with higher resolution, you can connect an external display monitor to your computer. Follow this procedure to connect an external monitor:

1. Make sure that the computer is not turned on.
2. Plug the monitor's D-type signal connector to the computer's VGA connector.

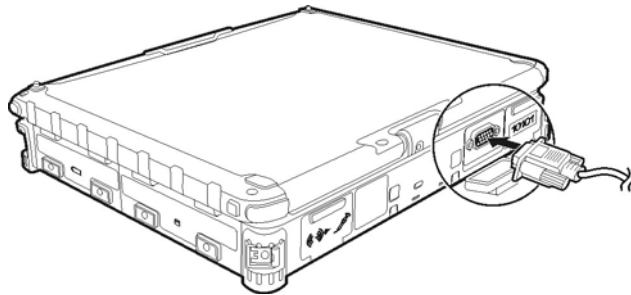

3. Plug one end of the monitor's power cord into the power socket on the monitor and the other end to an electrical outlet.
4. To use the monitor, turn on the monitor before turning on the computer.
5. The monitor should respond by default. If not, you can switch the display to the monitor or to both (simultaneous display), or to multi-display by pressing the **Fn+F9** hot key. In Windows, you can also change the display through the settings in **Display** Properties.
6. You can change display settings through your operating system. See your operating system documentation or online help for specific information.



**CAUTION:** Do not disconnect the external monitor while the computer is in the Standby/Sleep mode or Hibernation mode. If no external monitor is connected when the computer resumes, the LCD might not display properly.



# Connecting a Serial Device

Your computer has one or two serial ports (depending on model) for connecting a serial device such as a serial mouse or serial communication device (modem).

Follow this procedure to connect a serial device:

1. Make sure the computer is not turned on
2. Plug the device cable to the serial port on the rear of the computer.

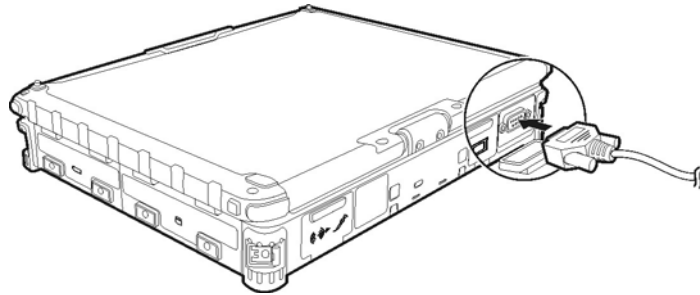

3. Turn on the computer.

**NOTE:** Portable modems that derive power through the serial port cannot be used with the computer. Instead, use a modem that is powered by its own internal battery or external AC power.

# Connecting a USB Device

Your computer has a USB port for connecting USB devices, such as a digital camera, scanner, printer, modem, and mouse.

**NOTE:** The eSATA/USB Combo port can also function as a USB port.

The USB port support transfer rates up to 12 MB/s for USB 1.1 devices and 480 MB/s for USB 2.0 devices.

To connect a USB device, simply plug the device cable to one of the USB ports.

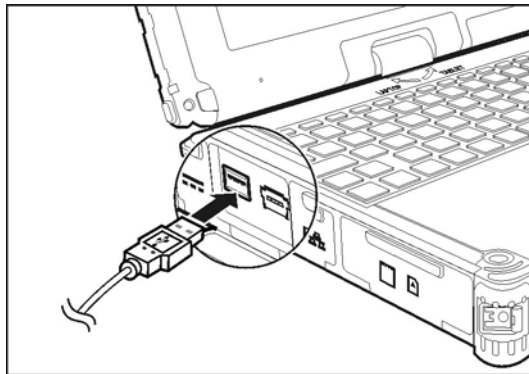

## Connecting an eSATA Device

Your computer has an eSATA/USB Combo port for connecting eSATA devices (such as an external hard drive and external optical drive) / USB devices (see previous section).

The port supports SATA II with transfer rate up to 3.0Gbit/s. It can provide 5V power if a certified USB-eSata combo cable is used.

To connect an external eSATA device, simply plug the device cable to the eSATA port.

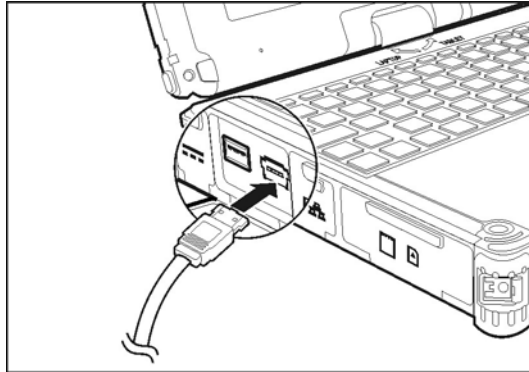

## Using Smart Cards (Optional)

Your computer may have a smart card slot for additional security feature, providing tamper-proof storage of user and account identity. A smart card is a type of plastic card embedded with a computer chip that stores and transacts data between you (user) and the computer.

You need to install third-party smart card software to take advantage of the smart card feature.

### Inserting and Removing a Smart Card

To insert a smart card:

1. Locate the smart card slot.
2. Slide the smart card, with its label and embedded computer chip facing up into the slot.

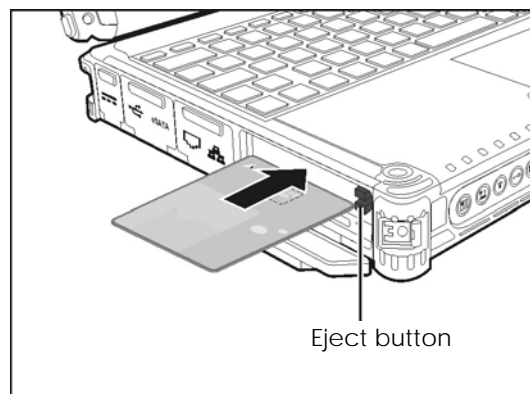

3. When a new card is seated, use the third-party smart card software to allow your computer to read it.

To remove a smart card:

1. Make sure that the third-party smart card software is not accessing the smart card.
2. Pull the card out of the slot.



# Using PC Cards

**NOTE:** To take advantage of the PC Card interface, the PC Card Controller driver supplied with your system must be installed.

Your computer has one or two PC card slots that support CardBus specifications. The slots can accommodate a type II card. Typical type II cards are flash memory, SRAM, modem, LAN, and SCSI cards.

## Inserting and Removing a PC Card

**NOTE:**

- Some PC cards require additional system resources. Before using such PC card, you may have to free other system resources for the PC card.
- Although some PC cards can be inserted and removed without turning off the computer, you cannot remove or install PC cards during Standby mode.

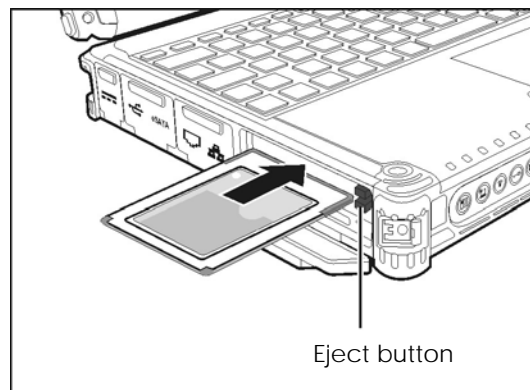

To insert a PC card:

1. Locate the PC card slot on the left side of the computer.
2. Slide the PC card, with its label facing up, into the slot until the eject button pops out.



3. When a new card is seated, the computer will detect it and try to install the appropriate driver. Follow the on-screen instructions to complete the process.

To remove a PC card:

1. Double-click on the **Safely Remove Hardware** icon (  for Windows Vista/Windows 7 or  for Windows XP) found on the Windows taskbar and the **Safely Remove Hardware** window appears on screen.
2. Select (highlight) the PC card from the list to disable the card.
3. Push the eject button and the card will slide out slightly.
4. Pull the card out of the slot.

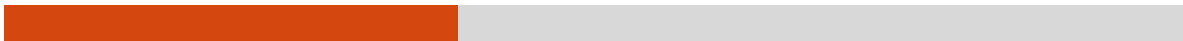



# Using ExpressCards (Optional)

**NOTE:** The ExpressCard interface is not compatible with the PC card interface.

Your computer may have an ExpressCard slot.

ExpressCard supports the PCI Express and USB 2.0 serial data interfaces (supporting speeds of up to 2.5 Gbps and 480 Mbps respectively), improving speed in data transfer while conserving power usage.

## ExpressCard Type

The ExpressCard slot can accommodate a 54 mm (ExpressCard/54) or 34 mm (ExpressCard/34) wide ExpressCard. Typical ExpressCards support a very extensive range of applications including memory, wired and wireless communication cards, and security devices.

Shown next are the appearances of ExpressCards for your reference.

**ExpressCard/54**



**ExpressCard/34**



## Inserting and Removing an ExpressCard

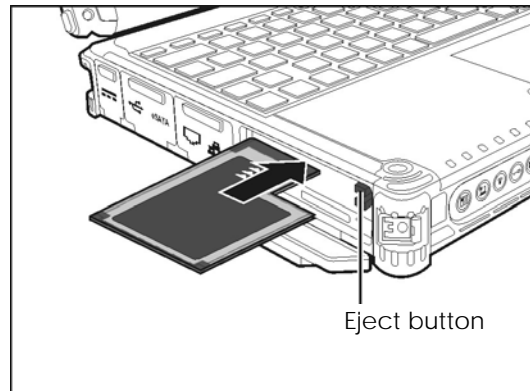

To insert an ExpressCard:

1. Locate the ExpressCard slot on the left side of the computer.
2. Slide the ExpressCard, with its label facing up, all the way into the slot until the rear connectors click into place.



3. When a new card is seated, the computer will detect it and try to install the appropriate driver. Follow the on-screen instructions to complete the process.

To remove an ExpressCard:

1. Double-click on the **Safely Remove Hardware** icon (  for Windows Vista/Windows 7 or  for Windows XP) found on the Windows taskbar and the **Safely Remove Hardware** window appears on screen.
2. Select (highlight) the ExpressCard from the list to disable the card.
3. Push the eject button and the card will slide out slightly.
4. Pull the card out of the slot.

# Using the Card Reader

## NOTE:

- To use the Card Reader, the SD Reader driver supplied with your computer must be installed.
- If your hard disk is divided into several drives, make sure that all drives have been formatted before using the Card Reader. Otherwise, you may encounter problems when using the Card Reader.
- You can use only storage cards. Your Card Reader does not support cards with I/O (input/output) functions such as a wireless network card or Bluetooth card.

Your computer has a Card Reader. The Card Reader is a small drive for reading from and writing to removable storage cards (or called memory cards). The Card Reader supports Secure Digital (SD) cards.

To insert a storage card:

1. Locate the Card Reader slot on the left side of the computer.
2. Align the card with its connector pointing to the slot and its label facing up. Slide the card into the slot until it reaches the end.

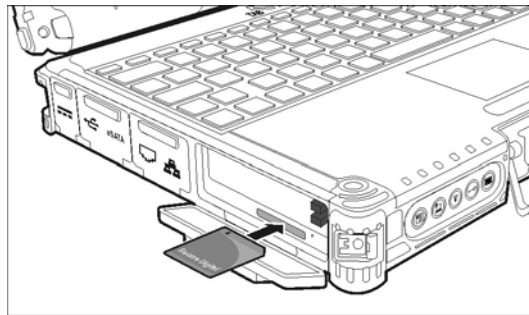

3. Windows will detect the card and assign it a drive name.

To remove a storage card:

1. Double-click **My Computer**.
2. Right-click the drive with the card and select **Eject**.
3. Pull the card out of the slot.



## Using the Port Replicator (Optional)

**NOTE:** To use the port replicator, the Vehicle Dock driver supplied with your computer must be installed.

A port replicator is available as an option. This device eliminates the hassles of having you connect and disconnect the various cables when carrying your computer around and allows a variety of peripherals to be connected including a headphone or microphone, etc. The port replicator connects to the expansion bus connector at the bottom of your computer.

1. Slide open the expansion bus connector cover.

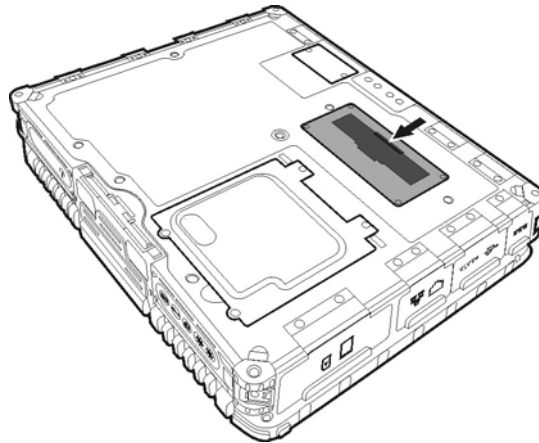

2. Connect your port replicator to the expansion bus connector.

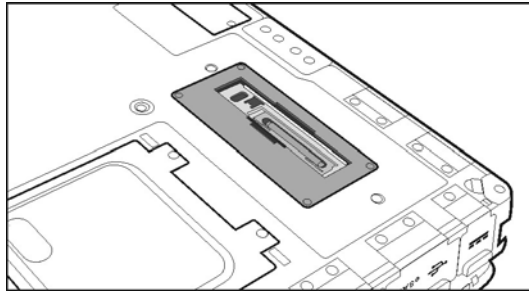

For more detailed information, refer to the instructions supplied with the port replicator.

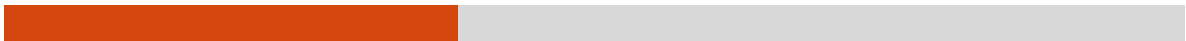

# System Memory Upgrade

You can upgrade your computer by changing system memory to a maximum of 8 GB on the DDR3 SO-DIMM slot.

**CAUTION:** RAM modules are extremely sensitive to static electricity. There are cases where static electricity generated by the human body has adversely affected such modules. When inserting or removing a RAM module, do not touch the terminals or internal components, insert objects other than the module, or allow foreign particles to enter. Doing so has been known to cause damage, fire, or electrical shock.

To install the RAM module:

1. Remove the battery pack (see chapter 3) and make sure that the computer is not connected to AC power.
2. Carefully place the notebook computer upside down.
3. Remove the four screws to open the compartment cover.

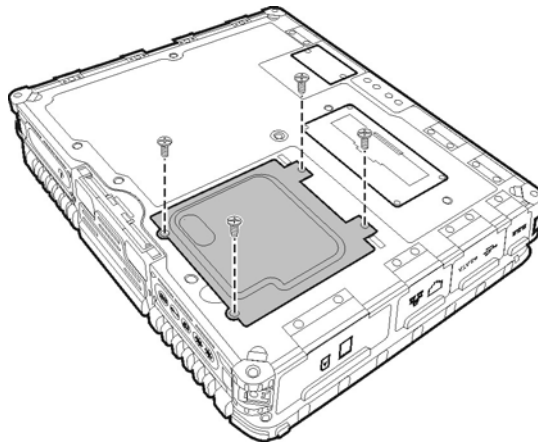

4. To install the RAM module, match the module's notched part with the socket's projected part and firmly insert the module into the socket at a 20-degree angle. Then push down until the retaining clips lock the module into position.

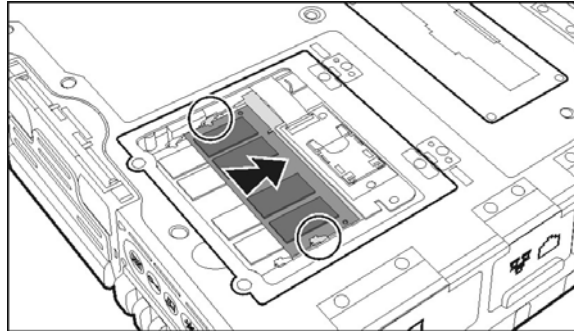

**CAUTION:** If the RAM module is difficult to insert or difficult to push down, do not force it. Check once more to ensure that the module is positioned correctly.

5. Close the compartment cover and secure with four screws.



## Chapter 5

# Using BIOS Setup and System Recovery

BIOS Setup Utility is a program for configuring the BIOS (Basic Input/ Output System) settings of the computer. BIOS is a layer of software, called firmware, that translates instructions from other layers of software into instructions that the computer hardware can understand. The BIOS settings are needed by your computer to identify the types of installed devices and establish special features.

System Recovery reinstalls Windows to your computer and restores it to the factory default status.

This chapter tells you how to use the BIOS Setup and System Recovery.

# BIOS Setup

## When to Use

You need to run BIOS Setup Utility when:

- You see an error message on the screen requesting you to run BIOS Setup Utility.
- You want to restore the factory default BIOS settings.
- You want to modify some specific settings according to the hardware.
- You want to modify some specific settings to optimize the system performance.

## How to Use

### Starting BIOS Setup

**NOTE:**

- The BIOS Setup Utility screens shown in this chapter are for your reference only. The actual items or settings on your computer may differ.
- The BIOS Setup Utility program may have been updated after the publication of this manual.
- The settings you select in your operating system might override similar settings in BIOS Setup Utility.

To run BIOS Setup Utility, press the **F2** key when the prompt appears on the screen during the system startup. The prompt shows up on the screen for only a few seconds. You must press the **F2** key quickly. The BIOS Setup Utility main screen appears as shown next.

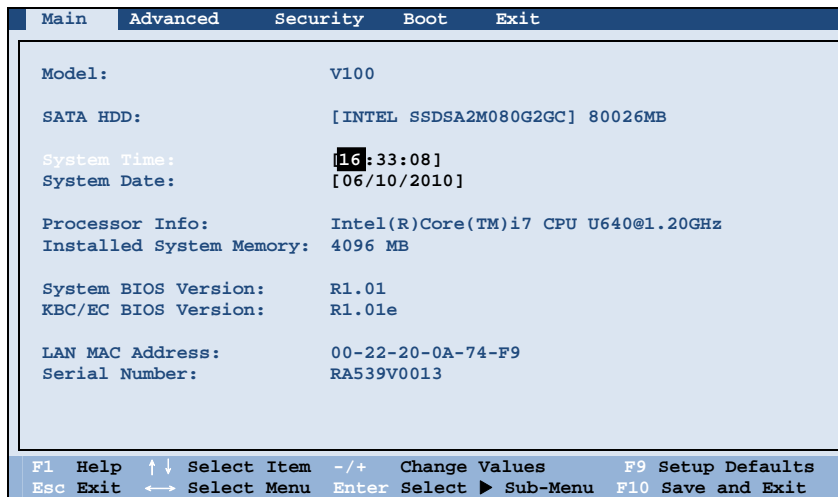

The BIOS Setup Utility screen can be divided into four areas:

- On the top is the menu bar containing the titles of the available menus. Each menu title brings a specific menu.
- The left column of the menu displays the menu items.
- The right column of the menu provides more detailed information when a menu item is highlighted.
- The bottom of the menu provides keyboard instructions for moving around and making selections.

## Moving Around and Making Selections

You must go through two or three levels to complete the setting for an item. In most cases, there are two levels: menu title and submenu.

Use the keyboard to move around and make selections. Keyboard information can be found at the bottom of the screen. A brief description of keyboard usage is listed next:

| Key          | Function  |
|--------------|---|
| ← , →        | Selects a menu title.   |
| ↑ , ↓        | Selects an item or option.  |
| + / -        | Changes the value.  |
| <b>Enter</b> | 1) Brings up the sub-menu when available.<br>2) Opens or closes the option window when an item is selected. |
| <b>Esc</b>   | 1) Exits BIOS Setup Utility.<br>2) Closes the option window if one is open.                                 |
| <b>F1</b>    | Provides help information.  |
| <b>F9</b>    | Loads setup defaults.   |
| <b>F10</b>   | Saves and exit the BIOS Setup Utility.  |

## Main Menu

The Main menu contains the system date and time settings as well as shows the basic configuration of the system.

```

Main  Advanced  Security  Boot  Exit
-----
Model:                               V100
SATA HDD:                            [INTEL SSDSA2M080G2GC] 80026MB
System Time:                          [16:33:08]
System Date:                          [06/10/2010]
Processor Info:                       Intel(R)Core(TM)i7 CPU U640@1.20GHz
Installed System Memory:              4096 MB
System BIOS Version:                  R1.01
KBC/EC BIOS Version:                 R1.01e
LAN MAC Address:                      00-22-20-0A-74-F9
Serial Number:                        RA539V0013

F1 Help  ↑↓ Select Item  -/+ Change Values  F9 Setup Defaults
Esc Exit  ←→ Select Menu  Enter Select ► Sub-Menu  F10 Save and Exit
```

**System Time** sets the system time.

**System Date** sets the system date.

## Advanced Menu

The Advanced menu contains the advanced settings as shown next.

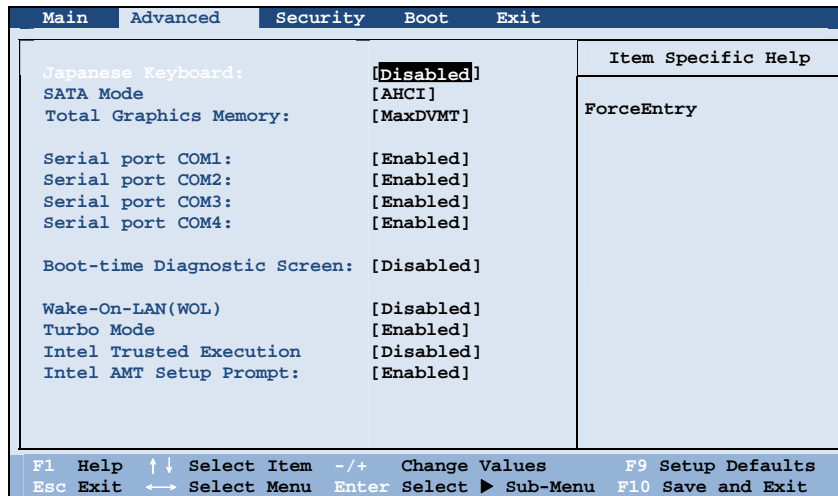

**Japanese Keyboard** enables support for the Japanese keyboard.

**SATA Mode** sets the mode to enhanced *AHCI* (Advanced Host Controller Interface) or *IDE*. Turbo memory feature works only when the SATA AHCI mode is enabled.

**Total Graphics Memory** sets the amount of total graphics memory (pre-allocated + fixed + DVMT) for use by the internal graphics device.

**Serial Port COM1/COM2/COM3/COM4** allows you to unconditionally disable it when set at *Disabled*.

**Boot-time Diagnostic Screen** allows you to display the diagnostic screen during system boot-up.

**Wake-On-LAN (WOL)** allow a LAN activity to wake up the system from S3 (Sleep) state.

**Turbo Mode** sets if turbo memory is enabled.

**Intel Trusted Execution** enables utilization of additional hardware capabilities provided by Intel® Trusted Execution Technology.

**Intel AMT Setup Prompt** sets if the prompt for entering Intel AMT Setup appears during POST. If disabled, you cannot enter Intel AMT Setup.

## Security Menu

The Security menu contains the security settings, which safeguard your system against unauthorized use.

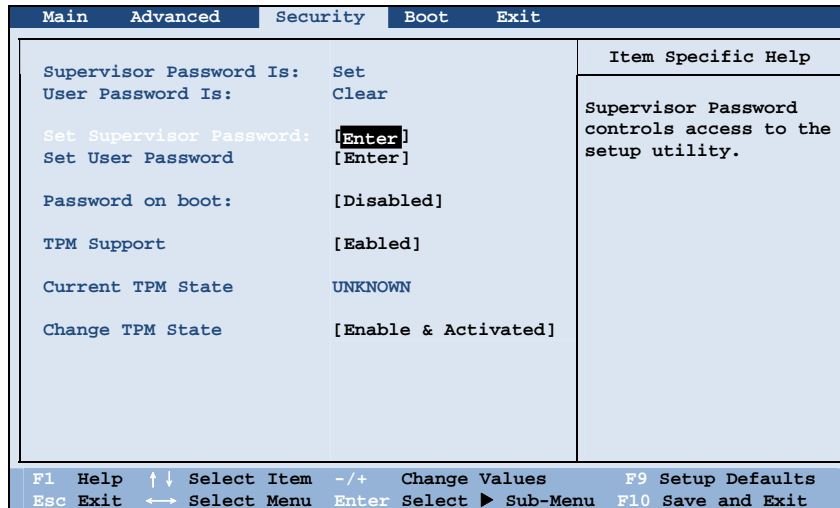

**Supervisor/User Password Is** shows whether you have set the supervisor/user password or not for the system.

**Set Supervisor/User Password** sets the supervisor/user password. When typing the password, first make sure that Num Lock is off, and then type the password in the entry fields and press **Enter**. Confirm your password by typing it again and pressing **Enter**. You can set the supervisor/user password to be required for starting up the system and/or entering BIOS Setup.

**NOTE:**

- You can set the user password only when the supervisor password has been set.
- If both the administrator and user passwords are set, you can enter any of them for starting up the system and/or entering BIOS Setup. However, the user password only allows you to view/change the settings of certain items.

**Password on Boot** allows you to enable or disable the entering of password for booting up your system. Once the password is successfully set and this item is enabled, it is required for booting up the system.

**TPM Support** enables or disables TPM (Trusted Platform Module) support. The TPM is a component on your computer's mainboard that is specifically designed to enhance platform security by providing a protected space for key operations and other security critical tasks. Using both hardware and software, TPM protects encryption and signature keys at their most vulnerable stages – operations when the keys are being used unencrypted in plain-text form. TPM is specifically designed to shield unencrypted keys and platform authentication information from software-based attacks.

**NOTE:**

- To use the TPM feature, the TPM driver supplied with your computer must be installed.
- The next two items **Current TPM State** and **Change TPM State** would only appear if the item **TPM Support** is set at *Enabled*.

**Current TPM State** shows the current TPM state.

**Change TPM State** allows you to select between *No Change*, *Clear*, *Deactivate & Disable*, and *Enable & Activate*.



## Boot Menu

The Boot menu sets the sequence of the devices to be searched for the operating system.

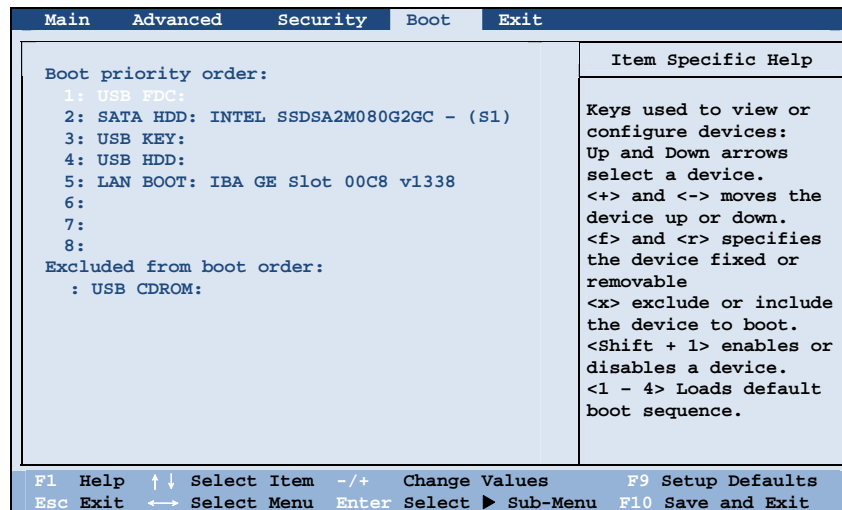

The bootable devices will be automatically detected during POST and shown here, allowing you to set the sequence that the BIOS uses to look for a device from which to load the OS. Below is a brief description of keyboard usage:

| Key           | Function  |
|---------------|---|
| ↑, ↓          | Selects (highlight) a boot device.                        |
| +, -          | Changes the boot sequence.                                |
| <b>1 to 4</b> | Loads the default boot sequence.                          |
| <b>X</b>      | Moves the highlighted boot device from the "Boot priority |

|                 |  |
|-----------------|--|
|                 | order" list to the "Excluded from boot order" list, and vice versa.  |
| <b>Shift+F1</b> | Deactivates/activates the highlighted boot device on the "Boot priority order" list. When a device has been deactivated, an "!" (exclamation) symbol appears beside the item and system will bypass it when detecting boot device during POST. |

## Exit Menu

The Exit menu displays ways of exiting BIOS Setup Utility. After finishing with your settings, you must save and exit so that the changes can take effect.

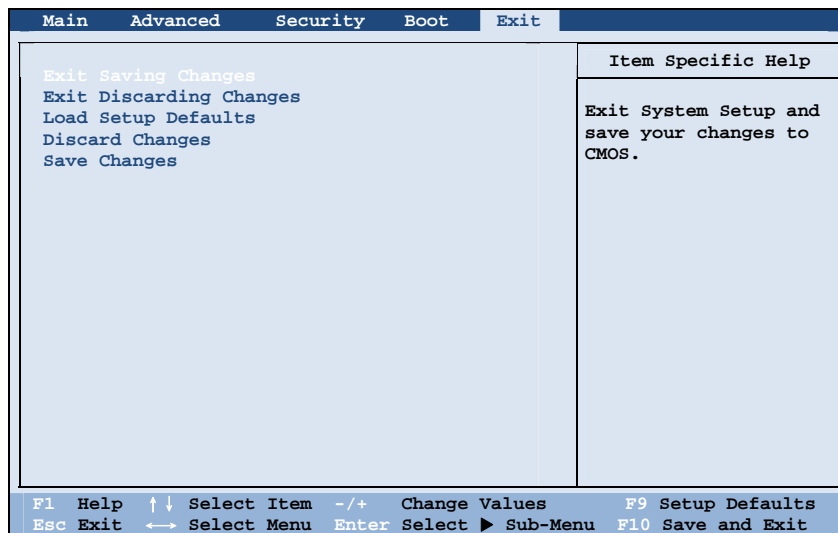

**Exit Saving Changes** saves the changes you have made and exits BIOS Setup Utility.

**Exit Discarding Changes** exits BIOS Setup Utility without saving the changes you have made.

**Load Setup Defaults** loads the factory default values for all the items.

**Discard Changes** restores the previous values for all the items.

**Saves Changes** saves the changes you have made.



# System Recovery

Use System Recovery when:

- Your Windows operating system does not start at all.
- You want to restore the factory default Windows settings.

**WARNING:** Using this feature will reinstall Windows to your system. All data on the hard disk drive will be lost.

To run System Recovery:

1. During system startup when the following screen appears, press **Ctrl + Alt + F2** keys for four seconds.

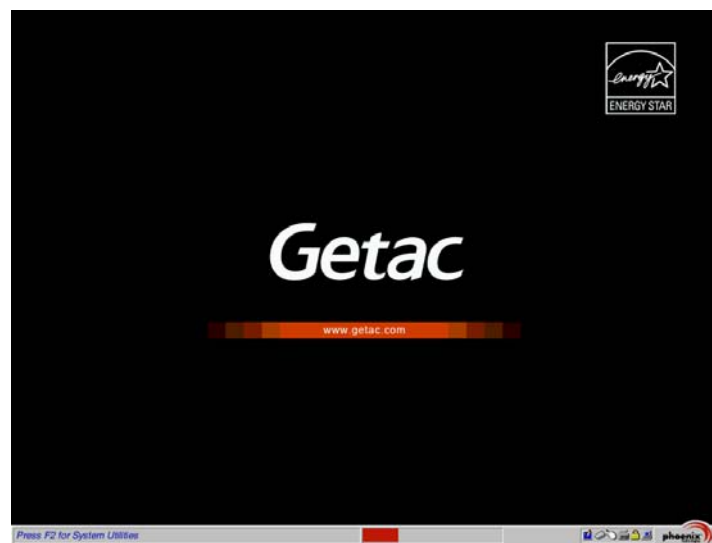

2. The message **This will help you reinstall Windows to the whole HDD to factory default. All data on HDD will be lost** appears on the screen to ask if you want to access System Recovery. Type **1** to continue or type **0** to exit.

3. A warning message appears as follows:
- ```
*****
You must accept the following terms before performing the recovery
process:
1. The recovery software is solely the purpose of reinstalling or
restoring software associated with the hard disk of this operating
GETAC machine.
2. Except the above, no other use is granted hereunder.
*****
(1)Yes, I agree to the provisions of this agreement and wish to
continue.
(0)No, I do not agree to the provisions of this agreement and do
not wish to continue.
Type 1 to continue.
```
4. Type **Y** when the message **Are you sure you want to recover now?**  
**(Y)Yes (N)No** appears onscreen. The following screen appears and  
system will perform the recovery process and Windows operating  
system will be re-installed to its default setting:

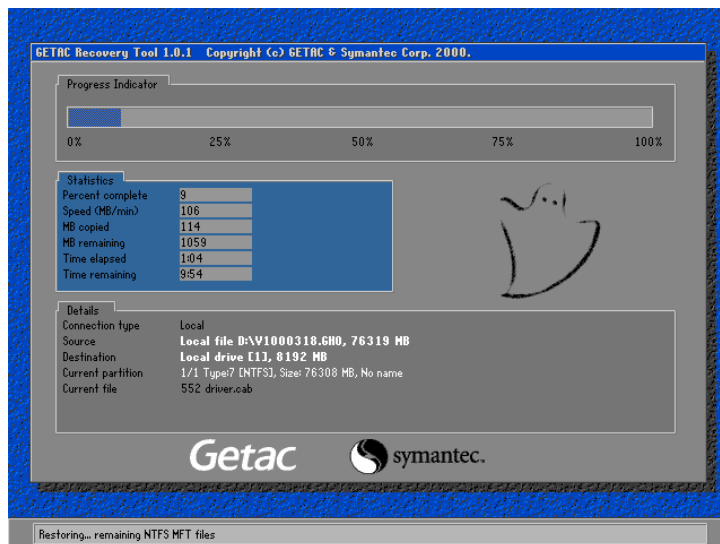

5. After the recovery process has been completed successfully, the GSI (GETAC Smart Installer) screen is displayed at the first boot-up of Windows operating system.

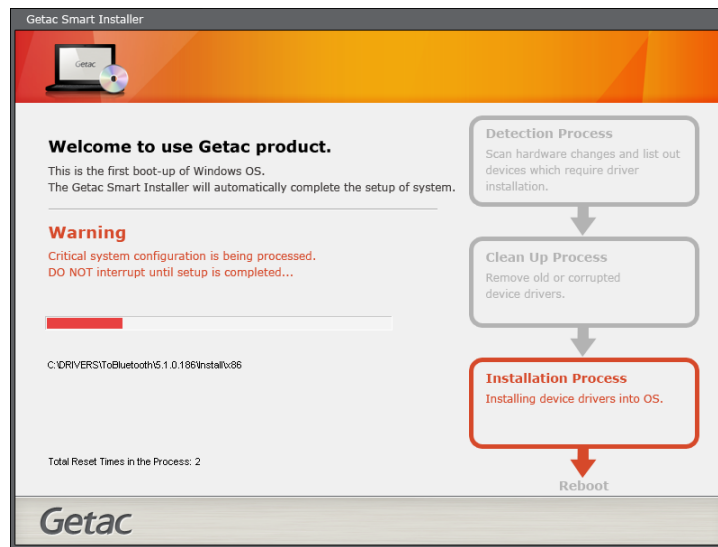

6. GSI will automatically perform system hardware detection and driver installation. After GSI has completed the whole process successfully, system will reboot.

## Chapter 6

# Installing Software Drivers and Utilities

To take full advantage of the unique features of your computer, drivers and utilities must be installed.

If you purchased the computer with Windows pre-installed, your dealer may have already installed the drivers and utilities. If not, you need to install them using the disc supplied with your computer.

This chapter describes how to install the drivers and utilities.

# How to Use the Driver Disc

## NOTE:

- The drivers may have been updated after this manual was published. For driver upgrade, please contact your dealer.
- This disc supports Windows XP, Windows Vista, and Windows 7.
- The available items may differ according to your computer model. Some items are for select models only.
- Do not remove the driver disc when installing the driver.

An autorun program is provided on the driver disc to help you easily install the drivers. As you insert the disc, the autorun program automatically starts. If you need to start the program manually, run the **Autorun.exe** program from the driver disc.

When the following screen appears, select **Windows XP**, **Windows Vista**, or **Windows 7** based on the operating system installed.



The **User Manual** item on the screen allows you to view the User Manual with Adobe Acrobat Reader. If you do not have Adobe Acrobat Reader on your computer, install the program by clicking **Adobe Reader**.



# Installation for Windows XP

After selecting the operating system Windows XP, the driver installation menu appears. To install a driver, just click the particular button and follow the onscreen instructions to complete the installation.

## Drivers on the First Page



| Item                 | Description                                                                                                   |
|----------------------|---------------------------------------------------------------------------------------------------------------|
| <b>Device Driver</b> | Ensures the full function of the other drivers. Install this main driver before installing the other drivers. |
| <b>AHCI</b>          | Brings up a submenu as shown on the right.                                                                    |
| <b>Readme</b>        | Provides information on the AHCI driver.                                                                      |
| <b>AHCI driver</b>   | Installs the AHCI driver for full functionality of the AHCI feature.                                          |



| Item                | Description                                                                                                                   |
|---------------------|-------------------------------------------------------------------------------------------------------------------------------|
| <b>vPro Utility</b> | Installs the utility that starts the setup and configuration process for an Intel ® vPro system in an enterprise environment. |
| <b>WiFi</b>         | Installs the WLAN driver/utility for wireless network connection.                                                             |
| <b>Touch Screen</b> | Installs the touchscreen driver/utility for using the touchscreen feature (select models only).                               |

## Drivers on the Second Page





| Item                     | Description                                                                                       |
|--------------------------|---------------------------------------------------------------------------------------------------|
| <b>Digitizer</b>         | Installs the digitizer driver for using the digitizer feature (select models only).               |
| <b>TPM</b>               | Installs the TPM driver/utility for using the TPM (Trusted Platform Module) support for security. |
| <b>Smart Card Reader</b> | Installs the SmartCard driver for accessing SmartCards (select models only).                      |

| Item              | Description                                                                                                                           |
|-------------------|---------------------------------------------------------------------------------------------------------------------------------------|
| <b>GPS</b>        | Installs the GPS driver for using the GPS feature (select models only). The instructions for installing the GPS driver will appear.   |
| <b>GPS Filter</b> | Works with the previous item. You must install this driver after installing the above driver to complete the GPS driver installation. |

## Drivers on the Third Page



| Item             | Description                                                                                 |
|------------------|---------------------------------------------------------------------------------------------|
| <b>Bluetooth</b> | Installs the Bluetooth driver/utility for using the Bluetooth feature (select models only). |

| Item                  | Description                                                                                                                                                                                                        |
|-----------------------|--------------------------------------------------------------------------------------------------------------------------------------------------------------------------------------------------------------------|
| <b>WCDMA</b>          | <p>Brings up a submenu as shown on the right.</p> <p>Install the three items for using the 3G feature (select models only).</p>  |
| <b>Finger print</b>   | <p>Installs the driver/utility for using the finger print feature (select models only).</p>                                                                                                                        |
| <b>Docking</b>        | <p>Brings up a submenu as shown on the right.</p>                                                                                |
| <b>Video Capture</b>  | <p>Installs the video capture driver.</p>                                                                                                                                                                          |
| <b>USB to COM</b>     | <p>Installs the USB-to-COM driver.</p>                                                                                                                                                                             |
| <b>USB to LAN</b>     | <p>Installs the USB-to-LAN driver.</p>                                                                                                                                                                             |
| <b>Getac Utility</b>  | <p>Brings up a submenu as shown on the right.</p>                                                                               |
| <b>Getac Manager</b>  | <p>Installs the G-Manager utility that manages and configures various system resources.</p>                                                                                                                        |
| <b>Button Manager</b> | <p>Installs the Button Manager utility that can customize your computer's quick buttons.</p>                                                                                                                       |
| <b>Getac Camera</b>   | <p>Installs the G-Camera Lite utility that you can use to take pictures using your computer (select models only).</p>                                                                                              |

| Item                  | Description                                                               |
|-----------------------|---------------------------------------------------------------------------|
| <b>V-GPS</b>          | Installs the V-GPS utility that displays GPS status (select models only). |
| <b>Barcode Reader</b> | Installs the Barcode Reader program (select models only).                 |



# Installation for Windows Vista

After selecting the operating system Windows Vista, the driver installation menu appears. To install a driver, just click the particular button and follow the onscreen instructions to complete the installation.

## Drivers on the First Page



| Item                 | Description                                                                                                   |
|----------------------|---------------------------------------------------------------------------------------------------------------|
| <b>Device Driver</b> | Ensures the full function of the other drivers. Install this main driver before installing the other drivers. |
| <b>VGA</b>           | Installs the VGA driver for full functionality of the video subsystem.                                        |
| <b>Modem</b>         | Installs the modem driver.                                                                                    |
| <b>WiFi</b>          | Installs the WLAN driver/utility for wireless network connection.                                             |
| <b>LAN</b>           | Installs the LAN driver for Ethernet network connection.                                                      |
| <b>Touch Screen</b>  | Installs the touchscreen driver/utility for using the touchscreen feature (select models only).               |

## Drivers on the Second Page



| Item                | Description                                                                                                                           |
|---------------------|---------------------------------------------------------------------------------------------------------------------------------------|
| <b>vPRO Utility</b> | Installs the utility that starts the setup and configuration process for an Intel® vPro system in an enterprise environment.          |
| <b>Digitizer</b>    | Installs the digitizer driver for using the digitizer feature (select models only).                                                   |
| <b>TPM</b>          | Installs the TPM driver/utility for using the TPM (Trusted Platform Module) support for security.                                     |
| <b>GPS</b>          | Installs the GPS driver for using the GPS feature (select models only). The instructions for installing the GPS driver will appear.   |
| <b>GPS Filter</b>   | Works with the previous item. You must install this driver after installing the above driver to complete the GPS driver installation. |

| Item         | Description                                                                                                                                                                                             |
|--------------|---------------------------------------------------------------------------------------------------------------------------------------------------------------------------------------------------------|
| <b>WCDMA</b> | Brings up a submenu as shown on the right.<br>Install the three items for using the 3G feature (select models only).  |

## Drivers on the Third Page

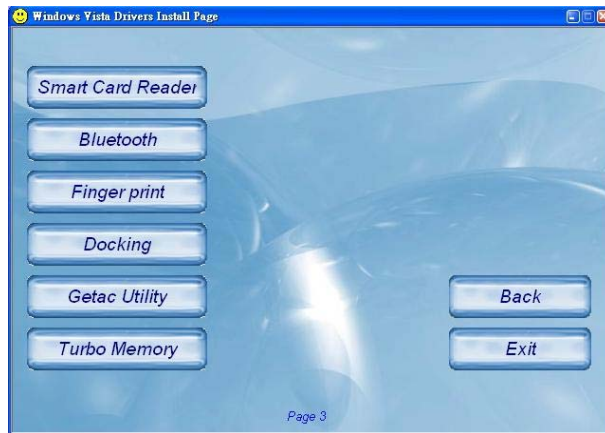

| Item                     | Description                                                                                 |
|--------------------------|---------------------------------------------------------------------------------------------|
| <b>Smart Card Reader</b> | Installs the SmartCard driver for accessing SmartCards (select models only).                |
| <b>Bluetooth</b>         | Installs the Bluetooth driver/utility for using the Bluetooth feature (select models only). |

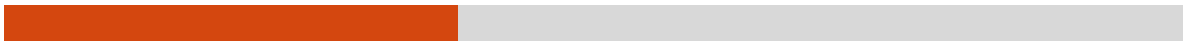



| Item                  | Description                                                                                                    |
|-----------------------|----------------------------------------------------------------------------------------------------------------|
| <b>Finger print</b>   | Installs the driver/utility for using the finger print feature (select models only).                           |
| <b>Docking</b>        | Brings up a submenu as shown on the right.                                                                     |
| <b>Video Capture</b>  | Installs the video capture driver.                                                                             |
| <b>USB to COM</b>     | Installs the USB-to-COM driver.                                                                                |
| <b>USB to LAN</b>     | Installs the USB-to-LAN driver.                                                                                |
| <b>Getac Utility</b>  | Brings up a submenu as shown on the right.                                                                     |
| <b>Getac Manager</b>  | Installs the G-Manager utility that manages and configures various system resources.                           |
| <b>Button Manager</b> | Installs the Button Manager utility that can customize your computer's quick buttons.                          |
| <b>Getac Camera</b>   | Installs the G-Camera Lite utility that you can use to take pictures using your computer (select models only). |
| <b>V-GPS</b>          | Installs the V-GPS utility that displays GPS status (select models only).                                      |
| <b>Barcode Reader</b> | Installs the Barcode Reader program (select models only).                                                      |
| <b>Hotfix</b>         | Allows you to perform the necessary fix(es) for the computer devices.                                          |
| <b>Turbo Memory</b>   | Installs the Turbo Memory driver for boosting system                                                           |



---

|  |              |
|--|--------------|
|  | performance. |
|--|--------------|

---



# Installation for Windows 7

After selecting the operating system Windows 7, the driver installation menu appears. To install a driver, just click the particular button and follow the onscreen instructions to complete the installation.

## Drivers on the First Page



| Item                 | Description                                                                                                   |
|----------------------|---------------------------------------------------------------------------------------------------------------|
| <b>Device Driver</b> | Ensures the full function of the other drivers. Install this main driver before installing the other drivers. |
| <b>VGA</b>           | Installs the VGA driver for full functionality of the video subsystem.                                        |
| <b>LAN</b>           | Installs the LAN driver for Ethernet network connection.                                                      |
| <b>Modem</b>         | Installs the modem driver.                                                                                    |
| <b>WiFi</b>          | Installs the WLAN driver/utility for wireless network connection.                                             |
| <b>Touch Screen</b>  | Installs the touchscreen driver/utility for using the touchscreen feature (select models only).               |

## Drivers on the Second Page



| Item                | Description                                                                                                                           |
|---------------------|---------------------------------------------------------------------------------------------------------------------------------------|
| <b>vPro Utility</b> | Installs the utility that starts the setup and configuration process for an Intel® vPro system in an enterprise environment.          |
| <b>Digitizer</b>    | Installs the digitizer driver for using the digitizer feature (select models only).                                                   |
| <b>TPM</b>          | Installs the TPM driver/utility for using the TPM (Trusted Platform Module) support for security.                                     |
| <b>GPS</b>          | Installs the GPS driver for using the GPS feature (select models only). The instructions for installing the GPS driver will appear.   |
| <b>GPS Filter</b>   | Works with the previous item. You must install this driver after installing the above driver to complete the GPS driver installation. |

| Item         | Description                                                                                                                                                                                             |
|--------------|---------------------------------------------------------------------------------------------------------------------------------------------------------------------------------------------------------|
| <b>WCDMA</b> | Brings up a submenu as shown on the right.<br>Install the three items for using the 3G feature (select models only).  |

## Drivers on the Third Page



| Item                     | Description                                                                                 |
|--------------------------|---------------------------------------------------------------------------------------------|
| <b>Smart Card Reader</b> | Installs the SmartCard driver for accessing SmartCards (select models only).                |
| <b>Bluetooth</b>         | Installs the Bluetooth driver/utility for using the Bluetooth feature (select models only). |
| <b>Finger print</b>      | Installs the driver/utility for using the finger print feature (select models only).        |

| Item                  | Description                                                                                                    |
|-----------------------|----------------------------------------------------------------------------------------------------------------|
| <b>Docking</b>        | Brings up a submenu as shown on the right.                                                                     |
| <b>Video Capture</b>  | Installs the video capture driver.                                                                             |
| <b>USB to COM</b>     | Installs the USB-to-COM driver.                                                                                |
| <b>USB to LAN</b>     | Installs the USB-to-LAN driver.                                                                                |
| <b>Getac Utility</b>  | Brings up a submenu as shown on the right.                                                                     |
| <b>Getac Manager</b>  | Installs the G-Manager utility that manages and configures various system resources.                           |
| <b>Button Manager</b> | Installs the Button Manager utility that can customize your computer's quick buttons.                          |
| <b>Getac Camera</b>   | Installs the G-Camera Lite utility that you can use to take pictures using your computer (select models only). |
| <b>V-GPS</b>          | Installs the V-GPS utility that displays GPS status (select models only).                                      |
| <b>Barcode Reader</b> | Installs the Barcode Reader program (select models only).                                                      |
| <b>Turbo Memory</b>   | Installs the Turbo Memory driver for boosting system performance.                                              |



## Chapter 7

# Using Getac Software

Getac software is provided for enhanced capabilities and management. This chapter describes how to use the software.

# Using G-Manager

G-Manager is a unified user interface utility that allows you to manage and configure the following:

- System
- Battery
- ECO (economy mode)
- Light Sensor
- Ignition
- Monitoring
- GPS Status

To start up G-Manager, do one of the following:

- Click **Start → All Programs → GETAC Utility**, or
- Right-click on the GETAC Utility icon (  ) located on the taskbar and click **G-Manager**.

The screen as shown next appears.





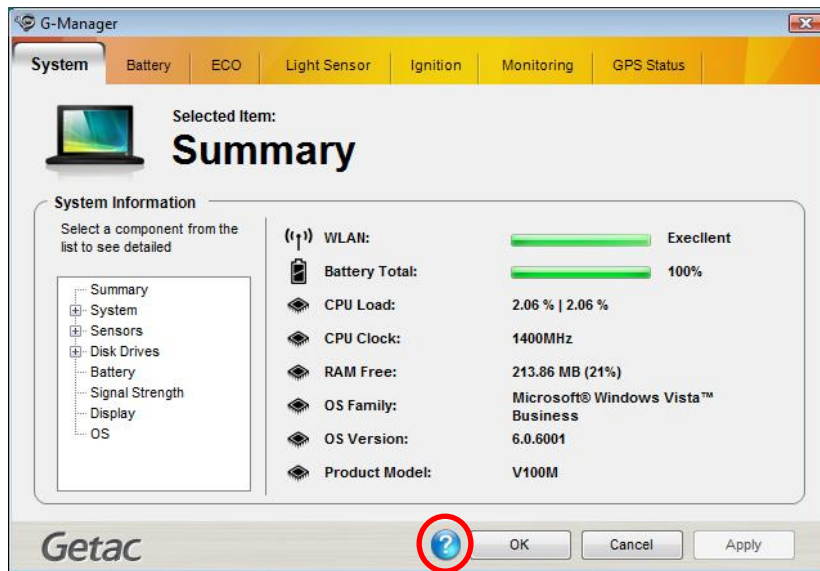

For detailed descriptions of G-Manager, click .

# Using Button Manager

The five quick buttons located on the front of your computer come with predefined functions. You can use Button Manager to re-define the buttons.

1. Click **Start → Programs → Button Manager → Button Manager**. The following screen appears.



2. Select the button to re-define.
3. Under the **Update Button Function** click the **Key Name** dropdown list to select a new button function.

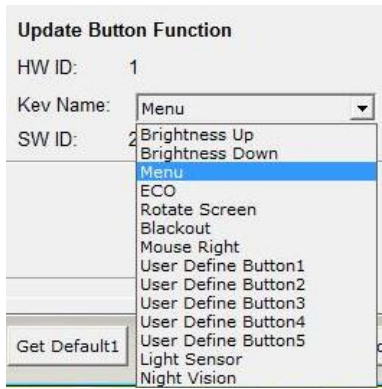

4. Repeat the steps for the other buttons that you want to re-define.
5. Click **Save** to save your configurations.
6. Click **Start Flash** to start the flash process, the percentage of flash process will be shown.
7. Click **Load** the next time you use Button Manager to load any previously saved configurations.

# Using Getac Camera (Optional)

Getac Camera is a geo-tagging camera program, which allows you to stamp geographical information on photos as watermarks and embed such information into JPEG files as EXIF 2.2 metadata.





**NOTE:**











- Getac Camera works with Virtual-GPS (a separate application program). Make sure that Virtual-GPS is installed in your computer.
- Before starting Getac Camera, close any other program that uses the camera; otherwise, Getac Camera can only provide limited functions.
- The instructions in this document are based on touch screen operations though there are equivalent touchpad and mouse operations.

To start the program, tap the Getac Camera program icon on Windows desktop. The Getac Camera window appears as shown below.

The GPS positioning will be automatically activated. When the GPS positioning is completed, you will see the geographical information in the watermark area on the image.

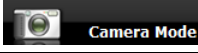

| No. | Screen Elements               | Descriptions                                                                                                                                                                                                                              |
|-----|-------------------------------|-------------------------------------------------------------------------------------------------------------------------------------------------------------------------------------------------------------------------------------------|
| ①   | <b>Preview/Display Window</b> | Displays the live image in Camera mode and the selected image in View mode.                                                                                                                                                               |
| ②   | <b>GPS Status</b>             | Indicates if the GPS positioning is completed (  ) or not (  ). |
| ③   | <b>Window Control Buttons</b> |  Minimizes the program window.                                                                                                                         |
|     |                               |  Resizes/maximizes the program window.<br>When resized, the smaller window size is fixed. You can move it but cannot change the size furthermore.      |
|     |                               |  Closes the program.                                                                                                                                   |

| No. | Screen Elements        | Descriptions                                                                                                                                                                                                                                                                                                                                                                                  |
|-----|------------------------|-----------------------------------------------------------------------------------------------------------------------------------------------------------------------------------------------------------------------------------------------------------------------------------------------------------------------------------------------------------------------------------------------|
| ④   | <b>Status Display</b>  | Indicates the use of a feature.                                                                                                                                                                                                                                                                                                                                                               |
|     |                        |  GPS Lock in use                                                                                                                                                                                                                                                                                             |
|     |                        |  Front / Bottom Front/Bottom camera in use                                                                                                                                                                                                                                                                   |
|     |                        |  Night mode in use                                                                                                                                                                                                                                                                                           |
|     |                        |  Continuous/Timer mode in use                                                                                                                                                                                                                                                                                |
| ⑤   | <b>Control Buttons</b> | Perform immediate tasks on the current image. (See “Camera Controls” and “Viewing Controls” for information.)                                                                                                                                                                                                                                                                                 |
| ⑥   | <b>Watermark</b>       | Displays the GPS information such as direction, longitude, latitude, GPS status, date, and time.                                                                                                                                                                                                                                                                                              |
| ⑦   | <b>Thumbnail Tray</b>  | Displays up to 7 pictures in a thumbnail view. The middle is the picture last taken or selected. You can drag toward the right or left to scroll through the thumbnail view. The  /  button hides/shows the Thumbnail Tray. |
| ⑧   | <b>Command Buttons</b> |  Camera Mode Switches to Camera Mode.                                                                                                                                                                                                                                                                        |
|     |                        |  View Mode Switches to View Mode.                                                                                                                                                                                                                                                                           |
|     |                        |  GPS Switches to GPS view.                                                                                                                                                                                                                                                                                 |
|     |                        |  Settings Switches to the Settings screen.                                                                                                                                                                                                                                                                 |
|     |                        |  About Provides copyright, licensing, and help information.                                                                                                                                                                                                                                                |

## Taking Pictures

1. Start the Getac Camera program. You will be in Camera Mode.

2. For camera settings such as timer, brightness, etc., tap  Settings. (See "Camera Settings" for detailed information.)

If needed, you can turn on/off GPS lock or watermark using the buttons on the right. (See "Camera Controls" for detailed information.)

3. Aim the camera lens at your subject.

Tap and hold the  button for focusing. A white plus sign and frame appear. Wait until the subject is in focus.

**NOTE:** The focus button is not available on computer models with 1.3MP camera.

4. When ready, you can shoot the picture in either of the two methods:

- **Method 1:** Tap the  button.

**TIPS:** If your computer model comes with multi-touch screen and Windows 7, You can conveniently tap the focus button using your left hand and tap the shutter button using your right hand at the same time.





- **Method 2:** Drag the preview image and drop it into Thumbnail Tray.



5. The picture will appear in the middle of the Thumbnail View and be saved to the predefined storage location.

## Camera Controls

Two control buttons to the right of the Preview Window allow you to turn on or off GPS lock and watermark.

| Control Buttons                                                                   | Descriptions                                                                                                                                                                                                                                                                                                                                                                                                                                                                                                                                                                        |
|-----------------------------------------------------------------------------------|-------------------------------------------------------------------------------------------------------------------------------------------------------------------------------------------------------------------------------------------------------------------------------------------------------------------------------------------------------------------------------------------------------------------------------------------------------------------------------------------------------------------------------------------------------------------------------------|
|  | <p>Turns on/off GPS lock. The icon in the button shows the current status.</p> <p>GPS lock allows you record the exact location of the object you are shooting instead of where you are using the computer to shoot the picture. First, put the computer near your object and tap this button to lock the GPS information; then, you can go farther away to where you can have a good view of the object for the shooting.</p> <p>Remember to turn off GPS lock when the feature is not needed for the next picture. The GPS lock is always off whenever you start the program.</p> |
|  | <p>Turns off/on watermark. The icon in the button shows the current status.</p> <p>You can turn off watermark if you do not want the watermark to show in the picture. Your setting remains effective until you change it again.</p>                                                                                                                                                                                                                                                                                                                                                |

## Viewing Images

Tap  at the bottom of the screen to switch to View Mode.

While in Camera Mode, you can also switch to View Mode by either of the two methods:



- **Method 1:** Double tap the thumbnail in the Thumbnail Tray.
- **Method 2:** Drag the thumbnail and drop into the preview window.



## Selecting an Image to View

To scroll through the Thumbnail Tray, drag the tray toward the left or right.







To select an image to view, use either of the two methods:

- **Method 1:** Double tap the thumbnail in the Thumbnail Tray.

- **Method 2:** Drag the thumbnail and drop into the display window.



## Viewing Controls

| To                                                                 | Via Control Buttons                                                                 | Via Multi-touch Operations (Select Models Only*)                                                                                             |
|--------------------------------------------------------------------|-------------------------------------------------------------------------------------|----------------------------------------------------------------------------------------------------------------------------------------------|
| Zoom in/out (up to four scales)                                    |    |  <p>Drag two fingers apart/towards to zoom in/out.</p>     |
| When zoomed in, you can drag to view another portion of the image. |                                                                                     |                                                                                                                                              |
| To                                                                 | Via Control Buttons                                                                 | Via Multi-touch Operations (Select Models Only*)                                                                                             |
| Restore to the 100% scale                                          |  | —                                                                                                                                            |
| Rotate to the right/left by 15°                                    |  |  <p>Drag two fingers in a clockwise/counterclockwise</p> |

|  |  |                  |
|--|--|------------------|
|  |  | circular motion. |
|--|--|------------------|

\* Multi-touch operations are available only on computer models with multi-touch screen and Windows 7.



## Viewing Image Properties

Switch to View Mode, select the image, and tap  to view the properties.



Scroll down for more information. To switch back to image view, tap .

## Adding Notes to an Image

1. Switch to View Mode, select the image, and tap .
2. In properties view, tap .
3. Type your notes in the entry field.



4. When completed, tap .

The first three lines of the notes show on the screen.

## Camera Settings



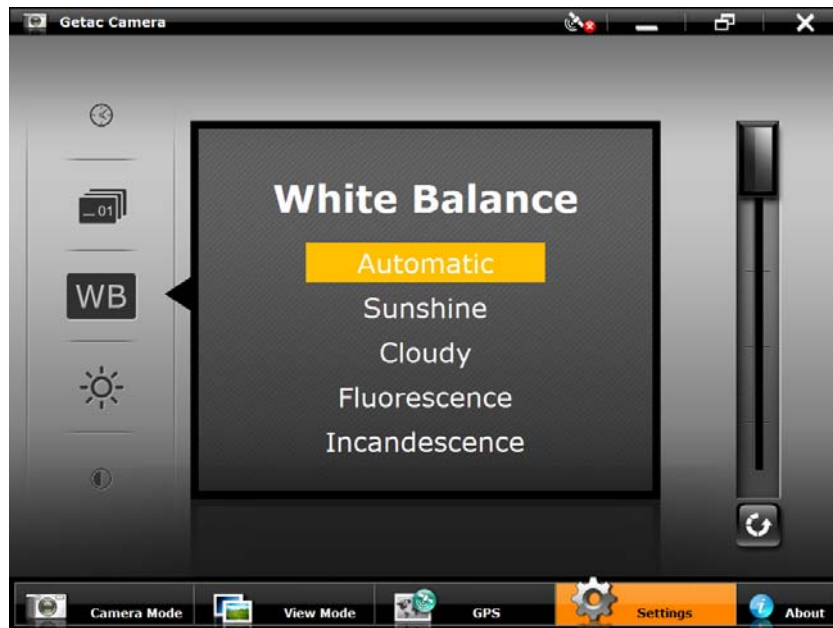







To change camera settings, tap  **Settings** at the bottom of the screen. The Settings window appears showing the setting item previously accessed.









Along the left of the window are all the setting items. You can drag this area up or down to scroll through the items. The middle of the window displays the current item and setting value. To the right is the adjustment bar where you can tap or drag to change the setting value.



All changes (except for **Camera Mode**) remain effective until you change them again.

| Setting Items                                                                       | Name                 | Descriptions                                                                                                                                                              |
|-------------------------------------------------------------------------------------|----------------------|---------------------------------------------------------------------------------------------------------------------------------------------------------------------------|
|  | <b>White Balance</b> | Five choices from which you can select one that matches the current light source: <b>Automatic</b> (default), <b>Sunshine</b> , <b>Cloudy</b> , <b>Fluorescence</b> , and |

|                                                                                     |                   |                                                                                                                                                                                                                                                      |
|-------------------------------------------------------------------------------------|-------------------|------------------------------------------------------------------------------------------------------------------------------------------------------------------------------------------------------------------------------------------------------|
|                                                                                     |                   | <p><b>Incandescence.</b></p> <p><b>NOTE:</b> Only one choice (<b>Automatic</b>) is available on computer models with 1.3MP camera.</p>                                                                                                               |
|    | <b>Brightness</b> | <p>Adjusts the brightness level. The range of levels depends on computer models.</p> <p>You can tap  to restore to the default level.</p>                           |
|    | <b>Contrast</b>   | <p>Adjusts the contrast level. The range of levels depends on computer models.</p> <p>You can tap  to restore to the default level.</p>                             |
|    | <b>Hue</b>        | <p>Adjusts the hue level. The range of levels depends on computer models.</p> <p>You can tap  to restore to the default level.</p>                                  |
|    | <b>Flicker</b>    | <p>Sets the frequency to match the local electrical system for flicker free shooting under electric light. Choices are: <b>60Hz</b> (default) and <b>50Hz</b>.</p>                                                                                   |
|    | <b>LED Light</b>  | <p>Turns <b>On</b> (default) or <b>Off</b> the LED light.</p> <p>This item is available for setting only on models with the LED light.</p>                                                                                                           |
|   | <b>Night Mode</b> | <p>Turns <b>On</b> or <b>Off</b> (default) night mode.</p> <p>You can turn on the feature for shooting in low light situations.</p>                                                                                                                  |
|  | <b>Image Size</b> | <p>Sets the image resolution. Available choices depend on your computer model:</p> <p><b>640x480, 800x600, 1024x768, 1280x960,</b> and <b>1600x1200</b> for 2.0MP Camera.</p> <p><b>320x240, 640x480,</b> and <b>1280x1024</b> for 1.3MP Camera.</p> |

| Setting Items                                                                       | Name                  | Descriptions                                                                                                                                                         |                                                                                                  |
|-------------------------------------------------------------------------------------|-----------------------|----------------------------------------------------------------------------------------------------------------------------------------------------------------------|--------------------------------------------------------------------------------------------------|
|    | <b>Camera Mode</b>    | Three choices for the shooting mode:                                                                                                                                 |                                                                                                  |
|                                                                                     |                       | <b>Normal</b>                                                                                                                                                        | This is the default setting whenever the program is started.                                     |
|                                                                                     |                       | <b>Continuous</b>                                                                                                                                                    | Continuous shooting of 3 pictures (1 shot per second).                                           |
|                                                                                     |                       | <b>Timer</b>                                                                                                                                                         | 5-second countdown before shooting.                                                              |
|    | <b>Status Display</b> | Turns <b>On</b> (default) or <b>Off</b> the display of the status indicators.                                                                                        |                                                                                                  |
|    | <b>Watermark</b>      | Turns <b>On</b> (default) or <b>Off</b> the display of watermark in the image. (Turning off does not affect the embedded EXIF 2.2 metadata.)                         |                                                                                                  |
|    | <b>Shutter Sound</b>  | Turns <b>On</b> (default) or <b>Off</b> the sound played upon photo shooting.                                                                                        |                                                                                                  |
|    | <b>Power Saving</b>   | Sets if power saving works for the program.                                                                                                                          |                                                                                                  |
|                                                                                     |                       | <b>System</b> (default)                                                                                                                                              | The Camera program enters power saving mode according to the settings of Windows' Power Options. |
|                                                                                     | <b>Never</b>          | The Camera program will not enter power saving mode while the program window is open. But when the program window is minimized, the <b>System</b> setting overrides. |                                                                                                  |
|  | <b>Camera Switch</b>  | Switches to the <b>Front</b> (default) or <b>Bottom</b> camera lens.<br>The latter is available for selection only on computer models with two cameras.              |                                                                                                  |



| Setting Items                                                                       | Name                                                                                                                                                          | Descriptions                                                                                                                                                                                                                                                                                                                                                                                                                                                                                                                                                                                 |                                      |                                                                                                                                                               |            |                                                  |
|-------------------------------------------------------------------------------------|---------------------------------------------------------------------------------------------------------------------------------------------------------------|----------------------------------------------------------------------------------------------------------------------------------------------------------------------------------------------------------------------------------------------------------------------------------------------------------------------------------------------------------------------------------------------------------------------------------------------------------------------------------------------------------------------------------------------------------------------------------------------|--------------------------------------|---------------------------------------------------------------------------------------------------------------------------------------------------------------|------------|--------------------------------------------------|
|    | <b>Folder Path</b>                                                                                                                                            | <p>Sets the storage location of the images. To change to a different folder, tap <b>Browse</b> and select the folder.</p> <p>The default location is <b>User\[user name]\Pictures</b> folder that contains the original images. A subfolder named <b>Thumbs</b> contains a copy of the same images (with filename prefix <b>Thumb_</b>) for the thumbnail view.</p> <p><b>NOTE:</b> If you are adding or deleting images using File Explorer, make sure to work on both the correct folder and its <b>Thumbs</b> subfolder.</p>                                                              |                                      |                                                                                                                                                               |            |                                                  |
|    | <b>Time Option</b>                                                                                                                                            | <p>Displays the time throughout the program according to one of the two choices:</p> <table border="1" data-bbox="659 730 1286 1028"> <tr> <td data-bbox="659 730 810 947"><b>System time zone</b><br/>(default)</td> <td data-bbox="810 730 1286 947">The time zone setting of the computer is taken into consideration. If the current location is in daylight saving time, the time will be adjusted accordingly.</td> </tr> <tr> <td data-bbox="659 947 810 1028"><b>UTC</b></td> <td data-bbox="810 947 1286 1028">The time is based on Coordinated Universal Time.</td> </tr> </table> | <b>System time zone</b><br>(default) | The time zone setting of the computer is taken into consideration. If the current location is in daylight saving time, the time will be adjusted accordingly. | <b>UTC</b> | The time is based on Coordinated Universal Time. |
| <b>System time zone</b><br>(default)                                                | The time zone setting of the computer is taken into consideration. If the current location is in daylight saving time, the time will be adjusted accordingly. |                                                                                                                                                                                                                                                                                                                                                                                                                                                                                                                                                                                              |                                      |                                                                                                                                                               |            |                                                  |
| <b>UTC</b>                                                                          | The time is based on Coordinated Universal Time.                                                                                                              |                                                                                                                                                                                                                                                                                                                                                                                                                                                                                                                                                                                              |                                      |                                                                                                                                                               |            |                                                  |
|  | <b>Filename Prefix</b>                                                                                                                                        | <p>The default filename prefix is <b>IMG</b>. The complete filename is <b>IMG_XXXXXX.jpg</b> (where <b>XXXXXX</b> = sequential number). When the sequential number has reached 999999 and you are taking the next picture, a message will pop up to ask you to change the prefix.</p> <p>You can change the prefix by typing the characters (limited to A-Z, a-z, 0-9, - and _) in the entry field. Maximum number of characters allowed is 10.</p>                                                                                                                                          |                                      |                                                                                                                                                               |            |                                                  |



# Using Getac Barcode Reader (OptionI)

Getac Barcode Reader is a camera-based barcode reading application program. It can identify barcodes of the following types and input the decoded data into any existing processing software.

Barcode types supported:

- **1D** – Code 128, Code 39, and EAN family (EAN/JAN-13, EAN/JAN-8, UPC-A, UPC-E)
- **2D** – QR Code

**NOTE:** Recommended for use with the 2.0MP (or higher resolution) camera.

## Reading Barcodes

### **NOTE:**

- Before starting Getac Barcode Reader, close any other program that uses the camera.
- The instructions in this document are based on touch screen operations though there are equivalent touchpad and mouse operations.
- The procedure below is based on the default settings of Getac Barcode Reader.

1. Tap the Getac Barcode Reader program icon on Windows desktop to start the program. The Barcode Reader screen is always on top of other screens.

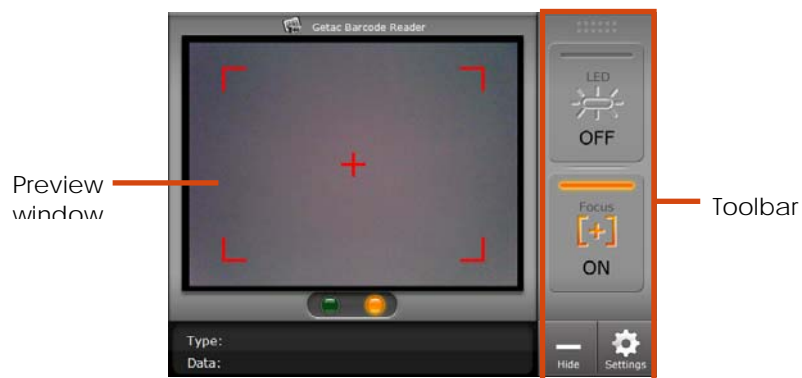

If this is the first time you start the program after it has been installed, the Settings screen instead of the main screen appears. (See “Barcode Reader Settings” for information.)

2. Start your processing software and open a new or existing file. Place the insertion point (or called cursor) where you want the data to be entered.

**NOTE:** If you start the processing software first and then Getac Barcode Reader or if you have switched to another computer program during the barcode reading session, make sure to set the insertion point again in the processing software before reading the barcode.

3. Bring the barcode to face the camera lens. Orient the barcode either upright or upside down in the preview window. (Rotation by  $\pm 90^\circ$  is not supported.)



4. Wait for the program to focus and read the barcode.
5. When the reading is successful, the green indicator lights up. The barcode type and decoded data are shown at the bottom. The **Accept** and **Discard** buttons appear.



6. Tap the **Accept** button for the data to be entered into your processing software. A sound will be played to indicate completion of the entry.

Barcode entries are separated by "Enter" (default setting) in the processing software.

Noteepad is shown as an example of the processing software.

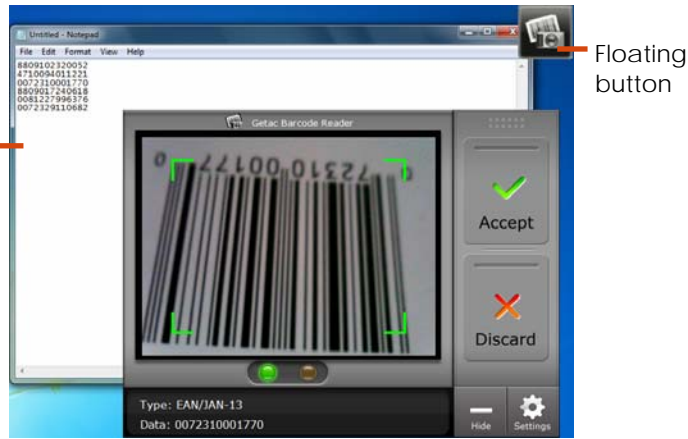







If you want to discard the data, tap the **Discard** button.

7. The orange indicator lights up again ready for the next barcode. Repeat the same action for the next entry.
8. To exit the program, tap and hold the floating button and select **Exit** from the shortcut menu.

## Toolbar

During the operation, you can use the toolbar for functions as described below.

| Buttons                                                                                                                                                                   | Descriptions                                                                                                                                                                                                     |
|---------------------------------------------------------------------------------------------------------------------------------------------------------------------------|------------------------------------------------------------------------------------------------------------------------------------------------------------------------------------------------------------------|
|  /  | <p>Turns on/off the LED light. The word ON or OFF in the button indicates the current status.</p> <p>The button is valid only for computer models with LED light.</p>                                            |
|  /  | <p>Turns on/off the focus function. The word ON or OFF in the button indicates the current status.</p> <p>When you are reading a batch of barcodes of the same size from the same distance, you can turn off</p> |

|                                                                                   |                                                                                                                                                        |
|-----------------------------------------------------------------------------------|--------------------------------------------------------------------------------------------------------------------------------------------------------|
|                                                                                   | the focus function. This speeds up the process and consumes less power.                                                                                |
|  | Hides the screen.<br>To show the screen, tap the floating button  . |
|  | Switches to the Settings screen.                                                                                                                       |

## Floating Button and Shortcut Menu

Whenever the program is started, the floating button appears at the upper right corner of the computer screen. This button provides a quick way to bring up the hidden Barcode Reader main screen. When tapping and holding the button, the shortcut menu appears.

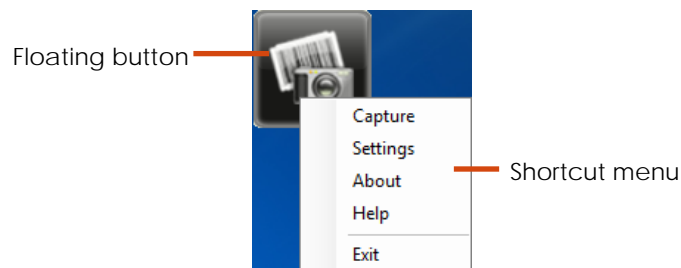

| Shortcut Menu Items | Descriptions                          |
|---------------------|---------------------------------------|
| <b>Capture</b>      | Opens the Barcode Reader main screen. |
| <b>Settings</b>     | Opens the Settings screen.            |
| <b>About</b>        | Opens the About screen.               |
| <b>Help</b>         | Opens this document.                  |
| <b>Exit</b>         | Closes the program.                   |

## Barcode Reader Settings

To set up Barcode Reader, tap  in the Barcode Reader main screen or select **Settings** from the shortcut menu. The Settings screen with three tabs appears.

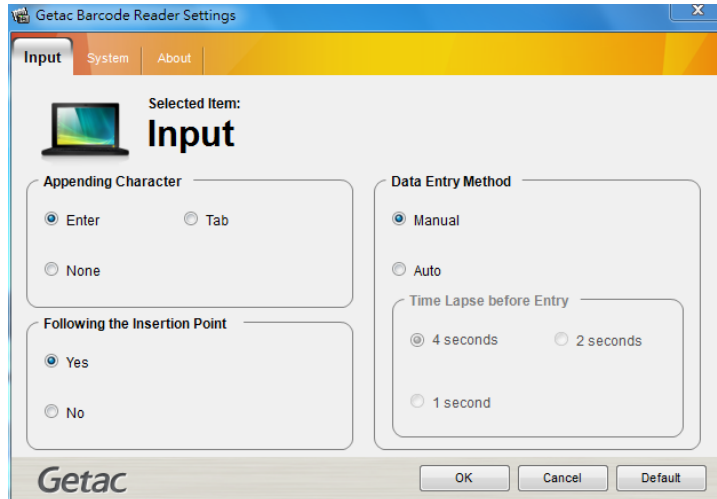



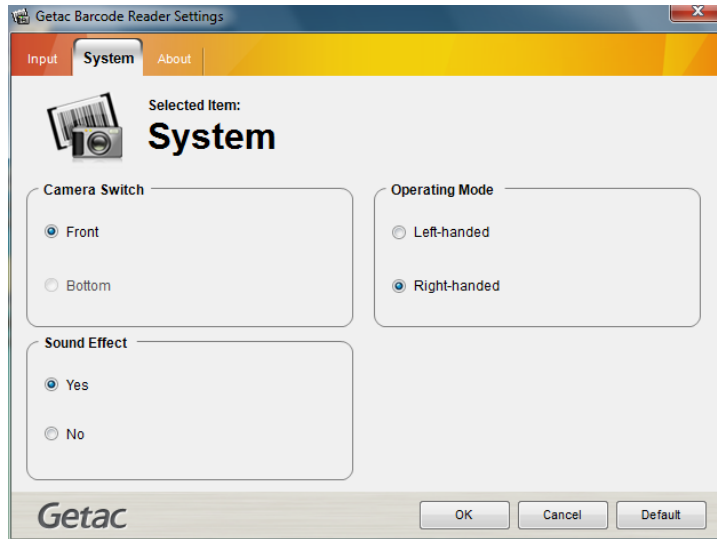

| Tabs                     | Setting Items                        | Descriptions                                       |                                                                        |
|--------------------------|--------------------------------------|----------------------------------------------------|------------------------------------------------------------------------|
| Input                    | <b>Appending Character</b>           |                                                    | Sets how individual barcodes are separated.                            |
|                          |                                      | <b>Enter</b><br>(default)                          | Each barcode begins in a new line.                                     |
|                          |                                      | <b>Tab</b>                                         | Barcodes are separated by tabs.                                        |
|                          |                                      | <b>None</b>                                        | Barcodes are not separated.                                            |
|                          | <b>Following the Insertion Point</b> |                                                    | Sets if the Barcode Reader main screen moves when necessary.           |
|                          |                                      | <b>Yes</b><br>(default)                            | The main screen will move aside to keep the latest data input visible. |
|                          |                                      | <b>No</b>                                          | The main screen remains at the same place unless you manually move it. |
| <b>Data Entry Method</b> |                                      | Sets if the decoded data is automatically entered. |                                                                        |

|               |                                |                            |                                                                                                                                                                                                                                                                    |
|---------------|--------------------------------|----------------------------|--------------------------------------------------------------------------------------------------------------------------------------------------------------------------------------------------------------------------------------------------------------------|
|               |                                | <b>Manual</b><br>(default) | Data are entered only upon your request.                                                                                                                                                                                                                           |
|               |                                | <b>Auto</b>                | Data are entered after a specific time lapse (determined by the next item).                                                                                                                                                                                        |
|               | <b>Time Lapse Before Entry</b> |                            | Sets how many seconds ( <b>4</b> , <b>2</b> , or <b>1</b> ) the program waits before entering the decoded data into the processing software. The default setting is <b>4</b> . This item is available for setting only when the above item is set to <b>Auto</b> . |
| <b>System</b> | <b>Camera Switch</b>           |                            | Switches to the <b>Front</b> (default) or <b>Bottom</b> camera lens. The latter is available for selection only on computer models with two cameras.                                                                                                               |
|               | <b>Sound Effect</b>            |                            | Turns on (default) or off the sound that indicates completion of data entry.                                                                                                                                                                                       |
|               | <b>Operating Mode</b>          |                            | Positions the toolbar at the left or right (default) side of the main screen.                                                                                                                                                                                      |

To restore default settings, tap the **Default** button.

To save any changes you have made, tap **OK**. All the changes remain effective until you change them again.

If you want to leave without applying any changes, tap **Cancel** or .



## Chapter 8

# Caring for the Computer

Taking good care of your computer will ensure a trouble-free operation and reduce the risk of damage to your computer.

This chapter gives you guidelines covering areas such as protecting, storing, cleaning, and traveling.

# Protecting the Computer

To safeguard the integrity of your computer data as well as the computer itself, you can protect the computer in several ways as described in this section.

## Using an Anti-Virus Strategy

You can install a virus-detecting program to monitor potential viruses that could damage your files.

## Using Security Center (for Windows Vista) or Action Center (for Windows 7)

Security Center (for Windows Vista) or Action Center (for Windows 7) alerts you to take action on the following security essentials:

- Windows Firewall
- Windows Update
- Malware Protection (anti-virus, anti-spyware)
- Others (Internet security, user account control)

For detailed information, see Windows' Help.

## Using the Cable Lock

You can use a Kensington-type cable lock to protect your computer against theft. The cable lock is available in most computer stores.

To use the lock, loop the lock cable around a stationary object such as a table. Insert the lock to the Kensington lock hole and turn the key to secure the lock. Store the key in a safe place.

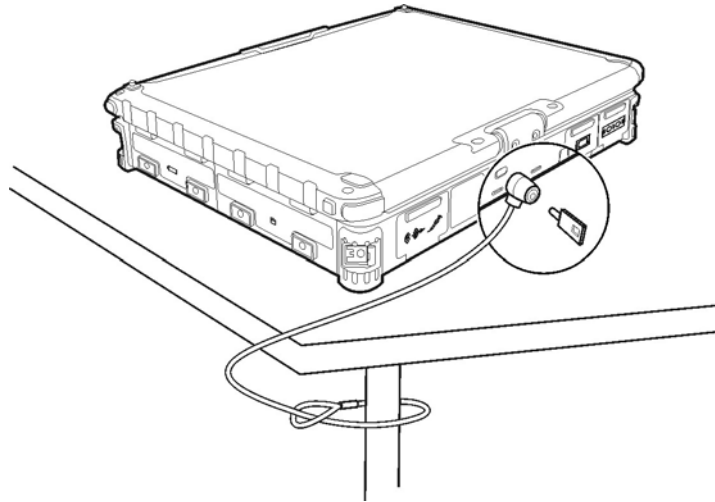

# Taking Care of the Computer

## Location Guidelines

- For optimal performance, use the computer where the recommended temperature is between 0°C (32°F) and 55°C (131°F) – actual operating temperature depending on product specifications.
- Avoid placing the computer in a location subject to high humidity, extreme temperatures, mechanical vibration, direct sunlight, or heavy dust.
- Do not cover or block any ventilation openings on the computer. For example, do not place the computer on a bed, sofa, rug, or other similar surface. Otherwise, overheating may occur that results in damage to the computer.
- Keep the computer at least 13 cm (5 inches) away from electrical appliances that can generate a strong magnetic field such as a TV, refrigerator, motor, or a large audio speaker.
- Avoid moving the computer abruptly from a cold to a warm place. A temperature difference of more than 10°C (18°F) may cause condensation inside the unit, which may damage the storage media.
- Do not place the computer on an unsteady surface.

## General Guidelines

- Do not place heavy objects on top of the computer when it is closed as this may damage the display.
- The screen surface is easily scratched. Do not use paper towels to clean the display but use the included soft cloth. Avoid touching it with your fingers, pen, or pencil.
- To maximize the life of the backlight in the display, allow the backlight to automatically turn off as a result of power management. Avoid

using a screen saver or other software that prevents the power management from working.

## Cleaning Guidelines

- Never clean the computer with its power on.
- Use a soft cloth moistened with water or a non-alkaline detergent to wipe the exterior of the computer.
- Gently wipe the display with a soft, lint-free cloth. Do not use alcohol or detergent on the display.
- Dust or grease on the touchpad can affect its sensitivity. Clean the pad by using adhesive tape to remove the dust and grease on its surface.

## Battery Pack Guidelines

- Recharge the battery pack when it is nearly discharged. When recharging, make sure that the battery pack is fully charged. Doing so may avoid harm to the battery pack.
- The battery pack is a consumable product and the following conditions will shorten its life:
  - when frequently charging the battery pack
  - when using, charging, or storing the battery in high temperature condition
- To avoid hastening the deterioration of the battery pack thereby prolonging its useful life, minimize the number of times you charge it so as not to frequently increase its internal temperature.
- Charge the battery pack between 10°C ~ 30°C (50°F ~ 86°F) temperature range.  
A higher environment temperature will cause the battery pack's temperature to rise. Avoid charging the battery pack inside a closed vehicle and in hot weather condition.

Also, charging will not start if the battery pack is not within the allowed temperature range.

- It is recommended that you do not charge the battery pack more than once a day.
- It is recommended that you charge the battery pack with the computer's power off.
- To maintain the battery pack's operating efficiency, store it in a cool dark place removed from the computer and with 30% - 40% charge remaining.
- Important guidelines when using the battery pack.

When installing or removing the battery pack take note of the following:

- avoid installing or removing the battery pack when the computer is in Sleep mode. Abruptly removing the battery pack may cause loss of data or the computer may become unstable.
- avoid touching the battery pack terminals or damage may occur, thereby causing improper operation to it or the computer.

The computer's input voltage and surrounding temperature will directly affect the battery pack's charge and discharge time:

- charging time will be prolonged when the computer is turned on. To shorten the charging time, it is recommended that you place the computer in sleep or hibernation mode.
- a low temperature will prolong the charging time as well as hasten the discharge time.

## Touchscreen Guidelines

- Use the finger or the included touchscreen pen on the display. Using a sharp or metallic object other than your finger or touchscreen pen may cause scratches and damage the display, thereby causing errors.
- Avoid using excessive force that may cause damage to the display.



- Use a soft cloth to remove dirt on the display. The touchscreen surface has a special protective coating that prevents dirt from sticking to it. Not using a soft cloth may cause damage to the special protective coating on the touchscreen surface.  
To remove hard to remove dirt, blow some steam on the particular area and gently wipe away using a soft cloth.
- Turn off the computer power when cleaning the display. Cleaning the display with the power on may cause improper operation.
- Use the touchscreen within the intended area only. The display area and touchscreen operating area is the same. Using it beyond the allowed area may cause damage to the display and result in improper operation.
- Do not use excessive force on the display. Avoid moving the computer while holding the display or twisting the display. Avoid placing objects on top of the display as this may cause the glass to break thereby damaging the display.
- Using the touchscreen during low temperature (less than 5°C) may cause a slower response time, this is normal. A normal response time may be restored upon returning to room temperature.
- When there is noticeable discrepancy in the operation of the touchscreen function (wrong location on intended operation or improper display resolution), calibrate the touchscreen using the calibration utility called **IdeaCom Calibration** on Windows XP/Vista or **CalTouch** on Windows 7.

# When Traveling

- Before traveling with your computer, make a backup of your hard disk data into flash disks or other storage devices. As an added precaution, bring along an extra copy of your important data.
- Make sure that the battery pack is fully charged.
- Make sure that the computer is turned off and the top cover is securely closed.
- Do not leave objects in between the keyboard and closed display.
- Disconnect the AC adapter from the computer and take it with you. Use the AC adapter as the power source and as a battery-charger.
- Hand-carry the computer. Do not check it in as luggage.
- If you need to leave the computer in the car, put it in the trunk of the car to avoid exposing the computer to excessive heat.
- When going through airport security, it is recommended that you send the computer and flash disks through the X-ray machine (the device you set your bags on). Avoid the magnetic detector (the device you walk through) or the magnetic wand (the handheld device used by security personnel).
- If you plan to travel abroad with your computer, consult your dealer for the appropriate AC power cord for use in your country of destination.

## Chapter 9

# Troubleshooting

Computer problems can be caused by hardware, software, or both. When you encounter any problem, it might be a typical problem that can easily be solved.

This chapter tells you what actions to take when solving common computer problems.



# Preliminary Checklist

Here are helpful hints to follow before you take further actions when you encounter any problem:

- Try to isolate which part of the computer is causing the problem.
- Make sure that you turn on all peripheral devices before turning on the computer.
- If an external device has a problem, make sure that the cable connections are correct and secure.
- Make sure that the configuration information is properly set in the BIOS Setup program.
- Make sure that all the device drivers are correctly installed.
- Make notes of your observations. Are there any messages on the screen? Do any indicators light? Do you hear any beeps? Detailed descriptions are useful to the service personnel when you need to consult one for assistance.

If any problem persists after you follow the instructions in this chapter, contact an authorized dealer for help.

# Solving Common Problems

## Battery Problems

### **The battery does not charge (Battery Charge indicator does not light yellow).**

- Make sure that the AC adapter is properly connected.
- Make sure that the battery is not too hot or cold. Allow time for the battery pack to return to room temperature.
- Make sure that the battery pack is installed correctly.
- Make sure that the battery terminals are clean.

### **The operating time of a fully charged battery becomes shorter.**

- If you often partially recharge and discharge, the battery might not be charged to its full potential. Initialize the battery to solve the problem.

### **The battery operating time indicated by the battery meter does not match the actual operating time.**

- The actual operating time can be different from the estimated time, depending on how you are using the computer. If the actual operating time is much less than the estimated time, initialize the battery.

## Bluetooth Problems

### **I cannot connect to another Bluetooth-enabled device.**

- Make sure that the Bluetooth card is correctly installed.
- Make sure that the Bluetooth driver is correctly installed.
- Make sure that both devices have activated Bluetooth.

- Make sure that the distance between the two devices are not over 10 meters or that there are no walls or other obstructions between the devices.
- Make sure that the other device is not in “Hidden” mode.
- Make sure that both devices are compatible.

## Display Problems

### **Nothing appears on the screen.**

- During operation, the screen may automatically turn off as a result of power management. Press any key to see if the screen comes back.
- The brightness level might be too low. Increase brightness by pressing the **Fn+F6** hot key.
- The display output might be set to an external device. To switch the display back to the LCD, press the **Fn+F9** hot key or change the display through the settings in **Display** Properties.

### **The characters on the screen are dim.**

- Adjust the brightness and/or contrast.

### **Bad dots appear on the display at all times.**

- A small number of missing, discolored, or bright dots on the screen are an intrinsic characteristic of TFT LCD technology. It is not regarded as a LCD defect.

### **Resolution cannot be adjusted to desired setting.**

- Make sure that the VGA driver is installed correctly.

### **The external monitor displays nothing.**

- Make sure that the monitor is turned on.
- Make sure that the monitor’s signal cable is properly connected.

- Switch the display to the monitor by pressing the **Fn+F9** hot key or change the display through the settings in **Display** Properties.

**Simultaneous display/multi-display does not work.**

- Make sure that you turn on the external monitor before turning on the computer.
- Press the **Fn+F9** hot key to toggle through the display options or change the settings in **Display** Properties in Windows.

## Hardware Device Problems

**The computer does not recognize a newly installed device.**

- The device may not be correctly configured in the BIOS Setup program. Run the BIOS Setup program to identify the new type.
- Make sure if any device driver needs to be installed. (Refer to the documentation that came with the device.)
- Make sure if the device needs any jumper or switch settings. (Refer to the documentation that came with the device.)
- Check the cables or power cords for correct connections.
- For an external device that has its own power switch, make sure that the power is turned on.

## Hard Disk Drive Problems

**The hard disk drive error message appears on the screen.**

- The hard disk drive has defects. Ask your dealer for help.

**The hard disk drive operations seem slow.**

- The data files stored on the hard disk drive may be fragmented. Use a tool such as Windows's **Disk Defragmenter** to defragment the files.

**The hard disk drive in-use indicator glows without blinking.**

- The data files stored on the hard disk drive may be fragmented. Use a tool such as Window's **Disk Defragmenter** to defragment the files.

## Keyboard, Mouse, and Touchpad Problems

### The keyboard does not respond.

- Try connecting an external keyboard. If it works, contact an authorized dealer, as the internal keyboard cable might be loose.

### The numeric keypad is disabled.

- Make sure that the **Num Lock** is switched on. (Check if the Num Lock Indicator  glows or not.)

### The external keyboard does not work.

- Make sure that the keyboard cable is properly connected.

### The USB mouse does not work.

- Make sure that the mouse cable is properly connected.

### The touchpad does not work, or the pointer is difficult to control with the touchpad.

- Make sure that the touchpad is clean.

## LAN Problems

### I cannot access the network.

- Make sure that the LAN driver is correctly installed.
- Make sure that the LAN cable is properly connected to the RJ-45 connector and the network hub.
- Make sure that the network configuration is appropriate.
- Make sure that the user name or password is correct.



## Modem Problems

### **The modem does not work.**

- Make sure that the modem driver is correctly installed.
- Make sure that the telephone line is properly connected.
- Make sure that the COM port in the communication software is correctly set.
- Turn off power management.

## PC Card Problems

### **The PC card does not work.**

- Make sure that the PC card controller driver is correctly installed.
- Make sure that the PC card is correctly seated.
- If the card requires an IRQ (Interrupt ReQuest), make sure that there is one available.

### **The PC card stops communicating properly.**

- The application may have been reset when the computer is turned off or in Standby mode. Exit and restart the application.

## Power Management Problems

### **The computer does not enter Standby or Hibernation mode automatically.**

- If you have a connection to another computer, the computer does not enter Standby or Hibernation mode if the connection is actively in use.
- Make sure that the Standby or Hibernation time-out is enabled.

### **The computer does not enter Standby or Hibernation mode immediately.**

- If the computer is performing an operation, it normally waits for the operation to finish.

**The computer does not resume from Standby or Hibernation mode.**

- The computer automatically enters Standby or Hibernation mode when the battery pack is empty. Do any one of the following:
  - Connect the AC adapter to the computer.
  - Replace the empty battery pack with a fully charged one.

**The computer does not enter Hibernation mode with the Fn+F10 hot keys.**

- Make sure that the Hibernation function is specified for the sleep button.
- You might be using a PC card that prevents the computer from entering Hibernation mode. To enter the mode, stop the communication program and then remove the card or stop the card.

## Software Problems

**An application program does not work correctly.**

- Make sure that the software is correctly installed.
- If an error message appears on the screen, consult the software program's documentation for further information.
- If you are sure the operation has stop, reset the computer. (See "Resetting the Computer" later in this chapter.)

## Sound Problems

**No sound is produced.**

- Make sure that the volume control is not set too low.
- Make sure that the audio driver is correctly installed.
- Make sure that the computer is not in Standby mode.

- If using an external speaker, make sure that the speaker is properly connected.

**Distorted sound is produced.**

- Make sure that the volume control is not set too high or too low. In most cases, a high setting can cause the audio electronics to distort the sound.

**The sound system does not record.**

- Adjust the playback or recording sound levels.

**The external microphone or audio device does not work.**

- Make sure that the microphone is connected to the proper connector on the computer.
- Make sure that your computer is equipped with the driver needed.
- Click the speaker symbol on the taskbar and check the Windows volume control.
- Check the volume control of your computer.

## Startup Problems

**When you turn on the computer, it does not respond and the Power Indicator does not light green.**

- If you are using an external AC power, make sure that the AC adapter is correctly and securely connected. If so, make sure that the electrical outlet works properly.
- If you are using the battery power, make sure that the battery is not discharged.

**When you turn on the computer, it stops after POST.**

- Restart your computer.

# WLAN Problems

## **I cannot use the WLAN feature.**

- Make sure that the mini PCI-E WLAN card is correctly installed.
- Make sure that the necessary driver(s) is correctly installed.
- Make sure that the WLAN feature is turned on.

## **Transmission quality is poor.**

- Your computer may be in an out-of-range situation. Move your computer closer to the Access Point or another WLAN device it is associated with.
- Check if there is high interference around the environment and solve the problem as described next.

## **Radio interference exists.**

- Move your computer away from the device causing the radio interference such as microwave oven and large metal objects.
- Plug your computer into an outlet on a different branch circuit from that used by the affecting device.
- Consult your dealer or an experienced radio technician for help.

## **I cannot connect to another WLAN device.**

- Make sure that the WLAN feature is turned on.
- Make sure that the SSID setting is the same for every WLAN device in the network.
- Your computer is not recognizing changes. Restart the computer.
- Make sure that the IP address or subnet mask setting is correct.

## **I cannot communicate with the computer in the network when Infrastructure mode is configured.**

- Make sure that the Access Point your computer is associated with is powered on and all the LEDs are working properly.
- If the operating radio channel is in poor quality, change the Access Point and all the wireless station(s) within the BSSID to another radio channel.
- Your computer may be in an out-of-range situation. Move your computer closer to the Access Point it is associated with.
- Make sure that your computer is configured with the same security option (encryption) to the Access Point.
- Use the Web Manager/Telnet of the Access Point to check whether it is connected to the network.
- Reconfigure and reset the Access Point.

#### **I cannot access the network.**

- Make sure that the necessary driver(s) is correctly installed.
- Make sure that the network configuration is appropriate.
- Make sure that the user name or password is correct.
- You have moved out of range of the network.
- Turn off power management.

## **Other Problems**

#### **The date/time is incorrect.**

- Correct the date and time via the operating system or BIOS Setup program.
- After you have performed everything as described above and still have the incorrect date and time every time you turn on the computer, the RTC (Real-Time Clock) battery is at the end of its life. Call an authorized dealer to replace the RTC battery.

# Resetting the Computer

You may have to reset (reboot) your computer on some occasions when an error occurs and the program you are using hangs up.

If the computer operation seems to hang up, first wait. It is possible that the computer is processing data. Periodically check the hard disk drive in-use indicator, if it flashes irregularly, the program may be accessing data and preventing you from using the keyboard. If you are sure the operation has stopped and you cannot use the “restart” function of the operating system, reset the computer.

Reset the computer by any one of these methods:

- Press **Ctrl+Alt+Del** on your built-in keyboard.
- Press the Reset button  on the front panel of your computer.
- If the above action does not work, turn off the computer with the power button. Wait for at least five seconds and turn it on again.

**CAUTION:** Resetting will cause any unsaved data to be lost.

# Appendix A

## Specifications

**NOTE:** Specifications are subject to change without any prior notice.

| Parts   |                  | Specifications                                                                                                                                                                                                                                                                                                       |
|---------|------------------|----------------------------------------------------------------------------------------------------------------------------------------------------------------------------------------------------------------------------------------------------------------------------------------------------------------------|
| CPU     | Processor        | Intel® i7-640UM, 1.2GHz, Max. 2.266 GHz with Intel Turbo Boost Technology, Thermal 18W<br>or<br>Intel® i5-540UM, 1.2GHz, Max. 2.00 GHz with Intel Turbo Boost Technology, Thermal 18W                                                                                                                                |
|         | Cache            | i7-640UM, 512K L2, 4MB L3<br>or<br>i5-540UM, 512K L2, 3MB L3                                                                                                                                                                                                                                                         |
| Memory  | RAM (system)     | Up to 8 GB, 240-pin × 2, DDR3 SO-DIMM                                                                                                                                                                                                                                                                                |
| Chipset |                  | Intel® QM57                                                                                                                                                                                                                                                                                                          |
| BIOS    |                  | 8 MB EEPROM, system and VGA BIOS, G-sensor support, Plug-and-Play, ACPI 2.0 capability, boot from SATA/LAN/USB devices (e.g., DVD Combo / DVD Dual / Flash / floppy drives), light sensor for LCD panel and keyboard backlight brightness control support, computrace                                                |
| Display | Panel            | 12.1-inch TFT LCD, resolution up to 1280×800 WXGA<br>Touchscreen function and/or Active Digitizer feature (option) (with pen holder)<br>Sunlight-readable (option), brightness > 1200 nits after touchscreen or glass<br>Night vision (option), brightness < 1.7 nits after touchscreen or glass, meets MIL-STD-3009 |
|         | Video controller | Integrated in Intel® GMA HD, DirectX® 10 support, dual view, LCD/CRT simultaneous display capability, ECO mode support                                                                                                                                                                                               |
|         | Video memory     | BIOS selectable, 128MB/256MB (default)/Max DVMT (OS dynamic auto-adjust)                                                                                                                                                                                                                                             |
|         | Video out        | VGA<br>Replaced with serial port (RS-232 or RS-422) – option                                                                                                                                                                                                                                                         |

| Parts                 |                             | Specifications                                                                                                                                                                                         |
|-----------------------|-----------------------------|--------------------------------------------------------------------------------------------------------------------------------------------------------------------------------------------------------|
| Audio                 | Features                    | Azalia interface, left/right-channel analog output for line-out connector                                                                                                                              |
|                       | Speaker                     | One built-in                                                                                                                                                                                           |
|                       | Ports                       | Two audio ports for Line-out (green) / Mic-in (red)                                                                                                                                                    |
| Keyboard              |                             | Standard keys with numeric pad keys, 12 function keys, special <b>Fn</b> (Function) key and Windows keys<br>Water-proof and dust-proof membrane, large character printing, water-proof rubber (option) |
| Pointing device       |                             | Glide touchpad with 2 buttons, capacitance-type                                                                                                                                                        |
| Hard disk drive       |                             | SATA interface, 5400 rpm support, 9.5 mm height 2.5-inch diameter<br>HDD heater for low temperature -20°C, solid state disk (option)                                                                   |
| PCMCIA                |                             | Type II × 1 and ExpressCard/54/32<br>Type II × 1 and Smart Card Reader (option)                                                                                                                        |
| Card Reader (option)  |                             | Secure Digital (SD), SDHC-support                                                                                                                                                                      |
| I/O ports             |                             | USB port (USB 2.0 support), eSATA/USB combo port (SATA II support), serial port (RS-232), RJ-45 port, RJ-11 port                                                                                       |
| Antenna               | Wi-Fi 802.11a/b/g/n         | 2 internal (pass-through for external antenna – option)<br>Triple band support 2.3~2.7, 3.3~3.8, 5.1~5.8 GHz                                                                                           |
|                       | WCDMA/HSDPA 2100 MHz (3.5G) | 2 internal (pass-through for external antenna – option)<br>cannot co-exist with Wimax                                                                                                                  |
|                       | Bluetooth 2.4G              | 1 internal                                                                                                                                                                                             |
|                       | GPS 1.5G                    | 1 internal                                                                                                                                                                                             |
| Modem                 |                             | Azalia interface, 56 Kbps, ITU V.90 MDC 1.5 internal fax modem                                                                                                                                         |
| LAN                   |                             | IEEE 802.3i 10Base-T / IEEE 802.3u 100Base-T /<br>IEEE 802.3ab 1000Base-T Ethernet                                                                                                                     |
| Wireless LAN (option) |                             | Intel® Centrino Advanced-N6200 AGN                                                                                                                                                                     |
| Bluetooth (option)    |                             | Specification 2.1 module plus EDR                                                                                                                                                                      |
| Camera                |                             | 2.0 M pixel                                                                                                                                                                                            |
| GPS                   |                             | RS232 interface                                                                                                                                                                                        |
| 3G                    |                             | EDGE/HSDPA/HSUPA/EVDO multi-band, with internal SIM slot (mini-card)                                                                                                                                   |
| Security              |                             | Kensington lock<br>TPM 1.2<br>Smart Card Reader (integrated) will occupy one Type II PCMCIA slot (option)<br>Fingerprint scanner (option)                                                              |



| Parts                  |             | Specifications                                                                                                                                                                            |
|------------------------|-------------|-------------------------------------------------------------------------------------------------------------------------------------------------------------------------------------------|
| Docking                |             | 100-pin, engage with vehicle docking                                                                                                                                                      |
| Handle                 |             | Grip and cross-type hand strap                                                                                                                                                            |
| Power                  | AC adapter  | Universal 60 W; input: 100~240 V, 50/60 Hz; output: 19 V                                                                                                                                  |
|                        | Battery     | Li-ion smart 6-cell battery 5200 mAh / 11.1 V (option)<br>Li-ion smart 9-cell battery 7800 mAh / 11.1 V<br>user-swappable, under -20 °C combined with hard drive low temperature solution |
| Accessories (option)   |             | Stylus for touchscreen, active digitizer pen, vehicle docking (need to combine with docking connector)                                                                                    |
| Dimension (L×W×H)      |             | 289.68×227.77×59.4 mm (11.4×8.97×2.3 inch)                                                                                                                                                |
| Weight                 |             | Less than 2.5 kg (5.5 lb)                                                                                                                                                                 |
| Environment            | Temperature | Operating: 0 °C (32 °F) to 60 °C (140 °F)<br>-20 °C (4 °F) to 60 °C (140 °F) – low temperature option<br>Non-operating: -40 °C (-40 °F) to 70 °C (158 °F)                                 |
|                        | Humidity    | 5 % to 95 % relative, non-condensing                                                                                                                                                      |
|                        | Altitude    | Operating: 15,000 ft<br>Non-operating: 40,000 ft                                                                                                                                          |
|                        | Shock       | Operating: 15 g, 11 ms half-sine wave<br>Non-operating: 50 g, 11 ms half-sine wave                                                                                                        |
|                        | Vibration   | Random vibration:<br>Operating: MIL-STD-810F, 514.5C-1 – highway truck exposure<br>Non-operating: MIL-STD-810F, 514.5C-17                                                                 |
|                        | Drop        | 100 cm drop 26 times onto plywood plate surface                                                                                                                                           |
|                        | Enclosure   | IP65 (with input/output doors closed)                                                                                                                                                     |
|                        | ESD         | Air discharge: 0-8 KV (included) no error; 9-15 KV allow soft error<br>Contact discharge: 0-6 KV (included) no error; 7-8 KV allow soft error                                             |
| Regulation             | EMC         | FCC part 15, subpart B, class B, CE, CCC, BSMI                                                                                                                                            |
|                        | Safety      | UL, UL1604, TUV, TUV/CB, E-mark                                                                                                                                                           |
| Green Product Coverage | RoHS        | 6 European union banned materials, EPEAT silver                                                                                                                                           |
|                        | Other       | 12 universal GP product banned materials, ENERGY STAR, WEEE                                                                                                                               |



## Appendix B

# Regulatory Information

This appendix provides regulatory statements and safety notices on your computer.

**NOTE:** Marking labels located on the exterior of your computer indicate the regulations that your model complies with. Please check the marking labels and refer to the corresponding statements in this appendix. Some notices apply to specific models only.

# On the Use of the System

## Class B Regulations

### USA

#### Federal Communications Commission Radio Frequency Interference Statement

##### NOTE:

This equipment has been tested and found to comply with the limits for a Class B digital device pursuant to Part 15 of the FCC Rules. These limits are designed to provide reasonable protection against harmful interference in a residential installation. This equipment generates, uses, and can radiate radio frequency energy and, if not installed and used in accordance with the instructions, may cause harmful interference to radio communications. However, there is no guarantee that interference will not occur in a particular installation. If this equipment does cause harmful interference to radio or television reception, which can be determined by turning the equipment off and on, the user is encouraged to try to correct the interference by one or more of the following measures:

- Reorient or relocate the receiving antenna.
- Increase the separation between the equipment and receiver.
- Connect the equipment into an outlet on a circuit different from that to which the receiver is connected.
- Consult the dealer or an experienced radio/TV technician for help.

Any changes or modifications not expressly approved by the manufacturer could void the user's authority to operate the equipment.

##### **Please note:**

The use of a non-shielded interface cable with this equipment is prohibited.

## Canada

### Canadian Department of Communications Radio Interference Regulations Class B Compliance Notice

This Class B digital apparatus meets all requirements of the Canada Interference-Causing equipment regulations.

Cet appareil numérique de Classe B respecte toutes les exigences du Règlement Canadien sur le matériel brouilleur.

This digital apparatus does not exceed the Class B limits for radio noise emissions from digital apparatus set out in the Radio Interference Regulations of the Canadian Department of Communications.

Le présent appareil numérique n'émet pas de bruits radioélectriques dépassant les limites applicables aux appareils numériques de la classe B prescrites dans le Règlement sur le brouillage radioélectrique édicté par le ministère des Communications du Canada.

## UL1604 Installation Instructions

- This equipment is suitable for use in Class I, Division 2, Groups A, B, C and D OR non-hazardous locations only.
- WARNING – EXPLOSION HAZARD – Do not disconnect equipment unless power has been removed or the area is known to be non-hazardous.
- WARNING – EXPLOSION HAZARD - Substitution of components may impair suitability for Class I, Division 2.
- Non-LPS or TNV output connectors identify the type of circuit, intended cable type or relevant circuit characteristics.
- "IMPORTANT SAFETY INSTRUCTIONS - When using your telephone equipment, basic safety precautions should always be followed to reduce the risk of fire, electric shock and injury to persons, including the following:
  - Do not use this product near water for example, near a bathtub, washbowl, kitchen sink or laundry tub, in a wet basement or near a

- swimming pool.
  - Avoid using a telephone (other than a cordless type) during an electrical storm. There may be a remote risk of electric shock from lightning.
  - Do not use the telephone to report a gas leak in the vicinity of the leak.
- Use only the power cord and batteries indicated in this manual. Do not dispose of batteries in a fire. They may explode. Check with local codes for possible special disposal instructions.

“SAVE THESE INSTRUCTIONS”

## Safety Notices

### About the Battery

#### Caution Texts Concerning Lithium Batteries

##### DANISH

ADVARSEL! Lithiumbatteri – Eksplosionsfare ved fejlagtig håndtering. Udskiftning må kun ske med batteri af samme fabrikat og type. Levér det brugte batteri tilbage til leverandøren.

##### NORWEGIAN

ADVARSEL: Eksplosjonsfare ved feilaktig skifte av batteri. Benytt samme batteritype eller en tilsvarende type anbefalt av apparatfabrikanten. Brukte batterier kasseres i henhold til fabrikantens instruksjoner.

##### SWEDISH

VARNING: Explosionsfara vid felaktigt batteribyte. Använd samma batterityp eller en ekvivalent typ som rekommenderas av apparattillverkaren. Kassera använt batteri enligt fabrikantens instruktion.

##### FINNISH

VAROITUS: Paristo voi räjähtää, jos se on virheellisesti asennettu. Vaihda paristo ainoastaan valmistajan suosittelemaan tyyppiin. Hävitä käytetty paristo valmistajan ohjeiden mukaisesti.

**ENGLISH**

CAUTION: Danger of explosion if battery is incorrectly replaced. Replace only with the same or equivalent type recommended by the equipment manufacturer. Discard used batteries according to manufacturer's instructions.

**DEUTSCH**

VORSICHT: Explosionsgefahr bei unsachgemäßem Austausch der Batterie. Ersatz nur durch denselben oder einen vom Hersteller empfohlenen gleichwertigen Typ. Entsorgung gebrauchter Batterien nach Angaben des Herstellers.

**FRENCH**

ATTENTION: Il y a danger d'explosion s'il y a remplacement incorrect de la batterie. Remplacer uniquement avec une batterie du même type ou d'un type équivalent recommandé par le constructeur. Mettre au rebut les batteries usagées conformément aux instructions du fabricant.

**Attention (for USA Users)**

The product that you have purchased contains a rechargeable battery. The battery is recyclable. At the end of its useful life, under various state and local laws, it may be illegal to dispose of this battery into the municipal waste stream. Check with your local solid waste officials for details in your area for recycling options or proper disposal.

**About the AC Adapter**

- Use only the AC adapter supplied with your computer. Use of another type of AC adapter will result in malfunction and/or danger.
- Do not use the adapter in a high moisture environment. Never touch the adapter when your hands or feet are wet.
- Allow adequate ventilation around the adapter when using it to operate the device or charge the battery. Do not cover the AC adapter with paper or other objects that will reduce cooling. Do not use the AC adapter while it is inside a carrying case.
- Connect the adapter to a proper power source. The voltage requirements are found on the product case and/or packaging.

- Do not use the adapter if the cord becomes damaged.
- Do not attempt to service the unit. There are no serviceable parts inside. Replace the unit if it is damaged or exposed to excess moisture.

## **About the Modem**

### **Caution**

- Never install telephone wiring during a lightning storm.
- Never install telephone jacks in wet locations unless the jack is specifically designed for wet locations.
- Never touch non-insulated telephone wires or terminals unless the telephone line has been disconnected at the network interface.
- Use caution when installing or modifying telephone lines.
- Avoid using the telephone function (other than a cordless type) during an electrical storm. There may be a remote risk of electric shock from lightning.
- Do not use the telephone function to report a gas leak in the vicinity of the leak.
- Do not use this product near water, for example near a bathtub, wash bowl, kitchen sink or laundry tub, in a wet basement or near a swimming pool.

### **Caution (for USA Users)**

To reduce the risk of fire, use only No.26 AWG or larger telecommunication line cord.



# On the Use of the RF Device

**NOTE:** The information in this section applies to models with the wireless LAN module.

## USA and Canada Safety Requirements and Notices

### Radio Frequency Interference Requirements and SAR

The FCC with its action in ET Docket 93-62 has adopted a safety standard for human exposure to Radio Frequency (RF) electromagnetic energy emitted by FCC certified equipment. The wireless LAN module meets the Human Exposure limits found in OET Bulletin 65, 2001, and ANSI/IEEE C95.1, 1992. Proper operation of this radio according to the instructions found in this manual will result in exposure substantially below the FCC's recommended limits. The following safety precautions should be observed:

- Do not touch or move antenna while the unit is transmitting or receiving.
- Do not hold any component containing the radio such that the antenna is very close or touching any exposed parts of the body, especially the face or eyes, while transmitting.
- Do not operate the radio or attempt to transmit data unless the antenna is connected; if not, the radio may be damaged.

### Use in specific environments:

- The use of wireless devices in hazardous locations is limited by the constraints posed by the safety directors of such environments.
- The use of wireless devices on airplanes is governed by the Federal Aviation Administration (FAA).
- The use of wireless devices in hospitals is restricted to the limits set forth by each hospital.

- High-gain, wall-mount, or mast-mount antennas are designed to be professionally installed and should be located at a minimum distance of 30 cm (12 inches) or more from the body of all persons. Please contact your professional installer, VAR, or antenna manufacturer for proper installation requirements.

### **Explosive Device Proximity Warning**

**WARNING:** Do not operate a portable transmitter (such as a wireless network device) near unshielded blasting caps or in an explosive environment unless the device has been modified to be qualified for such use.

### **Use on Aircraft Caution**

**CAUTION:** Regulations of the FCC and FAA prohibit airborne operation of radio-frequency wireless devices because their signals could interfere with critical aircraft instruments.

### **EMC Requirements**

This device uses, generates and radiates radio frequency energy. The radio frequency energy produced by this device is well below the maximum exposure allowed by the Federal Communications Commission (FCC).

This device complies with the limits for a Class B digital device pursuant to Part 15 subpart C of the FCC Rules and Regulations. Operation is subject to the following two conditions:

- (1) This device may not cause harmful interference.
- (2) This device must accept any interference received, including interference that may cause undesired operation.

The FCC limits are designed to provide reasonable protection against harmful interference when the equipment is installed and used in accordance with the instruction manual and operated in a commercial environment. However, there is no guarantee that interference will not occur in a particular commercial installation, or if operated in a residential area.

If harmful interference with radio or television reception occurs when the device is turned on, the user must correct the situation at the user's own

expense. The user is encouraged to try one or more of the following corrective measures:

- Reorient or relocate the receiving antenna.
- Increase the separation between the equipment and receiver.
- Connect the equipment into an outlet on a circuit different from that to which the receiver is connected.
- Consult the dealer or an experienced radio/TV technician for help.

**CAUTION:** The Part 15 radio device operates on a non-interference basis with other devices operating at this frequency. Any changes or modification to said product not expressly approved by the manufacturer could void the user's authority to operate this device.

## **Canada Radio Frequency Interference Requirements**

To prevent radio interference to the licensed service, this device is intended to be operated indoors and away from windows to provide maximum shielding. Equipment (or its transmit antenna) that is installed outdoors is subject to licensing.

Pour empêcher que cet appareil cause du brouillage au service faisant l'objet d'une licence, il doit être utilisé à l'intérieur et devrait être placé loin des fenêtres afin de fournir un écran de blindage maximal. Si le matériel (ou son antenne d'émission) est installé à l'extérieur, il doit faire l'objet d'une licence.

## **European Union CE Marking and Compliance Notices**

### **Statements of Compliance**

#### **English**

This product follows the provisions of the European Directive 1999/5/EC.

**Danish**

Dette produkt er i overensstemmelse med det europæiske direktiv 1999/5/EC.

**Dutch**

Dit product is in navolging van de bepalingen van Europees Directief 1999/5/EC.

**Finnish**

Tämä tuote noudattaa EU-direktiivin 1999/5/EC määräyksiä.

**French**

Ce produit est conforme aux exigences de la Directive Européenne 1999/5/EC.

**German**

Dieses Produkt entspricht den Bestimmungen der Europäischen Richtlinie 1999/5/EC.

**Greek**

Το προϊόν αυτό πληροί τις προβλέψεις της Ευρωπαϊκής Οδηγίας 1999/5/EC.

**Icelandic**

Þessi vara stent reglugerð Evrópska Efnahags Bandalagsins númer 1999/5/EC.

**Italian**

Questo prodotto è conforme alla Direttiva Europea 1999/5/EC.

**Norwegian**

Dette produktet er i henhold til bestemmelsene i det europeiske direktivet 1999/5/EC.

**Portuguese**

Este produto cumpre com as normas da Diretiva Europeia 1999/5/EC.

**Spanish**

Este producto cumple con las normas del Directivo Europeo 1999/5/EC.

**Swedish**

Denna produkt har tillverkats i enlighet med EG-direktiv 1999/5/EC.

## Local Restrictions of 802.11a/g/n Radio Usage

**CAUTION:** Due to the fact that the frequencies used by 802.11a/g/n wireless LAN devices may not yet be harmonized in all countries, 802.11a/g/n products are designed for use only in specific countries or regions, and is not allowed to be operated in countries or regions other than those of designated use. As a user of these products, you are responsible for ensuring that the products are used only in the countries or regions for which they were intended and for verifying that they are configured with the correct selection of frequency and channel for the country or region of use. Any deviation from permissible settings and restrictions in the country or region of use could be an infringement of local law and may be punished as such.

The European variant is intended for use throughout the European Economic Area. However, authorization for use is further restricted in particular countries or regions within countries, as follows:

### General

European standards dictate maximum radiated transmit power of 100 mW Effective Isotropic Radiated Power (EIRP) and the frequency range 2400 – 2483.5 MHz.

### Belgium and the Netherlands

In Belgium and the Netherlands, the product may not be used outdoors. See the instructions next under the heading "Turning Off the Wireless LAN Radio."

### France

#### Departments in Which the Wireless LAN Module Can Be Used (Indoors Only)

The wireless LAN module can currently be used indoors only in the following 38 departments of mainland France. Please turn off your wireless LAN radio when operating the device in areas/places other than the 38 departments listed:

|    |                |    |                |    |          |
|----|----------------|----|----------------|----|----------|
| 01 | Ain Orientales | 36 | Indre          | 66 | Pyrénées |
| 02 | Aisne          | 37 | Indre et Loire | 67 | Bas Rhin |

|    |              |    |                        |    |                       |
|----|--------------|----|------------------------|----|-----------------------|
| 03 | Allier       | 41 | Loir et Cher           | 68 | Haut Rhin             |
| 05 | Hautes Alpes | 42 | Loire                  | 70 | Haute Saône           |
| 08 | Ardennes     | 45 | Loiret                 | 71 | Saône et Loire        |
| 09 | Ariège       | 50 | Manche                 | 75 | Paris                 |
| 11 | Aude         | 55 | Meuse                  | 82 | Tarn et Garonne       |
| 12 | Aveyron      | 58 | Nièvre                 | 84 | Vaucluse              |
| 16 | Charente     | 59 | Nord                   | 88 | Vosges                |
| 24 | Dordogne     | 60 | Oise                   | 89 | Yonne                 |
| 25 | Doubs        | 61 | Orne                   | 90 | Territoire de Belfort |
| 26 | Drôme        | 63 | Puy du Dôme            | 94 | Val de Marne          |
| 32 | Gers         | 64 | Pyrénées<br>Atlantique |    |                       |

Departments in Which the Wireless LAN Module's Maximum EIRP Not Shown in the Previous Table

| Frequency Ranges (MHz) | Indoors | Outdoors                                                     |
|------------------------|---------|--------------------------------------------------------------|
| 2400 – 2446.5          | 10 mW   | Not permitted                                                |
| 2446.5 – 2483.5        | 100 mW  | 100 mW on private property with Ministry of Defense approval |

## Turning Off the Wireless LAN Radio

**NOTE:** Turning the wireless LAN radio off is not the same as disabling the wireless LAN card. It is not necessary to disable the card to meet the regulatory requirements.

While operating the computer in those French departments that do not allow use of the wireless LAN equipment, the user of the equipment must turn off the wireless LAN radio in order to comply with local regulations (see "Turning Off/On the WLAN Radio" in Chapter 2 for more information).