



FCC 47 CFR PART 15 SUBPART E

TEST REPORT

For

NOTEBOOK COMPUTER

Model: V100

Trade Name: Getac

Issued to

Getac Technology Corp.

**No.1,R&D Road 2 , Hsinchu Science Based Industrial Park ,
Hsinchu , Taiwan**

Issued by

Compliance Certification Services Inc.

**No. 81-1, Lane 210, Pa-De 2nd Rd., Luchu Hsiang,
Taoyuan Shien, (338), Taiwan, R.O.C.**

<http://www.ccsrf.com>

service@ccsrf.com



Note: This report shall not be reproduced except in full, without the written approval of Compliance Certification Services Inc. This document may be altered or revised by Compliance Certification Services Inc. personnel only, and shall be noted in the revision section of the document.



TABLE OF CONTENTS

1. TEST RESULT CERTIFICATION.....	3
2. EUT DESCRIPTION	4
3. TEST METHODOLOGY	6
3.1 EUT CONFIGURATION	6
3.2 EUT EXERCISE	6
3.3 GENERAL TEST PROCEDURES	6
3.4 FCC PART 15.205 RESTRICTED BANDS OF OPERATIONS	7
3.5 DESCRIPTION OF TEST MODES	8
4. INSTRUMENT CALIBRATION.....	9
4.1 MEASURING INSTRUMENT CALIBRATION	9
4.2 MEASUREMENT EQUIPMENT USED	9
4.3 MEASUREMENT UNCERTAINTY	11
5. FACILITIES AND ACCREDITATIONS	12
5.1 FACILITIES	12
5.2 EQUIPMENT	12
5.3 TABLE OF ACCREDITATIONS AND LISTINGS	13
6. SETUP OF EQUIPMENT UNDER TEST	14
6.1 SETUP CONFIGURATION OF EUT	14
6.2 SUPPORT EQUIPMENT	14
7. FCC PART 15 REQUIREMENTS.....	15
7.1 26 DB EMISSION BANDWIDTH	15
7.2 MAXIMUM CONDUCTED OUTPUT POWER	33
7.3 BAND EDGES MEASUREMENT.....	39
7.4 PEAK POWER SPECTRAL DENSITY	52
7.5 PEAK EXCURSION	69
7.6 RADIATED UNDESIRABLE EMISSION.....	86
7.7 CONDUCTED UNDESIRABLE EMISSION	116
7.8 POWERLINE CONDUCTED EMISSIONS	130
7.9 FREQUENCY STABILITY.....	133
7.10 DYNAMIC FREQUENCY SELECTION.....	152
APPENDIX I RADIO FREQUENCY EXPOSURE	179
APPENDIX II PHOTOGRAPHS OF TEST SETUP.....	181
APPENDIX 1 - PHOTOGRAPHS OF EUT	



1. TEST RESULT CERTIFICATION

Applicant: Getac Technology Corp.
 No.1,R&D Road 2 , Hsinchu Science Based Industrial
 Park ,Hsinchu , Taiwan

Equipment Under Test: NOTEBOOK COMPUTER

Trade Name: Getac

Model: V100

Date of Test: July 26 ~ September 13, 2010

APPLICABLE STANDARDS	
STANDARD	TEST RESULT
FCC 47 CFR Part 15 Subpart E	No non-compliance noted

We hereby certify that:

Compliance Certification Services Inc. tested the above equipment. The test data, data evaluation, test procedures, and equipment configurations shown in this report were made in accordance with the procedures given in ANSI C63.4: 2003 and the energy emitted by the sample EUT tested as described in this report is in compliance with conducted and radiated emission limits of FCC Rules Part 15.407.

The test results of this report relate only to the tested sample identified in this report.

Approved by:

 Rex Lai
 Section Manager
 Compliance Certification Services Inc.

Reviewed by:

 Gina Lo
 Section Manager
 Compliance Certification Services Inc.



2. EUT DESCRIPTION

Product	NOTEBOOK COMPUTER			
Trade Name	Getac			
Model Number	V100			
Model Discrepancy	N/A			
WLAN Module Trade Name / Model	Intel / Intel Advanced-N 6200 WiFi Card			
Power Supply	<p>1. Power Adapter: Getac / ADM-6019M I/P: 100-240V, 1.5A, 50-60Hz O/P: 19V, 3.16A</p> <p>2. VDC from Battery: Mode: BP-LC2600/33-01SI Rating: DC 11.1V, 7800mAh, 87Wh</p>			
Operating Frequency Range & Number of Channels		Mode	Frequency Range (MHz)	Number of Channels
	UNII Band I	IEEE 802.11a	5180 - 5240	4 Channels
		draft 802.11n Standard-20 MHz	5180 - 5240	4 Channels
		draft 802.11n Wide-40 MHz	5190 ~ 5230	2 Channels
	UNII Band II	IEEE 802.11a	5260 - 5320	4 Channels
		draft 802.11n Standard-20 MHz	5260 - 5320	4 Channels
		draft 802.11n Wide-40 MHz	5270 - 5310	2 Channels
	UNII Band III	IEEE 802.11a	5500 - 5700	11 Channels
		draft 802.11n Standard-20 MHz	5500 - 5700	11 Channels
draft 802.11n Wide-40 MHz		5510 - 5670	5 Channels	
Transmit Power	<p>IEEE 802.11a mode / 5180 ~ 5240MHz: 13.96 dBm draft 802.11n Standard-20 MHz Channel mode / 5180 ~ 5240MHz: 9.51 dBm draft 802.11n Wide-40 MHz Channel mode / 5190 ~ 5230MHz: 13.19 dBm IEEE 802.11a mode / 5260 ~ 5320MHz: 17.3 dBm draft 802.11n Standard-20 MHz Channel mode / 5260 ~ 5320MHz: 16.75 dBm draft 802.11n Wide-40 MHz Channel mode / 5270 ~ 5310MHz: 16.98 dBm IEEE 802.11a mode / 5500 ~ 5700MHz: 17.39 dBm draft 802.11n Standard-20 MHz Channel mode / 5500 ~ 5700MHz: 17.19 dBm draft 802.11n Wide-40 MHz Channel mode / 5510 ~ 5670MHz: 17.02 dBm</p>			
Modulation Technique	OFDM (QPSK, BPSK, 16-QAM, 64-QAM)			
Transmit Data Rate	<p>IEEE 802.11a mode: 54, 48, 36, 24, 18, 12, 9, 6 Mbps draft 802.11n Standard-20 MHz Channel mode: OFDM (6.5, 7.2, 13, 14.4, 14.44, 19.5, 21.7, 26, 28.89, 28.9, 39, 43.3, 43.33 52, 57.78, 57.8, 58.5, 65.0, 72.2, 78, 86.67, 104, 115.56, 117, 130, 144.44 Mbps) draft 802.11n Wide-40 MHz Channel mode: OFDM (13.5, 15, 27, 30, 40.5, 45, 54, 60, 81, 90, 108, 120, 121.5, 135, 150, 162, 180, 216, 240, 243, 270, 300 Mbps)</p>			
Antenna Specification	<p>UNII Band I IEEE 802.11a: Gain: 2.41dBi UNII Band II: IEEE 802.11a: Gain: 1.86 UNII Band III: IEEE 802.11a: Gain: 3.48</p>			
Antenna Designation	PIFA Antenna			



Operation Frequency:

UNLICENSED NATIONAL INFORMATION INFRASTRUCTURE (U-NII)	
CHANNEL	MHz
36	5180
38	5190
40	5200
44	5220
46	5230
48	5240
52	5260
54	5270
56	5280
60	5300
62	5310
64	5320
100	5500
102	5510
104	5520
108	5540
110	5550
112	5560
116	5580
118	5590
120	5600
124	5620
126	5630
128	5640
132	5660
134	5670
136	5680
140	5700
149	5745

Remark:

1. *The sample selected for test was engineering sample that approximated to production product and was provided by manufacturer.*
2. *This submittal(s) (test report) is intended for FCC ID: **MAU043** filing to comply with Section 15.407 of the FCC Part 15, Subpart E Rules.*
3. *The EUT is only 1T1R.*



3. TEST METHODOLOGY

Both conducted and radiated testing was performed according to the procedures in ANSI C63.4. Radiated testing was performed at an antenna to EUT distance 3 meters.

3.1 EUT CONFIGURATION

The EUT configuration for testing is installed for RF field strength measurement to meet the Commissions requirement, and is operated in a manner intended to generate the maximum emission in a continuous normal application.

3.2 EUT EXERCISE

The EUT is operated in the engineering mode to fix the Tx frequency for the purposes of measurement.

According to its specifications, the EUT must comply with the requirements of Section 15.407 under the FCC Rules Part 15 Subpart E.

3.3 GENERAL TEST PROCEDURES

Conducted Emissions

The EUT is placed on the turntable, which is positioned at 0.8 m above the ground plane. According to the requirements in Section 13.1.4.1 of ANSI C63.4, the conducted emission from the EUT is measured in the frequency range between 0.15 MHz and 30MHz, using the CISPR Quasi-Peak detector mode.

Radiated Emissions

The EUT is placed on the turntable, which is 0.8 m above the ground plane. The turntable is then rotated for 360 degrees to determine the proper orientation for the maximum emission level. The EUT is set 3m away from the receiving antenna, which is varied from 1m to 4m to find out the highest emission level. And, each emission is to be maximized by changing the horizontal and vertical polarization of the receiving antenna. In order to find out the maximum emissions, exploratory radiated emission measurements were made according to the requirements in Section 13.1.4.1 of ANSI C63.4.



3.4 FCC PART 15.205 RESTRICTED BANDS OF OPERATIONS

(a) Except as shown in paragraph (d) of this section, only spurious emissions are permitted in any of the frequency bands listed below:

MHz	MHz	MHz	GHz
0.090 - 0.110	16.42 - 16.423	399.9 - 410	4.5 - 5.15
¹ 0.495 - 0.505	16.69475 - 16.69525	608 - 614	5.35 - 5.46
2.1735 - 2.1905	16.80425 - 16.80475	960 - 1240	7.25 - 7.75
4.125 - 4.128	25.5 - 25.67	1300 - 1427	8.025 - 8.5
4.17725 - 4.17775	37.5 - 38.25	1435 - 1626.5	9.0 - 9.2
4.20725 - 4.20775	73 - 74.6	1645.5 - 1646.5	9.3 - 9.5
6.215 - 6.218	74.8 - 75.2	1660 - 1710	10.6 - 12.7
6.26775 - 6.26825	108 - 121.94	1718.8 - 1722.2	13.25 - 13.4
6.31175 - 6.31225	123 - 138	2200 - 2300	14.47 - 14.5
8.291 - 8.294	149.9 - 150.05	2310 - 2390	15.35 - 16.2
8.362 - 8.366	156.52475 -	2483.5 - 2500	17.7 - 21.4
8.37625 - 8.38675	156.52525	2655 - 2900	22.01 - 23.12
8.41425 - 8.41475	156.7 - 156.9	3260 - 3267	23.6 - 24.0
12.29 - 12.293	162.0125 - 167.17	3332 - 3339	31.2 - 31.8
12.51975 - 12.52025	167.72 - 173.2	3345.8 - 3358	36.43 - 36.5
12.57675 - 12.57725	240 - 285	3600 - 4400	(²)
13.36 - 13.41	322 - 335.4		

¹ Until February 1, 1999, this restricted band shall be 0.490-0.510 MHz.

² Above 38.6

(b) Except as provided in paragraphs (d) and (e), the field strength of emissions appearing within these frequency bands shall not exceed the limits shown in Section 15.209. At frequencies equal to or less than 1000 MHz, compliance with the limits in Section 15.209 shall be demonstrated using measurement instrumentation employing a CISPR quasi-peak detector. Above 1000 MHz, compliance with the emission limits in Section 15.209 shall be demonstrated based on the average value of the measured emissions. The provisions in Section 15.35 apply to these measurements.



3.5 DESCRIPTION OF TEST MODES

The EUT (model: V100) had been tested under operating condition.

The EUT comes with one battery and one power adapter for sale. After the preliminary test, the EUT with power adapter was found to emit the worst emissions and therefore had been tested under standby condition.

Software used to control the EUT for staying in continuous transmitting mode was programmed.

After verification, all tests were carried out with the worst case test modes as shown below except radiated spurious emission below 1GHz, which worst case was in normal link mode only.

IEEE 802.11a mode / 5180 ~ 5240MHz:

Channel Low (5180MHz), Channel Mid (5220MHz) and Channel High (5240MHz) with 6Mbps data rate were chosen for full testing.

draft 802.11n Standard-20 MHz Channel mode / 5180 ~ 5240MHz:

Channel Low (5180MHz), Channel Mid (5220MHz) and Channel High (5240MHz) with 6.5Mbps data rate were chosen for full testing.

draft 802.11n Wide-40 MHz Channel mode / 5190 ~ 5230MHz:

Channel Low (5190MHz) and Channel High (5230MHz) with 13.5Mbps data rate were chosen for full testing.

IEEE 802.11a mode / 5260 ~ 5320MHz:

Channel Low (5260MHz), Channel Mid (5280MHz) and Channel High (5320MHz) with 6Mbps data rate were chosen for full testing.

draft 802.11n Standard-20 MHz Channel mode / 5260 ~ 5320MHz:

Channel Low (5260MHz), Channel Mid (5280MHz) and Channel High (5320MHz) with 6.5Mbps data rate were chosen for full testing.

draft 802.11n Wide-40 MHz Channel mode / 5270 ~ 5310MHz:

Channel Low (5270MHz) and Channel High (5310MHz) with 13.5Mbps data rate were chosen for full testing.

IEEE 802.11a mode / 5500 ~ 5700MHz:

Channel Low (5500MHz), Channel Mid (5600MHz) and Channel High (5700MHz) with 6Mbps data rate were chosen for full testing.

draft 802.11n Standard-20 MHz Channel mode / 5500 ~ 5700MHz:

Channel Low (5500MHz), Channel Mid (5600MHz) and Channel High (5700MHz) with 6.5Mbps data rate were chosen for full testing.

draft 802.11n Wide-40 MHz Channel mode / 5510 ~ 5670MHz:

Channel Low (5510MHz), Channel Mid (5590MHz) and Channel High (5670MHz) with 13.5Mbps data rate were chosen for full testing.

This amplifier is only connected to used for 2.4 GHz antenna part.



4. INSTRUMENT CALIBRATION

4.1 MEASURING INSTRUMENT CALIBRATION

The measuring equipment, which was utilized in performing the tests documented herein, has been calibrated in accordance with the manufacturer's recommendations for utilizing calibration equipment, which is traceable to recognized national standards.

4.2 MEASUREMENT EQUIPMENT USED

Equipment Used for Emissions Measurement

Remark: Each piece of equipment is scheduled for calibration once a year and Loop Antenna is scheduled for calibration once three years.

Conducted Emissions Test Site				
Name of Equipment	Manufacturer	Model	Serial Number	Calibration Due
Spectrum Analyzer	Agilent	E4446A	MY43360131	03/03/2011

3M Semi Anechoic Chamber				
Name of Equipment	Manufacturer	Model	Serial Number	Calibration Due
Spectrum Analyzer	Agilent	E4446A	US42510252	10/27/2011
EMI Test Receiver	R&S	ESCI	100064	02/04/2011
Pre-Amplifier	Mini-Circuits	ZFL-1000LN	SF350700823	01/13/2011
Pre-Amplifier	MITEQ	AFS44-00102650-42-10P-44	1415367	11/20/2010
Bilog Antenna	Sunol Sciences	JB3	A030105	09/10/2011
Horn Antenna	EMCO	3117	00055165	12/07/2010
Loop Antenna	EMCO	6502	8905/2356	06/10/2013
Turn Table	CCS	CC-T-1F	N/A	N.C.R
Antenna Tower	CCS	CC-A-1F	N/A	N.C.R
Controller	CCS	CC-C-1F	N/A	N.C.R
Site NSA	CCS	N/A	N/A	12/31/2010
Test S/W	EZ-EMC (CCS-3A1RE)			



Powerline Conducted Emissions Test Site				
Name of Equipment	Manufacturer	Model	Serial Number	Calibration Due
L.I.S.N	SCHWARZBECK	NSLK 8127	8127-465	08/12/2011
L.I.S.N	SCHWARZBECK	NSLK 8127	8127-473	03/22/2011
EMI Test Receiver	ROHDE & SCHWARZ	ESHS 30	838550/003	01/28/2011
Pulse Limit	ROHDE & SCHWARZ	ESH3-Z2	100117	09/16/2011
N Type Coaxial Cable	BELDEN	8268 M17/164	003	07/09/2011
I.S.N.	SCHAFFNER	T800	24313	05/04/2011
Ferrite Clamp	SCHAFFNER	KEMA801	15937	05/04/2011
Current Probe	SCHAFFNER	SMZ11	14802	N.C.R.

Dynamic Frequency Selection				
Name of Equipment	Manufacturer	Model	Serial Number	Calibration Due
Spectrum Analyzer	Rohde&Schwarz	FSEK 30	100264	04/08/2011
Signal Generator	Agilent	E8267C	US42340162	04/08/2011



4.3 MEASUREMENT UNCERTAINTY

PARAMETER	UNCERTAINTY
Powerline Conducted Emission	+/- 1.7468
3M Semi Anechoic Chamber / 30M~200M	+/- 4.0606
3M Semi Anechoic Chamber / 200M~1000M	+/- 3.9979
3M Semi Anechoic Chamber / 1G~8G	+/- 2.5790
3M Semi Anechoic Chamber / 8G~18G	+/- 2.5928
3M Semi Anechoic Chamber / 18G~26G	+/- 2.7212
3M Semi Anechoic Chamber / 26G~40G	+/- 2.9520

Remark: This uncertainty represents an expanded uncertainty expressed at approximately the 95% confidence level using a coverage factor of $k=2$.



5. FACILITIES AND ACCREDITATIONS

5.1 FACILITIES

All measurement facilities used to collect the measurement data are located at

No. 11, Wugong 6th Rd., Wugu Industrial Park, Taipei Hsien 248, Taiwan
Tel: 886-2-2299-9720 / Fax: 886-2-2298-4045

No.989-1, Wenshan Rd., Qionglin Township, Hsinchu County 307, Taiwan (R.O.C.)
Tel: +886-3-5921698

Remark: The powerline conducted emissions items was tested at Compliance Certification Services Inc. (Hsinchu Lab.) The test equipments were listed in page 10 and the test data, please refer page 131-132.

No.81-1, Lane 210, Bade 2nd Rd., Luchu Hsiang, Taoyuan Hsien 338, Taiwan
Tel: 886-3-324-0332 / Fax: 886-3-324-5235

The sites are constructed in conformance with the requirements of ANSI C63.7, ANSI C63.4 and CISPR Publication 22.

5.2 EQUIPMENT

Radiated emissions are measured with one or more of the following types of linearly polarized antennas: tuned dipole, biconical, log periodic, bi-log, and/or ridged waveguide, horn. Spectrum analyzers with pre-selectors and quasi-peak detectors are used to perform radiated measurements.





Conducted emissions are measured with Line Impedance Stabilization Networks and EMI Test Receivers.

Calibrated wideband preamplifiers, coaxial cables, and coaxial attenuators are also used for making measurements.

All receiving equipment conforms to CISPR Publication 16-1, "Radio Interference Measuring Apparatus and Measurement Methods."

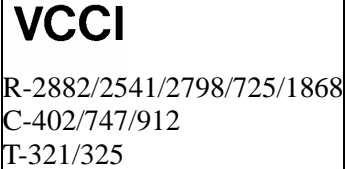

5.3 TABLE OF ACCREDITATIONS AND LISTINGS

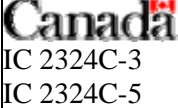
Country	Agency	Scope of Accreditation	Logo
USA	A2LA	CFR 47, FCC Part15/18, CISPR 22, EN 55022, ICES-003, AS/NZS CISPR 22, VCCI V-3, EN 55011, CISPR 11, IEC/EN 61000-4-2/3/4/5/6/8/11, EN 61000-6-1/2/3/4, EN 55024, CISPR 24, AS/NZS CISPR 24, AS/NZS 61000.6.2, EN 55014-1/-2, ETSI EN 300 386 v1.3.2/v1.3.3, IEC/EN 61000-3-2, AS/NZS 61000.3.2, IEC/EN 61000-3-3, AS/NZS 61000.3.3	
USA	FCC MRA	3/10 meter Open Area Test Sites to perform FCC Part 15/18 measurements	
Japan	VCCI	3/10 meter Open Area Test Sites and conducted test sites to perform radiated/conducted measurements	
Taiwan	TAF	EN 55014-1, CISPR 14, CNS 13781-1, EN 55013, CISPR 13, CNS 13439, EN 55011, CISPR 11, CNS 13803, PLMN09, IS2045-0, LP0002 FCC Part 27/90, Part 15B/C/D/E, RSS-192/193/210/310 ETSI EN 300 328/ 300 220-1/ 300 220-2/ 301 893/ 301 489-01/ 301 489-03/ 301 489-07 / 301 489-17/ 300 440-1/ 300 440-2 AS/NZS 4268, AS/NZS 4771 CISPR 22, EN 55022, CNS 13438, AS/NZS CISPR 22, VCCI, IEC/EN 61000-4-2/3/4/5/6/8/11, CNS 14676-2/3/4/5/6/8, CNS 14934-2/3, CNS 13783-1, CNS 13439, CNS 13803	
Taiwan	BSMI	CNS 13438, CNS 13783-1, CNS 13439, CNS 14115	SL2-IS-E-0014 / IN-E-0014 /A1-E-0014 /R1-E-0014 /R2-E-0014 /L1-E-0014
Canada	Industry Canada	RSS212, Issue 1	

* No part of this report may be used to claim or imply product endorsement by A2LA or any agency of the US Government.



6. SETUP OF EQUIPMENT UNDER TEST

6.1 SETUP CONFIGURATION OF EUT

See test photographs attached in Appendix I for the actual connections between EUT and support equipment.

6.2 SUPPORT EQUIPMENT

No.	Product	Manufacturer	Model No.	Serial No.	FCC ID
1	GPS Simulator	HWAJEAT	GPS-101	EN001	---
2	8960 Series 10 Wireless Communication test set	Agilent	E5515C	GB44051665	---
3	ADVANCED HYBRID SYSTEM	Panasonic	KX-TA308	---	---
4	Notebook PC	Lenovo ideaPad	S10e_4068-RZ1	L3CEV2D	HFS-FL
5	Notebook PC	HP	nx6130	CNU543274R	CNTWM3B2200BGA
6	Bluetooth Headset	Motorola	H17	SJYN029A	IHDP6KE1
7	Modem	ZyXEL	Omni 56K	S1Z4107727	1880MNI56K
8	LED Monitor	ViewSonic	VS12085	R18082200389	DoC
9	Headset/Microphone	ERGOTECH	ET-E203	4719405008042	---
10	E-SATA External hard	VANTEC	NexStar CX	---	---
11	Flash disk	Transcend	CompactFlash512MB	1561433338	---
12	Flash disk	Sayho	PR1014(256M)	104720	---
13	SD Crad	SanDisk	---	---	---
14	Smart Card	HOME RUN CARD	---	---	---
15	PCMCIA Card (CF Adapter)	Billionton	1211004-0040	00082900065	---
16	CF Card	iEi	ICF1000	ICF-10001-128MB	---

Remark:

1. All the equipment/cables were placed in the worst-case configuration to maximize the emission during the test.
2. Grounding was established in accordance with the manufacturer's requirements and conditions for the intended use.



7. FCC PART 15 REQUIREMENTS

7.1 26 DB EMISSION BANDWIDTH

LIMIT

According to §15.303(c), for purposes of this subpart the emission bandwidth shall be determined by measuring the width of the signal between two points, one below the carrier center frequency and one above the carrier center frequency, that are 26 dB down relative to the maximum level of the modulated carrier. Compliance with the emissions limits is based on the use of measurement instrumentation employing a peak detector function with an instrument resolutions bandwidth approximately equal to 1.0 percent of the emission bandwidth of the device under measurement.

Test Configuration

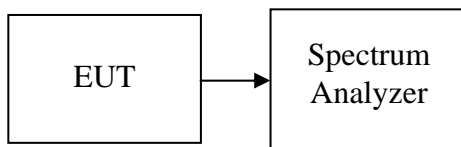

TEST PROCEDURE

1. Place the EUT on the table and set it in the transmitting mode.
2. Remove the antenna from the EUT and then connect a low-loss RF cable from the antenna port to the spectrum analyzer.
3. Set the spectrum analyzer as $RBW > 1\%EBW$, $VBW > RBW$, $Span > 26dB$ bandwidth, and Sweep = auto.
4. Mark the peak frequency and $-26dB$ (upper and lower) frequency.
5. Repeat until all the rest channels were investigated.

TEST RESULTS

No non-compliance noted



Test Data

Test mode: IEEE 802.11a mode / 5180 ~ 5240MHz

Channel	Frequency (MHz)	Bandwidth (MHz)
Low	5180	17.8778
Mid	5220	17.6860
High	5240	18.1167

Test mode: draft 802.11n Standard-20 MHz Channel mode / 5180 ~ 5240MHz

Channel	Frequency (MHz)	Bandwidth (MHz)
Low	5180	17.7229
Mid	5220	17.7124
High	5240	17.7051

Test mode: draft 802.11n Wide-40 MHz Channel mode/ 5190 ~ 5230MHz

Channel	Frequency (MHz)	Bandwidth (MHz)
Low	5190	35.1716
High	5230	35.0385



Test mode: IEEE 802.11a mode / 5260 ~ 5320MHz

Channel	Frequency (MHz)	Bandwidth (MHz)
Low	5260	26.7455
Mid	5280	25.9677
High	5320	24.8279

Test mode: draft 802.11n Standard-20 MHz Channel mode / 5260 ~ 5320MHz

Channel	Frequency (MHz)	Bandwidth (MHz)
Low	5260	22.9213
Mid	5280	21.2566
High	5320	20.7527

Test mode: draft 802.11n Wide-40 MHz Channel mode / 5270 ~ 5310MHz

Channel	Frequency (MHz)	Bandwidth (MHz)
Low	5270	35.0599
High	5310	35.0841



Test mode: IEEE 802.11a mode / 5500 ~ 5700MHz

Channel	Frequency (MHz)	Bandwidth (MHz)
Low	5500	21.3457
Mid	5600	21.2108
High	5700	23.8520

Test mode: draft 802.11n Standard-20 MHz Channel mode / 5500 ~ 5700MHz

Channel	Frequency (MHz)	Bandwidth (MHz)
Low	5500	19.1300
Mid	5600	20.7282
High	5700	21.5958

Test mode: draft 802.11n Wide-40 MHz Channel mode / 5510 ~ 5670MHz

Channel	Frequency (MHz)	Bandwidth (MHz)
Low	5510	35.6595
Mid	5590	35.6675
High	5670	35.7511



Test Plot

IEEE 802.11a mode / 5180 ~ 5240MHz

CH Low

Agilent 17:02:44 Jul 27, 2010

R T

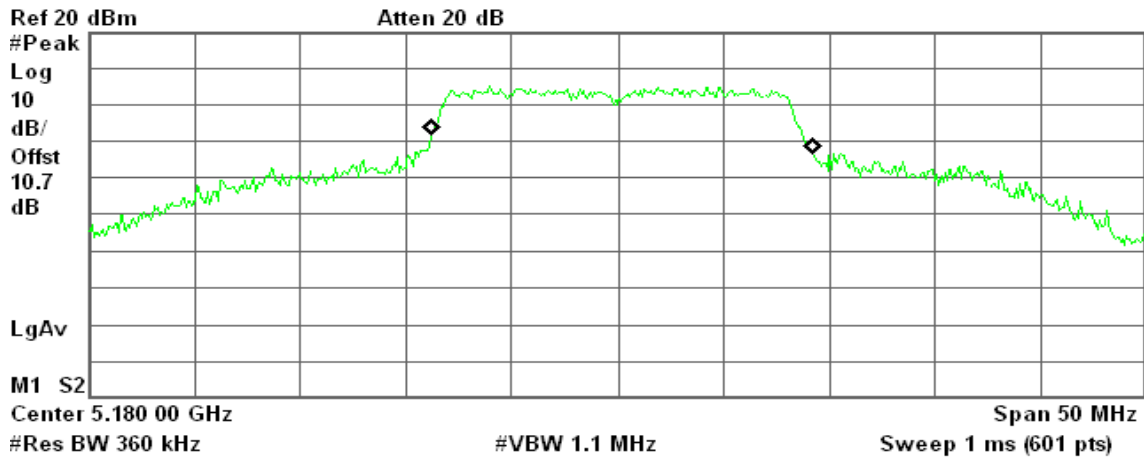

Occupied Bandwidth

17.8778 MHz

Occ BW % Pwr 99.00 %
x dB -26.00 dB

Transmit Freq Error 198.653 kHz
x dB Bandwidth 35.440 MHz

CH Mid

Agilent 17:10:11 Jul 27, 2010

R T

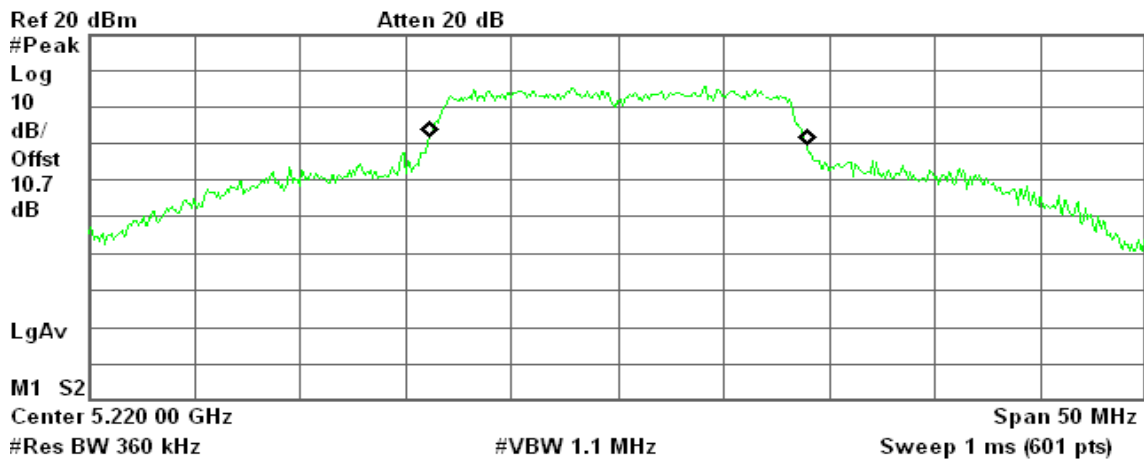

Occupied Bandwidth

17.6860 MHz

Occ BW % Pwr 99.00 %
x dB -26.00 dB

Transmit Freq Error 41.596 kHz
x dB Bandwidth 34.251 MHz



CH High

Agilent 17:14:12 Jul 27, 2010

R T

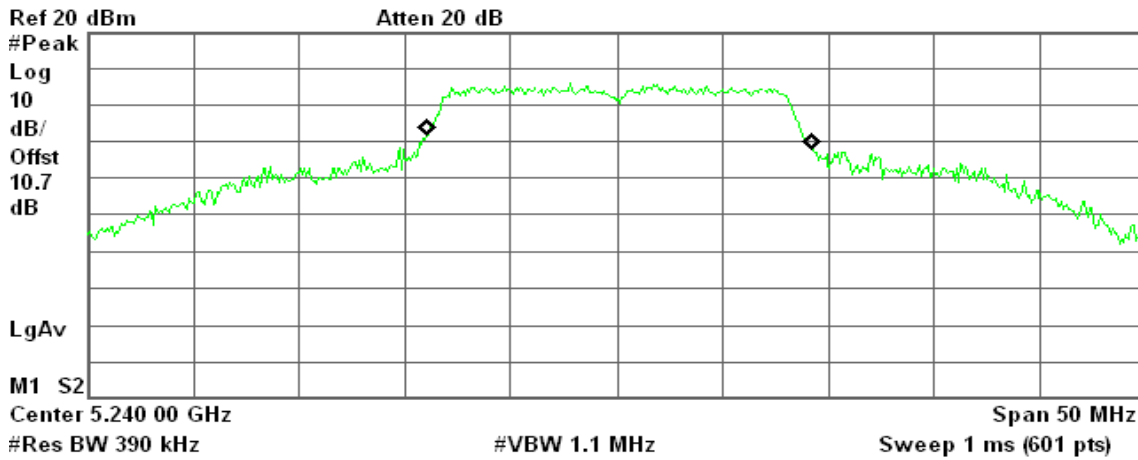

Occupied Bandwidth
18.1167 MHz

Occ BW % Pwr 99.00 %
x dB -26.00 dB

Transmit Freq Error 140.472 kHz
x dB Bandwidth 36.030 MHz

draft 802.11n Standard-20 MHz Channel mode / 5180 ~ 5240MHz

CH Low

Agilent 14:50:01 Jul 28, 2010

R T

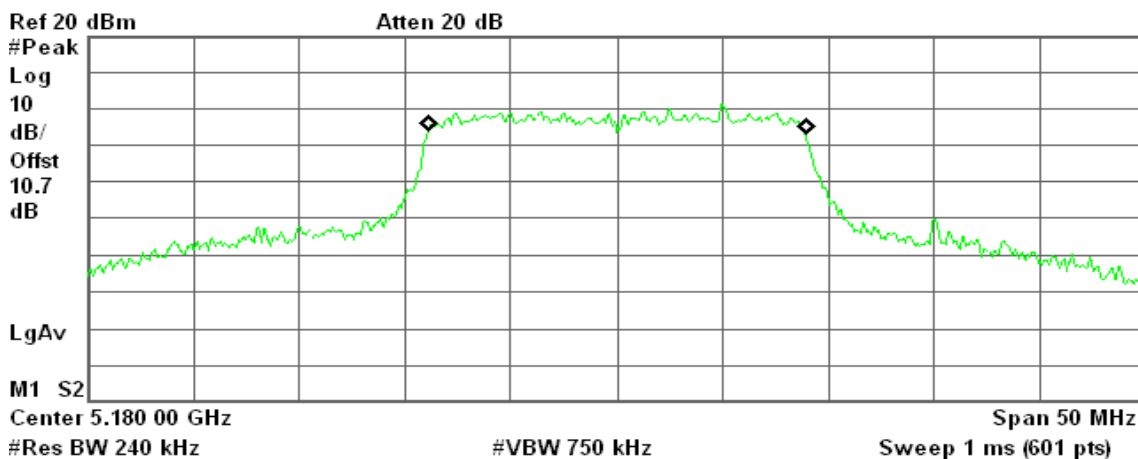

Occupied Bandwidth
17.7229 MHz

Occ BW % Pwr 99.00 %
x dB -26.00 dB

Transmit Freq Error 14.632 kHz
x dB Bandwidth 19.966 MHz



CH Mid

Agilent 14:52:20 Jul 28, 2010

R T

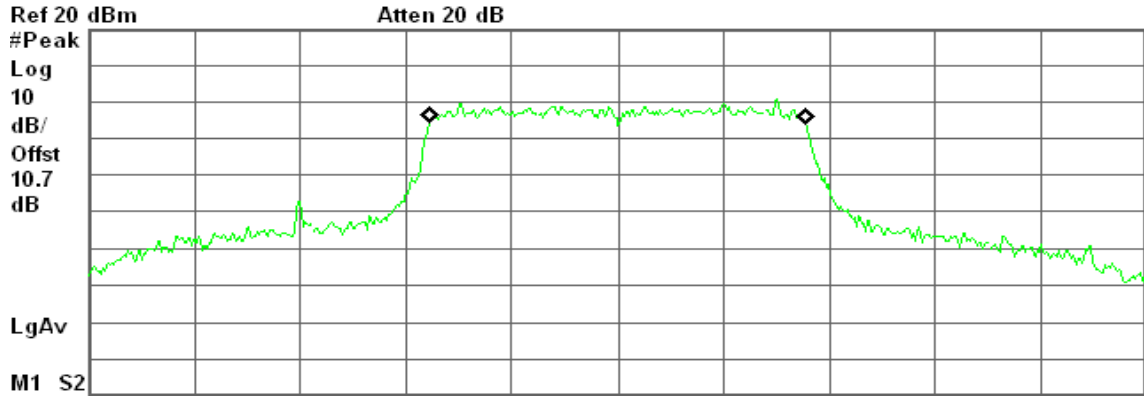

Center 5.220 00 GHz Span 50 MHz
#Res BW 240 kHz #VBW 680 kHz Sweep 1 ms (601 pts)

Occupied Bandwidth
17.7124 MHz

Occ BW % Pwr 99.00 %
x dB -26.00 dB

Transmit Freq Error 16.057 kHz
x dB Bandwidth 19.974 MHz

CH High

Agilent 14:35:53 Jul 28, 2010

R T

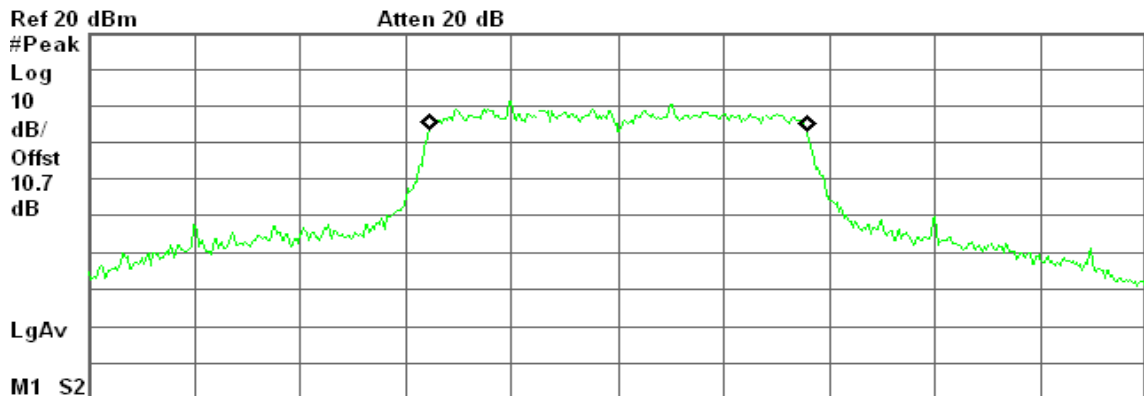

Center 5.240 00 GHz Span 50 MHz
#Res BW 240 kHz #VBW 680 kHz Sweep 1 ms (601 pts)

Occupied Bandwidth
17.7051 MHz

Occ BW % Pwr 99.00 %
x dB -26.00 dB

Transmit Freq Error 25.611 kHz
x dB Bandwidth 19.779 MHz



draft 802.11n Wide-40 MHz Channel mode / 5190 ~ 5230MHz

CH Low

Agilent 16:58:10 Jul 28, 2010

R L

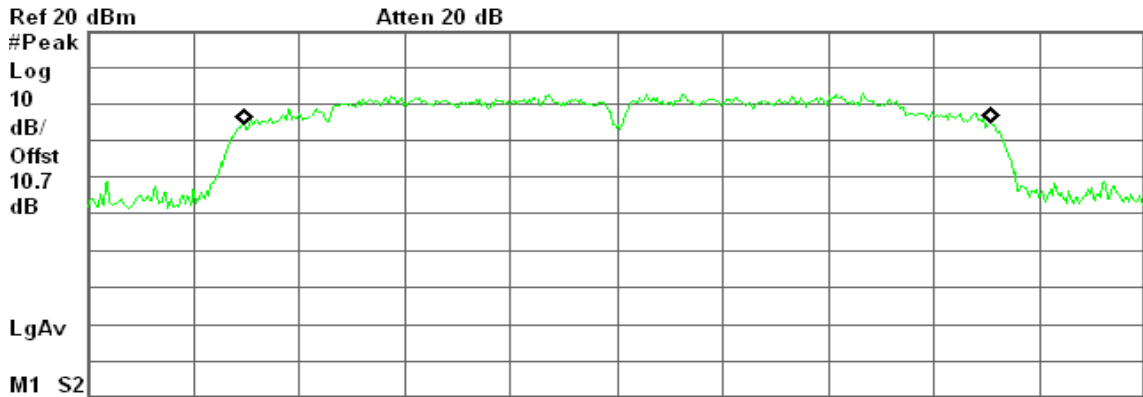

Center 5.190 00 GHz Span 50 MHz
#Res BW 430 kHz #VBW 1.3 MHz Sweep 1 ms (601 pts)

Occupied Bandwidth
35.1716 MHz

Occ BW % Pwr 99.00 %
x dB -26.00 dB

Transmit Freq Error 41.972 kHz
x dB Bandwidth 47.807 MHz

CH High

Agilent 17:08:31 Jul 28, 2010

R T

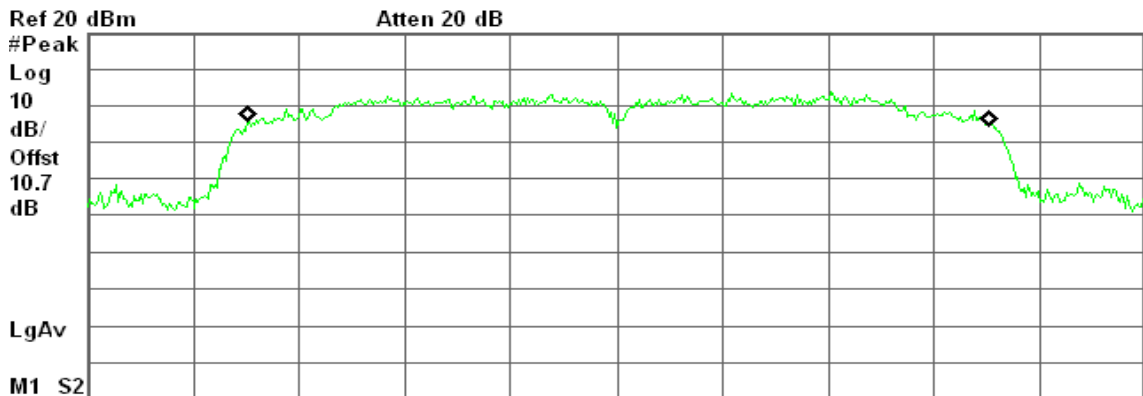

Center 5.230 00 GHz Span 50 MHz
#Res BW 470 kHz #VBW 1.3 MHz Sweep 1 ms (601 pts)

Occupied Bandwidth
35.0385 MHz

Occ BW % Pwr 99.00 %
x dB -26.00 dB

Transmit Freq Error 103.485 kHz
x dB Bandwidth 46.795 MHz



IEEE 802.11a mode / 5260 ~ 5320MHz

CH Low

Agilent 10:46:48 Jul 28, 2010

R T

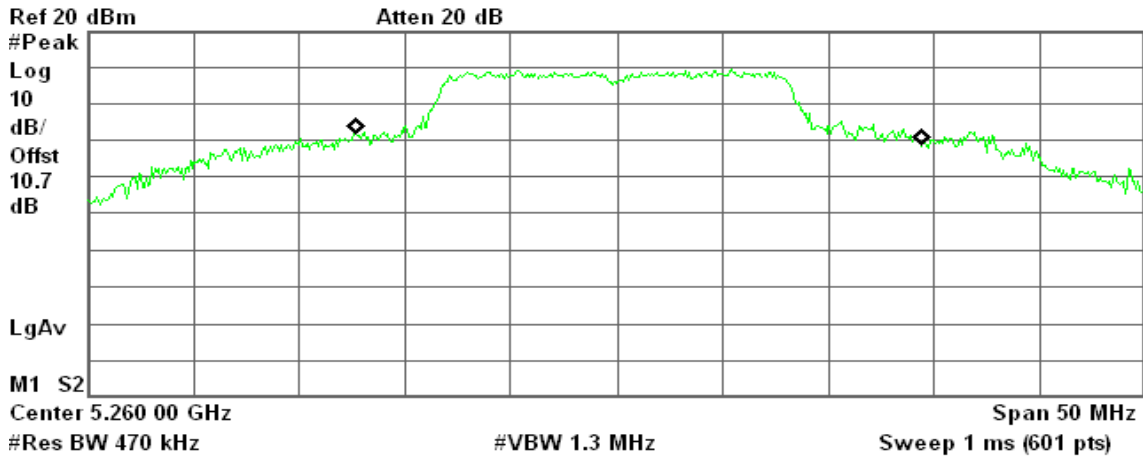

Occupied Bandwidth
26.7455 MHz

Occ BW % Pwr 99.00 %
x dB -26.00 dB

Transmit Freq Error 1.034 MHz
x dB Bandwidth 40.339 MHz

CH Mid

Agilent 10:41:45 Jul 28, 2010

R T

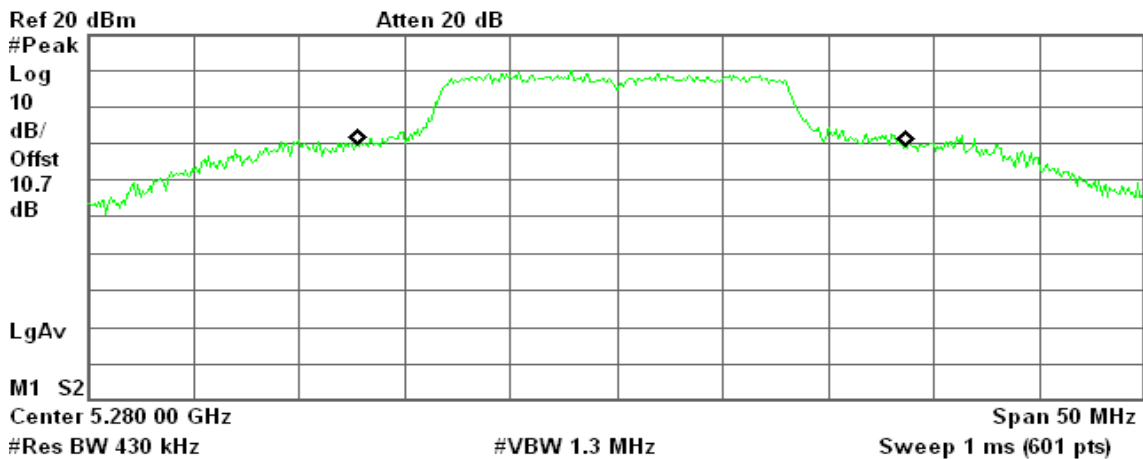

Occupied Bandwidth
25.9677 MHz

Occ BW % Pwr 99.00 %
x dB -26.00 dB

Transmit Freq Error 720.370 kHz
x dB Bandwidth 40.034 MHz



CH High

Agilent 10:52:48 Jul 28, 2010

R T

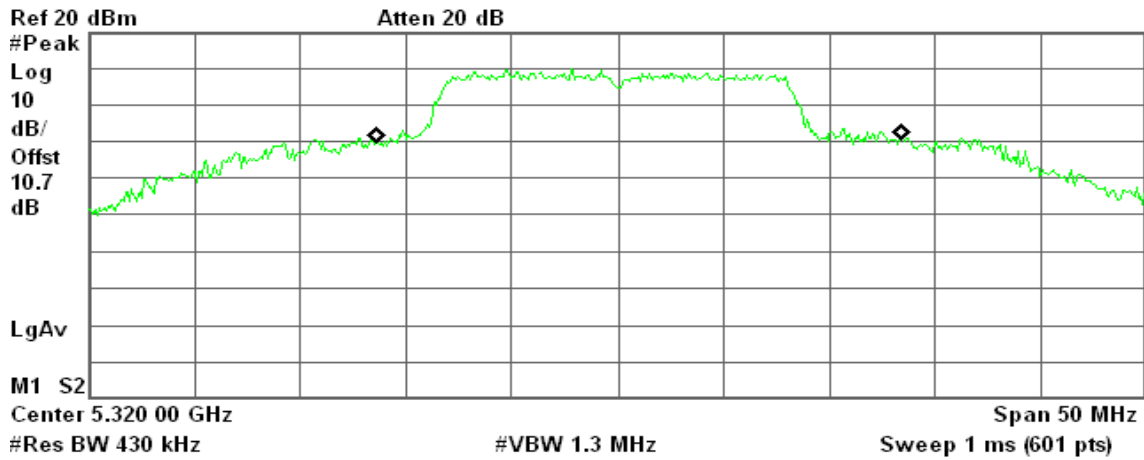

Occupied Bandwidth
24.8279 MHz

Occ BW % Pwr 99.00 %
x dB -26.00 dB

Transmit Freq Error 963.460 kHz
x dB Bandwidth 38.964 MHz



draft 802.11n Standard-20 MHz Channel mode / 5260 ~ 5320MHz

CH Low

* Agilent 14:57:42 Jul 28, 2010

R T

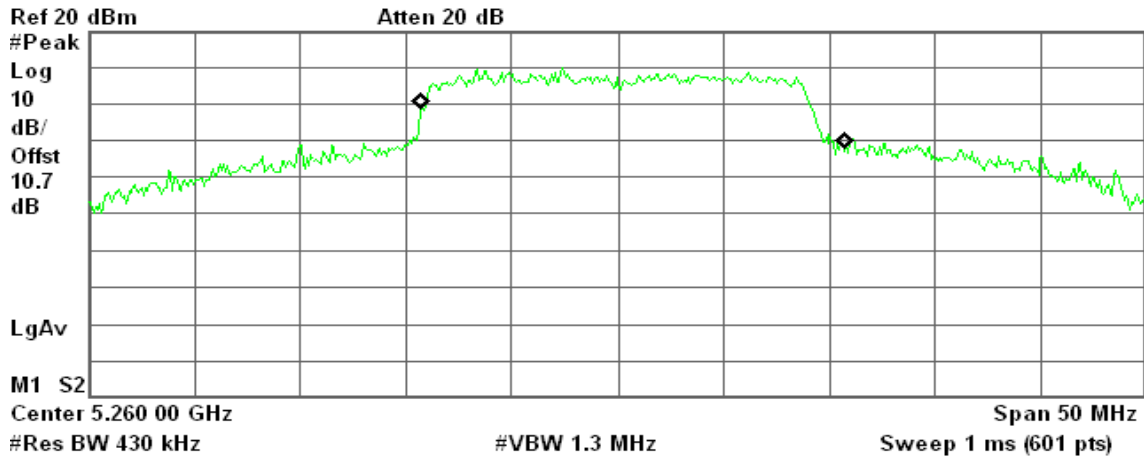

Occupied Bandwidth
19.9704 MHz

Occ BW % Pwr 99.00 %
x dB -26.00 dB

Transmit Freq Error 734.151 kHz
x dB Bandwidth 37.116 MHz



CH Mid

Agilent 15:00:54 Jul 28, 2010

R T

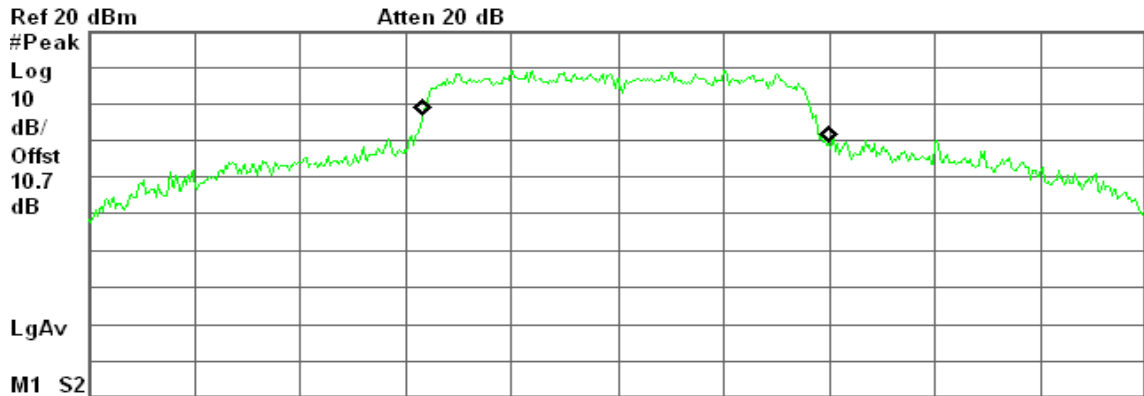

Center 5.280 00 GHz Span 50 MHz
#Res BW 390 kHz #VBW 1.1 MHz Sweep 1 ms (601 pts)

Occupied Bandwidth
19.0482 MHz

Occ BW % Pwr 99.00 %
x dB -26.00 dB

Transmit Freq Error 389.039 kHz
x dB Bandwidth 37.598 MHz

CH High

Agilent 15:03:41 Jul 28, 2010

R L

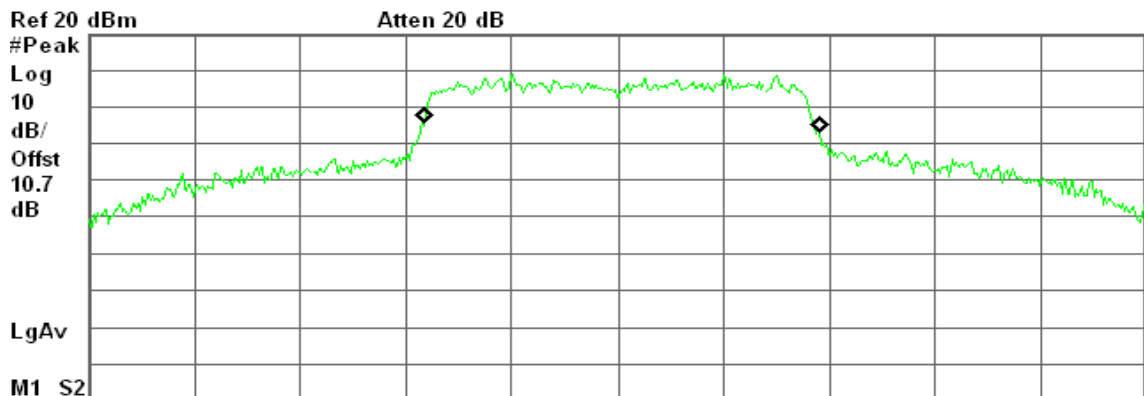

Center 5.320 00 GHz Span 50 MHz
#Res BW 330 kHz #VBW 1 MHz Sweep 1 ms (601 pts)

Occupied Bandwidth
18.5639 MHz

Occ BW % Pwr 99.00 %
x dB -26.00 dB

Transmit Freq Error 230.887 kHz
x dB Bandwidth 35.759 MHz



draft 802.11n Wide-40 MHz Channel mode / 5270 ~ 5310MHz

CH Low

Agilent 16:53:10 Jul 28, 2010

R T

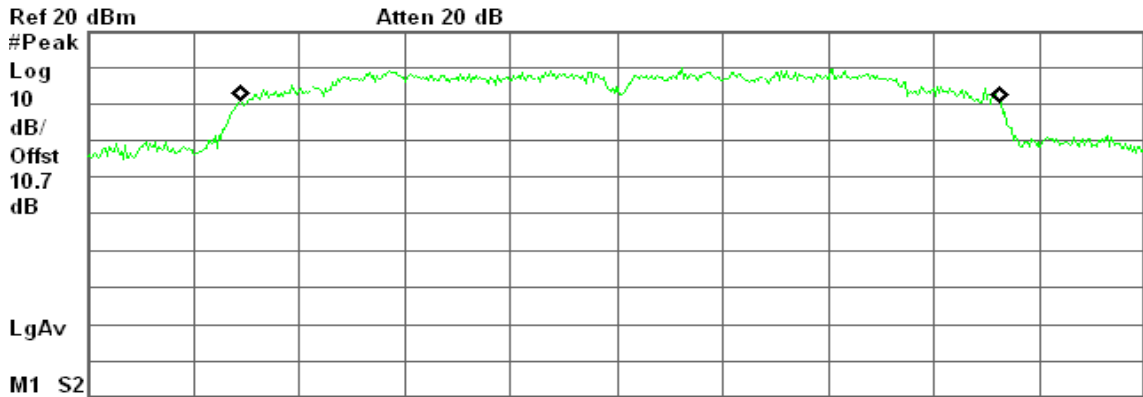

Center 5.270 00 GHz Span 50 MHz
 #Res BW 620 kHz #VBW 1.8 MHz Sweep 1 ms (601 pts)

Occupied Bandwidth
 35.8777 MHz

Occ BW % Pwr 99.00 %
 x dB -26.00 dB

Transmit Freq Error 162.486 kHz
 x dB Bandwidth 50.000 MHz

CH High

Agilent 16:39:05 Jul 28, 2010

R T

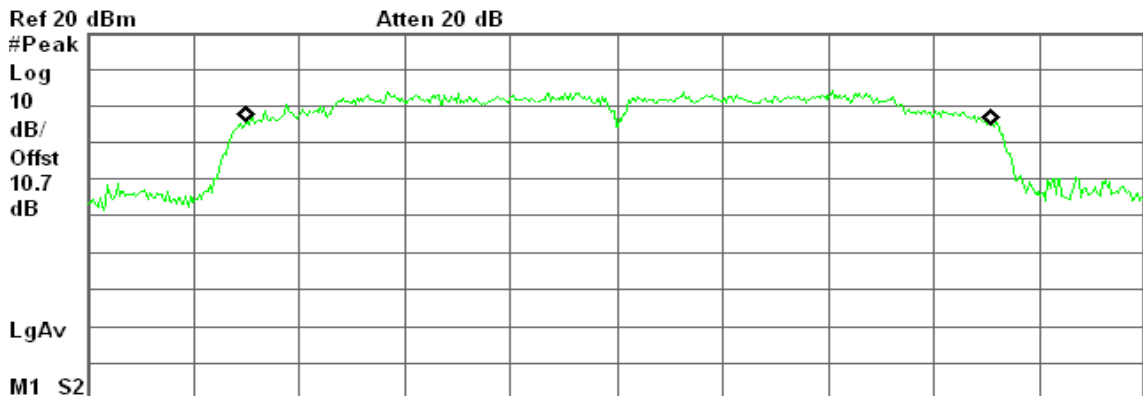

Center 5.310 00 GHz Span 50 MHz
 #Res BW 430 kHz #VBW 1.3 MHz Sweep 1 ms (601 pts)

Occupied Bandwidth
 35.1158 MHz

Occ BW % Pwr 99.00 %
 x dB -26.00 dB

Transmit Freq Error 79.564 kHz
 x dB Bandwidth 47.455 MHz



Test mode: IEEE 802.11a mode / 5500 ~ 5700MHz

CH Low

Agilent 11:00:18 Jul 28, 2010

R T

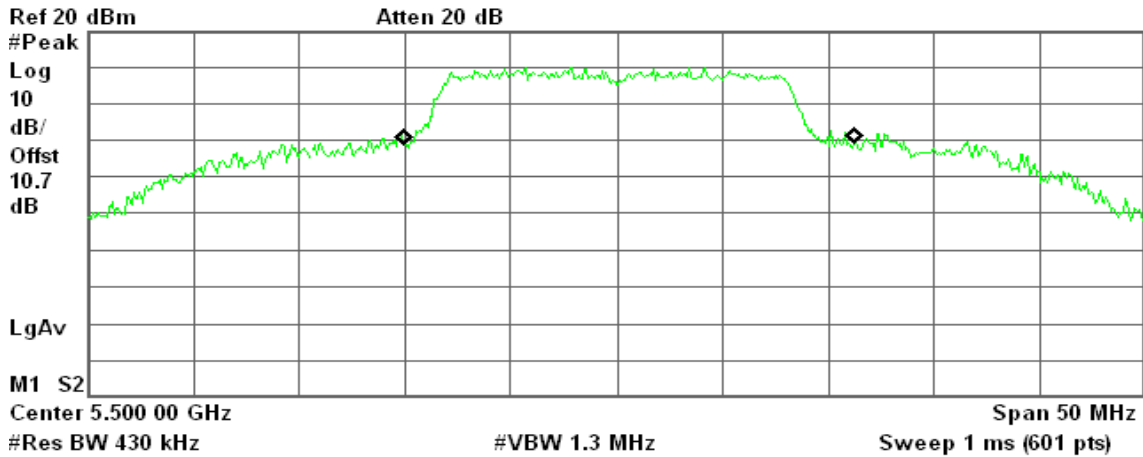

Occupied Bandwidth
21.3457 MHz

Occ BW % Pwr 99.00 %
x dB -26.00 dB

Transmit Freq Error 595.998 kHz
x dB Bandwidth 38.753 MHz

CH Mid

Agilent 11:02:52 Jul 28, 2010

R T

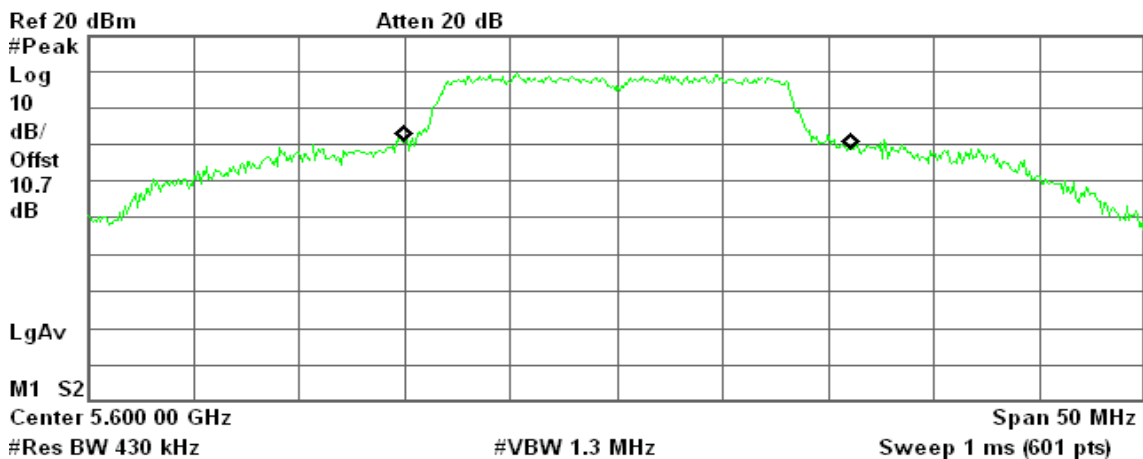

Occupied Bandwidth
21.2108 MHz

Occ BW % Pwr 99.00 %
x dB -26.00 dB

Transmit Freq Error 501.155 kHz
x dB Bandwidth 38.673 MHz



CH High

Agilent 11:05:31 Jul 28, 2010

R L

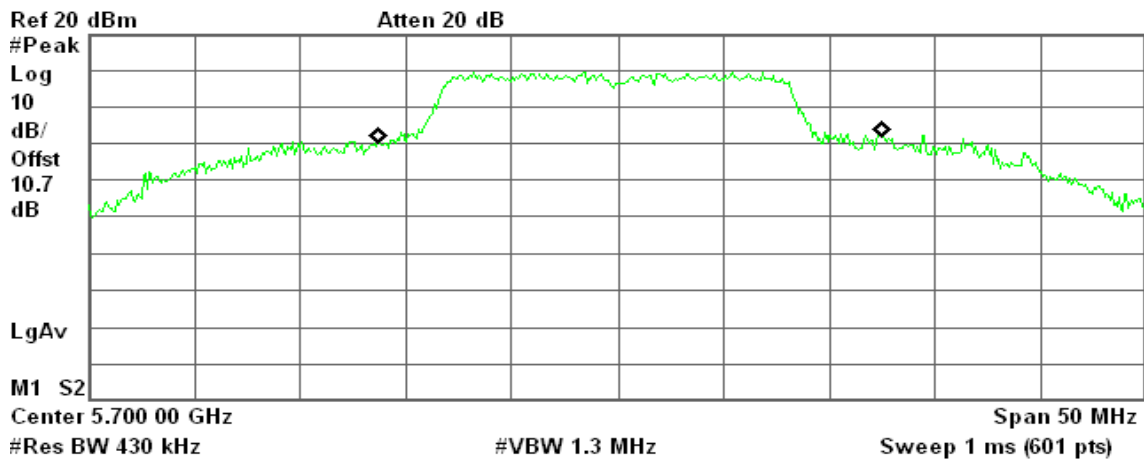

Occupied Bandwidth
23.8520 MHz

Occ BW % Pwr 99.00 %
x dB -26.00 dB

Transmit Freq Error 560.056 kHz
x dB Bandwidth 39.608 MHz

draft 802.11n Standard-20 MHz Channel mode / 5500 ~ 5700MHz

CH Low

Agilent 15:08:07 Jul 28, 2010

R T

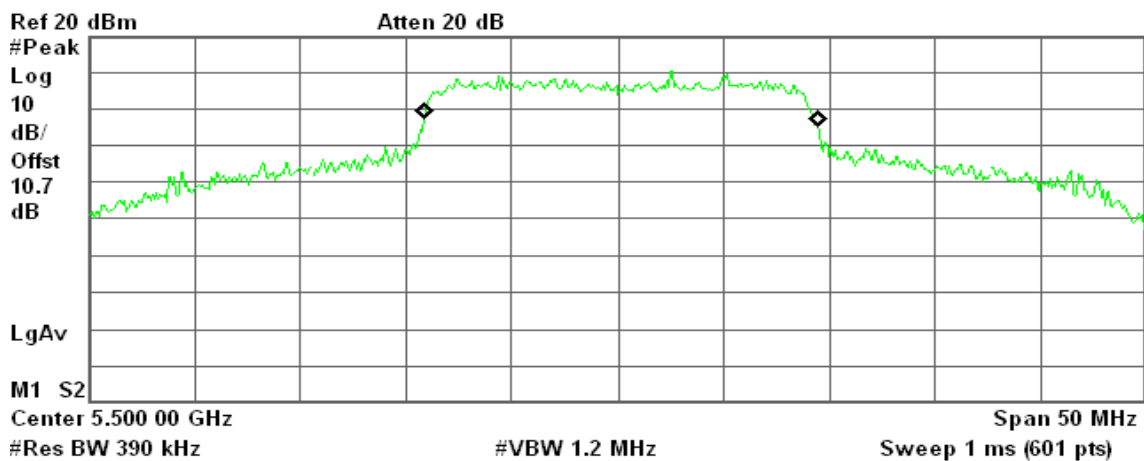

Occupied Bandwidth
18.5349 MHz

Occ BW % Pwr 99.00 %
x dB -26.00 dB

Transmit Freq Error 175.665 kHz
x dB Bandwidth 33.594 MHz



CH Mid

Agilent 15:10:29 Jul 28, 2010

R T

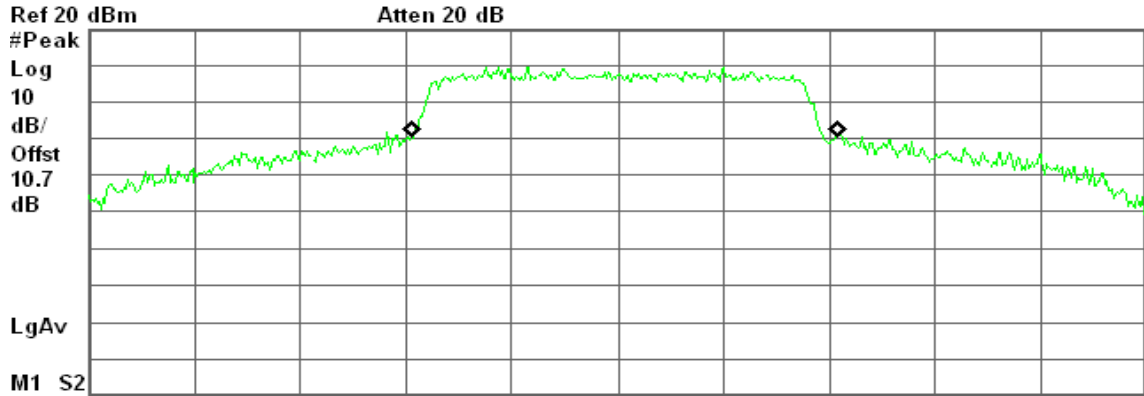

Center 5.600 00 GHz Span 50 MHz
#Res BW 430 kHz #VBW 1.2 MHz Sweep 1 ms (601 pts)

Occupied Bandwidth
20.0124 MHz

Occ BW % Pwr 99.00 %
x dB -26.00 dB

Transmit Freq Error 377.655 kHz
x dB Bandwidth 38.351 MHz

CH High

Agilent 15:14:13 Jul 28, 2010

R T

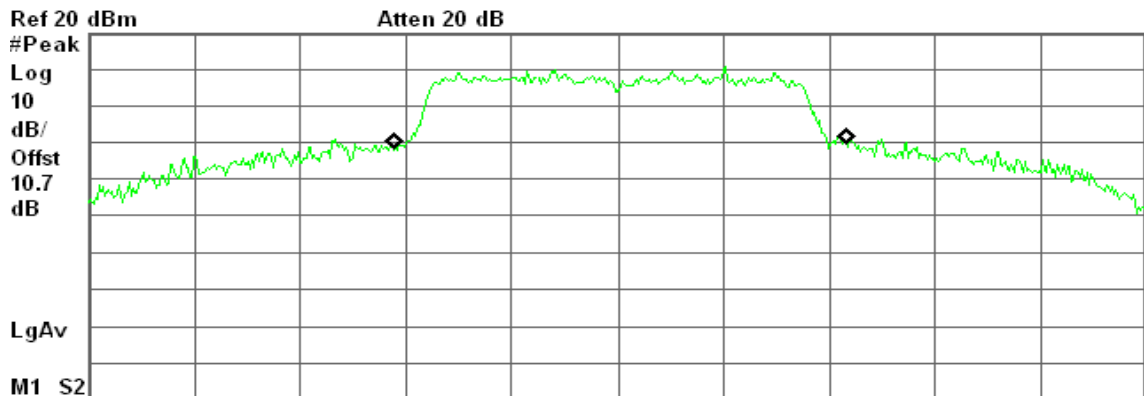

Center 5.700 00 GHz Span 50 MHz
#Res BW 430 kHz #VBW 1.3 MHz Sweep 1 ms (601 pts)

Occupied Bandwidth
21.4706 MHz

Occ BW % Pwr 99.00 %
x dB -26.00 dB

Transmit Freq Error 125.914 kHz
x dB Bandwidth 41.039 MHz



draft 802.11n Wide-40 MHz Channel mode / 5510 ~ 5670MHz

CH Low

Agilent 17:20:30 Jul 28, 2010

R T

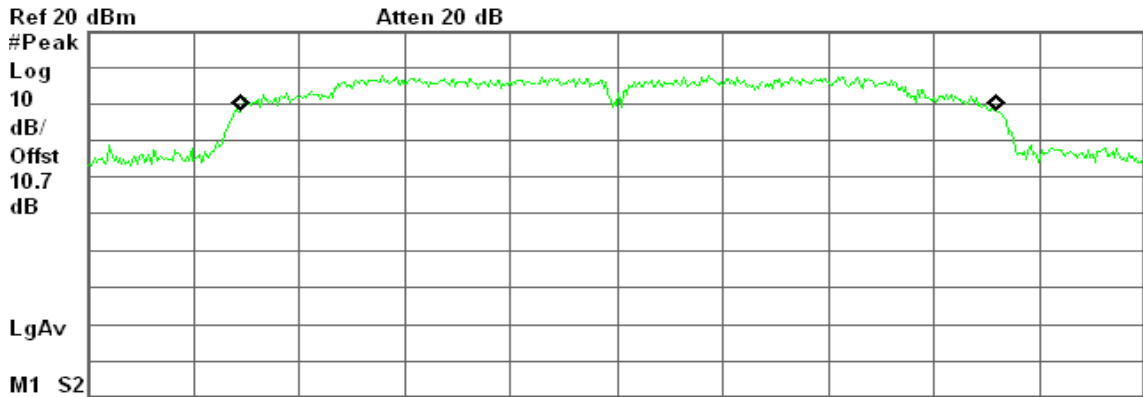

Center 5.510 00 GHz Span 50 MHz
 #Res BW 560 kHz #VBW 1.8 MHz Sweep 1 ms (601 pts)

Occupied Bandwidth
35.6344 MHz

Occ BW % Pwr 99.00 %
 x dB -26.00 dB

Transmit Freq Error 95.471 kHz
 x dB Bandwidth 50.000 MHz

CH Mid

Agilent 17:23:17 Jul 28, 2010

R T

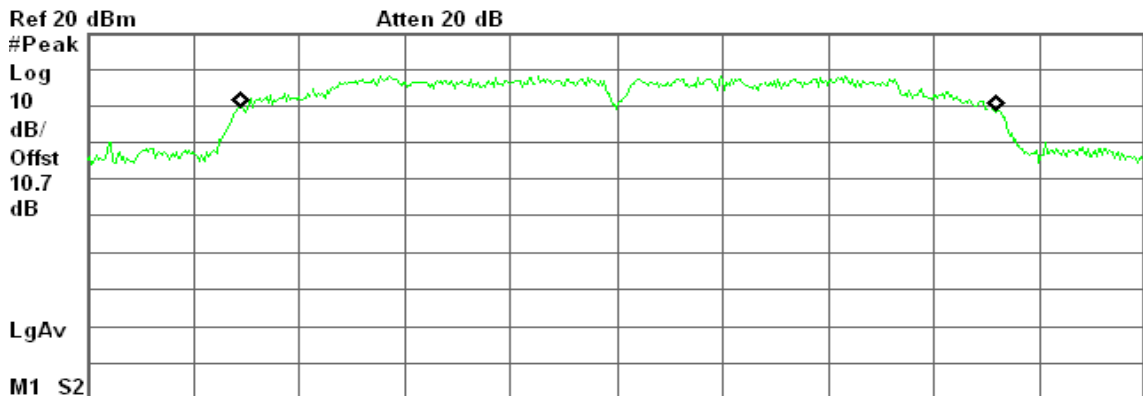

Center 5.590 00 GHz Span 50 MHz
 #Res BW 560 kHz #VBW 1.8 MHz Sweep 1 ms (601 pts)

Occupied Bandwidth
35.7386 MHz

Occ BW % Pwr 99.00 %
 x dB -26.00 dB

Transmit Freq Error 80.828 kHz
 x dB Bandwidth 50.000 MHz



CH High

Agilent 17:25:48 Jul 28, 2010

R T

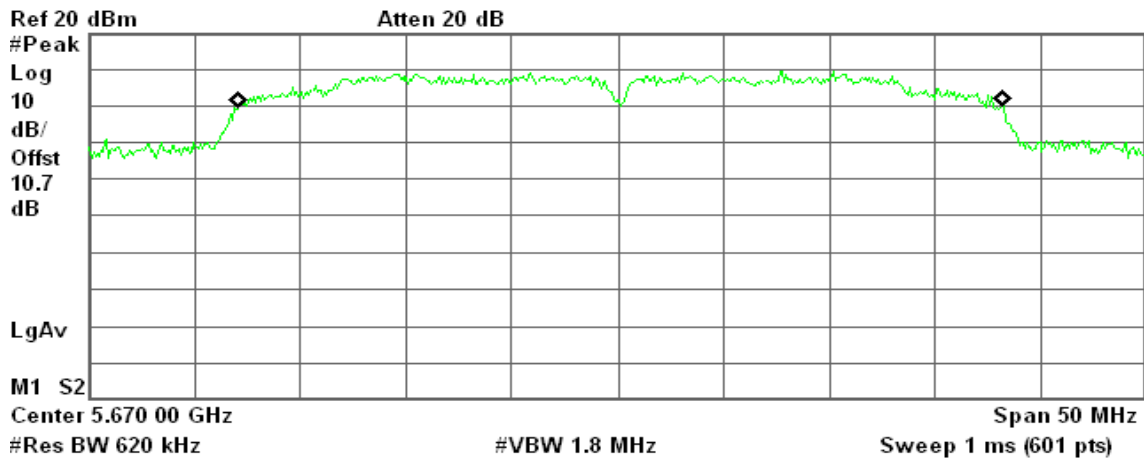

Occupied Bandwidth
36.0224 MHz

Occ BW % Pwr 99.00 %
x dB -26.00 dB

Transmit Freq Error 119.512 kHz
x dB Bandwidth 50.000 MHz



7.2 MAXIMUM CONDUCTED OUTPUT POWER

LIMIT

According to §15.407(a),

- (1) For the band 5.15-5.25 GHz, the maximum conducted output power over the frequency band of operation shall not exceed the lesser of 50 mW or $4 \text{ dBm} + 10 \log B$, where B is the 26 dB emission bandwidth in MHz.
- (2) For the 5.25-5.35 GHz and 5.47-5.725 GHz bands, the maximum conducted output power over the frequency bands of operation shall not exceed the lesser of 250 mW or $11 \text{ dBm} + 10 \log B$, where B is the 26 dB emission bandwidth in MHz.

If transmitting antennas of directional gain greater than 6dBi are used, both the peak transmit power and the peak power spectral density shall be reduced by the amount in dB that the directional gain of the antenna exceeds 6dBi.

The peak power shall not exceed the limit as follow:

Test mode: IEEE 802.11a mode / 5180 ~ 5240MHz

Channel	Frequency (MHz)	26 dB Bandwidth (B) (MHz)	10 Log B (dB)	4 + 10 Log B (dBm)	Maximum Conducted Output Power Limit (dBm)
Low	5180	17.8778	12.52314	16.5231	17.00
Mid	5220	17.686	12.47630	16.4763	17.00
High	5240	18.1167	12.58079	16.5808	17.00

Test mode: draft 802.11n Standard-20 MHz Channel mode / 5180 ~ 5240MHz

Channel	Frequency (MHz)	26 dB Bandwidth (B) (MHz)	10 Log B (dB)	4 + 10 Log B (dBm)	Maximum Conducted Output Power Limit (dBm)
Low	5180	17.7229	12.48535	16.4853	17.00
Mid	5220	17.7124	12.48277	16.4828	17.00
High	5240	17.7051	12.48098	16.4810	17.00

Test mode: draft 802.11n Wide-40 MHz Channel mode / 5190 ~ 5230MHz

Channel	Frequency (MHz)	26 dB Bandwidth (B) (MHz)	10 Log B (dB)	4 + 10 Log B (dBm)	Maximum Conducted Output Power Limit (dBm)
Low	5190	35.1716	15.46192	19.4619	17.00
High	5230	35.0385	15.44546	19.4455	17.00



Test mode: IEEE 802.11a mode / 5260 ~ 5320MHz

Channel	Frequency (MHz)	26 dB Bandwidth (B) (MHz)	10 Log B (dB)	11 + 10 Log B (dBm)	Maximum Conducted Output Power Limit (dBm)
Low	5260	26.7455	14.27251	18.2725	24.00
Mid	5280	25.9677	14.14433	18.1443	24.00
High	5320	24.8279	13.94940	17.9494	24.00

Test mode: draft 802.11n Standard-20 MHz Channel mode / 5260 ~ 5320MHz

Channel	Frequency (MHz)	26 dB Bandwidth (B) (MHz)	10 Log B (dB)	11 + 10 Log B (dBm)	Maximum Conducted Output Power Limit (dBm)
Low	5260	19.9704	13.00387	17.0039	24.00
Mid	5280	19.0482	12.79854	16.7985	24.00
High	5320	18.5639	12.68669	16.6867	24.00

Test mode: draft 802.11n Wide-40 MHz Channel mode / 5270 ~ 5310MHz

Channel	Frequency (MHz)	26 dB Bandwidth (B) (MHz)	10 Log B (dB)	11 + 10 Log B (dBm)	Maximum Conducted Output Power Limit (dBm)
Low	5270	35.8777	15.54825	19.5482	24.00
High	5310	35.1158	15.45503	19.4550	24.00

Test mode: IEEE 802.11a mode / 5500 ~ 5700MHz

Channel	Frequency (MHz)	26 dB Bandwidth (B) (MHz)	10 Log B (dB)	11 + 10 Log B (dBm)	Maximum Conducted Output Power Limit (dBm)
Low	5500	21.3457	13.29310	17.2931	24.00
Mid	5600	21.2108	13.26557	17.2656	24.00
High	5700	23.852	13.77525	17.7752	24.00

Test mode: draft 802.11n Standard-20 MHz Channel mode/ 5500 ~ 5700MHz

Channel	Frequency (MHz)	26 dB Bandwidth (B) (MHz)	10 Log B (dB)	11 + 10 Log B (dBm)	Maximum Conducted Output Power Limit (dBm)
Low	5500	18.5349	12.67990	16.6799	24.00
Mid	5600	20.0124	13.01299	17.0130	24.00
High	5700	21.4706	13.31844	17.3184	24.00

Test mode: draft 802.11n Wide-40 MHz Channel mode / 5510 ~ 5670MHz

Channel	Frequency (MHz)	26 dB Bandwidth (B) (MHz)	10 Log B (dB)	11 + 10 Log B (dBm)	Maximum Conducted Output Power Limit (dBm)
Low	5510	35.6344	15.51869	19.5187	24.00
Mid	5590	35.7386	15.53138	19.5314	24.00
High	5670	36.0224	15.56573	19.5657	24.00



Test Configuration

The EUT was connected to a spectrum analyzer through a 50 Ω RF cable.

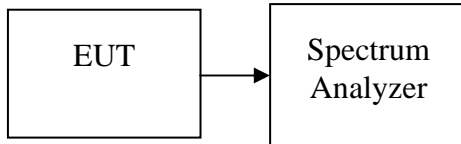

TEST PROCEDURE

Set span to encompass the entire emission bandwidth (EBW) of the signal.

Set RBW = 1 MHz / Set VBW = 3 MHz.

Use sample detector mode if bin width (i.e., span/number of points in spectrum display) < 0.5 RBW. Otherwise use peak detector mode. Use a video trigger with the trigger level set to enable triggering only on full power pulses. Transmitter must operate at full control power for entire sweep of every sweep. If the device transmits continuously, with no off intervals or reduced power intervals, the trigger may be set to “free run”. Trace average 100 traces in power averaging mode. Compute power by integrating the spectrum across the 26 dB EBW of the signal. The integration can be performed using the spectrum analyzer’s band power measurement function with band limits set equal to the EBW band edges or by summing power levels in each 1 MHz band in linear power terms. The 1 MHz band power levels to be summed can be obtained by averaging, in linear power terms, power levels in each frequency bin across the 1 MHz.

TEST RESULTS

No non-compliance noted



Test Data

Test mode: IEEE 802.11a mode / 5180 ~ 5240MHz

Channel	Frequency (MHz)	Maximum Conducted Output Power (dBm)	Limit (dBm)
Low	5180	13.52	17.00
Mid	5220	13.75	17.00
High	5240	13.96	17.00

Test mode: draft 802.11n Standard-20 MHz Channel mode / 5180 ~ 5240MHz

Channel	Frequency (MHz)	Maximum Conducted Output Power (dBm)	Limit (dBm)
Low	5180	9.51	17.00
Mid	5220	9.01	17.00
High	5240	9.12	17.00

Test mode: draft 802.11n Wide-40 MHz Channel mode / 5190 ~ 5230MHz

Channel	Frequency (MHz)	Maximum Conducted Output Power (dBm)	Limit (dBm)
Low	5190	13.19	17.00
High	5230	11.3	17.00



Test mode: IEEE 802.11a mode / 5260 ~ 5320MHz

Channel	Frequency (MHz)	Maximum Conducted Output Power (dBm)	Limit (dBm)
Low	5260	16.42	24.00
Mid	5280	17.3	24.00
High	5320	17.16	24.00

Test mode: draft 802.11n Standard-20 MHz Channel mode / 5260 ~ 5320MHz

Channel	Frequency (MHz)	Maximum Conducted Output Power (dBm)	Limit (dBm)
Low	5260	16.03	24.00
Mid	5280	16.29	24.00
High	5320	16.75	24.00

Test mode: draft 802.11n Wide-40 MHz Channel mode / 5270 ~ 5310MHz

Channel	Frequency (MHz)	Maximum Conducted Output Power (dBm)	Limit (dBm)
Low	5270	16.98	24.00
High	5310	13.16	24.00



Test mode: IEEE 802.11a mode / 5500 ~ 5700MHz

Channel	Frequency (MHz)	Maximum Conducted Output Power (dBm)	Limit (dBm)
Low	5500	17.2	24.00
Mid	5600	17.05	24.00
High	5700	17.39	24.00

Test mode: draft 802.11n Standard-20 MHz Channel mode / 5500 ~ 5700MHz

Channel	Frequency (MHz)	Maximum Conducted Output Power (dBm)	Limit (dBm)
Low	5500	16.45	24.00
Mid	5600	16.59	24.00
High	5700	17.19	24.00

Test mode: draft 802.11n Wide-40 MHz Channel mode / 5510 ~ 5670MHz

Channel	Frequency (MHz)	Maximum Conducted Output Power (dBm)	Limit (dBm)
Low	5510	16.02	24.00
Mid	5590	17.02	24.00
High	5670	16.96	24.00



7.3 BAND EDGES MEASUREMENT

LIMIT

According to §15.407(b),

- (1) The provisions of Section 15.205 of this part apply to intentional radiators operating under this section.
- (2) When measuring the emission limits, the nominal carrier frequency shall be adjusted as close to the upper and lower frequency block edges as the design of the equipment permits.

Test Configuration

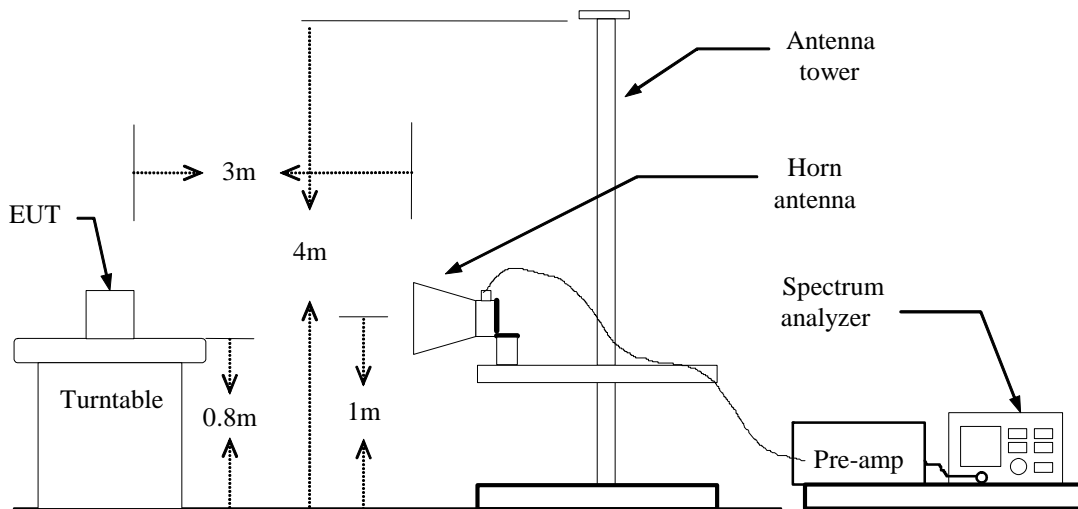

TEST PROCEDURE

1. The EUT is placed on a turntable, which is 0.8m above the ground plane.
2. The turntable shall be rotated for 360 degrees to determine the position of maximum emission level.
3. EUT is set 3m away from the receiving antenna, which is varied from 1m to 4m to find out the highest emission.
4. Set the spectrum analyzer in the following setting in order to capture the lower and upper band-edges of the emission:
 - (a) PEAK: RBW=VBW=1MHz / Sweep=AUTO
 - (b) AVERAGE: RBW=1MHz / VBW=10Hz / Sweep=AUTO
5. Repeat the procedures until all the PEAK and AVERAGE versus POLARIZATION are measured.

TEST RESULTS

Refer to attach spectrum analyzer data chart.

802.11a Mode

1. Operating Frequency: 5500-5700MHz
2. CH Low: 5500MHz, CH High: 5700MHz
3. 26dB bandwidth: CH Low: 21.3457MHz, CH High: 23.8520MHz

Because the mentioned conditions, the test is not applicable.



Band Edges (IEEE 802.11a mode / 5180 MHz)

Detector mode: Peak

Polarity: Vertical

Agilent 12:13:05 Jul 26, 2010

R T

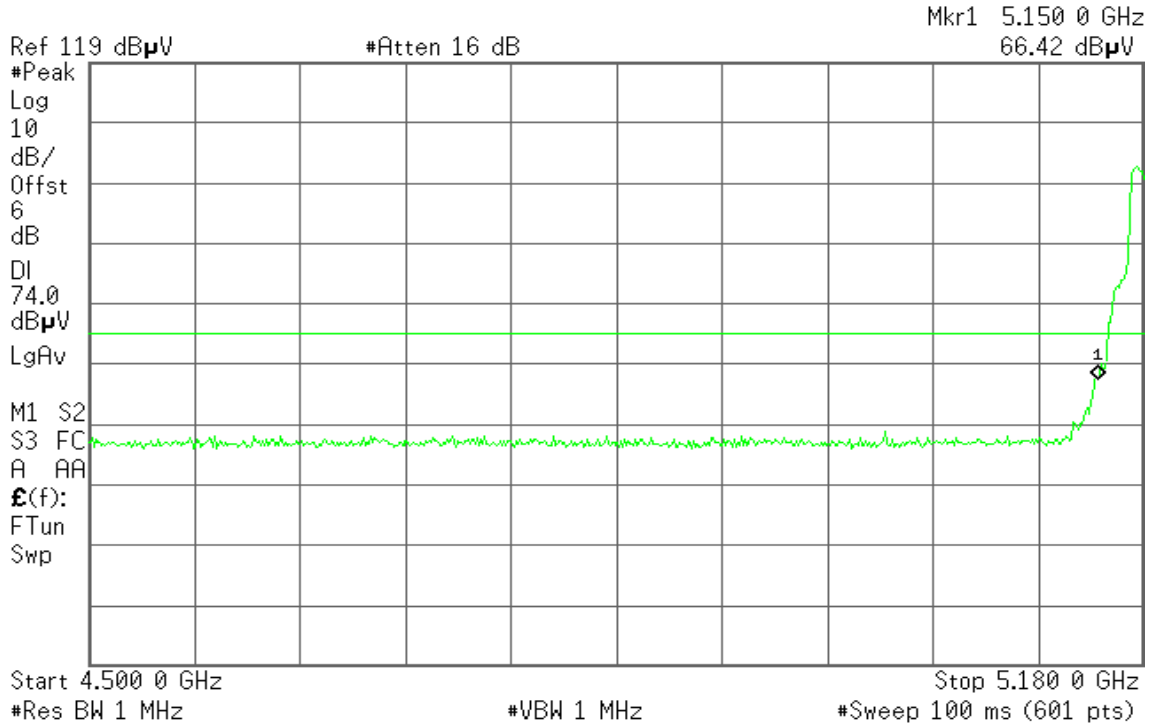

Detector mode: Average

Polarity: Vertical

Agilent 12:14:53 Jul 26, 2010

R T

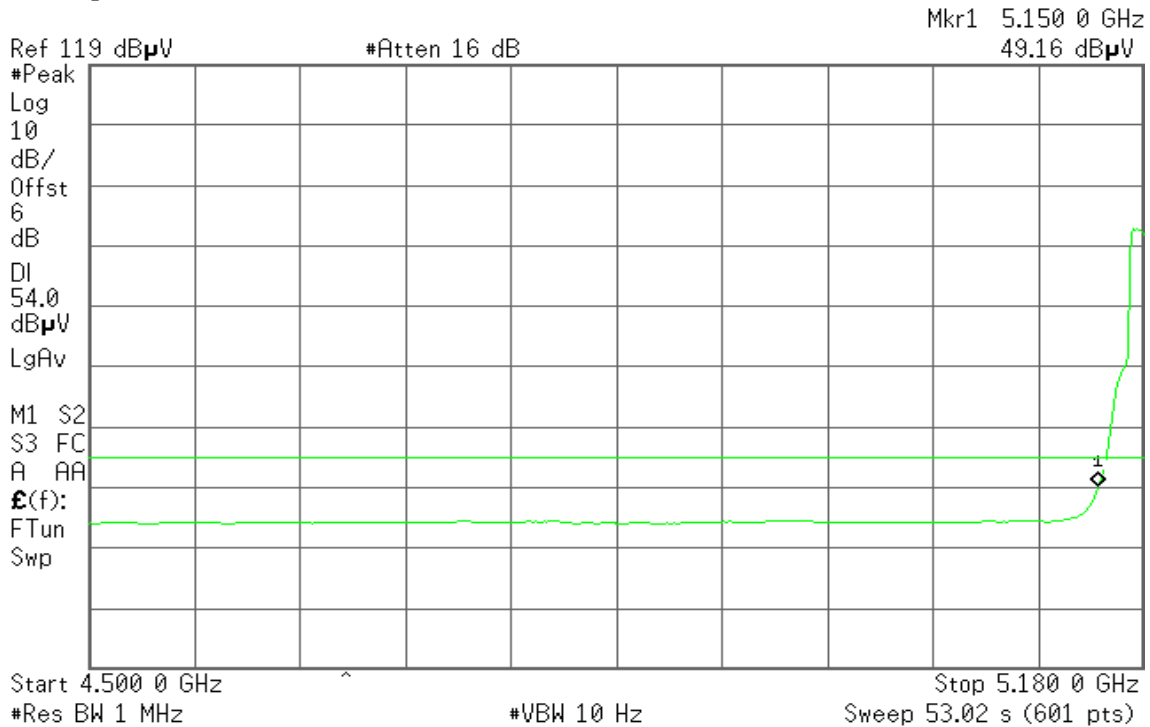



Detector mode: Peak

Polarity: Horizontal

Agilent 12:19:23 Jul 26, 2010

R T

Mkr1 5.150 0 GHz
63.97 dB μ V

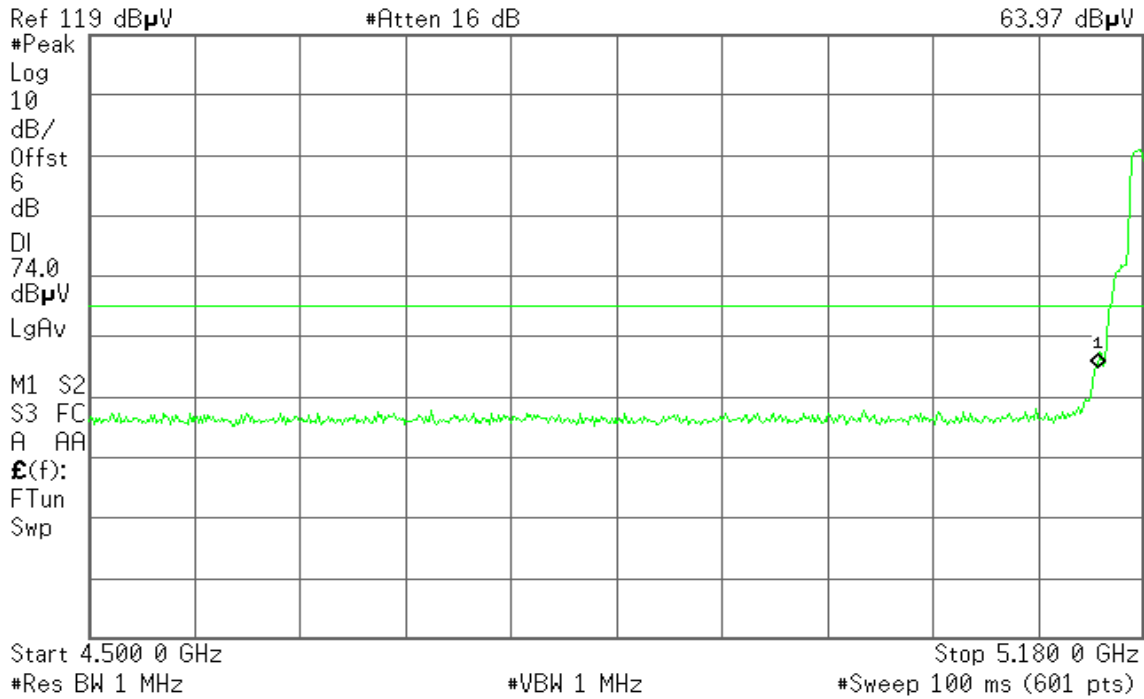

Detector mode: Average

Polarity: Horizontal

Agilent 12:20:43 Jul 26, 2010

R T

Mkr1 5.150 0 GHz
48.34 dB μ V

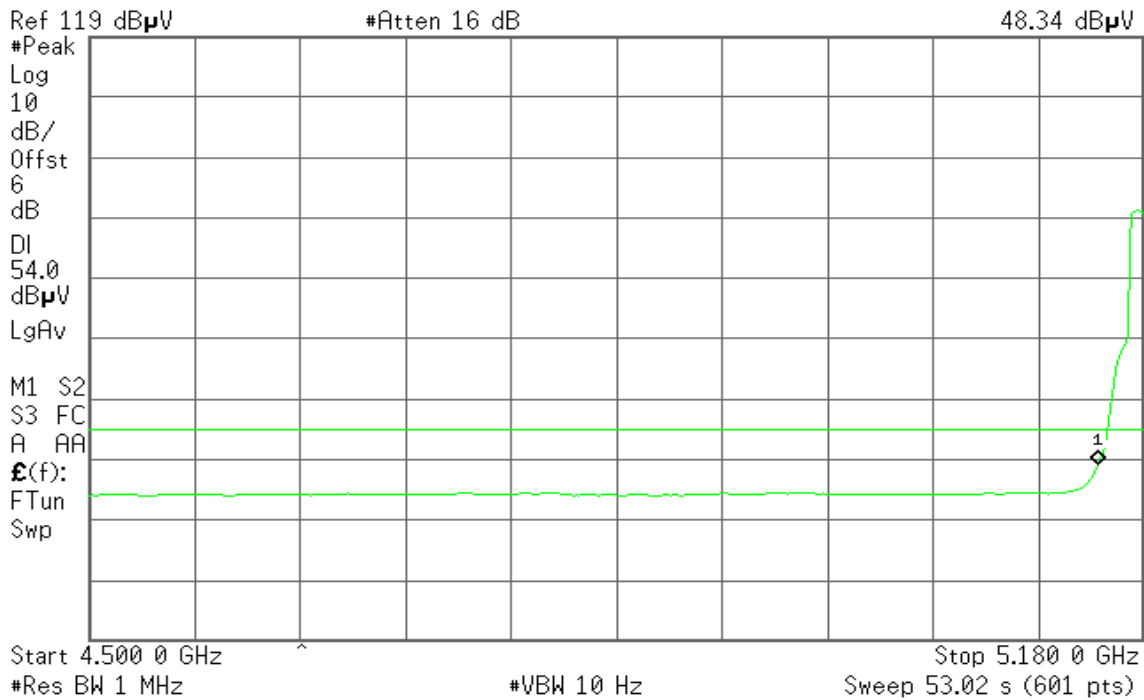



Band Edges (IEEE 802.11a mode / 5320 MHz)

Detector mode: Peak

Polarity: Vertical

Agilent 14:26:04 Jul 26, 2010

R T

Mkr1 5.350 0 GHz
64.07 dB μ V

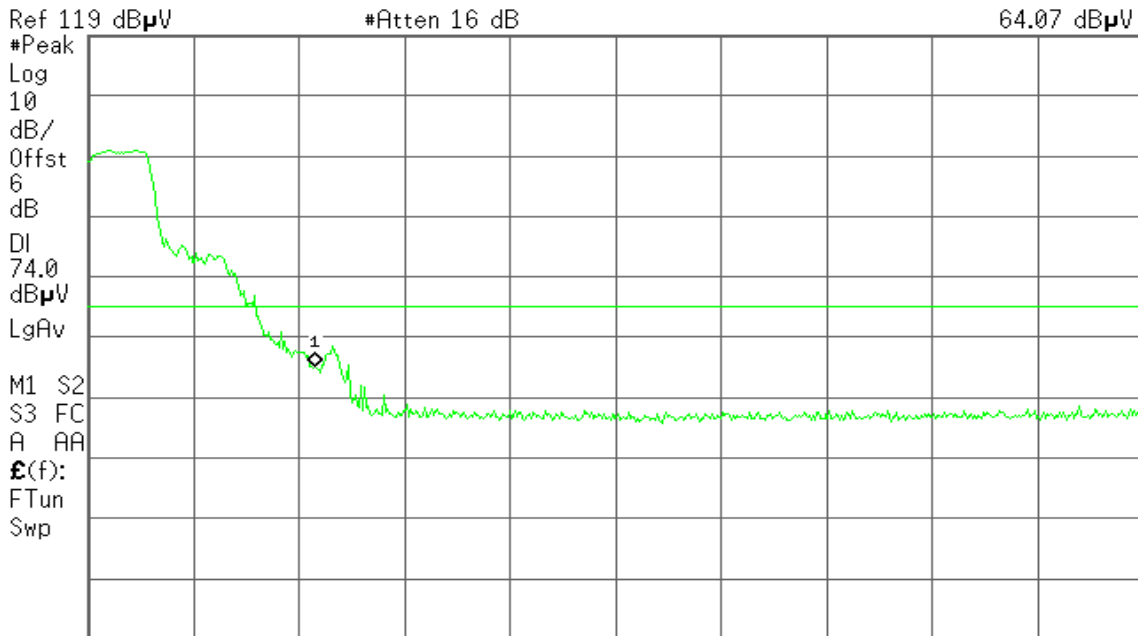

Start 5.320 0 GHz

#Res BW 1 MHz

#VBW 1 MHz

Stop 5.460 0 GHz
#Sweep 100 ms (601 pts)

Detector mode: Average

Polarity: Vertical

Agilent 14:26:40 Jul 26, 2010

R T

Mkr1 5.350 0 GHz
46.56 dB μ V

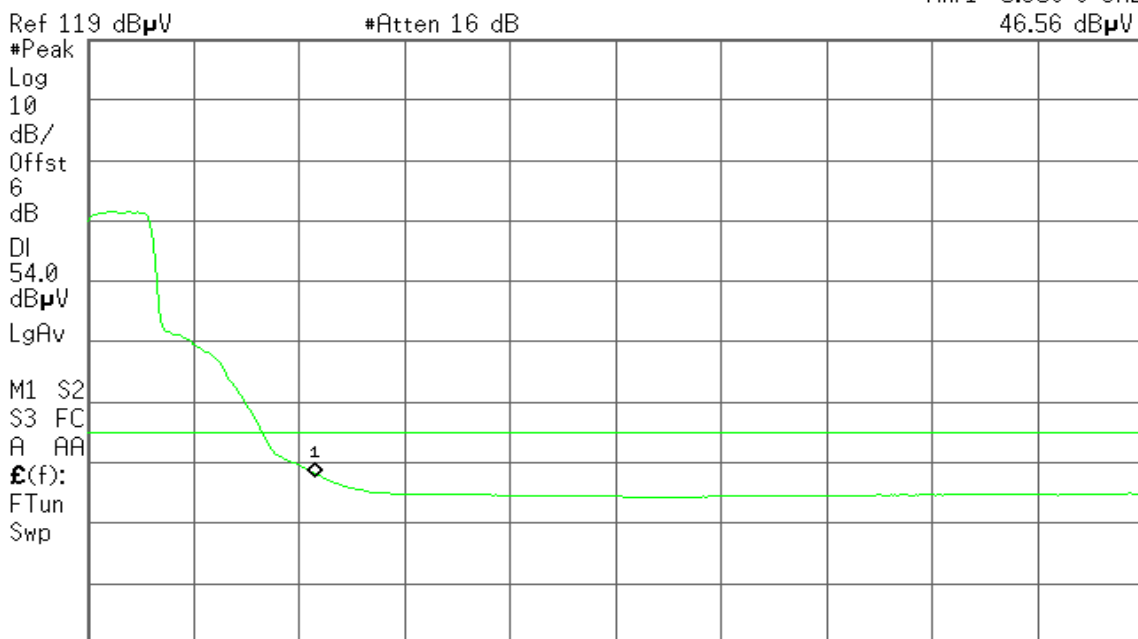

Start 5.320 0 GHz

#Res BW 1 MHz

#VBW 10 Hz

Stop 5.460 0 GHz
Sweep 10.92 s (601 pts)



Detector mode: Peak

Polarity: Horizontal

Agilent 14:21:27 Jul 26, 2010

R T

Mkr1 5.350 0 GHz
60.67 dB μ V

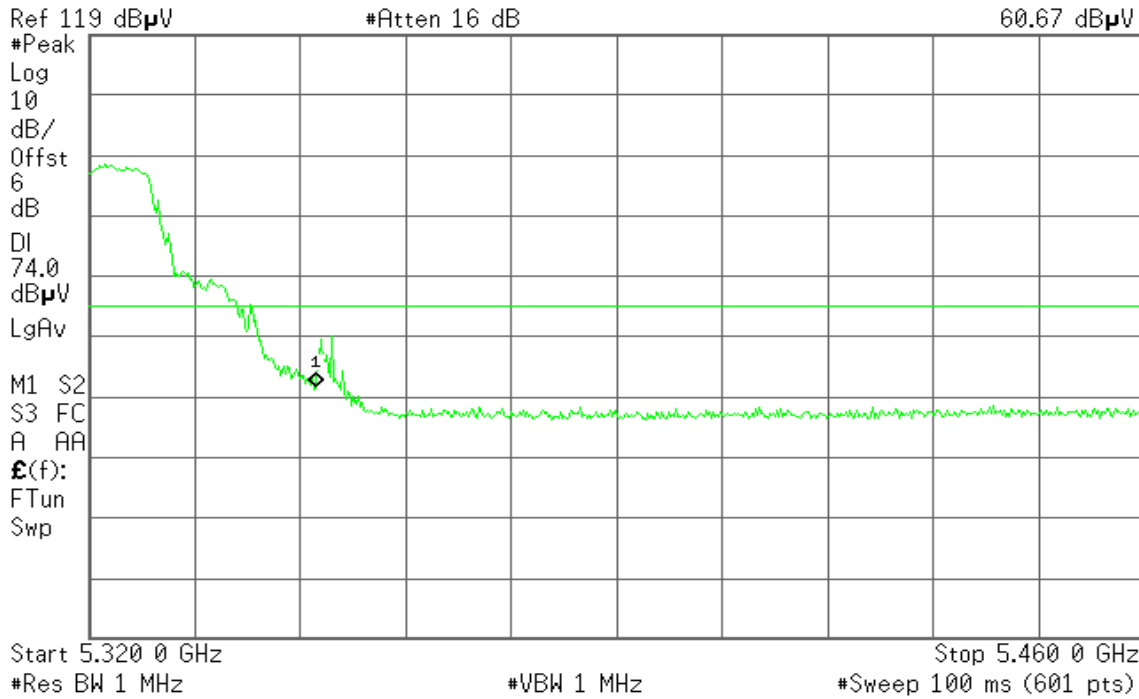

Detector mode: Average

Polarity: Horizontal

Agilent 14:22:41 Jul 26, 2010

R T

Mkr1 5.350 0 GHz
44.95 dB μ V

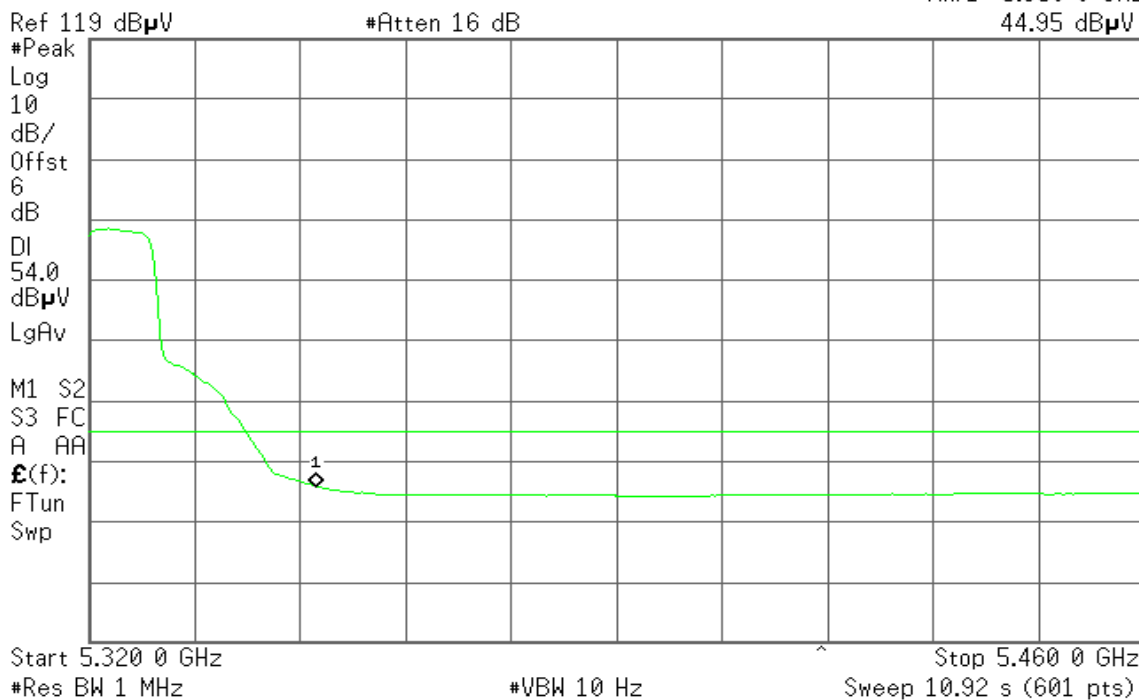



Band Edges (draft 802.11n Standard-20 MHz Channel mode / 5180 MHz)

Detector mode: Peak

Polarity: Vertical

Agilent 12:41:31 Jul 26, 2010

R T

Mkr1 5.150 0 GHz
66.93 dB μ V

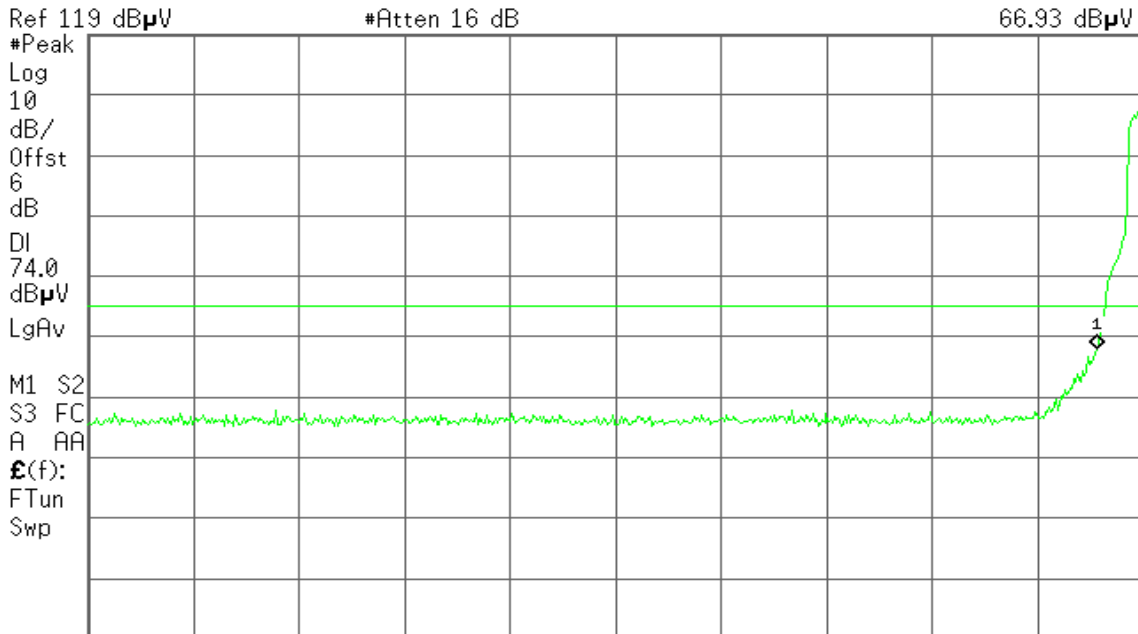

Start 4.500 0 GHz #Res BW 1 MHz #VBW 1 MHz Stop 5.180 0 GHz #Sweep 100 ms (601 pts)

Detector mode: Average

Polarity: Vertical

Agilent 12:45:38 Jul 26, 2010

R T

Mkr1 5.150 0 GHz
53.02 dB μ V

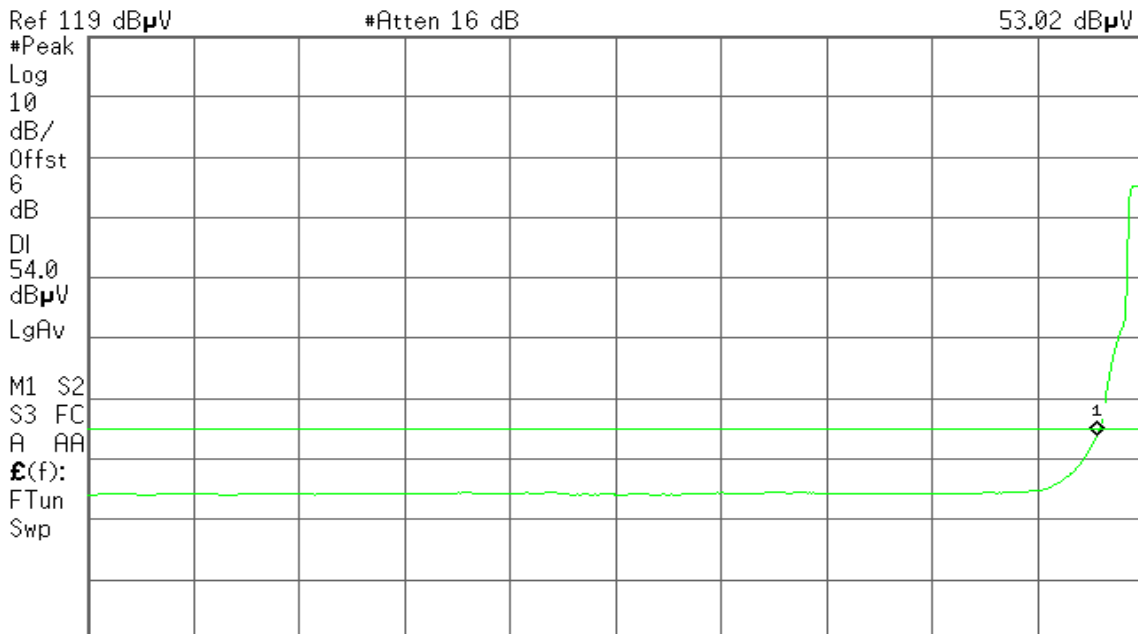

Start 4.500 0 GHz #Res BW 1 MHz #VBW 10 Hz Sweep 53.02 s (601 pts)



Detector mode: Peak

Polarity: Horizontal

Agilent 12:36:12 Jul 26, 2010

R T

Mkr1 5.150 0 GHz
64.17 dB μ V

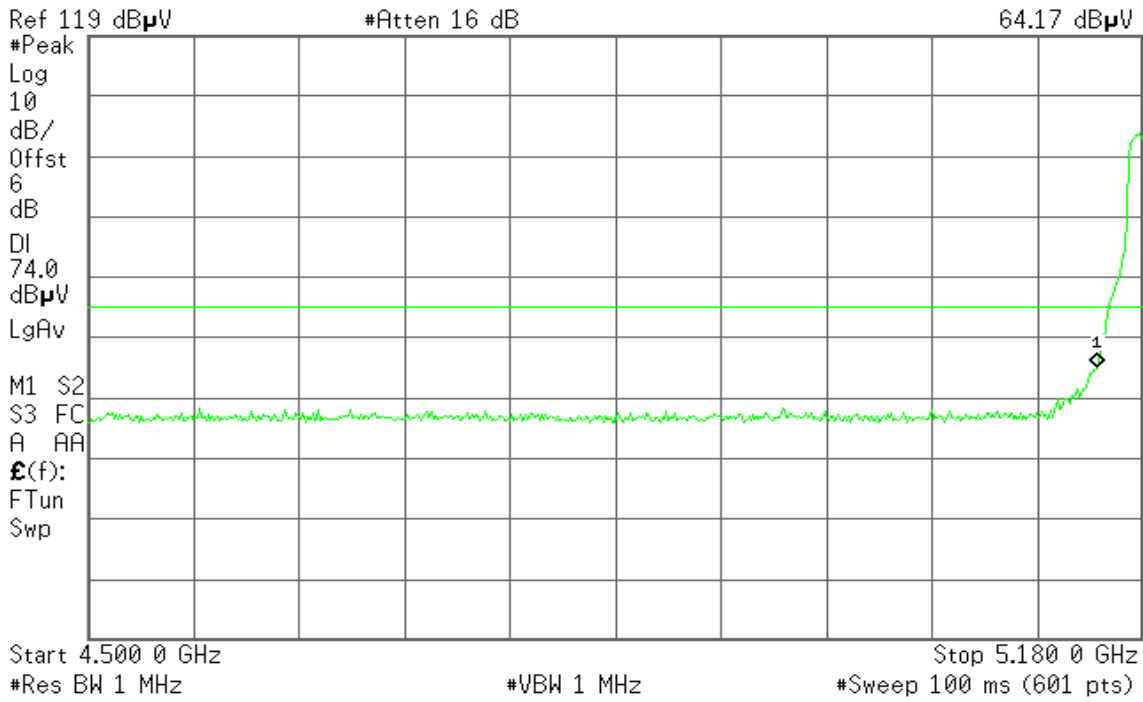

Detector mode: Average

Polarity: Horizontal

Agilent 12:37:25 Jul 26, 2010

R T

Mkr1 5.150 0 GHz
50.22 dB μ V

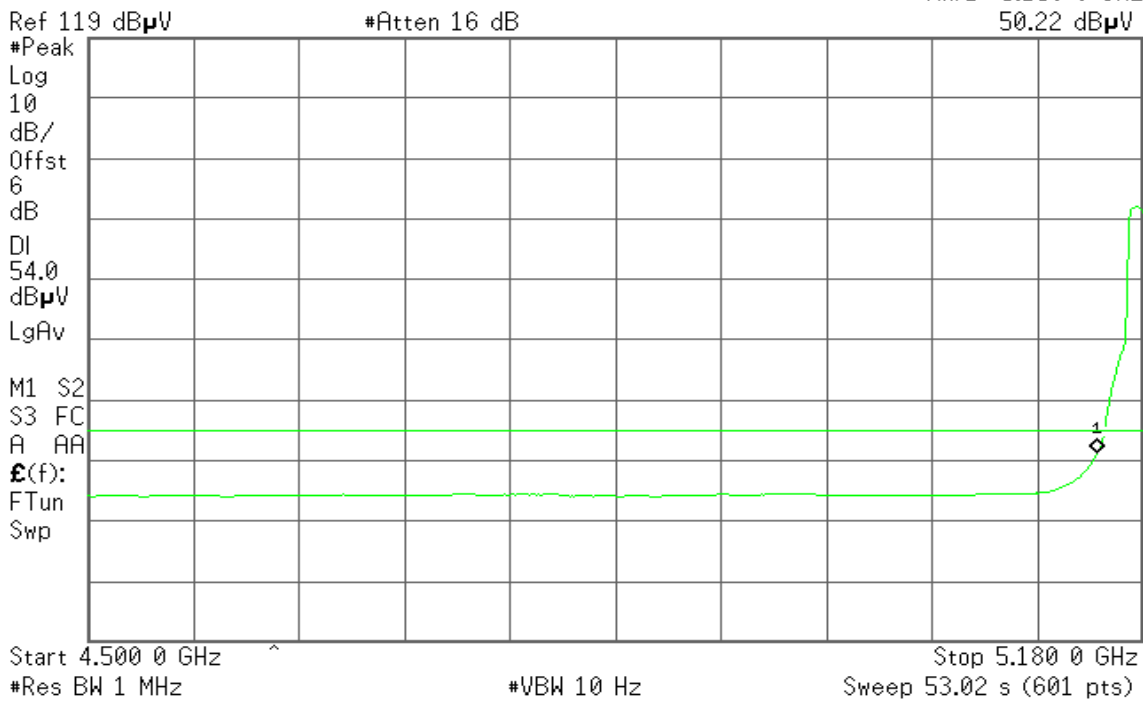



Band Edges (draft 802.11n Standard-20 MHz Channel mode / 5320 MHz)

Detector mode: Peak

Polarity: Vertical

Agilent 14:08:04 Jul 26, 2010

R T

Mkr1 5.350 0 GHz
66.31 dBµV

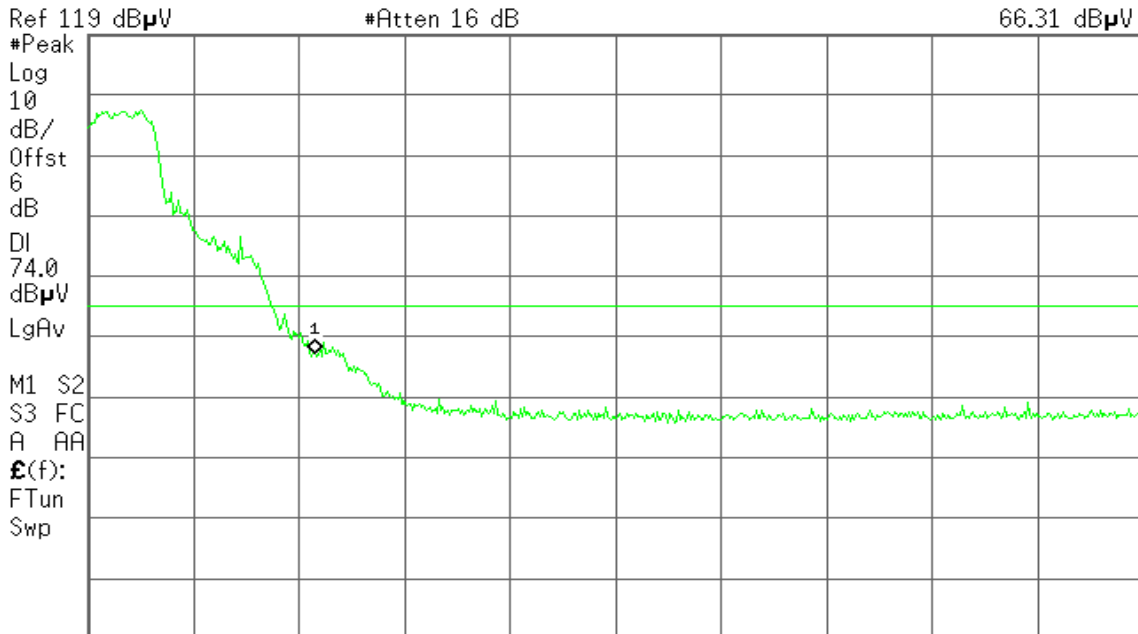

Start 5.320 0 GHz #Res BW 1 MHz #VBW 1 MHz Stop 5.460 0 GHz #Sweep 100 ms (601 pts)

Detector mode: Average

Polarity: Vertical

Agilent 14:08:43 Jul 26, 2010

R T

Mkr1 5.350 0 GHz
49.21 dBµV

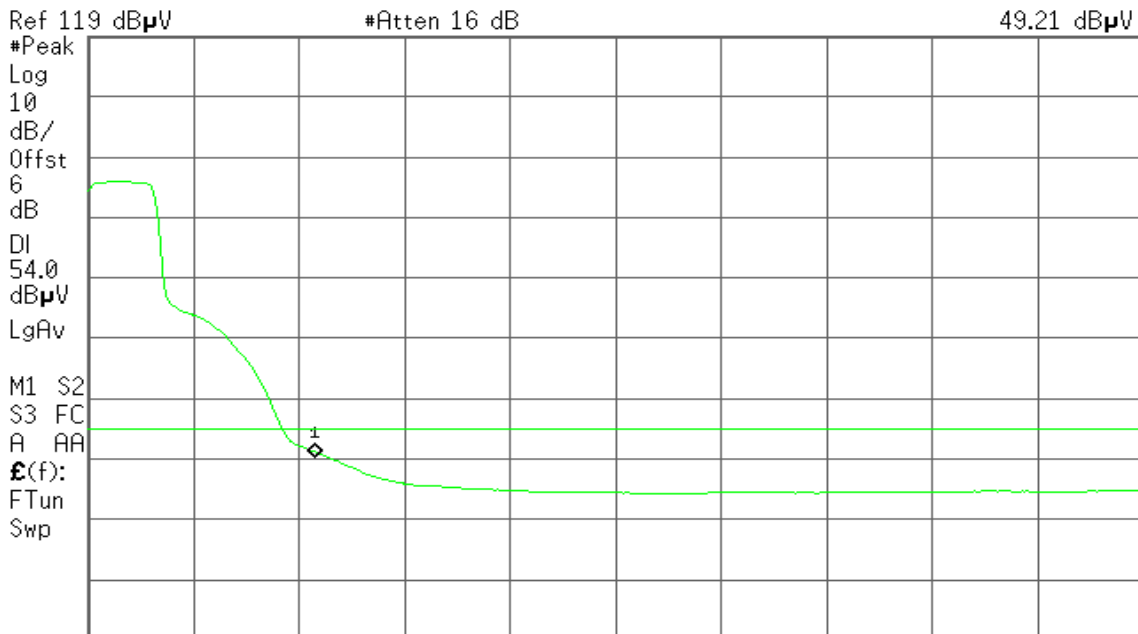

Start 5.320 0 GHz #Res BW 1 MHz #VBW 10 Hz Sweep 10.92 s (601 pts)



Detector mode: Peak

Polarity: Horizontal

Agilent 14:14:16 Jul 26, 2010

R T

Mkr1 5.350 0 GHz
64.95 dB μ V

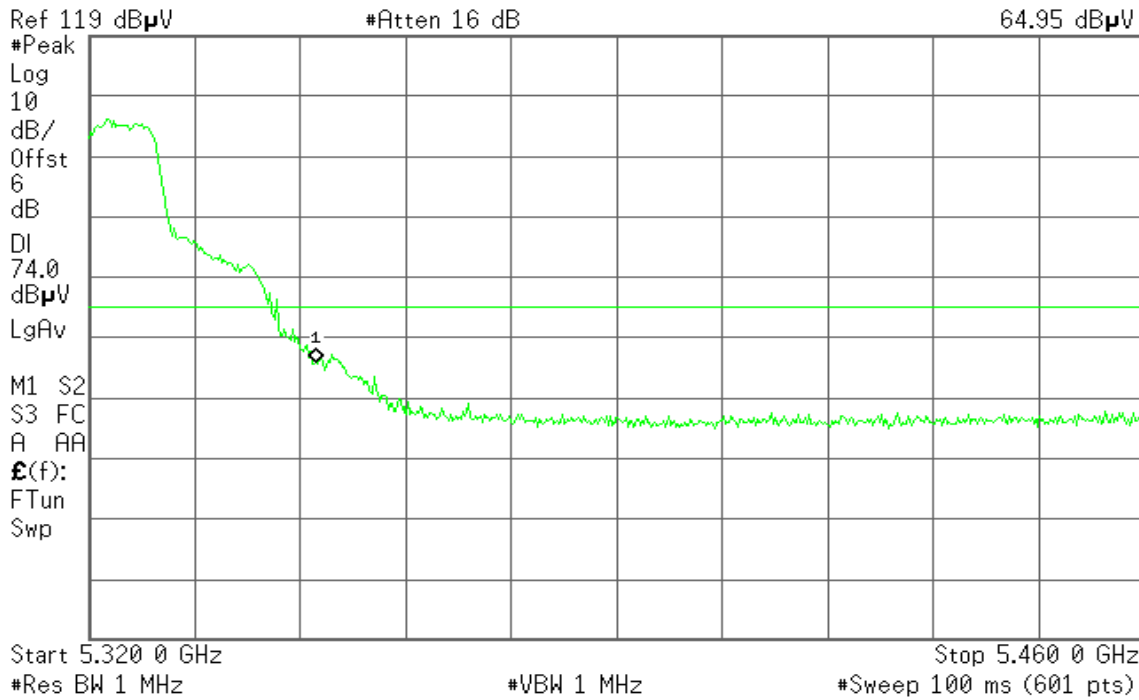

Detector mode: Average

Polarity: Horizontal

Agilent 14:14:57 Jul 26, 2010

R T

Mkr1 5.350 0 GHz
49.23 dB μ V

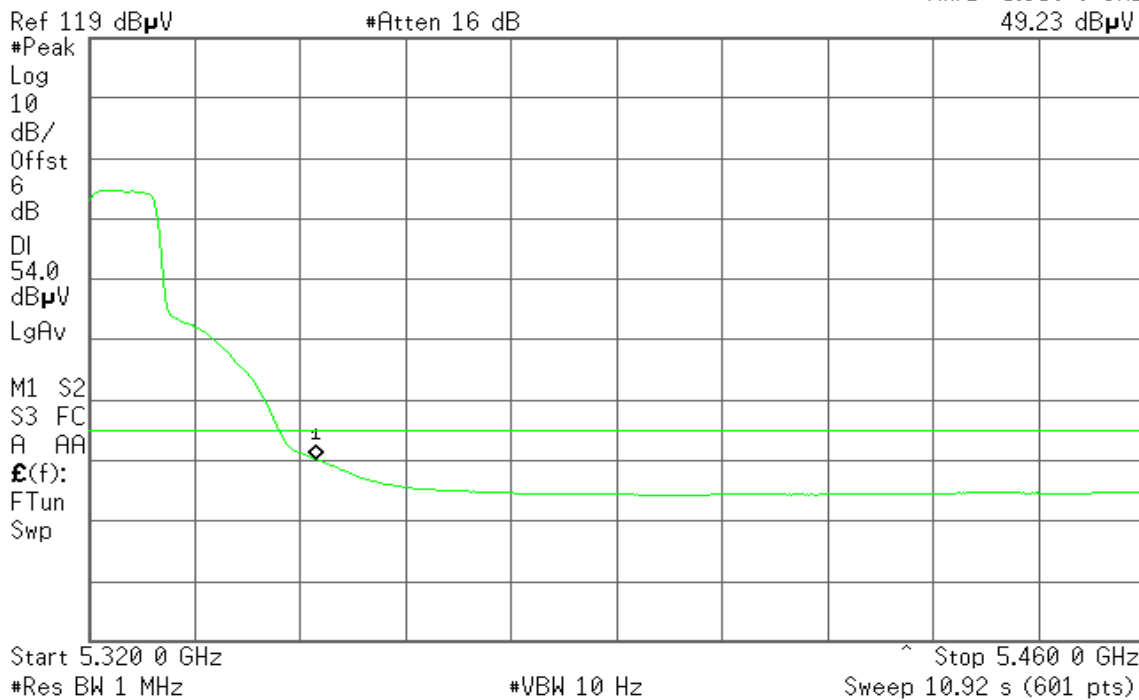



Band Edges (draft 802.11n Wide-40 MHz Channel mode / 5190 MHz)

Detector mode: Peak

Polarity: Vertical

Agilent 15:49:02 Jul 26, 2010

R T

Mkr1 5.150 0 GHz
68.31 dB μ V

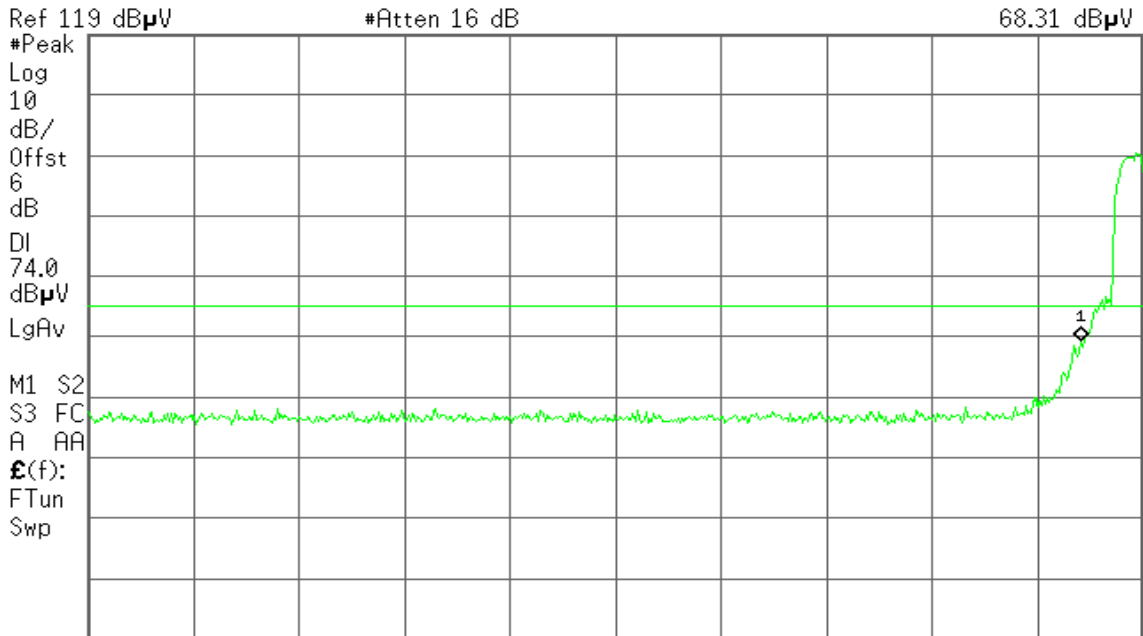

Start 4.500 0 GHz

#Res BW 1 MHz

#VBW 1 MHz

Stop 5.190 0 GHz
#Sweep 100 ms (601 pts)

Detector mode: Average

Polarity: Vertical

Agilent 15:48:01 Jul 26, 2010

R T

Mkr1 5.150 0 GHz
52.82 dB μ V

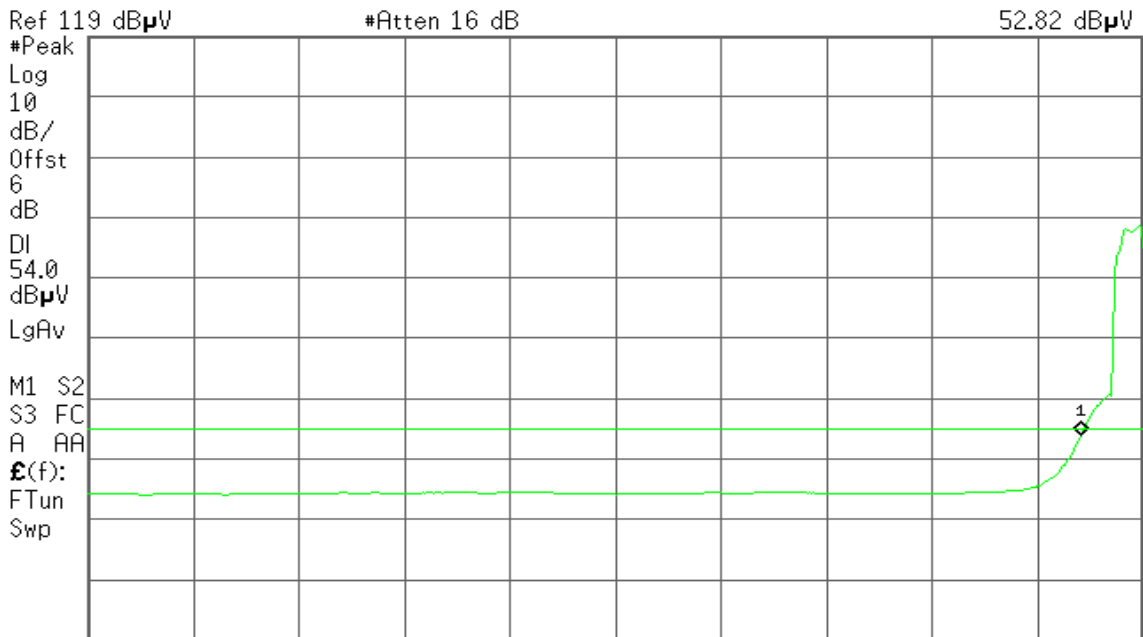

Start 4.500 0 GHz

#Res BW 1 MHz

#VBW 10 Hz

Stop 5.190 0 GHz
Sweep 53.8 s (601 pts)



Detector mode: Peak

Polarity: Horizontal

Agilent 15:51:46 Jul 26, 2010

R T

Mkr1 5.150 0 GHz
63.38 dB μ V

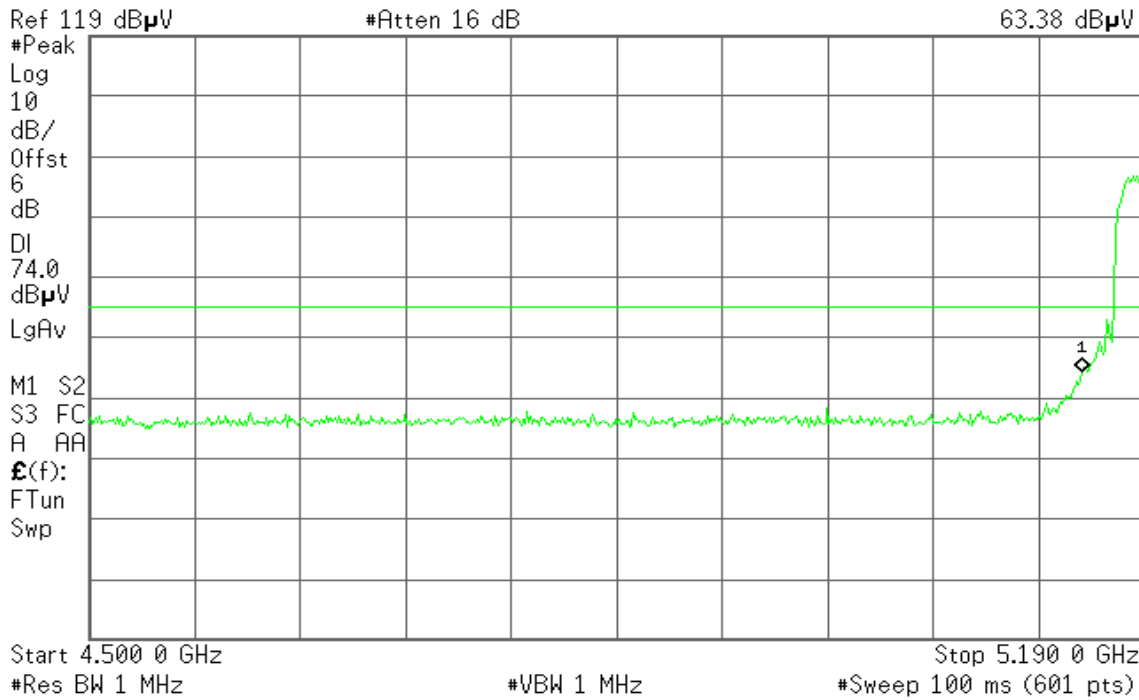

Detector mode: Average

Polarity: Horizontal

Agilent 15:53:42 Jul 26, 2010

R T

Mkr1 5.150 0 GHz
48.87 dB μ V

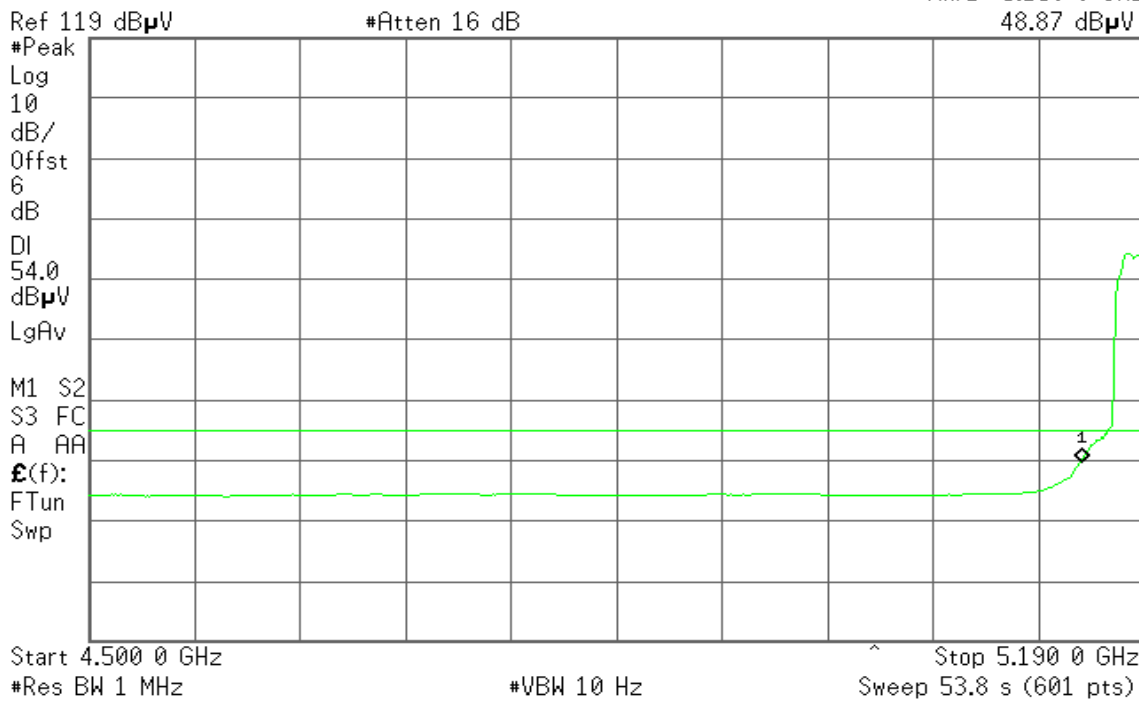



Band Edges (draft 802.11n Wide-40 MHz Channel mode / CH 5310 MHz)

Detector mode: Peak

Polarity: Vertical

Agilent 15:29:39 Jul 26, 2010

R T

Mkr1 5.350 0 GHz
71.41 dB μ V

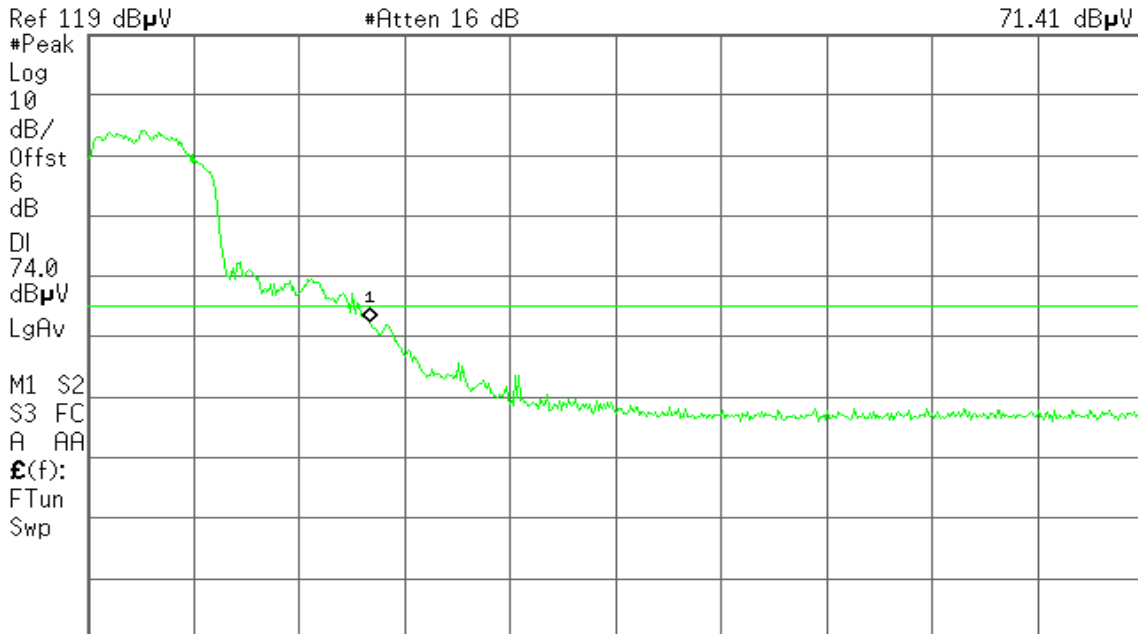

Start 5.310 0 GHz #Res BW 1 MHz #VBW 1 MHz #Sweep 100 ms (601 pts) Stop 5.460 0 GHz

Detector mode: Average

Polarity: Vertical

Agilent 15:32:59 Jul 26, 2010

T

Mkr1 5.350 0 GHz
51.78 dB μ V



Start 5.310 0 GHz #Res BW 1 MHz #VBW 10 Hz Sweep 11.7 s (601 pts) Stop 5.460 0 GHz



Detector mode: Peak

Polarity: Horizontal

Agilent 15:37:03 Jul 26, 2010

R T

Mkr1 5.350 0 GHz
66.06 dB μ V

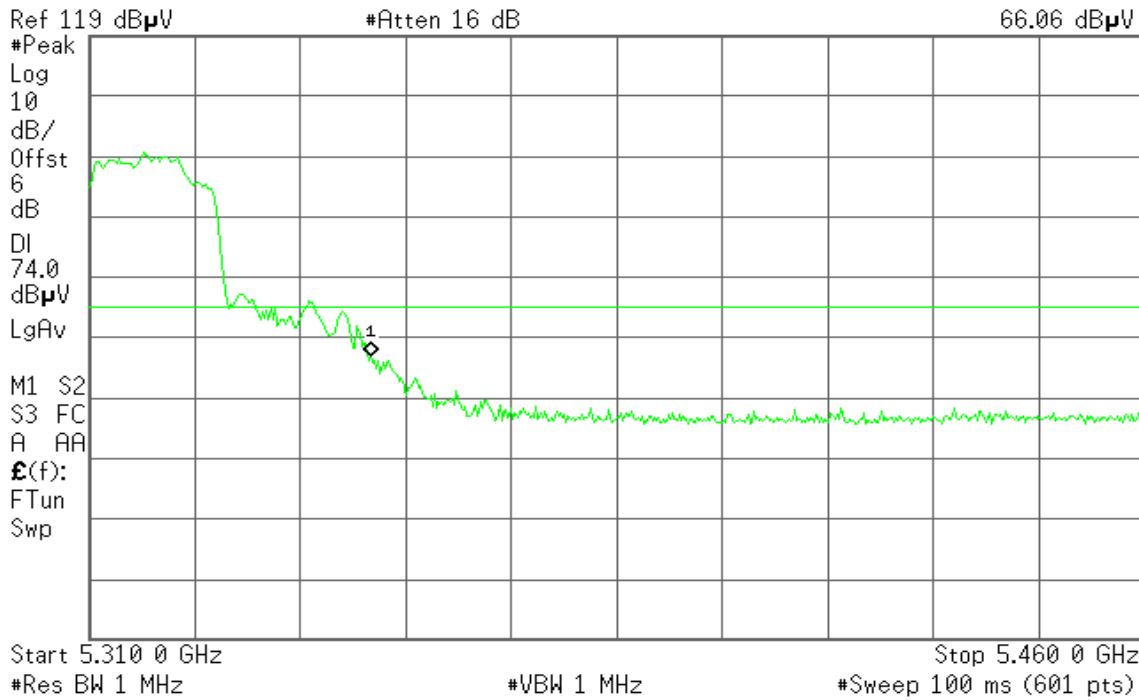

Detector mode: Average

Polarity: Horizontal

Agilent 15:37:38 Jul 26, 2010

R T

Mkr1 5.350 0 GHz
50.59 dB μ V

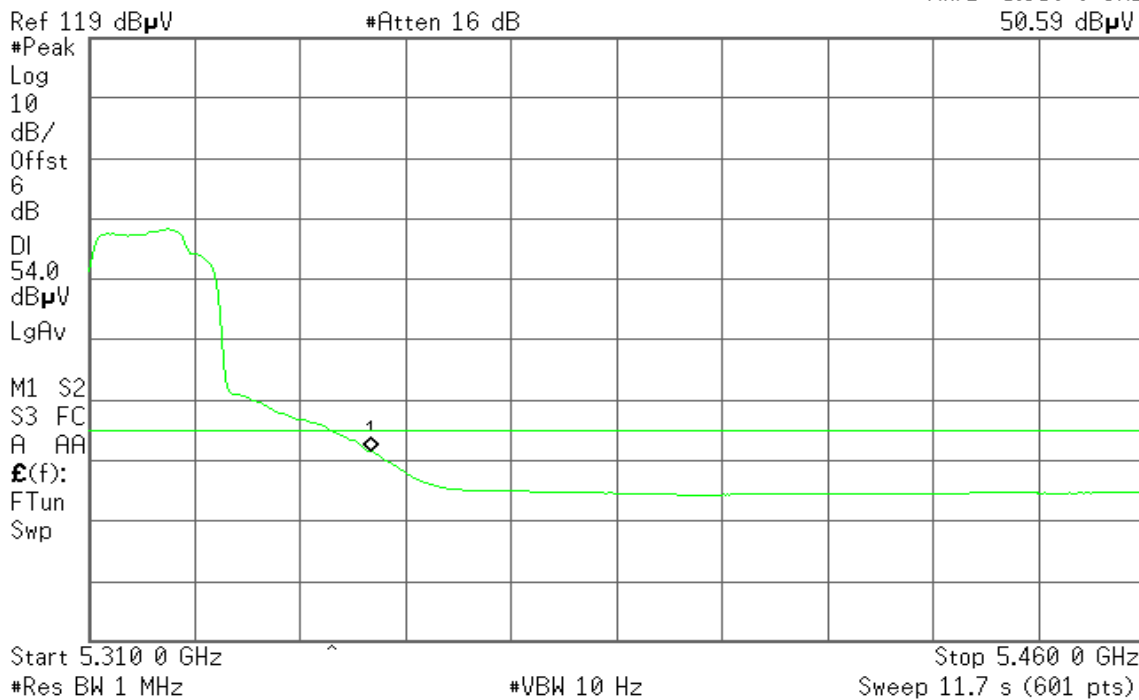



7.4 PEAK POWER SPECTRAL DENSITY

LIMIT

According to §15.407(a),

- (1) For the band 5.15-5.25 GHz, the peak power spectral density shall not exceed 4dBm in any 1MHz band.
- (2) For the band 5.25-5.35 GHz and 5.47-5.725 GHz bands, the peak power spectral density shall not exceed 11dBm in any 1MHz band.

If transmitting antennas of directional gain greater than 6dBi are used, both the peak transmit power and the peak power spectral density shall be reduced by the amount in dB that the directional gain of the antenna exceeds 6dBi.

Test Configuration

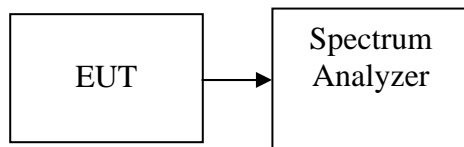

TEST PROCEDURE

1. Place the EUT on the table and set it in transmitting mode.
Remove the antenna from the EUT and then connect a low loss RF cable from the antenna port to the spectrum analyzer.
2. Set the spectrum analyzer as RBW = 1MHz, VBW = 3MHz, Span = Sweep= AUTO
3. Record the max. reading.
4. Repeat the above procedure until the measurements for all frequencies are completed

TEST RESULTS

No non-compliance noted



Test Data

Test mode: IEEE 802.11a mode / 5180 ~ 5240MHz

Channel	Frequency (MHz)	PPSD (dBm)	Limit (dBm)	Margin	Result
Low	5180	3.411	4.00	-0.589	PASS
Mid	5220	2.701	4.00	-1.299	PASS
High	5240	3.074	4.00	-0.926	PASS

Test mode: draft 802.11n Standard-20 MHz Channel mode / 5180 ~ 5240MHz

Channel	Frequency (MHz)	PPSD (dBm)	Limit (dBm)	Margin	Result
Low	5180	-0.611	4.00	-4.611	PASS
Mid	5220	-0.913	4.00	-4.913	PASS
High	5240	-1.204	4.00	-5.204	PASS

Test mode: draft 802.11n Wide-40 MHz Channel mode / 5190 ~ 5230MHz

Channel	Frequency (MHz)	PPSD (dBm)	Limit (dBm)	Margin	Result
Low	5190	-0.092	4.00	-4.092	PASS
High	5230	-0.702	4.00	-4.702	PASS



Test mode: IEEE 802.11a mode/ 5260 ~ 5320MHz

Channel	Frequency (MHz)	PPSD (dBm)	Limit (dBm)	Margin	Result
Low	5260	6.552	11.00	-4.45	PASS
Mid	5280	6.897	11.00	-4.10	PASS
High	5320	7.075	11.00	-3.93	PASS

Test mode: draft 802.11n Standard-20 MHz Channel mode / 5260 ~ 5320MHz

Channel	Frequency (MHz)	PPSD (dBm)	Limit (dBm)	Margin	Result
Low	5260	6.710	11.00	-4.29	PASS
Mid	5280	7.207	11.00	-3.79	PASS
High	5320	7.170	11.00	-3.83	PASS

Test mode: draft 802.11n Wide-40 MHz Channel mode / 5270 ~ 5310MHz

Channel	Frequency (MHz)	PPSD (dBm)	Limit (dBm)	Margin	Result
Low	5270	4.263	11.00	-6.737	PASS
High	5310	0.720	11.00	-10.28	PASS



Test mode: IEEE 802.11a mode / 5500 ~ 5700MHz

Channel	Frequency (MHz)	PPSD (dBm)	Limit (dBm)	Margin	Result
Low	5500	7.703	11.00	-3.30	PASS
Mid	5600	7.821	11.00	-3.18	PASS
High	5700	7.680	11.00	-3.32	PASS

Test mode: draft 802.11n Standard-20 MHz Channel mode / 5500 ~ 5700MHz

Channel	Frequency (MHz)	PPSD (dBm)	Limit (dBm)	Margin	Result
Low	5500	6.419	11.00	-4.586	PASS
Mid	5600	6.509	11.00	-4.491	PASS
High	5700	6.654	11.00	-4.35	PASS

Test mode: draft 802.11n Wide-40 MHz Channel mode / 5510 ~ 5670MHz

Channel	Frequency (MHz)	PPSD (dBm)	Limit (dBm)	Margin	Result
Low	5510	4.019	11.00	-6.981	PASS
Mid	5590	4.922	11.00	-6.078	PASS
High	5670	4.598	11.00	-6.402	PASS



Test Plot
IEEE 802.11a mode / 5180 ~ 5240MHz

CH Low

Agilent 17:03:20 Jul 27, 2010

R T

Mkr1 5.176 25 GHz
3.411 dBm

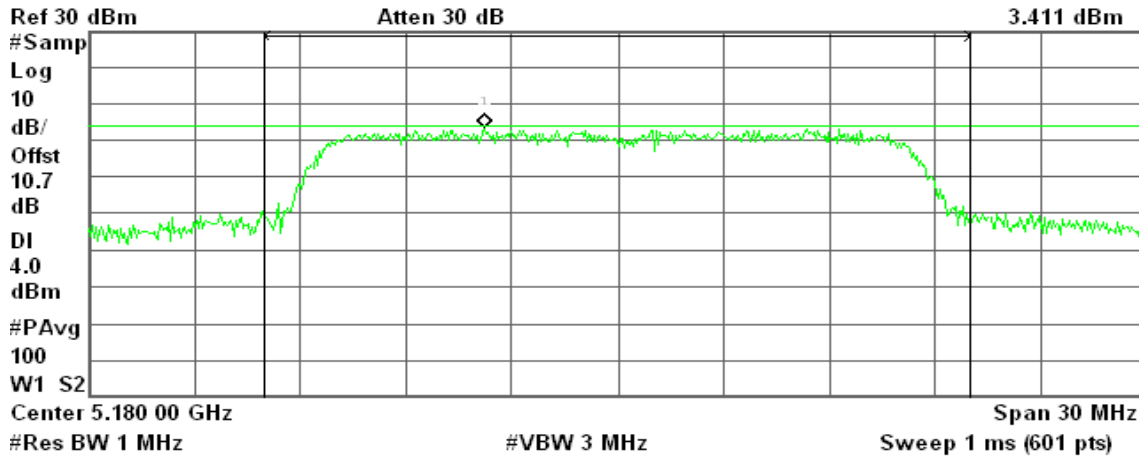

Channel Power

13.19 dBm / 20.0000 MHz

Power Spectral Density

-59.82 dBm/Hz

CH Mid

Agilent 17:11:30 Jul 27, 2010

R L

Mkr1 5.221 65 GHz
2.701 dBm

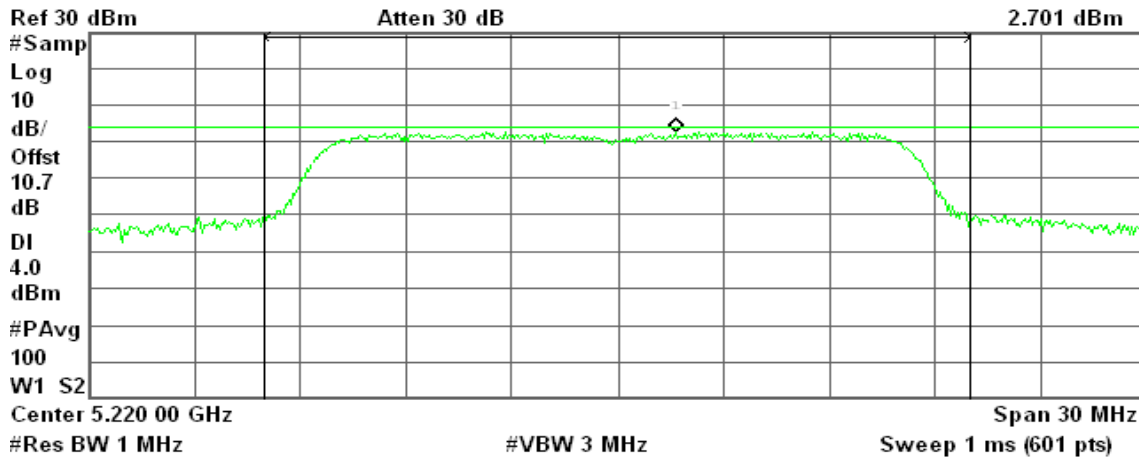

Channel Power

13.17 dBm / 20.0000 MHz

Power Spectral Density

-59.84 dBm/Hz



CH High

Agilent 17:15:32 Jul 27, 2010

R T

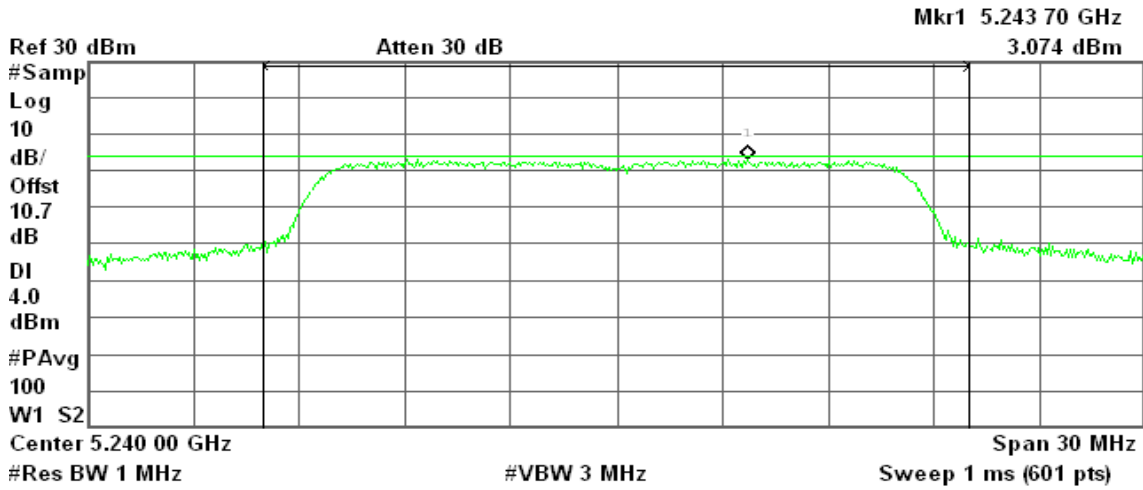

Channel Power

Power Spectral Density

13.80 dBm / 20.0000 MHz

-59.21 dBm/Hz

draft 802.11n Standard-20 MHz Channel mode / 5180 ~ 5240MHz

CH Low

Agilent 14:50:42 Jul 28, 2010

R T

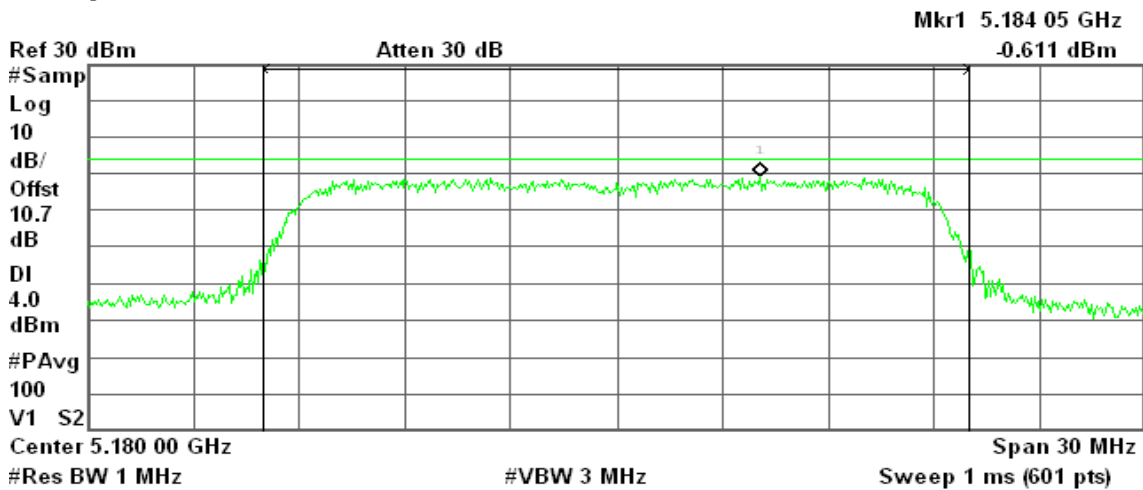

Channel Power

Power Spectral Density

9.24 dBm / 20.0000 MHz

-63.77 dBm/Hz



CH Mid

Agilent 14:52:50 Jul 28, 2010

R T

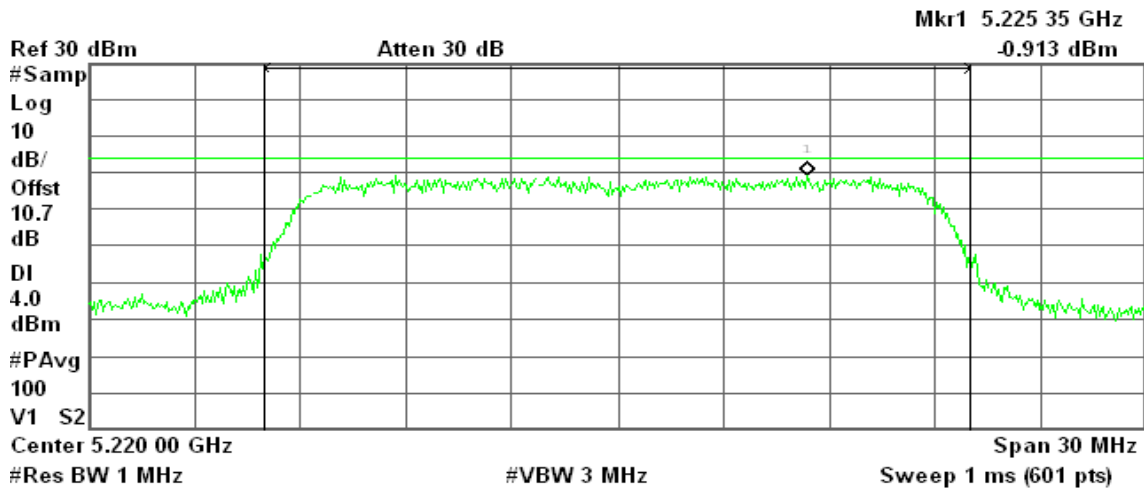

Channel Power

9.17 dBm / 20.0000 MHz

Power Spectral Density

-63.84 dBm/Hz

CH High

Agilent 14:36:26 Jul 28, 2010

R T

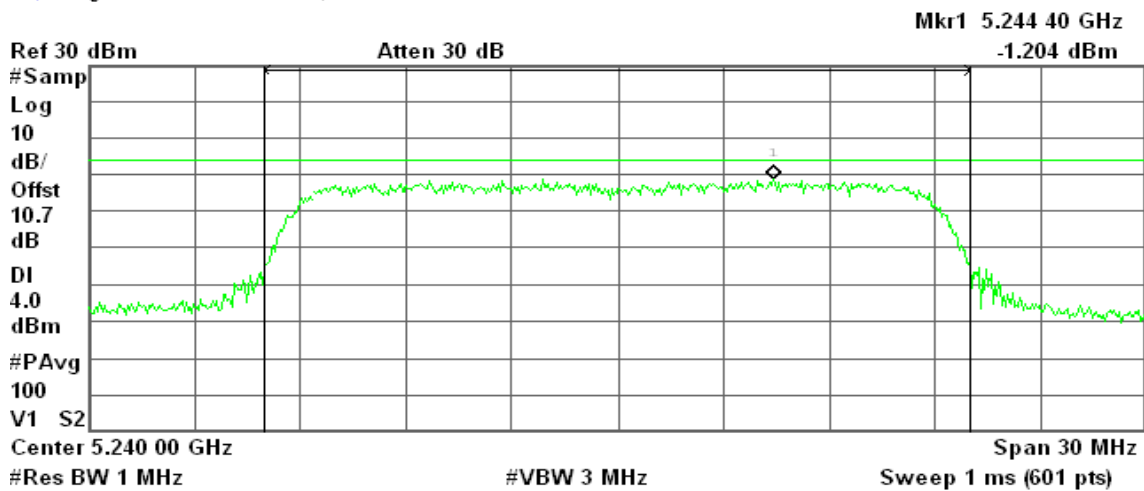

Channel Power

8.47 dBm / 20.0000 MHz

Power Spectral Density

-64.54 dBm/Hz



draft 802.11n Wide-40 MHz Channel mode / 5190 ~ 5230MHz

CH Low

Agilent 16:58:42 Jul 28, 2010

R T

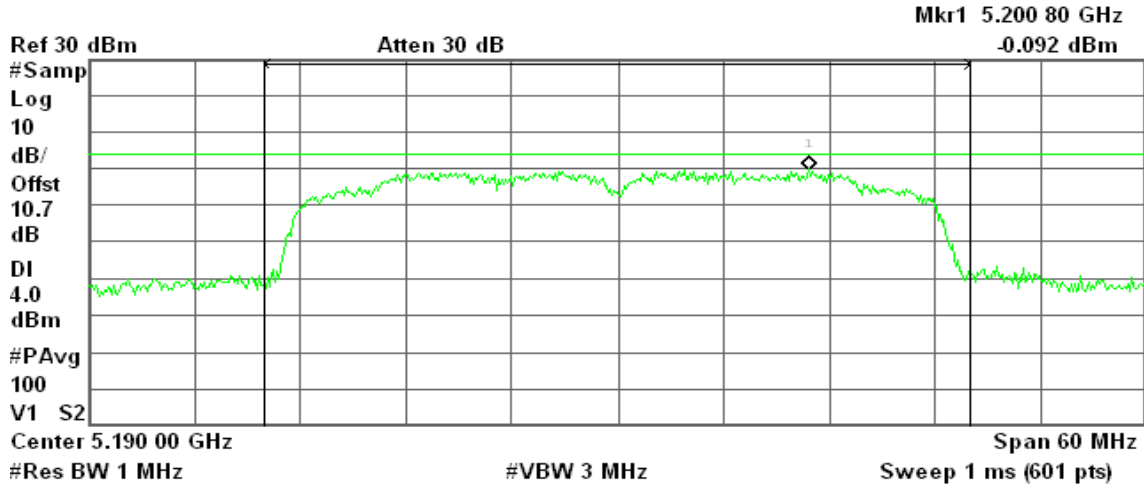

Channel Power

12.88 dBm / 40.0000 MHz

Power Spectral Density

-63.14 dBm/Hz

CH High

Agilent 17:09:12 Jul 28, 2010

R T

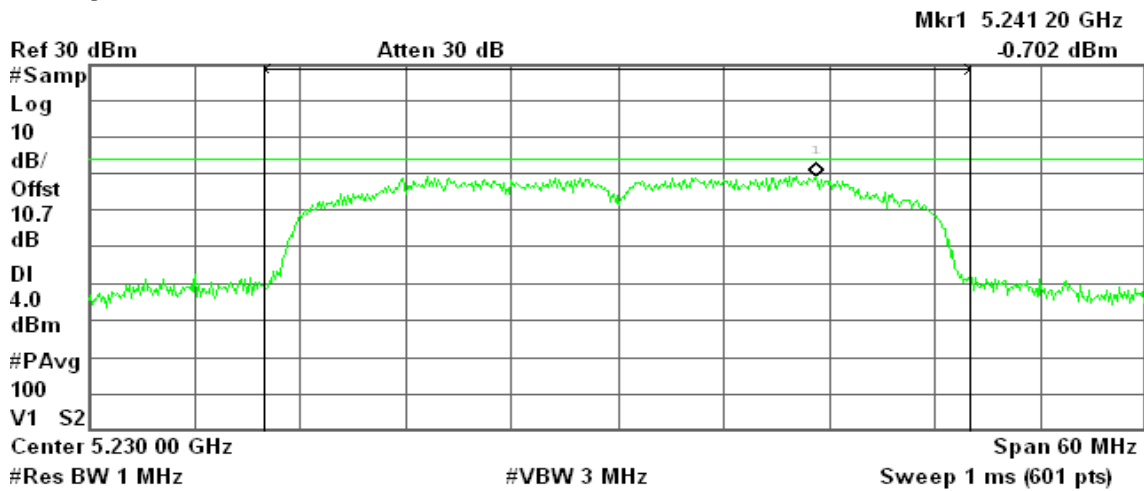

Channel Power

11.27 dBm / 40.0000 MHz

Power Spectral Density

-64.75 dBm/Hz



IEEE 802.11a mode / 5260 ~ 5320MHz

CH Low

Agilent 10:47:20 Jul 28, 2010

R T

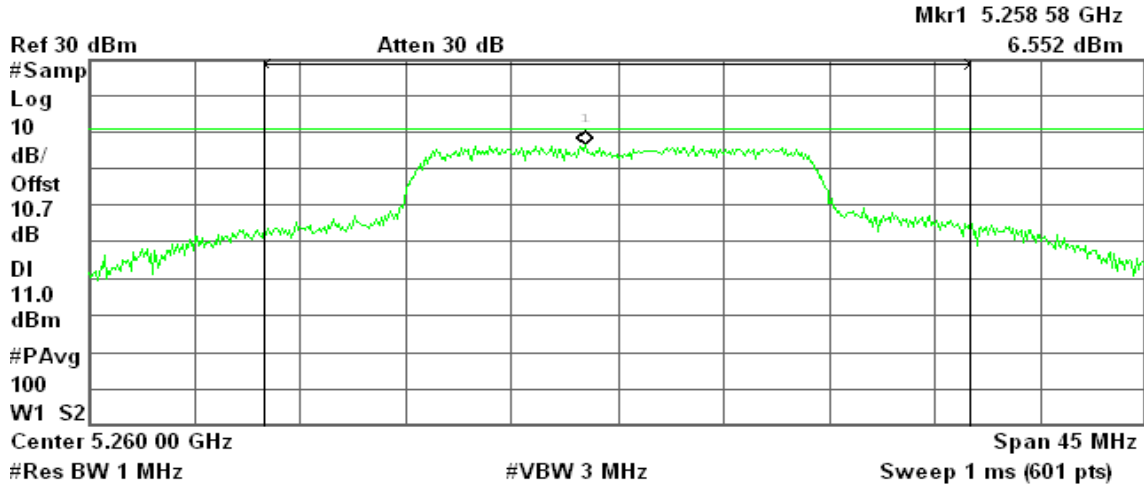

Channel Power

16.46 dBm / 30.0000 MHz

Power Spectral Density

-58.31 dBm/Hz

CH Mid

Agilent 10:42:20 Jul 28, 2010

R T

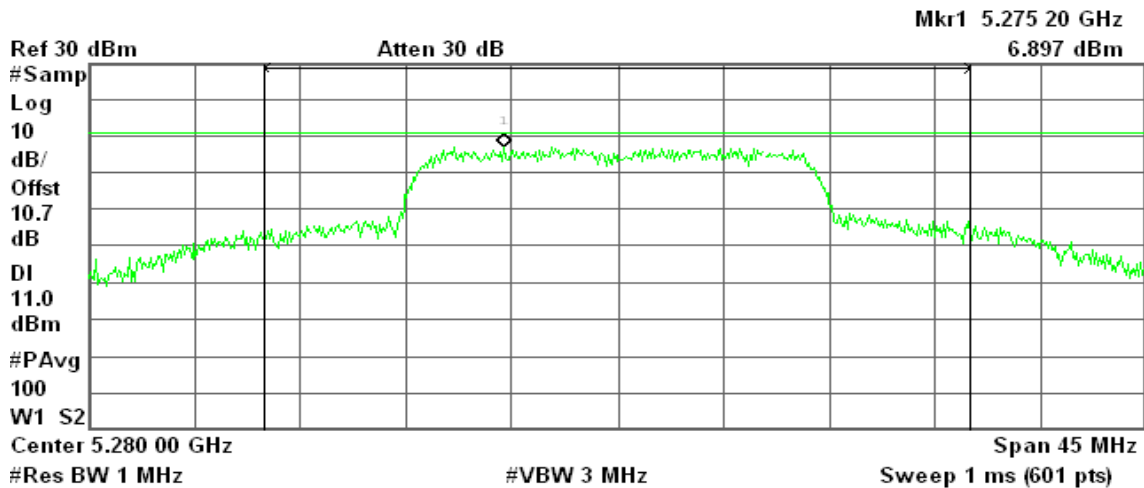

Channel Power

16.68 dBm / 30.0000 MHz

Power Spectral Density

-58.09 dBm/Hz



CH High

Agilent 10:53:45 Jul 28, 2010

R L

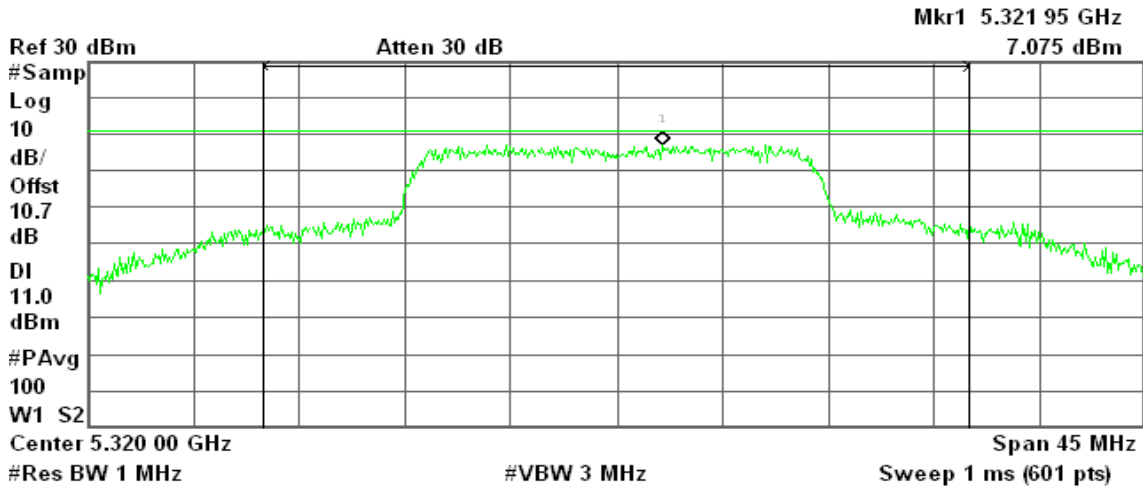

Channel Power

16.95 dBm / 30.0000 MHz

Power Spectral Density

-57.82 dBm/Hz

draft 802.11n Standard-20 MHz Channel mode / 5260 ~ 5320MHz

CH Low

Agilent 14:58:35 Jul 28, 2010

R L

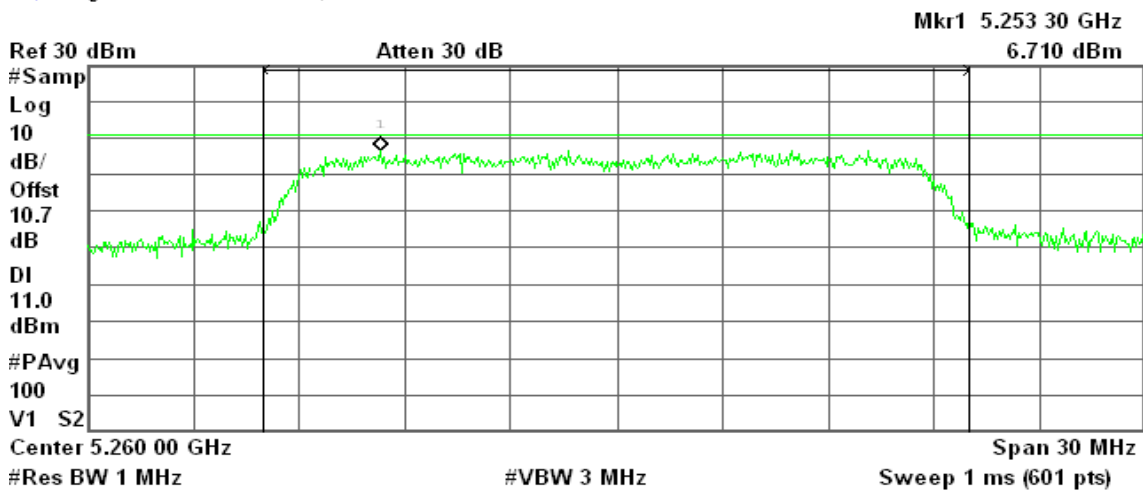

Channel Power

16.10 dBm / 20.0000 MHz

Power Spectral Density

-56.92 dBm/Hz



CH Mid

Agilent 15:01:29 Jul 28, 2010

R T

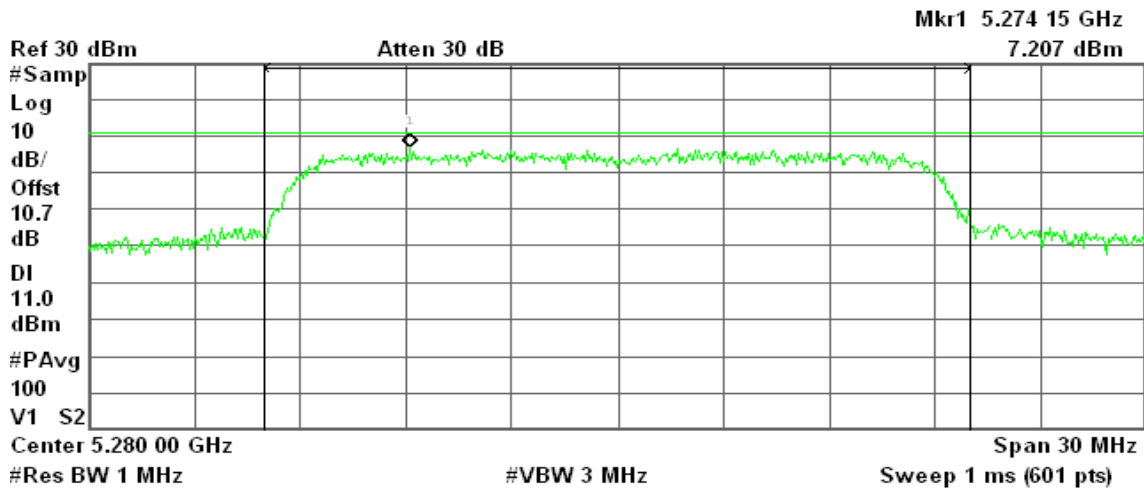

Channel Power

16.10 dBm / 20.0000 MHz

Power Spectral Density

-56.91 dBm/Hz

CH High

Agilent 15:04:15 Jul 28, 2010

R T

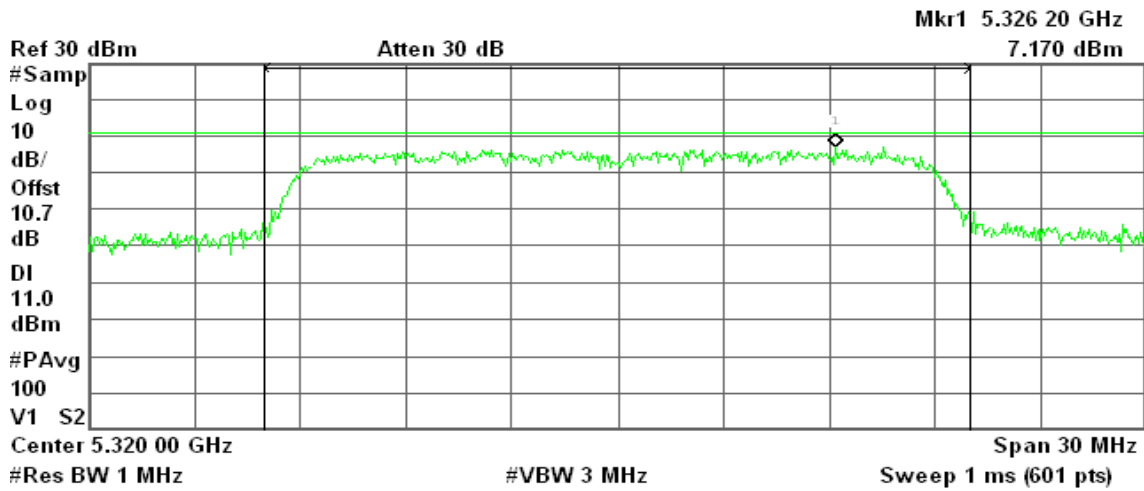

Channel Power

16.81 dBm / 20.0000 MHz

Power Spectral Density

-56.20 dBm/Hz



draft 802.11n Wide-40 MHz Channel mode / 5270 ~ 5310MHz

CH Low

Agilent 16:53:45 Jul 28, 2010

R T

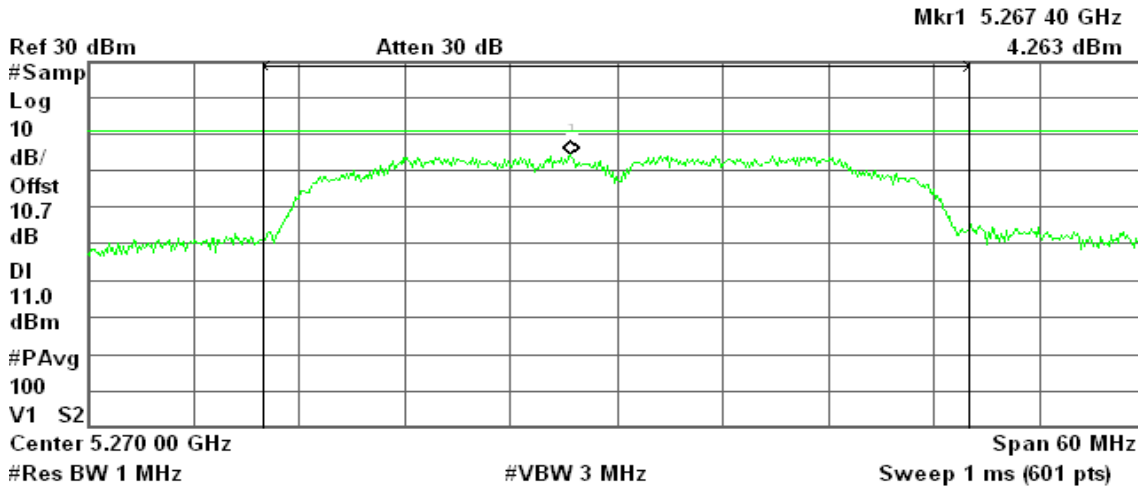

Channel Power

16.68 dBm / 40.0000 MHz

Power Spectral Density

-59.34 dBm/Hz

CH High

Agilent 16:39:39 Jul 28, 2010

R T

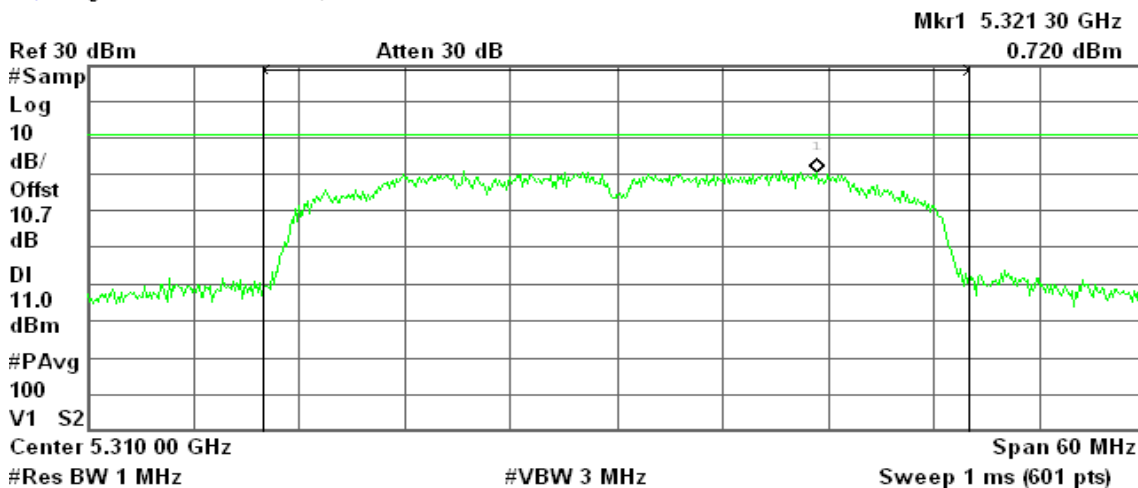

Channel Power

13.29 dBm / 40.0000 MHz

Power Spectral Density

-62.73 dBm/Hz



Test mode: IEEE 802.11a mode / 5500 ~ 5700MHz

CH Low

Agilent 11:00:55 Jul 28, 2010

R T

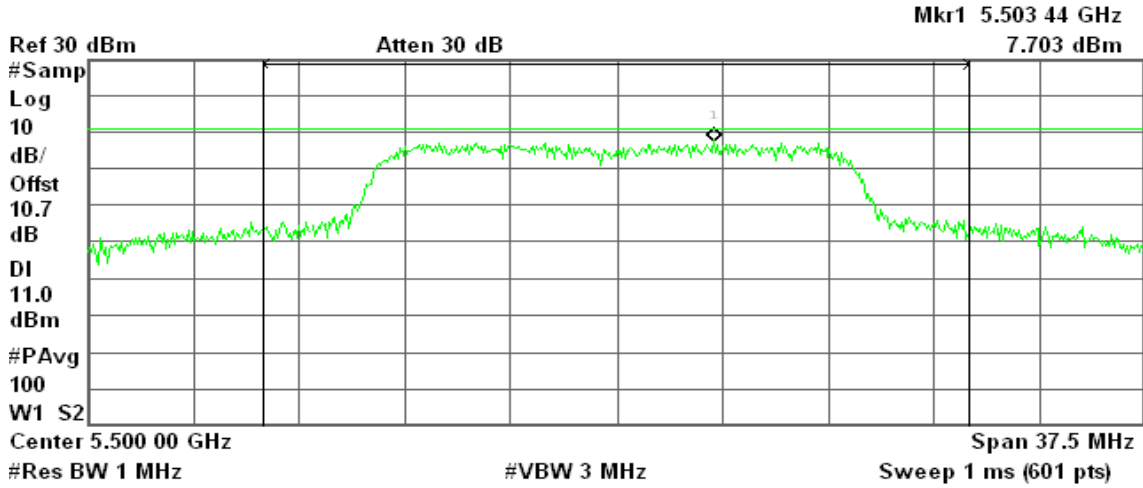

Channel Power

17.29 dBm / 25.0000 MHz

Power Spectral Density

-56.69 dBm/Hz

CH Mid

Agilent 11:03:23 Jul 28, 2010

R T

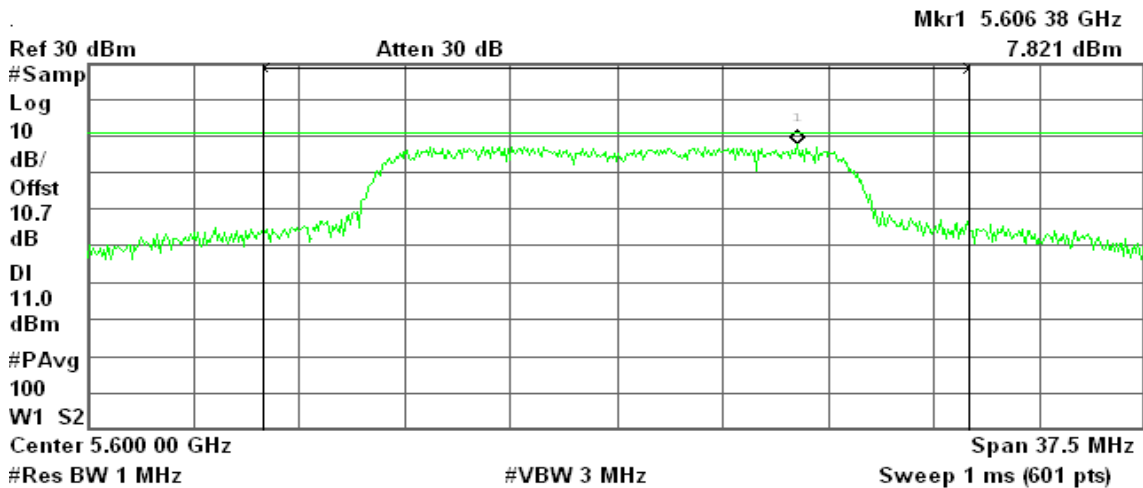

Channel Power

17.09 dBm / 25.0000 MHz

Power Spectral Density

-56.89 dBm/Hz



CH High

Agilent 11:06:05 Jul 28, 2010

R T

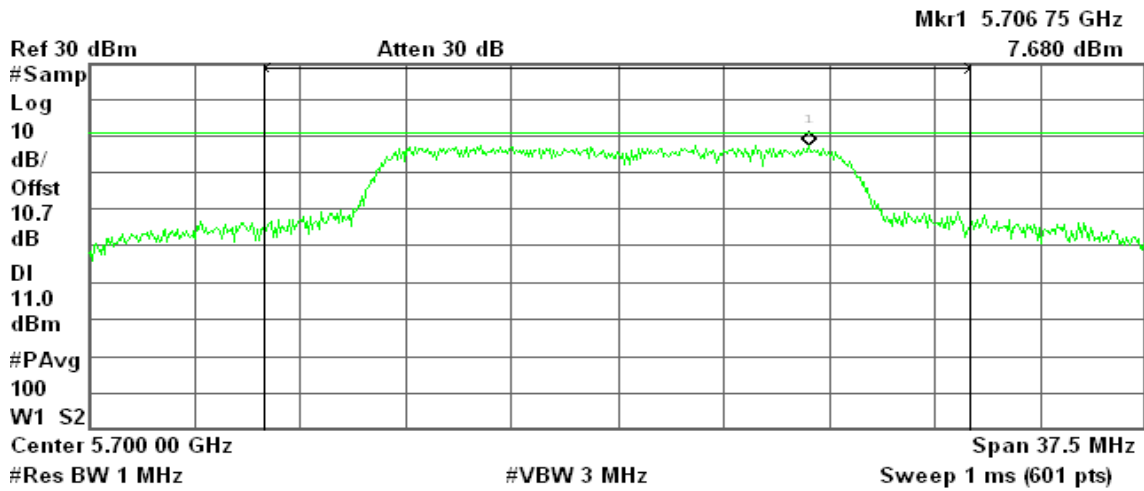

Channel Power

16.88 dBm / 25.0000 MHz

Power Spectral Density

-57.10 dBm/Hz

draft 802.11n Standard-20 MHz Channel mode / 5500 ~ 5700MHz

CH Low

Agilent 15:50:49 Sep 14, 2010

R L

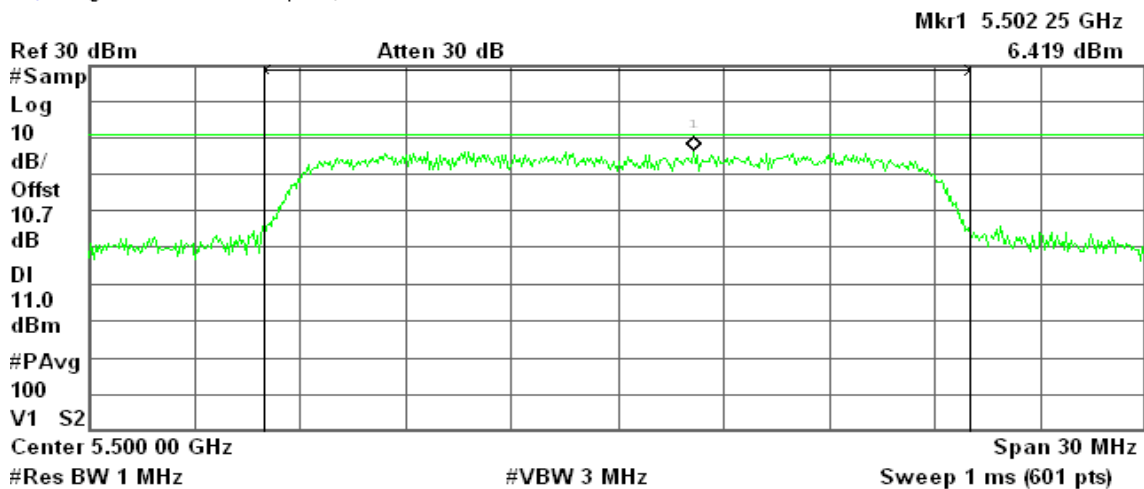

Channel Power

15.70 dBm / 20.0000 MHz

Power Spectral Density

-57.27 dBm/Hz



CH Mid

Agilent 15:11:38 Jul 28, 2010

R T

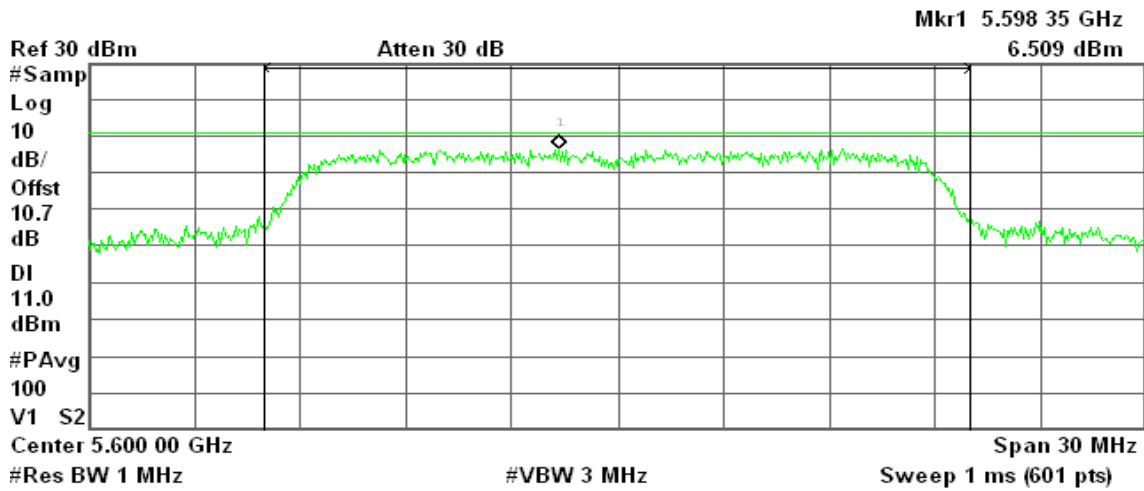

Channel Power

16.64 dBm / 20.0000 MHz

Power Spectral Density

-56.37 dBm/Hz

CH High

Agilent 15:43:22 Sep 14, 2010

R T

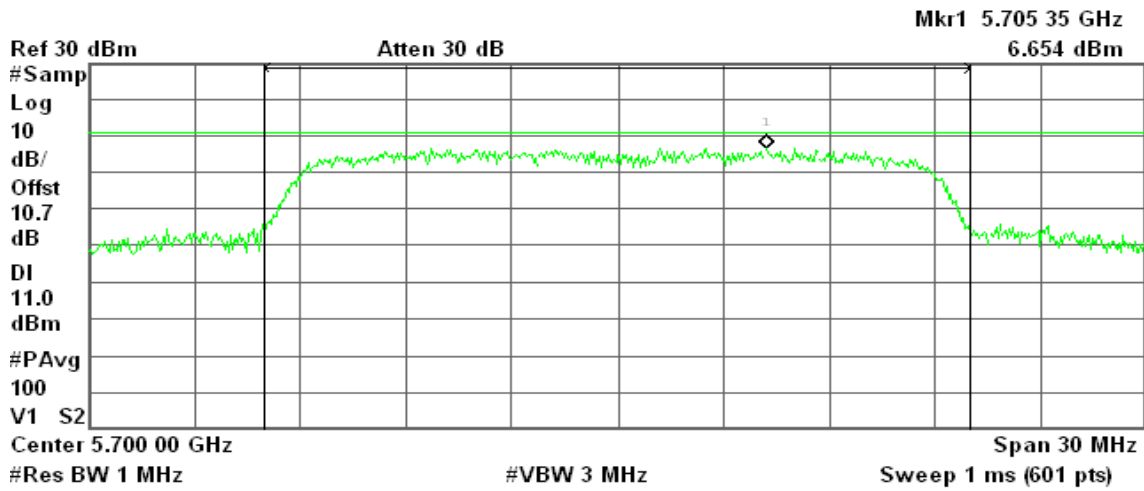

Channel Power

16.70 dBm / 20.0000 MHz

Power Spectral Density

-57.23 dBm/Hz



draft 802.11n Wide-40 MHz Channel mode / 5510 ~ 5670MHz

CH Low

Agilent 17:21:31 Jul 28, 2010

R T

Peak Power Spectral Density, a Mode Low Ch.

Mkr1 5.505 80 GHz

Ref 30 dBm

Atten 30 dB

4.019 dBm

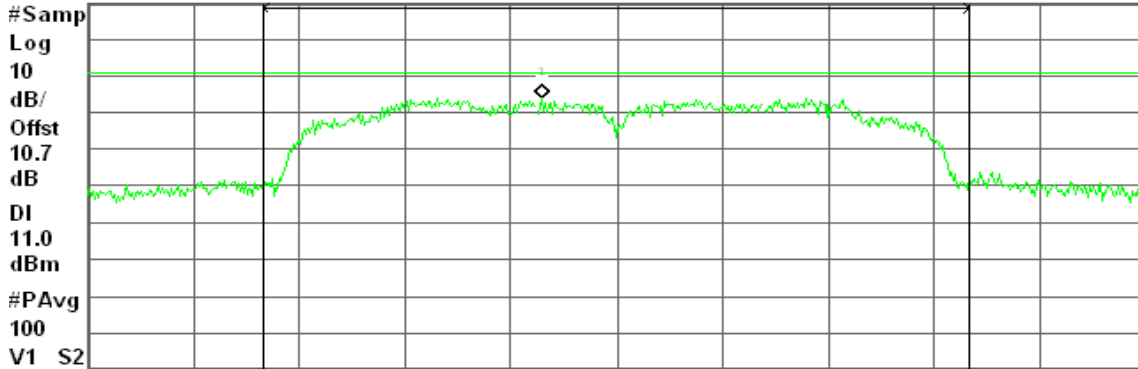

Channel Power

16.37 dBm / 40.0000 MHz

Power Spectral Density

-59.66 dBm/Hz

CH Mid

Agilent 17:24:00 Jul 28, 2010

R T

Ref 30 dBm

Atten 30 dB

Mkr1 5.579 00 GHz

4.922 dBm

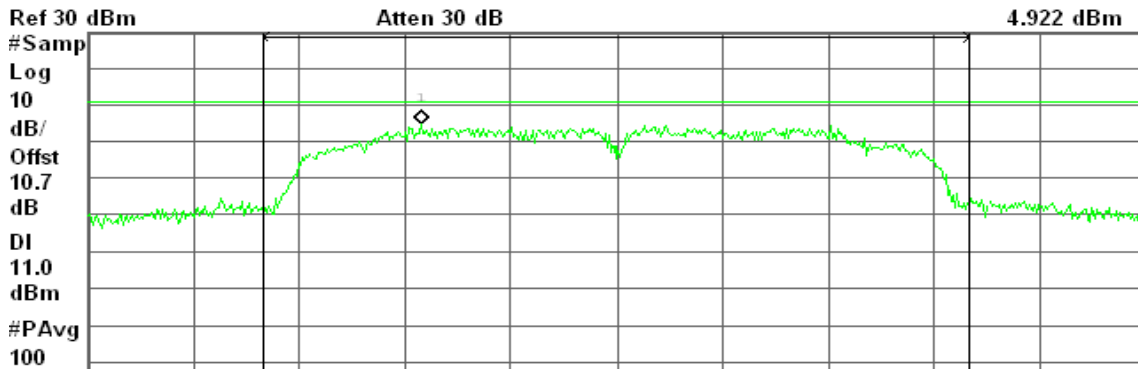

Channel Power

16.65 dBm / 40.0000 MHz

Power Spectral Density

-59.37 dBm/Hz



CH High

Agilent 17:26:26 Jul 28, 2010

R L

Mkr1 5.660 70 GHz
4.598 dBm

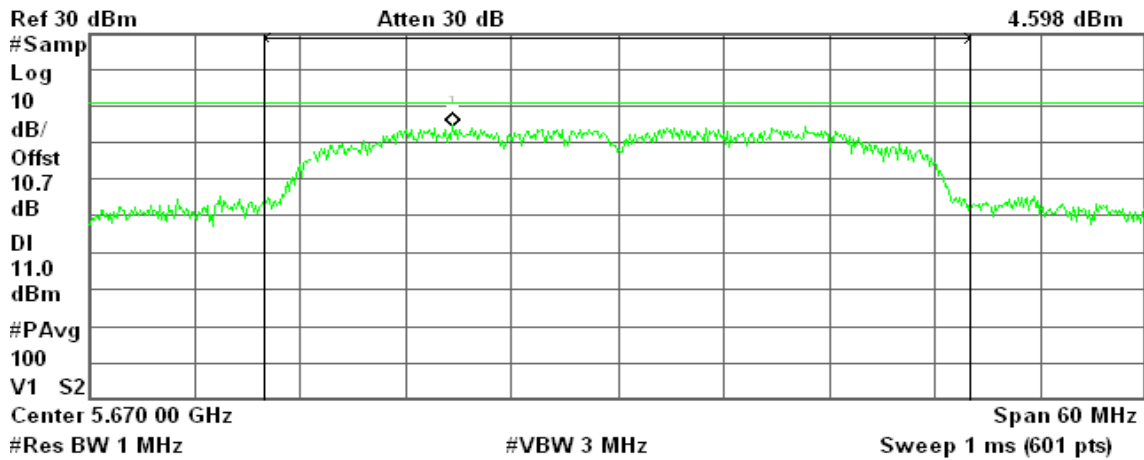

Channel Power

16.56 dBm / 40.0000 MHz

Power Spectral Density

-59.46 dBm/Hz



7.5 PEAK EXCURSION

LIMIT

According to §15.407(a)(6), the ratio of the peak excursion of the modulation envelope (measured using a peak hold function) to the maximum conducted output power (measured as specified above) shall not exceed 13 dB across any 1 MHz bandwidth or the emission bandwidth whichever is less.

Test Configuration

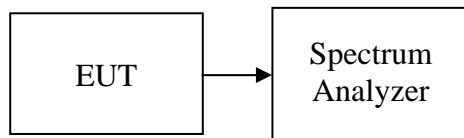

TEST PROCEDURE

The test is performed in accordance with <FCC Public Notice: APPENDIX A Guidelines for Assessing Unlicensed National Information Infrastructure (U-NII) Devices> – Part 15, Subpart E, August 2002.

1. Place the EUT on the table and set it in transmitting mode.
2. Remove the antenna from the EUT and then connect a low loss RF cable from the antenna port to spectrum.
3. Trace A, Set RBW = 1MHz, VBW = 3MHz, Span >26dB bandwidth, Max. hold.
Trace B, Set RBW = 1MHz, VBW = 3MHz, Span >26dB bandwidth, Setup sample detector and power average mode, to scan 100 times with Average.
4. Delta Mark trace A Maximum frequency and trace B same frequency.
5. Repeat the above procedure until measurements for all frequencies were complete.

TEST RESULTS

No non-compliance noted



Test Data

Test mode: IEEE 802.11a mode / 5180 ~ 5240MHz

Channel	Frequency (MHz)	Peak Excursion (dB)	Limit (dB)	Margin (dB)	Result
Low	5180	7.57	13.00	-5.43	PASS
Mid	5220	8.10	13.00	-4.90	PASS
High	5240	8.15	13.00	-4.85	PASS

Test mode: draft 802.11n Standard-20 MHz Channel mode / 5180 ~ 5240MHz

Channel	Frequency (MHz)	Peak Excursion (dB)	Limit (dB)	Margin (dB)	Result
Low	5180	10.72	13.00	-2.28	PASS
Mid	5220	12.13	13.00	-0.87	PASS
High	5240	11.02	13.00	-1.98	PASS

Test mode: draft 802.11n Wide-40 MHz Channel mode / 5190 ~ 5230MHz

Channel	Frequency (MHz)	Peak Excursion (dB)	Limit (dB)	Margin (dB)	Result
Low	5190	10.17	13.00	-2.83	PASS
High	5230	11.64	13.00	-1.36	PASS



Test mode: IEEE 802.11a mode / 5260 ~ 5320MHz

Channel	Frequency (MHz)	Peak Excursion (dB)	Limit (dB)	Margin (dB)	Result
Low	5260	9.74	13.00	-3.26	PASS
Mid	5280	9.65	13.00	-3.35	PASS
High	5320	7.38	13.00	-5.62	PASS

Test mode: draft 802.11n Standard-20 MHz Channel mode / 5260 ~ 5320MHz

Channel	Frequency (MHz)	Peak Excursion (dB)	Limit (dB)	Margin (dB)	Result
Low	5260	11.34	13.00	-1.66	PASS
Mid	5280	10.58	13.00	-2.42	PASS
High	5320	11.59	13.00	-1.41	PASS

Test mode: draft 802.11n Wide-40 MHz Channel mode / 5270 ~ 5310MHz

Channel	Frequency (MHz)	Peak Excursion (dB)	Limit (dB)	Margin (dB)	Result
Low	5270	11.22	13.00	-1.78	PASS
High	5310	11.39	13.00	-1.61	PASS



Test mode: IEEE 802.11a mode / 5500 ~ 5700MHz

Channel	Frequency (MHz)	Peak Excursion (dB)	Limit (dB)	Margin (dB)	Result
Low	5500	8.76	13.00	-4.24	PASS
Mid	5600	9.01	13.00	-3.99	PASS
High	5700	9.99	13.00	-3.01	PASS

Test mode: draft 802.11n Standard-20 MHz Channel mode / 5500 ~ 5700MHz

Channel	Frequency (MHz)	Peak Excursion (dB)	Limit (dB)	Margin (dB)	Result
Low	5500	9.10	13.00	-3.90	PASS
Mid	5600	9.12	13.00	-3.88	PASS
High	5700	10.02	13.00	-2.98	PASS

Test mode: draft 802.11n Wide-40 MHz Channel mode / 5510 ~ 5670MHz

Channel	Frequency (MHz)	Peak Excursion (dB)	Limit (dB)	Margin (dB)	Result
Low	5510	9.31	13.00	-3.69	PASS
Mid	5590	8.98	13.00	-4.02	PASS
High	5670	7.49	13.00	-5.51	PASS



Test Plot

IEEE 802.11a mode / 5180 ~ 5240MHz

CH Low

Agilent 17:04:45 Jul 27, 2010

R T

Δ Mkr1 0 Hz
7.57 dB

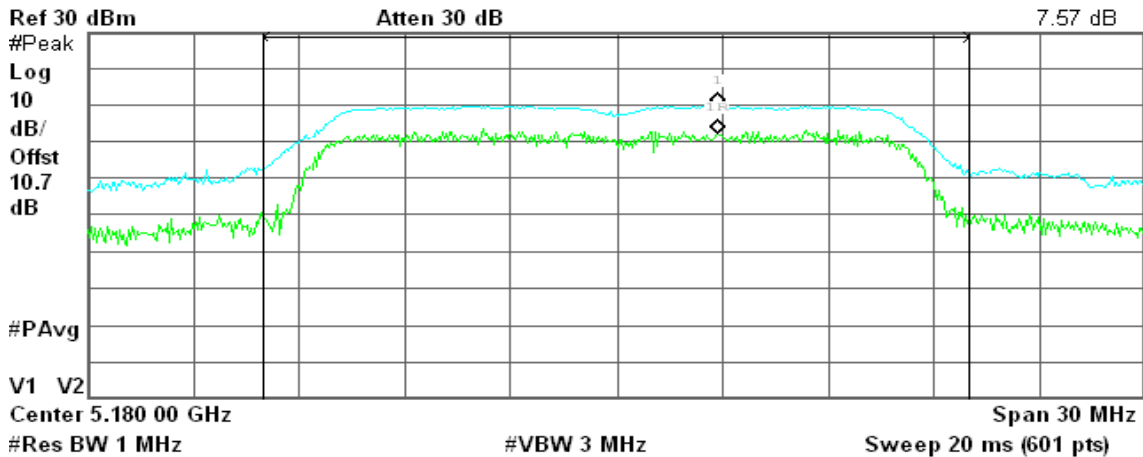

Channel Power

19.21 dBm / 20.0000 MHz

Power Spectral Density

-53.80 dBm/Hz

CH Mid

Agilent 17:12:21 Jul 27, 2010

R T

Δ Mkr1 0 Hz
8.10 dB

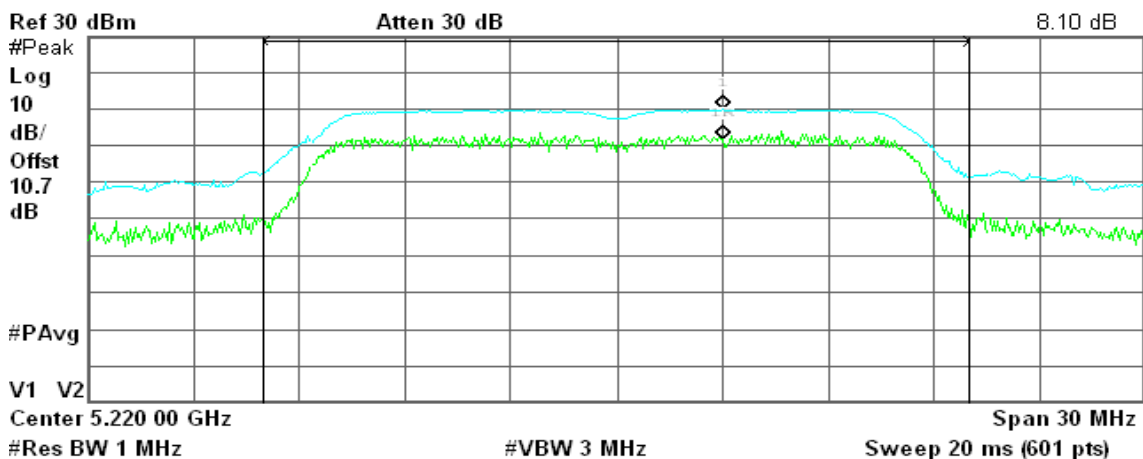

Channel Power

19.70 dBm / 20.0000 MHz

Power Spectral Density

-53.31 dBm/Hz



CH High

Agilent 17:16:48 Jul 27, 2010

R T

Δ Mkr1 0 Hz
8.15 dB

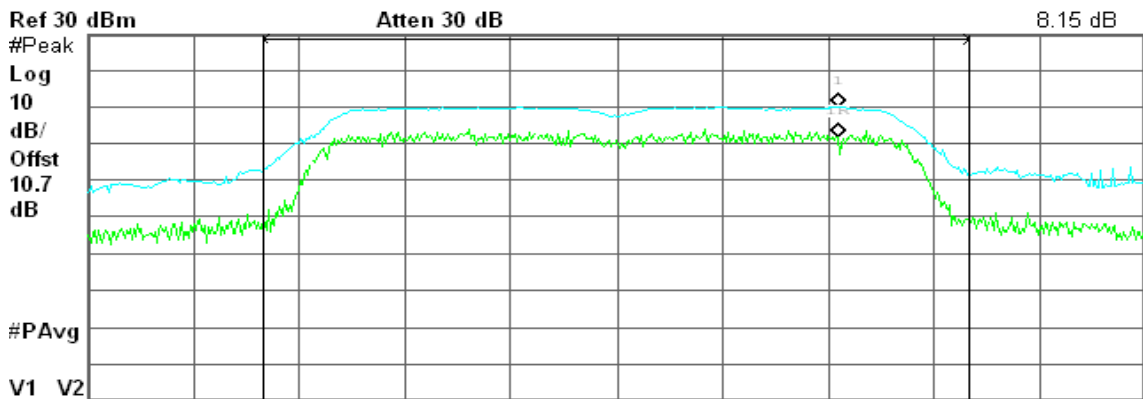

Center 5.240 00 GHz Span 30 MHz
#Res BW 1 MHz #VBW 3 MHz Sweep 20 ms (601 pts)

Channel Power

Power Spectral Density

19.84 dBm / 20.0000 MHz

-53.17 dBm/Hz

draft 802.11n Standard-20 MHz Channel mode / 5180 ~ 5240MHz

CH Low

Agilent 14:51:04 Jul 28, 2010

R T

Δ Mkr1 0 Hz
10.72 dB

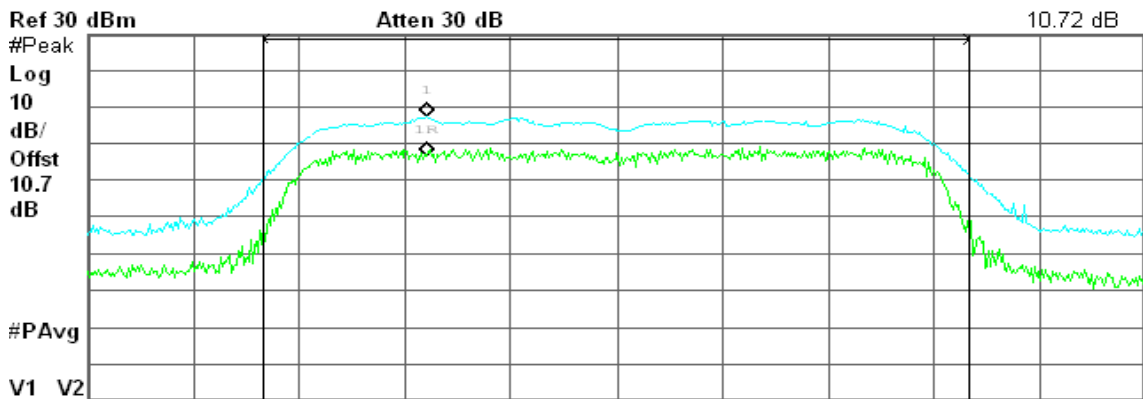

Center 5.180 00 GHz Span 30 MHz
#Res BW 1 MHz #VBW 3 MHz Sweep 20 ms (601 pts)

Channel Power

Power Spectral Density

15.96 dBm / 20.0000 MHz

-57.05 dBm/Hz



CH Mid

Agilent 14:53:10 Jul 28, 2010

R T

Δ Mkr1 0 Hz
12.13 dB

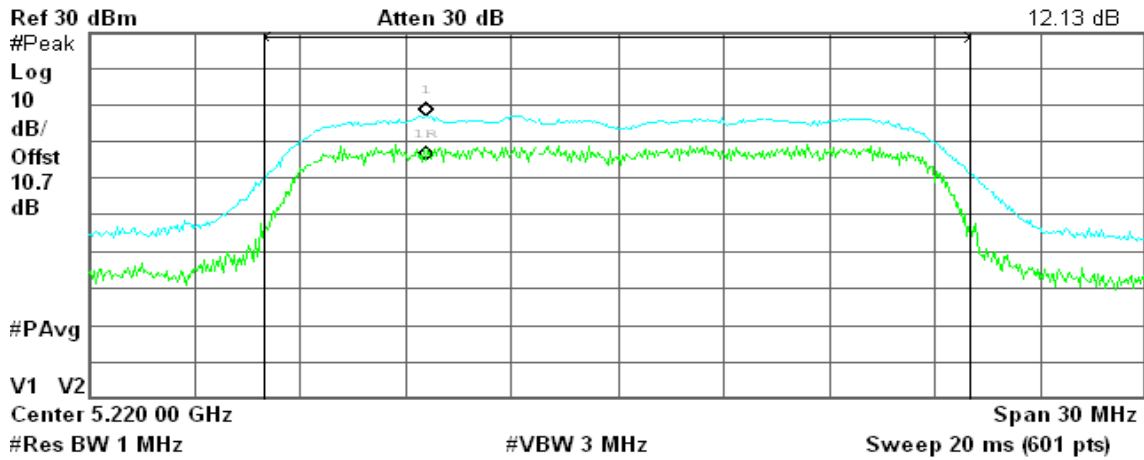

Channel Power

15.81 dBm / 20.0000 MHz

Power Spectral Density

-57.20 dBm/Hz

CH High

Agilent 14:36:47 Jul 28, 2010

R T

Δ Mkr1 0 Hz
11.02 dB

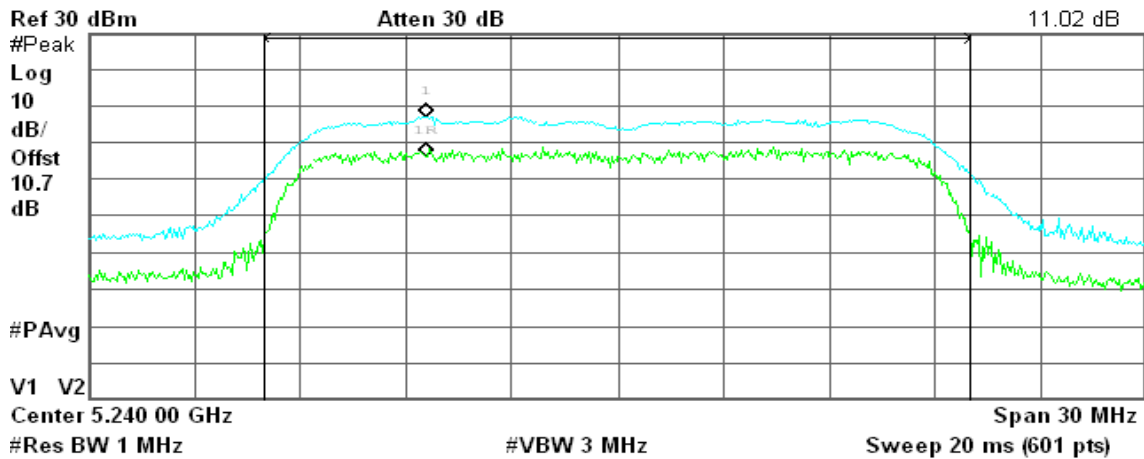

Channel Power

16.22 dBm / 20.0000 MHz

Power Spectral Density

-56.79 dBm/Hz



draft 802.11n Wide-40 MHz Channel mode / 5190 ~ 5230MHz

CH Low

Agilent 17:04:25 Jul 28, 2010

R T

Δ Mkr1 0 Hz
10.17 dB

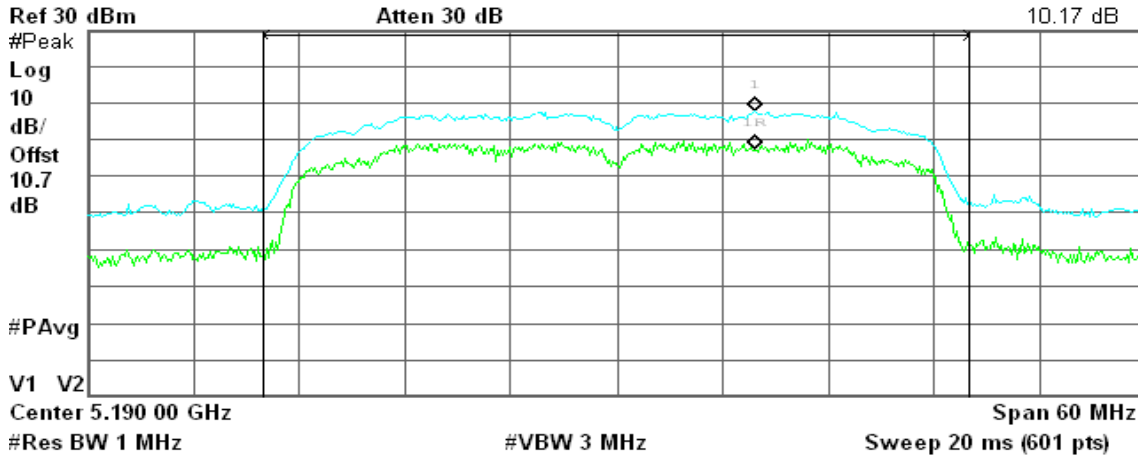

Channel Power

19.18 dBm / 40.0000 MHz

Power Spectral Density

-56.84 dBm/Hz

CH High

Agilent 17:09:32 Jul 28, 2010

R L

Δ Mkr1 0 Hz
11.64 dB

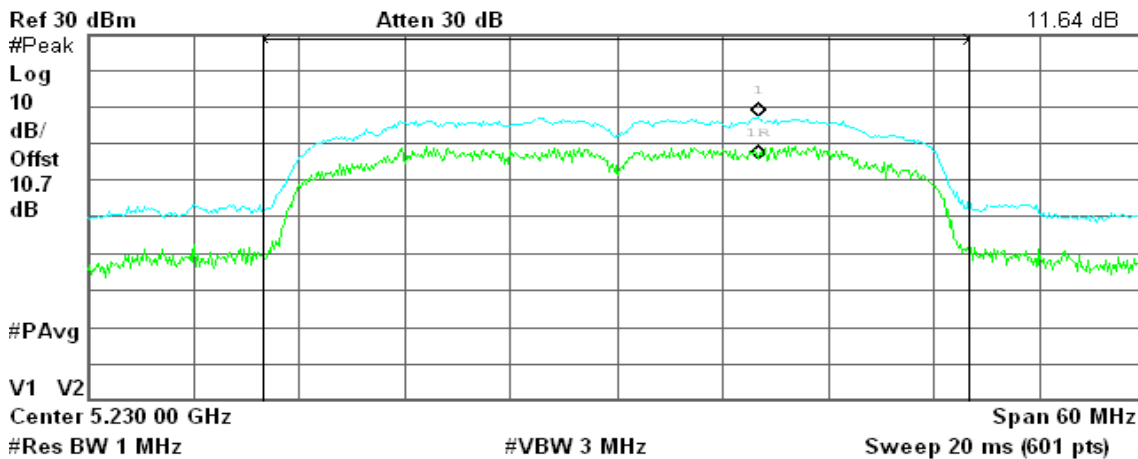

Channel Power

18.33 dBm / 40.0000 MHz

Power Spectral Density

-57.69 dBm/Hz



IEEE 802.11a mode / 5260 ~ 5320MHz

CH Low

Agilent 10:47:49 Jul 28, 2010

R T

Δ Mkr1 0 Hz
9.74 dB

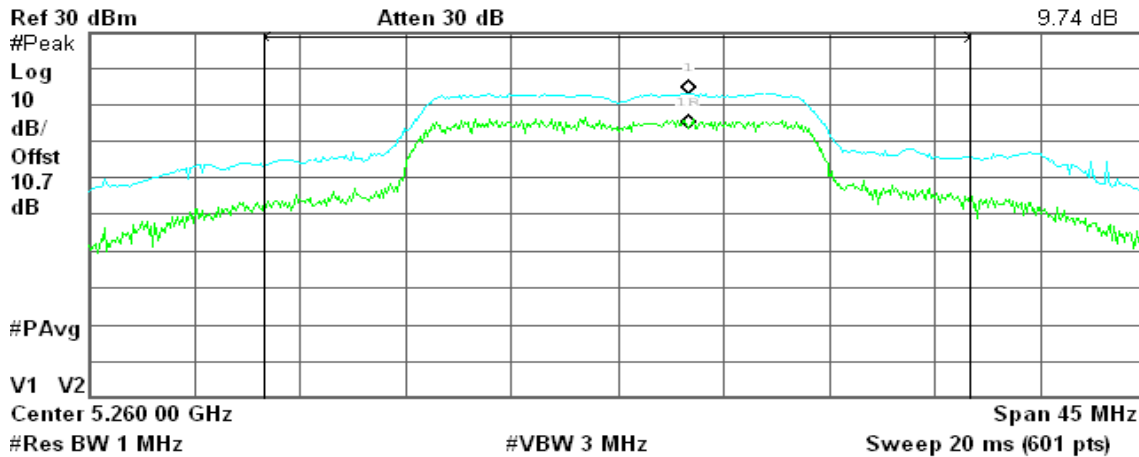

Channel Power

22.81 dBm / 30.0000 MHz

Power Spectral Density

-51.96 dBm/Hz

CH Mid

Agilent 10:42:44 Jul 28, 2010

R T

Δ Mkr1 0 Hz
9.65 dB

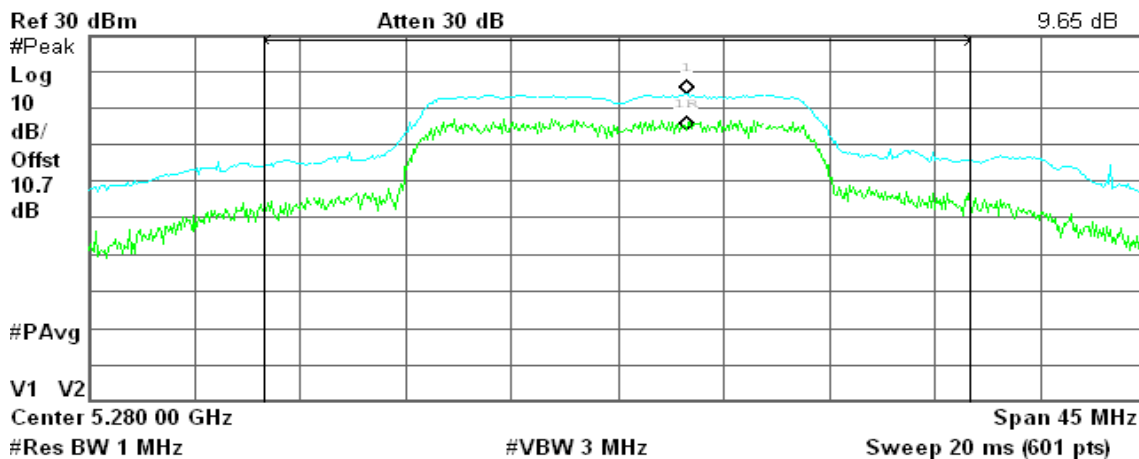

Channel Power

23.12 dBm / 30.0000 MHz

Power Spectral Density

-51.65 dBm/Hz



CH High

Agilent 10:54:13 Jul 28, 2010

R T

Δ Mkr1 0 Hz

7.38 dB

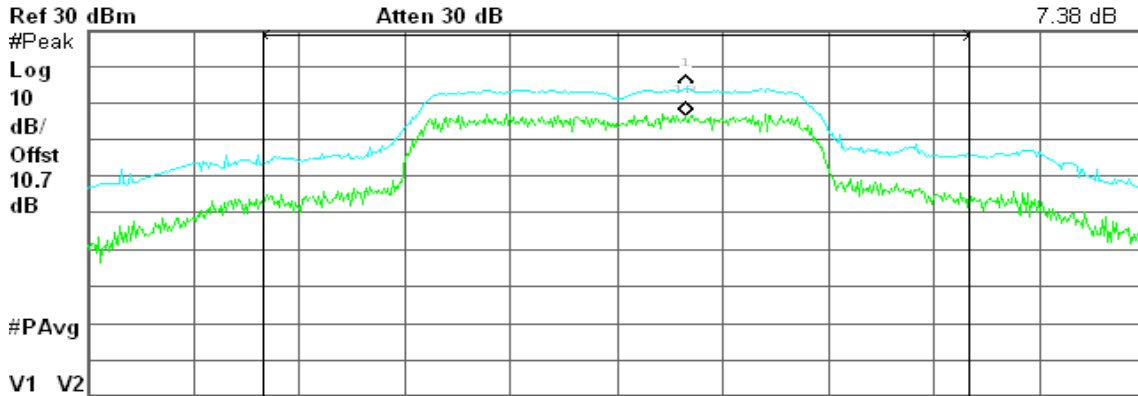

Ref 30 dBm Atten 30 dB #Peak Log 10 dB/ Offst 10.7 dB #PAvg V1 V2 Center 5.320 00 GHz Span 45 MHz #Res BW 1 MHz #VBW 3 MHz Sweep 20 ms (601 pts)

Channel Power

Power Spectral Density

23.12 dBm / 30.0000 MHz

-51.65 dBm/Hz

draft 802.11n Standard-20 MHz Channel mode / 5260 ~ 5320MHz

CH Low

Agilent 14:58:58 Jul 28, 2010

R L

Δ Mkr1 0 Hz

11.34 dB

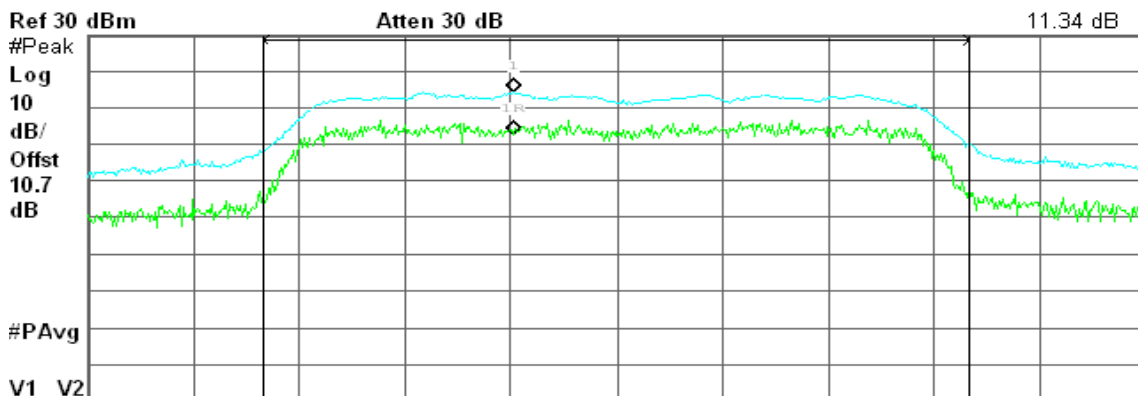

Ref 30 dBm Atten 30 dB #Peak Log 10 dB/ Offst 10.7 dB #PAvg V1 V2 Center 5.260 00 GHz Span 30 MHz #Res BW 1 MHz #VBW 3 MHz Sweep 20 ms (601 pts)

Channel Power

Power Spectral Density

23.02 dBm / 20.0000 MHz

-49.99 dBm/Hz



CH Mid

Agilent 15:01:49 Jul 28, 2010

R T

Δ Mkr1 0 Hz
10.58 dB

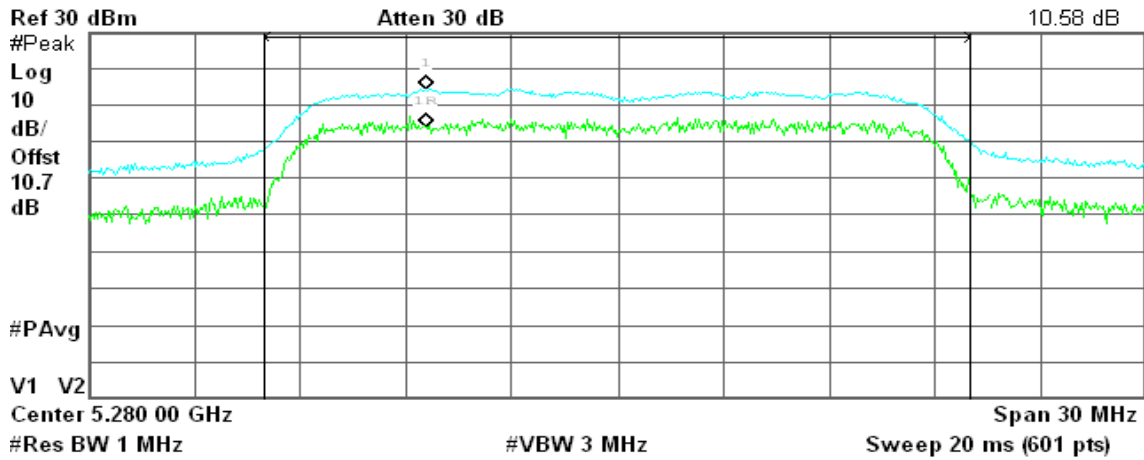

Channel Power

23.32 dBm / 20.0000 MHz

Power Spectral Density

-49.69 dBm/Hz

CH High

Agilent 15:04:37 Jul 28, 2010

R T

Δ Mkr1 0 Hz
11.59 dB

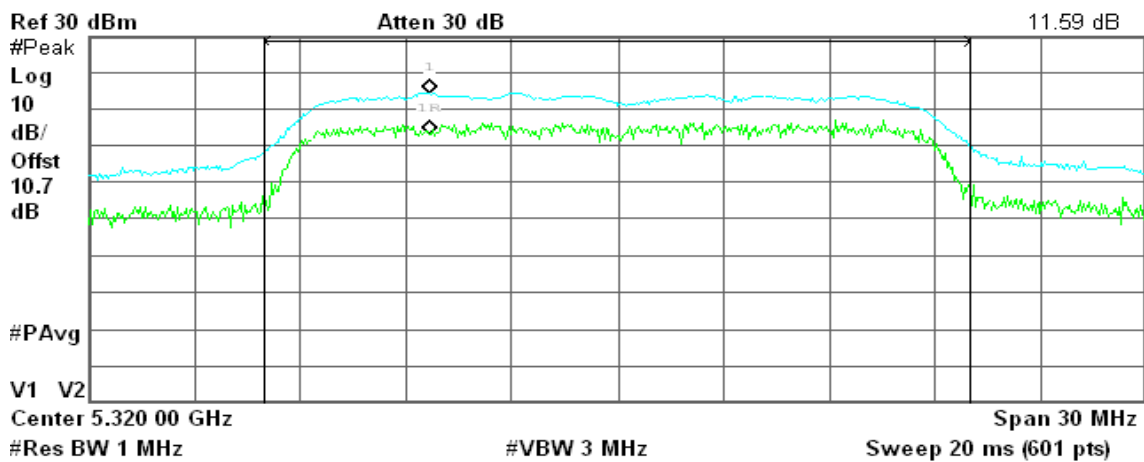

Channel Power

23.42 dBm / 20.0000 MHz

Power Spectral Density

-49.59 dBm/Hz



draft 802.11n Wide-40 MHz Channel mode / 5270 ~ 5310MHz

CH Low

Agilent 16:54:06 Jul 28, 2010

R T

Δ Mkr1 0 Hz
11.22 dB

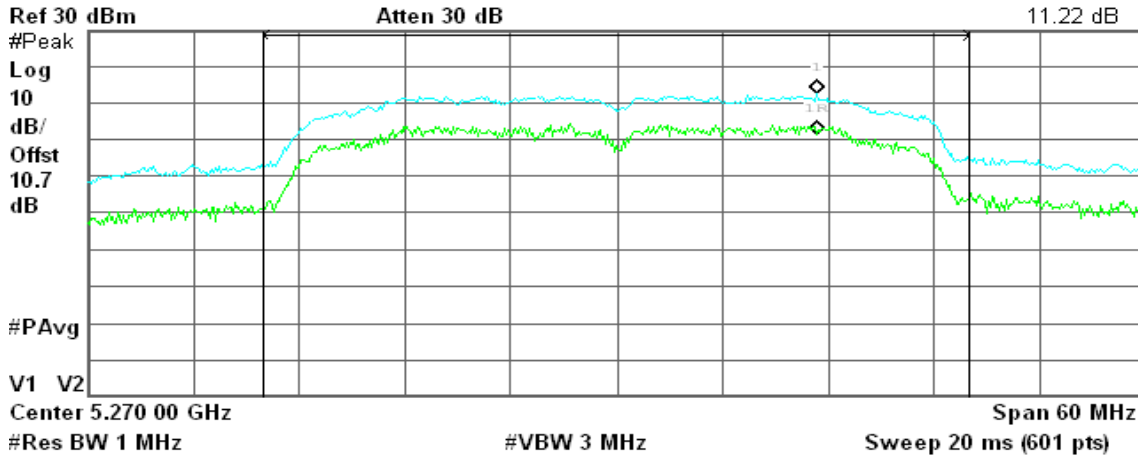

Channel Power

23.77 dBm / 40.0000 MHz

Power Spectral Density

-52.25 dBm/Hz

CH High

Agilent 16:40:00 Jul 28, 2010

R T

Δ Mkr1 0 Hz
11.39 dB

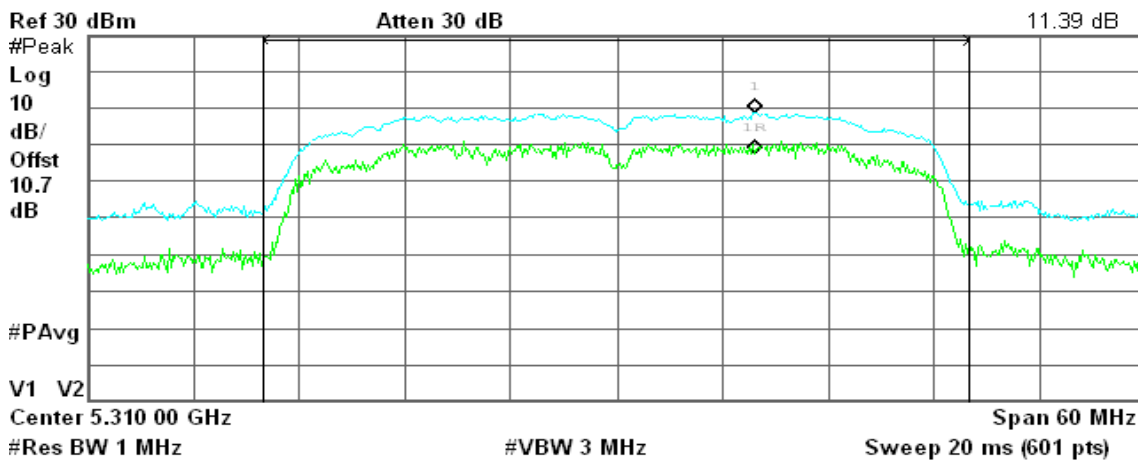

Channel Power

20.36 dBm / 40.0000 MHz

Power Spectral Density

-55.66 dBm/Hz



Test mode: IEEE 802.11a mode / 5500 ~ 5700MHz

CH Low

Agilent 11:01:21 Jul 28, 2010

R L

Δ Mkr1 0 Hz
8.76 dB

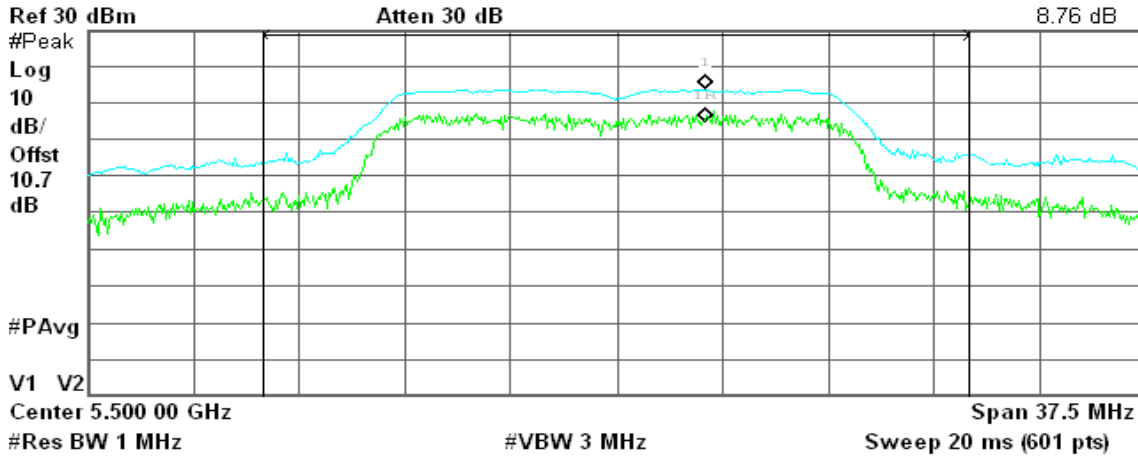

Channel Power

23.36 dBm / 25.0000 MHz

Power Spectral Density

-50.62 dBm/Hz

CH Mid

Agilent 11:03:50 Jul 28, 2010

R L

Δ Mkr1 0 Hz
9.01 dB

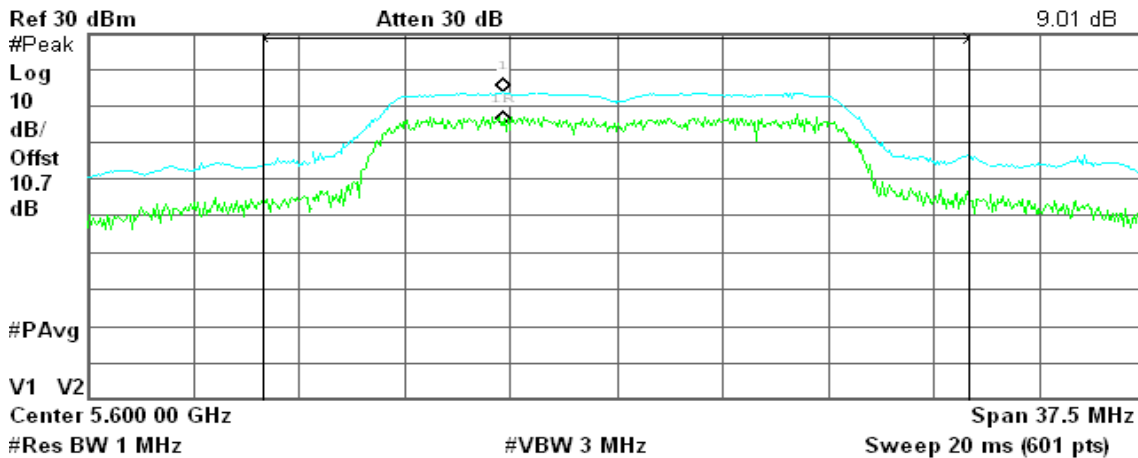

Channel Power

23.42 dBm / 25.0000 MHz

Power Spectral Density

-50.56 dBm/Hz



CH High

Agilent 11:06:26 Jul 28, 2010

R T

Δ Mkr1 0 Hz
9.99 dB

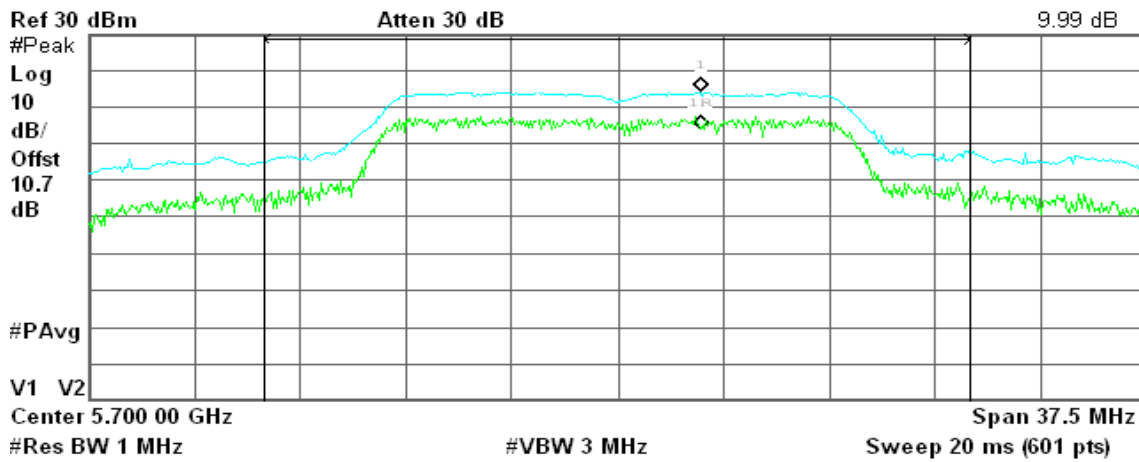

Channel Power

23.40 dBm / 25.0000 MHz

Power Spectral Density

-50.58 dBm/Hz

draft 802.11n Standard-20 MHz Channel mode / 5500 ~ 5700MHz

CH Low

Agilent 15:09:19 Jul 28, 2010

R T

Δ Mkr1 0 Hz
9.10 dB

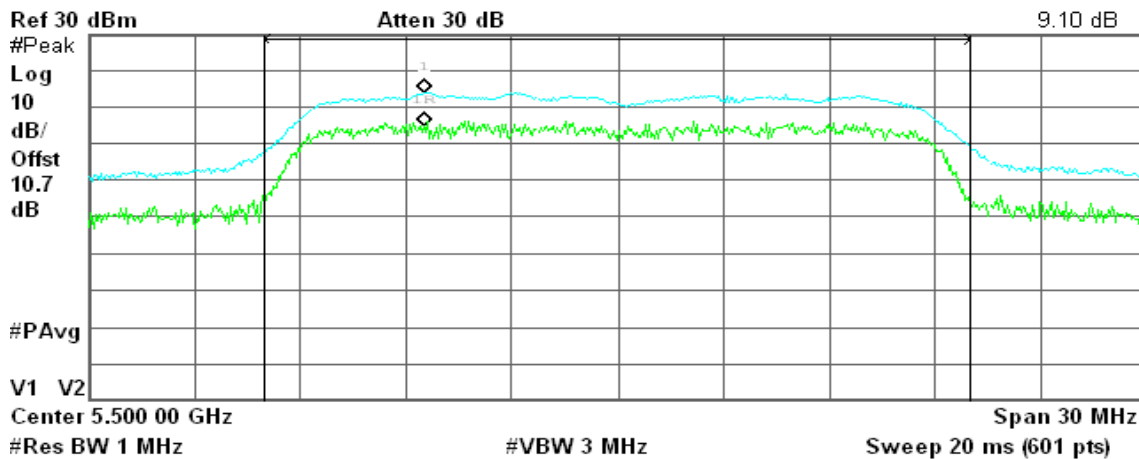

Channel Power

22.48 dBm / 20.0000 MHz

Power Spectral Density

-50.53 dBm/Hz



CH Mid

Agilent 15:12:03 Jul 28, 2010

R T

Δ Mkr1 0 Hz
9.12 dB

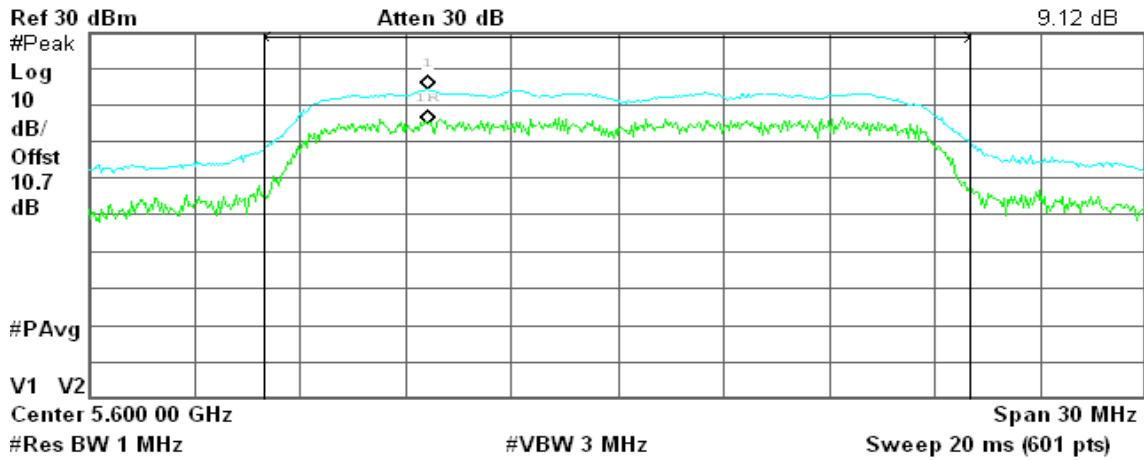

Channel Power

22.92 dBm / 20.0000 MHz

Power Spectral Density

-50.09 dBm/Hz

CH High

Agilent 15:15:02 Jul 28, 2010

R T

Δ Mkr1 0 Hz
10.02 dB

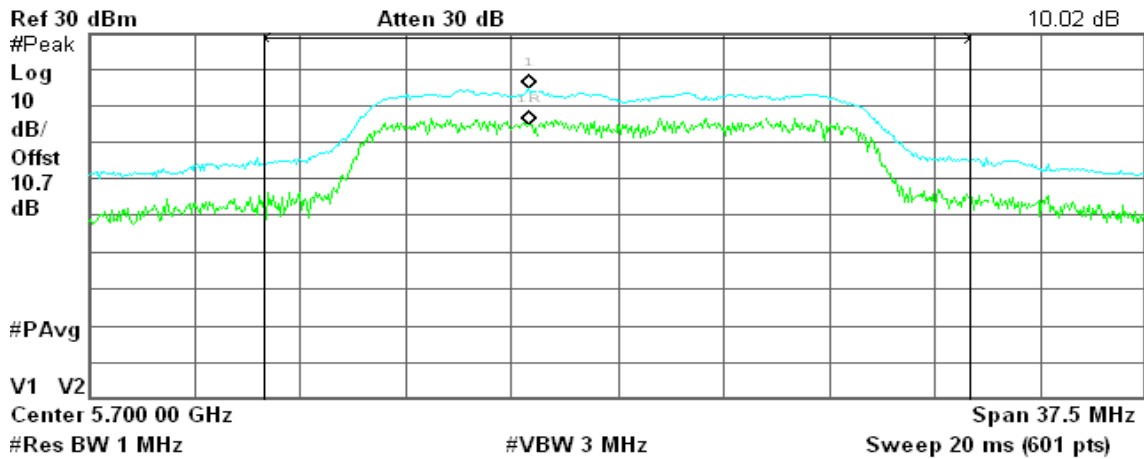

Channel Power

23.17 dBm / 25.0000 MHz

Power Spectral Density

-50.81 dBm/Hz



draft 802.11n Wide-40 MHz Channel mode / 5510 ~ 5670MHz

CH Low

Agilent 17:21:57 Jul 28, 2010

R T

Δ Mkr1 0 Hz
9.31 dB

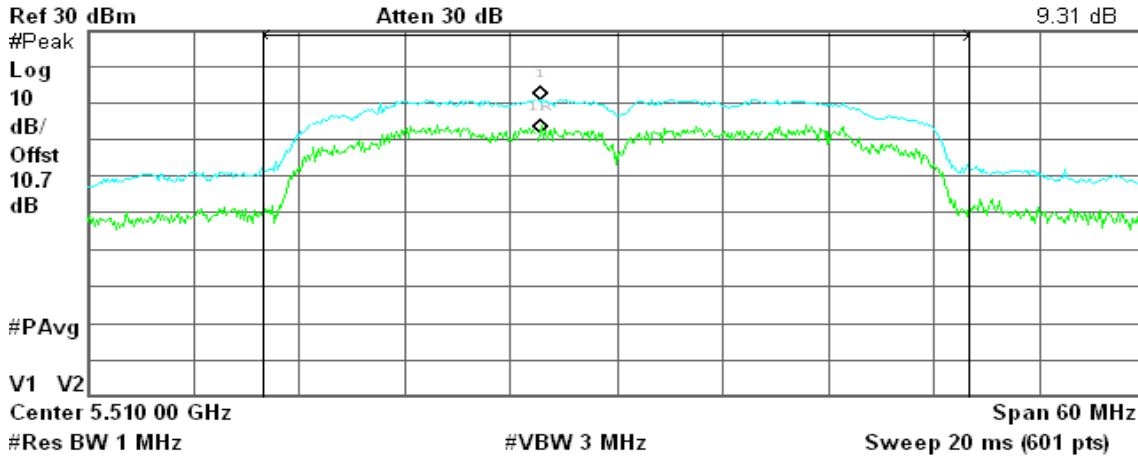

Channel Power

22.74 dBm / 40.0000 MHz

Power Spectral Density

-53.28 dBm/Hz

CH Mid

Agilent 17:24:30 Jul 28, 2010

R T

Δ Mkr1 0 Hz
8.98 dB

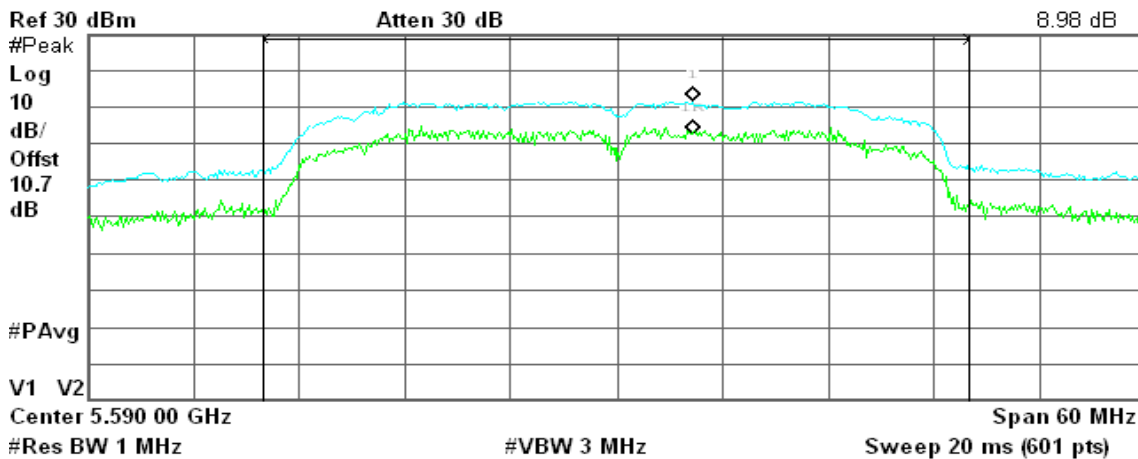

Channel Power

23.07 dBm / 40.0000 MHz

Power Spectral Density

-52.95 dBm/Hz



CH High

Agilent 17:26:46 Jul 28, 2010

R T

Δ Mkr1 0 Hz
7.49 dB

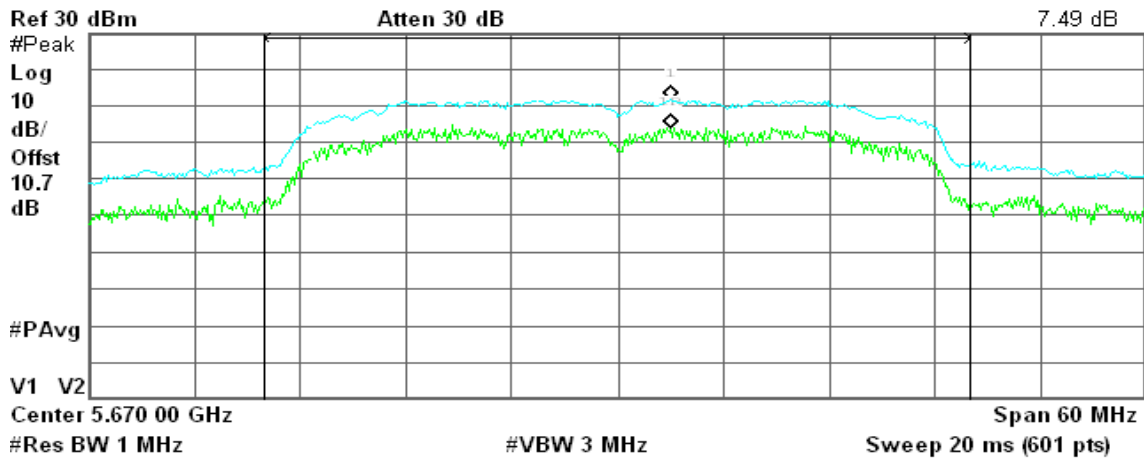

Channel Power

Power Spectral Density

23.24 dBm / 40.0000 MHz

-52.79 dBm/Hz



7.6 RADIATED UNDESIRABLE EMISSION

1. According to §15.209(a), except as provided elsewhere in this Subpart, the emissions from an intentional radiator shall not exceed the field strength levels specified in the following table:

Frequency (MHz)	Field Strength ($\mu\text{V/m}$)	Measurement Distance (m)
30-88	100*	3
88-216	150*	3
216-960	200*	3
Above 960	500	3

Remark: Except as provided in paragraph (g), fundamental emissions from intentional radiators operating under this Section shall not be located in the frequency bands 54-72 MHz, 76-88 MHz, 174-216 MHz or 470-806 MHz. However, operation within these frequency bands is permitted under other sections of this Part, e.g., Sections 15.231 and 15.241.

2. In the emission table above, the tighter limit applies at the band edges.

Frequency (MHz)	Field Strength ($\mu\text{V/m}$ at 3-meter)	Field Strength (dB $\mu\text{V/m}$ at 3-meter)
30-88	100	40
88-216	150	43.5
216-960	200	46
Above 960	500	54



Test Configuration

9kHz ~ 30MHz

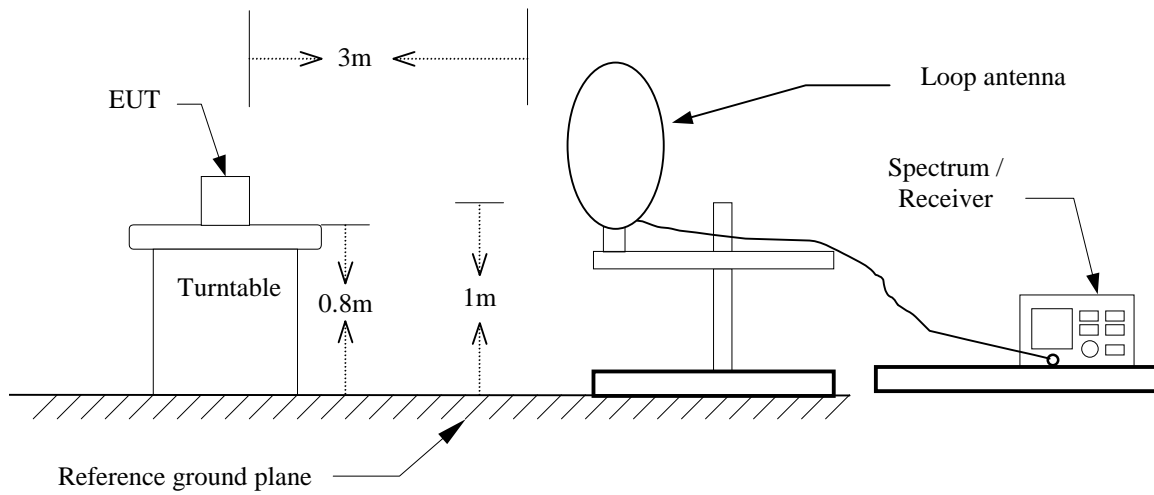

30MHz ~ 1GHz

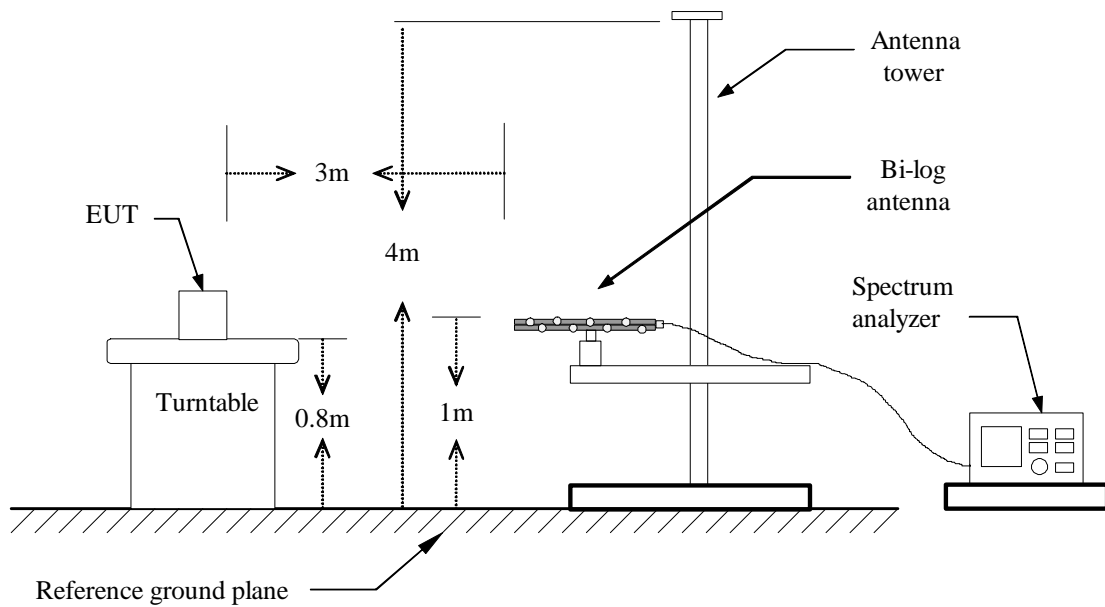



Above 1 GHz

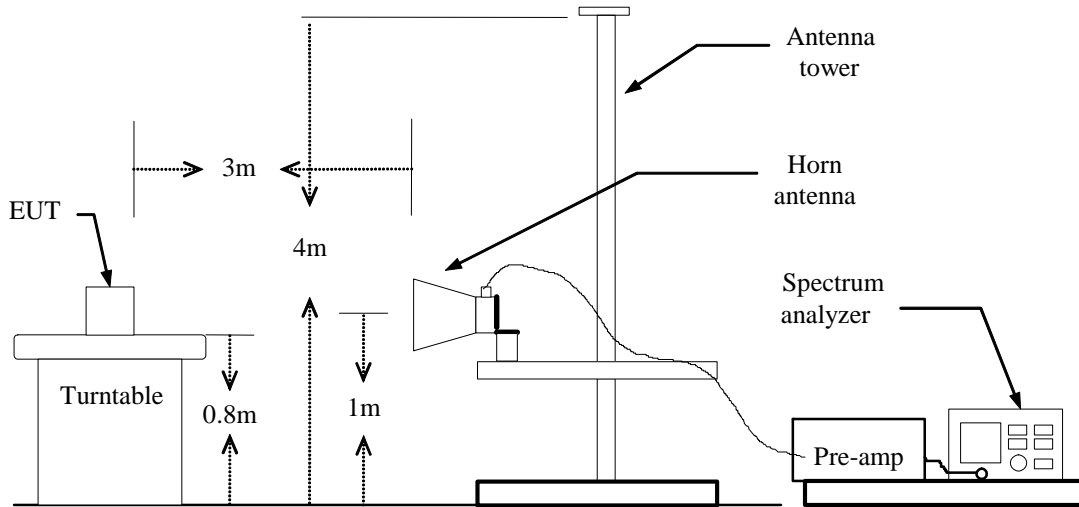



TEST PROCEDURE

1. The EUT is placed on a turntable, which is 0.8m above ground plane.
2. The turntable shall be rotated for 360 degrees to determine the position of maximum emission level.
3. EUT is set 3m away from the receiving antenna, which is varied from 1m to 4m to find out the highest emissions.
4. Maximum procedure was performed on the six highest emissions to ensure EUT compliance.
5. And also, each emission was to be maximized by changing the polarization of receiving antenna both horizontal and vertical.
6. Set the spectrum analyzer in the following setting as:

Below 1GHz:

RBW=100kHz / VBW=300kHz / Sweep=AUTO

Above 1GHz:

(a) PEAK: RBW=VBW=1MHz / Sweep=AUTO

(b) AVERAGE: RBW=1MHz / VBW=10Hz / Sweep=AUTO

7. Repeat above procedures until the measurements for all frequencies are complete.



TEST RESULTS

Below 1 GHz

Operation Mode: Normal Link

Test Date: September 10, 2010

Temperature: 25°C

Tested by: Mark Yang

Humidity: 50% RH

Polarity: Ver. / Hor.

Frequency (MHz)	Ant.Pol. (H/V)	Reading (dBuV)	Correction Factor (dB/m)	Result (dBuV/m)	Limit (dBuV/m)	Margin (dB)	Remark
31.62	V	30.64	-3.02	27.62	40.00	-12.38	Peak
299.98	V	41.47	-9.24	32.23	46.00	-13.77	Peak
479.43	V	36.06	-5.44	30.62	46.00	-15.38	Peak
500.45	V	36.14	-5.14	31.00	46.00	-15.00	Peak
584.52	V	34.30	-4.19	30.11	46.00	-15.89	Peak
959.58	V	29.58	0.44	30.03	46.00	-15.97	Peak
240.17	H	41.46	-11.09	30.37	46.00	-15.63	Peak
299.98	H	39.06	-9.24	29.82	46.00	-16.18	Peak
400.22	H	36.62	-7.08	29.54	46.00	-16.46	Peak
500.45	H	35.39	-5.14	30.25	46.00	-15.75	Peak
699.30	H	32.75	-2.54	30.20	46.00	-15.80	Peak
959.58	H	29.84	0.44	30.28	46.00	-15.72	Peak

Remark:

1. No emission found between lowest internal used/generated frequency to 30MHz (9kHz~30MHz).
2. Radiated emissions measured in frequency range from 30 MHz to 1000MHz were made with an instrument using peak/quasi-peak detector mode.
3. Quasi-peak test would be performed if the peak result were greater than the quasi-peak limit or as required by the applicant.
4. Measurements above show only up to 6 maximum emissions noted, or would be lesser, with " N/A " remark, if no specific emissions from the EUT are recorded (ie: margin>20dB from the applicable limit) and considered that's already beyond the background noise floor.
5. Margin (dB) = Remark result (dBuV/m) – Quasi-peak limit (dBuV/m).



Above 1 GHz

Operation Mode: Tx / IEEE 802.11a mode / 5180 ~ 5240MHz / CH Low **Test Date:** July 27, 2010
Temperature: 25°C **Tested by:** Wolf Huang
Humidity: 50% RH **Polarity:** Ver. / Hor.

Frequency (MHz)	Ant.Pol. (H/V)	Reading (Peak) (dBuV)	Reading (Average) (dBuV)	Correction Factor (dB/m)	Result (Peak) (dBuV/m)	Result (Average) (dBuV/m)	Limit (Peak) (dBuV/m)	Limit (Average) (dBuV/m)	Margin (dB)	Remark
1906.67	V	53.67	---	-5.01	48.66	---	74.00	54.00	-5.34	Peak
2300.00	V	52.43	---	-3.26	49.17	---	74.00	54.00	-4.83	Peak
N/A										
2300.00	H	52.49	---	-3.26	49.24	---	74.00	54.00	-4.76	Peak
N/A										

Remark:

1. Measuring frequencies from 1 GHz to the 10th harmonic of highest fundamental frequency.
2. Radiated emissions measured in frequency above 1000MHz were made with an instrument using peak/average detector mode.
3. Average test would be performed if the peak result were greater than the average limit.
4. Data of measurement within this frequency range shown " --- " in the table above means the reading of emissions are attenuated more than 20dB below the permissible limits or the field strength is too small to be measured.
5. Measurements above show only up to 6 maximum emissions noted, or would be lesser, with " N/A " remark, if no specific emissions from the EUT are recorded (ie: margin>20dB from the applicable limit) and considered that's already beyond the background noise floor.
6. Margin (dB) = Remark result (dBuV/m) – Average limit (dBuV/m).



Operation Mode: Tx / IEEE 802.11a mode / 5180 ~ 5240MHz / CH Mid **Test Date:** July 27, 2010
Temperature: 25°C **Tested by:** Wolf Huang
Humidity: 50% RH **Polarity:** Ver. / Hor.

Frequency (MHz)	Ant. Pol. (H/V)	Reading (Peak) (dBuV)	Reading (Average) (dBuV)	Correction Factor (dB/m)	Result (Peak) (dBuV/m)	Result (Average) (dBuV/m)	Limit (Peak) (dBuV/m)	Limit (Average) (dBuV/m)	Margin (dB)	Remark
1576.67	V	52.27	---	-8.05	44.21	---	74.00	54.00	-9.79	Peak
2230.00	V	52.46	---	-3.46	49.00	---	74.00	54.00	-5.00	Peak
N/A										
1926.67	H	52.79	---	-4.83	47.97	---	74.00	54.00	-6.03	Peak
2453.33	H	52.25	---	-2.80	49.45	---	74.00	54.00	-4.55	Peak
N/A										

Remark:

1. Measuring frequencies from 1 GHz to the 10th harmonic of highest fundamental frequency.
2. Radiated emissions measured in frequency above 1000MHz were made with an instrument using peak/average detector mode.
3. Average test would be performed if the peak result were greater than the average limit.
4. Data of measurement within this frequency range shown " --- " in the table above means the reading of emissions are attenuated more than 20dB below the permissible limits or the field strength is too small to be measured.
5. Measurements above show only up to 6 maximum emissions noted, or would be lesser, with " N/A " remark, if no specific emissions from the EUT are recorded (ie: margin>20dB from the applicable limit) and considered that's already beyond the background noise floor.
6. Margin (dB) = Remark result (dBuV/m) – Average limit (dBuV/m).



Operation Mode: Tx / IEEE 802.11a mode / 5180 ~ 5240MHz / CH High

Test Date: July 27, 2010

Temperature: 25°C

Tested by: Wolf Huang

Humidity: 50% RH

Polarity: Ver. / Hor.

Frequency (MHz)	Ant.Pol. (H/V)	Reading (Peak) (dBuV)	Reading (Average) (dBuV)	Correction Factor (dB/m)	Result (Peak) (dBuV/m)	Result (Average) (dBuV/m)	Limit (Peak) (dBuV/m)	Limit (Average) (dBuV/m)	Margin (dB)	Remark
1630.00	V	53.16	---	-7.56	45.60	---	74.00	54.00	-8.40	Peak
1890.00	V	52.88	---	-5.16	47.71	---	74.00	54.00	-6.29	Peak
2796.67	V	51.36	---	-1.79	49.56	---	74.00	54.00	-4.44	Peak
N/A										
2090.00	H	52.72	---	-3.88	48.84	---	74.00	54.00	-5.16	Peak
2313.33	H	51.60	---	-3.22	48.38	---	74.00	54.00	-5.62	Peak
N/A										

Remark:

1. Measuring frequencies from 1 GHz to the 10th harmonic of highest fundamental frequency.
2. Radiated emissions measured in frequency above 1000MHz were made with an instrument using peak/average detector mode.
3. Average test would be performed if the peak result were greater than the average limit.
4. Data of measurement within this frequency range shown " --- " in the table above means the reading of emissions are attenuated more than 20dB below the permissible limits or the field strength is too small to be measured.
5. Measurements above show only up to 6 maximum emissions noted, or would be lesser, with " N/A " remark, if no specific emissions from the EUT are recorded (ie: margin>20dB from the applicable limit) and considered that's already beyond the background noise floor.
6. Margin (dB) = Remark result (dBuV/m) – Average limit (dBuV/m).



Operation Mode: Tx / draft 802.11n Standard-20 MHz Channel mode / 5180 ~ 5240MHz / CH Low **Test Date:** July 27, 2010
Temperature: 25°C **Tested by:** Wolf Huang
Humidity: 50% RH **Polarity:** Ver. / Hor.

Frequency (MHz)	Ant.Pol. (H/V)	Reading (Peak) (dBuV)	Reading (Average) (dBuV)	Correction Factor (dB/m)	Result (Peak) (dBuV/m)	Result (Average) (dBuV/m)	Limit (Peak) (dBuV/m)	Limit (Average) (dBuV/m)	Margin (dB)	Remark
1873.33	V	52.61	---	-5.32	47.29	---	74.00	54.00	-6.71	Peak
2046.67	V	52.44	---	-4.01	48.43	---	74.00	54.00	-5.57	Peak
2786.67	V	51.11	---	-1.82	49.29	---	74.00	54.00	-4.71	Peak
N/A										
1770.00	H	53.26	---	-6.27	46.99	---	74.00	54.00	-7.01	Peak
2440.00	H	51.77	---	-2.84	48.94	---	74.00	54.00	-5.06	Peak
N/A										

Remark:

1. Measuring frequencies from 1 GHz to the 10th harmonic of highest fundamental frequency.
2. Radiated emissions measured in frequency above 1000MHz were made with an instrument using peak/average detector mode.
3. Average test would be performed if the peak result were greater than the average limit.
4. Data of measurement within this frequency range shown “ --- ” in the table above means the reading of emissions are attenuated more than 20dB below the permissible limits or the field strength is too small to be measured.
5. Measurements above show only up to 6 maximum emissions noted, or would be lesser, with “ N/A ” remark, if no specific emissions from the EUT are recorded (ie: margin>20dB from the applicable limit) and considered that's already beyond the background noise floor.
6. Margin (dB) = Remark result (dBuV/m) – Average limit (dBuV/m).



Operation Mode: Tx / draft 802.11n Standard-20 MHz Channel mode / 5180 ~ 5240MHz / CH Mid **Test Date:** July 27, 2010

Temperature: 25°C **Tested by:** Wolf Huang

Humidity: 50% RH **Polarity:** Ver. / Hor.

Frequency (MHz)	Ant.Pol. (H/V)	Reading (Peak) (dBuV)	Reading (Average) (dBuV)	Correction Factor (dB/m)	Result (Peak) (dBuV/m)	Result (Average) (dBuV/m)	Limit (Peak) (dBuV/m)	Limit (Average) (dBuV/m)	Margin (dB)	Remark
2036.67	V	51.88	---	-4.04	47.84	---	74.00	54.00	-6.16	Peak
N/A										
2213.33	H	53.14	---	-3.51	49.63	---	74.00	54.00	-4.37	Peak
N/A										

Remark:

1. Measuring frequencies from 1 GHz to the 10th harmonic of highest fundamental frequency.
2. Radiated emissions measured in frequency above 1000MHz were made with an instrument using peak/average detector mode.
3. Average test would be performed if the peak result were greater than the average limit.
4. Data of measurement within this frequency range shown “ --- ” in the table above means the reading of emissions are attenuated more than 20dB below the permissible limits or the field strength is too small to be measured.
5. Measurements above show only up to 6 maximum emissions noted, or would be lesser, with “ N/A ” remark, if no specific emissions from the EUT are recorded (ie: margin>20dB from the applicable limit) and considered that's already beyond the background noise floor.
6. Margin (dB) = Remark result (dBuV/m) – Average limit (dBuV/m).



Operation Mode: Tx / draft 802.11n Standard-20 MHz Channel mode / 5180 ~ 5240MHz / CH High

Test Date: July 27, 2010

Temperature: 25°C

Tested by: Wolf Huang

Humidity: 50% RH

Polarity: Ver. / Hor.

Frequency (MHz)	Ant.Pol. (H/V)	Reading (Peak) (dBuV)	Reading (Average) (dBuV)	Correction Factor (dB/m)	Result (Peak) (dBuV/m)	Result (Average) (dBuV/m)	Limit (Peak) (dBuV/m)	Limit (Average) (dBuV/m)	Margin (dB)	Remark
1660.00	V	52.29	---	-7.28	45.01	---	74.00	54.00	-8.99	Peak
2193.33	V	51.79	---	-3.57	48.22	---	74.00	54.00	-5.78	Peak
2440.00	V	52.39	---	-2.84	49.55	---	74.00	54.00	-4.45	Peak
N/A										
1206.67	H	53.41	---	-9.25	44.17	---	74.00	54.00	-9.83	Peak
1936.67	H	51.84	---	-4.73	47.10	---	74.00	54.00	-6.90	Peak
2346.67	H	51.86	---	-3.12	48.74	---	74.00	54.00	-5.26	Peak
N/A										

Remark:

1. Measuring frequencies from 1 GHz to the 10th harmonic of highest fundamental frequency.
2. Radiated emissions measured in frequency above 1000MHz were made with an instrument using peak/average detector mode.
3. Average test would be performed if the peak result were greater than the average limit.
4. Data of measurement within this frequency range shown “ --- ” in the table above means the reading of emissions are attenuated more than 20dB below the permissible limits or the field strength is too small to be measured.
5. Measurements above show only up to 6 maximum emissions noted, or would be lesser, with “ N/A ” remark, if no specific emissions from the EUT are recorded (ie: margin>20dB from the applicable limit) and considered that's already beyond the background noise floor.
6. Margin (dB) = Remark result (dBuV/m) – Average limit (dBuV/m).



Operation Mode: Tx / draft 802.11n Wide-40 MHz Channel mode / 5190 ~ 5230MHz / CH Low

Test Date: July 27, 2010

Temperature: 25°C

Tested by: Wolf Huang

Humidity: 50% RH

Polarity: Ver. / Hor.

Frequency (MHz)	Ant.Pol. (H/V)	Reading (Peak) (dBuV)	Reading (Average) (dBuV)	Correction Factor (dB/m)	Result (Peak) (dBuV/m)	Result (Average) (dBuV/m)	Limit (Peak) (dBuV/m)	Limit (Average) (dBuV/m)	Margin (dB)	Remark
2056.67	V	52.22	---	-3.98	48.24	---	74.00	54.00	-5.76	Peak
2270.00	V	52.13	---	-3.35	48.79	---	74.00	54.00	-5.21	Peak
N/A										
1653.33	H	52.64	---	-7.35	45.29	---	74.00	54.00	-8.71	Peak
1880.00	H	52.19	---	-5.26	46.93	---	74.00	54.00	-7.07	Peak
2316.67	H	51.67	---	-3.21	48.46	---	74.00	54.00	-5.54	Peak
N/A										

Remark:

1. Measuring frequencies from 1 GHz to the 10th harmonic of highest fundamental frequency.
2. Radiated emissions measured in frequency above 1000MHz were made with an instrument using peak/average detector mode.
3. Average test would be performed if the peak result were greater than the average limit.
4. Data of measurement within this frequency range shown “ --- ” in the table above means the reading of emissions are attenuated more than 20dB below the permissible limits or the field strength is too small to be measured.
5. Measurements above show only up to 6 maximum emissions noted, or would be lesser, with “ N/A ” remark, if no specific emissions from the EUT are recorded (ie: margin>20dB from the applicable limit) and considered that's already beyond the background noise floor.
6. Margin (dB) = Remark result (dBuV/m) – Average limit (dBuV/m).



Operation Mode: Tx / draft 802.11n Wide-40 MHz Channel mode / 5190 ~ 5230MHz / CH High

Test Date: July 27, 2010

Temperature: 25°C

Tested by: Wolf Huang

Humidity: 50% RH

Polarity: Ver. / Hor.

Frequency (MHz)	Ant.Pol. (H/V)	Reading (Peak) (dBuV)	Reading (Average) (dBuV)	Correction Factor (dB/m)	Result (Peak) (dBuV/m)	Result (Average) (dBuV/m)	Limit (Peak) (dBuV/m)	Limit (Average) (dBuV/m)	Margin (dB)	Remark
2233.33	V	52.68	---	-3.45	49.23	---	74.00	54.00	-4.77	Peak
2780.00	V	52.21	---	-1.84	50.37	---	74.00	54.00	-3.63	Peak
N/A										
2313.33	H	51.90	---	-3.22	48.68	---	74.00	54.00	-5.32	Peak
N/A										

Remark:

1. Measuring frequencies from 1 GHz to the 10th harmonic of highest fundamental frequency.
2. Radiated emissions measured in frequency above 1000MHz were made with an instrument using peak/average detector mode.
3. Average test would be performed if the peak result were greater than the average limit.
4. Data of measurement within this frequency range shown “ --- ” in the table above means the reading of emissions are attenuated more than 20dB below the permissible limits or the field strength is too small to be measured.
5. Measurements above show only up to 6 maximum emissions noted, or would be lesser, with “ N/A ” remark, if no specific emissions from the EUT are recorded (ie: margin>20dB from the applicable limit) and considered that's already beyond the background noise floor.
6. Margin (dB) = Remark result (dBuV/m) – Average limit (dBuV/m).



Operation Mode: Tx / IEEE 802.11a mode / 5260 ~ 5320MHz / CH Low **Test Date:** July 27, 2010
Temperature: 25°C **Tested by:** Wolf Huang
Humidity: 50% RH **Polarity:** Ver. / Hor.

Frequency (MHz)	Ant.Pol. (H/V)	Reading (Peak) (dBuV)	Reading (Average) (dBuV)	Correction Factor (dB/m)	Result (Peak) (dBuV/m)	Result (Average) (dBuV/m)	Limit (Peak) (dBuV/m)	Limit (Average) (dBuV/m)	Margin (dB)	Remark
1400.00	V	54.15	---	-8.93	45.22	---	74.00	54.00	-8.78	Peak
2183.33	V	52.83	---	-3.60	49.23	---	74.00	54.00	-4.77	Peak
2540.00	V	51.83	---	-2.54	49.29	---	74.00	54.00	-4.71	Peak
N/A										
2246.67	H	51.76	---	-3.41	48.35	---	74.00	54.00	-5.65	Peak
2536.67	H	52.03	---	-2.55	49.48	---	74.00	54.00	-4.52	Peak
N/A										

Remark:

1. Measuring frequencies from 1 GHz to the 10th harmonic of highest fundamental frequency.
2. Radiated emissions measured in frequency above 1000MHz were made with an instrument using peak/average detector mode.
3. Average test would be performed if the peak result were greater than the average limit.
4. Data of measurement within this frequency range shown " --- " in the table above means the reading of emissions are attenuated more than 20dB below the permissible limits or the field strength is too small to be measured.
5. Measurements above show only up to 6 maximum emissions noted, or would be lesser, with " N/A " remark, if no specific emissions from the EUT are recorded (ie: margin>20dB from the applicable limit) and considered that's already beyond the background noise floor.
6. Margin (dB) = Remark result (dBuV/m) – Average limit (dBuV/m).



Operation Mode: Tx / IEEE 802.11a mode / 5260 ~ 5320MHz / CH Mid **Test Date:** July 27, 2010
Temperature: 25°C **Tested by:** Wolf Huang
Humidity: 50% RH **Polarity:** Ver. / Hor.

Frequency (MHz)	Ant.Pol. (H/V)	Reading (Peak) (dBuV)	Reading (Average) (dBuV)	Correction Factor (dB/m)	Result (Peak) (dBuV/m)	Result (Average) (dBuV/m)	Limit (Peak) (dBuV/m)	Limit (Average) (dBuV/m)	Margin (dB)	Remark
1210.00	V	53.91	---	-9.24	44.67	---	74.00	54.00	-9.33	Peak
2006.67	V	52.54	---	-4.13	48.41	---	74.00	54.00	-5.59	Peak
2263.33	V	52.03	---	-3.37	48.67	---	74.00	54.00	-5.33	Peak
N/A										
1750.00	H	53.44	---	-6.46	46.99	---	74.00	54.00	-7.01	Peak
2436.67	H	52.78	---	-2.85	49.93	---	74.00	54.00	-4.07	Peak
N/A										

Remark:

1. Measuring frequencies from 1 GHz to the 10th harmonic of highest fundamental frequency.
2. Radiated emissions measured in frequency above 1000MHz were made with an instrument using peak/average detector mode.
3. Average test would be performed if the peak result were greater than the average limit.
4. Data of measurement within this frequency range shown " --- " in the table above means the reading of emissions are attenuated more than 20dB below the permissible limits or the field strength is too small to be measured.
5. Measurements above show only up to 6 maximum emissions noted, or would be lesser, with " N/A " remark, if no specific emissions from the EUT are recorded (ie: margin>20dB from the applicable limit) and considered that's already beyond the background noise floor.
6. Margin (dB) = Remark result (dBuV/m) – Average limit (dBuV/m).



Operation Mode: Tx / IEEE 802.11a mode / 5260 ~ 5320MHz / CH High **Test Date:** July 27, 2010
Temperature: 25°C **Tested by:** Wolf Huang
Humidity: 50% RH **Polarity:** Ver. / Hor.

Frequency (MHz)	Ant.Pol. (H/V)	Reading (Peak) (dBuV)	Reading (Average) (dBuV)	Correction Factor (dB/m)	Result (Peak) (dBuV/m)	Result (Average) (dBuV/m)	Limit (Peak) (dBuV/m)	Limit (Average) (dBuV/m)	Margin (dB)	Remark
1876.67	V	53.37	---	-5.29	48.08	---	74.00	54.00	-5.92	Peak
2073.33	V	52.51	---	-3.93	48.57	---	74.00	54.00	-5.43	Peak
N/A										
1923.33	H	52.27	---	-4.86	47.41	---	74.00	54.00	-6.59	Peak
2176.67	H	52.13	---	-3.62	48.51	---	74.00	54.00	-5.49	Peak
N/A										

Remark:

1. Measuring frequencies from 1 GHz to the 10th harmonic of highest fundamental frequency.
2. Radiated emissions measured in frequency above 1000MHz were made with an instrument using peak/average detector mode.
3. Average test would be performed if the peak result were greater than the average limit.
4. Data of measurement within this frequency range shown " --- " in the table above means the reading of emissions are attenuated more than 20dB below the permissible limits or the field strength is too small to be measured.
5. Measurements above show only up to 6 maximum emissions noted, or would be lesser, with " N/A " remark, if no specific emissions from the EUT are recorded (ie: margin>20dB from the applicable limit) and considered that's already beyond the background noise floor.
6. Margin (dB) = Remark result (dBuV/m) – Average limit (dBuV/m).



Operation Mode: Tx / draft 802.11n Standard-20 MHz Channel mode / 5260 ~ 5320MHz / CH Low **Test Date:** July 27, 2010

Temperature: 25°C **Tested by:** Wolf Huang

Humidity: 50% RH **Polarity:** Ver. / Hor.

Frequency (MHz)	Ant.Pol. (H/V)	Reading (Peak) (dBuV)	Reading (Average) (dBuV)	Correction Factor (dB/m)	Result (Peak) (dBuV/m)	Result (Average) (dBuV/m)	Limit (Peak) (dBuV/m)	Limit (Average) (dBuV/m)	Margin (dB)	Remark
1256.67	V	54.81	---	-9.16	45.65	---	74.00	54.00	-8.35	Peak
1653.33	V	53.29	---	-7.35	45.95	---	74.00	54.00	-8.05	Peak
2153.33	V	52.75	---	-3.69	49.06	---	74.00	54.00	-4.94	Peak
2636.67	V	51.16	---	-2.26	48.90	---	74.00	54.00	-5.10	Peak
N/A										
1313.33	H	53.19	---	-9.07	44.12	---	74.00	54.00	-9.88	Peak
2180.00	H	52.11	---	-3.61	48.50	---	74.00	54.00	-5.50	Peak
2753.33	H	51.08	---	-1.92	49.16	---	74.00	54.00	-4.84	Peak
N/A										

Remark:

1. Measuring frequencies from 1 GHz to the 10th harmonic of highest fundamental frequency.
2. Radiated emissions measured in frequency above 1000MHz were made with an instrument using peak/average detector mode.
3. Average test would be performed if the peak result were greater than the average limit.
4. Data of measurement within this frequency range shown “ --- ” in the table above means the reading of emissions are attenuated more than 20dB below the permissible limits or the field strength is too small to be measured.
5. Measurements above show only up to 6 maximum emissions noted, or would be lesser, with “ N/A ” remark, if no specific emissions from the EUT are recorded (ie: margin>20dB from the applicable limit) and considered that's already beyond the background noise floor.
6. Margin (dB) = Remark result (dBuV/m) – Average limit (dBuV/m).



Operation Mode: Tx / draft 802.11n Standard-20 MHz Channel mode / 5260 ~ 5320MHz / CH Mid **Test Date:** July 27, 2010
Temperature: 25°C **Tested by:** Wolf Huang
Humidity: 50% RH **Polarity:** Ver. / Hor.

Frequency (MHz)	Ant.Pol. (H/V)	Reading (Peak) (dBuV)	Reading (Average) (dBuV)	Correction Factor (dB/m)	Result (Peak) (dBuV/m)	Result (Average) (dBuV/m)	Limit (Peak) (dBuV/m)	Limit (Average) (dBuV/m)	Margin (dB)	Remark
1413.33	V	52.57	---	-8.90	43.67	---	74.00	54.00	-10.33	Peak
1980.00	V	52.43	---	-4.33	48.10	---	74.00	54.00	-5.90	Peak
2606.67	V	51.36	---	-2.35	49.01	---	74.00	54.00	-4.99	Peak
N/A										
1126.67	H	54.43	---	-9.38	45.05	---	74.00	54.00	-8.95	Peak
2296.67	H	51.90	---	-3.27	48.64	---	74.00	54.00	-5.36	Peak
2393.33	H	52.32	---	-2.98	49.34	---	74.00	54.00	-4.66	Peak
2790.00	H	51.39	---	-1.81	49.58	---	74.00	54.00	-4.42	Peak
N/A										

Remark:

1. Measuring frequencies from 1 GHz to the 10th harmonic of highest fundamental frequency.
2. Radiated emissions measured in frequency above 1000MHz were made with an instrument using peak/average detector mode.
3. Average test would be performed if the peak result were greater than the average limit.
4. Data of measurement within this frequency range shown “ --- ” in the table above means the reading of emissions are attenuated more than 20dB below the permissible limits or the field strength is too small to be measured.
5. Measurements above show only up to 6 maximum emissions noted, or would be lesser, with “ N/A ” remark, if no specific emissions from the EUT are recorded (ie: margin>20dB from the applicable limit) and considered that's already beyond the background noise floor.
6. Margin (dB) = Remark result (dBuV/m) – Average limit (dBuV/m).



Operation Mode: Tx / draft 802.11n Standard-20 MHz Channel mode / 5260 ~ 5320MHz / CH High

Test Date: July 27, 2010

Temperature: 25°C

Tested by: Wolf Huang

Humidity: 50% RH

Polarity: Ver. / Hor.

Frequency (MHz)	Ant.Pol. (H/V)	Reading (Peak) (dBuV)	Reading (Average) (dBuV)	Correction Factor (dB/m)	Result (Peak) (dBuV/m)	Result (Average) (dBuV/m)	Limit (Peak) (dBuV/m)	Limit (Average) (dBuV/m)	Margin (dB)	Remark
1303.33	V	52.98	---	-9.09	43.89	---	74.00	54.00	-10.11	Peak
1770.00	V	52.94	---	-6.27	46.67	---	74.00	54.00	-7.33	Peak
2536.67	V	51.91	---	-2.55	49.36	---	74.00	54.00	-4.64	Peak
N/A										
1226.67	H	53.74	---	-9.21	44.53	---	74.00	54.00	-9.47	Peak
1510.00	H	54.35	---	-8.67	45.68	---	74.00	54.00	-8.32	Peak
2330.00	H	51.79	---	-3.17	48.62	---	74.00	54.00	-5.38	Peak
N/A										

Remark:

1. Measuring frequencies from 1 GHz to the 10th harmonic of highest fundamental frequency.
2. Radiated emissions measured in frequency above 1000MHz were made with an instrument using peak/average detector mode.
3. Average test would be performed if the peak result were greater than the average limit.
4. Data of measurement within this frequency range shown “ --- ” in the table above means the reading of emissions are attenuated more than 20dB below the permissible limits or the field strength is too small to be measured.
5. Measurements above show only up to 6 maximum emissions noted, or would be lesser, with “ N/A ” remark, if no specific emissions from the EUT are recorded (ie: margin>20dB from the applicable limit) and considered that's already beyond the background noise floor.
6. Margin (dB) = Remark result (dBuV/m) – Average limit (dBuV/m).



Operation Mode: Tx / draft 802.11n Wide-40 MHz Channel mode / 5270 ~ 5310MHz / CH Low

Test Date: July 27, 2010

Temperature: 25°C

Tested by: Wolf Huang

Humidity: 50% RH

Polarity: Ver. / Hor.

Frequency (MHz)	Ant.Pol. (H/V)	Reading (Peak) (dBuV)	Reading (Average) (dBuV)	Correction Factor (dB/m)	Result (Peak) (dBuV/m)	Result (Average) (dBuV/m)	Limit (Peak) (dBuV/m)	Limit (Average) (dBuV/m)	Margin (dB)	Remark
2023.33	V	52.41	---	-4.08	48.33	---	74.00	54.00	-5.67	Peak
2553.33	V	51.54	---	-2.50	49.04	---	74.00	54.00	-4.96	Peak
N/A										
1740.00	H	52.24	---	-6.55	45.69	---	74.00	54.00	-8.31	Peak
2053.33	H	52.48	---	-3.99	48.49	---	74.00	54.00	-5.51	Peak
2410.00	H	51.59	---	-2.93	48.66	---	74.00	54.00	-5.34	Peak
N/A										

Remark:

1. Measuring frequencies from 1 GHz to the 10th harmonic of highest fundamental frequency.
2. Radiated emissions measured in frequency above 1000MHz were made with an instrument using peak/average detector mode.
3. Average test would be performed if the peak result were greater than the average limit.
4. Data of measurement within this frequency range shown “ --- ” in the table above means the reading of emissions are attenuated more than 20dB below the permissible limits or the field strength is too small to be measured.
5. Measurements above show only up to 6 maximum emissions noted, or would be lesser, with “ N/A ” remark, if no specific emissions from the EUT are recorded (ie: margin>20dB from the applicable limit) and considered that's already beyond the background noise floor.
6. Margin (dB) = Remark result (dBuV/m) – Average limit (dBuV/m).



Operation Mode: Tx / draft 802.11n Wide-40 MHz Channel mode / 5270 ~ 5310MHz / CH High

Test Date: July 27, 2010

Temperature: 25°C

Tested by: Wolf Huang

Humidity: 50% RH

Polarity: Ver. / Hor.

Frequency (MHz)	Ant.Pol. (H/V)	Reading (Peak) (dBuV)	Reading (Average) (dBuV)	Correction Factor (dB/m)	Result (Peak) (dBuV/m)	Result (Average) (dBuV/m)	Limit (Peak) (dBuV/m)	Limit (Average) (dBuV/m)	Margin (dB)	Remark
2023.33	V	51.79	---	-4.08	47.71	---	74.00	54.00	-6.29	Peak
2363.33	V	51.94	---	-3.07	48.88	---	74.00	54.00	-5.12	Peak
N/A										
1836.67	H	52.85	---	-5.66	47.19	---	74.00	54.00	-6.81	Peak
2010.00	H	52.01	---	-4.12	47.89	---	74.00	54.00	-6.11	Peak
2636.67	H	50.95	---	-2.26	48.69	---	74.00	54.00	-5.31	Peak
N/A										

Remark:

1. Measuring frequencies from 1 GHz to the 10th harmonic of highest fundamental frequency.
2. Radiated emissions measured in frequency above 1000MHz were made with an instrument using peak/average detector mode.
3. Average test would be performed if the peak result were greater than the average limit.
4. Data of measurement within this frequency range shown “ --- ” in the table above means the reading of emissions are attenuated more than 20dB below the permissible limits or the field strength is too small to be measured.
5. Measurements above show only up to 6 maximum emissions noted, or would be lesser, with “ N/A ” remark, if no specific emissions from the EUT are recorded (ie: margin>20dB from the applicable limit) and considered that's already beyond the background noise floor.
6. Margin (dB) = Remark result (dBuV/m) – Average limit (dBuV/m).



Operation Mode: Tx / IEEE 802.11a mode / 5500 ~ 5700MHz / CH Low **Test Date:** July 27, 2010
Temperature: 25°C **Tested by:** Wolf Huang
Humidity: 50% RH **Polarity:** Ver. / Hor.

Frequency (MHz)	Ant.Pol. (H/V)	Reading (Peak) (dBuV)	Reading (Average) (dBuV)	Correction Factor (dB/m)	Result (Peak) (dBuV/m)	Result (Average) (dBuV/m)	Limit (Peak) (dBuV/m)	Limit (Average) (dBuV/m)	Margin (dB)	Remark
1430.00	V	53.41	---	-8.88	44.53	---	74.00	54.00	-9.47	Peak
2070.00	V	52.43	---	-3.94	48.49	---	74.00	54.00	-5.51	Peak
2650.00	V	51.71	---	-2.22	49.49	---	74.00	54.00	-4.51	Peak
N/A										
1910.00	H	53.08	---	-4.98	48.10	---	74.00	54.00	-5.90	Peak
2296.67	H	52.47	---	-3.27	49.21	---	74.00	54.00	-4.79	Peak
N/A										

Remark:

1. Measuring frequencies from 1 GHz to the 10th harmonic of highest fundamental frequency.
2. Radiated emissions measured in frequency above 1000MHz were made with an instrument using peak/average detector mode.
3. Average test would be performed if the peak result were greater than the average limit or as required by the applicant.
4. Data of measurement within this frequency range shown “ --- ” in the table above means the reading of emissions are attenuated more than 20dB below the permissible limits or the field strength is too small to be measured.
5. Measurements above show only up to 6 maximum emissions noted, or would be lesser, with “ N/A ” remark, if no specific emissions from the EUT are recorded (ie: margin>20dB from the applicable limit) and considered that's already beyond the background noise floor.
6. Margin (dB) = Remark result (dBuV/m) – Average limit (dBuV/m).



Operation Mode: Tx / IEEE 802.11a mode / 5500 ~ 5700MHz /CH Mid **Test Date:** July 27, 2010
Temperature: 25°C **Tested by:** Wolf Huang
Humidity: 50% RH **Polarity:** Ver. / Hor.

Frequency (MHz)	Ant.Pol. (H/V)	Reading (Peak) (dBuV)	Reading (Average) (dBuV)	Correction Factor (dB/m)	Result (Peak) (dBuV/m)	Result (Average) (dBuV/m)	Limit (Peak) (dBuV/m)	Limit (Average) (dBuV/m)	Margin (dB)	Remark
2036.67	V	52.49	---	-4.04	48.45	---	74.00	54.00	-5.55	Peak
2743.33	V	51.12	---	-1.95	49.17	---	74.00	54.00	-4.83	Peak
N/A										
1786.67	H	52.70	---	-6.12	46.58	---	74.00	54.00	-7.42	Peak
2203.33	H	52.27	---	-3.54	48.72	---	74.00	54.00	-5.28	Peak
N/A										

Remark:

1. Measuring frequencies from 1 GHz to the 10th harmonic of highest fundamental frequency.
2. Radiated emissions measured in frequency above 1000MHz were made with an instrument using peak/average detector mode.
3. Average test would be performed if the peak result were greater than the average limit.
4. Data of measurement within this frequency range shown " --- " in the table above means the reading of emissions are attenuated more than 20dB below the permissible limits or the field strength is too small to be measured.
5. Measurements above show only up to 6 maximum emissions noted, or would be lesser, with " N/A " remark, if no specific emissions from the EUT are recorded (ie: margin>20dB from the applicable limit) and considered that's already beyond the background noise floor.
6. Margin (dB) = Remark result (dBuV/m) – Average limit (dBuV/m).



Operation Mode: Tx / IEEE 802.11a mode / 5500 ~ 5700MHz / CH High **Test Date:** July 27, 2010
Temperature: 25°C **Tested by:** Wolf Huang
Humidity: 50% RH **Polarity:** Ver. / Hor.

Frequency (MHz)	Ant.Pol. (H/V)	Reading (Peak) (dBuV)	Reading (Average) (dBuV)	Correction Factor (dB/m)	Result (Peak) (dBuV/m)	Result (Average) (dBuV/m)	Limit (Peak) (dBuV/m)	Limit (Average) (dBuV/m)	Margin (dB)	Remark
1806.67	V	52.98	---	-5.93	47.04	---	74.00	54.00	-6.96	Peak
2690.00	V	51.11	---	-2.11	49.01	---	74.00	54.00	-4.99	Peak
11400.00	V	45.58	32.12	16.44	62.02	48.56	74.00	54.00	-5.44	AVG
N/A										
1826.67	H	52.34	---	-5.75	46.59	---	74.00	54.00	-7.41	Peak
2350.00	H	52.13	---	-3.11	49.02	---	74.00	54.00	-4.98	Peak
N/A										

Remark:

1. Measuring frequencies from 1 GHz to the 10th harmonic of highest fundamental frequency.
2. Radiated emissions measured in frequency above 1000MHz were made with an instrument using peak/average detector mode.
3. Average test would be performed if the peak result were greater than the average limit.
4. Data of measurement within this frequency range shown " --- " in the table above means the reading of emissions are attenuated more than 20dB below the permissible limits or the field strength is too small to be measured.
5. Measurements above show only up to 6 maximum emissions noted, or would be lesser, with " N/A " remark, if no specific emissions from the EUT are recorded (ie: margin>20dB from the applicable limit) and considered that's already beyond the background noise floor.
6. Margin (dB) = Remark result (dBuV/m) – Average limit (dBuV/m).



Operation Mode: Tx / draft 802.11n Standard-20 MHz Channel mode / 5500 ~ 5700MHz / CH Low **Test Date:** July 27, 2010

Temperature: 25°C **Tested by:** Wolf Huang

Humidity: 50% RH **Polarity:** Ver. / Hor.

Frequency (MHz)	Ant.Pol. (H/V)	Reading (Peak) (dBuV)	Reading (Average) (dBuV)	Correction Factor (dB/m)	Result (Peak) (dBuV/m)	Result (Average) (dBuV/m)	Limit (Peak) (dBuV/m)	Limit (Average) (dBuV/m)	Margin (dB)	Remark
1463.33	V	53.43	---	-8.82	44.61	---	74.00	54.00	-9.39	Peak
1893.33	V	52.63	---	-5.13	47.50	---	74.00	54.00	-6.50	Peak
2260.00	V	51.84	---	-3.38	48.47	---	74.00	54.00	-5.53	Peak
11000.00	V	42.40	30.37	15.72	58.12	46.09	74.00	54.00	-7.91	AVG
N/A										
2213.33	H	52.29	---	-3.51	48.78	---	74.00	54.00	-5.22	Peak
2686.67	H	51.31	---	-2.11	49.20	---	74.00	54.00	-4.80	Peak
N/A										

Remark:

1. Measuring frequencies from 1 GHz to the 10th harmonic of highest fundamental frequency.
2. Radiated emissions measured in frequency above 1000MHz were made with an instrument using peak/average detector mode.
3. Average test would be performed if the peak result were greater than the average limit or as required by the applicant.
4. Data of measurement within this frequency range shown “ --- ” in the table above means the reading of emissions are attenuated more than 20dB below the permissible limits or the field strength is too small to be measured.
5. Measurements above show only up to 6 maximum emissions noted, or would be lesser, with “ N/A ” remark, if no specific emissions from the EUT are recorded (ie: margin>20dB from the applicable limit) and considered that's already beyond the background noise floor.
6. Margin (dB) = Remark result (dBuV/m) – Average limit (dBuV/m).



Operation Mode: Tx / draft 802.11n Standard-20 MHz Channel mode / 5500 ~ 5700MHz / CH Mid **Test Date:** July 27, 2010

Temperature: 25°C **Tested by:** Wolf Huang

Humidity: 50% RH **Polarity:** Ver. / Hor.

Frequency (MHz)	Ant.Pol. (H/V)	Reading (Peak) (dBuV)	Reading (Average) (dBuV)	Correction Factor (dB/m)	Result (Peak) (dBuV/m)	Result (Average) (dBuV/m)	Limit (Peak) (dBuV/m)	Limit (Average) (dBuV/m)	Margin (dB)	Remark
1723.33	V	53.33	---	-6.70	46.63	---	74.00	54.00	-7.37	Peak
2050.00	V	52.08	---	-4.00	48.08	---	74.00	54.00	-5.92	Peak
N/A										
2303.33	H	51.33	---	-3.25	48.08	---	74.00	54.00	-5.92	Peak
2540.00	H	51.43	---	-2.54	48.89	---	74.00	54.00	-5.11	Peak
N/A										

Remark:

1. Measuring frequencies from 1 GHz to the 10th harmonic of highest fundamental frequency.
2. Radiated emissions measured in frequency above 1000MHz were made with an instrument using peak/average detector mode.
3. Average test would be performed if the peak result were greater than the average limit.
4. Data of measurement within this frequency range shown " --- " in the table above means the reading of emissions are attenuated more than 20dB below the permissible limits or the field strength is too small to be measured.
5. Measurements above show only up to 6 maximum emissions noted, or would be lesser, with " N/A " remark, if no specific emissions from the EUT are recorded (ie: margin>20dB from the applicable limit) and considered that's already beyond the background noise floor.
6. Margin (dB) = Remark result (dBuV/m) – Average limit (dBuV/m).



Operation Mode: Tx / draft 802.11n Standard-20 MHz Channel mode / 5500 ~ 5700MHz / CH High **Test Date:** July 27, 2010

Temperature: 25°C **Tested by:** Wolf Huang

Humidity: 50% RH **Polarity:** Ver. / Hor.

Frequency (MHz)	Ant.Pol. (H/V)	Reading (Peak) (dBuV)	Reading (Average) (dBuV)	Correction Factor (dB/m)	Result (Peak) (dBuV/m)	Result (Average) (dBuV/m)	Limit (Peak) (dBuV/m)	Limit (Average) (dBuV/m)	Margin (dB)	Remark
1856.67	V	52.49	---	-5.47	47.02	---	74.00	54.00	-6.98	Peak
2496.67	V	51.42	---	-2.67	48.75	---	74.00	54.00	-5.25	Peak
11400.00	V	42.02	30.69	16.44	58.46	47.13	74.00	54.00	-6.87	AVG
1360.00	H	53.53	---	-8.99	44.54	---	74.00	54.00	-9.46	Peak
2053.33	H	52.27	---	-3.99	48.28	---	74.00	54.00	-5.72	Peak
2243.33	H	51.96	---	-3.42	48.54	---	74.00	54.00	-5.46	Peak
11450.00	H	41.43	29.16	16.53	57.96	45.69	74.00	54.00	-8.31	AVG
N/A										

Remark:

1. Measuring frequencies from 1 GHz to the 10th harmonic of highest fundamental frequency.
2. Radiated emissions measured in frequency above 1000MHz were made with an instrument using peak/average detector mode.
3. Average test would be performed if the peak result were greater than the average limit or as required by the applicant.
4. Data of measurement within this frequency range shown “ --- ” in the table above means the reading of emissions are attenuated more than 20dB below the permissible limits or the field strength is too small to be measured.
5. Measurements above show only up to 6 maximum emissions noted, or would be lesser, with “ N/A ” remark, if no specific emissions from the EUT are recorded (ie: margin>20dB from the applicable limit) and considered that's already beyond the background noise floor.
6. Margin (dB) = Remark result (dBuV/m) – Average limit (dBuV/m).



Operation Mode: Tx / draft 802.11n Wide-40 MHz Channel mode / 5510 ~ 5670MHz / CH Low

Test Date: July 27, 2010

Temperature: 25°C

Tested by: Wolf Huang

Humidity: 50% RH

Polarity: Ver. / Hor.

Frequency (MHz)	Ant.Pol. (H/V)	Reading (Peak) (dBuV)	Reading (Average) (dBuV)	Correction Factor (dB/m)	Result (Peak) (dBuV/m)	Result (Average) (dBuV/m)	Limit (Peak) (dBuV/m)	Limit (Average) (dBuV/m)	Margin (dB)	Remark
1873.33	V	52.37	---	-5.32	47.05	---	74.00	54.00	-6.95	Peak
2606.67	V	51.42	---	-2.35	49.07	---	74.00	54.00	-4.93	Peak
N/A										
1856.67	H	52.79	---	-5.47	47.32	---	74.00	54.00	-6.68	Peak
2516.67	H	51.90	---	-2.61	49.29	---	74.00	54.00	-4.71	Peak
2656.67	H	51.66	---	-2.20	49.45	---	74.00	54.00	-4.55	Peak
N/A										

Remark:

1. Measuring frequencies from 1 GHz to the 10th harmonic of highest fundamental frequency.
2. Radiated emissions measured in frequency above 1000MHz were made with an instrument using peak/average detector mode.
3. Average test would be performed if the peak result were greater than the average limit or as required by the applicant.
4. Data of measurement within this frequency range shown “ --- ” in the table above means the reading of emissions are attenuated more than 20dB below the permissible limits or the field strength is too small to be measured.
5. Measurements above show only up to 6 maximum emissions noted, or would be lesser, with “ N/A ” remark, if no specific emissions from the EUT are recorded (ie: margin>20dB from the applicable limit) and considered that's already beyond the background noise floor.
6. Margin (dB) = Remark result (dBuV/m) – Average limit (dBuV/m).



Operation Mode: Tx / draft 802.11n Wide-40 MHz Channel mode / 5510 ~ 5670MHz / CH Mid

Test Date: July 27, 2010

Temperature: 25°C

Tested by: Wolf Huang

Humidity: 50% RH

Polarity: Ver. / Hor.

Frequency (MHz)	Ant.Pol. (H/V)	Reading (Peak) (dBuV)	Reading (Average) (dBuV)	Correction Factor (dB/m)	Result (Peak) (dBuV/m)	Result (Average) (dBuV/m)	Limit (Peak) (dBuV/m)	Limit (Average) (dBuV/m)	Margin (dB)	Remark
2023.33	V	51.67	---	-4.08	47.59	---	74.00	54.00	-6.41	Peak
2523.33	V	51.24	---	-2.59	48.65	---	74.00	54.00	-5.35	Peak
N/A										
1860.00	H	52.20	---	-5.44	46.76	---	74.00	54.00	-7.24	Peak
2620.00	H	51.46	---	-2.31	49.15	---	74.00	54.00	-4.85	Peak
N/A										

Remark:

1. Measuring frequencies from 1 GHz to the 10th harmonic of highest fundamental frequency.
2. Radiated emissions measured in frequency above 1000MHz were made with an instrument using peak/average detector mode.
3. Average test would be performed if the peak result were greater than the average limit or as required by the applicant.
4. Data of measurement within this frequency range shown “ --- ” in the table above means the reading of emissions are attenuated more than 20dB below the permissible limits or the field strength is too small to be measured.
5. Measurements above show only up to 6 maximum emissions noted, or would be lesser, with “ N/A ” remark, if no specific emissions from the EUT are recorded (ie: margin>20dB from the applicable limit) and considered that's already beyond the background noise floor.
6. Margin (dB) = Remark result (dBuV/m) – Average limit (dBuV/m).



Operation Mode: Tx / draft 802.11n Wide-40 MHz Channel mode / 5510 ~ 5670MHz / CH High

Test Date: July 27, 2010

Temperature: 25°C

Tested by: Wolf Huang

Humidity: 50% RH

Polarity: Ver. / Hor.

Frequency (MHz)	Ant.Pol. (H/V)	Reading (Peak) (dBuV)	Reading (Average) (dBuV)	Correction Factor (dB/m)	Result (Peak) (dBuV/m)	Result (Average) (dBuV/m)	Limit (Peak) (dBuV/m)	Limit (Average) (dBuV/m)	Margin (dB)	Remark
1993.33	V	52.84	---	-4.21	48.63	---	74.00	54.00	-5.37	Peak
2250.00	V	51.94	---	-3.41	48.54	---	74.00	54.00	-5.46	Peak
11333.33	V	44.95	31.43	16.32	61.27	47.75	74.00	54.00	-6.25	AVG
N/A										
2040.00	H	51.95	---	-4.03	47.91	---	74.00	54.00	-6.09	Peak
2386.67	H	51.92	---	-3.00	48.92	---	74.00	54.00	-5.08	Peak
N/A										

Remark:

1. Measuring frequencies from 1 GHz to the 10th harmonic of highest fundamental frequency.
2. Radiated emissions measured in frequency above 1000MHz were made with an instrument using peak/average detector mode.
3. Average test would be performed if the peak result were greater than the average limit or as required by the applicant.
4. Data of measurement within this frequency range shown “ --- ” in the table above means the reading of emissions are attenuated more than 20dB below the permissible limits or the field strength is too small to be measured.
5. Measurements above show only up to 6 maximum emissions noted, or would be lesser, with “ N/A ” remark, if no specific emissions from the EUT are recorded (ie: margin>20dB from the applicable limit) and considered that's already beyond the background noise floor.
6. $Margin (dB) = Remark\ result (dBuV/m) - Average\ limit (dBuV/m)$.



7.7 CONDUCTED UNDESIRABLE EMISSION

LIMIT

According to 15.407(b),

- (1) For transmitters operating in the 5.15-5.25 GHz band: all emissions outside of the 5.15-5.35 GHz band shall not exceed an EIRP of -27 dBm/MHz.
- (2) For transmitters operating in the 5.25-5.35 GHz band: all emissions outside of the 5.15-5.35 GHz band shall not exceed an EIRP of -27 dBm/MHz. Devices operating in the 5.25-5.35 GHz band that generate emissions in the 5.15-5.25 GHz band must meet all applicable technical requirements for operation in the 5.15-5.25 GHz band (including indoor use) or alternatively meet an out-of-band emission EIRP limit of -27 dBm/MHz in the 5.15-5.25 GHz band.

The provisions of §15.205 apply to intentional radiators operating under this section.

Test Configuration

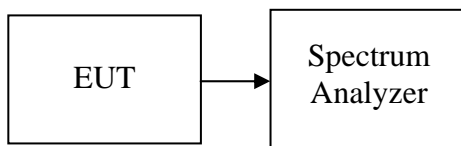

TEST PROCEDURE

Conducted RF measurements of the transmitter output were made to confirm that the EUT antenna port conducted emissions meet the specified limit and to identify any spurious signals that require further investigation or measurements on the radiated emissions site.

The transmitter output is connected to the spectrum analyzer. The resolution bandwidth is set to 1 MHz. The video bandwidth is set to 1 MHz. Peak detection measurements are compared to the average EIRP limit, adjusted for the maximum antenna gain. If necessary, additional average detection measurements are made.

Measurements are made over the 30 MHz to 40 GHz range with the transmitter set to the lowest, middle, and highest channels.

TEST RESULTS

No non-compliance noted



Test Plot

IEEE 802.11a mode / 5180 ~ 5240MHz

CH Low

30MHz ~ 40GHz

Agilent 17:07:18 Jul 27, 2010

R L

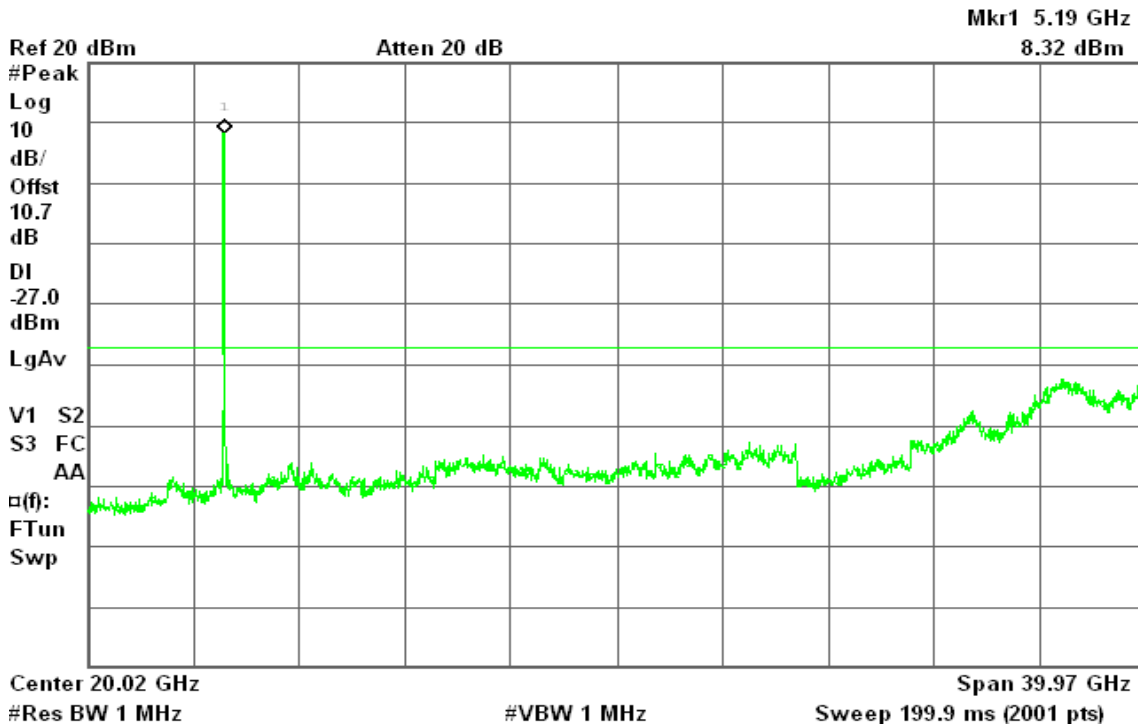

CH Mid

30MHz ~ 40GHz

Agilent 17:12:49 Jul 27, 2010

R T

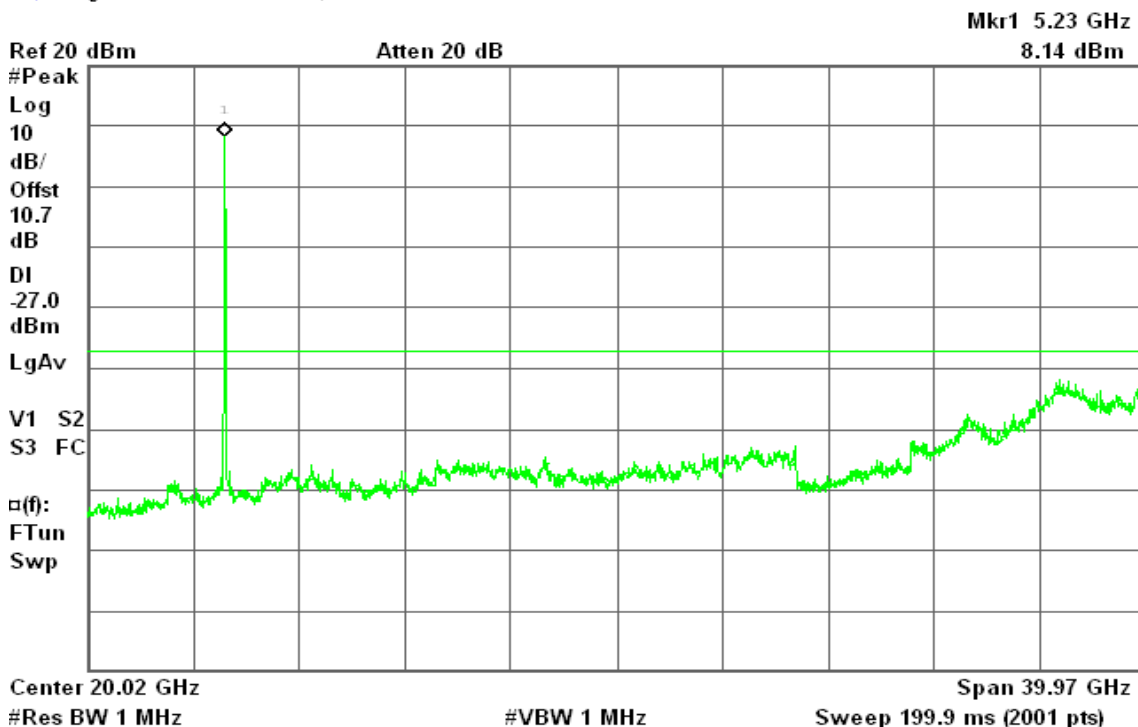



CH High

30MHz ~ 40GHz

Agilent 17:17:58 Jul 27, 2010

R T

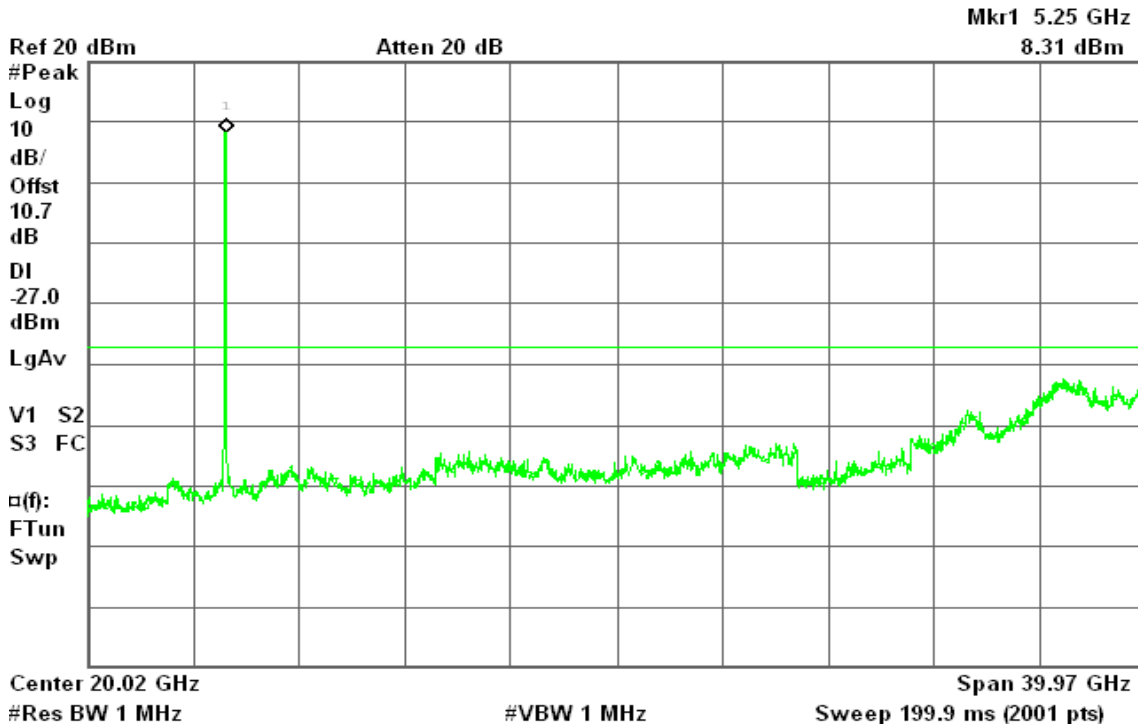

draft 802.11n Standard-20 MHz Channel mode / 5180 ~ 5240MHz

CH Low

30MHz ~ 40GHz

Agilent 14:51:30 Jul 28, 2010

R L

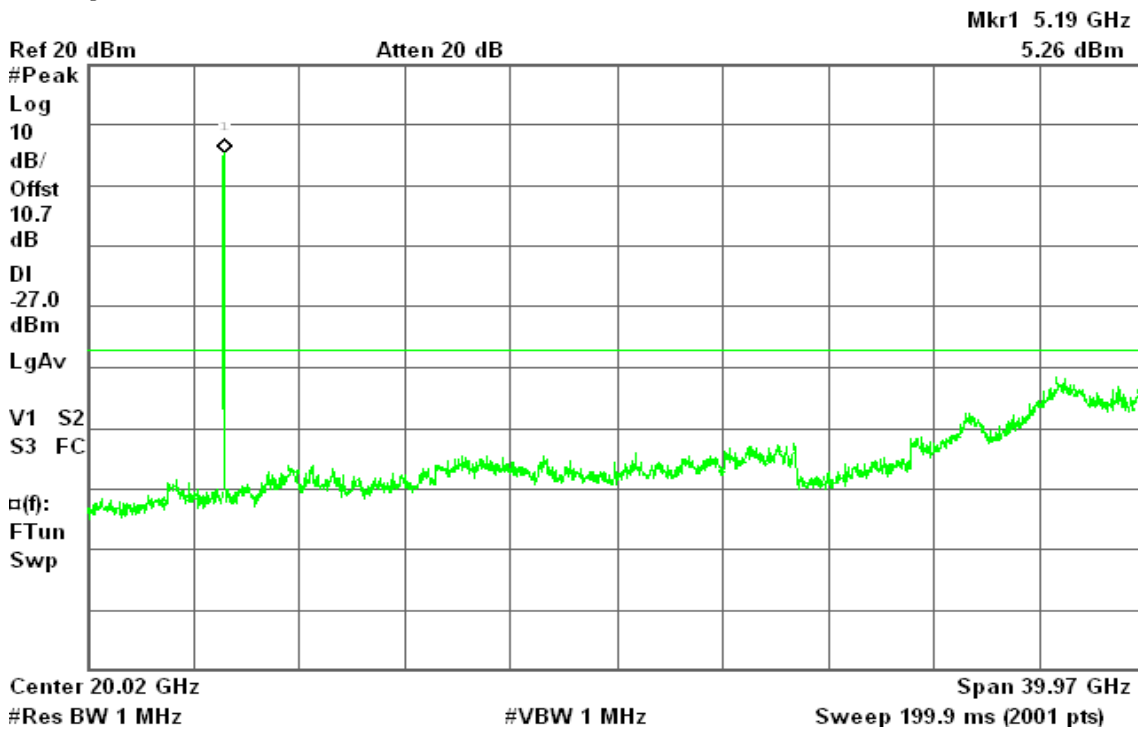



CH Mid

30MHz ~ 40GHz

Agilent 14:53:33 Jul 28, 2010

R T

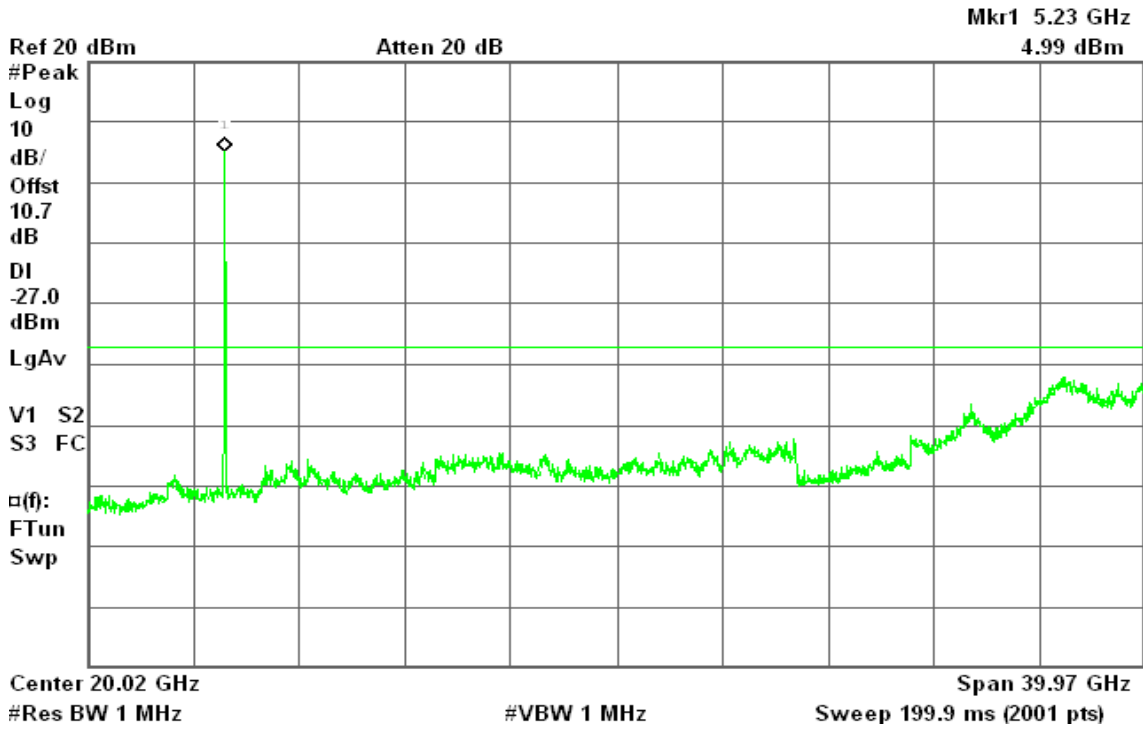

CH High

30MHz ~ 40GHz

Agilent 14:37:40 Jul 28, 2010

R T

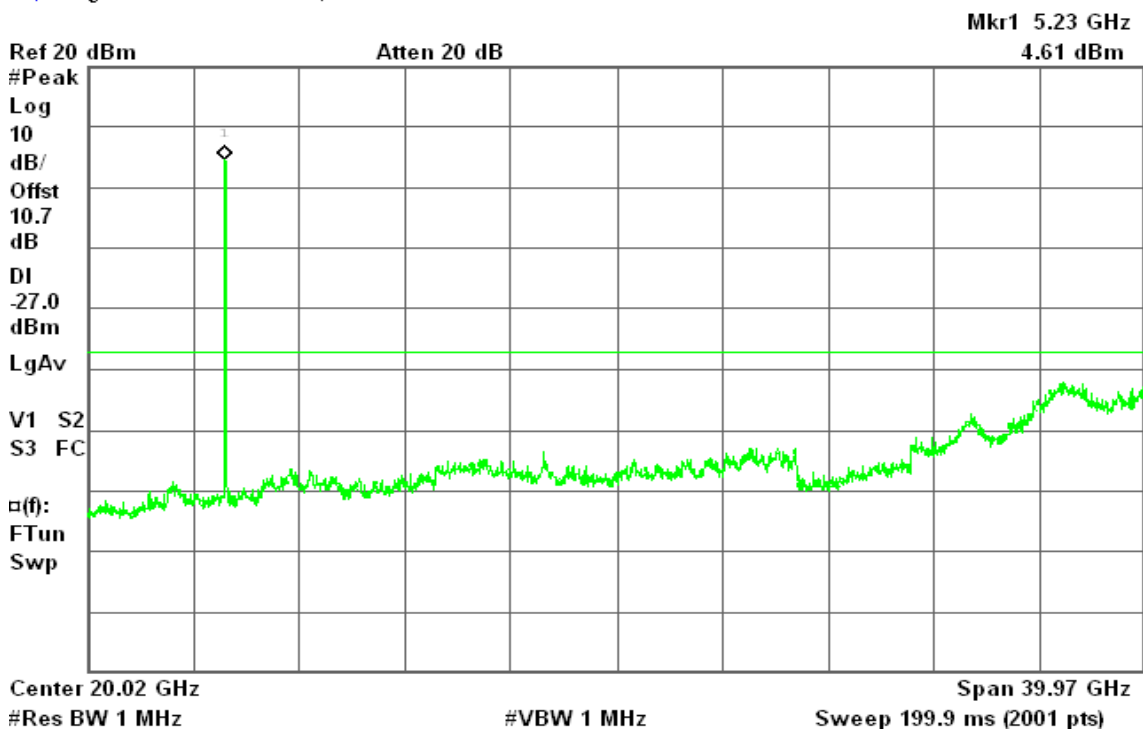



draft 802.11n Wide-40 MHz Channel mode / 5190 ~ 5230MHz

CH Low

30MHz ~ 40GHz

Agilent 17:04:51 Jul 28, 2010

R T

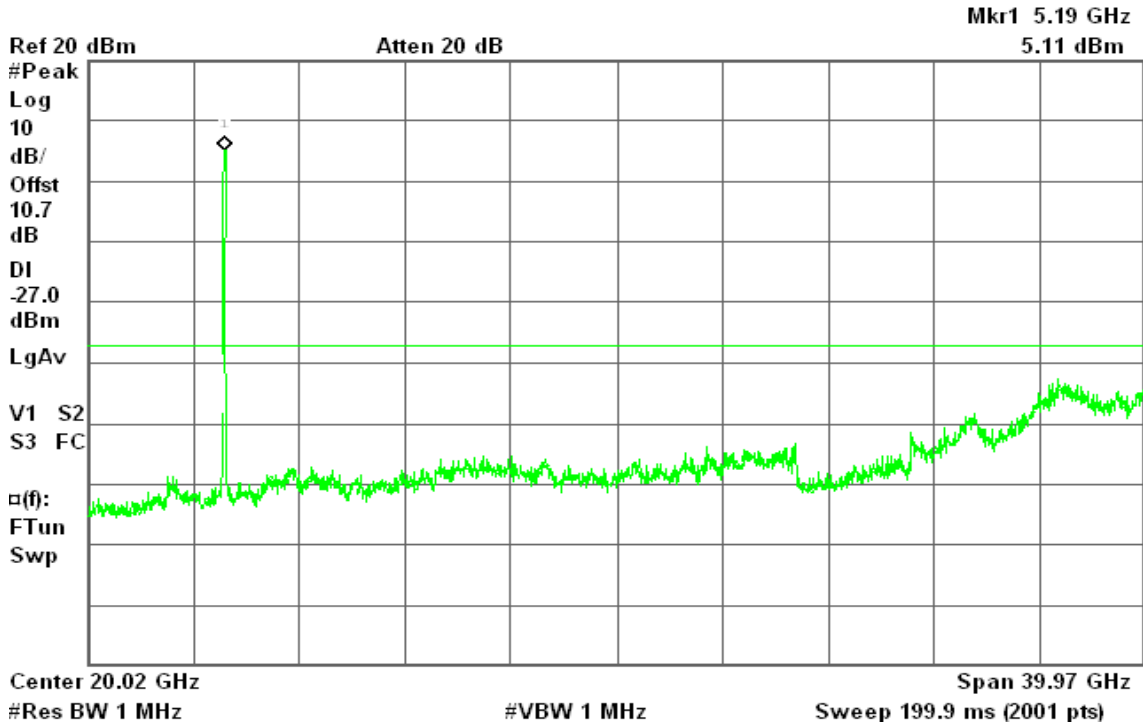

CH High

30MHz ~ 40GHz

Agilent 17:10:06 Jul 28, 2010

R T

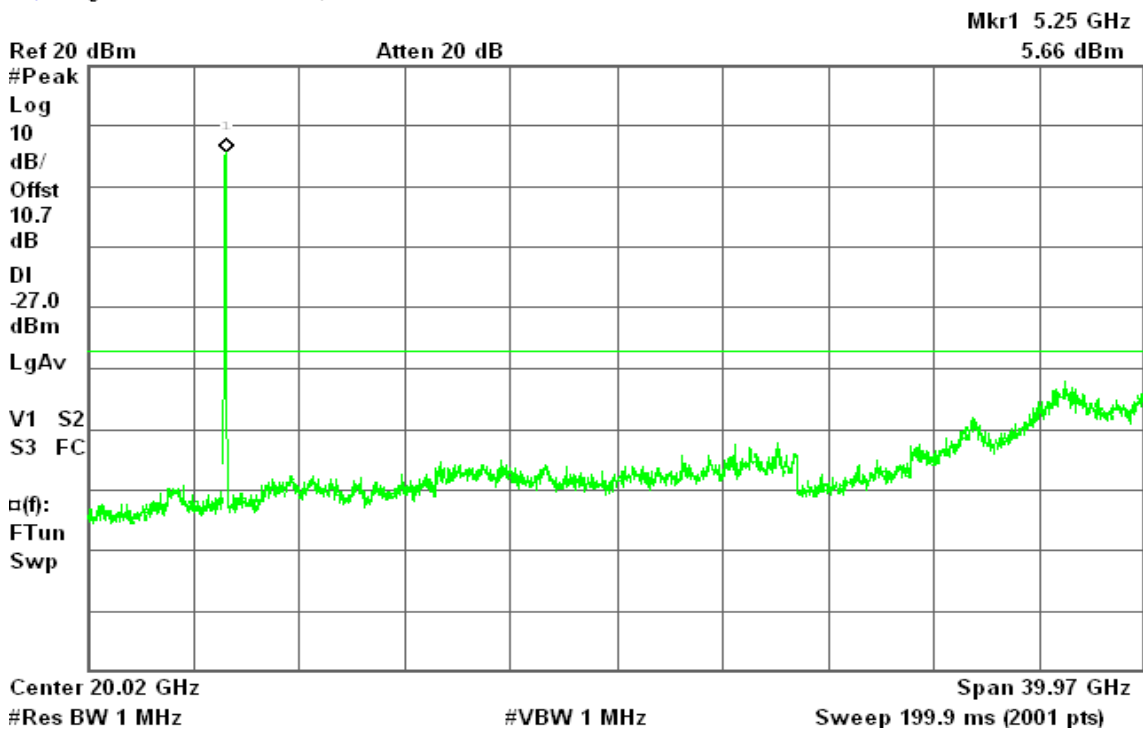



CH High

30MHz ~ 40GHz

Agilent 10:54:42 Jul 28, 2010

R T

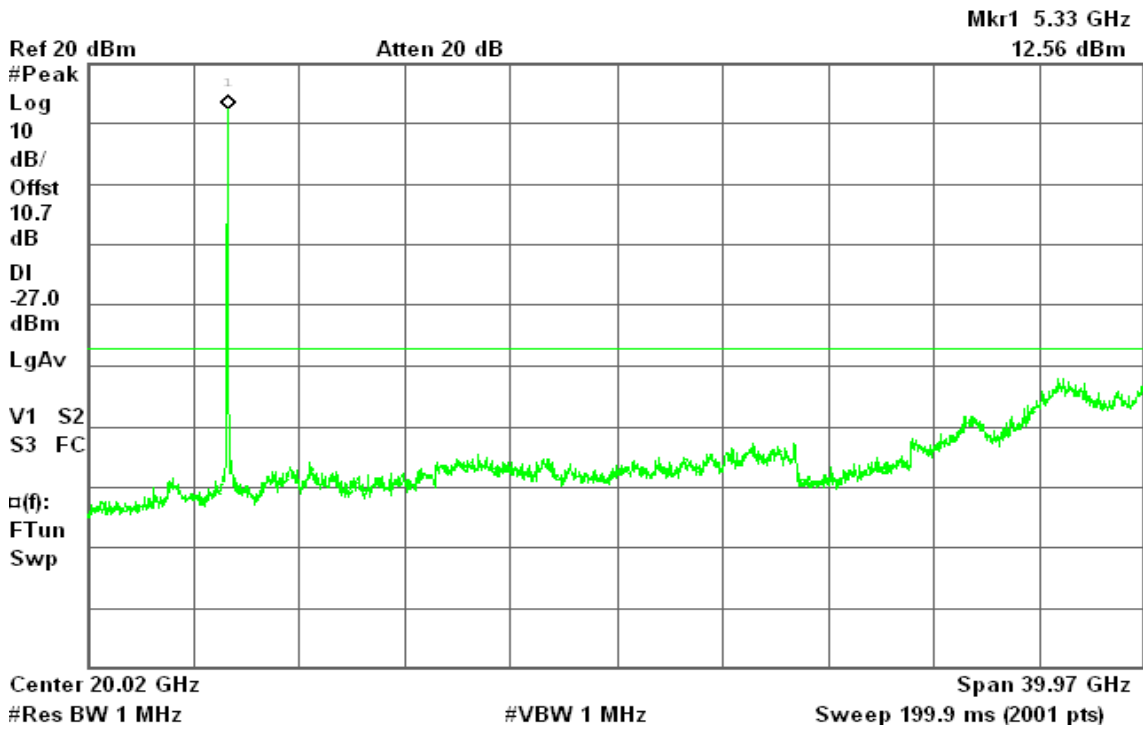

draft 802.11n Standard-20 MHz Channel mode / 5260 ~ 5320MHz

CH Low

30MHz ~ 40GHz

Agilent 14:59:24 Jul 28, 2010

R T

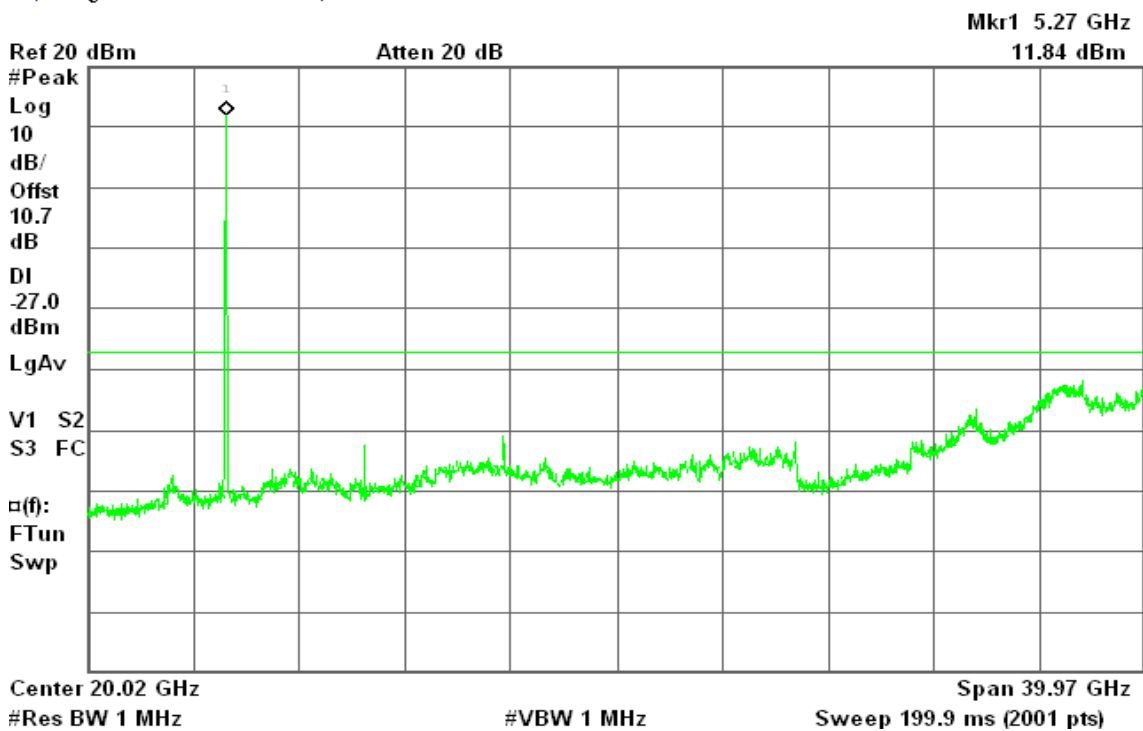



CH Mid 30MHz ~ 40GHz

Agilent 15:02:56 Jul 28, 2010

R T

Mkr1 5.29 GHz
12.30 dBm

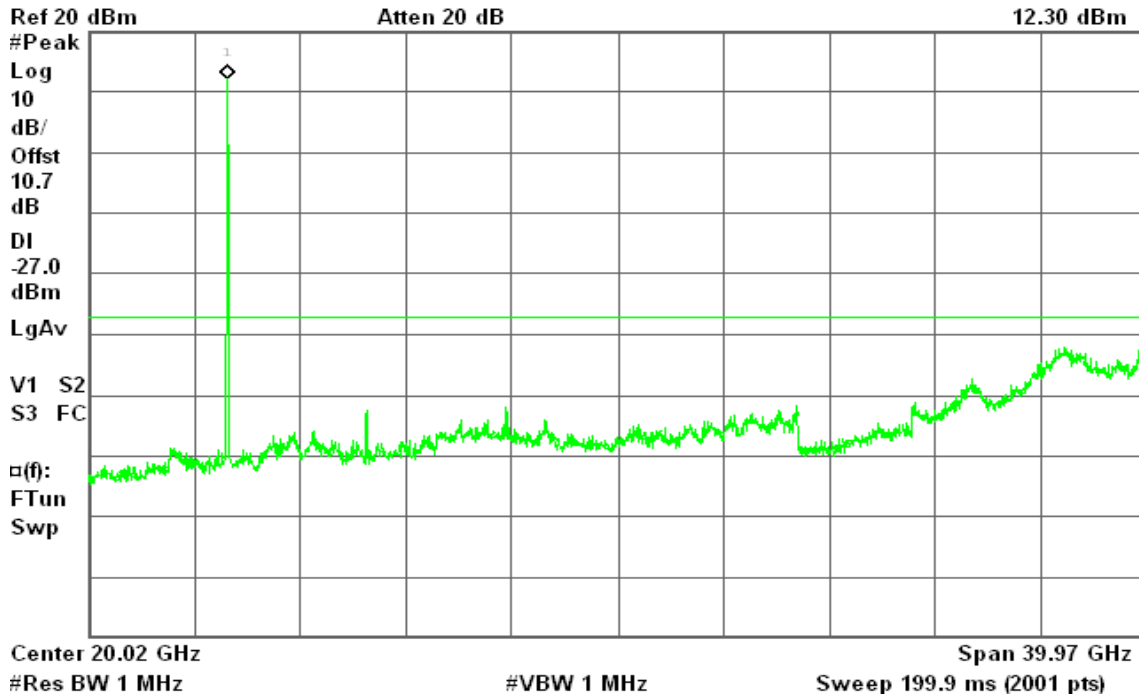

CH High 30MHz ~ 40GHz

Agilent 15:05:01 Jul 28, 2010

R T

Mkr1 5.31 GHz
12.50 dBm

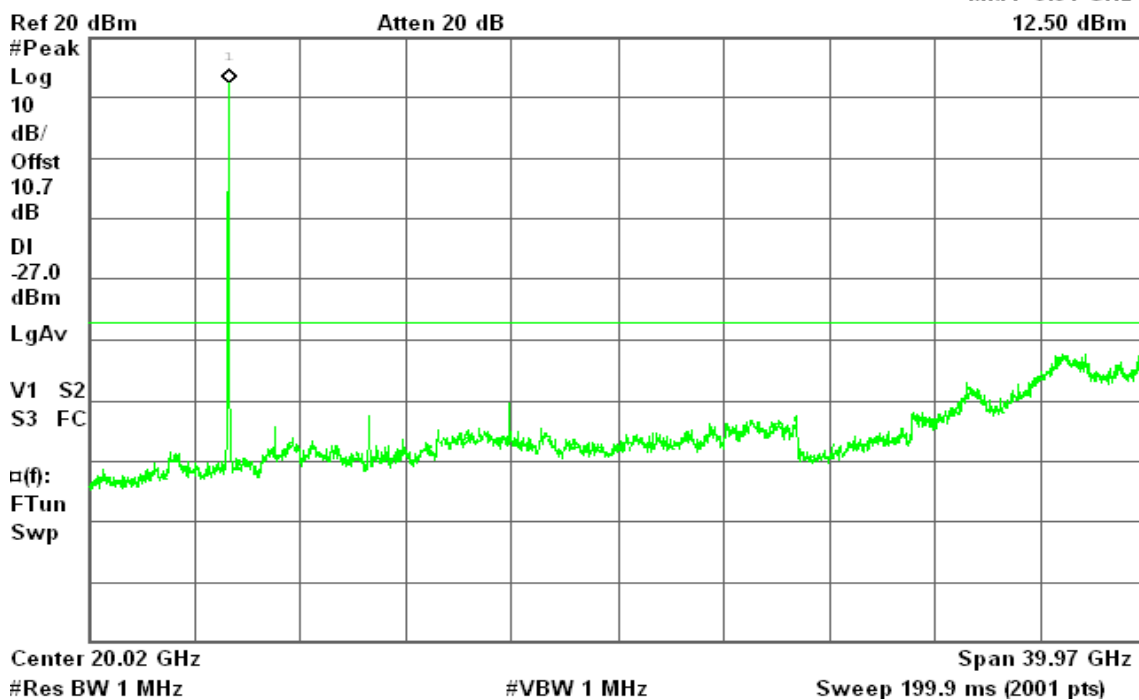



Test mode: IEEE 802.11a mode / 5500 ~ 5700MHz

CH Low

30MHz ~ 40GHz

Agilent 11:01:58 Jul 28, 2010

R T

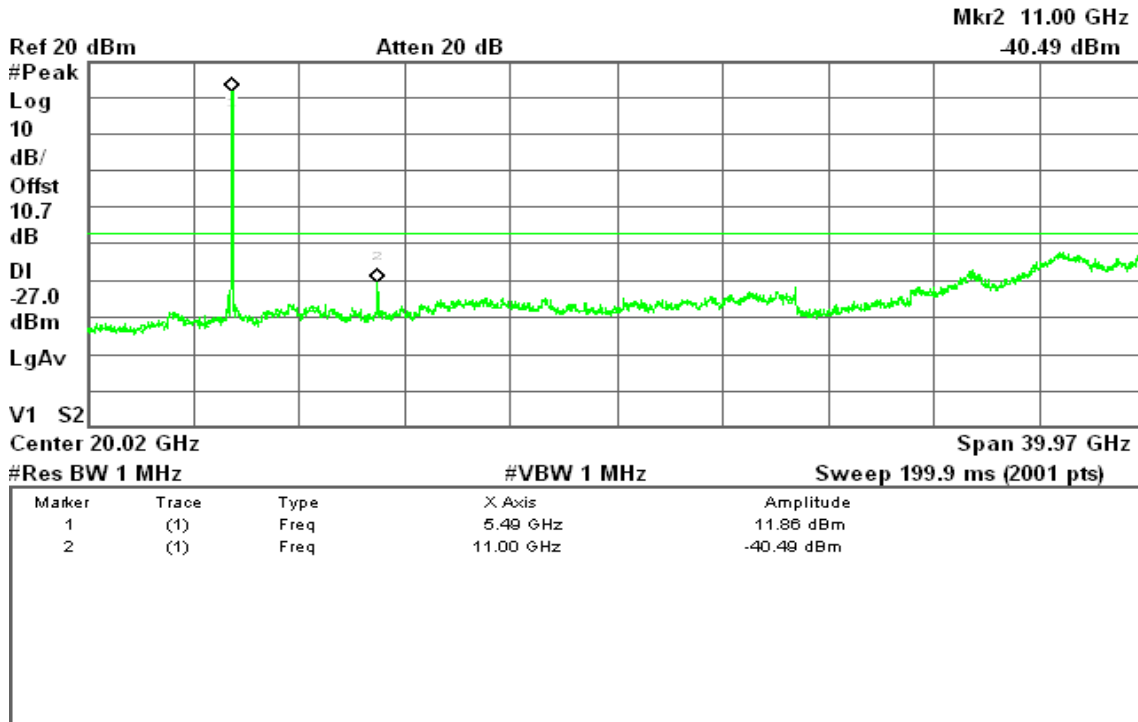

CH Mid

30MHz ~ 40GHz

Agilent 11:04:33 Jul 28, 2010

R T

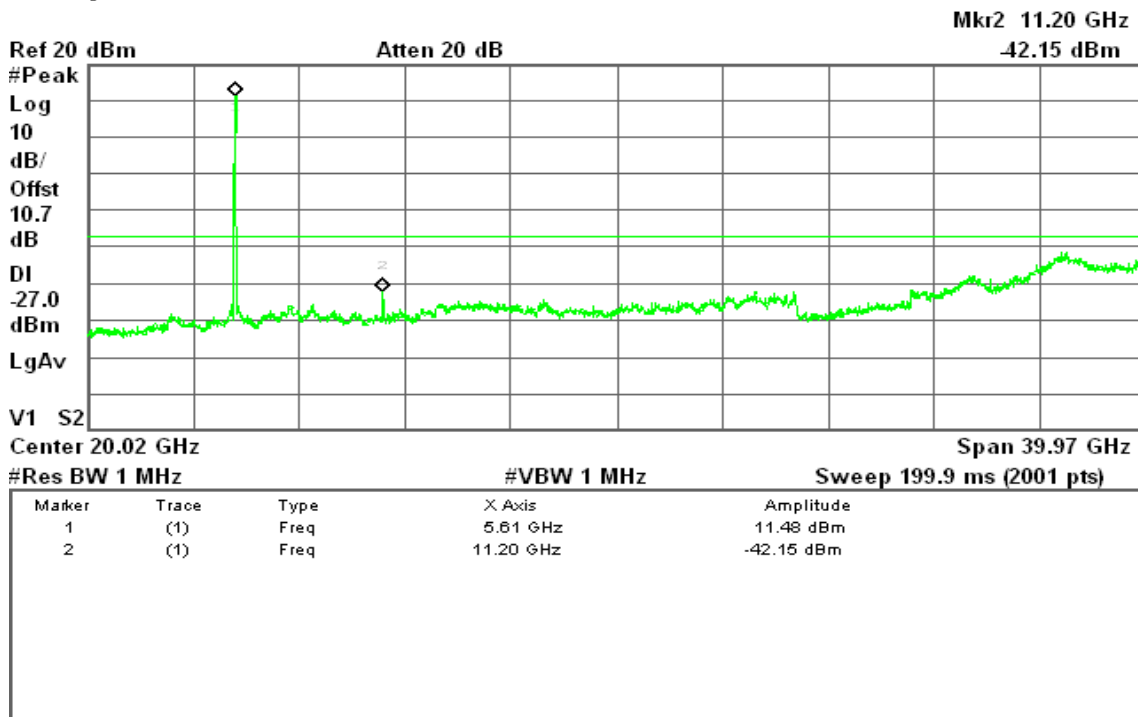



CH Mid

30MHz ~ 40GHz

Agilent 15:12:44 Jul 28, 2010

R T

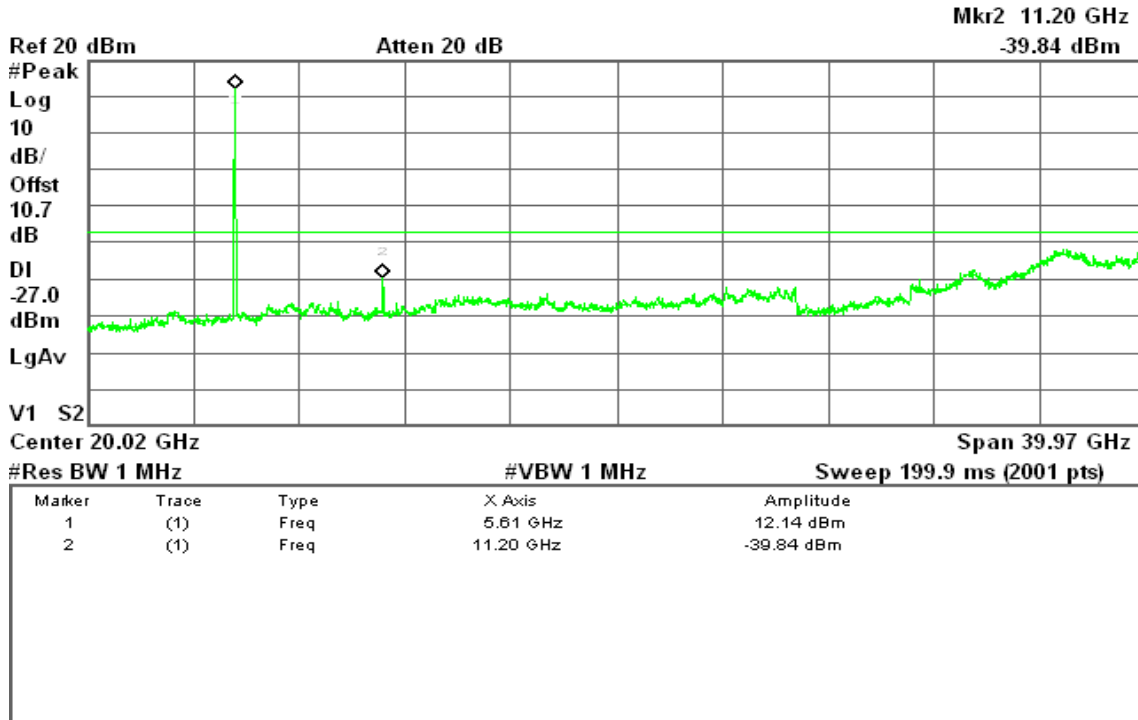

CH High

30MHz ~ 40GHz

Agilent 15:15:29 Jul 28, 2010

R T

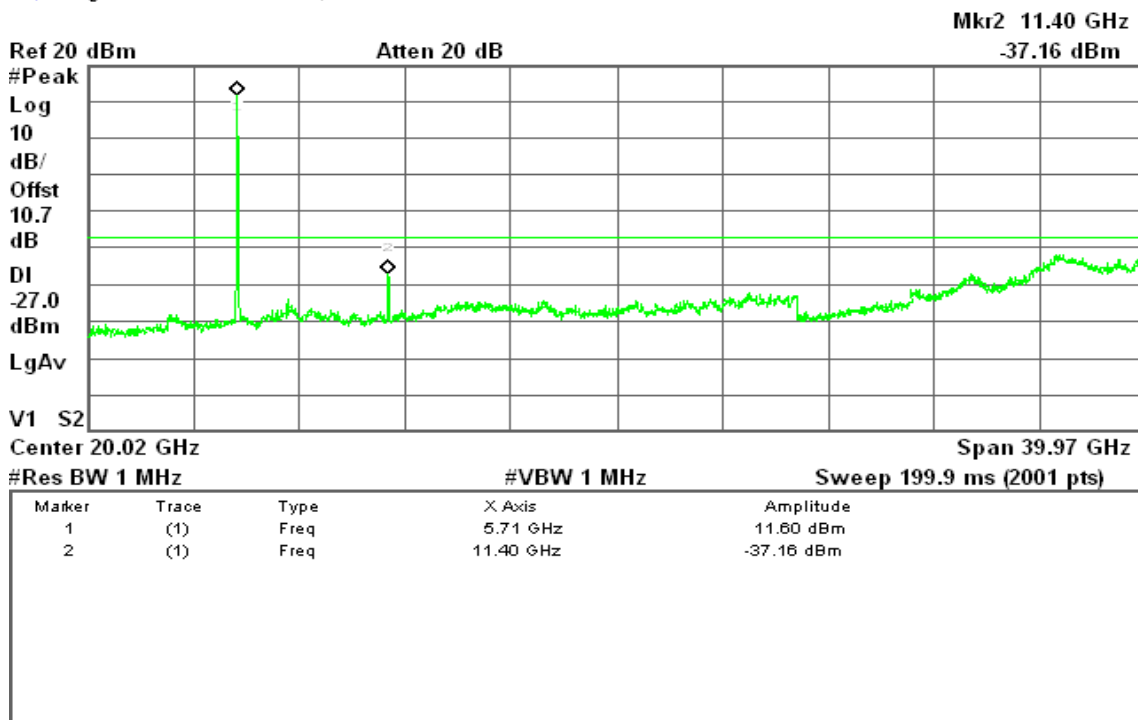



draft 802.11n Wide-40 MHz Channel mode / 5510 ~ 5670MHz

CH Low

30MHz ~ 40GHz

Agilent 17:22:20 Jul 28, 2010

R T

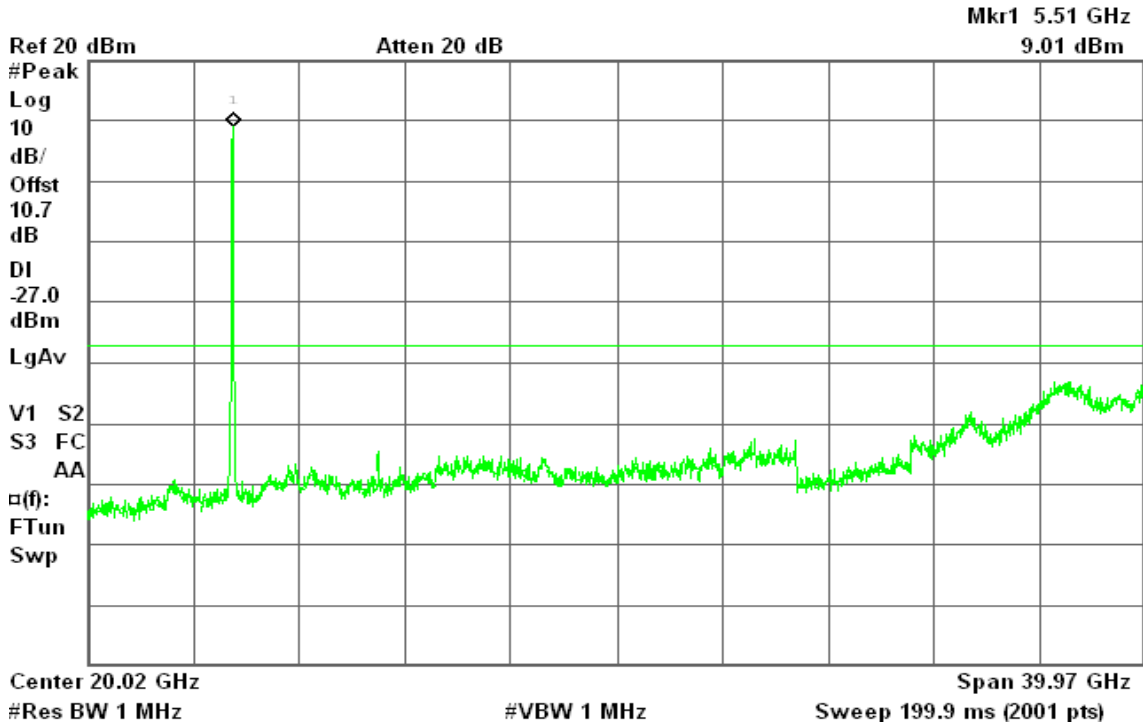

CH Mid

30MHz ~ 40GHz

Agilent 17:25:01 Jul 28, 2010

R T

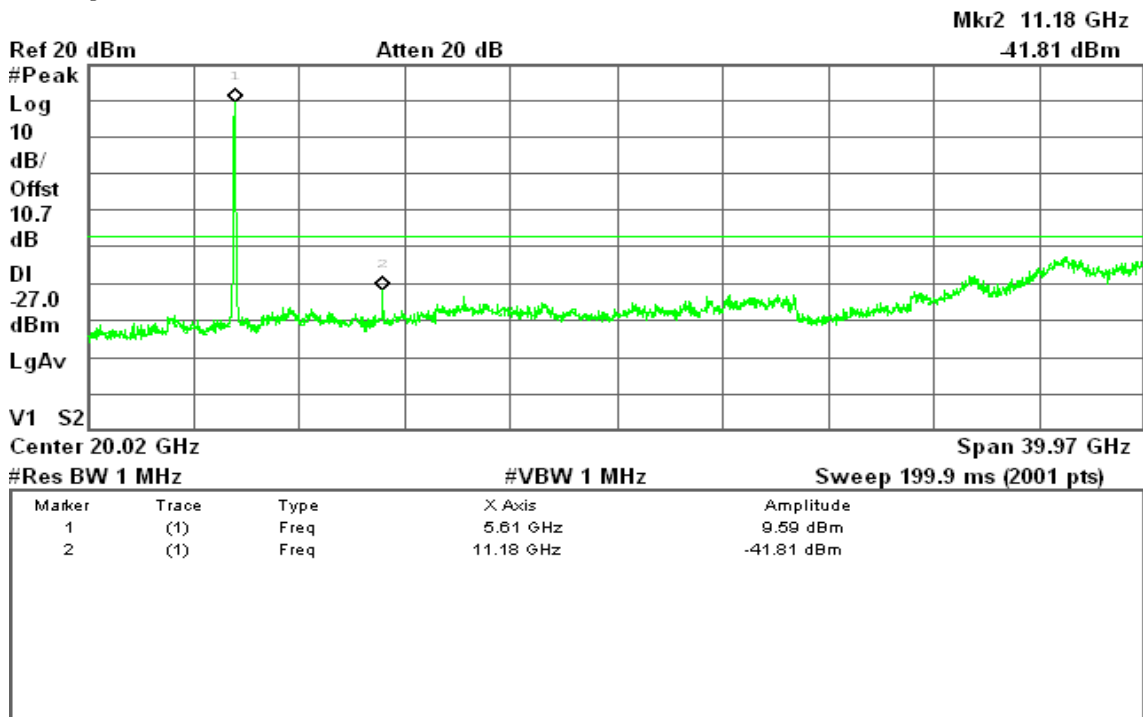



CH High 30MHz ~ 40GHz

Agilent 17:27:05 Jul 28, 2010

R T

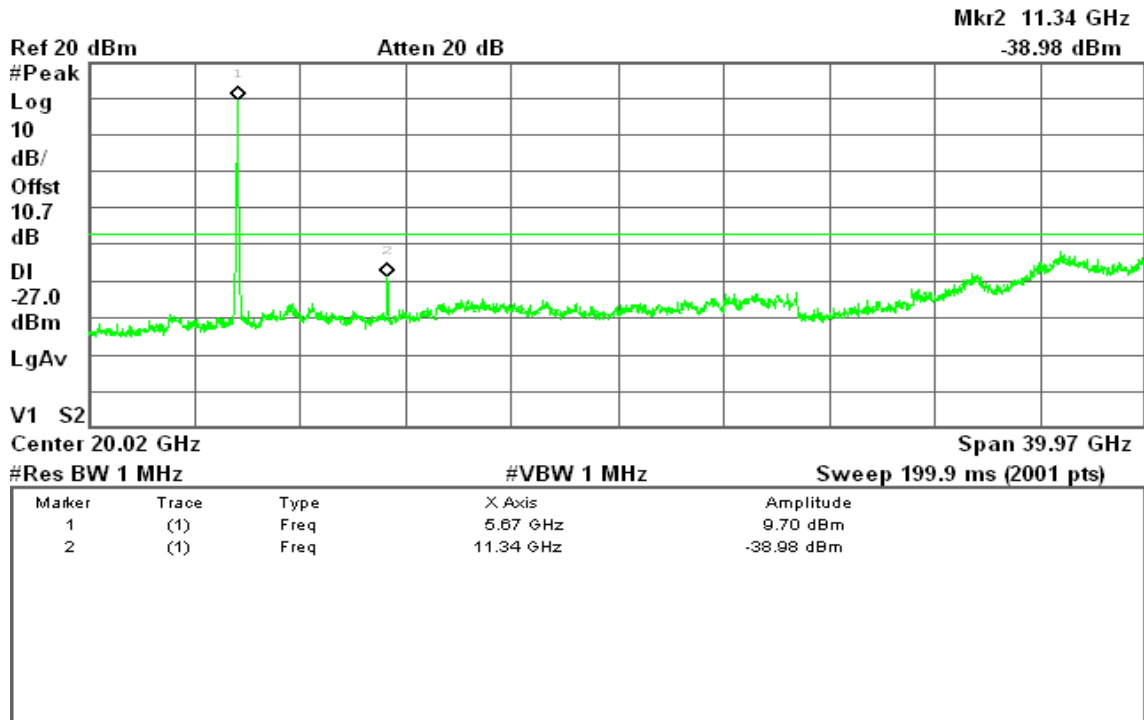



7.8 POWERLINE CONDUCTED EMISSIONS

LIMIT

According to §15.207(a), except as shown in paragraphs (b) and (c) of this section, for an intentional radiator that is designed to be connected to the public utility (AC) power line, the radio frequency voltage that is conducted back onto the AC power line on any frequency or frequencies within the band 150 kHz to 30 MHz shall not exceed the limits in the following table, as measured using a 50 μ H/50 ohms line impedance stabilization network (LISN). Compliance with the provisions of this paragraph shall be based on the measurement of the radio frequency voltage between each power line and ground at the power terminal. The lower limit applies at the boundary between the frequency ranges.

Frequency Range (MHz)	Limits (dB μ V)	
	Quasi-peak	Average
0.15 to 0.50	66 to 56*	56 to 46*
0.50 to 5	56	46
5 to 30	60	50

* Decreases with the logarithm of the frequency.

TEST CONFIGURATION

See test photographs attached in Appendix 1 for the actual connections between EUT and support equipment.

TEST PROCEDURE

1. The EUT was placed on a table, which is 0.8m above ground plane.
2. Maximum procedure was performed on the six highest emissions to ensure EUT compliance.
3. Repeat above procedures until all frequency measured were complete.

TEST RESULTS

The initial step in collecting conducted data is a spectrum analyzer peak scan of the measurement range. Significant peaks are then marked as shown on the following data page, and these signals are then quasi-peaked.



Test Data

Operation Mode: Normal Link
Temperature: 19°C
Humidity: 66% RH

Test Date: August 23, 2010
Tested by: Vic Lin
Line: L1

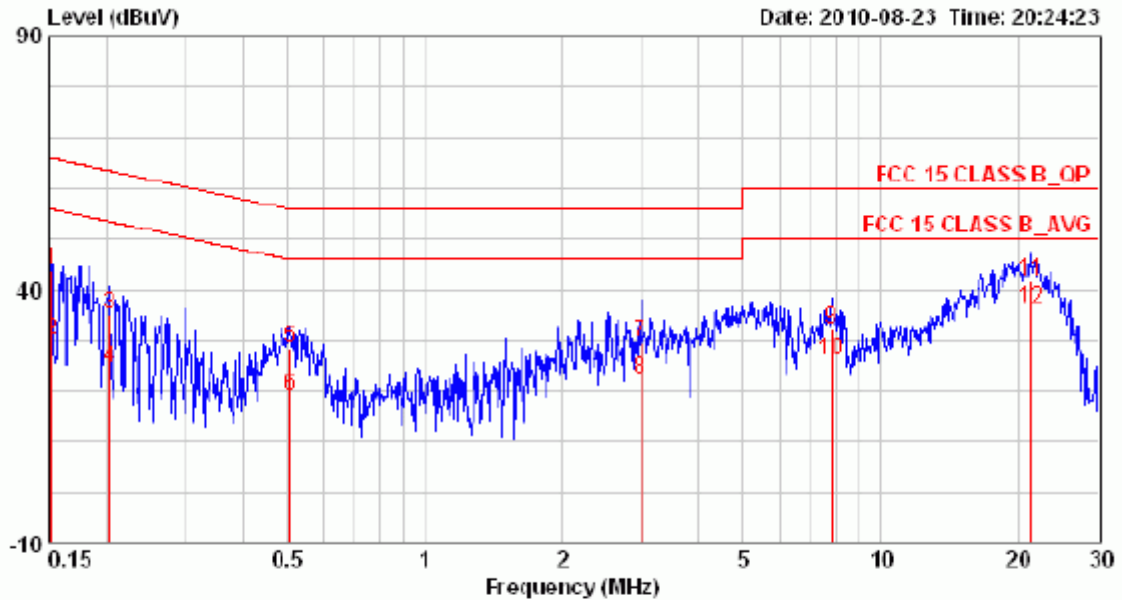

Freq. MHz	Corr. Factor dB	Reading Value dBuV		Emission Level dBuV		Limit dBuV		Margin dB	
		Q. P.	Ave.	Q. P.	Ave.	Q. P.	Ave.	Q. P.	Ave.
0.152	0.05	43.04	29.90	43.09	29.95	65.91	55.91	-22.02	-25.96
0.203	0.06	34.96	24.26	35.02	24.32	63.49	53.49	-28.47	-29.17
0.507	0.06	28.34	18.70	28.40	18.76	56.00	46.00	-27.60	-27.24
2.978	0.16	29.54	22.02	29.70	22.18	56.00	46.00	-26.30	-23.82
7.810	0.29	31.83	25.77	32.12	26.06	60.00	50.00	-27.88	-23.94
21.373	0.53	41.18	35.60	41.71	36.13	60.00	50.00	-18.29	-13.87

Remark:

1. Measuring frequencies from 0.15 MHz to 30MHz.
2. The emissions measured in frequency range from 0.15 MHz to 30MHz were made with an instrument using Quasi-peak detector and average detector.
3. The IF bandwidth of SPA between 0.15MHz and 30MHz was 10kHz; the IF bandwidth of Test Receiver between 0.15MHz and 30MHz was 9kHz;
4. L1 = Line One (Live Line) / L2 = Line Two (Neutral Line)



Operation Mode: Normal Link

Test Date: August 23, 2010

Temperature: 19°C

Tested by: Vic Lin

Humidity: 66% RH

Line: L2

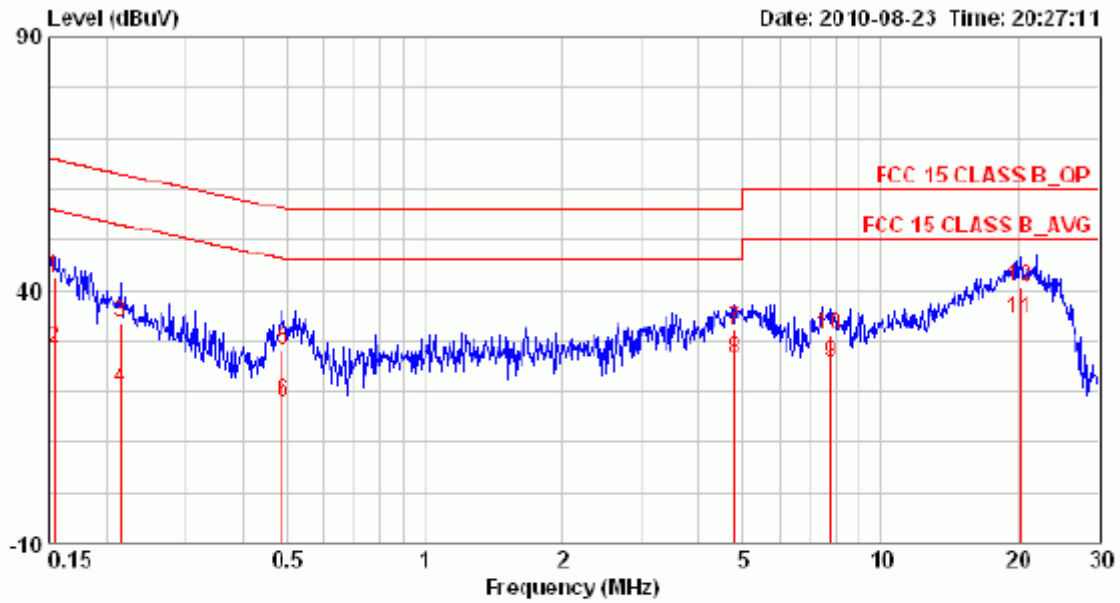

Freq. MHz	Corr. Factor dB	Reading Value dBuV		Emission Level dBuV		Limit dBuV		Margin dB	
		Q. P.	Ave.	Q. P.	Ave.	Q. P.	Ave.	Q. P.	Ave.
0.154	0.06	42.16	28.24	42.22	28.30	65.78	55.78	-23.56	-27.48
0.215	0.06	33.36	20.34	33.42	20.40	63.01	53.01	-29.59	-32.61
0.489	0.06	27.90	17.71	27.96	17.77	56.19	46.19	-28.23	-28.42
4.772	0.19	31.81	26.23	32.00	26.42	56.00	46.00	-24.00	-19.58
7.769	0.27	30.78	25.30	31.05	25.57	60.00	50.00	-28.95	-24.43
20.270	0.48	39.96	33.79	40.44	34.27	60.00	50.00	-19.56	-15.73

Remark:

1. Measuring frequencies from 0.15 MHz to 30MHz.
2. The emissions measured in frequency range from 0.15 MHz to 30MHz were made with an instrument using Quasi-peak detector and average detector.
3. The IF bandwidth of SPA between 0.15MHz and 30MHz was 10kHz; the IF bandwidth of Test Receiver between 0.15MHz and 30MHz was 9kHz;
4. L1 = Line One (Live Line) / L2 = Line Two (Neutral Line)



7.9 FREQUENCY STABILITY

LIMIT

According to §15.407(g), manufacturers of U-NII devices are responsible for ensuring frequency stability such that an emission is maintained within the band of operation under all conditions of normal operation as specified in the user's manual.

Test Configuration

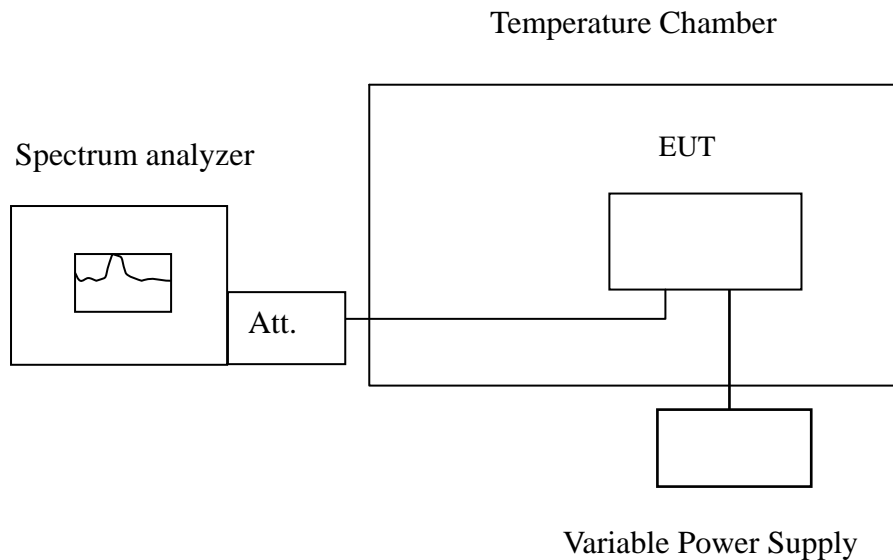

Remark: Measurement setup for testing on Antenna connector



TEST PROCEDURE

The equipment under test was connected to an external AC or DC power supply and input rated voltage. RF output was connected to a frequency counter or spectrum analyzer via feed through attenuators. The EUT was placed inside the temperature chamber. Set the spectrum analyzer RBW low enough to obtain the desired frequency resolution and measure EUT 20°C operating frequency as reference frequency. Turn EUT off and set the chamber temperature to -20°C. After the temperature stabilized for approximately 30 minutes recorded the frequency. Repeat step measure with 10°C increased per stage until the highest temperature of +50°C reached.

TEST RESULTS

No non-compliance noted.

IEEE 802.11a mode / 5180 ~ 5240 MHz:

CH Low

Operating Frequency: 5180 MHz				
Environment Temperature (°C)	Voltage (V)	Measured Frequency (MHz)	Limit Range	Test Result
50	110	5179.994280	5150~5250	Pass
40	110	5180.001009	5150~5250	Pass
30	110	5179.998525	5150~5250	Pass
20	110	5179.982668	5150~5250	Pass
10	110	5180.008516	5150~5250	Pass
0	110	5179.979187	5150~5250	Pass
-10	110	5179.988953	5150~5250	Pass
-20	110	5179.971851	5150~5250	Pass

Operating Frequency: 5180 MHz				
Environment Temperature (°C)	Voltage (V)	Measured Frequency (MHz)	Limit Range	Test Result
20	99	5179.983826	5150~5250	Pass
	110	5180.004066	5150~5250	Pass
	121	5180.002293	5150~5250	Pass



CH High

Operating Frequency: 5240 MHz				
Environment Temperature (°C)	Voltage (V)	Measured Frequency (MHz)	Limit Range	Test Result
50	110	5240.011483	5150~5250	Pass
40	110	5239.989052	5150~5250	Pass
30	110	5239.97171	5150~5250	Pass
20	110	5239.999063	5150~5250	Pass
10	110	5240.012907	5150~5250	Pass
0	110	5240.007675	5150~5250	Pass
-10	110	5239.981583	5150~5250	Pass
-20	110	5240.006497	5150~5250	Pass

Operating Frequency: 5240 MHz				
Environment Temperature (°C)	Voltage (V)	Measured Frequency (MHz)	Limit Range	Test Result
20	99	5239.974893	5150~5250	Pass
	110	5239.996009	5150~5250	Pass
	121	5240.007005	5150~5250	Pass



draft 802.11n Standard-20 MHz Channel mode / 5180 ~ 5240 MHz:

CH Low

Operating Frequency: 5180 MHz				
Environment Temperature (°C)	Voltage (V)	Measured Frequency (MHz)	Limit Range	Test Result
50	110	5180.012254	5150~5250	Pass
40	110	5179.980279	5150~5250	Pass
30	110	5180.003689	5150~5250	Pass
20	110	5179.997802	5150~5250	Pass
10	110	5179.971316	5150~5250	Pass
0	110	5180.006715	5150~5250	Pass
-10	110	5179.983170	5150~5250	Pass
-20	110	5179.992990	5150~5250	Pass

Operating Frequency: 5180 MHz				
Environment Temperature (°C)	Voltage (V)	Measured Frequency (MHz)	Limit Range	Test Result
20	99	5180.014738	5150~5250	Pass
	110	5179.986089	5150~5250	Pass
	121	5179.993759	5150~5250	Pass



CH High

Operating Frequency: 5240 MHz				
Environment Temperature (°C)	Voltage (V)	Measured Frequency (MHz)	Limit Range	Test Result
50	110	5239.998866	5150~5250	Pass
40	110	5240.008763	5150~5250	Pass
30	110	5240.00759	5150~5250	Pass
20	110	5240.014107	5150~5250	Pass
10	110	5240.008261	5150~5250	Pass
0	110	5239.973581	5150~5250	Pass
-10	110	5240.013917	5150~5250	Pass
-20	110	5239.979161	5150~5250	Pass

Operating Frequency: 5240 MHz				
Environment Temperature (°C)	Voltage (V)	Measured Frequency (MHz)	Limit Range	Test Result
20	99	5239.991183	5150~5250	Pass
	110	5239.986526	5150~5250	Pass
	121	5239.998332	5150~5250	Pass



draft 802.11n Wide-40 MHz Channel mode / 5190 ~ 5230 MHz:

CH Low

Operating Frequency: 5190 MHz				
Environment Temperature (°C)	Voltage (V)	Measured Frequency (MHz)	Limit Range	Test Result
50	110	5190.012814	5150~5250	Pass
40	110	5190.019838	5150~5250	Pass
30	110	5189.985185	5150~5250	Pass
20	110	5189.986597	5150~5250	Pass
10	110	5189.984501	5150~5250	Pass
0	110	5190.005642	5150~5250	Pass
-10	110	5190.006639	5150~5250	Pass
-20	110	5190.001927	5150~5250	Pass

Operating Frequency: 5190 MHz				
Environment Temperature (°C)	Voltage (V)	Measured Frequency (MHz)	Limit Range	Test Result
20	99	5189.991643	5150~5250	Pass
	110	5190.020659	5150~5250	Pass
	121	5189.994408	5150~5250	Pass



CH High

Operating Frequency: 5230 MHz				
Environment Temperature (°C)	Voltage (V)	Measured Frequency (MHz)	Limit Range	Test Result
50	110	5230.014948	5150~5250	Pass
40	110	5229.976434	5150~5250	Pass
30	110	5229.979094	5150~5250	Pass
20	110	5229.993816	5150~5250	Pass
10	110	5229.995199	5150~5250	Pass
0	110	5230.009753	5150~5250	Pass
-10	110	5229.989794	5150~5250	Pass
-20	110	5230.016223	5150~5250	Pass

Operating Frequency: 5230 MHz				
Environment Temperature (°C)	Voltage (V)	Measured Frequency (MHz)	Limit Range	Test Result
20	99	5229.998084	5150~5250	Pass
	110	5229.984963	5150~5250	Pass
	121	5230.007881	5150~5250	Pass



IEEE 802.11a mode / 5260 ~ 5320 MHz:

CH Low

Operating Frequency: 5260 MHz				
Environment Temperature (°C)	Voltage (V)	Measured Frequency (MHz)	Limit Range	Test Result
50	110	5260.007146	5250~5350	Pass
40	110	5259.97489	5250~5350	Pass
30	110	5259.971883	5250~5350	Pass
20	110	5260.01535	5250~5350	Pass
10	110	5259.977986	5250~5350	Pass
0	110	5259.976992	5250~5350	Pass
-10	110	5260.009784	5250~5350	Pass
-20	110	5259.985933	5250~5350	Pass

Operating Frequency: 5260 MHz				
Environment Temperature (°C)	Voltage (V)	Measured Frequency (MHz)	Limit Range	Test Result
20	99	5260.002865	5250~5350	Pass
	110	5259.971089	5250~5350	Pass
	121	5259.970435	5250~5350	Pass



CH High

Operating Frequency: 5320 MHz				
Environment Temperature (°C)	Voltage (V)	Measured Frequency (MHz)	Limit Range	Test Result
50	110	5319.993267	5250~5350	Pass
40	110	5319.980488	5250~5350	Pass
30	110	5320.020199	5250~5350	Pass
20	110	5320.011366	5250~5350	Pass
10	110	5320.014059	5250~5350	Pass
0	110	5320.000178	5250~5350	Pass
-10	110	5319.998094	5250~5350	Pass
-20	110	5319.982933	5250~5350	Pass

Operating Frequency: 5320 MHz				
Environment Temperature (°C)	Voltage (V)	Measured Frequency (MHz)	Limit Range	Test Result
20	99	5320.012065	5250~5350	Pass
	110	5319.993859	5250~5350	Pass
	121	5320.009046	5250~5350	Pass



draft 802.11n Standard-20 MHz Channel mode / 5260 ~ 5320 MHz:

CH Low

Operating Frequency: 5260 MHz				
Environment Temperature (°C)	Voltage (V)	Measured Frequency (MHz)	Limit Range	Test Result
50	110	5259.982565	5250~5350	Pass
40	110	5260.019851	5250~5350	Pass
30	110	5260.01517	5250~5350	Pass
20	110	5259.996719	5250~5350	Pass
10	110	5259.991243	5250~5350	Pass
0	110	5260.017786	5250~5350	Pass
-10	110	5259.980214	5250~5350	Pass
-20	110	5259.977541	5250~5350	Pass

Operating Frequency: 5260 MHz				
Environment Temperature (°C)	Voltage (V)	Measured Frequency (MHz)	Limit Range	Test Result
20	99	5260.008211	5250~5350	Pass
	110	5259.986892	5250~5350	Pass
	121	5259.980574	5250~5350	Pass



CH High

Operating Frequency: 5320 MHz				
Environment Temperature (°C)	Voltage (V)	Measured Frequency (MHz)	Limit Range	Test Result
50	110	5320.004534	5250~5350	Pass
40	110	5319.974437	5250~5350	Pass
30	110	5320.001835	5250~5350	Pass
20	110	5320.00271	5250~5350	Pass
10	110	5319.979586	5250~5350	Pass
0	110	5319.980016	5250~5350	Pass
-10	110	5319.974455	5250~5350	Pass
-20	110	5319.975138	5250~5350	Pass

Operating Frequency: 5320 MHz				
Environment Temperature (°C)	Voltage (V)	Measured Frequency (MHz)	Limit Range	Test Result
20	99	5319.985069	5250~5350	Pass
	110	5319.972448	5250~5350	Pass
	121	5320.003644	5250~5350	Pass



draft 802.11n Wide-40 MHz Channel mode / 5270 ~ 5310 MHz:

CH Low

Operating Frequency: 5270 MHz				
Environment Temperature (°C)	Voltage (V)	Measured Frequency (MHz)	Limit Range	Test Result
50	110	5269.992833	5250~5350	Pass
40	110	5269.980124	5250~5350	Pass
30	110	5270.011228	5250~5350	Pass
20	110	5269.993481	5250~5350	Pass
10	110	5270.018087	5250~5350	Pass
0	110	5269.976021	5250~5350	Pass
-10	110	5270.011394	5250~5350	Pass
-20	110	5269.98935	5250~5350	Pass

Operating Frequency: 5270 MHz				
Environment Temperature (°C)	Voltage (V)	Measured Frequency (MHz)	Limit Range	Test Result
20	99	5270.017791	5250~5350	Pass
	110	5269.978255	5250~5350	Pass
	121	5270.020274	5250~5350	Pass



CH High

Operating Frequency: 5310 MHz				
Environment Temperature (°C)	Voltage (V)	Measured Frequency (MHz)	Limit Range	Test Result
50	110	5310.002241	5250~5350	Pass
40	110	5310.006137	5250~5350	Pass
30	110	5309.974259	5250~5350	Pass
20	110	5309.996793	5250~5350	Pass
10	110	5310.006624	5250~5350	Pass
0	110	5310.009284	5250~5350	Pass
-10	110	5309.973079	5250~5350	Pass
-20	110	5309.980627	5250~5350	Pass

Operating Frequency: 5310 MHz				
Environment Temperature (°C)	Voltage (V)	Measured Frequency (MHz)	Limit Range	Test Result
20	99	5309.996251	5250~5350	Pass
	110	5309.9873	5250~5350	Pass
	121	5310.006258	5250~5350	Pass



IEEE 802.11a mode / 5500 ~ 5700 MHz:

CH Low

Operating Frequency: 5500 MHz				
Environment Temperature (°C)	Voltage (V)	Measured Frequency (MHz)	Limit Range	Test Result
50	110	5499.995987	5470~5725	Pass
40	110	5499.996122	5470~5725	Pass
30	110	5499.995374	5470~5725	Pass
20	110	5499.991104	5470~5725	Pass
10	110	5499.983538	5470~5725	Pass
0	110	5499.987191	5470~5725	Pass
-10	110	5500.009796	5470~5725	Pass
-20	110	5500.005004	5470~5725	Pass

Operating Frequency: 5500 MHz				
Environment Temperature (°C)	Voltage (V)	Measured Frequency (MHz)	Limit Range	Test Result
20	99	5499.989054	5470~5725	Pass
	110	5499.995972	5470~5725	Pass
	121	5500.002928	5470~5725	Pass



CH High

Operating Frequency: 5700 MHz				
Environment Temperature (°C)	Voltage (V)	Measured Frequency (MHz)	Limit Range	Test Result
50	110	5700.01101	5470~5725	Pass
40	110	5699.976483	5470~5725	Pass
30	110	5700.003691	5470~5725	Pass
20	110	5699.974725	5470~5725	Pass
10	110	5699.977013	5470~5725	Pass
0	110	5700.006582	5470~5725	Pass
-10	110	5700.005498	5470~5725	Pass
-20	110	5700.019957	5470~5725	Pass

Operating Frequency: 5700 MHz				
Environment Temperature (°C)	Voltage (V)	Measured Frequency (MHz)	Limit Range	Test Result
20	99	5700.011523	5470~5725	Pass
	110	5699.975469	5470~5725	Pass
	121	5699.991407	5470~5725	Pass



draft 802.11n Standard-20 MHz Channel mode / 5500 ~ 5700 MHz:

CH Low

Operating Frequency: 5500 MHz				
Environment Temperature (°C)	Voltage (V)	Measured Frequency (MHz)	Limit Range	Test Result
50	110	5500.018589	5470~5725	Pass
40	110	5499.970457	5470~5725	Pass
30	110	5499.989247	5470~5725	Pass
20	110	5500.00284	5470~5725	Pass
10	110	5499.977444	5470~5725	Pass
0	110	5500.010155	5470~5725	Pass
-10	110	5500.012187	5470~5725	Pass
-20	110	5499.970114	5470~5725	Pass

Operating Frequency: 5500 MHz				
Environment Temperature (°C)	Voltage (V)	Measured Frequency (MHz)	Limit Range	Test Result
20	99	5500.006526	5470~5725	Pass
	110	5499.970953	5470~5725	Pass
	121	5500.010779	5470~5725	Pass



CH High

Operating Frequency: 5700 MHz				
Environment Temperature (°C)	Voltage (V)	Measured Frequency (MHz)	Limit Range	Test Result
50	110	5699.978874	5470~5725	Pass
40	110	5700.000105	5470~5725	Pass
30	110	5699.994718	5470~5725	Pass
20	110	5699.974967	5470~5725	Pass
10	110	5700.008961	5470~5725	Pass
0	110	5700.013961	5470~5725	Pass
-10	110	5699.99955	5470~5725	Pass
-20	110	5699.998181	5470~5725	Pass

Operating Frequency: 5700 MHz				
Environment Temperature (°C)	Voltage (V)	Measured Frequency (MHz)	Limit Range	Test Result
20	99	5700.019473	5470~5725	Pass
	110	5699.975437	5470~5725	Pass
	121	5699.980422	5470~5725	Pass



draft 802.11n Wide-40 MHz Channel mode / 5510 ~ 5670 MHz:

CH Low

Operating Frequency: 5510 MHz				
Environment Temperature (°C)	Voltage (V)	Measured Frequency (MHz)	Limit Range	Test Result
50	110	5509.982328	5470~5725	Pass
40	110	5510.002453	5470~5725	Pass
30	110	5510.005246	5470~5725	Pass
20	110	5509.995099	5470~5725	Pass
10	110	5509.997864	5470~5725	Pass
0	110	5510.013354	5470~5725	Pass
-10	110	5510.010339	5470~5725	Pass
-20	110	5509.980554	5470~5725	Pass

Operating Frequency: 5510 MHz				
Environment Temperature (°C)	Voltage (V)	Measured Frequency (MHz)	Limit Range	Test Result
20	99	5509.99053	5470~5725	Pass
	110	5510.005879	5470~5725	Pass
	121	5509.986714	5470~5725	Pass



CH High

Operating Frequency: 5670 MHz				
Environment Temperature (°C)	Voltage (V)	Measured Frequency (MHz)	Limit Range	Test Result
50	110	5670.004381	5470~5725	Pass
40	110	5669.981857	5470~5725	Pass
30	110	5670.002096	5470~5725	Pass
20	110	5670.018484	5470~5725	Pass
10	110	5669.997257	5470~5725	Pass
0	110	5669.976783	5470~5725	Pass
-10	110	5669.991171	5470~5725	Pass
-20	110	5669.974813	5470~5725	Pass

Operating Frequency: 5670 MHz				
Environment Temperature (°C)	Voltage (V)	Measured Frequency (MHz)	Limit Range	Test Result
20	99	5670.015453	5470~5725	Pass
	110	5670.017966	5470~5725	Pass
	121	5670.01909	5470~5725	Pass



7.10 DYNAMIC FREQUENCY SELECTION

LIMIT

According to §15.407 (h) and FCC 06-96 appendix “compliance measurement procedures for unlicensed-national information infrastructure devices operating in the 5250-5350 MHz and 5470-5725 MHz bands incorporating dynamic frequency selection”.

Table 1: Applicability of DFS requirements prior to use of a channel

Requirement	Operational Mode		
	Master	Client (without radar detection)	Client(with radar detection)
Non-Occupancy Period	Yes	Yes	Yes
DFS Detection Threshold	Yes	Not required	Yes
Channel Availability Check Time	Yes	Not required	Not required
Uniform Spreading	Yes	Not required	Not required
U-NII Detection Bandwidth	Yes	Not required	Yes

Table 2: Applicability of DFS requirements during normal operation

Requirement	Operational Mode		
	Master	Client (without radar detection)	Client(with radar detection)
DFS Detection Threshold	Yes	Not required	Yes
Channel Closing Transmission Time	Yes	Yes	Yes
Channel Move Time	Yes	Yes	Yes
U-NII Detection Bandwidth	Yes	Not required	Yes

Table 3: Interference Threshold values, Master or Client incorporating In-Service

Maximum Transmit Power	Value (see note)
≥200 Milliwatt	-64 dBm
< 200 Milliwatt	-62 dBm

Note 1: This is the level at the input of the receiver assuming a 0 dBi receive antenna.

Note 2: Throughout these test procedures an additional 1 dB has been added to the amplitude of the test transmission waveforms to account for variations in measurement equipment. This will ensure that the test signal is at or above the detection threshold level to trigger a DFS response.



Table 4: DFS Response requirement values

Parameter	Value
Non-occupancy period	30 minutes
Channel Availability Check Time	60 seconds
Channel Move Time	10 seconds
Channel Closing Transmission Time	200 milliseconds + approx. 60 milliseconds over remaining 10 second period
U-NII Detection Bandwidth	Minimum 80% of the UNII 99% transmission power bandwidth. See Note 3.

The instant that the Channel Move Time and the Channel Closing Transmission Time begins is as follows:

- For the Short pulse radar Test Signals this instant is the end of the Burst.
- For the Frequency Hopping radar Test Signal, this instant is the end of the last radar burst generated.
- For the Long Pulse radar Test Signal this instant is the end of the 12 second period defining the radar transmission.

The Channel Closing Transmission Time is comprised of 200 milliseconds starting at the beginning of the Channel Move Time plus any additional intermittent control signals required to facilitate channel changes (an aggregate of approximately 60 milliseconds) during the remainder of the 10 second period. The aggregate duration of control signals will not count quiet periods in between transmissions.

Table 5 – Short Pulse Radar Test Waveforms

Radar Type	Pulse Width (Microseconds)	PRI (Microseconds)	Pulses	Minimum Percentage of Successful Detection	Minimum Trials
1	1	1428	18	60%	30
2	1-5	150-230	23-29	60%	30
3	6-10	200-500	16-18	60%	30
4	11-20	200-500	12-16	60%	30
Aggregate (Radar Types 1-4)				80%	120

Table 6 – Long Pulse Radar Test Signal

Radar Waveform	Bursts	Pulses per Burst	Pulse Width (µsec)	Chirp Width (µsec)	PRI (µsec)	Minimum Percentage of Successful Detection	Minimum Trials
5	8-20	1-3	50-100	5-20	1000-2000	80%	30

Table 7 – Frequency Hopping Radar Test Signal

Radar Waveform	Pulse Width (µsec)	PRI (µsec)	Burst Length (ms)	Pulses Per Hop	Hopping Rate (kHz)	Minimum Percentage of Successful Detection	Minimum Trials
6	1	333	300	9	0.33	70%	30



DESCRIPTION OF EUT

Overview Of EUT With Respect To §15.407 (H) Requirements

The EUT operates over the 5250-5350 MHz range as a Client Device that does not have radar detection capability.

The antenna assembly utilized with the EUT has a gain of 3.48 dBi.

The highest power level is 20.02 dBm EIRP in the 5500 ~ 5700MHz band.

The EUT uses one transmitter connected to two 50-ohm coaxial antenna ports via a diversity switch. Two antenna port is connected to the test system since the EUT has two antenna.

The Slave device associated with the EUT during these tests does not have radar detection capability.

WLAN traffic is generated by streaming the video file TestFile.mp2 “6 ½ Magic Hours” from the Master to the Slave in full motion video mode using the media player with the V2.61 Codec package.

TPC is not required since the maximum EIRP is less than 500 mW (27 dBm).

The EUT utilizes the 802.11a architecture, with a nominal channel bandwidth of 20 MHz.

The Master Device is a Cisco Aironet 802.11a/b/g Access Point, FCC ID: LDK102056.

The rated output power of the Master unit is < 23dBm (EIRP). Therefore the required interference threshold level is -62 dBm. After correction for antenna gain and procedural adjustments, the required conducted threshold at the antenna port is $-62 + 5 = -57$ dBm.

The calibrated conducted DFS Detection Threshold level is set to -62 dBm. The tested level is lower than the required level hence it provides margin to the limit.

Manufacturer’s Statement Regarding Uniform Channel Spreading

The end product implements an automatic channel selection feature at startup such that operation commences on channels distributed across the entire set of allowed 5GHz channels. This feature will ensure uniform spreading is achieved while avoiding non-allowed channels due to prior radar events.



TEST AND MEASUREMENT SYSTEM

System Overview

The measurement system is based on a conducted test method.

The short pulse and long pulse signal generating system utilizes the NTIA software. The Vector Signal Generator has been validated by the NTIA. The hopping signal generating system utilizes the CCS simulated hopping method and system, which has been validated by the DoD, FCC and NTIA. The software selects waveform parameters from within the bounds of the signal type on a random basis using uniform distribution.

The short pulse types 2, 3 and 4, and the long pulse type 5 parameters are randomized at run-time.

The hopping type 6 pulse parameters are fixed while the hopping sequence is based on the August 2005 NTIA Hopping Frequency List. The initial starting point randomized at run-time and each subsequent starting point is incremented by 475. Each frequency in the 100-length segment is compared to the boundaries of the EUT Detection Bandwidth and the software creates a hopping burst pattern in accordance with Section 7.4.1.3 Method #2 Simulated Frequency Hopping Radar Waveform Generating Subsystem of FCC 06-96 APPENDIX. The frequency of the signal generator is incremented in 1 MHz steps from FL to FH for each successive trial. This incremental sequence is repeated as required to generate a minimum of 30 total trials and to maintain a uniform frequency distribution over the entire Detection Bandwidth.

The signal monitoring equipment consists of a spectrum analyzer set to display 8001 bins on the horizontal axis. The time-domain resolution is 2 msec / bin with a 16 second sweep time, meeting the 10 second short pulse reporting criteria. The aggregate ON time is calculated by multiplying the number of bins above a threshold during a particular observation period by the dwell time per bin, with the analyzer set to peak detection and max hold. The time-domain resolution is 3 msec / bin with a 24 second sweep time, meeting the 22 second long pulse reporting criteria and allowing a minimum of 10 seconds after the end of the long pulse waveform.

Should multiple RF ports be utilized for the Master and/or Slave devices (for example, for diversity or MIMO implementations), 50 ohm termination would be removed from the splitter so that connection can be established between splitter and the Master and/or Slave devices.

Conducted Method System Block Diagram

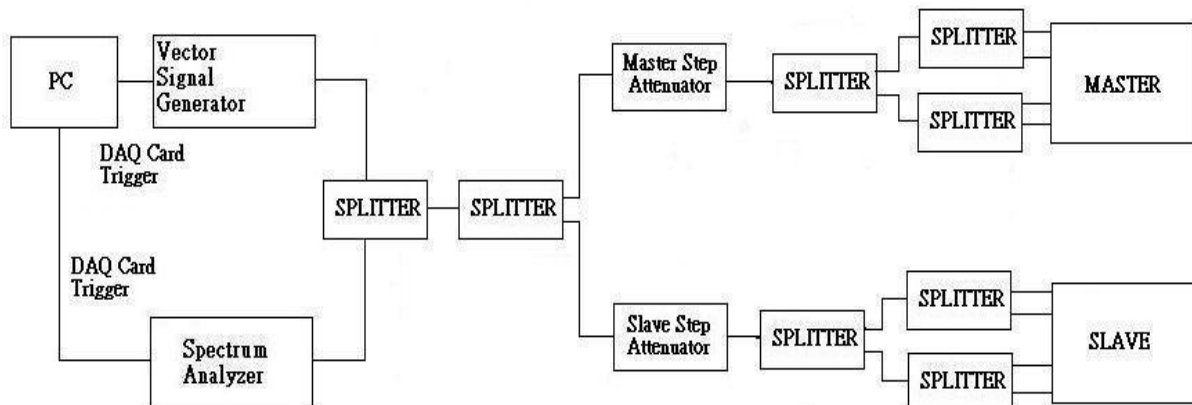



System Calibration

Connect the spectrum analyzer to the test system in place of the master device. Set the signal generator to CW mode. Adjust the amplitude of the signal generator to yield a measured level of -62 dBm on the spectrum analyzer.

Without changing any of the instrument settings, reconnect the spectrum analyzer to the Common port of the Spectrum Analyzer Combiner/Divider and connect a 50 ohm load to the Master Device port of the test system.

Measure the amplitude and calculate the difference from -62 dBm. Adjust the Reference Level Offset of the spectrum analyzer to this difference. Confirm that the signal is displayed at -62 dBm. Readjust the RBW and VBW to 3 MHz, set the span to 10 MHz, and confirm that the signal is still displayed at -62 dBm.

The spectrum analyzer displays the level of the signal generator as received at the antenna ports of the Master Device. The interference detection threshold may be varied from the calibrated value of -62 dBm and the spectrum analyzer will still indicate the level as received by the Master Device.

Set the signal generator to produce a radar waveform, trigger a burst manually and measure the level on the spectrum analyzer. Readjust the amplitude of the signal generator as required so that the peak level of the waveform is at a displayed level equal to the required or desired interference detection threshold. Separate signal generator amplitude settings are determined as required for each radar type.

Adjustment Of Displayed Traffic Level

Establish a link between the Master and Slave, adjusting the Link Step Attenuator as needed to provide a suitable received level at the Master and Slave devices. Stream the video test file to generate WLAN traffic. Confirm that the WLAN traffic level, as displayed on the spectrum analyzer, is at lower amplitude than the radar detection threshold. Confirm that the displayed traffic is from the Master Device. For Master Device testing confirm that the displayed traffic does not include Slave Device traffic. For Slave Device testing confirm that the displayed traffic does not include Master Device traffic.

If a different setting of the Master Step Attenuator is required to meet the above conditions, perform a new System Calibration for the new Master Step Attenuator setting.



Test Setup

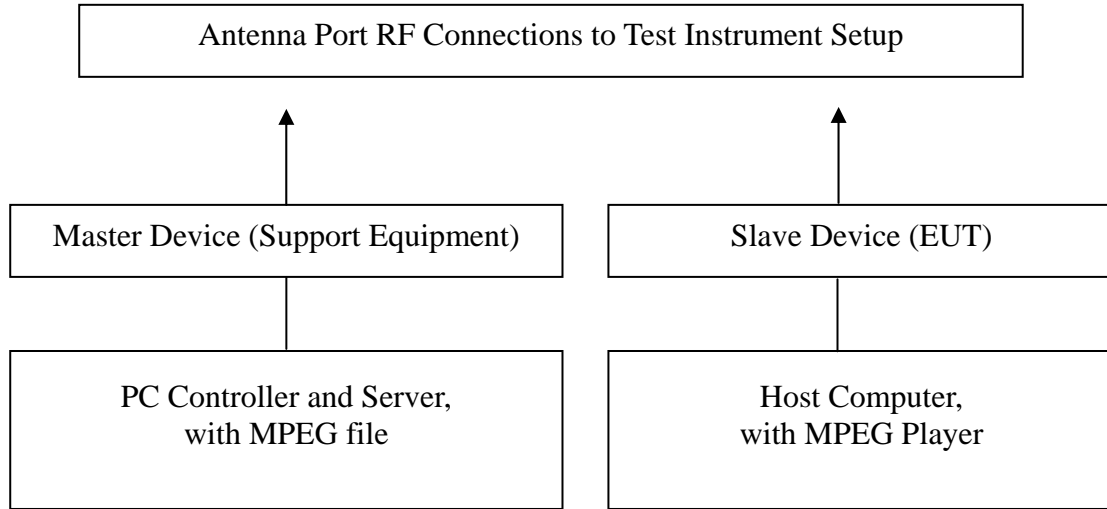

TEST RESULTS

No non-compliance noted



Test Plot

PLOTS OF RADAR WAVEFORMS

draft 802.11n Standard-20 MHz mode

Sample of Short Pulse Radar Type 1

Agilent 17:20:47 Aug 4, 2010

T

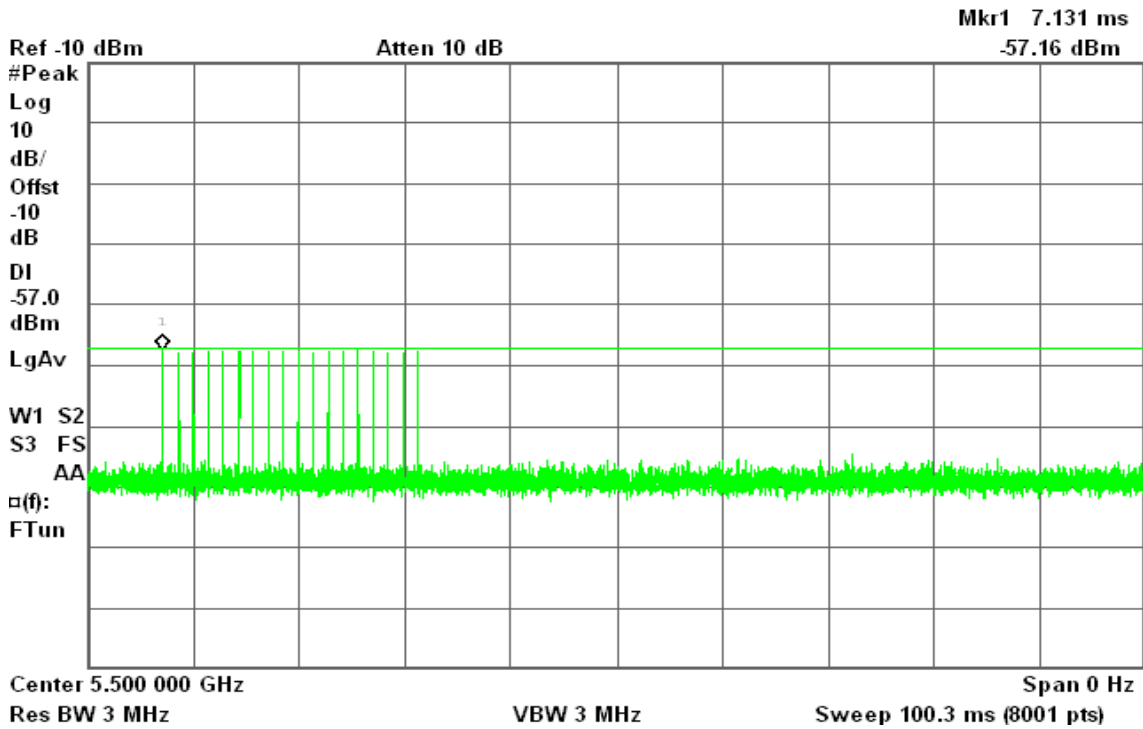

Sample of Short Pulse Radar Type 2

Agilent 17:18:57 Aug 4, 2010

T

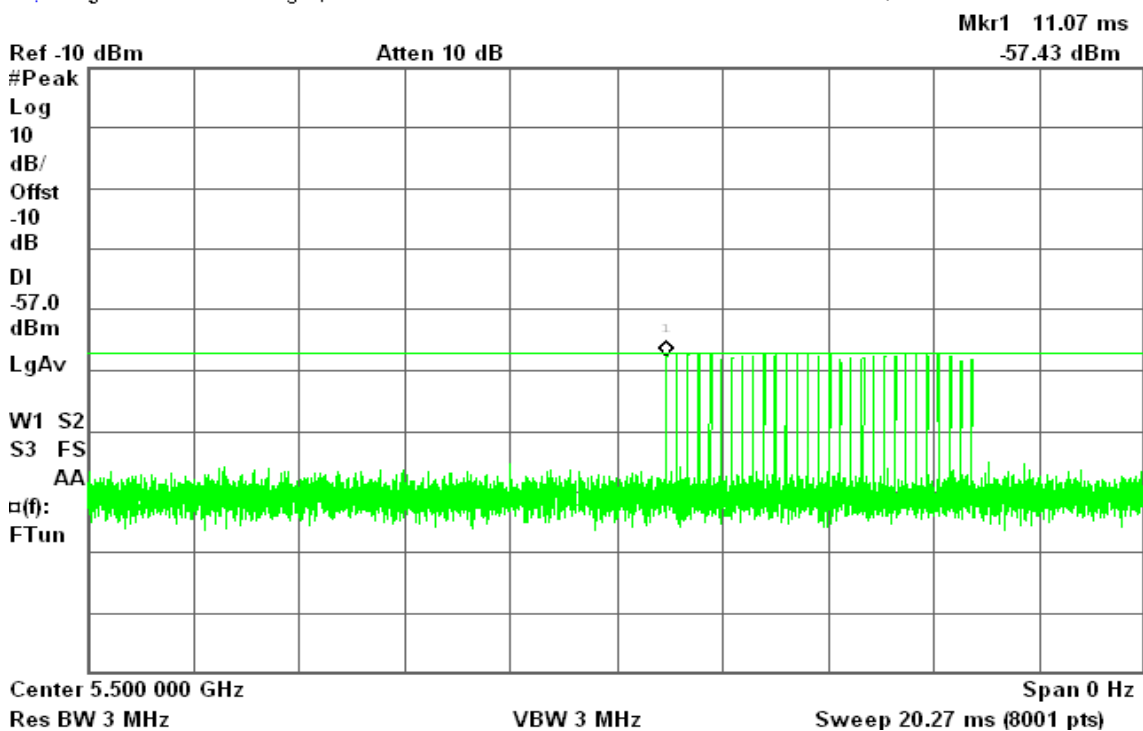



Sample of Short Pulse Radar Type 3

Agilent 17:17:54 Aug 4, 2010

T

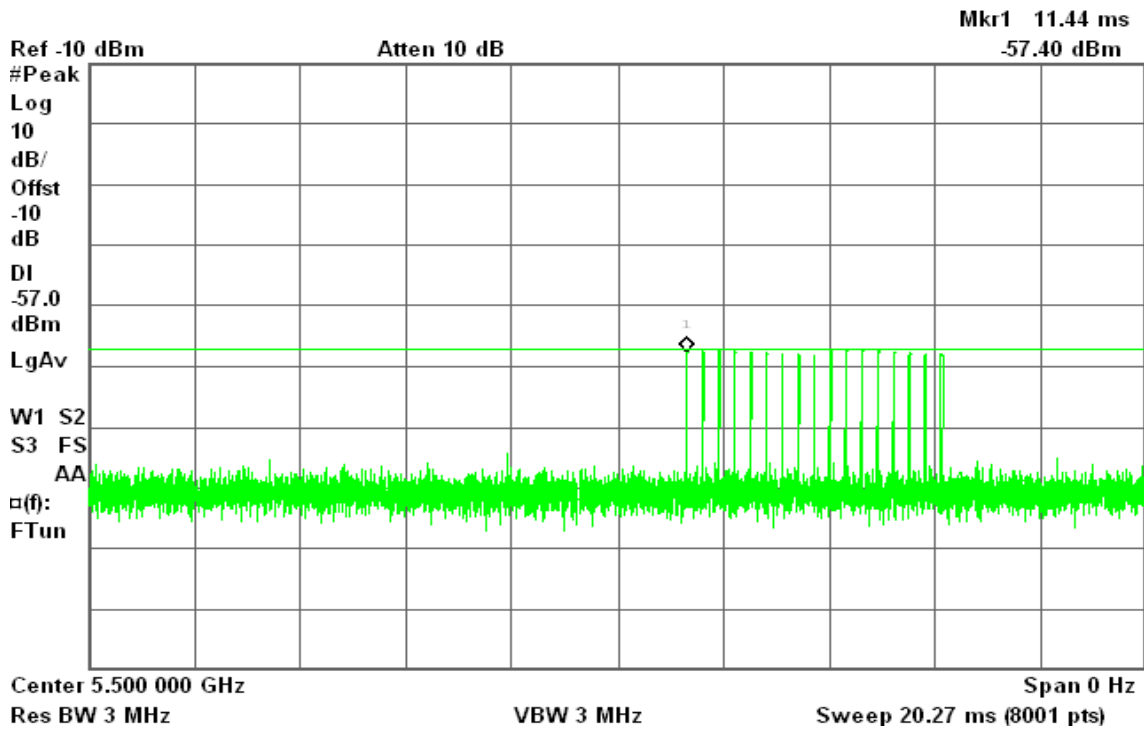

Sample of Short Pulse Radar Type 4

Agilent 17:16:39 Aug 4, 2010

T

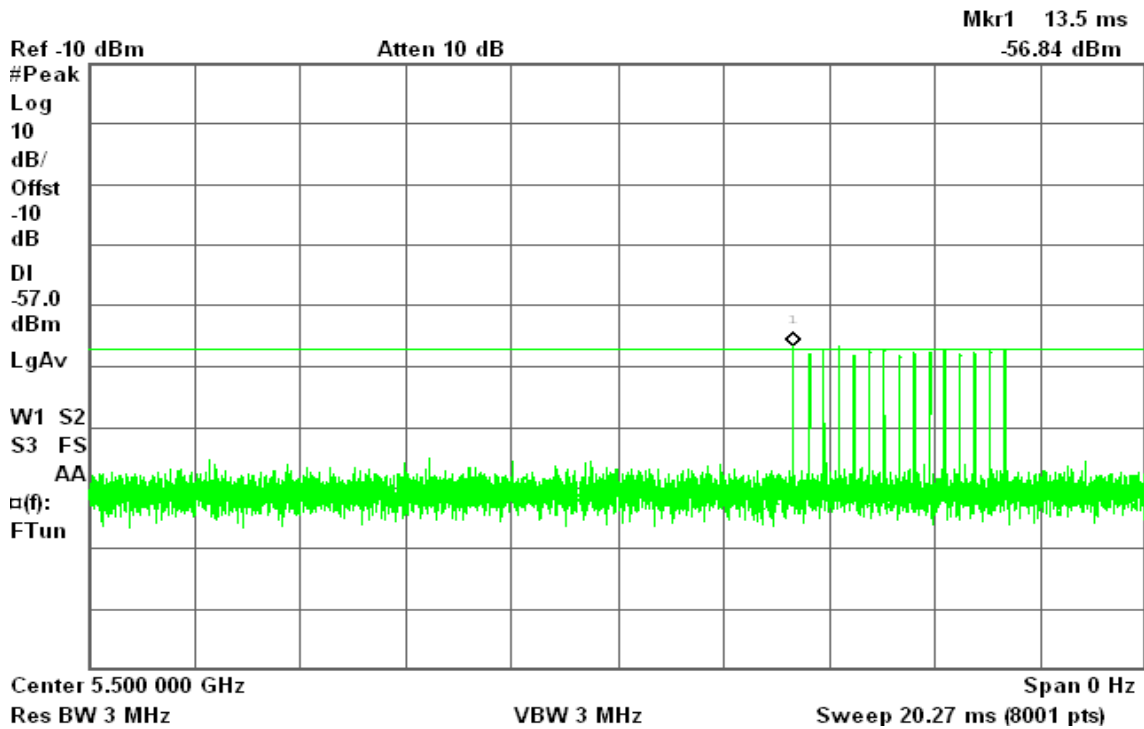



Sample of Long Pulse Radar Type 5

Agilent 17:02:21 Aug 4, 2010

T

Mkr1 3.14 s
-57.79 dBm

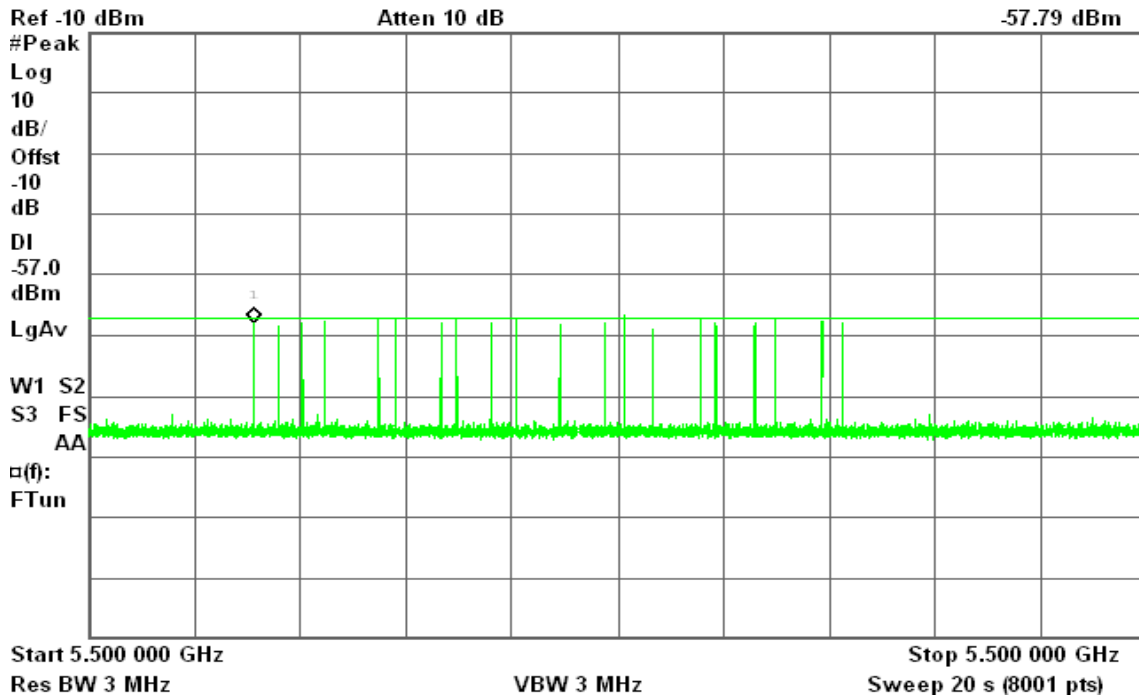

Sample of Frequency Hopping Radar Type 6

Agilent 17:14:44 Aug 4, 2010

T

Mkr1 31.45 ms
-58.15 dBm

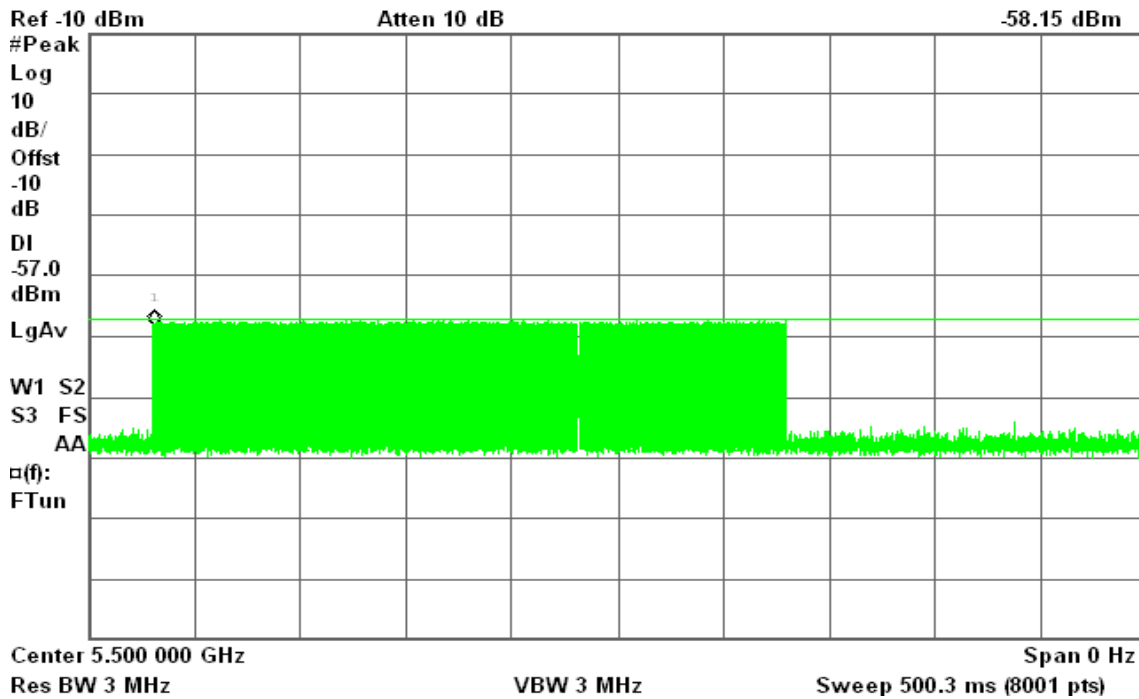



Plot of WLAN Traffic from Slave

Agilent 15:34:46 Aug 3, 2010

R T

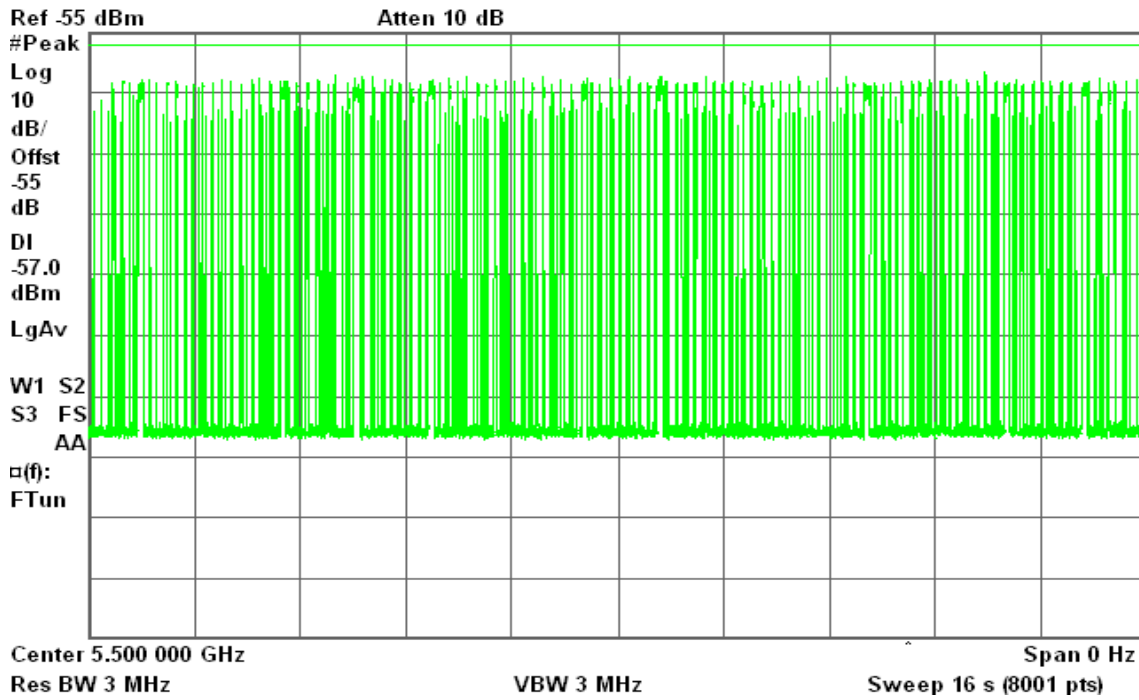



draft 802.11n Wide-40 MHz mode

Sample of Short Pulse Radar Type 1

Agilent 16:51:36 Aug 4, 2010

T

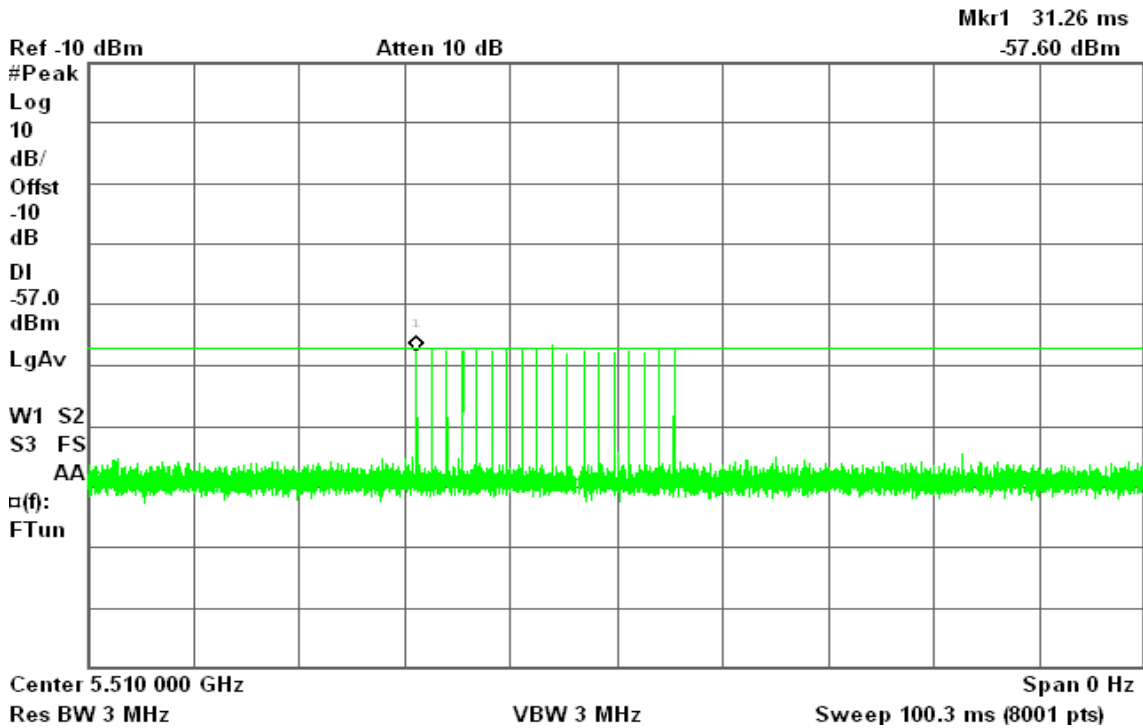

Sample of Short Pulse Radar Type 2

Agilent 16:53:09 Aug 4, 2010

T

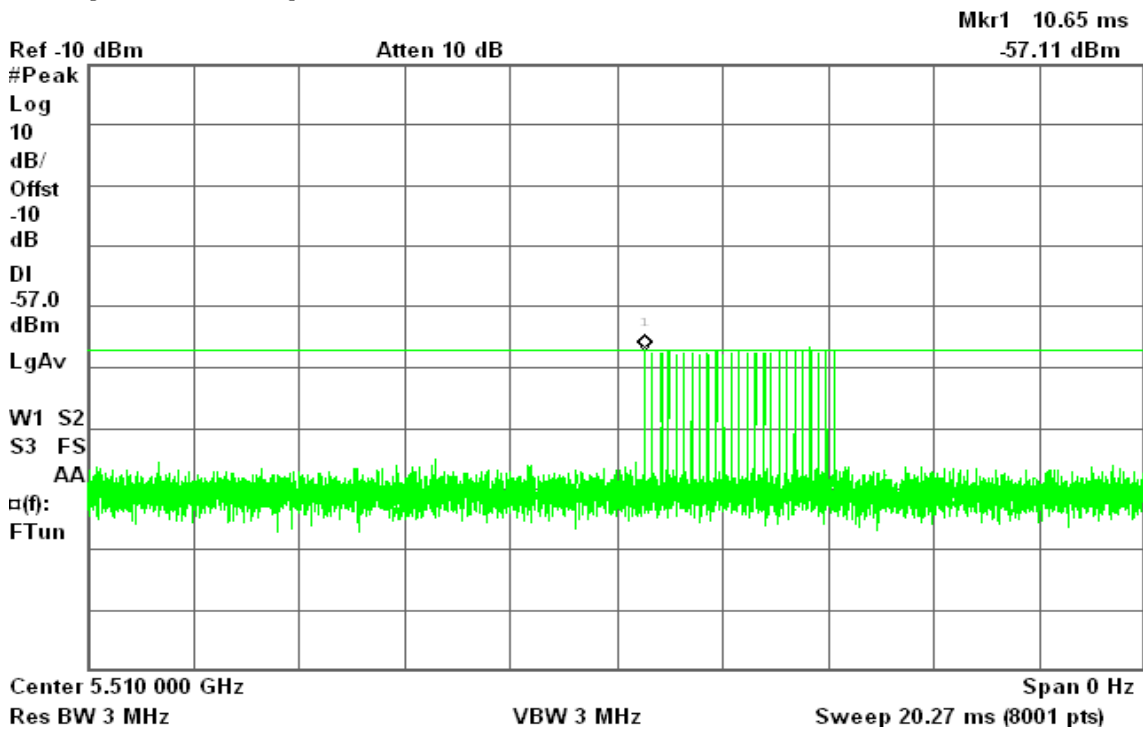



Sample of Short Pulse Radar Type 3

Agilent 16:54:47 Aug 4, 2010

T

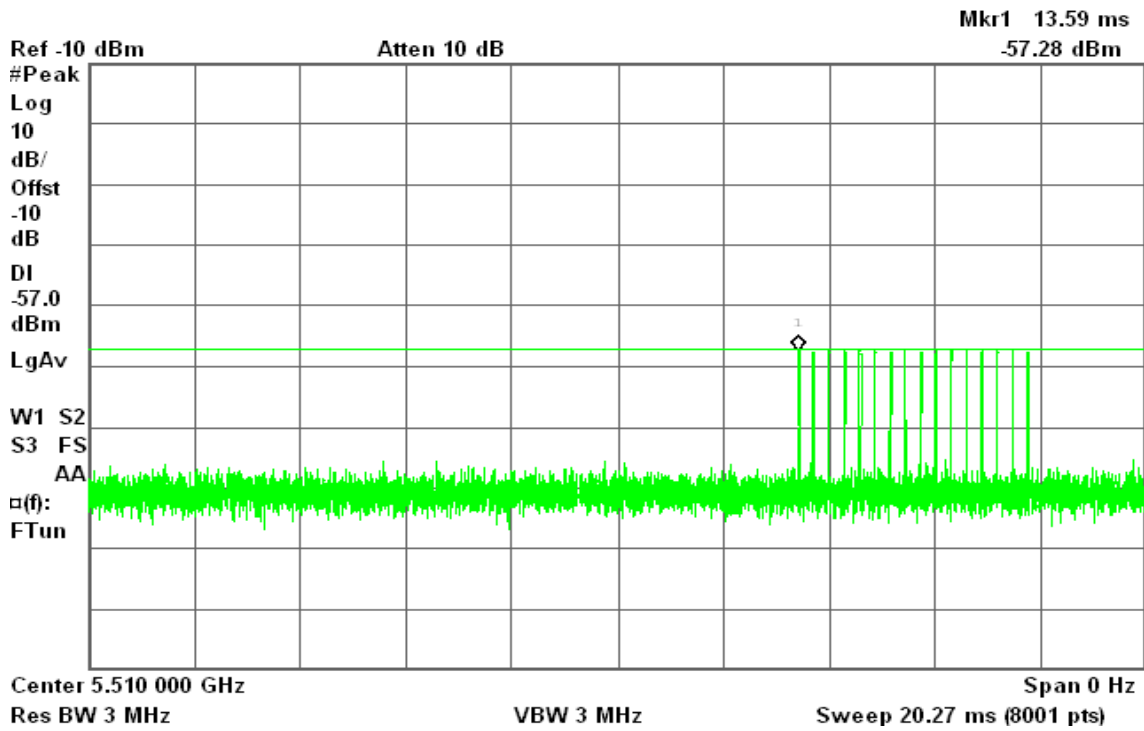

Sample of Short Pulse Radar Type 4

Agilent 16:55:59 Aug 4, 2010

T

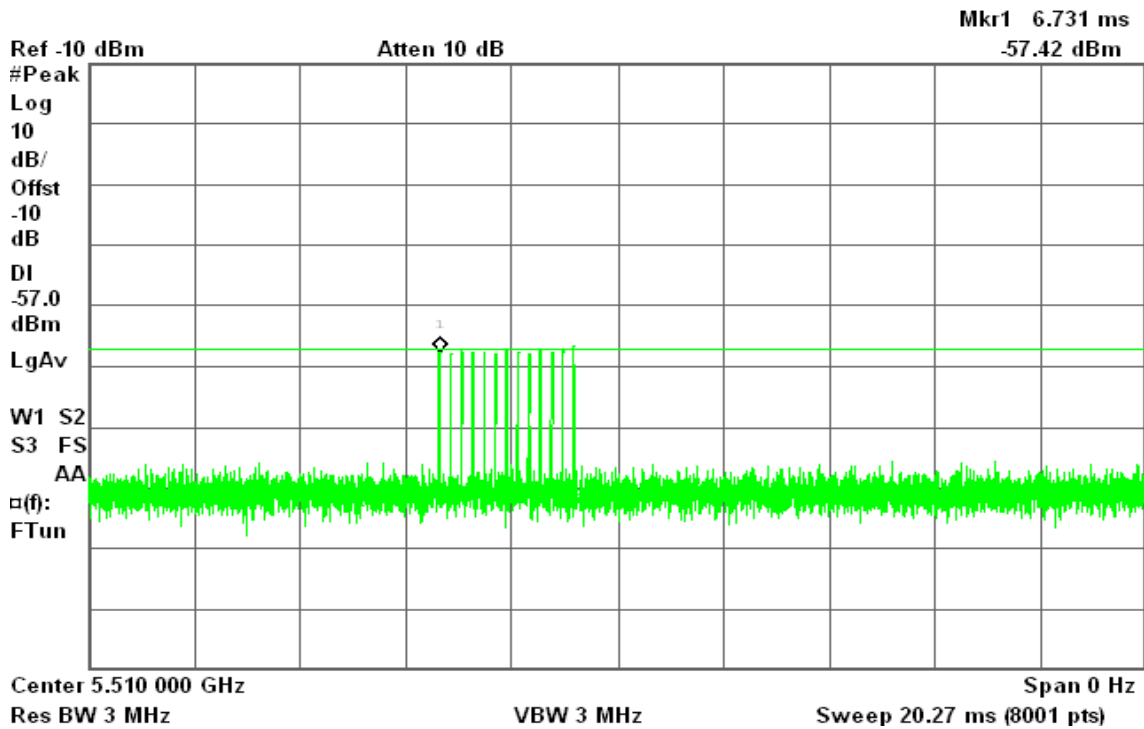



Sample of Long Pulse Radar Type 5

Agilent 17:00:57 Aug 4, 2010

T

Mkr1 2.4 s
-57.56 dBm

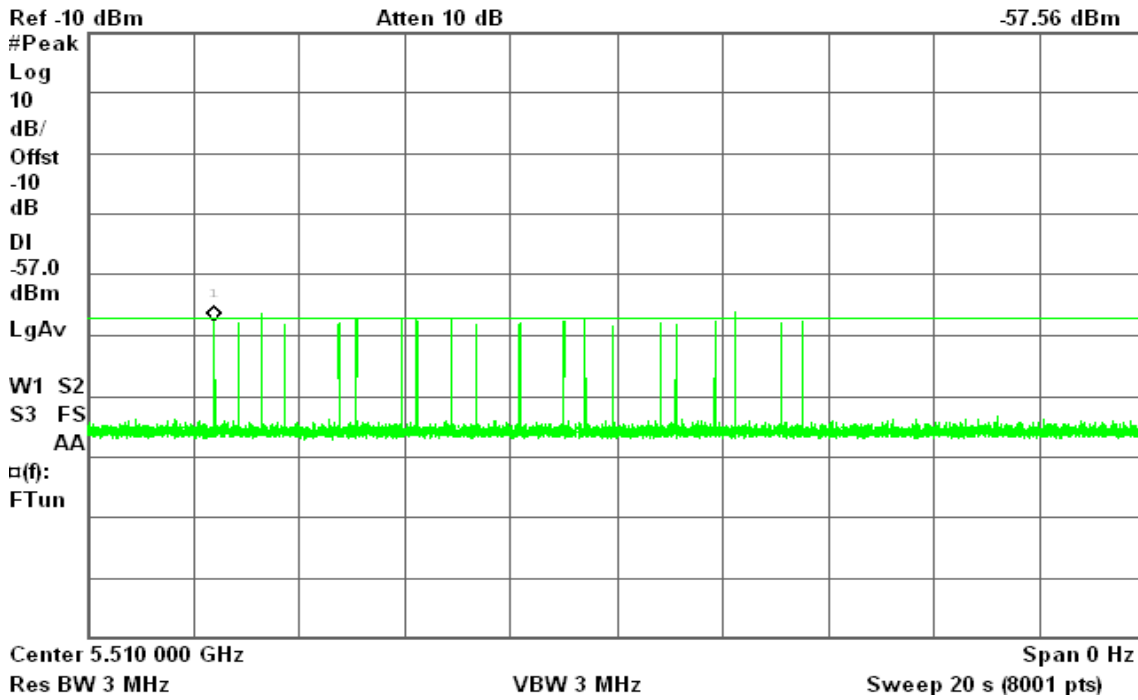

Sample of Frequency Hopping Radar Type 6

Agilent 17:11:39 Aug 4, 2010

T

Mkr1 43.71 ms
-57.83 dBm

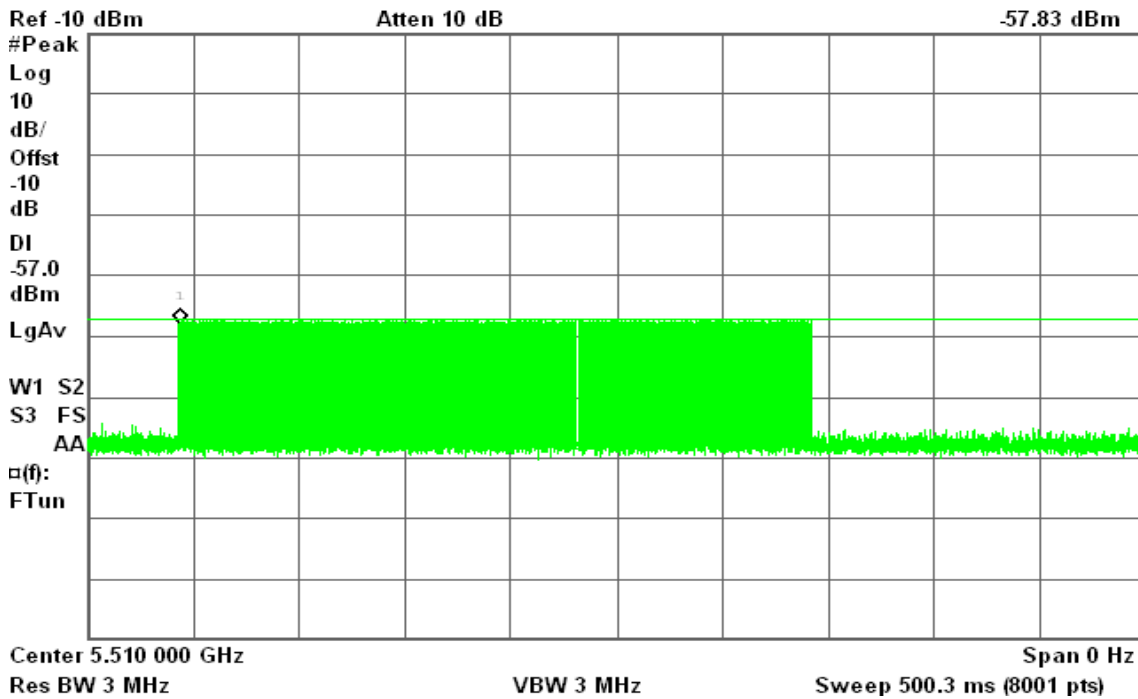



Plot of WLAN Traffic from Slave

* Agilent 13:13:31 Aug 4, 2010

R T

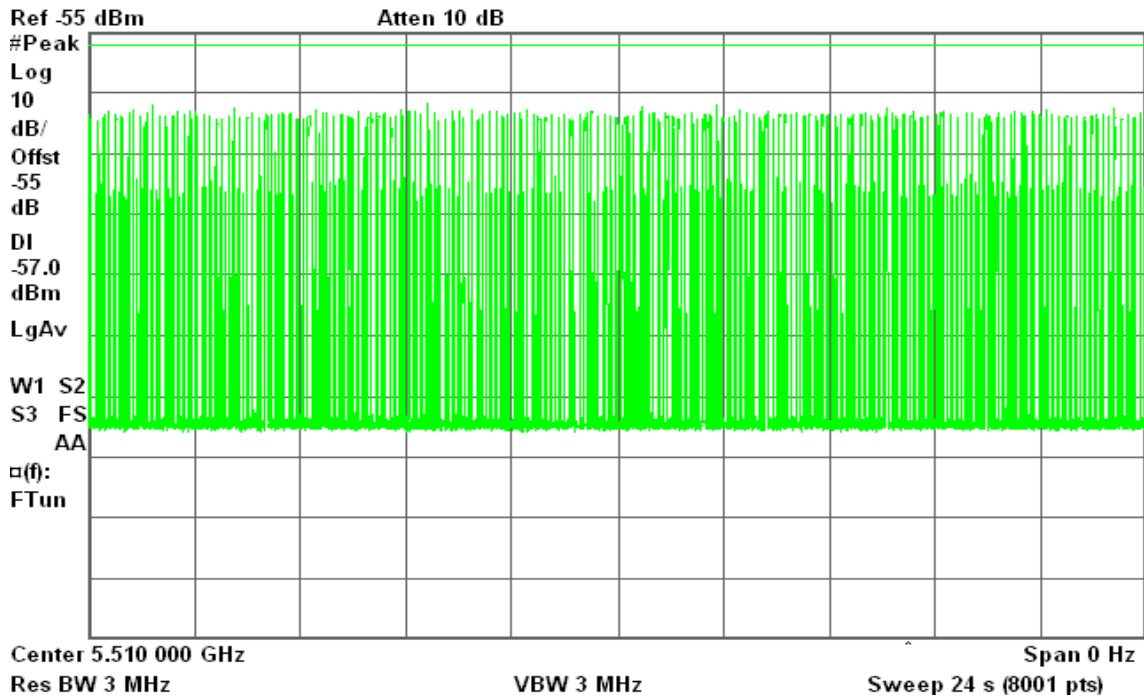



TEST CHANNEL AND METHOD

All tests were performed at a channel center frequency of 5500 MHz utilizing a conducted test method.

CHANNEL MOVE TIME AND CHANNEL CLOSING TRANSMISSION TIME

GENERAL REPORTING NOTES

The reference marker is set at the end of last radar pulse.

The delta marker is set at the end of the last WLAN transmission following the radar pulse. This delta is the channel move time.

The aggregate channel closing transmission time is calculated as follows:

Aggregate Transmission Time =

(Number of analyzer bins showing transmission) * (dwell time per bin)

The observation period over which the aggregate time is calculated

Begins at (Reference Marker + 200 msec) and

Ends no earlier than (Reference Marker + 10 sec).



draft 802.11n Standard-20 MHz Channel mode

Type 1 Channel Move Time Results

No non-compliance noted.

Channel Move Time (s)	Limit (s)
2.86	10

Agilent 15:51:51 Aug 3, 2010

R T



Center 5.500 000 GHz Span 0 Hz
Res BW 3 MHz VBW 3 MHz Sweep 16 s (8001 pts)

Marker	Trace	Type	X Axis	Amplitude
1R	(1)	Time	2.372 s	-57.31 dBm
1Δ	(1)	Time	10 s	-59.56 dB
2	(1)	Time	2.86 s	-70.38 dBm



draft 802.11n Wide-40 MHz Channel mode

Type 1 Channel Move Time Results

No non-compliance noted.

Channel Move Time (s)	Limit (s)
4.018	10

Agilent 15:27:02 Aug 4, 2010

R T

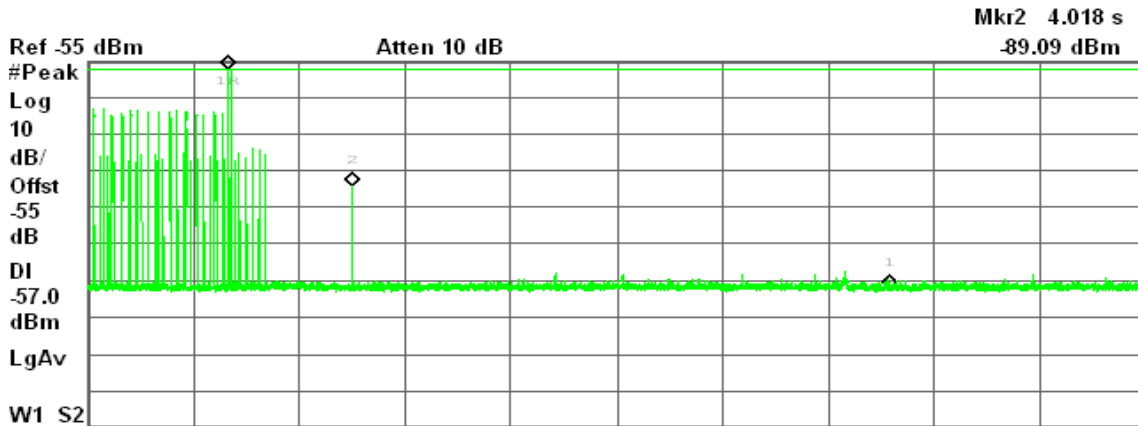

Start 5.510 000 GHz Stop 5.510 000 GHz

Res BW 3 MHz

VBW 3 MHz

Sweep 16 s (8001 pts)

Marker	Trace	Type	X Axis	Amplitude
1R	(1)	Time	2.124 s	-57.24 dBm
1Δ	(1)	Time	10 s	-60.04 dB
2	(1)	Time	4.018 s	-89.09 dBm



draft 802.11n Standard-20 MHz Channel mode

Type 1 Channel Closing Transmission Time Results

No non-compliance noted.

Aggregate Transmission Time (ms)	Limit (ms)	Margin (ms)
8	60	-52

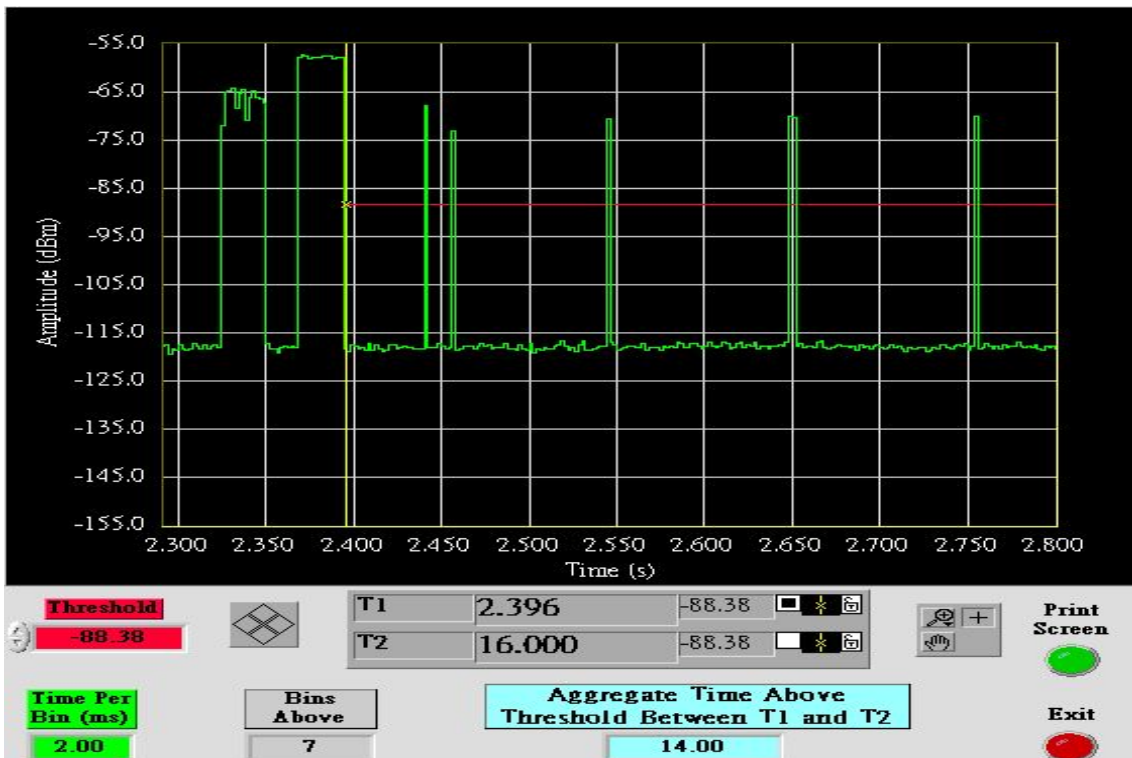
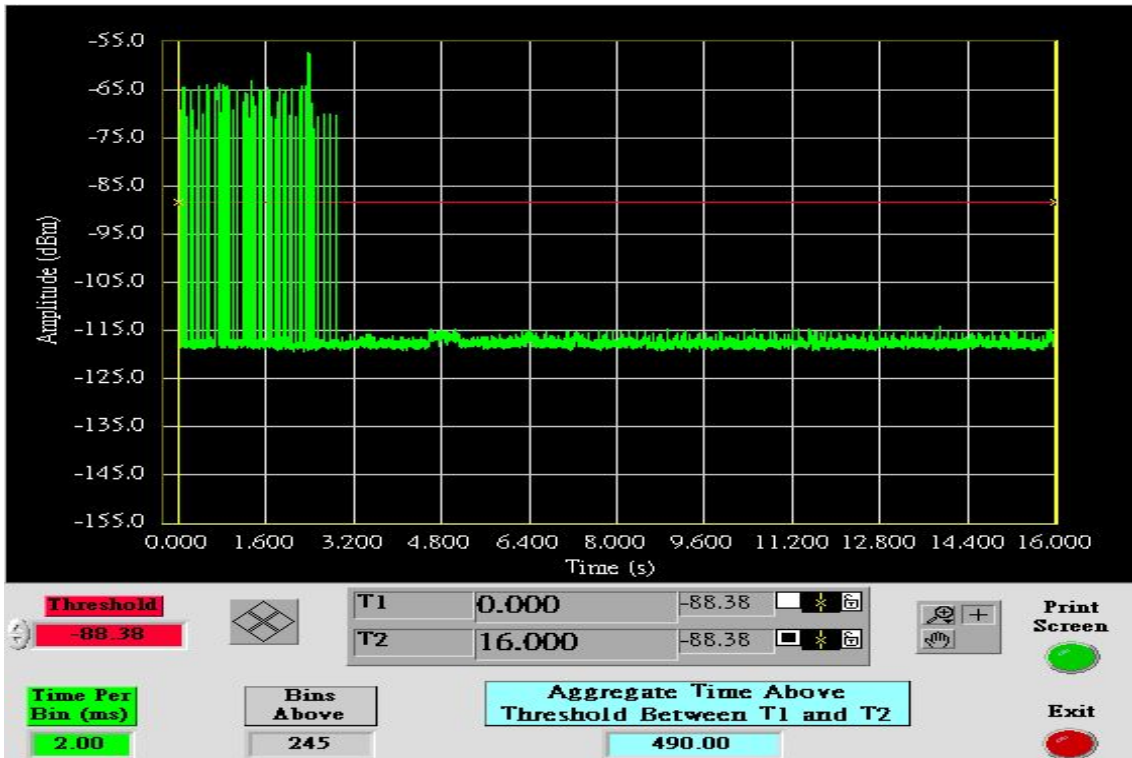

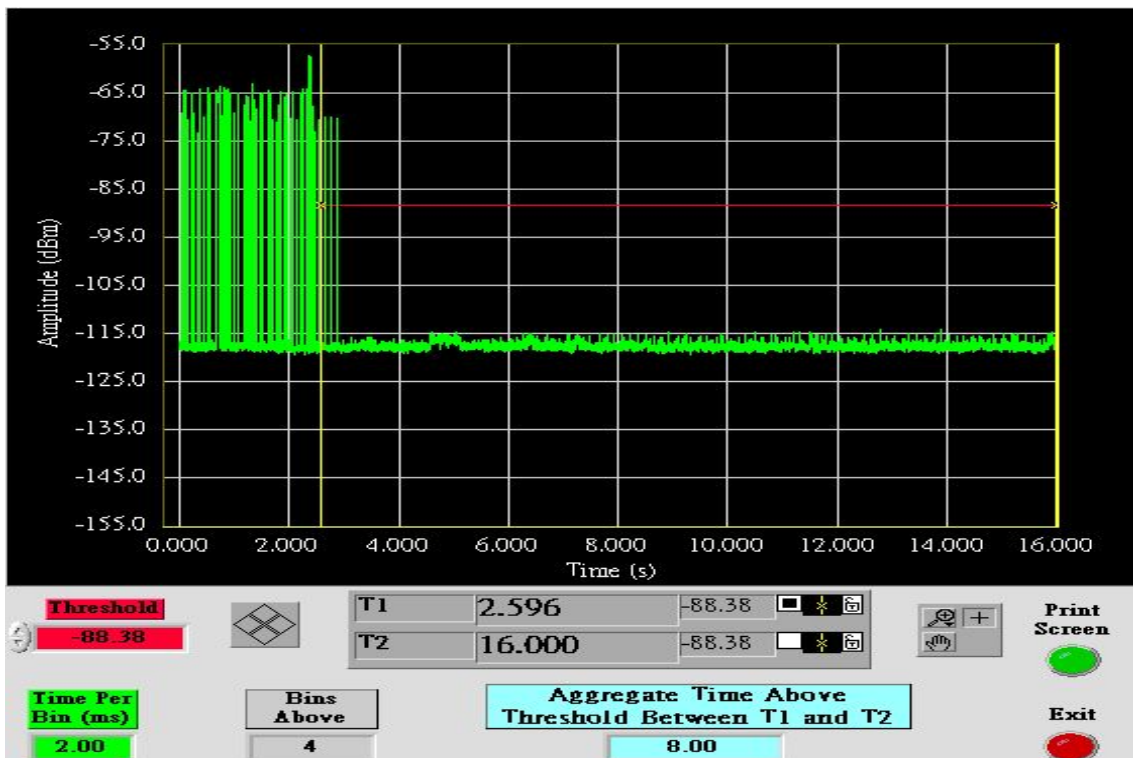
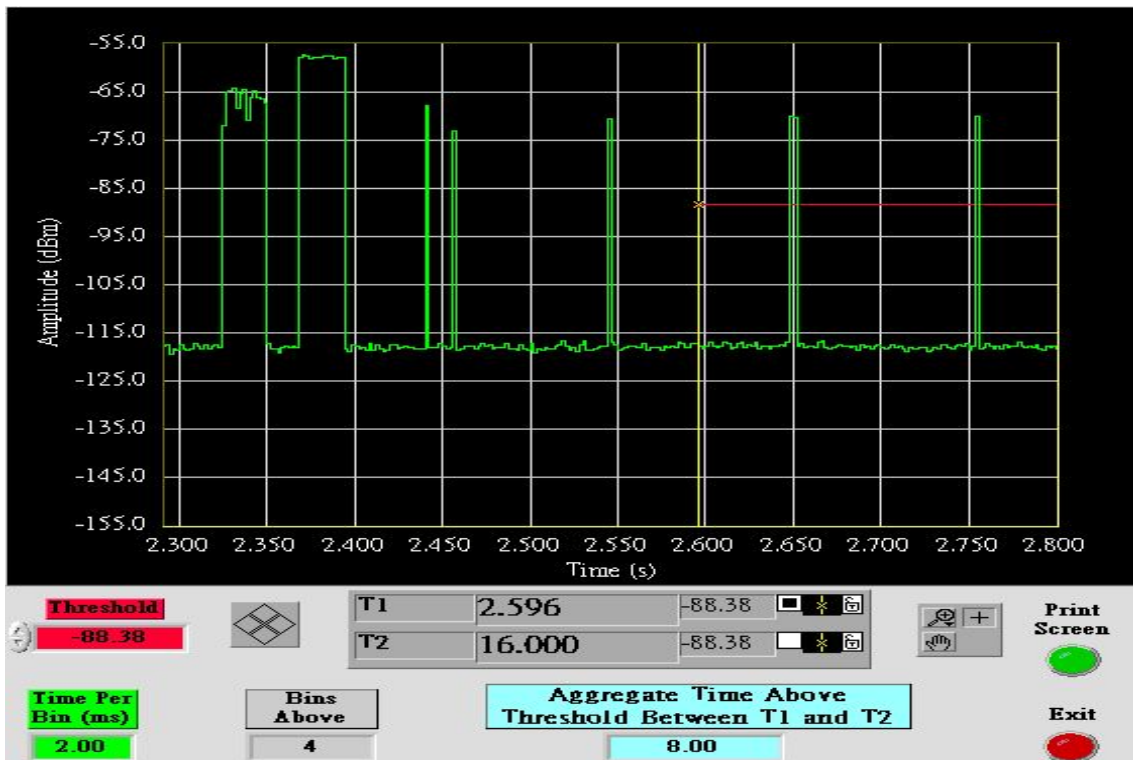



draft 802.11n Wide-40 MHz Channel mode

Type 1 Channel Closing Transmission Time Results

No non-compliance noted.

Aggregate Transmission Time (ms)	Limit (ms)	Margin (ms)
12	60	-48

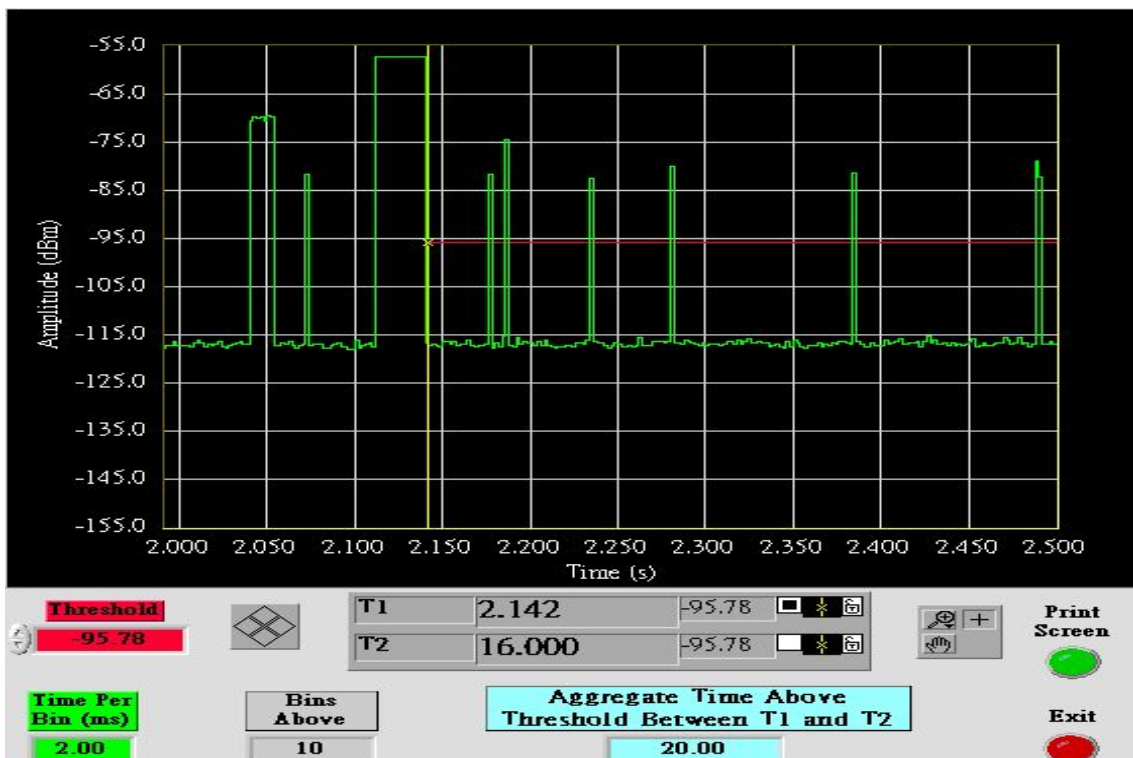
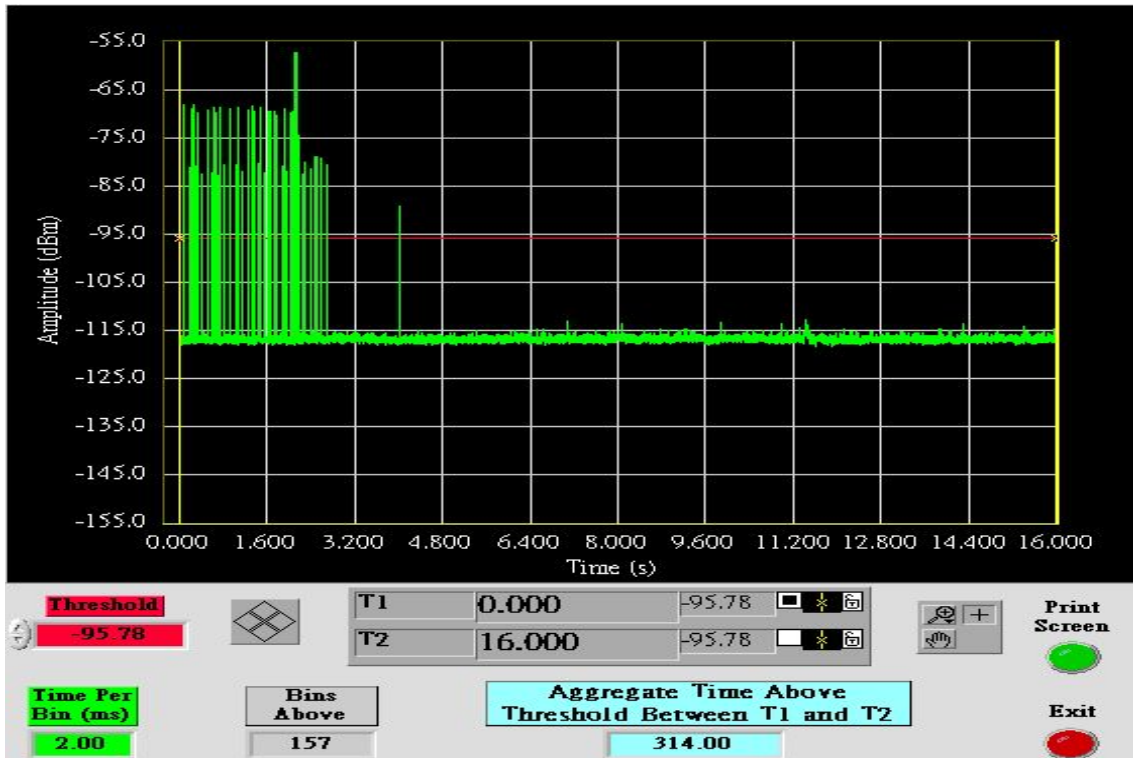

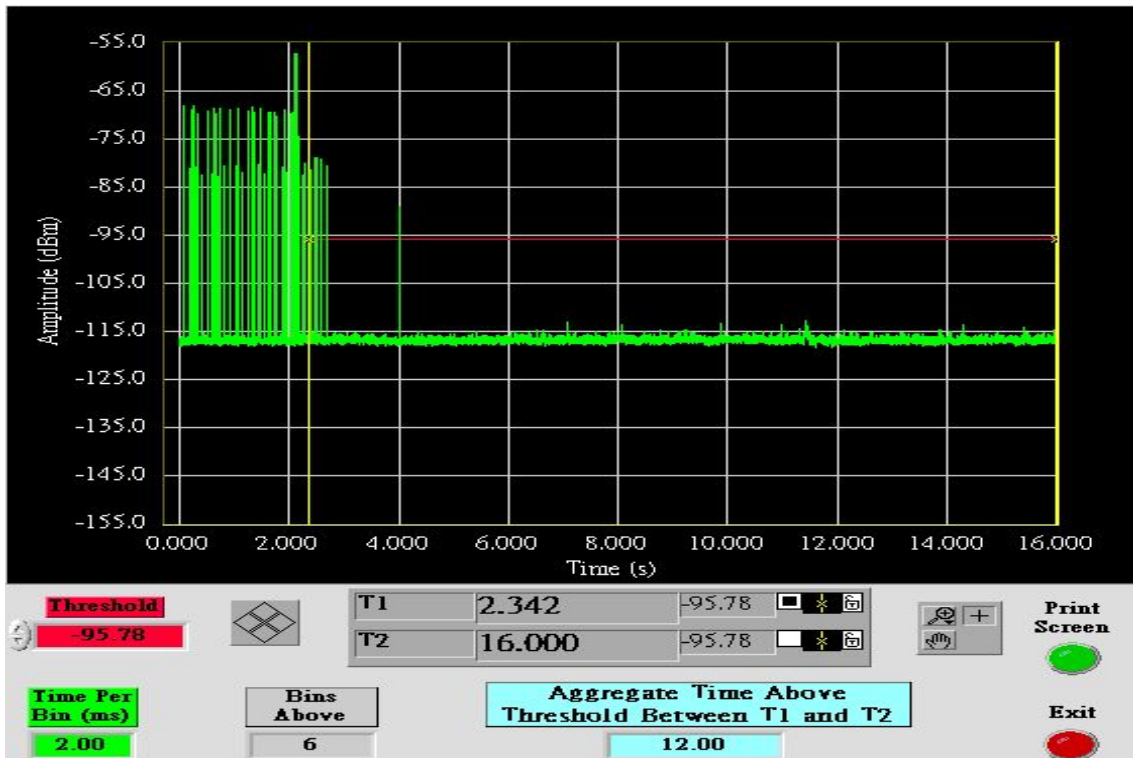
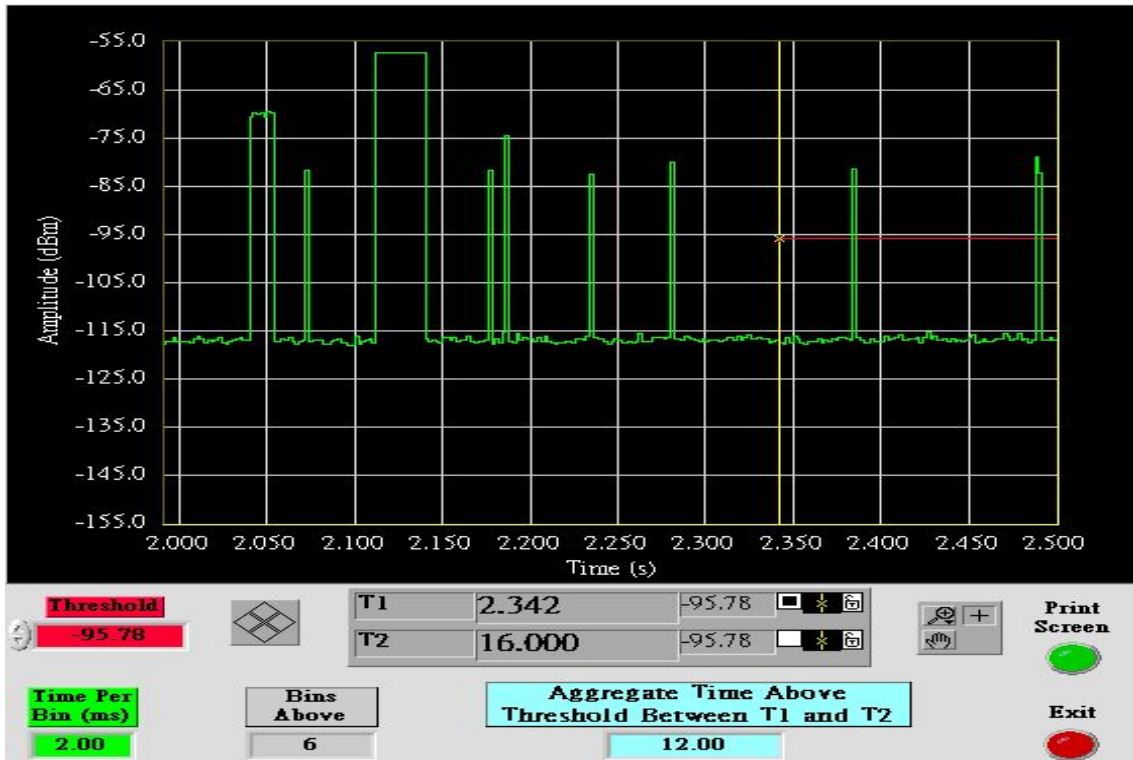



draft 802.11n Standard-20 MHz Channel mode

Type 5 Channel Move Time Results

No non-compliance noted: The traffic ceases prior to the end of the radar waveform, therefore it also ceases prior to 10 seconds after the end of the radar waveform.

Agilent 11:51:46 Aug 4, 2010

R T

Δ Mkr1 10 s

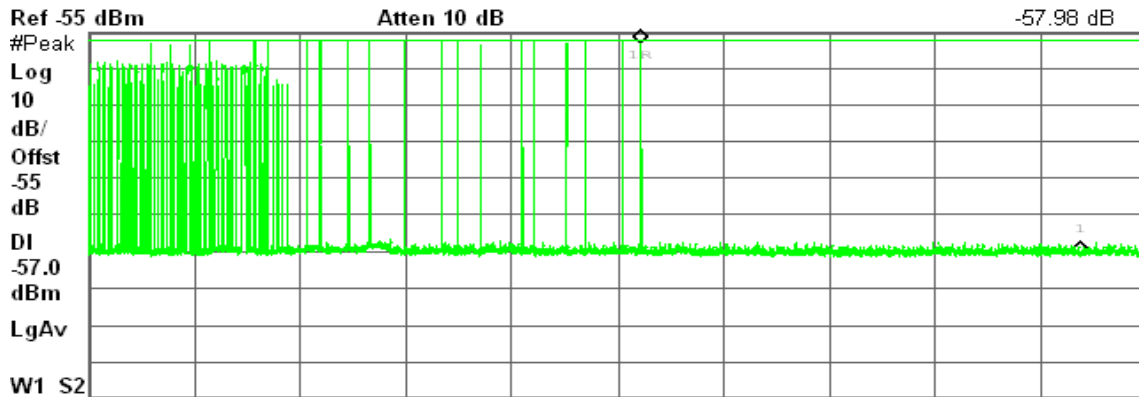

Center 5.500 000 GHz Span 0 Hz
 Res BW 3 MHz VBW 3 MHz Sweep 24 s (8001 pts)

Marker	Trace	Type	X Axis	Amplitude
1R	(1)	Time	12.52 s	-57.94 dBm
1Δ	(1)	Time	10 s	-57.98 dB



draft 802.11n Wide-40 MHz Channel mode

Type 5 Channel Move Time Results

No non-compliance noted: The traffic ceases prior to the end of the radar waveform, therefore it also ceases prior to 10 seconds after the end of the radar waveform.

Agilent 13:17:04 Aug 4, 2010

R T

Δ Mkr1 10 s
-57.55 dB

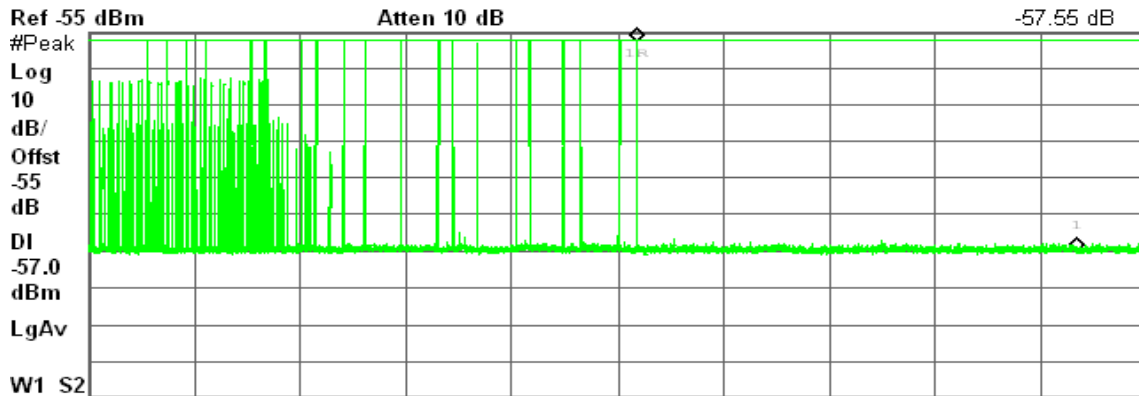

Center 5.510 000 GHz

Span 0 Hz

Res BW 3 MHz

VBW 3 MHz

Sweep 24 s (8001 pts)

Marker	Trace	Type	X Axis	Amplitude
1R	(1)	Time	12.42 s	-57.54 dBm
1Δ	(1)	Time	10 s	-57.55 dB



NON-OCCUPANCY PERIOD

draft 802.11n Wide-20 MHz mode

Type 1 Non-Occupancy Period Test Results

No non-compliance noted.

No EUT transmissions were observed on the test channel during the 30 minute observation time.

Agilent 16:49:54 Aug 3, 2010

R T

Δ Mkr1 1.8 ks

-59.62 dB

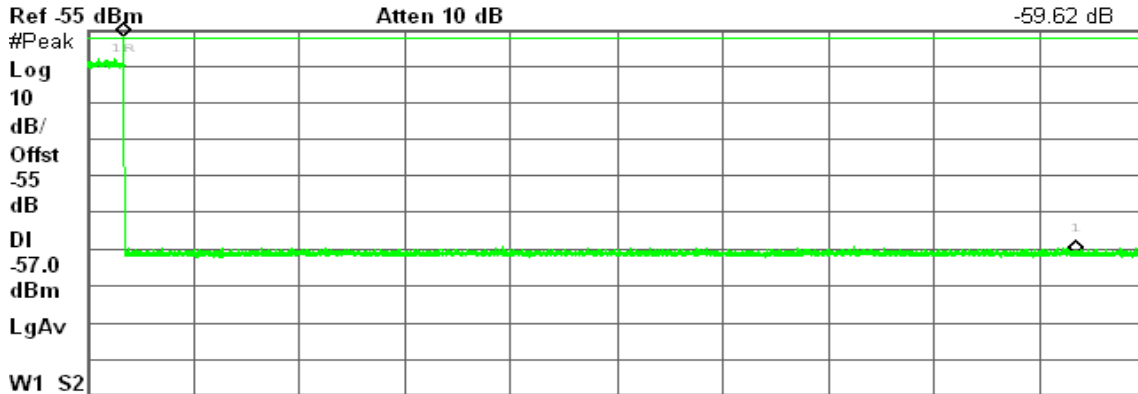

Center 5.500 000 GHz

Span 0 Hz

Res BW 3 MHz

VBW 3 MHz

Sweep 2 ks (8001 pts)

Marker	Trace	Type	X Axis	Amplitude
1R	(1)	Time	68.25 s	-56.66 dBm
1Δ	(1)	Time	1.8 ks	-59.62 dB



Type 5 Non-Occupancy Period Test Results

No non-compliance noted.

No EUT transmissions were observed on the test channel during the 30 minute observation time.

Agilent 14:51:07 Aug 4, 2010

R T

Δ Mkr1 1.8 ks

-56.26 dB

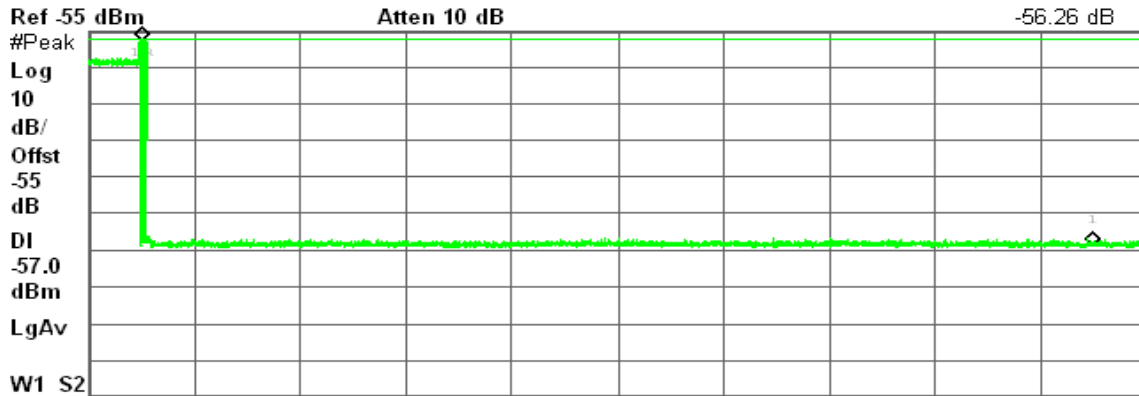

Center 5.500 000 GHz

Span 0 Hz

Res BW 3 MHz

VBW 3 MHz

Sweep 2 ks (8001 pts)

Marker	Trace	Type	X Axis	Amplitude
1R	(1)	Time	100.5 s	-57.56 dBm
1Δ	(1)	Time	1.8 ks	-56.26 dB



draft 802.11n Wide-40 MHz mode

Type 1 Non-Occupancy Period Test Results

No non-compliance noted.

No EUT transmissions were observed on the test channel during the 30 minute observation time.

Agilent 16:27:55 Aug 4, 2010

R T

Δ Mkr1 1.8 ks

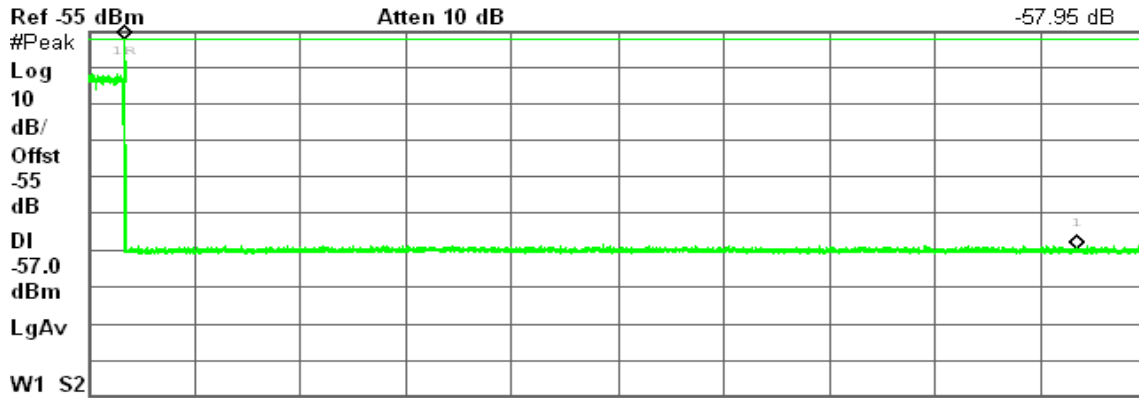

Center 5.510 000 GHz

Span 0 Hz

Res BW 3 MHz

VBW 3 MHz

Sweep 2 ks (8001 pts)

Marker	Trace	Type	X Axis	Amplitude
1R	(1)	Time	67.75 s	-56.97 dBm
1Δ	(1)	Time	1.8 ks	-57.95 dB



Type 5 Non-Occupancy Period Test Results

No non-compliance noted.

No EUT transmissions were observed on the test channel during the 30 minute observation time.

Agilent 14:09:22 Aug 4, 2010

R L

Δ Mkr1 1.8 ks

-55.68 dB



Center 5.510 000 GHz

Span 0 Hz

Res BW 3 MHz

VBW 3 MHz

Sweep 2 ks (8001 pts)

Marker	Trace	Type	X Axis	Amplitude
1R	(1)	Time	75 s	-57.49 dBm
1Δ	(1)	Time	1.8 ks	-55.68 dB



APPENDIX I RADIO FREQUENCY EXPOSURE

LIMIT

According to §15.407(f), U-NII devices are subject to the radio frequency radiation exposure requirements specified in §§ 1.1307(b), 2.1091 and 2.1093 of this chapter, as appropriate. All equipment shall be considered to operate in a "general population/uncontrolled" environment. Applications for equipment authorization of devices operating under this section must contain a statement confirming compliance with these requirements for both fundamental emissions and unwanted emissions. Technical information showing the basis for this statement must be submitted to the Commission upon request.

EUT Specification

EUT	NOTEBOOK COMPUTER
Frequency band (Operating)	<input type="checkbox"/> WLAN: 2.412GHz ~ 2.462GHz <input checked="" type="checkbox"/> WLAN: 5.15GHz ~ 5.35GHz <input checked="" type="checkbox"/> WLAN: 5.5GHz ~ 5.7GHz <input type="checkbox"/> WLAN: 5.725GHz ~ 5.850GHz <input type="checkbox"/> Bluetooth: 2.402 GHz ~ 2.482 GHz <input type="checkbox"/> Others: _____
Device category	<input checked="" type="checkbox"/> Portable (<20cm separation) <input type="checkbox"/> Mobile (>20cm separation) <input type="checkbox"/> Others: _____
Exposure classification	General Population/Uncontrolled exposure ($S=1mW/cm^2$)
Antenna diversity	<input checked="" type="checkbox"/> Single antenna <input type="checkbox"/> Multiple antennas <ul style="list-style-type: none"> <input type="checkbox"/> Tx diversity <input type="checkbox"/> Rx diversity <input type="checkbox"/> Tx/Rx diversity
Max. output power	IEEE 802.11a mode / 5180 ~ 5240MHz: 13.96 dBm (24.88mW) draft 802.11n Standard-20 MHz Channel mode / 5180 ~ 5240MHz: 9.51 dBm (8.93mW) draft 802.11n Wide-40 MHz Channel mode / 5190 ~ 5230MHz: 13.19 dBm (20.84mW) IEEE 802.11a mode / 5260 ~ 5320MHz: 17.3 dBm (53.70mW) draft 802.11n Standard-20 MHz Channel mode / 5260 ~ 5320MHz: 16.75 dBm (47.31mW) draft 802.11n Wide-40 MHz Channel mode / 5270 ~ 5310MHz: 16.98 dBm (49.88mW) IEEE 802.11a mode / 5500 ~ 5700MHz: 17.39 dBm (54.82mW) draft 802.11n Standard-20 MHz Channel mode / 5500 ~ 5700MHz: 17.19 dBm (52.36mW) draft 802.11n Wide-40 MHz Channel mode / 5510 ~ 5670MHz: 17.02 dBm (50.35mW)



Antenna gain (Max)	UNII Band I IEEE 802.11a: Gain: 2.41dBi UNII Band II: IEEE 802.11a: Gain: 1.86 UNII Band III: IEEE 802.11a: Gain: 3.48
Evaluation applied	<input type="checkbox"/> MPE Evaluation <input checked="" type="checkbox"/> SAR Evaluation* <input type="checkbox"/> N/A
Remark: 1. The maximum output power is <u>17.39 dBm (54.82mW)</u> at <u>5700MHz</u> (with <u>3.48 numeric antenna gain.</u>) 2. For mobile or fixed location transmitters, no SAR consideration applied. The maximum power density is 1.0 mW/cm^2 even if the calculation indicates that the power density would be larger.	

TEST RESULTS

No non-compliance noted.

Remark: Please refer to the separated SAR report.