

FCC Test Report

EQUIPMENT : BLUETOOTH MODULE
BRAND NAME : GETAC
MODEL NAME : GUBTCR42M
FCC ID : MAU036
STANDARD : FCC Part 15 Subpart C §15.247
CLASSIFICATION : Digital Spread Spectrum (DSS)
APPLICANT : Mitac Technology Corp
No. 1, R&D 2nd RD., HsinChu Science-Based
Industrial Park, HsinChu, Taiwan, R.O.C.

The product sample received on Nov. 21, 2008 and completely tested on Dec. 05, 2008. We, SPORTON INTERNATIONAL INC., would like to declare that the tested sample has been evaluated in accordance with the procedures given in ANSI C63.4-2003 and shown compliance with the applicable technical standards.

The EUT was installed into GETAC laptop PC, brand name: GETAC / model name : V100, during test.

The test results in this report apply exclusively to the tested model / sample. Without written approval of SPORTON INTERNATIONAL INC., the test report shall not be reproduced except in full.



Reviewed by: Roy Wu / Manager



SPORTON INTERNATIONAL INC.

No. 52, Hwa Ya 1st Rd., Hwa Ya Technology Park, Kwei-Shan Hsiang, Tao Yuan Hsien, Taiwan, R.O.C.

SPORTON INTERNATIONAL INC.

TEL : 886-3-327-3456

FAX : 886-3-328-4978

FCC ID : MAU036

Page Number : 1 of 50

Report Issued Date : Dec. 08, 2008

Report Version : Rev. 01



TABLE OF CONTENTS

SUMMARY OF TEST RESULT 3

REVISION HISTORY..... 4

1 GENERAL DESCRIPTION..... 5

 1.1 Applicant 5

 1.2 Manufacturer..... 5

 1.3 Feature of Equipment Under Test 5

 1.4 Testing Site..... 7

 1.5 Applied Standards 7

 1.6 Ancillary Equipment List 7

2 TEST CONFIGURATION OF EQUIPMENT UNDER TEST..... 8

 2.1 Pre-Scanned RF Power..... 8

 2.2 Test Mode..... 8

 2.3 Connection Diagram of Test System..... 9

 2.4 RF Utility 10

3 TEST RESULT 11

 3.1 Number of Channel Measurement 11

 3.2 20dB Bandwidth Measurement 13

 3.3 Hopping Channel Separation Measurement 16

 3.4 Dwell Time Measurement..... 19

 3.5 Peak Output Power Measurement 21

 3.6 Band Edges Measurement..... 24

 3.7 AC Conducted Emission Measurement..... 28

 3.8 Radiated Emission Measurement..... 32

 3.9 Antenna Requirements..... 46

4 LIST OF MEASURING EQUIPMENTS 47

5 UNCERTAINTY OF EVALUATION..... 48

6 CERTIFICATION OF TAF ACCREDITATION 50

APPENDIX A. PHOTOGRAPHS OF EUT

APPENDIX B. SETUP PHOTOGRAPHS



SUMMARY OF TEST RESULT

Report Section	FCC Rule	IC Rule	Description	Limit	Result	Remark
3.1	15.247(b)(1)	A8.4(2)	Number of Channels	≥ 15Chs	Pass	
3.2	15.247(a)(1)	A8.1(a)	20dB Bandwidth	NA	Pass	-
3.3	15.247(a)(1)	A8.1(b)	Channel Separation	≥ 2/3 of 20dB BW	Pass	-
3.4	15.247(a)(1)	A8.1(d)	Dwell Time of Each Channel	≤ 0.4sec in 31.6sec period	Pass	-
3.5	15.247(a)(1)	A8.1(b)	Peak Output Power	≤ 0.125W	Pass	-
3.6	15.247(d)	A8.5	Frequency Band Edges	≤ 20dBc	Pass	-
3.7	15.207	Gen 7.2.2	AC Conducted Emission	15.207(a)	Pass	Under limit 12.20 dB at 0.446 MHz
3.8	15.247(d)	A8.5	Transmitter Radiated Emission	15.209(a) & 15.247(d)	Pass	Under limit 10.00 dB at 233.58 MHz
3.9	15.203 & 15.247(b)	A8.4	Antenna Requirement	N/A	Pass	-

1 General Description

1.1 Applicant

Mitac Technology Corp

No. 1, R&D 2nd RD., HsinChu Science-Based Industrial Park, HsinChu, Taiwan, R.O.C.

1.2 Manufacturer

Mitac Technology Corp

No. 1, R&D 2nd RD., HsinChu Science-Based Industrial Park, HsinChu, Taiwan, R.O.C.

Getac Technology (Kunshan) Co., Ltd

No. 269, 2nd Road, Export Processing Zone, Changjiang South Road, Kunshan, Jiangsu, P.R.C.
215300

1.3 Feature of Equipment Under Test

Product Feature & Specification	
Equipment	Bluetooth Module
Brand Name	Getac
Model Name	GUBTCR42M
Tx/Rx Frequency Range	2400 MHz ~ 2483.5 MHz
Number of Channels	79
Carrier Frequency of Each Channel	2402+n*1 MHz; n=0~78
Channel Spacing	1 MHz
Maximum Output Power to Antenna	Bluetooth : 3.39 dBm (1Mbps) Bluetooth EDR : 0.76dBm (2Mbps) / 0.95dBm (3Mbps)
Antenna Type	PIFA Antenna with gain 4 dBi
Type of Modulation	Bluetooth (1Mbps) : GFSK Bluetooth EDR (2Mbps) : $\pi/4$ -DQPSK Bluetooth EDR (3Mbps) : 8-DPSK
EUT Stage	Identical Prototype

The specification of laptop PC, V100 :

Parts		Specifications
CPU		Intel® SU9400 Core 2 Duo ULV 1.4 GHz processor 800 MHz FSB (Front Side Bus), Thermal specifications 10 W
Cache Memory		3 MB L2 cache
Chipset	NorthBridge	Intel® GS45
	SouthBridge	ICH9M (small form factor)
BIOS		4 MB EEPROM, system and VGA BIOS, G-sensor support, Plug-and-Play, ACPI 2.0 capability, boot from SATA/LAN/USB devices (e.g., DVD Combo / DVD Dual / Flash / floppy drives), light sensor for LCD panel and keyboard backlight brightness control support, computrace

The more details information, please find the user manual.

1.4 Testing Site

Test Site	SPORTON INTERNATIONAL INC.		
Test Site Location	No. 52, Hwa Ya 1 st Rd., Hwa Ya Technology Park, Kwei-Shan Hsiang, Tao Yuan Hsien, Taiwan, R.O.C TEL: +886-3-3273456 / FAX: +886-3-3284978		
Test Site No.	Sporton Site No.		FCC/IC Registration No.
	CO05-HY	03CH06-HY	TW1022/4086B-1

1.5 Applied Standards

According to the specifications of the manufacturer, the EUT must comply with the requirements of the following standards:

- ♦ FCC Part 15 Subpart C §15.247
- ♦ FCC Public Notice DA 00-705
- ♦ ANSI C63.4-2003
- ♦ IC RSS-210 Issue 7

Remark:

1. All test items were verified and recorded according to the standards and without any deviation during the test.
2. This EUT has also been tested and complied with the requirements of FCC Part 15, Subpart B (DoC), recorded in a separate test report.

1.6 Ancillary Equipment List

Item	Equipment	Trade Name	Model Name	FCC ID	Data Cable	Power Cord
1.	LCD Monitor	lenovo	6135-AB1	FCC DoC	Shielded, 1.6 m	Unshielded, 1.8 m
2.	Earphone + Mic	Sampo	EK-Y652CS	FCC DoC	Shielded, 1.8 m	N/A
3.	Bluetooth Earphone	Cellink	BTHS-6025-F	PQY-4710874200357	N/A	N/A
4.	WLAN AP	SMC	SMC-100	HEDWG4005ACC	N/A	Unshielded, 1.8 m
5.	i-pod	Apple	A1199	FCC DoC	Shielded, 1.0 m	N/A
6.	Exchange	Sun Moon Star	SMS-4 PLUS	95180108	Shielded, 1.6 m	N/A

2 Test Configuration of Equipment Under Test

2.1 Pre-Scanned RF Power

Preliminary tests were performed in different data rate and recorded the RF output power in the following table:

RF Output Power				
Channel	Frequency	Data Rate / Modulation		
		GFSK	$\pi/4$ -DQPSK	8-DPSK
		1Mbps	2Mbps	3Mbps
Ch00	2402MHz	2.92 dBm	0.43 dBm	0.57 dBm
Ch39	2441MHz	3.39 dBm	0.76 dBm	0.95 dBm
Ch78	2480MHz	3.20 dBm	0.37 dBm	0.65 dBm

Remark:

1. The data rate 1Mbps was set for all the test cases, due to the highest RF output power.
2. The data rate 1Mbps was set for 20 dB band width and dwell time test cases.
3. The EUT is programmed to transmit signal continuously for all testing.

2.2 Test Mode

The EUT has been associated with peripherals pursuant to ANSI C63.4-2003 and configuration operated in a manner tended to maximize its emission characteristics in a typical application. Frequency range investigated: conduction (150 kHz to 30 MHz), radiation (9 kHz to the 10th harmonic of the highest fundamental frequency or to 40 GHz, whichever is lower). Pre-scanned tests, X,Y,Z in three orthogonal panels, were conducted to determine the final configuration from all possible combinations, laptop / tablet modes. The pre-scan results have been estimated the most severity frequency range from 1 to 25GHz at middle channel, and met the FCC limits. The worst case mode was estimated from the harmonics and fundamental carrier for full test. The following tables are showing the test modes as the worst cases and recorded in this report.

Test Cases			
Test Item	Modulation		
	Bluetooth 1Mbps GFSK	Bluetooth EDR 2Mbps $\pi/4$ -DQPSK	Bluetooth EDR 3Mbps 8-DPSK
Conducted TCs	<ul style="list-style-type: none"> ■ Mode 1: CH00_2402 MHz ■ Mode 2: CH39_2441 MHz ■ Mode 3: CH78_2480 MHz 	<ul style="list-style-type: none"> ■ Mode 4: CH00_2402 MHz ■ Mode 5: CH39_2441 MHz ■ Mode 6: CH78_2480 MHz 	<ul style="list-style-type: none"> ■ Mode 7: CH00_2402 MHz ■ Mode 8: CH39_2441 MHz ■ Mode 9: CH78_2480 MHz
Radiated TCs	<ul style="list-style-type: none"> ■ Mode 1: CH00_2402 MHz ■ Mode 2: CH39_2441 MHz ■ Mode 3: CH78_2480 MHz 	N/A	N/A
AC Conducted Emission	<ul style="list-style-type: none"> ■ Mode 1 : BT Link + Adapter 		
Remark: The worst case of testing is Bluetooth 1Mbps, only the test data of these modes was reported.			

2.3 Connection Diagram of Test System

<Conducted Emission>

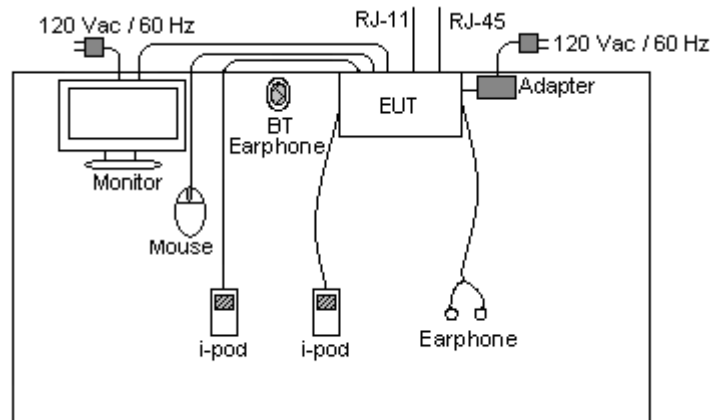

<Radiated Emission>

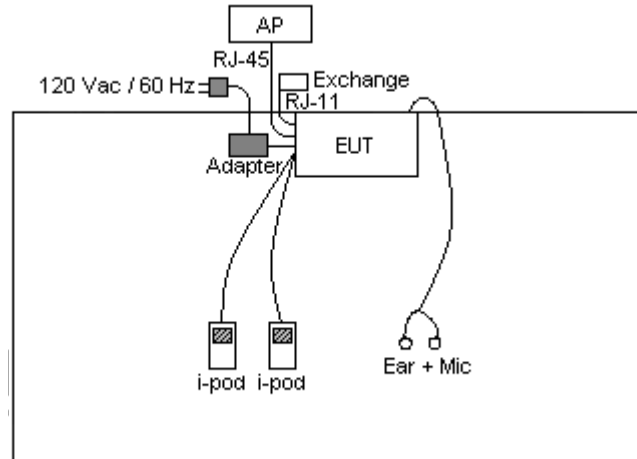

2.4 RF Utility

For Bluetooth function, the RF Utility, "Blue Test" was installed in EUT, which was programmed to link with BT base station in engineering mode.

3 Test Result

3.1 Number of Channel Measurement

3.1.1 Limits of Number of Hopping Frequency

Frequency hopping systems in the 2400-2483.5 MHz band shall use at least 15 channels.

3.1.2 Measuring Instruments

See list of measuring instruments of this test report.

3.1.3 Test Procedure

1. The testing follows FCC Public Notice DA 00-705 Measurement Guidelines.
2. The RF output of EUT was connected to the spectrum analyzer by a low loss cable.
3. The modulation types of EUT are irrelevant to number of hopping channels deviation.
4. The EUT must have its hopping function enabled. Use the following spectrum analyzer settings:
Span = the frequency band of operation; RBW \geq 1% of the span; VBW \geq RBW; Sweep = auto;
Detector function = peak; Trace = max hold.
5. The number of hopping frequency used is defined as the device has the numbers of total channel.

3.1.4 Test Setup

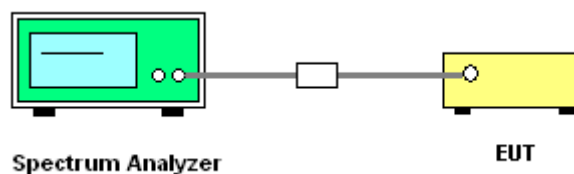

3.1.5 Test Result of Number of Hopping Frequency

Test Mode :	Mode 1, 2, 3	Temperature :	24~25°C
Test Engineer :	Ken Hsu	Relative Humidity :	35~37%
Number of Hopping Channels (Channel)		Limits (Channel)	
79		> 15	
		Pass/Fail	
		Pass	

Number of Hopping Channel Plot on Channel 00 - 78

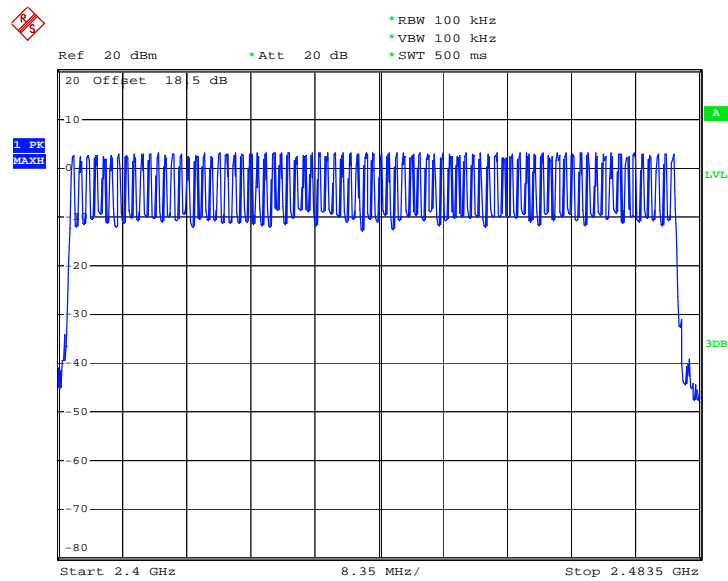

Date: 3.DEC.2008 13:15:35

3.2 20dB Bandwidth Measurement

3.2.1 Limit of 20dB Bandwidth

N/A

3.2.2 Measuring Instruments

See list of measuring instruments of this test report.

3.2.3 Test Procedures

1. The testing follows FCC Public Notice DA 00-705 Measurement Guidelines.
2. The RF output of EUT was connected to the spectrum analyzer by a low loss cable.
3. The EUT should be transmitting at its maximum data rate as the worst cases.
4. Use the following spectrum analyzer settings:
Span = approximately 2 to 3 times the 20 dB bandwidth, centered on a hopping channel;
RBW \geq 1% of the 20 dB bandwidth; VBW \geq RBW; Sweep = auto; Detector function = peak;
Trace = max hold.
5. The marker-delta reading at this point is the 20 dB bandwidth of the emission.

3.2.4 Test Setup

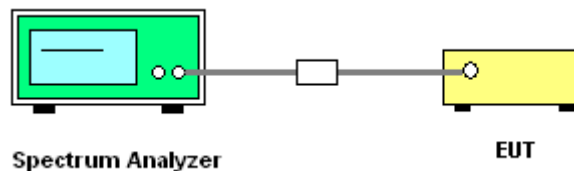



20 dB Bandwidth Plot on Channel 39

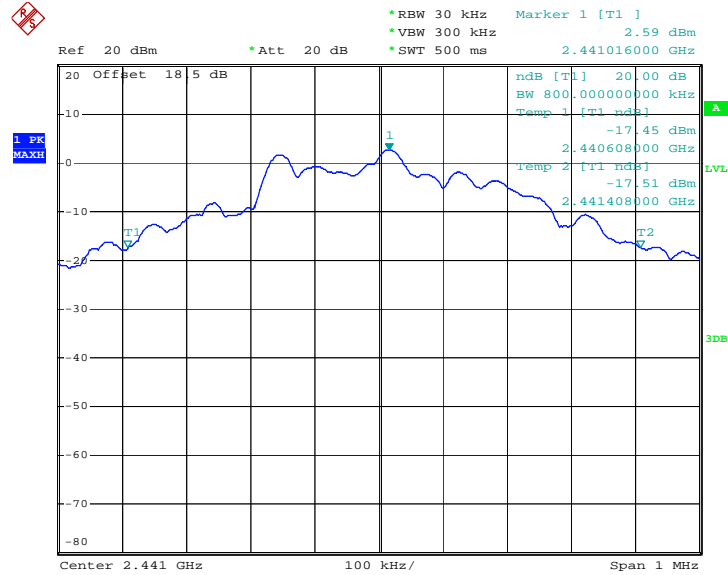

Date: 3.DEC.2008 10:24:48

20 dB Bandwidth Plot on Channel 78

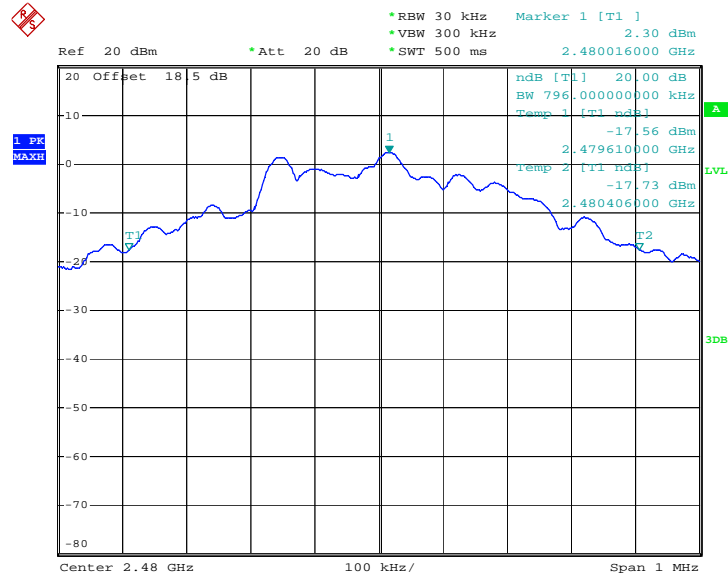

Date: 3.DEC.2008 10:25:13

3.3 Hopping Channel Separation Measurement

3.3.1 Limit of Hopping Channel Separation

Frequency hopping systems operating in the 2400-2483.5 MHz band may have hopping channel carrier frequencies that are separated by 25 kHz or two-thirds of the 20 dB bandwidth of the hopping channel, whichever is greater, provided the systems operate with an output power no greater than 125 mW.

3.3.2 Measuring Instruments

See list of measuring instruments of this test report.

3.3.3 Test Procedures

1. Please refer FCC Public Notice DA 00-705 Measurement Guidelines.
2. The RF output of EUT was connected to the spectrum analyzer by a low loss cable.
3. The EUT should be transmitting at its maximum data rate as the worst cases.
4. Use the following spectrum analyzer settings:
Span = wide enough to capture the peaks of two adjacent channels; $RBW \geq 1\%$ of the span;
 $VBW \geq RBW$; Sweep = auto; Detector function = peak; Trace = max hold.
5. Use the marker-delta function to determine the separation between the peaks of the adjacent channels.

3.3.4 Test Setup

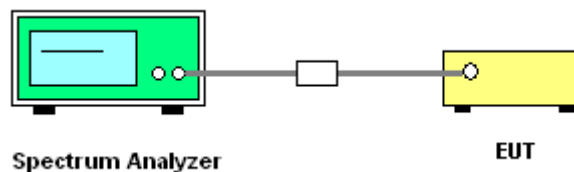

3.3.5 Test Result of Hopping Channel Separation

Test Mode :	Mode 1, 2, 3	Temperature :	24~25°C
Test Engineer :	Ken Hsu	Relative Humidity :	35~37%

Channel	Frequency (MHz)	Frequency Separation (MHz)	(2/3 of 20dB BW) Limits (MHz)	Pass/Fail
00	2402	1.000	0.532	Pass
39	2441	1.000	0.533	Pass
78	2480	1.000	0.531	Pass

Channel Separation Plot on Channel 00 - 01

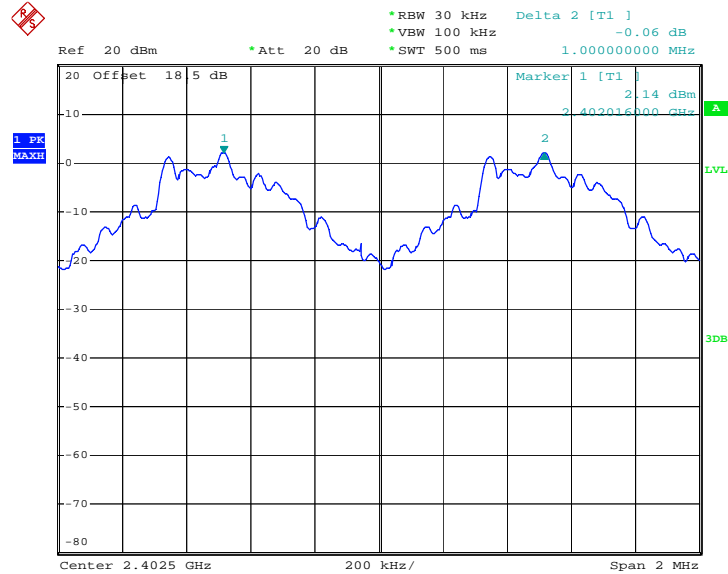

Date : 3.DEC.2008 10:34:32



Channel Separation Plot on Channel 39 - 40

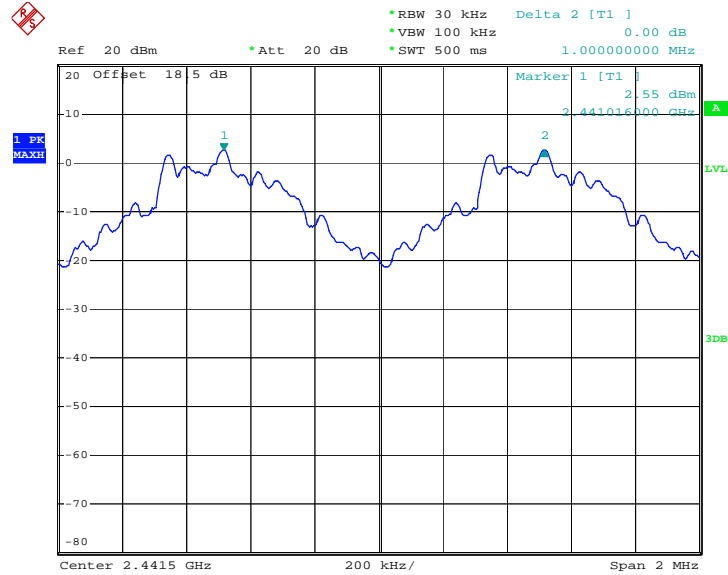

Date: 3.DEC.2008 10:35:19

Channel Separation Plot on Channel 77 - 78

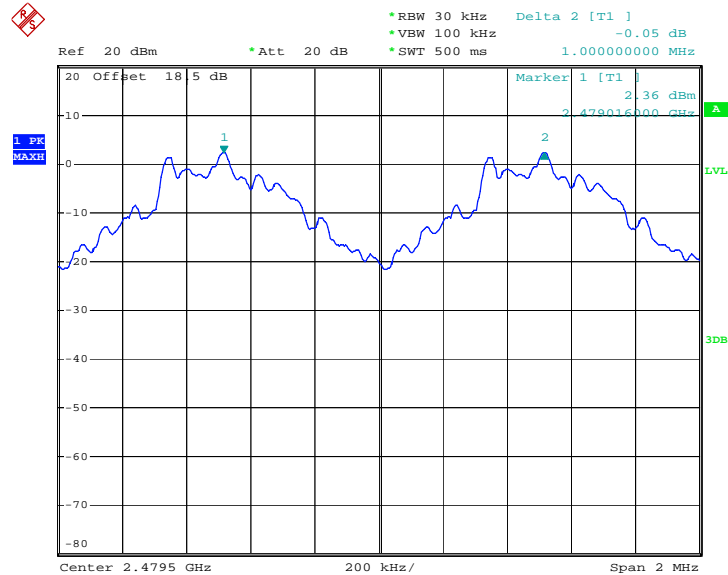

Date: 3.DEC.2008 10:35:50

3.4 Dwell Time Measurement

3.4.1 Limit of Dwell Time

The average time of occupancy on any channel shall not be greater than 0.4 seconds within a period of 0.4 seconds multiplied by the number of hopping channels employed.

3.4.2 Measuring Instruments

See list of measuring instruments of this test report.

3.4.3 Test Procedures

1. The testing follows FCC Public Notice DA 00-705 Measurement Guidelines.
2. The RF output of EUT was connected to the spectrum analyzer by a low loss cable.
3. The EUT should be transmitting at its maximum data rate as the worst cases.
4. The EUT must have its hopping function enabled. Use the following spectrum analyzer settings:
Span = zero span, centered on a hopping channel; RBW = 1 MHz; VBW ≥ RBW; Sweep = as necessary to capture the entire dwell time per hopping channel; Detector function = peak; Trace = max hold.
5. Use the marker-delta function to calculate the dwell time.

3.4.4 Test Setup

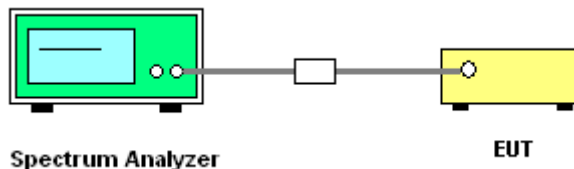

3.4.5 Test Result of Dwell Time

Test Mode :	Mode 3	Temperature :	24~25°C
Test Engineer :	Ken Hsu	Relative Humidity :	35~37%

Package Mode	Average Hopping Channel	Package Transfer Time (usec)	Dwell Time (sec)	Limits (sec)	Pass/Fail
DH5	3.40	3020.00	0.324	0.4	Pass

Remark:

1. Dwell Time=79(channels) x 0.4(s) x average hopping channel x package transfer time
2. 79 channels come from the Hopping Channel number.
3. Average Hopping Channel = hops/sweep time
4. t: Package Transfer Time(us)



DH5 Dwell Time (One Pulse) Plot on Channel 39

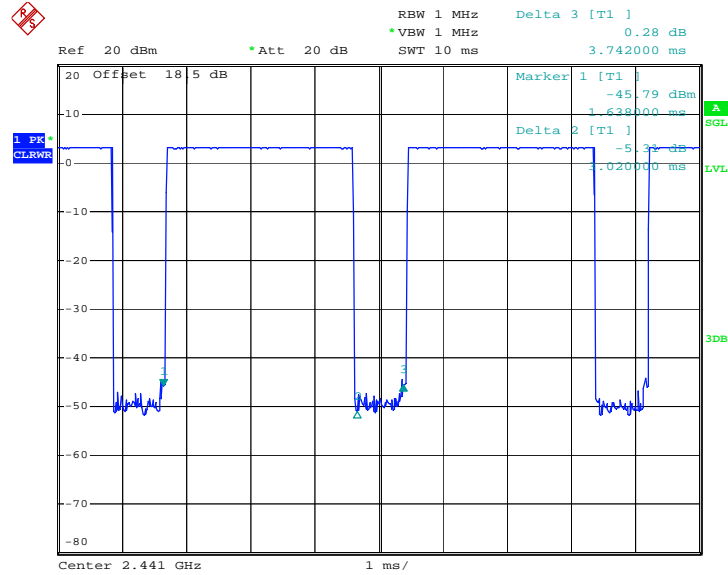

Date: 3.DEC.2008 10:38:57

DH5 Dwell Time (Count Pulses) Plot on Channel 39

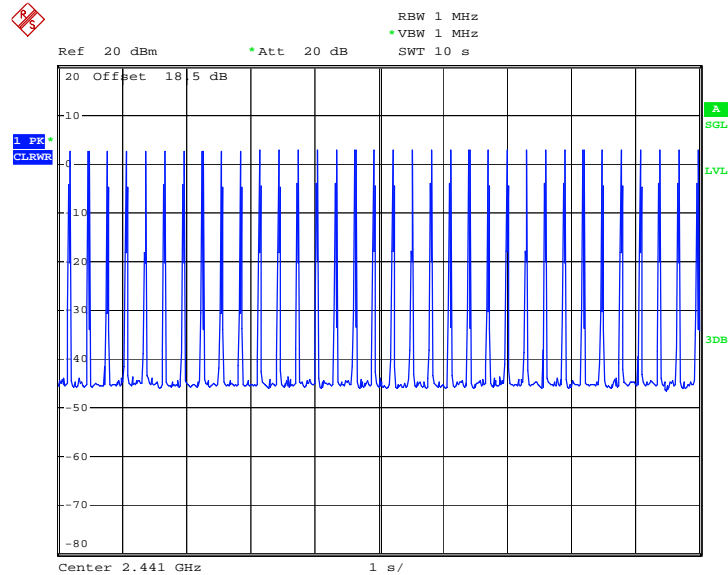

Date: 3.DEC.2008 10:39:28

3.5 Peak Output Power Measurement

3.5.1 Limit of Peak Output Power

Frequency hopping systems operating in the 2400-2483.5 MHz band may have hopping channel carrier frequencies that are separated by 25 kHz or two-thirds of the 20 dB bandwidth of the hopping channel, whichever is greater, provided the systems operate with an output power no greater than 1 W (30 dBm).

3.5.2 Measuring Instruments

See list of measuring instruments of this test report.

3.5.3 Test Procedures

1. The testing follows FCC Public Notice DA 00-705 Measurement Guidelines.
2. The RF output of EUT was connected to the peak power meter by a low loss cable.

3.5.4 Test Setup

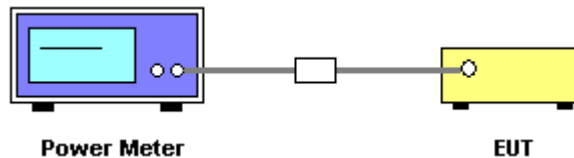

3.5.5 Test Result of Peak Output Power

Test Mode :	Mode 1, 2, 3	Temperature :	24~25°C
Test Engineer :	Ken Hsu	Relative Humidity :	35~37%

Channel	Frequency (MHz)	RF Power (dBm)		
		GFSK	Max. Limits (dBm)	Pass/Fail
		1 Mbps		
00	2402	2.92	30	Pass
39	2441	3.39	30	Pass
78	2480	3.20	30	Pass



Peak Output Power Plot on Channel 00

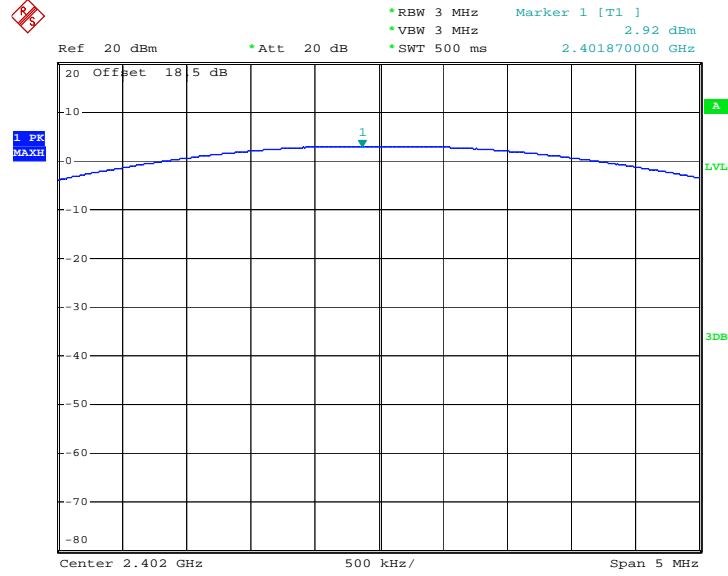

Date: 3.DEC.2008 09:58:58

Peak Output Power Plot on Channel 39

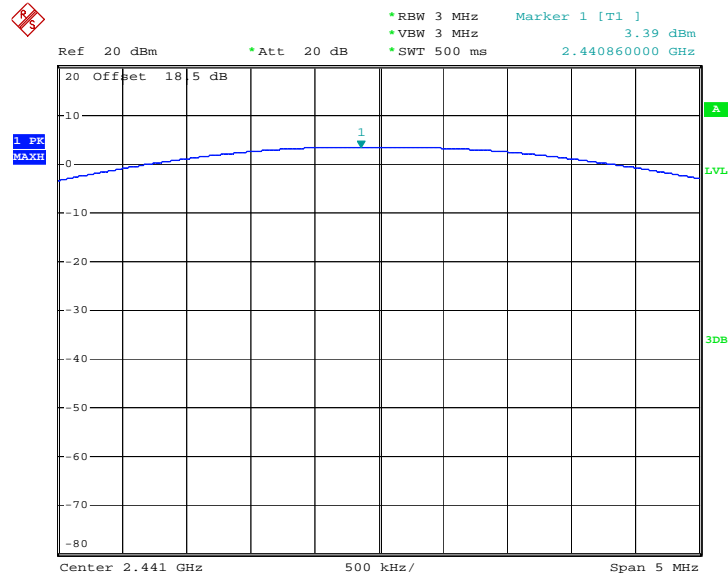

Date: 3.DEC.2008 09:59:14



Peak Output Power Plot on Channel 78

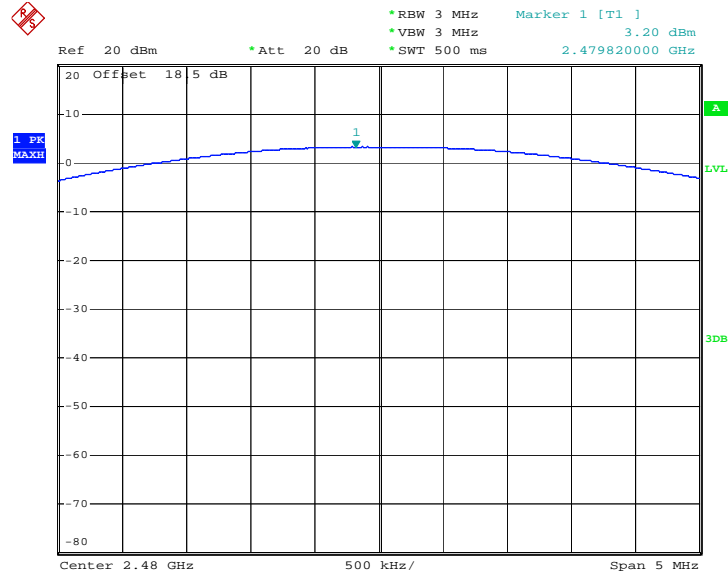

Date: 3.DEC.2008 09:59:33

3.6 Band Edges Measurement

3.6.1 Limit of Band Edges

In any 100 kHz bandwidth outside the intentional radiation frequency band, the radio frequency power shall be at least 20 dB below the highest level of the radiated power. In addition, radiated emissions which fall in the restricted bands must also comply with the radiated emission limits.

3.6.2 Measuring Instruments

See list of measuring instruments of this test report.

3.6.3 Test Procedures

1. The testing follows the guidelines in ANSI C63.4-2003 and FCC Public Notice DA 00-705 Measurement Guidelines.
2. RF antenna conducted test: Set RBW = 100 kHz, Video bandwidth (VBW) > RBW, scan up through 10th harmonic. Band edge emissions must be at least 20 dB down from the highest emission level within the authorized band as measured with a 100 kHz RBW. Note: If the device complies with the use of power option 2 the attenuation under this paragraph shall be 30 dB instead of 20 dB.
3. Radiated emission test: Applies to band edge emissions that fall in the restricted bands listed in FCC Section 15.205. The maximum permitted average field strength is listed in FCC Section 15.209. A pre-amp is necessary for this measurement. For measurements above 1 GHz, set RBW = 1MHz, VBW = 10 Hz, Sweep: Auto. If the emission is pulsed, modify the unit for continuous operation; use the settings shown above, then correct the reading by subtracting the peak-average correction factor, derived from the appropriate duty cycle calculation. See FCC Section 15.35(b) and (c).

3.6.4 Test Setup

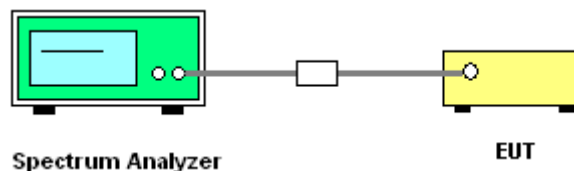



3.6.5 Test Result of Radiated Band Edges

Test Mode :	Mode 1	Temperature :	20~22°C
Test Channel :	00	Relative Humidity :	48~50%
Test Engineer :	Andrew Hsiao		

ANTENNA POLARITY : HORIZONTAL										
Frequency (MHz)	Level (dBuV/m)	Over Limit (dB)	Limit Line (dBuV/m)	Read Level (dBuV)	Antenna Factor (dB)	Cable Loss (dB)	Preamp Factor (dB)	Ant Pos (cm)	Table Pos (deg)	Remark
2389.61	54.20	-19.80	74.00	53.97	31.98	3.92	35.67	100	0	Peak
2389.61	14.43	-39.57	54.00	14.20	31.98	3.92	35.67	160	4	Average

Remark:

<Delta Marker>

Delta marker at 1% RBW of span = 43.63 dB

Peak band edge at 2389.61 MHz (RBW = VBW = 1MHz) = 97.83 dBuV/m – 43.63 dB = 54.20 dBuV/m

Duty factor = 20 log (Package Transfer Times x Avg Hopping Channel) = 20 log (0.00302 x 3.4) = -39.77

Average band edge = Peak band edge + Duty factor = 54.20 dBuV/m + (-39.77) = 14.43 dBuV/m

ANTENNA POLARITY : VERTICAL										
Frequency (MHz)	Level (dBuV/m)	Over Limit (dB)	Limit Line (dBuV/m)	Read Level (dBuV)	Antenna Factor (dB)	Cable Loss (dB)	Preamp Factor (dB)	Ant Pos (cm)	Table Pos (deg)	Remark
2389.61	53.02	-20.98	74.00	52.79	31.98	3.92	35.67	100	0	Peak
2389.61	13.25	-40.75	54.00	13.02	31.98	3.92	35.67	100	309	Average

Remark:

<Delta Marker>

Delta marker at 1% RBW of span = 43.63 dB

Peak band edge at 2389.61 MHz (RBW = VBW = 1MHz) = 96.65 dBuV/m – 43.63 dB = 53.02 dBuV/m

Duty factor = 20 log (Package Transfer Times x Avg Hopping Channel) = 20 log (0.00302 x 3.4) = -39.77

Average band edge = Peak band edge + Duty factor = 53.02 dBuV/m + (-39.77) = 13.25 dBuV/m



Test Mode :	Mode 3	Temperature :	20~22°C
Test Channel :	78	Relative Humidity :	48~50%
Test Engineer :	Andrew Hsiao		

ANTENNA POLARITY : HORIZONTAL										
Frequency (MHz)	Level (dBuV/m)	Over Limit (dB)	Limit Line (dBuV/m)	Read Level (dBuV)	Antenna Factor (dB)	Cable Loss (dB)	Preamp Factor (dB)	Ant Pos (cm)	Table Pos (deg)	Remark
2483.50	49.85	-24.15	74.00	49.41	32.08	4.05	35.69	100	0	Peak
2483.50	10.08	-43.92	54.00	9.64	32.08	4.05	35.69	100	17	Average

Remark:

<Delta Marker>

Delta marker at 1% RBW of span = 45.49 dB

Peak band edge at 2483.50 MHz (RBW = VBW = 1MHz) = 95.34 dBuV/m – 45.49 dB = 49.85 dBuV/m

Duty factor = 20 log (Package Transfer Times x Avg Hopping Channel) = 20 log (0.00302 x 3.4) = -39.77

Average band edge = Peak band edge + Duty factor = 49.85 dBuV/m + (-39.77) = 10.08 dBuV/m

ANTENNA POLARITY : VERTICAL										
Frequency (MHz)	Level (dBuV/m)	Over Limit (dB)	Limit Line (dBuV/m)	Read Level (dBuV)	Antenna Factor (dB)	Cable Loss (dB)	Preamp Factor (dB)	Ant Pos (cm)	Table Pos (deg)	Remark
2483.50	47.80	-26.20	74.00	47.36	32.08	4.05	35.69	100	0	Peak
2483.50	8.03	-45.97	54.00	7.59	32.08	4.05	35.69	100	305	Average

Remark:

<Delta Marker>

Delta marker at 1% RBW of span = 45.49 dB

Peak band edge at 2483.50 MHz (RBW = VBW = 1MHz) = 93.29 dBuV/m – 45.49 dB = 47.80 dBuV/m

Duty factor = 20 log (Package Transfer Times x Avg Hopping Channel) = 20 log (0.00302 x 3.4) = -39.77

Average band edge = Peak band edge + Duty factor = 47.80 dBuV/m + (-39.77) = 8.03 dBuV/m



3.6.6 Test Result of Conducted Band Edges

Test Mode :	Mode 1 and 3	Temperature :	24~25°C
Test Channel :	00	Relative Humidity :	35~37%
Test Engineer :	Ken Hsu		

Low Band Edge Plot on Channel 00

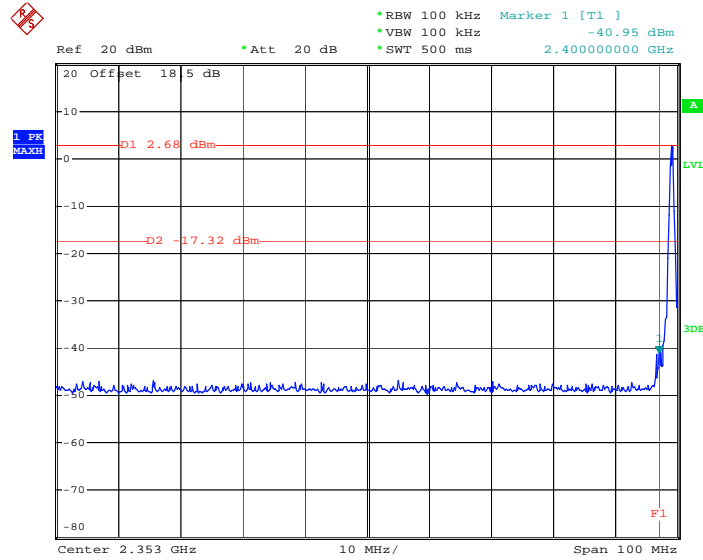

Date: 3.DEC.2008 10:32:49

High Band Edge Plot on Channel 78

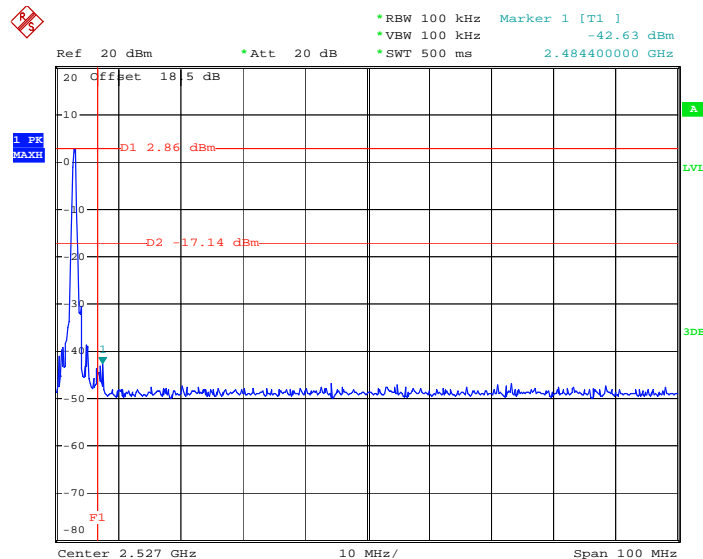

Date: 3.DEC.2008 13:16:29

3.7 AC Conducted Emission Measurement

3.7.1 Limit of AC Conducted Emission

For equipment that is designed to be connected to the public utility (AC) power line, the radio frequency voltage that is conducted back onto the AC power line on any frequency or frequencies within the band 150 kHz to 30 MHz shall not exceed the limits in the following table.

Frequency of emission (MHz)	Conducted limit (dBuV)	
	Quasi-peak	Average
0.15-0.5	66 to 56*	56 to 46*
0.5-5	56	46
5-30	60	50

*Decreases with the logarithm of the frequency.

3.7.2 Measuring Instruments

See list of measuring instruments of this test report.

3.7.3 Test Procedures

1. Please follow the guidelines in ANSI C63.4-2003.
2. The EUT was placed 0.4 meter from the conducting wall of the shielding room was kept at least 80 centimeters from any other grounded conducting surface.
3. Connect EUT to the power mains through a line impedance stabilization network (LISN).
4. All the support units are connecting to the other LISN.
5. The LISN provides 50 ohm coupling impedance for the measuring instrument.
6. The FCC states that a 50 ohm, 50 microhenry LISN should be used.
7. Both sides of AC line were checked for maximum conducted interference.
8. The frequency range from 150 kHz to 30 MHz was searched.
9. Set the test-receiver system to Peak Detect Function and specified bandwidth with Maximum Hold Mode.

3.7.5 Test Result of AC Conducted Emission

Test Mode :	Mode 1	Temperature :	24~25°C
Test Engineer :	Cona Huang	Relative Humidity :	35~37%
		Phase :	Line
Function Type :	BT Link + Adapter		
Remark :	All emissions not reported here are more than 10 dB below the prescribed limit.		

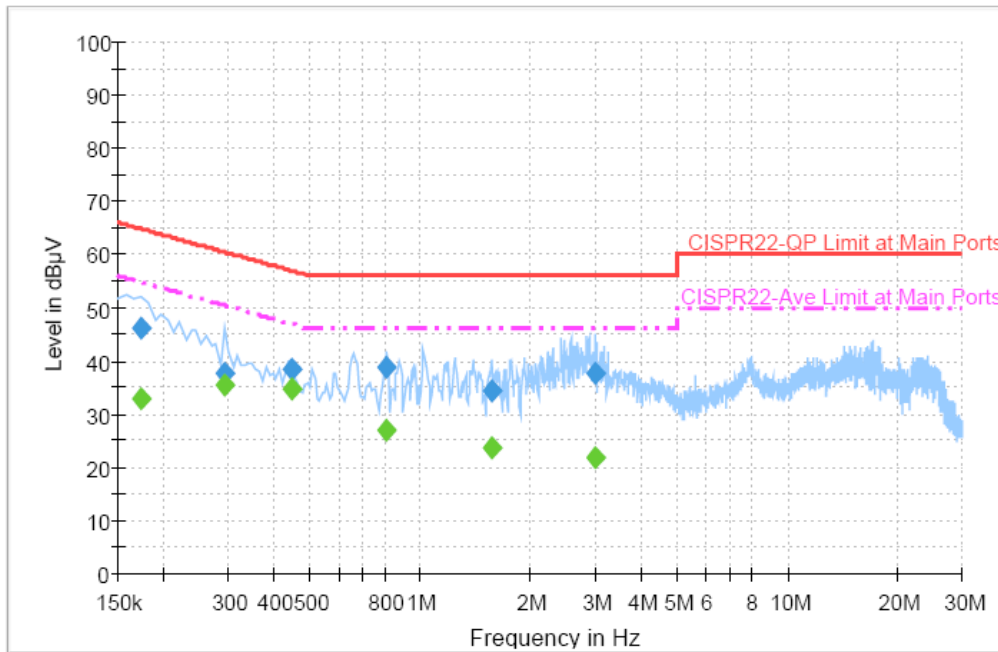

Final Result 1

Frequency (MHz)	QuasiPeak (dBµV)	Filter	Line	Corr. (dB)	Margin (dB)	Limit (dBµV)
0.174000	46.1	Off	L1	19.3	18.7	64.8
0.294000	37.6	Off	L1	19.3	22.8	60.4
0.446000	38.3	Off	L1	19.3	18.6	56.9
0.814000	38.7	Off	L1	19.4	17.3	56.0
1.566000	34.5	Off	L1	19.4	21.5	56.0
2.998000	37.5	Off	L1	19.5	18.5	56.0

Final Result 2

Frequency (MHz)	Average (dBµV)	Filter	Line	Corr. (dB)	Margin (dB)	Limit (dBµV)
0.174000	32.7	Off	L1	19.3	21.1	54.8
0.294000	35.5	Off	L1	19.3	14.9	50.4
0.446000	34.7	Off	L1	19.3	12.2	46.9
0.814000	26.9	Off	L1	19.4	19.1	46.0
1.566000	23.5	Off	L1	19.4	22.5	46.0
2.998000	21.9	Off	L1	19.5	24.1	46.0

Test Mode :	Mode 1	Temperature :	24~25°C
Test Engineer :	Cona Huang	Relative Humidity :	35~37%
		Phase :	Neutral
Function Type :	BT Link + Adapter		
Remark :	All emissions not reported here are more than 10 dB below the prescribed limit.		

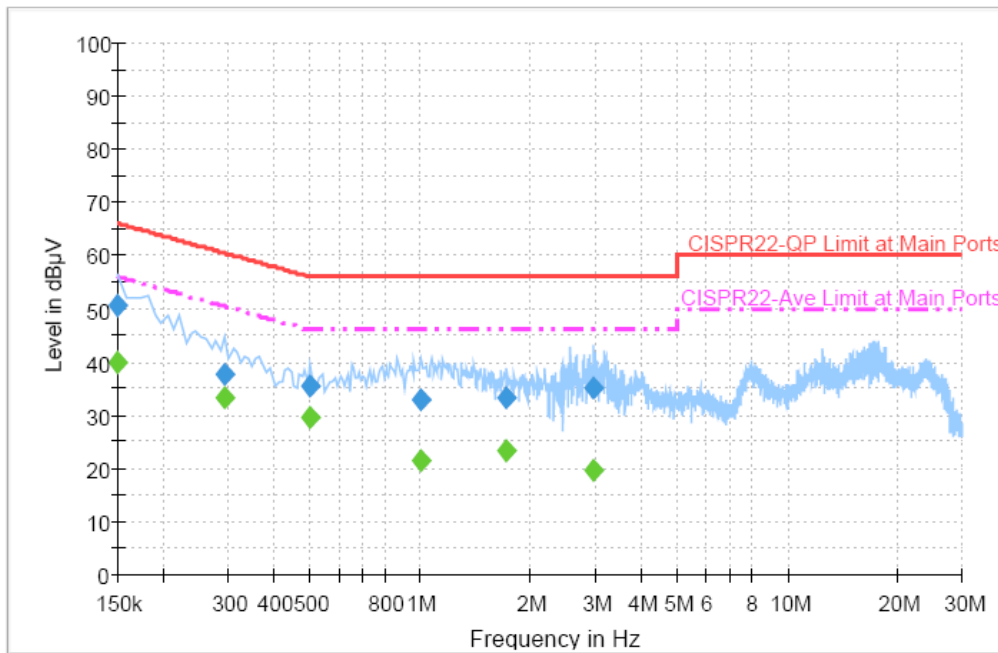

Final Result 1

Frequency (MHz)	QuasiPeak (dBµV)	Filter	Line	Corr. (dB)	Margin (dB)	Limit (dBµV)
0.150000	50.5	Off	N	19.4	15.5	66.0
0.294000	37.7	Off	N	19.3	22.8	60.4
0.502000	35.5	Off	N	19.3	20.5	56.0
1.006000	32.7	Off	N	19.4	23.3	56.0
1.726000	33.3	Off	N	19.5	22.7	56.0
2.982000	35.1	Off	N	19.5	20.9	56.0

Final Result 2

Frequency (MHz)	Average (dBµV)	Filter	Line	Corr. (dB)	Margin (dB)	Limit (dBµV)
0.150000	40.0	Off	N	19.4	16.0	56.0
0.294000	33.2	Off	N	19.3	17.2	50.4
0.502000	29.6	Off	N	19.3	16.4	46.0
1.006000	21.2	Off	N	19.4	24.8	46.0
1.726000	23.3	Off	N	19.5	22.7	46.0
2.982000	19.7	Off	N	19.5	26.3	46.0

3.8 Radiated Emission Measurement

3.8.1 Limit of Radiated Emission

In any 100 kHz bandwidth outside the intentional radiator frequency band, all harmonics/spurious must be at least 20 dB below the highest emission level within the authorized band. In addition, radiated emissions which fall in the restricted bands must also comply with the FCC section 15.209 limits as below.

Frequency (MHz)	Field Strength (microvolts/meter)	Measurement Distance (meters)
0.009 – 0.490	2400/F(kHz)	300
0.490 – 1.705	24000/F(kHz)	30
1.705 – 30.0	30	30
30 – 88	100	3
88 – 216	150	3
216 - 960	200	3
Above 960	500	3

3.8.2 Measuring Instruments

See list of measuring instruments of this test report.

3.8.3 Test Procedures

1. The testing follows the guidelines in FCC Public Notice DA 00-705 Measurement Guidelines.
2. Use the following spectrum analyzer settings:
Span = wide enough to fully capture the emission being measured; RBW = 1 MHz for $f \geq 1$ GHz, 100 kHz for $f < 1$ GHz; VBW \geq RBW; Sweep = auto; Detector function = peak; Trace = max hold.
3. Follow the guidelines in ANSI C63.4-2003 with respect to maximizing the emission by rotating the EUT, measuring the emission for three EUT orthogonal planes, and adjusting the measurement antenna height and polarization. A pre-amp and a high pass filter are used for this test in order to get the good signal level.

3.8.4 Test Setup

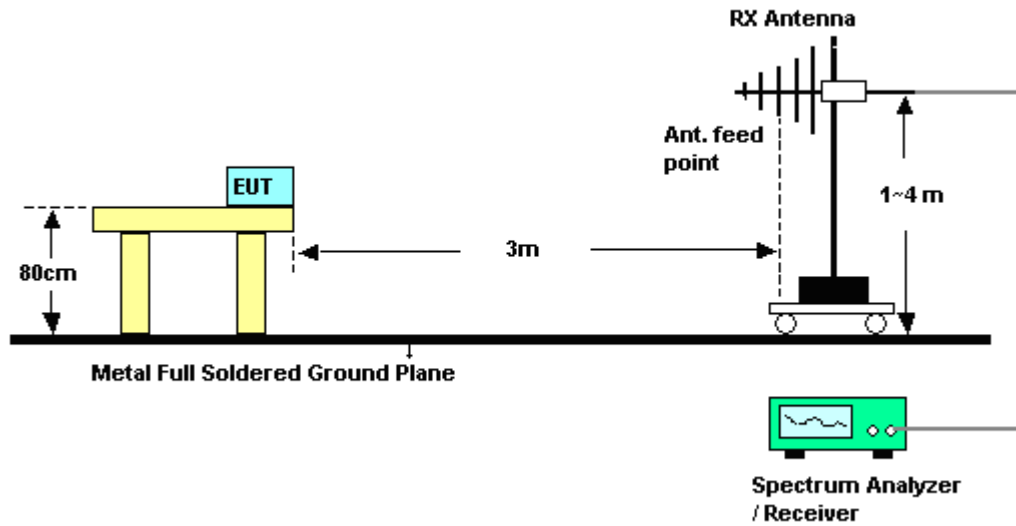



3.8.5 Test Result of Radiated Emission < 1GHz

Test Mode :	Mode 1	Temperature :	20~22°C
Test Channel :	00	Relative Humidity :	48~50%
Test Engineer :	Andrew Hsiao	Polarization :	Horizontal
Remark :	N/A		

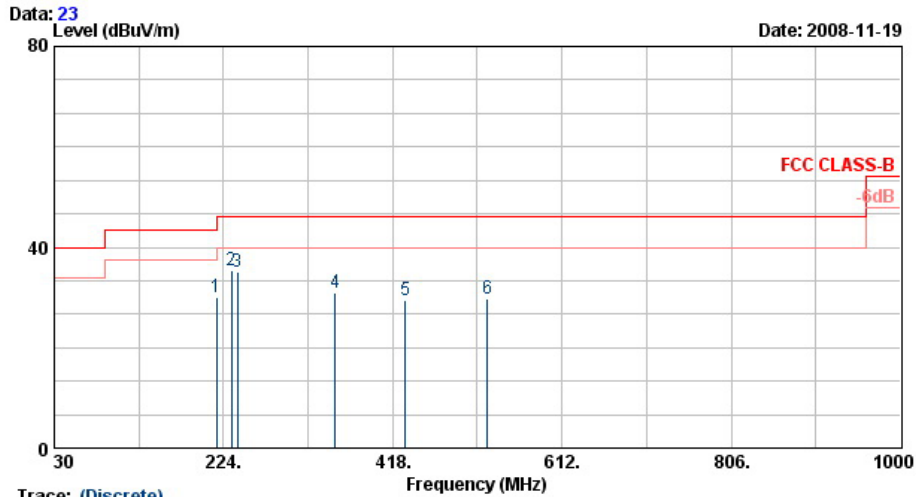

Site : 03CH06-HY
Condition : FCC CLASS-B 3m LF-ANT(051121) HORIZONTAL
Model : FR 8N2103
Mode : Mode 1

	Freq	Level	Over Limit	Limit Line	Read Level	Antenna Factor	Cable Loss	Preamp Factor	Ant Pos	Table Pos	Remark
	MHz	dBuV/m	dB	dBuV/m	dBuV	dB/m	dB	dB	cm	deg	
1	216.03	30.05	-15.95	46.00	51.14	10.27	0.66	32.02	---	---	Peak
2	233.58	35.52	-10.48	46.00	55.47	11.30	0.70	31.95	100	302	Peak
3	239.79	35.10	-10.90	46.00	54.62	11.64	0.70	31.86	---	---	Peak
4	351.80	30.87	-15.13	46.00	47.24	14.55	0.78	31.70	---	---	Peak
5	432.30	29.56	-16.44	46.00	44.41	16.31	0.83	31.99	---	---	Peak
6	526.80	29.63	-16.37	46.00	43.09	17.70	0.93	32.10	---	---	Peak



Test Mode :	Mode 1	Temperature :	20~22°C
Test Channel :	00	Relative Humidity :	48~50%
Test Engineer :	Andrew Hsiao	Polarization :	Vertical
Remark :	N/A		

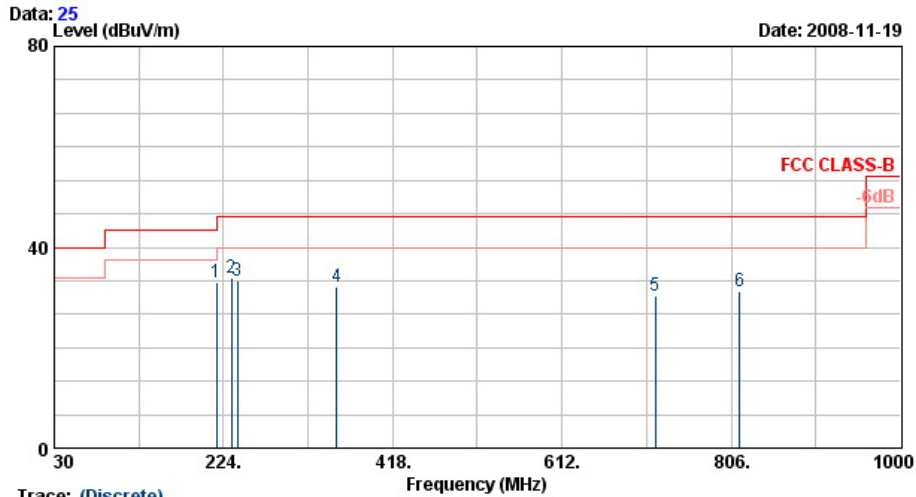

Trace: (Discrete)

Site : 03CH06-HY
 Condition : FCC CLASS-B 3m LF-ANT(051121) VERTICAL
 Model : FR 8N2103
 Mode : Mode 1

	Freq	Level	Over Limit	Limit Line	Read Level	Antenna Factor	Cable Loss	Preamp Factor	Ant Pos	Table Pos	Remark
	MHz	dBuV/m	dB	dBuV/m	dBuV	dB/m	dB	dB	cm	deg	
1	216.03	32.91	-13.09	46.00	54.00	10.27	0.66	32.02	---	---	Peak
2	233.58	33.97	-12.03	46.00	53.92	11.30	0.70	31.95	100	332	Peak
3	239.79	33.42	-12.58	46.00	52.93	11.64	0.70	31.86	---	---	Peak
4	353.90	32.03	-13.97	46.00	48.38	14.60	0.76	31.71	---	---	Peak
5	719.30	30.31	-15.69	46.00	42.35	19.07	1.20	32.32	---	---	Peak
6	815.90	31.37	-14.63	46.00	42.49	19.93	1.20	32.25	---	---	Peak



Test Mode :	Mode 2	Temperature :	20~22°C
Test Channel :	39	Relative Humidity :	48~50%
Test Engineer :	Andrew Hsiao	Polarization :	Horizontal
Remark :	N/A		

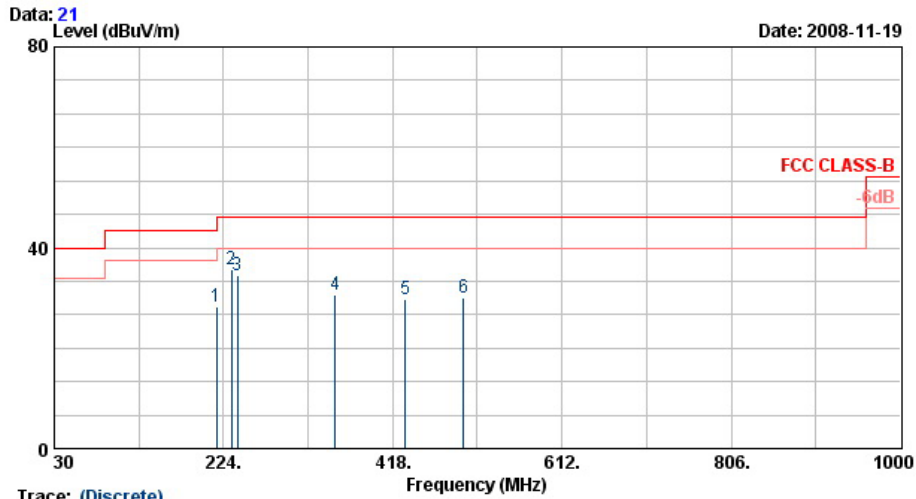

Trace: (Discrete)
Site : 03CH06-HY
Condition : FCC CLASS-B 3m LF-ANT(051121) HORIZONTAL
Model : FR 8N2103
Mode : Mode 2

	Freq	Level	Over Limit	Limit Line	ReadAntenna Level	Antenna Factor	Cable Loss	Preamp Factor	Ant Pos	Table Pos	Remark
	MHz	dBuV/m	dB	dBuV/m	dBuV	dB/m	dB	dB	cm	deg	
1	216.03	28.23	-17.77	46.00	49.32	10.27	0.66	32.02	---	---	Peak
2	233.58	35.75	-10.25	46.00	55.70	11.30	0.70	31.95	100	345	Peak
3	239.79	34.64	-11.36	46.00	54.16	11.64	0.70	31.86	---	---	Peak
4	351.80	30.56	-15.44	46.00	46.93	14.55	0.78	31.70	---	---	Peak
5	432.30	29.82	-16.18	46.00	44.68	16.31	0.83	31.99	---	---	Peak
6	498.80	30.06	-15.94	46.00	43.75	17.40	0.98	32.07	---	---	Peak



Test Mode :	Mode 2	Temperature :	20~22°C
Test Channel :	39	Relative Humidity :	48~50%
Test Engineer :	Andrew Hsiao	Polarization :	Vertical
Remark :	N/A		

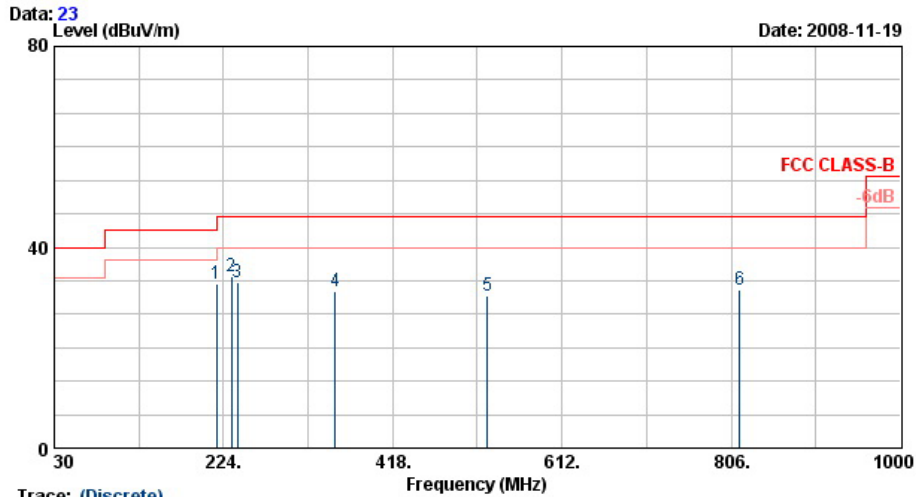

Trace: (Discrete)

Site : 03CH06-HY
Condition : FCC CLASS-B 3m LF-ANT(051121) VERTICAL
Model : FR 8N2103
Mode : Mode 2

	Freq	Level	Over	Limit	Read	Antenna	Cable	Preamp	Ant	Table	Remark
	MHz	dBuV/m	dB	dBuV/m	dBuV	dB/m	dB	dB	cm	deg	
1	216.03	32.74	-13.26	46.00	53.83	10.27	0.66	32.02	---	---	Peak
2	233.04	34.32	-11.68	46.00	54.35	11.24	0.70	31.97	100	226	Peak
3	239.79	33.09	-12.91	46.00	52.60	11.64	0.70	31.86	---	---	Peak
4	351.80	31.13	-14.87	46.00	47.50	14.55	0.78	31.70	---	---	Peak
5	526.80	30.42	-15.58	46.00	43.88	17.70	0.93	32.10	---	---	Peak
6	815.90	31.54	-14.46	46.00	42.66	19.93	1.20	32.25	---	---	Peak



Test Mode :	Mode 3	Temperature :	20~22°C
Test Channel :	78	Relative Humidity :	48~50%
Test Engineer :	Andrew Hsiao	Polarization :	Horizontal
Remark :	N/A		

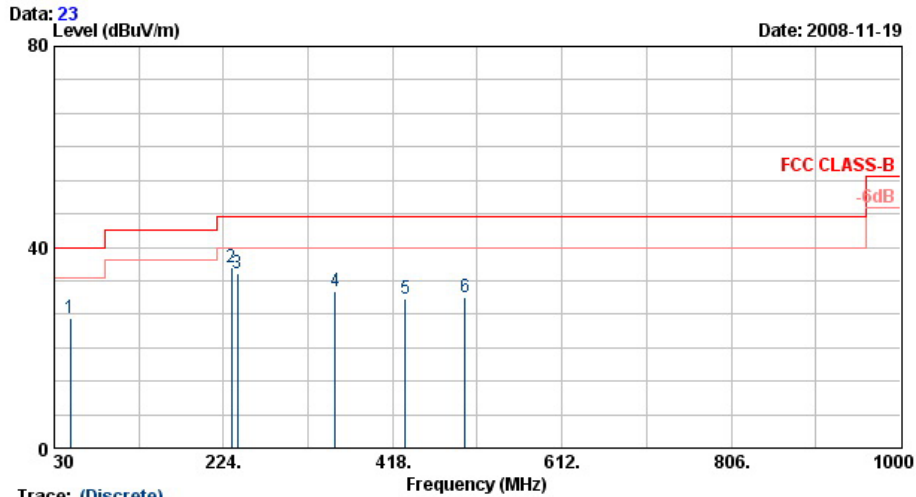

Trace: (Discrete)

Site : 03CH06-HY
Condition : FCC CLASS-B 3m LF-ANT(051121) HORIZONTAL
Model : FR 8N2103
Mode : Mode 3

	Freq	Level	Over Limit	Limit Line	Read Level	Antenna Factor	Cable Loss	Preamp Factor	Ant Pos	Table Pos	Remark
	MHz	dBuV/m	dB	dBuV/m	dBuV	dB/m	dB	dB	cm	deg	
1	48.63	25.86	-14.14	40.00	48.41	9.06	0.30	31.91	---	---	Peak
2	233.58	36.00	-10.00	46.00	55.95	11.30	0.70	31.95	100	332	Peak
3	239.79	34.94	-11.06	46.00	54.46	11.64	0.70	31.86	---	---	Peak
4	351.80	31.20	-14.80	46.00	47.57	14.55	0.78	31.70	---	---	Peak
5	432.30	29.74	-16.26	46.00	44.60	16.31	0.83	31.99	---	---	Peak
6	500.90	29.89	-16.11	46.00	43.53	17.43	1.00	32.07	---	---	Peak



Test Mode :	Mode 3	Temperature :	20~22°C
Test Channel :	78	Relative Humidity :	48~50%
Test Engineer :	Andrew Hsiao	Polarization :	Vertical
Remark :	N/A		

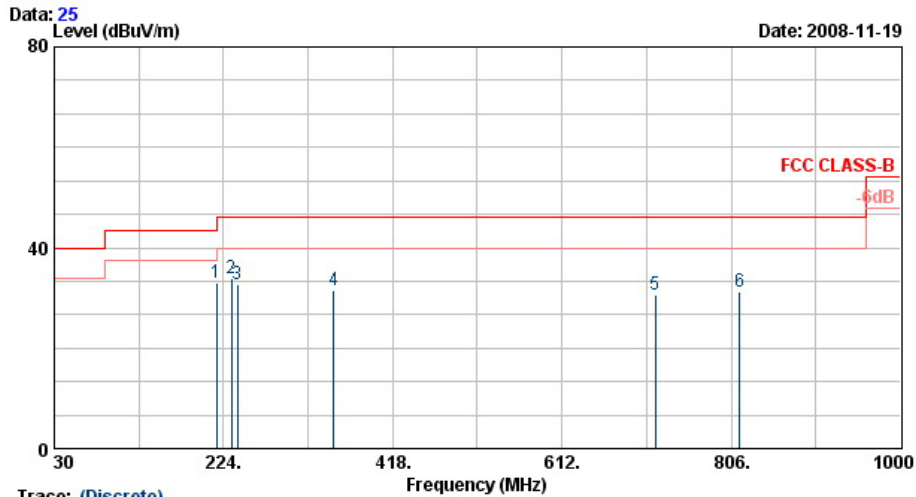

Trace: (Discrete)
 Site : 03CH06-HY
 Condition : FCC CLASS-B 3m LF-ANT(051121) VERTICAL
 Model : FR 8N2103
 Mode : Mode 3

	Freq	Level	Over	Limit	Read	Antenna	Cable	Preamp	Ant	Table	Remark
	MHz	dBuV/m	dB	dBuV/m	dBuV	dB/m	dB	dB	cm	deg	
1	216.03	32.93	-13.07	46.00	54.02	10.27	0.66	32.02	---	---	Peak
2	233.58	33.99	-12.01	46.00	53.94	11.30	0.70	31.95	100	301	Peak
3	239.79	32.84	-13.16	46.00	52.36	11.64	0.70	31.86	---	---	Peak
4	350.40	31.40	-14.60	46.00	47.79	14.50	0.80	31.69	---	---	Peak
5	719.30	30.51	-15.49	46.00	42.56	19.07	1.20	32.32	---	---	Peak
6	815.90	31.16	-14.84	46.00	42.28	19.93	1.20	32.25	---	---	Peak



3.8.6 Test Result of Radiated Emission $\geq 1\text{GHz}$

Test Mode :	Mode 1	Temperature :	20~22°C
Test Channel :	00	Relative Humidity :	48~50%
Test Engineer :	Andrew Hsiao	Polarization :	Horizontal
Remark :	#3 and #4 are Fundamental Signals		

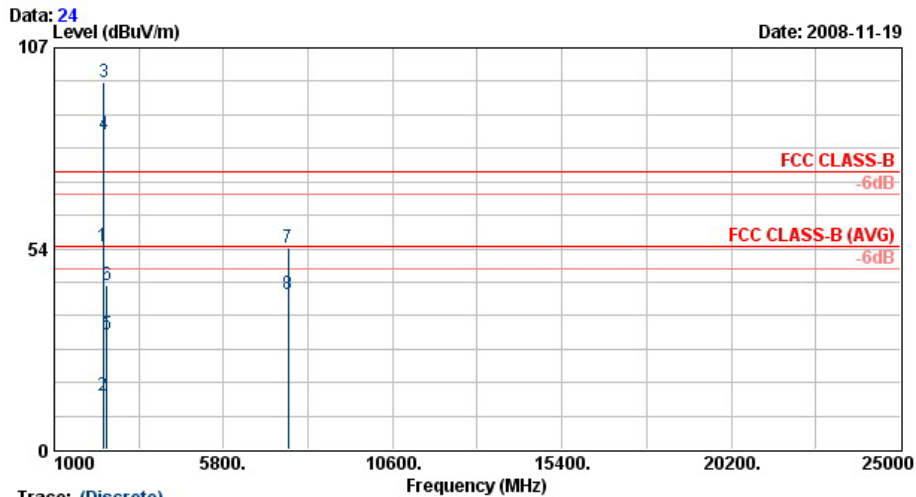

Trace: (Discrete)

Site : 03CH06-HY
 Condition : FCC CLASS-B 3m SHF-EHF HORN HORIZONTAL
 Model : FR 8N2103
 Mode : Mode 1

	Freq	Level	Over	Limit	ReadAntenna	Cable	Preamp	Ant	Table	Remark
	MHz	dBuV/m	dB	dBuV/m	dBuV	dB/m	dB	dB	cm	deg
1	2389.61	54.20	-19.80	74.00	53.98	31.98	3.92	35.68	100	0 Peak
2	2389.61	14.43	-39.57	54.00	14.21	31.98	3.92	35.68	160	4 Average
3 X	2402.00	97.83			97.59	32.00	3.92	35.68	100	0 Peak
4 @	2402.00	83.78			83.56	31.98	3.92	35.68	160	4 Average
5	2500.00	30.78	-23.22	54.00	30.33	32.10	4.05	35.70	160	4 Average
6	2500.00	43.66	-30.34	74.00	43.21	32.10	4.05	35.70	100	0 Peak
7	7626.00	53.88	-20.12	74.00	47.23	35.55	7.33	36.23	100	0 Peak
8	7626.00	41.20	-12.80	54.00	34.54	35.55	7.33	36.23	100	245 Average



Test Mode :	Mode 1	Temperature :	20~22°C
Test Channel :	00	Relative Humidity :	48~50%
Test Engineer :	Andrew Hsiao	Polarization :	Vertical
Remark :	#3 and #4 are Fundamental Signals		

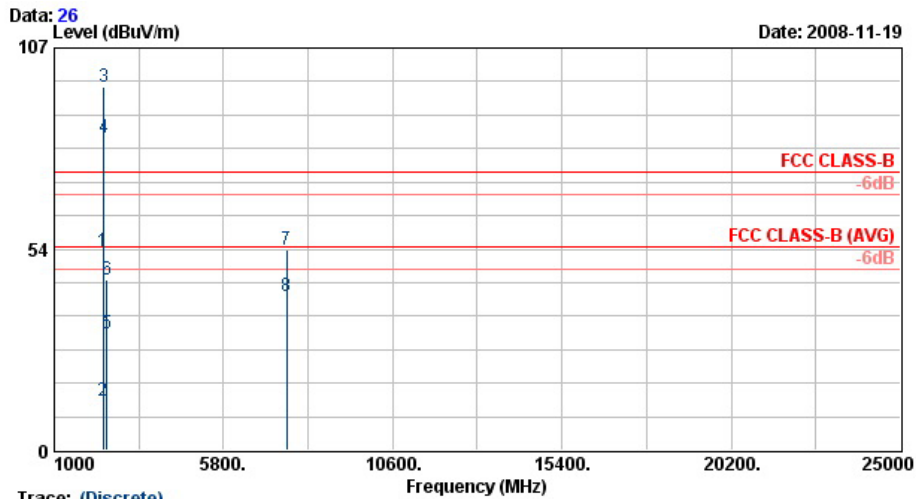

Trace: (Discrete)
Site : 03CH06-HY
Condition : FCC CLASS-B 3m SHF-EHF HORN VERTICAL
Model : FR 8N2103
Mode : Mode 1

	Freq	Level	Over	Limit	Read	Antenna	Cable	Preamp	Ant	Table	Remark
	MHz	dBuV/m	dB	dBuV/m	dBuV	dB/m	dB	dB	cm	deg	
1	2389.61	53.02	-20.98	74.00	52.80	31.98	3.92	35.68	100	0	Peak
2	2389.61	13.25	-40.75	54.00	13.03	31.98	3.92	35.68	100	309	Average
3 X	2402.00	96.65			96.42	32.00	3.92	35.68	100	0	Peak
4 X	2402.00	82.96			82.74	31.98	3.92	35.68	100	309	Average
5	2500.00	31.09	-22.91	54.00	30.64	32.10	4.05	35.70	100	309	Average
6	2500.00	45.35	-28.65	74.00	44.90	32.10	4.05	35.70	100	0	Peak
7	7596.00	53.26	-20.74	74.00	46.62	35.54	7.32	36.22	100	0	Peak
8	7596.00	41.02	-12.98	54.00	34.38	35.54	7.32	36.22	100	332	Average



Test Mode :	Mode 2	Temperature :	20~22°C
Test Channel :	39	Relative Humidity :	48~50%
Test Engineer :	Andrew Hsiao	Polarization :	Horizontal
Remark :	#3 and #4 are Fundamental Signals		

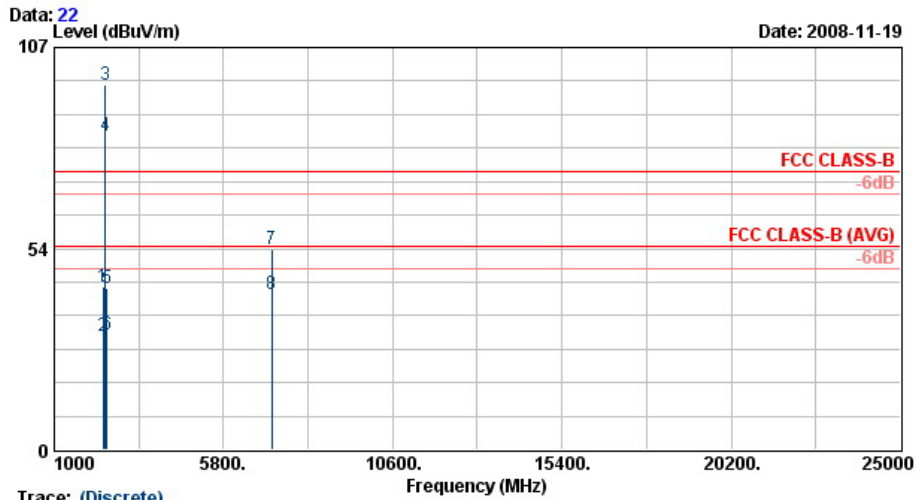

Trace: (Discrete)
Site : 03CH06-HY
Condition : FCC CLASS-B 3m SHF-EHF HORN HORIZONTAL
Model : FR 8N2103
Mode : Mode 2

	Freq	Level	Over	Limit	ReadAntenna	Cable	Preamp	Ant	Table	
	MHz	dBuV/m	dB	dBuV/m	dBuV	dB/m	dB	dB	cm	deg
1	2380.00	43.24	-30.76	74.00	43.04	31.96	3.92	35.68	100	0 Peak
2	2380.00	30.21	-23.79	54.00	30.01	31.96	3.92	35.68	100	22 Average
3 X	2441.00	97.18			96.85	32.04	3.99	35.69	100	0 Peak
4 X	2441.00	83.59			83.26	32.04	3.99	35.69	100	22 Average
5	2500.00	42.80	-31.20	74.00	42.35	32.10	4.05	35.70	100	0 Peak
6	2500.00	30.55	-23.45	54.00	30.10	32.10	4.05	35.70	100	22 Average
7	7161.00	53.39	-20.61	74.00	46.67	35.64	7.15	36.07	100	0 Peak
8	7161.00	41.22	-12.78	54.00	34.50	35.64	7.15	36.07	100	236 Average



Test Mode :	Mode 2	Temperature :	20~22°C
Test Channel :	39	Relative Humidity :	48~50%
Test Engineer :	Andrew Hsiao	Polarization :	Vertical
Remark :	#3 and #4 are Fundamental Signals		

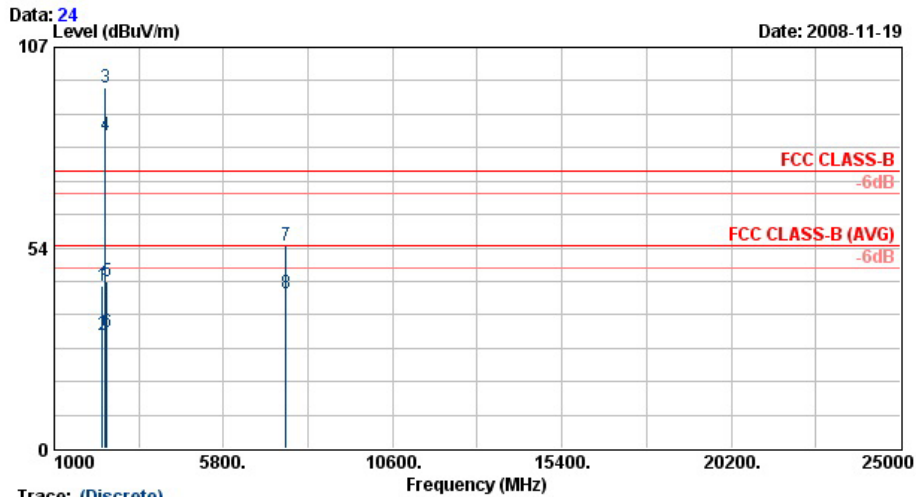

Site : 03CH06-HY
 Condition : FCC CLASS-B 3m SHF-EHF HORN VERTICAL
 Model : FR 8N2103
 Mode : Mode 2

Trace: (Discrete)

	Freq	Level	Over	Limit	Read	Antenna	Cable	Preamp	Ant	Table	Remark
	MHz	dBuV/m	dB	dBuV/m	dBuV	dB/m	dB	dB	cm	deg	
1	2372.00	43.30	-30.70	74.00	43.13	31.96	3.89	35.68	100	0	Peak
2	2372.00	30.18	-23.82	54.00	30.01	31.96	3.89	35.68	100	307	Average
3 X	2441.00	96.10			95.77	32.04	3.99	35.69	100	0	Peak
4 X	2441.00	83.49			83.16	32.04	3.99	35.69	100	307	Average
5	2500.00	44.45	-29.55	74.00	44.00	32.10	4.05	35.70	100	0	Peak
6	2500.00	30.91	-23.09	54.00	30.46	32.10	4.05	35.70	100	307	Average
7	7581.00	53.99	-20.01	74.00	47.36	35.53	7.31	36.22	100	0	Peak
8	7581.00	41.33	-12.67	54.00	34.71	35.53	7.31	36.22	100	302	Average



Test Mode :	Mode 3	Temperature :	20~22°C
Test Channel :	78	Relative Humidity :	48~50%
Test Engineer :	Andrew Hsiao	Polarization :	Horizontal
Remark :	#3 and #4 are Fundamental Signals		

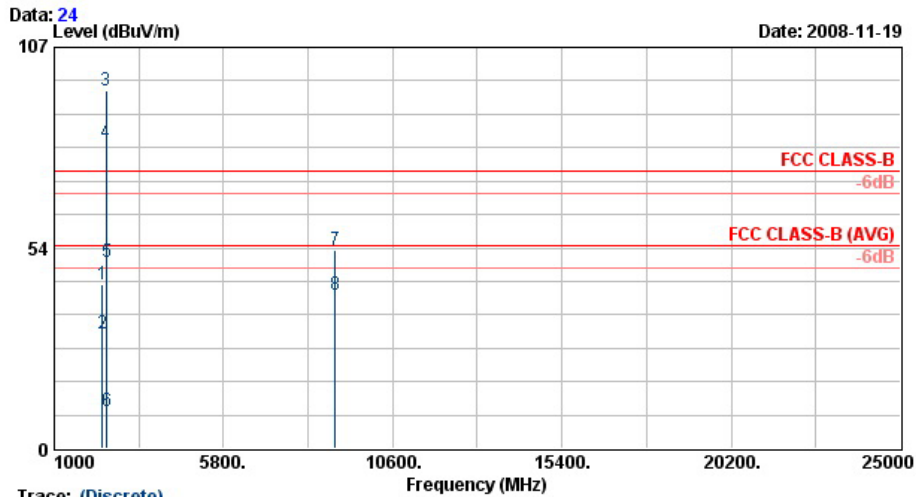

Site : 03CH06-HY
Condition : FCC CLASS-B 3m SHF-EHF HORN HORIZONTAL
Model : FR 8N2103
Mode : Mode 3

	Freq	Level	Over Limit	Limit Line	Read Level	Antenna Factor	Cable Loss	Preamp Factor	Ant Pos	Table Pos	Remark
	MHz	dBuV/m	dB	dBuV/m	dBuV	dB/m	dB	dB	cm	deg	
1	2358.00	43.92	-30.08	74.00	43.77	31.93	3.89	35.67	100	0	Peak
2	2358.00	30.46	-23.54	54.00	30.31	31.93	3.89	35.67	100	17	Average
3 X	2480.00	95.34			94.91	32.08	4.05	35.70	100	0	Peak
4 @	2480.00	81.73			81.30	32.08	4.05	35.70	100	17	Average
5	2483.50	49.85	-24.15	74.00	49.42	32.08	4.05	35.70	100	0	Peak
6	2483.50	10.08	-43.92	54.00	9.65	32.08	4.05	35.70	100	17	Average
7	8967.00	53.02	-20.98	74.00	45.65	36.17	7.77	36.57	100	0	Peak
8	8967.00	41.02	-12.98	54.00	33.65	36.17	7.77	36.57	100	234	Average



Test Mode :	Mode 3	Temperature :	20~22°C
Test Channel :	78	Relative Humidity :	48~50%
Test Engineer :	Andrew Hsiao	Polarization :	Vertical
Remark :	#3 and #4 are Fundamental Signals		

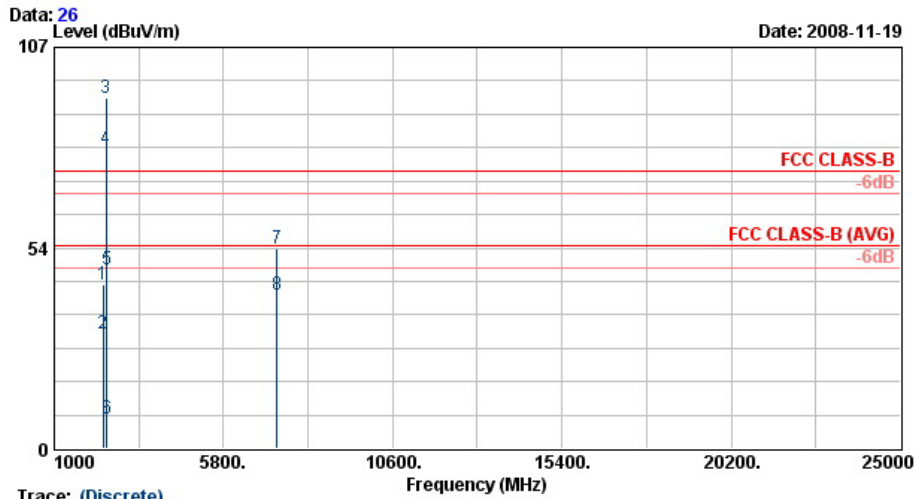

Site : 03CH06-HY
Condition : FCC CLASS-B 3m SHF-EHF HORN VERTICAL
Model : FR 8N2103
Mode : Mode 3

	Freq	Level	Over	Limit	Read	Antenna	Cable	Preamp	Ant	Table	Remark
	MHz	dBuV/m	Limit	Line	Level	Factor	Loss	Factor	Pos	Pos	
			dB	dBuV/m	dBuV	dB/m	dB	dB	cm	deg	
1	2382.00	43.76	-30.24	74.00	43.56	31.96	3.92	35.68	100	0	Peak
2	2382.00	30.48	-23.52	54.00	30.28	31.96	3.92	35.68	100	305	Average
3 X	2480.00	93.29			92.85	32.08	4.05	35.70	100	0	Peak
4 X	2480.00	80.03			79.60	32.08	4.05	35.70	100	305	Average
5	2483.50	47.80	-26.20	74.00	47.37	32.08	4.05	35.70	100	0	Peak
6	2483.50	8.03	-45.97	54.00	7.60	32.08	4.05	35.70	100	305	Average
7	7311.00	53.42	-20.58	74.00	46.76	35.58	7.20	36.12	100	0	Peak
8	7311.00	41.02	-12.98	54.00	34.36	35.58	7.20	36.12	100	332	Average



3.9 Antenna Requirements

3.9.1 Standard Applicable

If directional gain of transmitting antennas is greater than 6dBi, the power shall be reduced by the same level in dB comparing to gain minus 6dBi.

The use of a permanently attached antenna or of an antenna that uses a unique coupling to the intentional radiator shall be considered sufficient to comply with the FCC rule.

3.9.2 Antenna Connected Construction

The antenna type used in this product is PIFA Antenna without connector and it is considered to meet antenna requirement.

3.9.3 Antenna Gain

The antenna peak gain of EUT is less than 6 dBi. Therefore, it is not necessary to reduce maximum peak output power limit.

4 List of Measuring Equipments

Instrument	Manufacturer	Model No.	Serial No.	Characteristics	Calibration Date	Due Date	Remark
Spectrum Analyzer	R&S	FSP40	100055	9KHz~40GHz	Jun. 26, 2008	Jun. 25, 2009	Conducted (TH02-HY)
Power Meter	Agilent	E4416A	GB41292344	N/A	Feb. 21, 2008	Feb. 20, 2009	Conducted (TH02-HY)
Power Sensor	Agilent	E9327A	US40441548	N/A	Feb. 21, 2008	Feb. 20, 2009	Conducted (TH02-HY)
EMI Receiver	R&S	ESCS 30	100356	9kH~2.75GHz	Aug. 01, 2008	Jul. 31, 2009	Conduction (CO05-HY)
Two-LISN	R&S	ENV216	11-100081	9kH~30MHz	Nov. 26, 2008	Nov. 25, 2009	Conduction (CO05-HY)
Two-LISN	R&S	ENV216	11-100080	9kHz~30MHz	Nov. 26, 2008	Nov. 25, 2009	Conduction (CO05-HY)
AC Power Source	APC	APC-1000W	N/A	N/A	N/A	N/A	Conduction (CO05-HY)
Spectrum Analyzer	Agilent	E4408B	MY44211030	9kHz~26.5GHz	Oct. 24, 2008	Oct. 23, 2009	Radiation (03CH06-HY)
Spectrum Analyzer	R&S	FSP40	100057	9kHz~40GHz	Oct. 16, 2008	Oct. 15, 2009	Radiation (03CH06-HY)
EMI Test Receiver	R&S	ESVS10	834468/003	20MHz~1000M Hz	Apr. 24, 2008	Apr. 23, 2009	Radiation (03CH06-HY)
Bilog Antenna	SCHAFFNER	CBL6112B	2885	30MHz~2GHz	Nov. 12, 2008	Nov. 11, 2009	Radiation (03CH06-HY)
Double Ridge Horn Antenna	EMCO	3117	00066583	1G~18GHz	Aug. 18, 2008	Aug. 17, 2009	Radiation (03CH06-HY)
Double Ridge Horn Antenna	Training Research	AF-0801	95119	8G~18G	Oct. 28, 2008	Oct. 27, 2009	Radiation (03CH06-HY)
SHF-EHF Horn	SCHWARZBECK	BBHA 9170	9170-251	14G~40GHz	Oct. 16, 2008	Oct. 15, 2009	Radiation (03CH06-HY)
Pre Amplifier	Agilent	8449B	3008A01917	1G~26.5GHz	Nov. 11, 2008	Nov. 10, 2009	Radiation (03CH06-HY)
Pre Amplifier	Agilent	310N	186713	9kHz~1GHz	Apr. 21, 2008	Apr. 20, 2009	Radiation (03CH06-HY)

5 Uncertainty of Evaluation

Uncertainty of Conducted Emission Measurement (150kHz ~ 30MHz)

Contribution	Uncertainty of x_i		$u(x_i)$
	dB	Probability Distribution	
Receiver reading	0.10	Normal(k=2)	0.05
Cable loss	0.10	Normal(k=2)	0.05
AMN insertion loss	2.50	Rectangular	0.63
Receiver Spec	1.50	Rectangular	0.43
Site imperfection	1.39	Rectangular	0.80
Mismatch	+0.34/-0.35	U-shape	0.24
Combined standard uncertainty Uc(y)	1.13		
Measuring uncertainty for a level of confidence of 95% U=2Uc(y)	2.26		

Uncertainty of Radiated Emission Measurement (30MHz ~ 1000MHz)

Contribution	Uncertainty of x_i		$u(x_i)$
	dB	Probability Distribution	
Receiver reading	0.41	Normal(k=2)	0.21
Antenna factor calibration	0.83	Normal(k=2)	0.42
Cable loss calibration	0.25	Normal(k=2)	0.13
Pre Amplifier Gain calibration	0.27	Normal(k=2)	0.14
RCV/SPA specification	2.50	Rectangular	0.72
Antenna Factor Interpolation for Frequency	1.00	Rectangular	0.29
Site imperfection	1.43	Rectangular	0.83
Mismatch	+0.39/-0.41	U-shaped	0.28
Combined standard uncertainty Uc(y)	1.27		
Measuring uncertainty for a level of confidence of 95% U=2Uc(y)	2.54		

Uncertainty of Radiated Emission Measurement (1GHz ~ 40GHz)

Contribution	Uncertainty of x_i		$u(x_i)$	C_i	$C_i * u(x_i)$
	dB	Probability Distribution			
Receiver reading	±0.10	Normal(k=1)	0.10	1	0.10
Antenna factor calibration	±1.70	Normal(k=2)	0.85	1	0.85
Cable loss calibration	±0.50	Normal(k=2)	0.25	1	0.25
Receiver Correction	±2.00	Rectangular	1.15	1	1.15
Antenna Factor Directional	±1.50	Rectangular	0.87	1	0.87
Site imperfection	±2.80	Triangular	1.14	1	1.14
Mismatch Receiver VSWR $\Gamma_1 = 0.197$ Antenna VSWR $\Gamma_2 = 0.194$ Uncertainty = $20 \log(1 - \Gamma_1 * \Gamma_2)$	+0.34/-0.35	U-shaped	0.244	1	0.244
Combined standard uncertainty $U_c(y)$	2.36				
Measuring uncertainty for a level of confidence of 95% $U = 2U_c(y)$	4.72				

6 Certification of TAF Accreditation



Certificate No. : L1190-070110

財團法人全國認證基金會
Taiwan Accreditation Foundation

Certificate of Accreditation

This is to certify that

Sporton International Inc.
EMC & Wireless Communications Laboratory
No.52, Hwa Ya 1st Rd., Hwa Ya Technology Park, Kwei-Shan Hsiang, Tao Yuan Hsien,
Taiwan, R.O.C.

is accredited in respect of laboratory

Accreditation Criteria	: ISO/IEC 17025:2005
Accreditation Number	: 1190
Originally Accredited	: December 15, 2003
Effective Period	: January 10, 2007 to January 09, 2010
Accredited Scope	: Testing Field, see described in the Appendix Accreditation Program for Designated Testing Laboratory
Specific Accreditation Program	: for Commodities Inspection Accreditation Program for Telecommunication Equipment Testing Laboratory

Jay-San Chen
President, Taiwan Accreditation Foundation
Date : January 10, 2007

PI, total 9 pages

The Appendix forms an integral part of this Certificate, which shall be invalid when used without the Appendix.



Appendix A. Photographs of EUT

Please refer to Sporton report number EP8N2103 as below.