



FCC Test Report

According to

47 CFR Part 22H, 24E

Equipment : Notebook Personal Computer
Trade Name : MITAC / GETAC
Model No. : A790
FCC ID : MAU033
Tx Frequency Range : GSM850 : 824.2 ~ 848.8MHz
PCS1900 : 1850.2 ~1909.8 MHz
WCDMA Band V : 826.4 ~ 846.6 MHz
WCDMA Band II : 1852.4 ~1907.6 MHz
Max. ERP/EIRP Power : GSM850(GSM) : 0.18 W
GSM850(EDGE) : 0.06 W
PCS1900(GSM) : 0.11 W
PCS1900(EDGE) : 0.06 W
WCDMA Band V : 0.03 W
WCDMA Band V(HSDPA) : 0.03 W
WCDMA Band II : 0.04 W
WCDMA Band II(HSDPA) : 0.03 W
Emission Designator : GSM : 300KGXW
EDGE : 300KG7W
WCDMA : 4M22F9W
Applicant : MITAC Technology Corporation
No. 1, R&D Road 2, Hsinchu Science-Based
industrial Park, Hsinchu 300. Taiwan, R.O.C.

- The test result refers exclusively to the test presented test model / sample.
- Without written approval of SPORTON International Inc., the test report shall not be reproduced except in full.
- **Certificate or Test Report must not be used by the applicant to claim the product in this test report endorsement by NVLAP or any agency of U.S. government.**
- The data shown in this test report were carried out on Mar. 02, 2008 at **Sporton International Inc. LAB.**
- Report No.: FG821323, Report Version: Rev. 03.

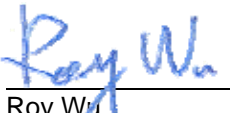
Roy Wu
Manager

SPORTON International Inc.

No. 52, Hwa Ya 1st Rd., Hwa Ya Technology Park, Kwei-Shan Hsiang, Tao Yuan Hsien, Taiwan, R.O.C.

SPORTON International Inc.

TEL : 886-2-2696-2468

FAX : 886-2-2696-2255

Report Version: Rev. 03



Table of Contents

History of This Test Report ii

1. General Information 1

1.1 Applicant..... 1

1.2 Manufacturer 1

1.3 Basic Description of Equipment under Test..... 1

1.4 Feature of Equipment under Test..... 2

1.5 Report Date 5

2. Test Configuration of Equipment under Test 6

2.1 Test Manner 6

2.2 Test Mode 6

2.3 Connection Diagram of Test System 6

2.4 Ancillary Equipment List 6

3. General Information of Test Site..... 7

3.1 Test Voltage 7

3.2 Test Compliance..... 7

3.3 Frequency Range 7

3.4 Test Distance..... 7

4. Test Data and Test Result 8

4.1 List of Measurements and Examinations 8

4.2 RF Output Power 9

4.3 ERP / EIRP Measurement 12

4.4 Occupied Bandwidth and Band Edge Measurement 18

4.5 Conducted Emission..... 83

4.6 Field Strength of Spurious Radiation 120

4.7 Frequency Stability (Temperature Variation) 141

4.8 Frequency Stability (Voltage Variation) 145

5. List of Measurement Equipments 147

6. Uncertainty Evaluation 148

Appendix A - External Photographs of EUT

Appendix B - Internal Photographs of EUT

Appendix C - Setup Photographs



1. General Information

1.1 Applicant

MITAC Technology Corporation

No. 1, R&D Road 2, Hsinchu Science-Based industrial Park, Hsinchu 300. Taiwan, R.O.C.

1.2 Manufacturer

1. MITAC Technology Corporation

No. 1, R&D Road 2, Hsinchu Science-Based industrial Park, Hsinchu 300. Taiwan, R.O.C.

2. Getac Technology (Kunshan) Co., Ltd.

No. 269, 2nd Road, Export Processing Zone, Changjiang South, Road, Kunshan, Jiangsu, P.R.C Zip code: 215300

1.3 Basic Description of Equipment under Test

Equipment		Notebook Personal Computer
Trade Name		MITAC / GETAC
Model Name		A790
FCC ID		MAU033
AC Adapter	Brand Name	EPS
	Model Name	F10903-A
	Power Rating	I/P:100-240Vac, 50-60Hz, 1.2A; O/P: 19Vdc, 4.75A
	AC Power Cord Type	1.2 meter shielded cable without ferrite core
Battery	Brand Name	MITAC
	Model Name	BP-LC2400/34-01SI
	Power Rating	11.1Vdc, 9600mAh
	Type	Li-ion

Remark: Above EUT's information was declared by manufacturer. Please refer to the specifications of manufacturer or User's Manual for more detailed features description.



1.4 Feature of Equipment under Test

Product Feature & Specification	
DUT Type	Notebook Personal Computer
Trade Name	MITAC / GETAC
Model Name	A790
FCC ID	MAU033
Tx Frequency	GSM850 : 824 MHz ~ 849 MHz PCS1900 : 1850 MHz ~ 1910 MHz WCDMA Band V : 824 MHz ~ 849 MHz WCDMA Band II : 1850 MHz ~ 1910 MHz
Rx Frequency	GSM850 : 869 MHz ~ 894 MHz PCS1900 : 1930 MHz ~ 1990 MHz WCDMA Band V : 869 MHz ~ 894 MHz WCDMA Band II : 1930 MHz ~ 1990 MHz
Maximum Output Power to Antenna	GSM850 : 31.79 dBm (GSM) / 25.80 dBm (GPRS12) / 27.01 dBm (EDGE12) PCS1900 : 28.81 dBm (GSM) / 28.50 dBm (GPRS12) / 26.15 dBm (EDGE12) WCDMA Band V : 22.51 dBm(12.2kbps) / 22.50 dBm(64kbps) / 22.49 dBm(144kbps) / 22.48 dBm(384kbps) / 22.42 dBm (12.2kbps+HSDPA) WCDMA Band II : 22.78 dBm(12.2kbps) / 22.84 dBm(64kbps) / 22.80 dBm(144kbps) / 22.83 dBm(384kbps) / 22.76 dBm (12.2kbps+HSDPA)
Maximum ERP/EIRP	GSM850(GSM) : 0.18 W (22.58 dBm) GSM850(EDGE) : 0.06 W (17.84 dBm) PCS1900(GSM) : 0.11 W (20.55 dBm) PCS1900(EDGE) : 0.06 W (17.78 dBm) WCDMA Band V : 0.03 W (15.17 dBm) WCDMA Band V(HSDPA) : 0.03 W (14.49 dBm) WCDMA Band II : 0.04 W (16.15 dBm) WCDMA Band II(HSDPA) : 0.03 W (14.74 dBm)
HW Version	2.1.4.0
SW Version	R2.0.1.1 Build1444
GPRS / EGPRS Multislot class	12
Type of Modulation	GSM / GPRS : GMSK EDGE : 8PSK WCDMA / HSDPA : QPSK
Type of Emission	GSM : 300KGXW EDGE : 300KG7W WCDMA : 4M22F9W
DUT Stage	Production Unit



Notebook System Specification				
		Manufacturer	Model Name	Description
a.	CPU	Intel	YONAH	167GHZ
b.	Power Adapter Type	EPS	F10903-A	INPUT: 100-240Vac, 1.2A, 50/60Hz OUTPUT: 19Vdc, 4.75A
c.	Hard Disk Driver	Toshiba	MK6025GAX	60GB
		Toshiba	MK8032GAX	80GB
		Toshiba	MK8032GSX	80GB
		Toshiba	MK1234GSX	120GB
		Toshiba	MK1234GAX	120G
d.	DVD Dual	Panasonic	UJ-840	N/A
		Panasonic	UJ-850	N/A
		MATSHITA	UJDA770	N/A
e.	Modem Card	Conexant	RD-02-D330	N/A
f.	3G WCDMA card	Sierra Wireless	MC8755V	N/A
g.	GPS Module	Globalsat	ET-301	N/A
h.	USB Connector			two 4 pin
i.	RJ11 Connector			one 2 pin
j.	Serial Port			Two 9 pin
k.	RJ45 Connector			one 8 pin
l.	Parallel Port			one 25 pin
m.	VGA Port			one
n.	Line out Port			one
o.	Line-in Port			one
p.	PCMCIA Slot			two
q.	DC IN Port			one



r.	1394B Port			one
s.	Battery	MITAC	BP-LC2400/34-01SI	11.1Vdc, 9600mAh
		MITAC	BP-LC2600/34-01SI	11.1Vdc, 10400mAh
f.	LCD	Toshiba	LTD141ECGA	N/A
u.	DDR	Maplin	PC2-2700S-2533-1-Z	512M*2
		Infineon	PC2-4200S-444-11-A0	512M*2
		Infineon	HYS64T64020HDL-3.7-A	512M*2
		Qimonda	HYS64T128921 HDL-3.7-B	1G*2
		HYNIX	HYMP564S64CP6-Y5	512M*2
		Qimonda	HYS64T64020EDL-3S-B2	512*2
		Qimonda	HYS64T128021EDL-3S-B2	1G*2
		HYNIX	HYMP512S64CP8-Y5	1G*2
v.	Power Cord			Non-shielded, Detachable
w.	WWAN Right antenna	JEM	P/N: 1A-060168	-1.38dBi(850MHz), -1.26dBi(900MHz), 0.72dBi(1800MHz), 0.15dBi(1900MHz), 0.59dBi(2100MHz), PIFA Antenna
x.	WWAN Left antenna	JEM	P/N: 1A-060242	-1.56dBi(850MHz),-1.44dBi(900MHz), -0.68dBi(1800MHz),1.62dBi(1900MHz), 1.92dBi(2100MHz), PIFA Antenna



1.5 Report Date

EUT Received : Feb. 13, 2008

Report Date : Apr. 14, 2008

2. Test Configuration of Equipment under Test

2.1 Test Manner

1. The spurious emission measurements were carried out in semi-anechoic chamber with 3-meter test range.
2. During all testings, EUT is in link mode with base station emulator at maximum power level.
3. Frequency range investigated: radiated emission 1000 MHz to 9000 MHz for GSM850 and WCDMA Band V; 1000MHz to 19000 MHz for PCS1900 and WCDMA Band II.

2.2 Test Mode

Application	GSM850	PCS1900	WCDMA Band V	WCDMA Band II
Radiated Emission	<input checked="" type="checkbox"/> Mode 1: GSM Link	<input checked="" type="checkbox"/> Mode 3: GSM Link	<input checked="" type="checkbox"/> Mode 5: WCDMA Link	<input checked="" type="checkbox"/> Mode 7: WCDMA Link
	<input checked="" type="checkbox"/> Mode 2: EDGE Link	<input checked="" type="checkbox"/> Mode 4: EDGE Link	<input checked="" type="checkbox"/> Mode 6: HSDPA Link	<input checked="" type="checkbox"/> Mode 8: HSDPA Link
Conducted Measurement	<input checked="" type="checkbox"/> Mode 1: GSM Link	<input checked="" type="checkbox"/> Mode 3: GSM Link	<input checked="" type="checkbox"/> Mode 5: WCDMA Link	<input checked="" type="checkbox"/> Mode 7: WCDMA Link
	<input checked="" type="checkbox"/> Mode 2: EDGE Link	<input checked="" type="checkbox"/> Mode 4: EDGE Link	<input checked="" type="checkbox"/> Mode 6: HSDPA Link	<input checked="" type="checkbox"/> Mode 8: HSDPA Link

2.3 Connection Diagram of Test System

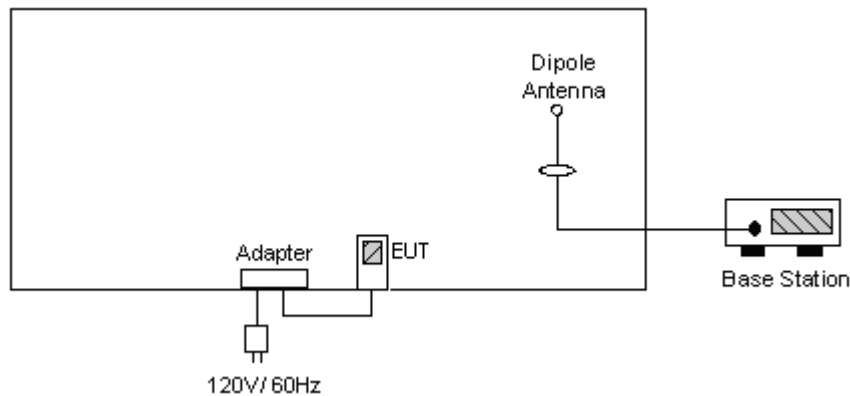

2.4 Ancillary Equipment List

Item	Equipment	Trade Name	Model No.	FCC ID	Data Cable / Power Code
1.	Base Station	R&S	CMU200	N/A	Unshielded, 1.8m



3. General Information of Test Site

Test Site Location : No. 52, Hwa Ya 1st Rd., Hwa Ya Technology Park,
Kwei-Shan Hsiang, Tao Yuan Hsien, Taiwan, R.O.C.
TEL : 886-3-327-3456
FAX : 886-3-328-4978
Test Site No : 03CH06-HY, TH02-HY

The chamber meets the characteristics of ANSI C63.4-2003. This site is on file with the FCC.

3.1 Test Voltage

AC 120V / 60Hz

3.2 Test Compliance

47 CFR Part 22H, 24E, Part 2

Preliminary Guidance for Receiving Applications for Certification of 3G Device. May 9, 2006.

3.3 Frequency Range

- a. Radiation: from 1000MHz to 9000MHz for GSM850 and WCDMA Band V.
- b. Radiation: from 1000 MHz to 19000 MHz for PCS1900 and WCDMA Band II.

3.4 Test Distance

The test distance of radiated emission from antenna to EUT is 3 m.



4. Test Data and Test Result

4.1 List of Measurements and Examinations

FCC Rule	Description of Test	Result	Section
§2.1046	RF Output Power	Passed	4.2
§ 22.913 §24.232	ERP / EIRP	Passed	4.3
§2.1049, § 22.917, § 24.238(b)	Occupied Bandwidth & Band Edge Measurement	Passed	4.4
§2.1051	Conducted Emission	Passed	4.5
§2.1053	Field Strength of Spurious Radiation	Passed	4.6
§2.1055, § 22.355, §24.235	Frequency Stability vs. Temperature	Passed	4.7
§2.1055, §22.355, §24.235	Frequency Stability vs. Voltage	Passed	4.8

4.2 RF Output Power

4.2.1 Measurement Instruments

As described in chapter 5 of this test report.

4.2.2 Test Procedure

- a. The transmitter output was connected to power meter and base station through power divider.
- b. Set EUT at maximum power through base station.
- c. Select lowest, middle, and highest channels for each band.

4.2.3 Test Setup Layout

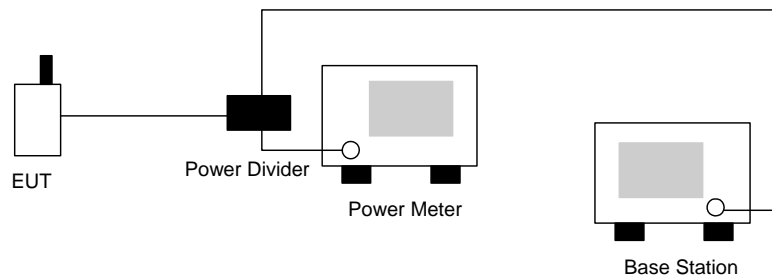



4.2.4 Test Result

Bands	Channel	Frequency (MHz)	Conducted Power (dBm)	Conducted Power (Watts)
GSM850 (GSM)	128	824.2 (Low)	31.73	1.49
	189	836.4 (Mid)	31.79	1.51
	251	848.8 (High)	31.74	1.49
GSM850 (EDGE)	128	824.2 (Low)	26.99	0.50
	189	836.4 (Mid)	27.01	0.50
	251	848.8 (High)	27.01	0.50
PCS1900 (GSM)	512	1850.2 (Low)	28.81	0.76
	661	1880.0 (Mid)	28.65	0.73
	810	1909.8 (High)	28.63	0.73
PCS1900 (EDGE)	512	1850.2 (Low)	26.15	0.41
	661	1880.0 (Mid)	25.89	0.39
	810	1909.8 (High)	25.90	0.39
WCDMA Band V (12.2k bps)	4132	826.4 (Low)	22.51	0.18
	4182	836.4 (Mid)	22.43	0.17
	4233	846.6 (High)	22.30	0.17
WCDMA Band V (64k bps)	4132	826.4 (Low)	22.50	0.18
	4182	836.4 (Mid)	22.43	0.17
	4233	846.6 (High)	22.36	0.17
WCDMA Band V (144k bps)	4132	826.4 (Low)	22.49	0.18
	4182	836.4 (Mid)	22.42	0.17
	4233	846.6 (High)	22.33	0.17
WCDMA Band V (384k bps)	4132	826.4 (Low)	22.48	0.18
	4182	836.4 (Mid)	22.41	0.17
	4233	846.6 (High)	22.36	0.17
WCDMA Band V (AMR)	4132	826.4 (Low)	22.54	0.18
	4182	836.4 (Mid)	22.44	0.18
	4233	846.6 (High)	22.39	0.17
WCDMA Band V (HSDPA)	4132	826.4 (Low)	22.38	0.17
	4182	836.4 (Mid)	22.42	0.17
	4233	846.6 (High)	22.27	0.17



Bands	Channel	Frequency (MHz)	Conducted Power (dBm)	Conducted Power (Watts)
WCDMA Band II (12.2k bps)	9262	1852.4 (Low)	22.78	0.19
	9400	1880.0 (Mid)	22.64	0.18
	9538	1907.6 (High)	22.30	0.17
WCDMA Band II (64k bps)	9262	1852.4 (Low)	22.84	0.19
	9400	1880.0 (Mid)	22.58	0.18
	9538	1907.6 (High)	22.31	0.17
WCDMA Band II (144k bps)	9262	1852.4 (Low)	22.80	0.19
	9400	1880.0 (Mid)	22.59	0.18
	9538	1907.6 (High)	22.19	0.17
WCDMA Band II (384k bps)	9262	1852.4 (Low)	22.83	0.19
	9400	1880.0 (Mid)	22.56	0.18
	9538	1907.6 (High)	22.18	0.17
WCDMA Band II (AMR)	9262	1852.4 (Low)	22.83	0.19
	9400	1880.0 (Mid)	22.59	0.18
	9538	1907.6 (High)	22.15	0.16
WCDMA Band II (HSDPA)	9262	1852.4 (Low)	22.76	0.19
	9400	1880.0 (Mid)	22.61	0.18
	9538	1907.6 (High)	22.33	0.17



4.3 ERP / EIRP Measurement

Equivalent isotropic radiated power measurements by substitution method according to ANSI/TIA/EIA-603-C.

4.3.1 Measurement Instruments

As described in chapter 5 of this test report.

4.3.2 Test Procedure

- a. The EUT was placed on a tutable with 1.0 meter height in an fully anechoic chamber.
- b. The EUT was set 1.2 meters from the receiving antenna which was mounted on the antenna tower.
- c. The table was rotated 360 degrees to determine the position of the highest radiated power.
- d. The height of the receiving antenna is also kept at 1.0M height.
- e. Taking the record of maximum ERP/EIRP.
- f. A dipole antenna was substituted in place of the EUT and was driven by a signal generator.
- g. The conducted power at the terminal of the dipole antenna is measured.
- h. Repeat step 3 to step 5 to get the maximum ERP/EIRP of the substitution antenna.
- i. $ERP/EIRP = P_s + E_t - E_s + G_s = P_s + R_t - R_s + G_s$

P_s (dBm) : Input power to substitution antenna.

G_s (dBi or dBd) : Substitution antenna Gain.

$E_t = R_t + AF$

$E_s = R_s + AF$

AF (dB/m) : Receive antenna factor

R_t : The highest received signal in Spectrum Analyzer for EUT.

R_s : The highest received signal in spectrum analyzer for substitution antenna.

4.3.3 Test Setup Layout of ERP/EIRP

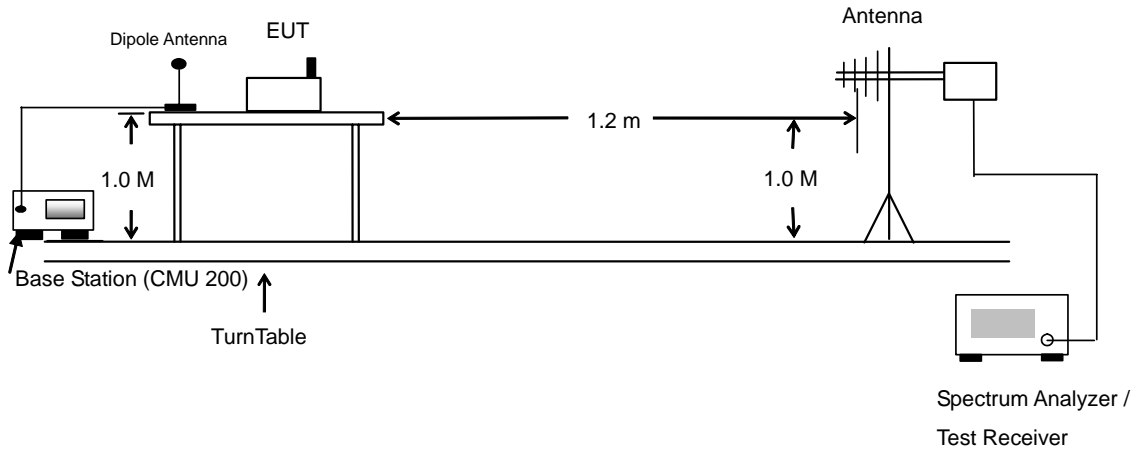



4.3.4 Test Result

GSM850 (GSM) Radiated Power ERP						
Horizontal Polarization						
Frequency (MHz)	Rt (dBm)	Rs (dBm)	Ps (dBm)	Gs (dBd)	ERP (dBm)	ERP (W)
824.20	-28.10	-48.12	0.00	-1.08	18.94	0.08
836.40	-27.84	-48.28	0.00	-0.93	19.51	0.09
848.80	-27.80	-48.35	0.00	-0.76	19.79	0.10
Vertical Polarization						
Frequency (MHz)	Rt (dBm)	Rs (dBm)	Ps (dBm)	Gs (dBd)	ERP (dBm)	ERP (W)
824.20	-24.74	-47.97	0.00	-1.08	22.15	0.16
836.40	-25.00	-48.01	0.00	-0.93	22.08	0.16
848.80	-24.71	-48.05	0.00	-0.76	22.58	0.18

GSM850 (EDGE) Radiated Power ERP						
Horizontal Polarization						
Frequency (MHz)	Rt (dBm)	Rs (dBm)	Ps (dBm)	Gs (dBd)	ERP (dBm)	ERP (W)
824.20	-32.89	-48.12	0.00	-1.08	14.15	0.03
836.40	-33.75	-48.28	0.00	-0.93	13.60	0.02
848.80	-33.49	-48.35	0.00	-0.76	14.10	0.03
Vertical Polarization						
Frequency (MHz)	Rt (dBm)	Rs (dBm)	Ps (dBm)	Gs (dBd)	ERP (dBm)	ERP (W)
824.20	-29.90	-47.97	0.00	-1.08	16.99	0.05
836.40	-29.57	-48.01	0.00	-0.93	17.51	0.06
848.80	-29.45	-48.05	0.00	-0.76	17.84	0.06



PCS1900 (GSM) Radiated Power EIRP						
Horizontal Polarization						
Frequency (MHz)	Rt (dBm)	Rs (dBm)	Ps (dBm)	Gs (dBi)	EIRP (dBm)	EIRP (W)
1850.20	-37.72	-51.88	0.00	1.96	16.12	0.04
1880.00	-38.07	-52.99	0.00	2.00	16.92	0.05
1909.80	-37.99	-54.28	0.00	1.98	18.27	0.07
Vertical Polarization						
Frequency (MHz)	Rt (dBm)	Rs (dBm)	Ps (dBm)	Gs (dBi)	EIRP (dBm)	EIRP (W)
1850.20	-34.02	-52.13	0.00	1.96	20.07	0.10
1880.00	-35.00	-53.17	0.00	2.00	20.17	0.10
1909.80	-35.56	-54.13	0.00	1.98	20.55	0.11

PCS1900 (EDGE) Radiated Power EIRP						
Horizontal Polarization						
Frequency (MHz)	Rt (dBm)	Rs (dBm)	Ps (dBm)	Gs (dBi)	EIRP (dBm)	EIRP (W)
1850.20	-40.93	-51.88	0.00	1.96	12.91	0.02
1880.00	-42.94	-52.99	0.00	2.00	12.05	0.02
1909.80	-43.28	-54.28	0.00	1.98	12.98	0.02
Vertical Polarization						
Frequency (MHz)	Rt (dBm)	Rs (dBm)	Ps (dBm)	Gs (dBi)	EIRP (dBm)	EIRP (W)
1850.20	-37.75	-52.13	0.00	1.96	16.34	0.04
1880.00	-38.47	-53.17	0.00	2.00	16.70	0.05
1909.80	-38.33	-54.13	0.00	1.98	17.78	0.06



WCDMA Band V Radiated Power ERP						
Horizontal Polarization						
Frequency (MHz)	Rt (dBm)	Rs (dBm)	Ps (dBm)	Gs (dBd)	ERP (dBm)	ERP (W)
826.40	-35.50	-48.12	0.00	-1.08	11.54	0.01
836.60	-34.87	-48.28	0.00	-0.93	12.48	0.02
846.60	-35.80	-48.35	0.00	-0.76	11.79	0.02
Vertical Polarization						
Frequency (MHz)	Rt (dBm)	Rs (dBm)	Ps (dBm)	Gs (dBd)	ERP (dBm)	ERP (W)
826.40	-32.57	-47.97	0.00	-1.08	14.32	0.03
836.60	-31.91	-48.01	0.00	-0.93	15.17	0.03
846.60	-32.66	-48.05	0.00	-0.76	14.63	0.03

WCDMA Band V (HSDPA) Radiated Power ERP						
Horizontal Polarization						
Frequency (MHz)	Rt (dBm)	Rs (dBm)	Ps (dBm)	Gs (dBd)	ERP (dBm)	ERP (W)
826.40	-36.74	-48.12	0.00	-1.08	10.30	0.01
836.60	-37.12	-48.28	0.00	-0.93	10.23	0.01
846.60	-38.29	-48.35	0.00	-0.76	9.30	0.01
Vertical Polarization						
Frequency (MHz)	Rt (dBm)	Rs (dBm)	Ps (dBm)	Gs (dBd)	ERP (dBm)	ERP (W)
826.40	-33.03	-47.97	0.00	-1.08	13.86	0.02
836.60	-32.59	-48.01	0.00	-0.93	14.49	0.03
846.60	-33.50	-48.05	0.00	-0.76	13.79	0.02



WCDMA Band II Radiated Power EIRP						
Horizontal Polarization						
Frequency (MHz)	Rt (dBm)	Rs (dBm)	Ps (dBm)	Gs (dBi)	EIRP (dBm)	EIRP (W)
1852.40	-42.13	-51.88	0.00	1.96	11.71	0.01
1880.00	-42.82	-52.99	0.00	2.00	12.17	0.02
1907.60	-42.85	-54.28	0.00	1.98	13.41	0.02
Vertical Polarization						
Frequency (MHz)	Rt (dBm)	Rs (dBm)	Ps (dBm)	Gs (dBi)	EIRP (dBm)	EIRP (W)
1852.40	-38.95	-52.13	0.00	1.96	15.14	0.03
1880.00	-39.57	-53.17	0.00	2.00	15.60	0.04
1907.60	-39.96	-54.13	0.00	1.98	16.15	0.04

WCDMA Band II (HSDPA) Radiated Power EIRP						
Horizontal Polarization						
Frequency (MHz)	Rt (dBm)	Rs (dBm)	Ps (dBm)	Gs (dBi)	EIRP (dBm)	EIRP (W)
1852.40	-42.38	-51.88	0.00	1.96	11.46	0.01
1880.00	-44.79	-52.99	0.00	2.00	10.20	0.01
1907.60	-45.35	-54.28	0.00	1.98	10.91	0.01
Vertical Polarization						
Frequency (MHz)	Rt (dBm)	Rs (dBm)	Ps (dBm)	Gs (dBi)	EIRP (dBm)	EIRP (W)
1852.40	-39.79	-52.13	0.00	1.96	14.30	0.03
1880.00	-40.96	-53.17	0.00	2.00	14.21	0.03
1907.60	-41.37	-54.13	0.00	1.98	14.74	0.03

4.4 Occupied Bandwidth and Band Edge Measurement

4.4.1 Measurement Instruments

As described in chapter 5 of this test report.

4.4.2 Test Procedure

- a. The EUT was connected to Spectrum Analyzer and Base Station via power divider.
- b. The 99% occupied bandwidth of middle channel for the highest and lowest RF powers were measured.
- c. The bandedge of low and high channels for the highest RF powers within the transmitting frequency band were measured. Setting RBW as roughly $BW/100$.

4.4.3 Test Setup Layout

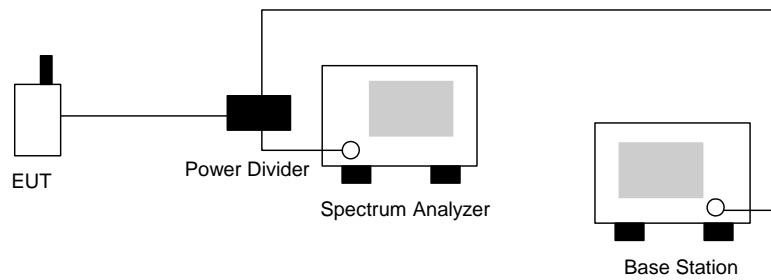



4.4.4 Test Result

- Mode 1
- Test Mode : GSM850 (GSM) CH128 Lower Band Edge
- Power State : High

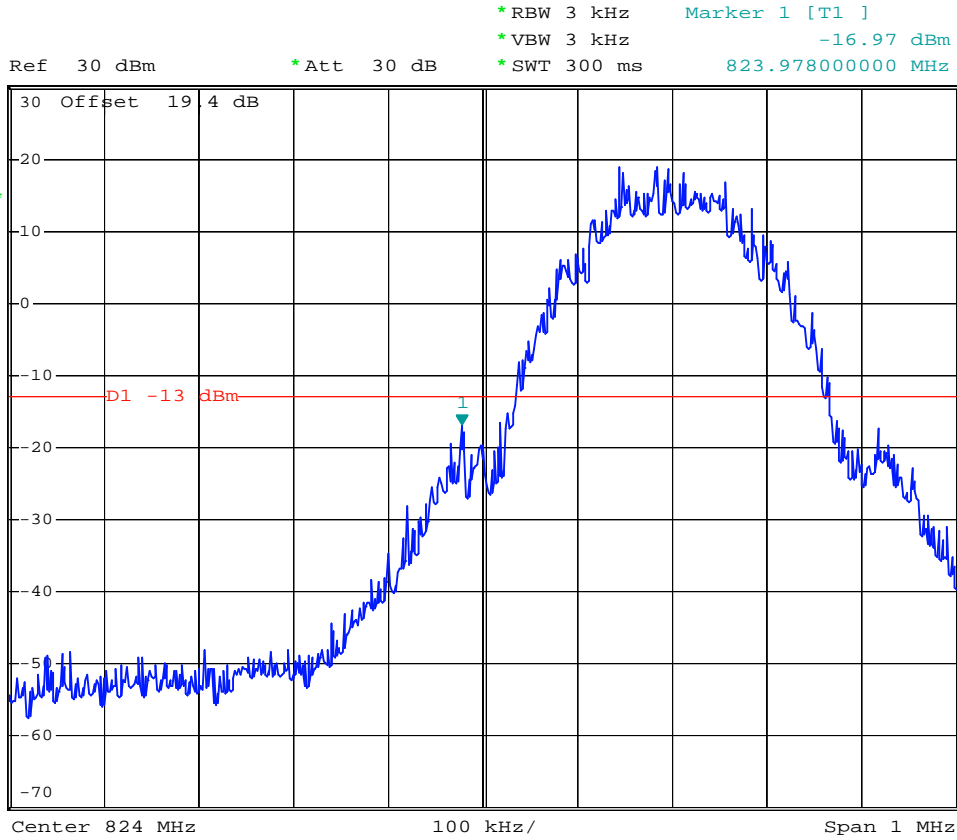

Date: 17.FEB.2008 10:52:44



- Test Mode : GSM850 (GSM) CH128 99% Occupied Bandwidth
- Power State : High

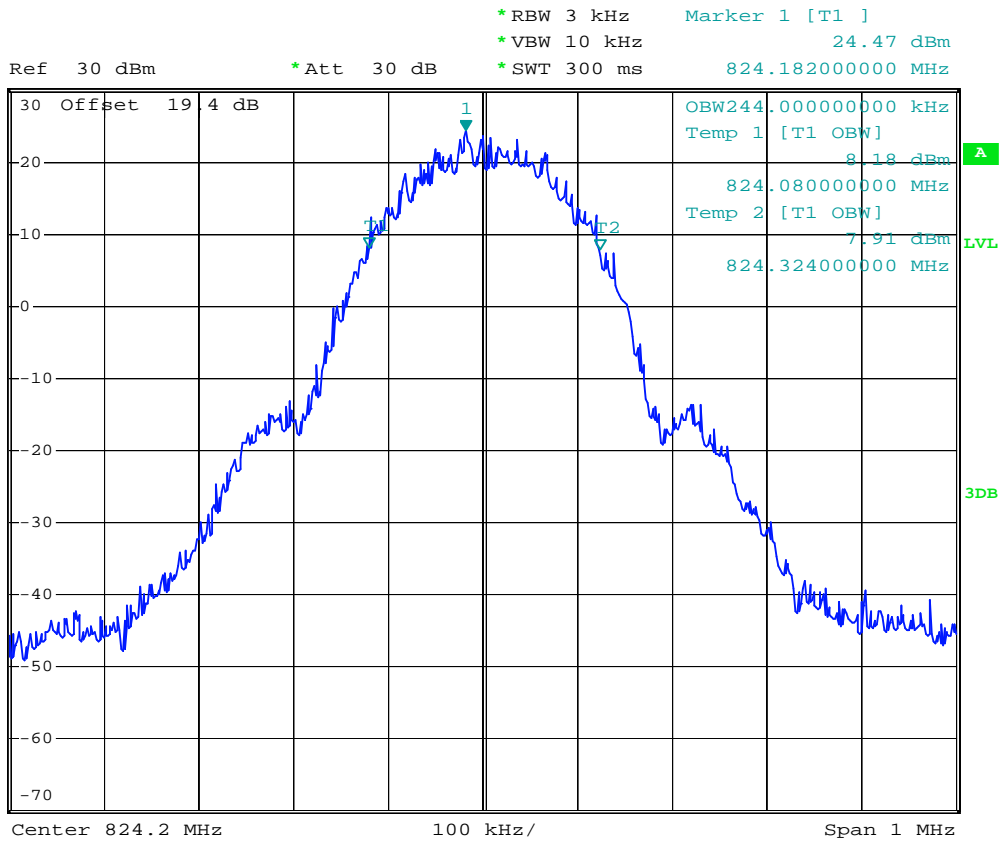

Date: 17.FEB.2008 10:59:04



- Test Mode : GSM850 (GSM) CH 251 99% Occupid Bandwidth
- Power State : High

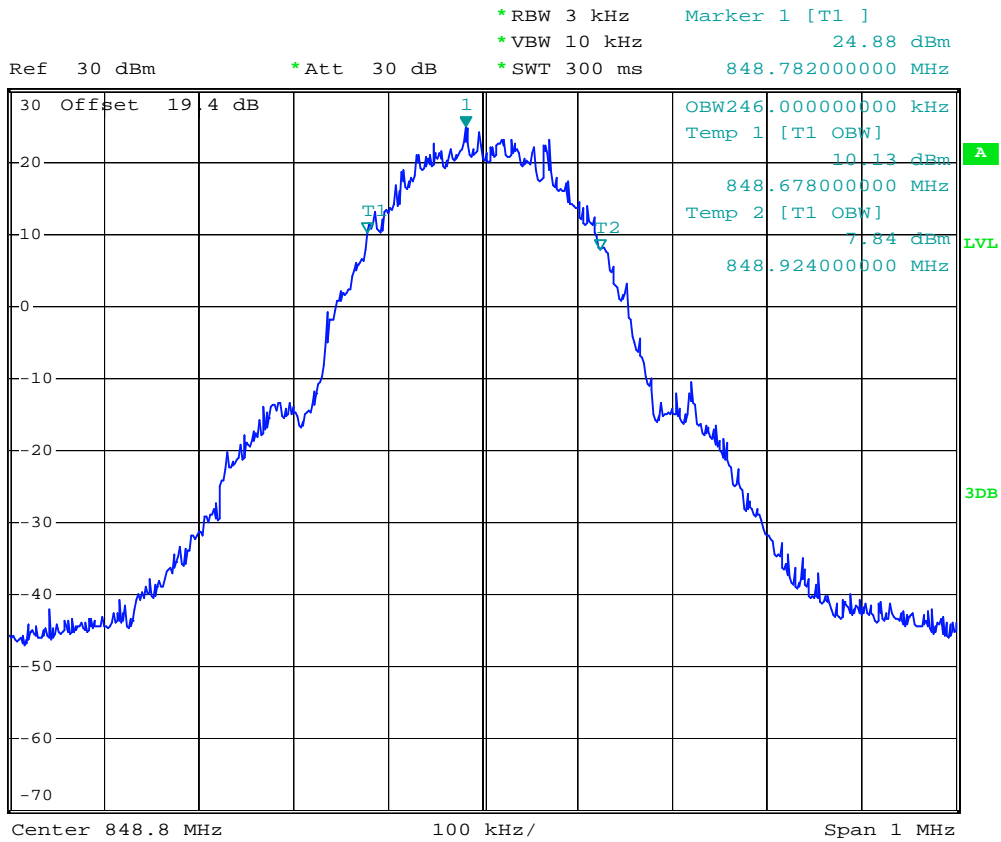

Date: 17.FEB.2008 10:56:19



- Test Mode : GSM850 (GSM) CH128 26dB Bandwidth
- Power State : High

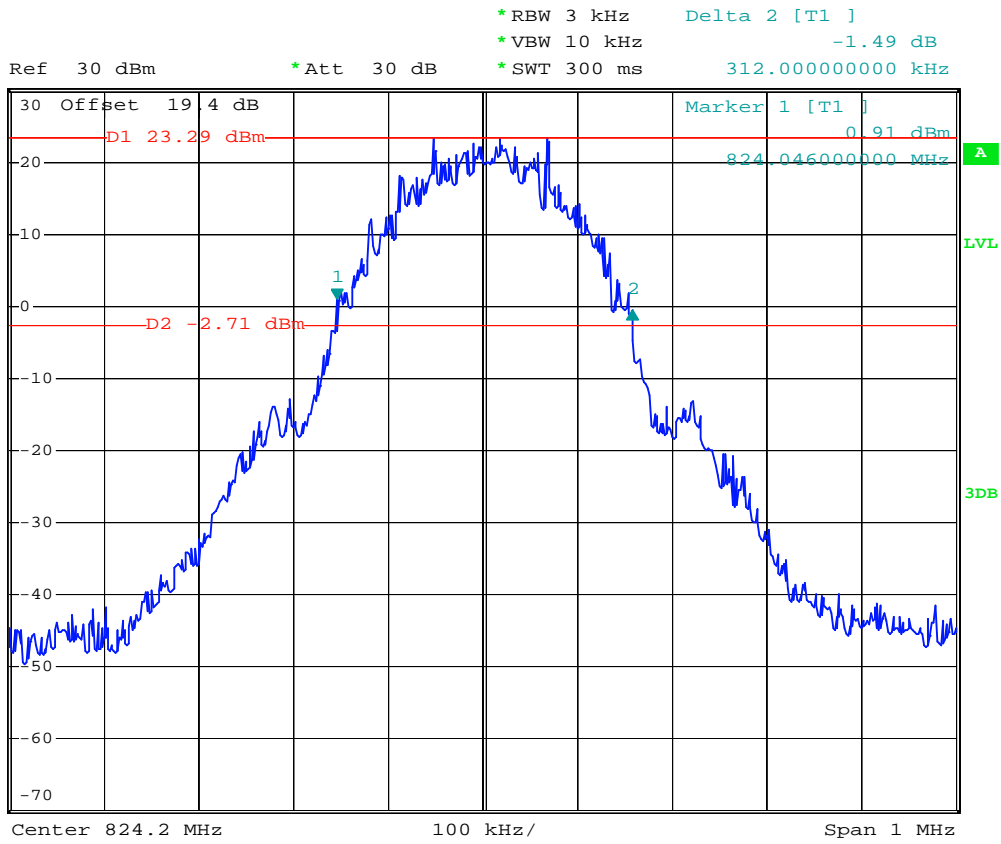

Date: 17.FEB.2008 10:47:27



- Test Mode : GSM850 (GSM) CH189 26dB Bandwidth
- Power State : High

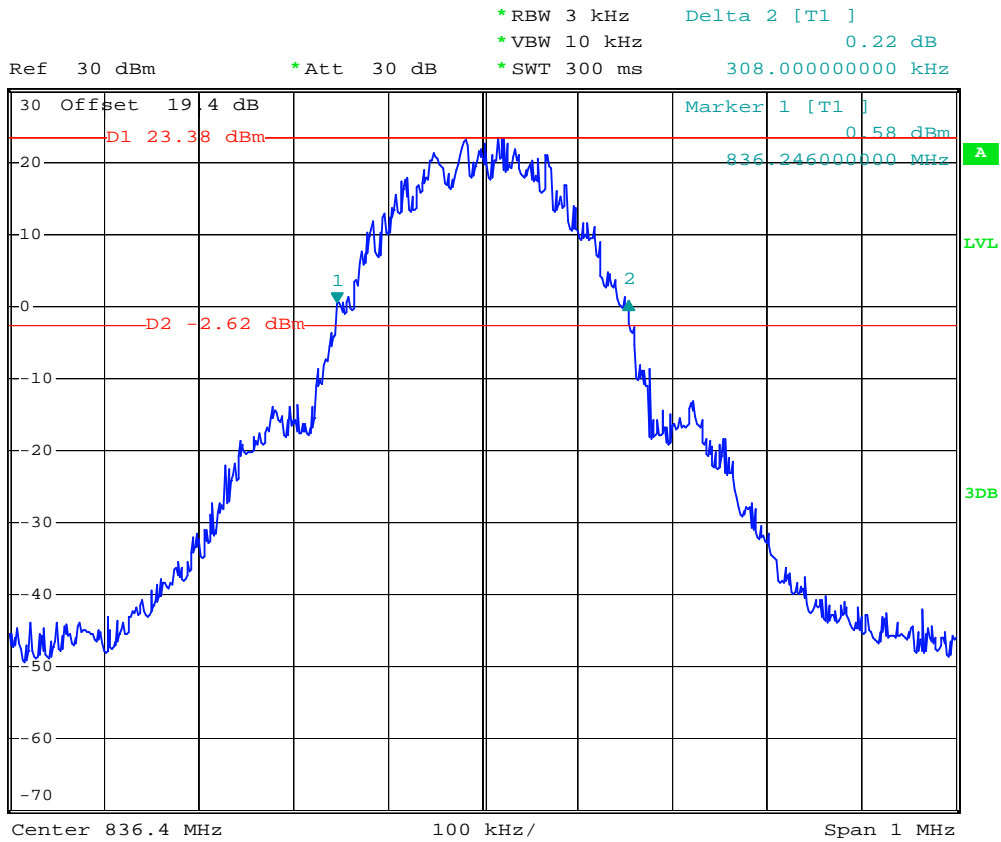

Date: 17.FEB.2008 10:48:53



- Test Mode : GSM850 (GSM) CH 251 26dB Bandwidth
- Power State : High

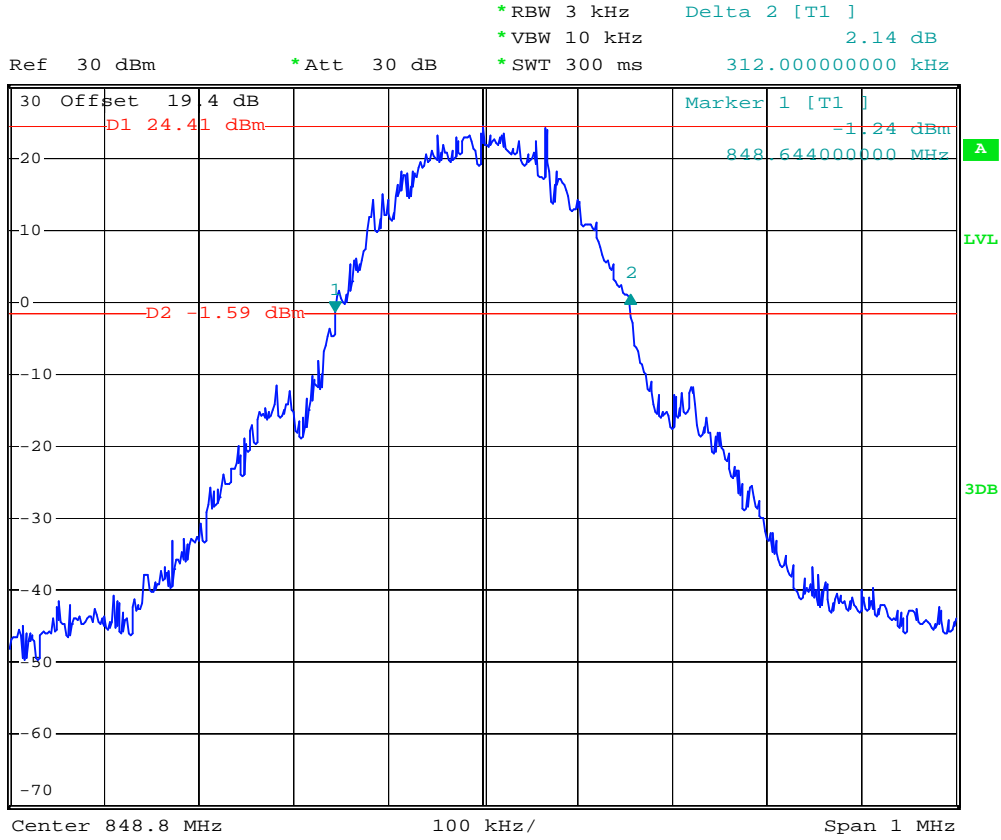

Date: 17.FEB.2008 10:50:37



- Test Mode : GSM850 (GSM) CH251 Higher Band Edge
- Power State : High



Ref 30 dBm *Att 30 dB *RBW 3 kHz Marker 1 [T1]
*VBW 3 kHz -18.61 dBm
*SWT 300 ms 849.024000000 MHz

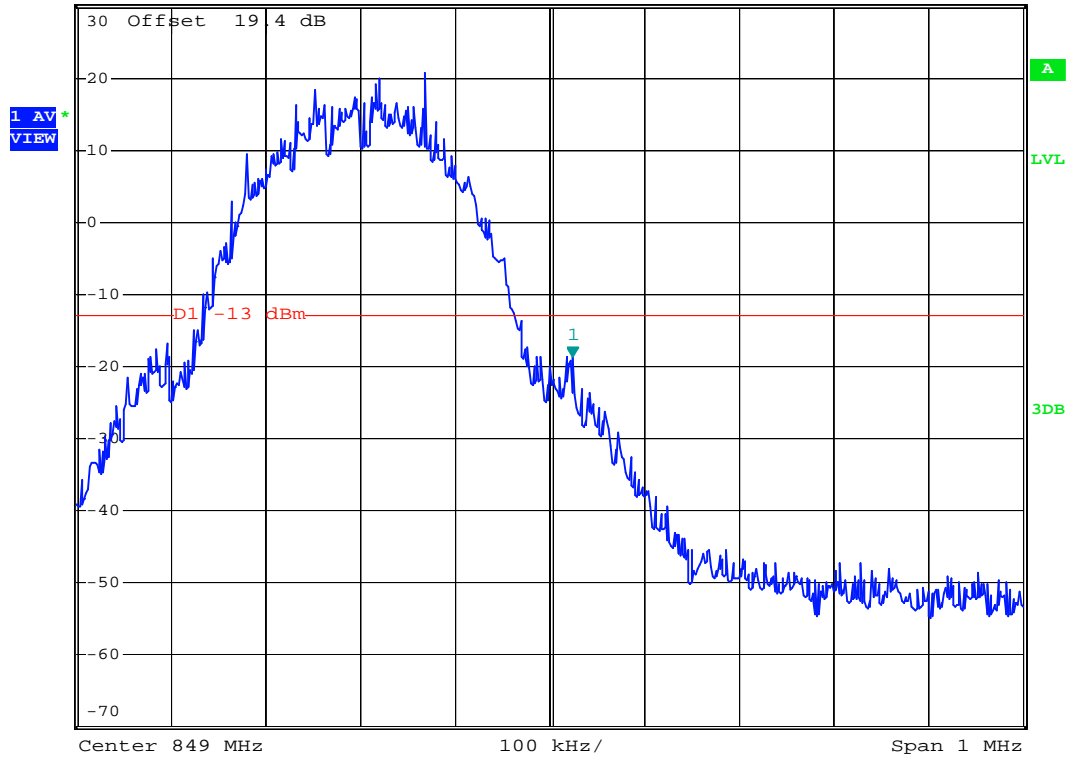

Date: 17.FEB.2008 10:52:01



- Test Mode : GSM850 (EDGE) CH 251 99% Occupied Bandwidth
- Power State : High

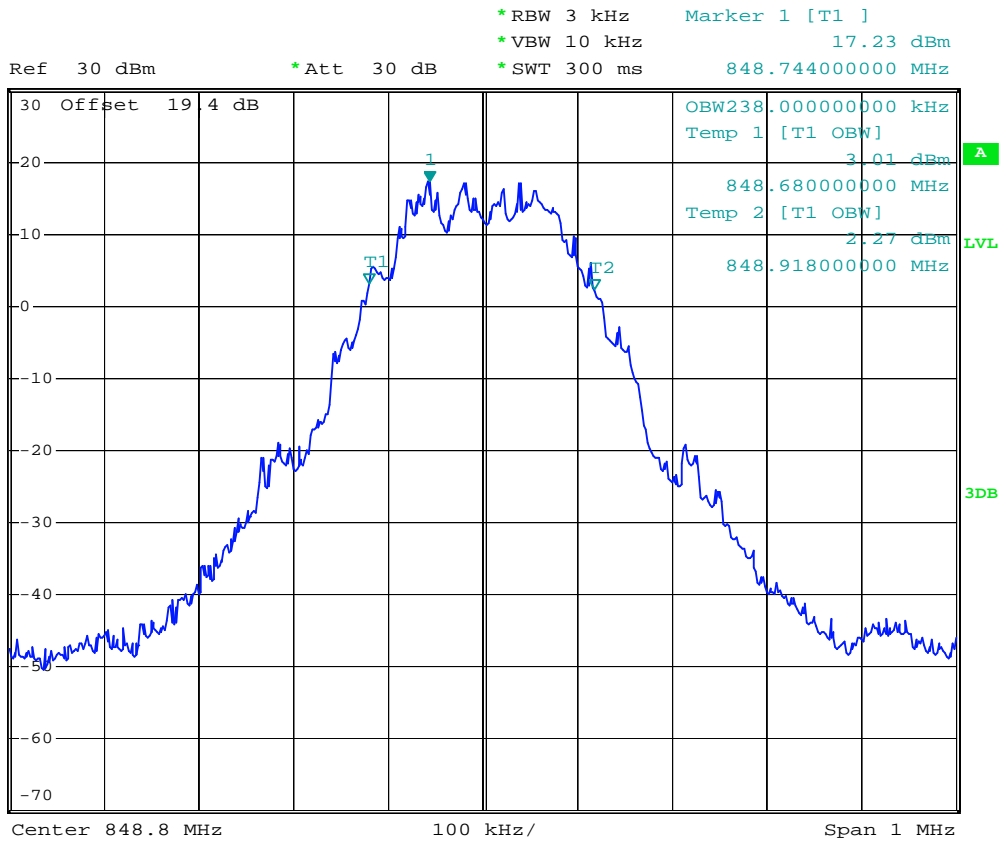

Date: 17.FEB.2008 11:49:39



- Test Mode : GSM850 (EDGE) CH128 26dB Bandwidth
- Power State : High



Ref 30 dBm *Att 30 dB *RBW 3 kHz Delta 2 [T1]
 *VBW 10 kHz -0.81 dB
 *SWT 300 ms 314.000000000 kHz

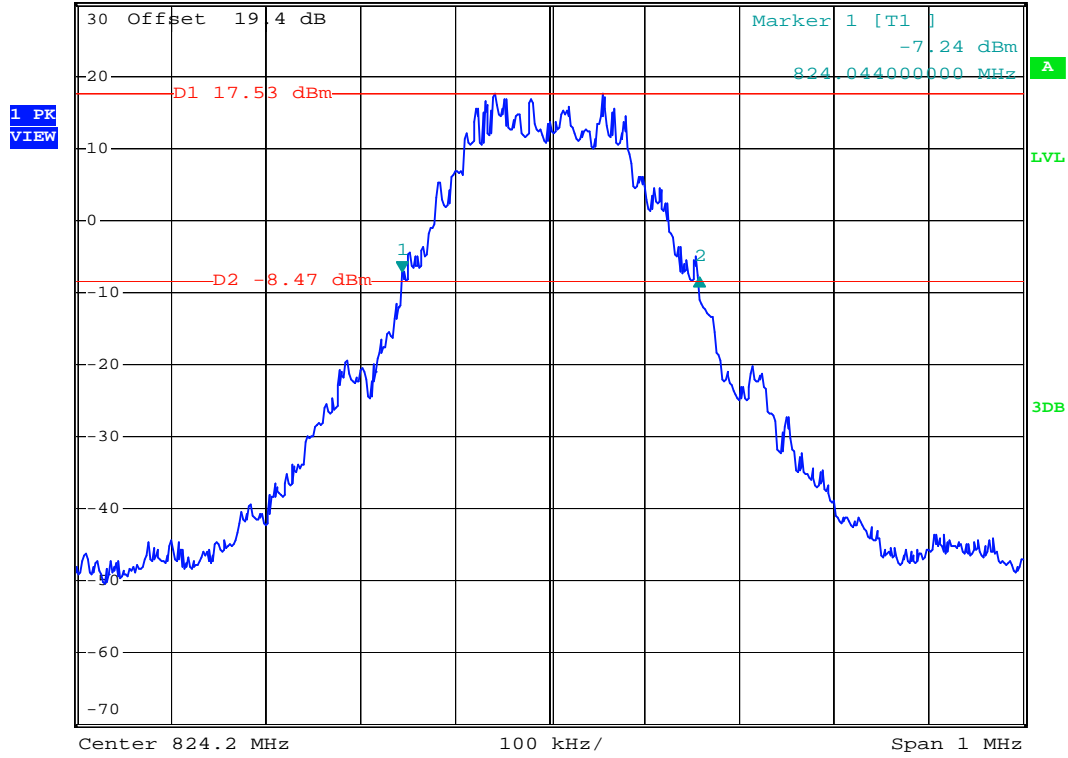

Date: 9.MAR.2008 03:42:42



- Test Mode : GSM850 (EDGE) CH189 26dB Bandwidth
- Power State : High



*RBW 3 kHz Delta 2 [T1]
 *VBW 10 kHz -1.76 dB
 *SWT 300 ms 316.000000000 kHz

Ref 30 dBm

*Att 30 dB

1 PK
VIEW

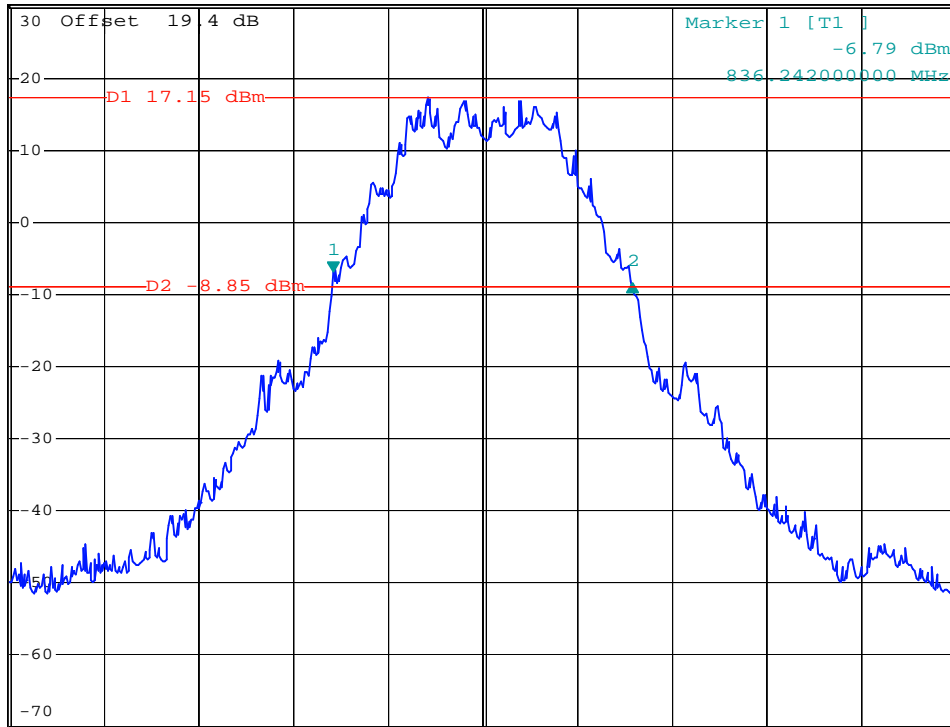

Center 836.4 MHz

100 kHz/

Span 1 MHz

Date: 17.FEB.2008 11:43:00



- Test Mode : GSM850 (EDGE) CH 251 26dB Bandwidth
- Power State : High



Ref 30 dBm *Att 30 dB *RBW 3 kHz Delta 2 [T1]
 *VBW 10 kHz -1.92 dB
 *SWT 300 ms 316.000000000 kHz

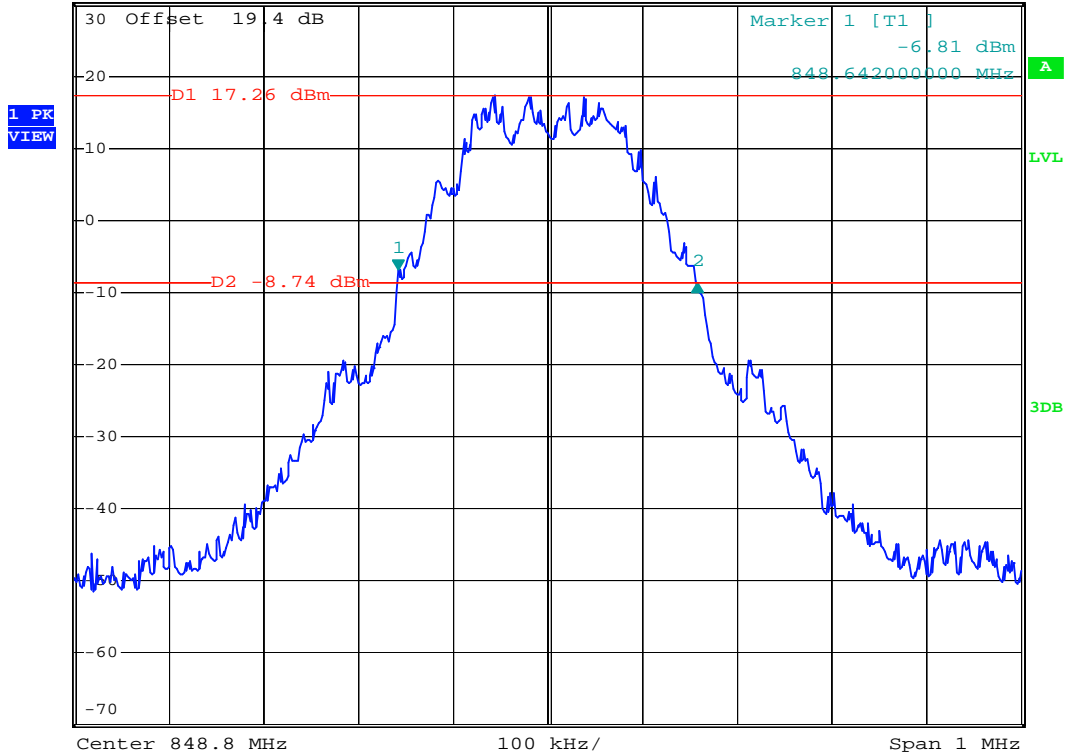

Date: 17.FEB.2008 11:44:45



- Test Mode : GSM850 (EDGE) CH251 Higher Band Edge
- Power State : High



Ref 30 dBm *Att 30 dB *RBW 3 kHz Marker 1 [T1]
*VBW 3 kHz -21.88 dBm
*SWT 300 ms 849.012000000 MHz

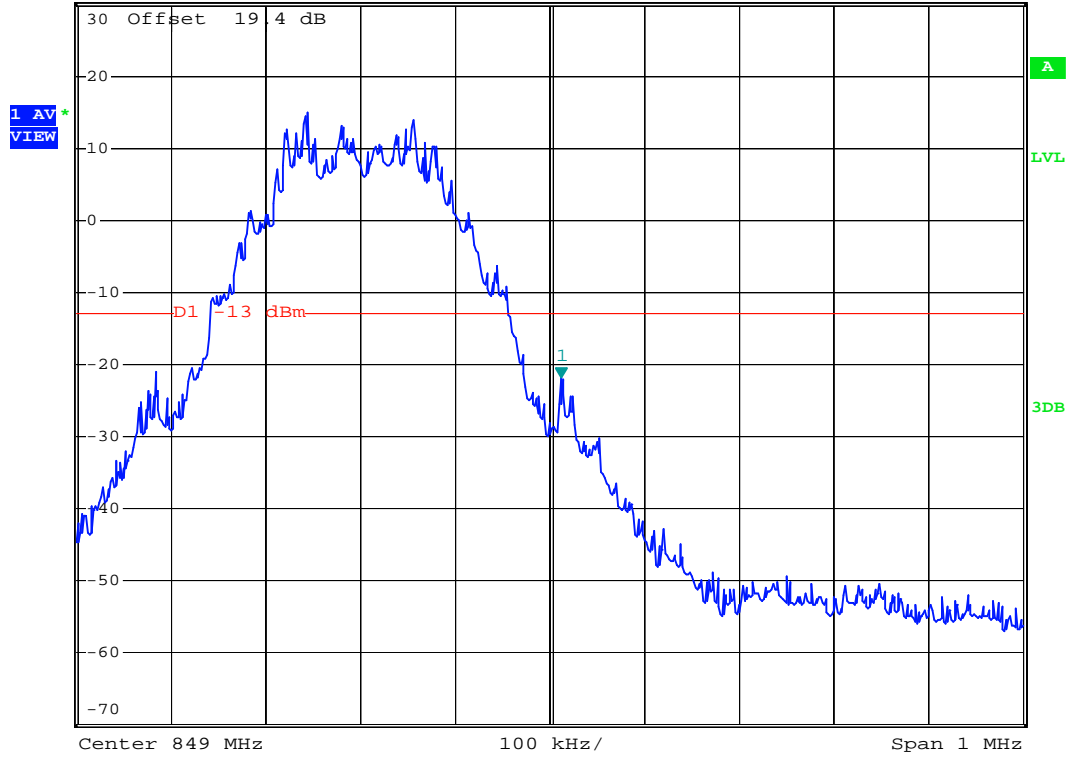

Date: 17.FEB.2008 11:45:55



- Mode 3
- Test Mode : PCS1900 (GSM) CH512 Lower Band Edge
- Power State : High

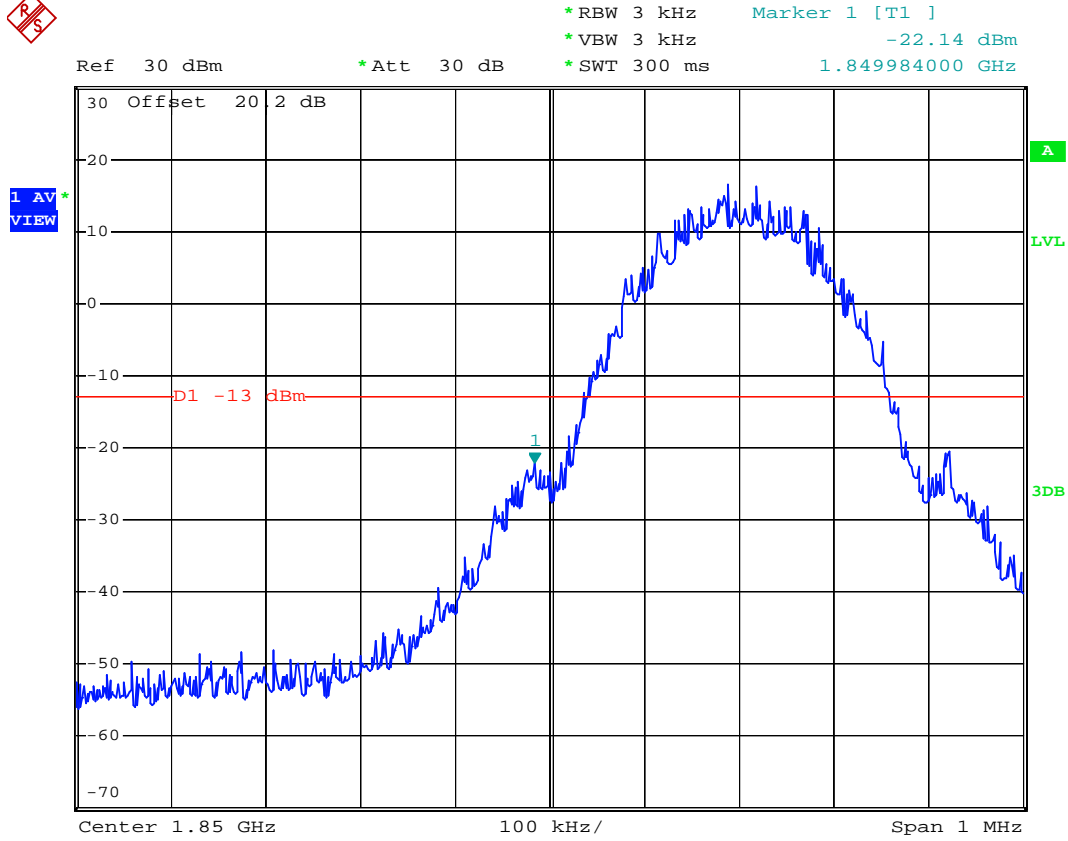

Date: 17.FEB.2008 15:09:11



- Test Mode : PCS1900 (GSM) CH512 99% Occupied Bandwidth
- Power State : High

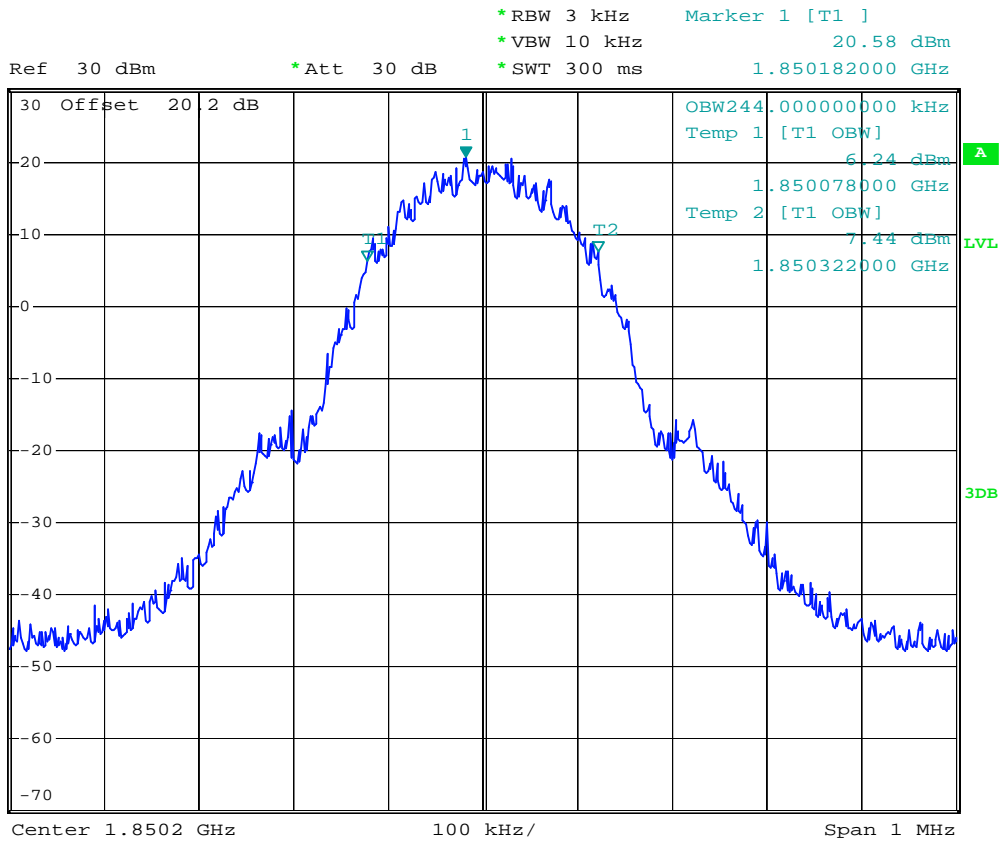

Date: 17.FEB.2008 15:17:25



- Test Mode : PCS1900 (GSM) CH661 99% Occupied Bandwidth
- Power State : High

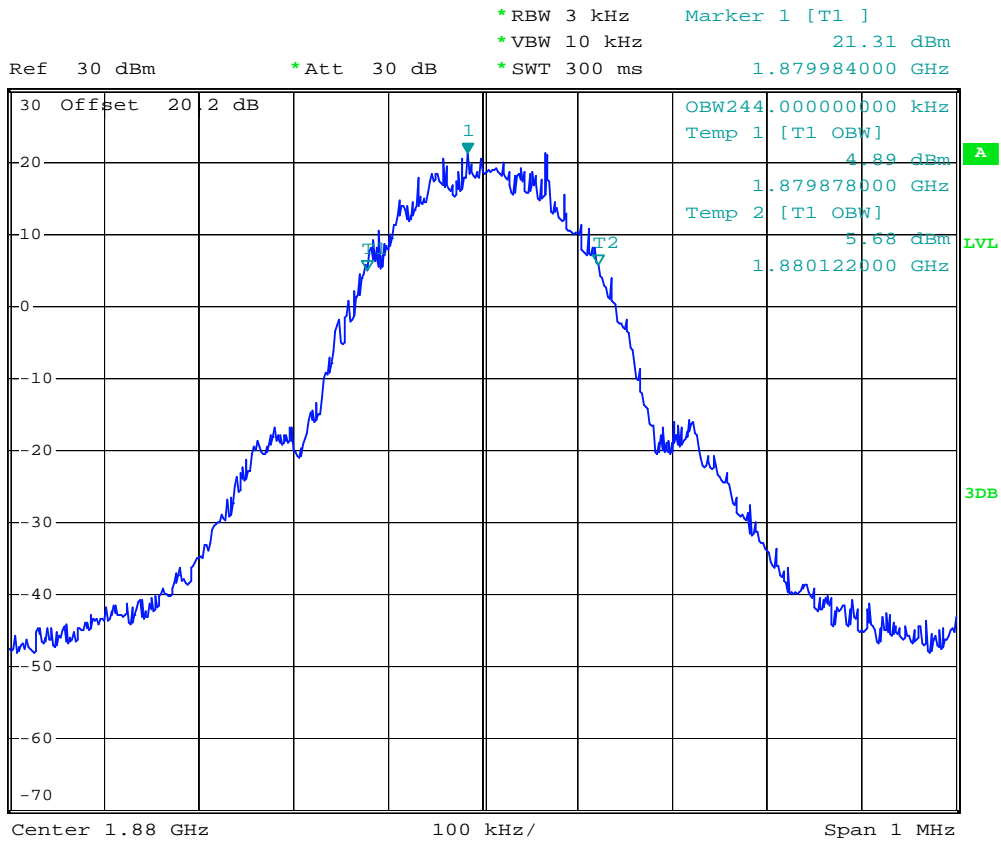

Date: 17.FEB.2008 15:16:38



- Test Mode : PCS1900 (GSM) CH810 99% Occupid Bandwidth
- Power State : High

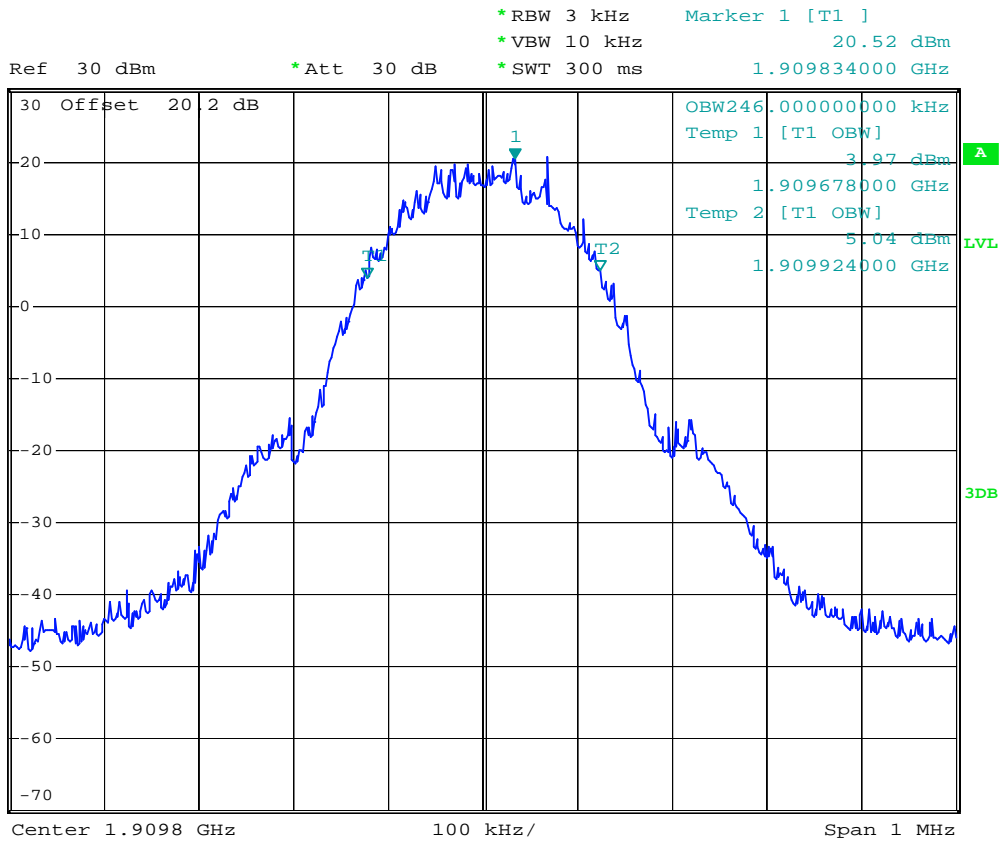

Date: 17.FEB.2008 15:15:47



- Test Mode : PCS1900 (GSM) CH512 26dB Bandwidth
- Power State : High



Ref 30 dBm *Att 30 dB *RBW 3 kHz Delta 2 [T1]
 *VBW 10 kHz -1.54 dB
 *SWT 300 ms 308.000000000 kHz

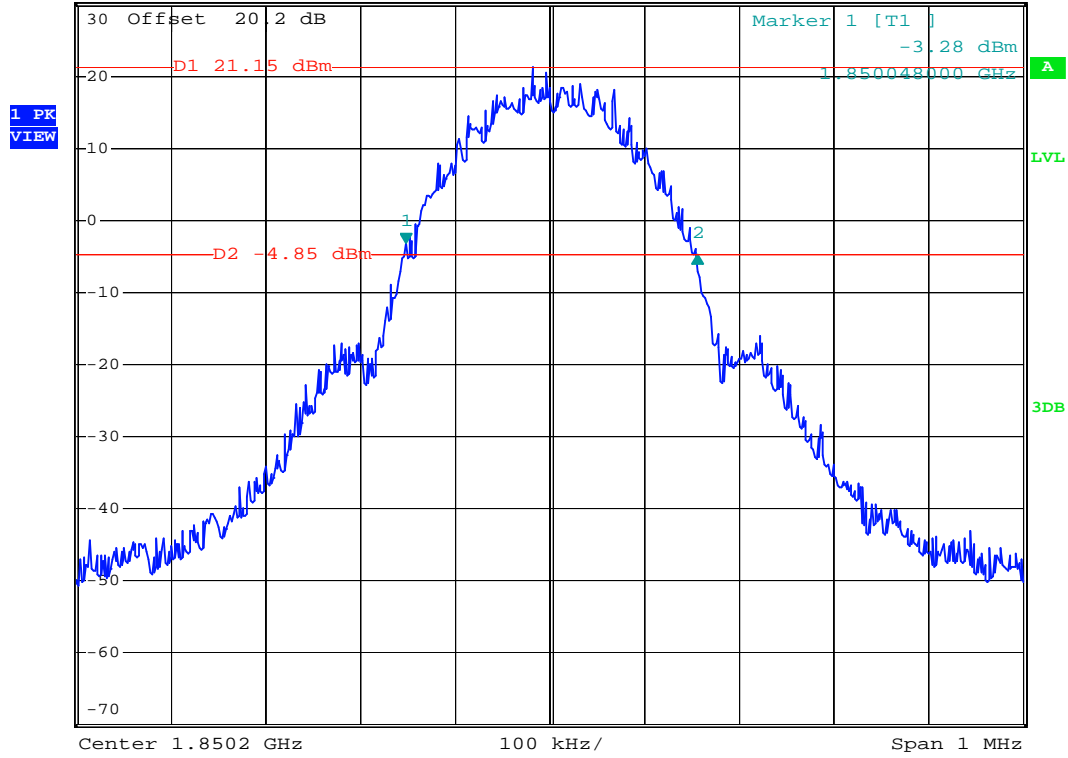

Date: 17.FEB.2008 15:02:21



- Test Mode : PCS1900 (GSM) CH661 26dB Bandwidth
- Power State : High



Ref 30 dBm *Att 30 dB *RBW 3 kHz Delta 2 [T1]
 *VBW 10 kHz -3.10 dB
 *SWT 300 ms 310.00000000 kHz

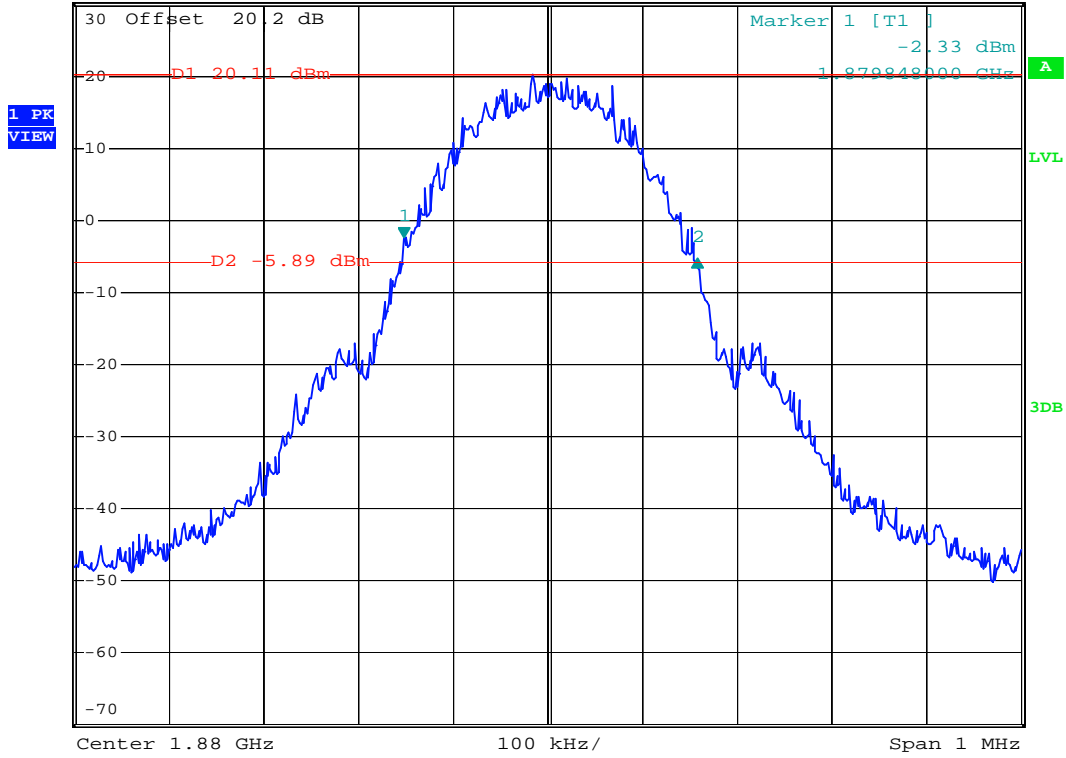

Date: 17.FEB.2008 15:03:47



- Test Mode : PCS1900 (GSM) CH810 26dB Bandwidth
- Power State : High



Ref 30 dBm *Att 30 dB *RBW 3 kHz Delta 2 [T1]
 *VBW 10 kHz 0.87 dB
 *SWT 300 ms 314.000000000 kHz

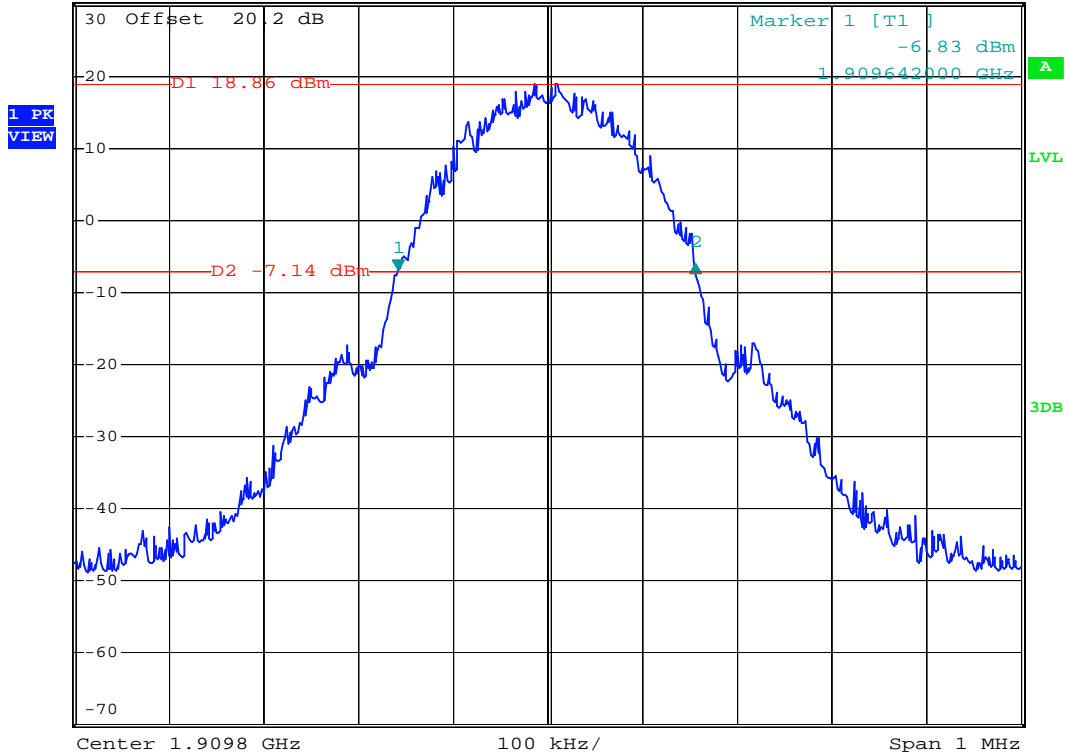

Date: 17.FEB.2008 15:06:32



- Test Mode : PCS1900 (GSM) CH810 Higher Band Edge
- Power State : High

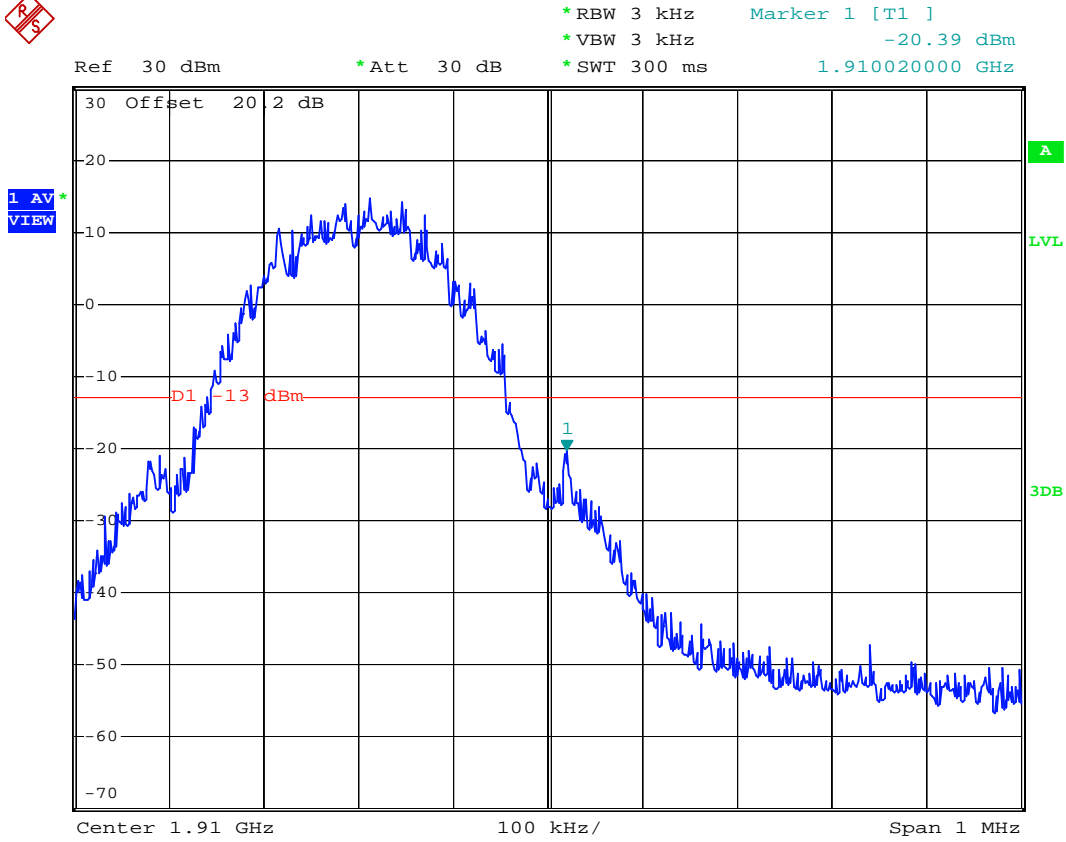

Date: 17.FEB.2008 15:08:01



- Mode 4
- Test Mode : PCS1900 (EDGE) CH512 Lower Band Edge
- Power State : High

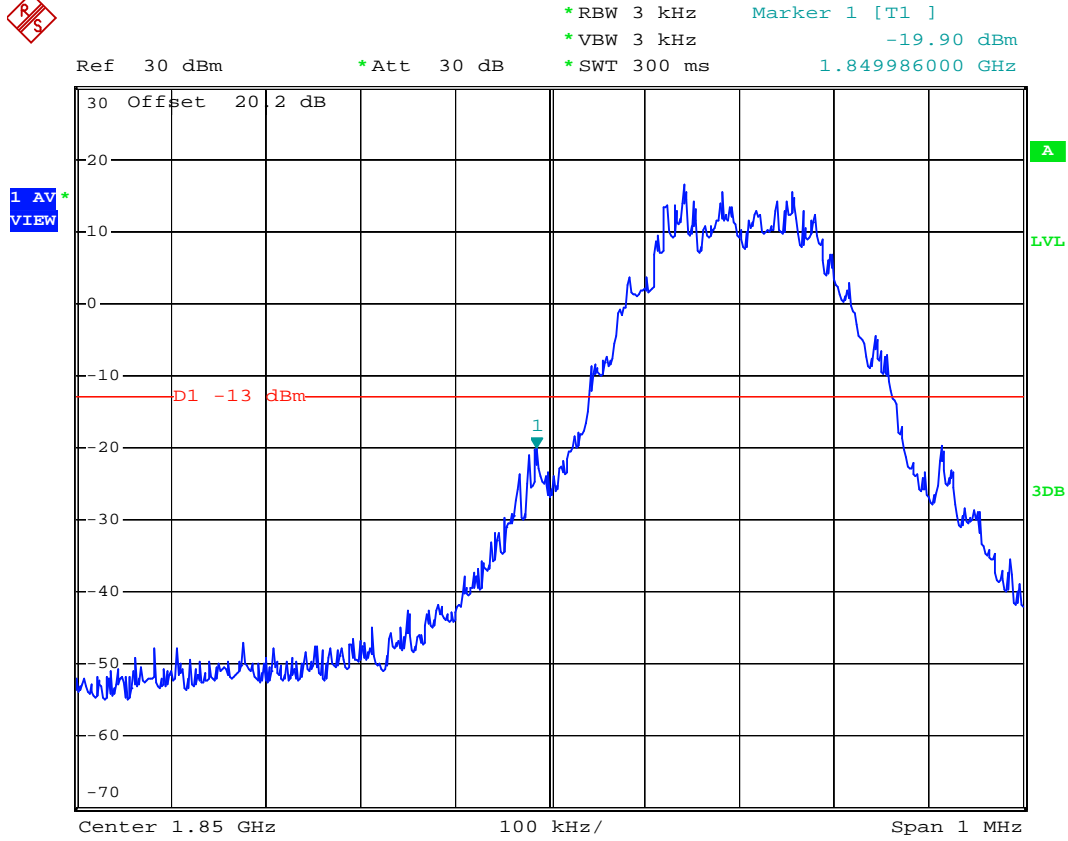

Date: 17.FEB.2008 16:08:19



- Test Mode : PCS1900 (EDGE) CH512 99% Occupied Bandwidth
- Power State : High

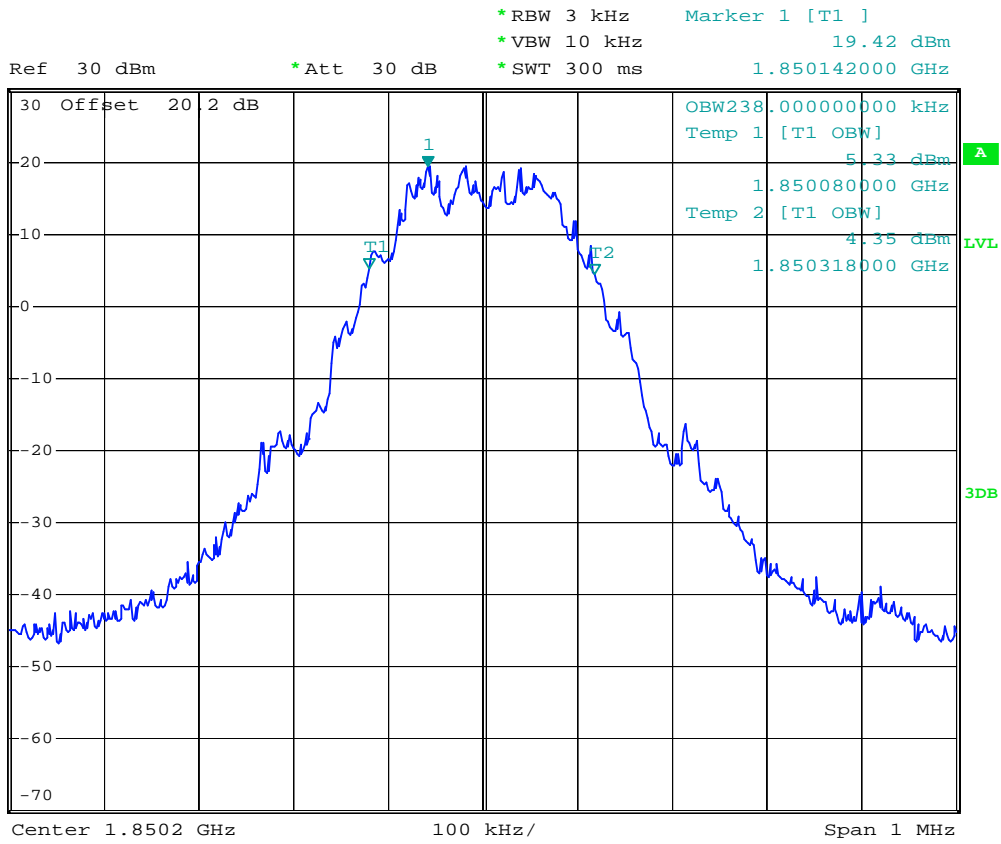

Date: 17.FEB.2008 16:13:32



- Test Mode : PCS1900 (EDGE) CH661 99% Occupied Bandwidth
- Power State : High

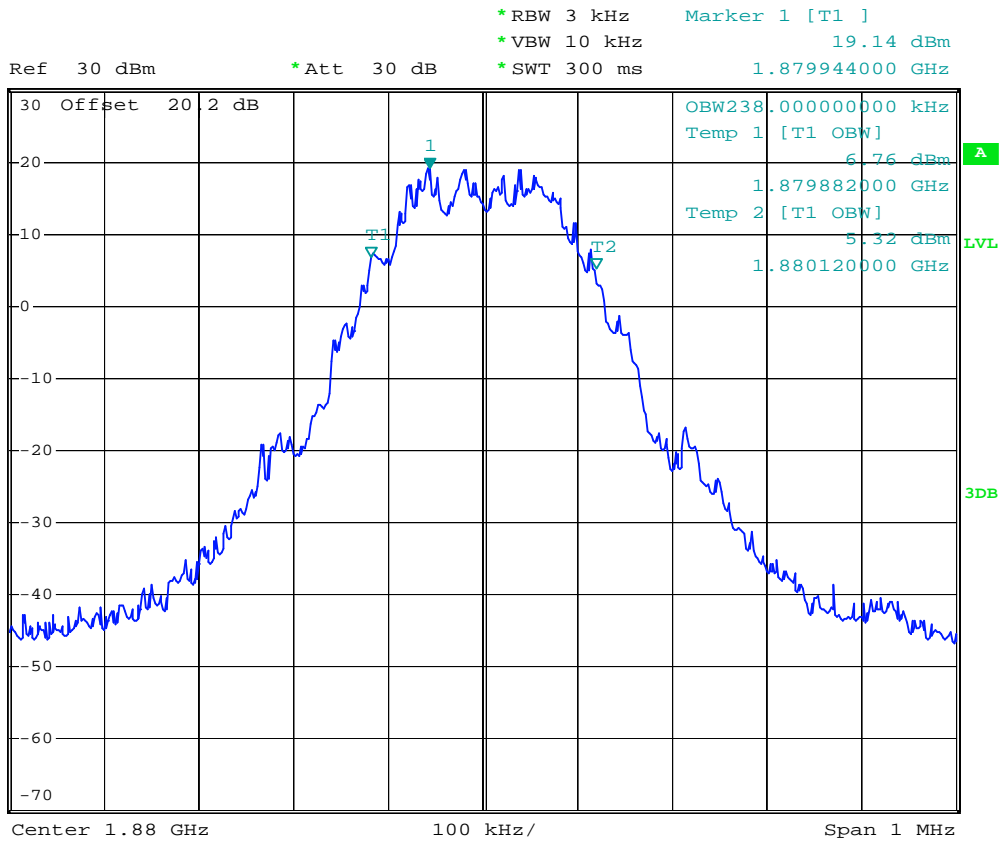

Date: 17.FEB.2008 16:14:17



- Test Mode : PCS1900 (EDGE) CH810 99% Occupied Bandwidth
- Power State : High

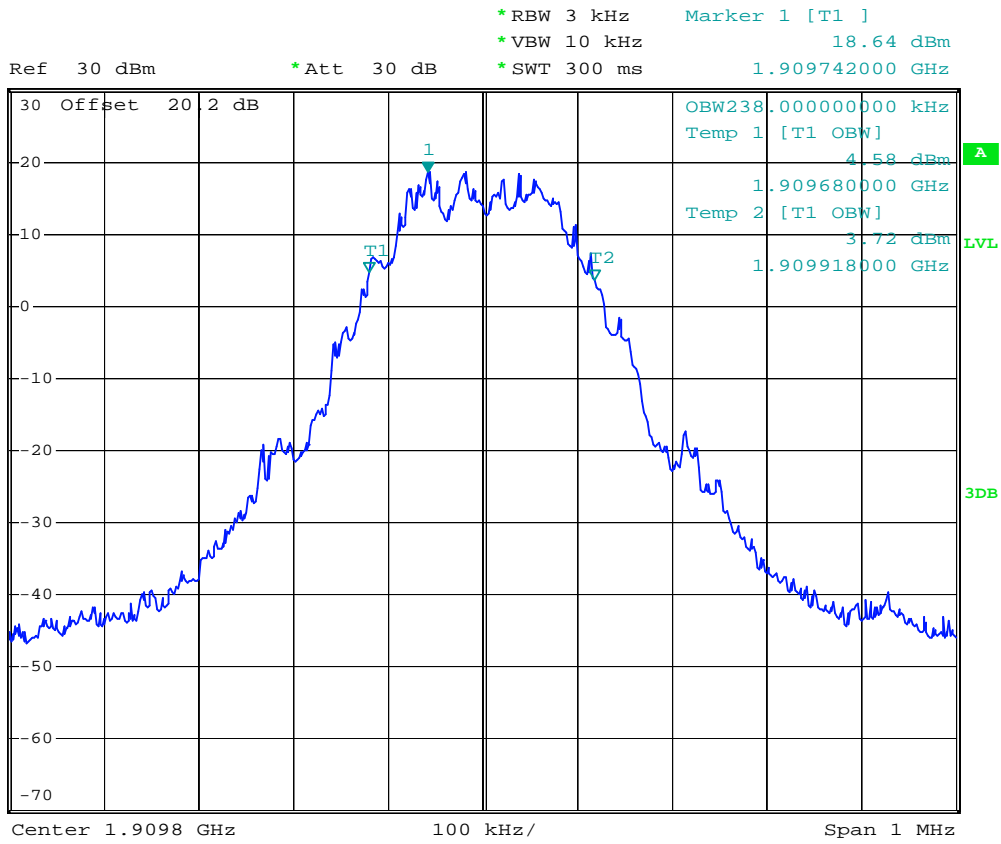

Date: 17.FEB.2008 16:15:08



- Test Mode : PCS1900 (EDGE) CH512 26dB Bandwidth
- Power State : High

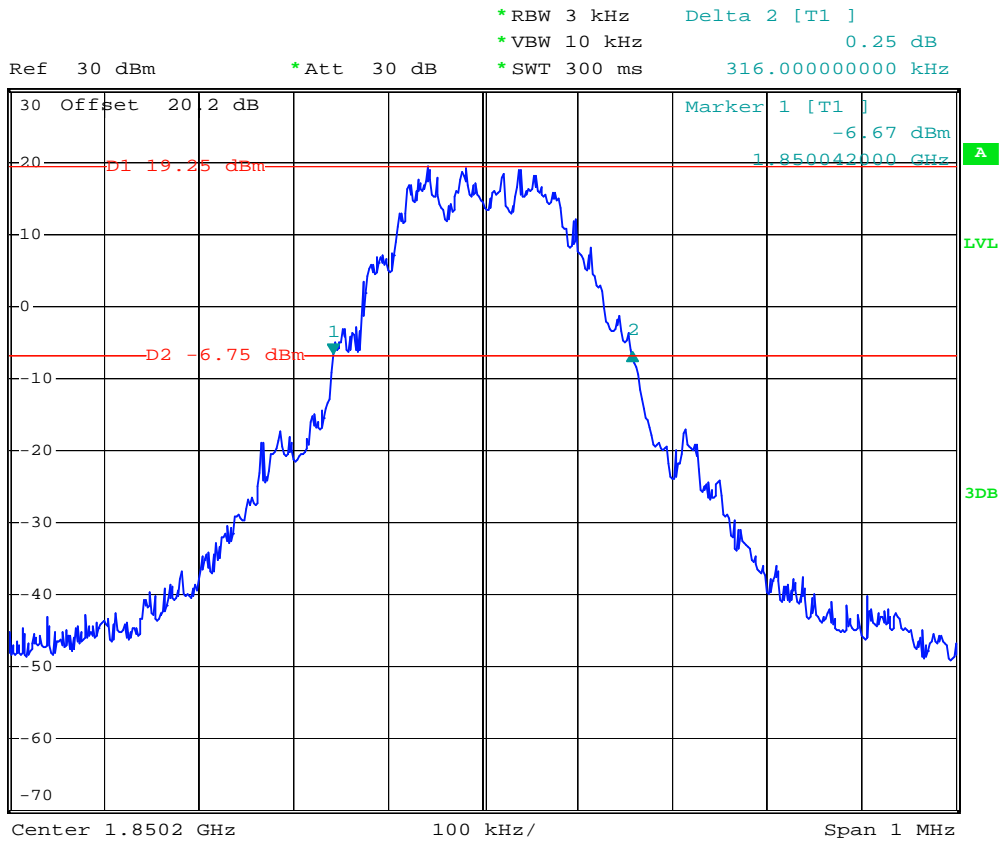

Date: 17.FEB.2008 16:04:33



- Test Mode : PCS1900 (EDGE) CH661 26dB Bandwidth
- Power State : High

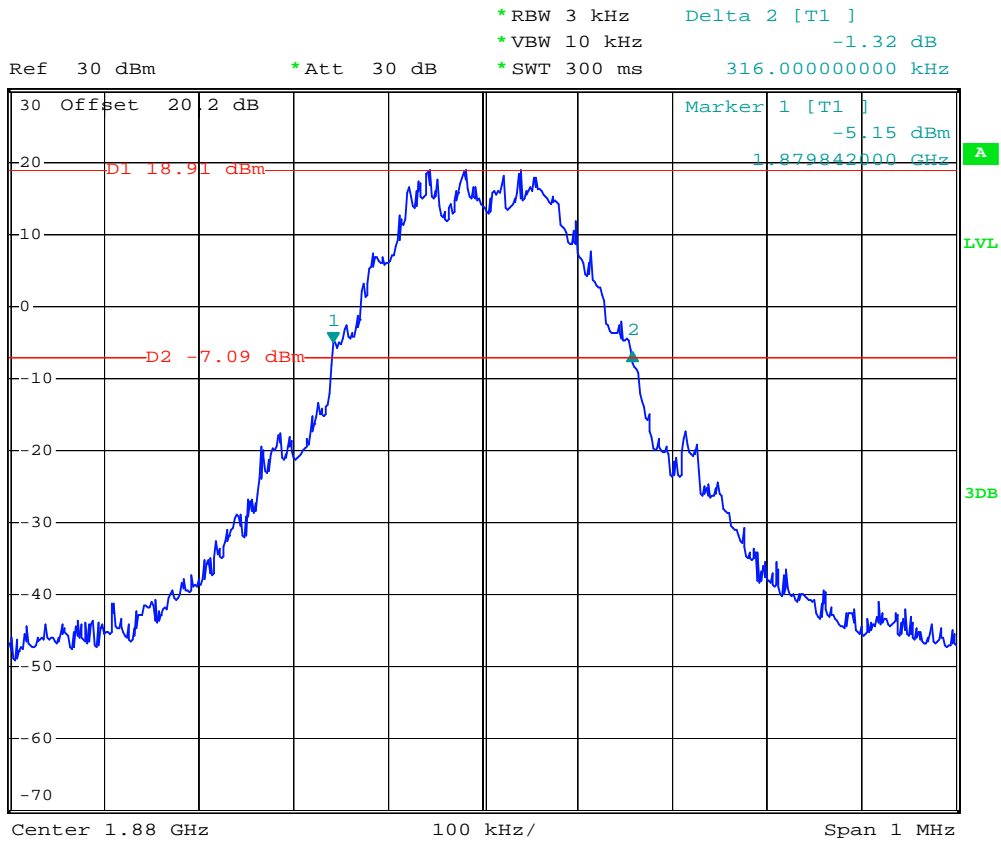

Date: 17.FEB.2008 16:05:30



- Test Mode : PCS1900 (EDGE) CH810 26dB Bandwidth
- Power State : High



Ref 30 dBm *Att 30 dB *RBW 3 kHz Delta 2 [T1]
 *VBW 10 kHz -0.65 dB
 *SWT 300 ms 316.000000000 kHz

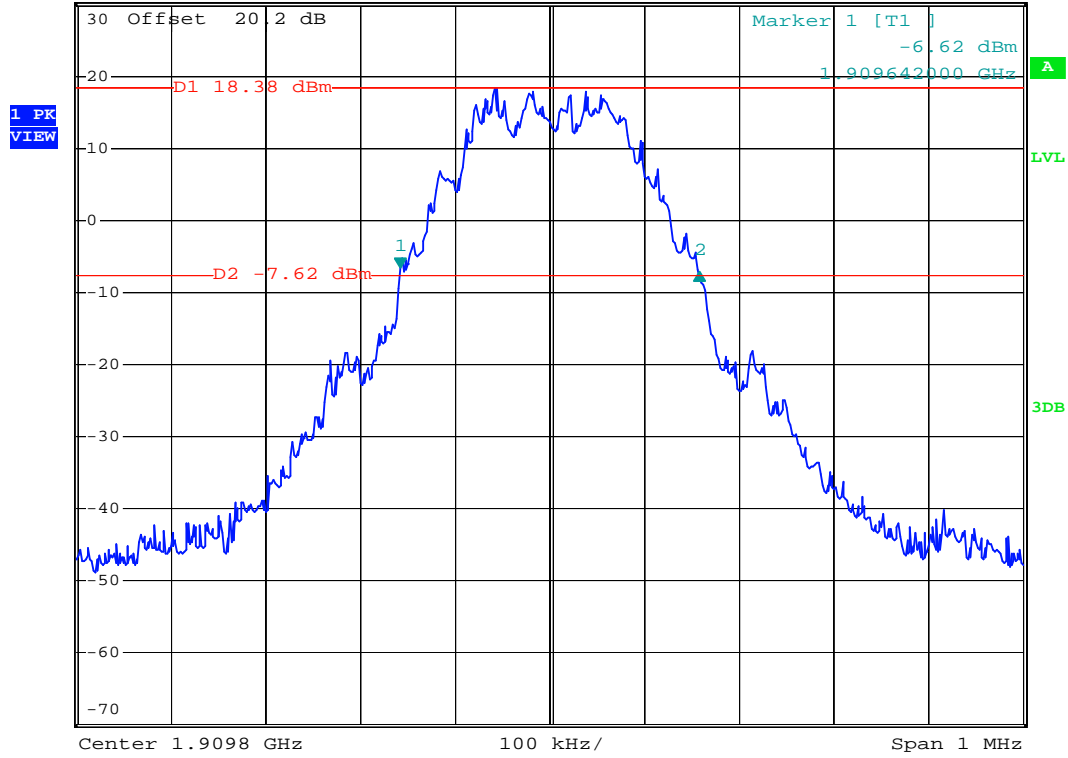

Date: 17.FEB.2008 16:06:47



- Test Mode : PCS1900(EDGE) CH810 Higher Band Edge
- Power State : High

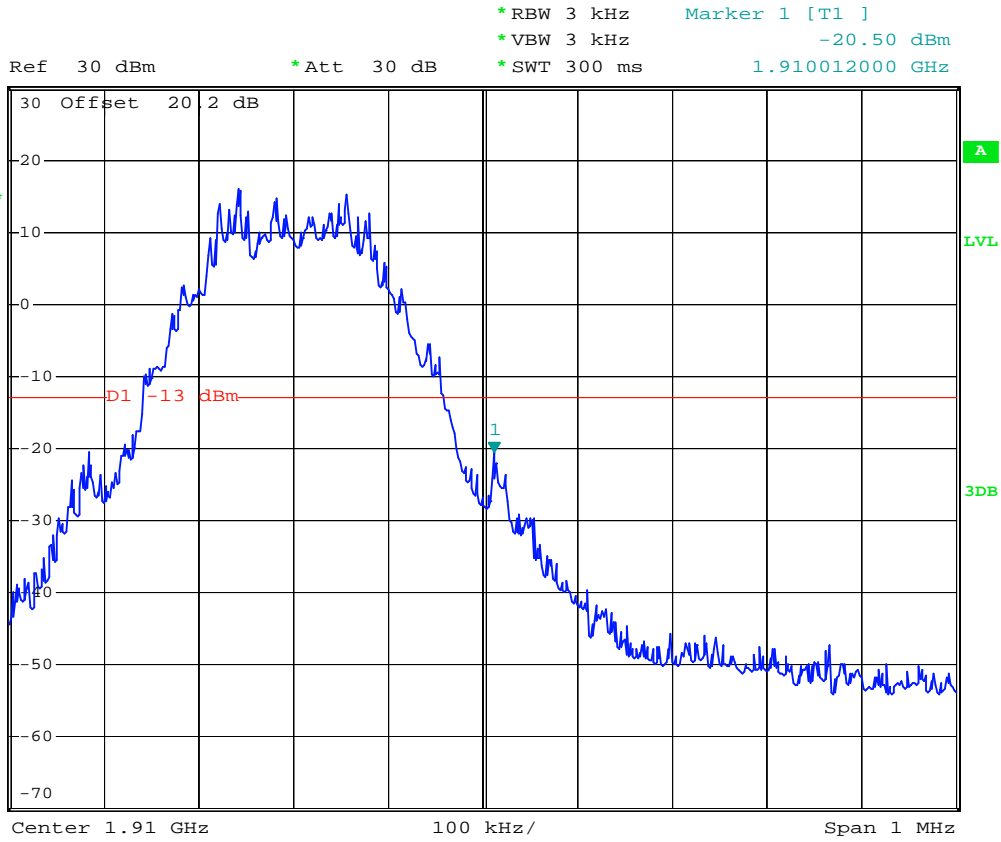

Date: 17.FEB.2008 16:07:36



- Mode 5
- Test Mode : WCDMA Band V CH4132 Lower Band Edge
- Power State : High



Ref 30 dBm *Att 30 dB *RBW 100 kHz Marker 1 [T1]
*VBW 100 kHz -29.68 dBm
*SWT 300 ms 823.99000000 MHz

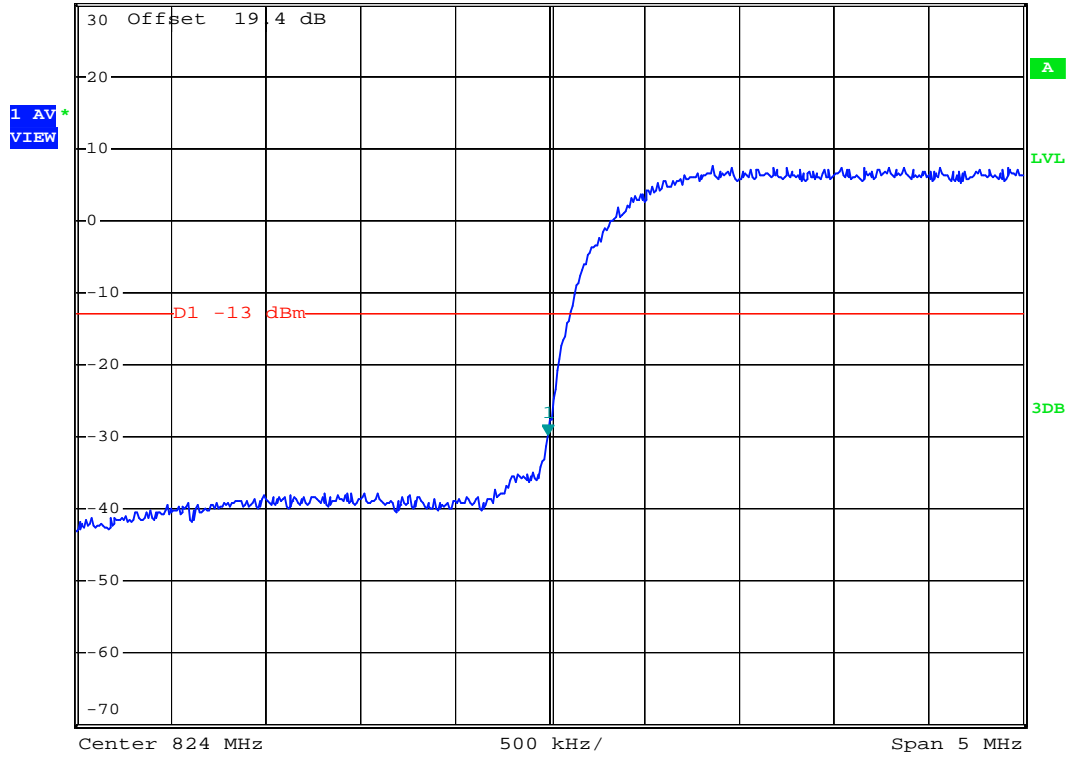

Date: 17.FEB.2008 16:54:54



- Test Mode : WCDMA Band V CH4182 99% Occupied Bandwidth
- Power State : High

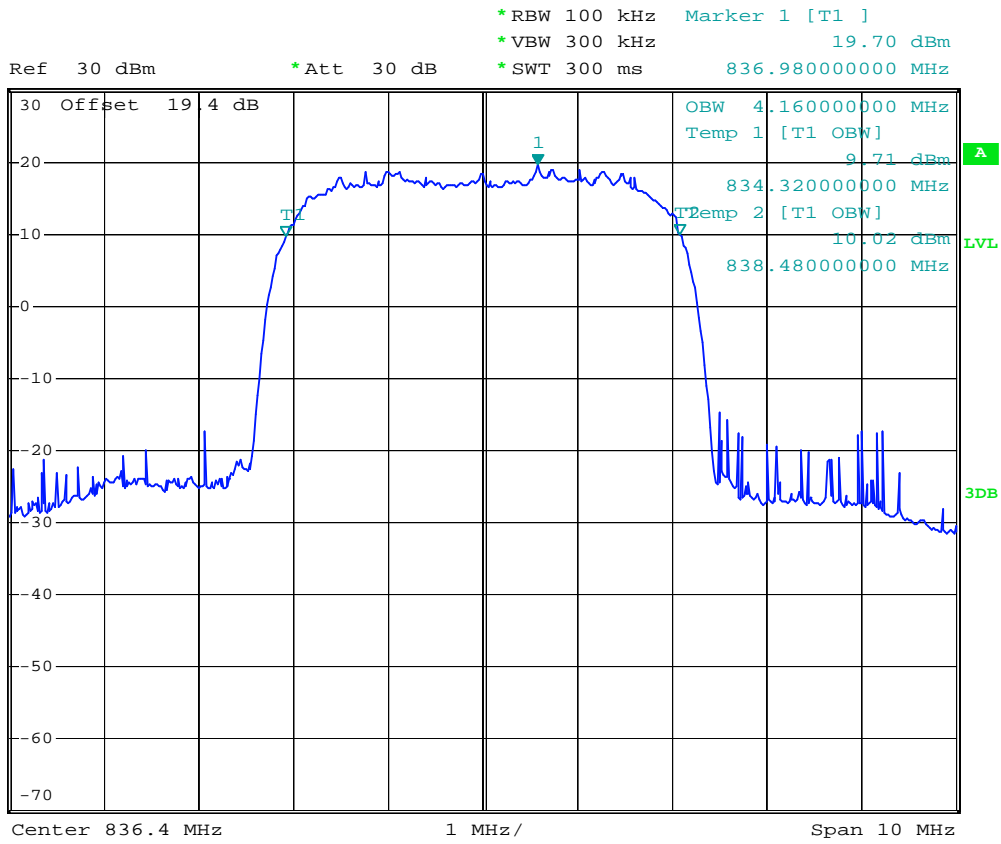

Date: 17.FEB.2008 16:42:54



- Test Mode : WCDMA Band V CH4233 99% Occupied Bandwidth
- Power State : High

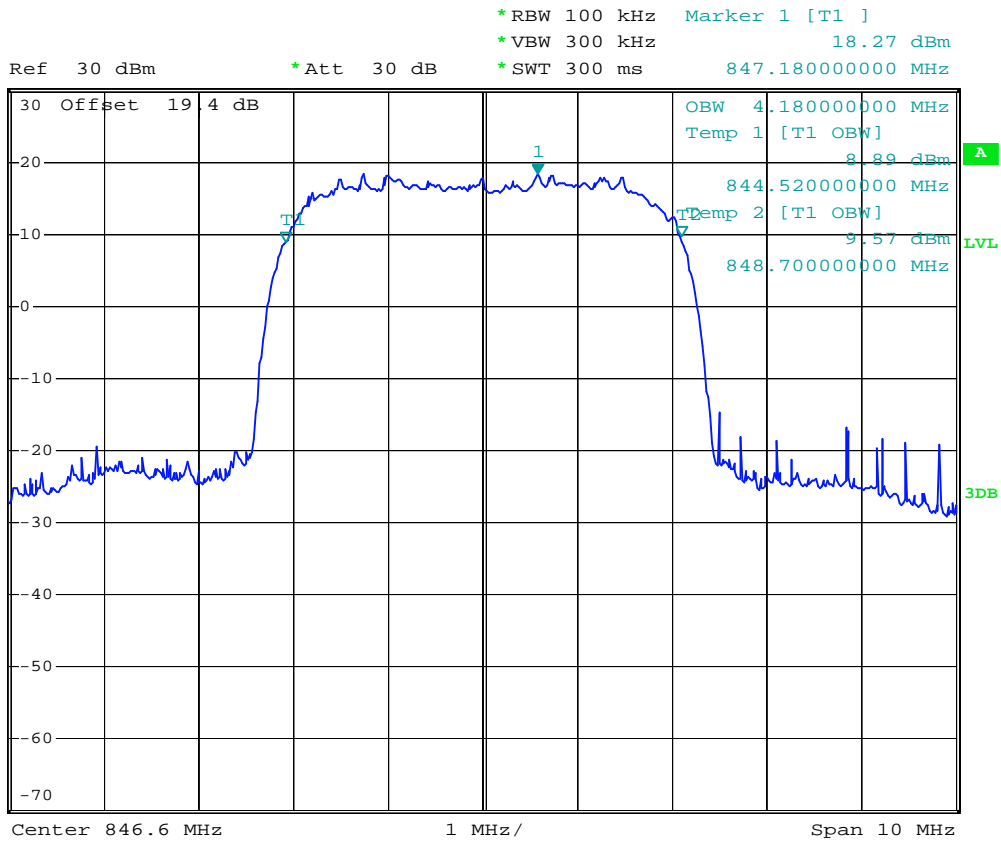

Date: 17.FEB.2008 16:43:21



- Test Mode : WCDMA Band V CH4132 26dB Bandwidth
- Power State : High

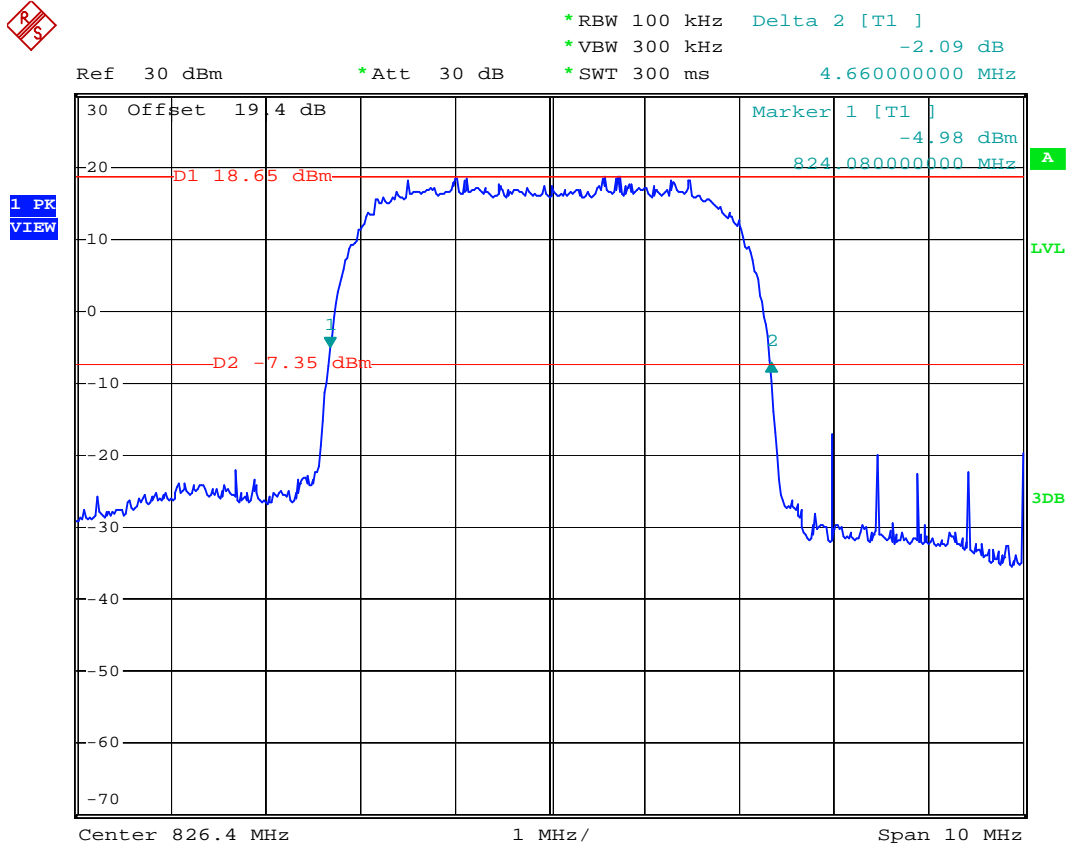

Date: 17.FEB.2008 16:34:39



- Test Mode : WCDMA Band V CH4182 26dB Bandwidth
- Power State : High



*RBW 100 kHz Delta 2 [T1]
 *VBW 300 kHz 2.50 dB
 *SWT 300 ms 4.640000000 MHz

Ref 30 dBm

*Att 30 dB

1 PK*
VIEW

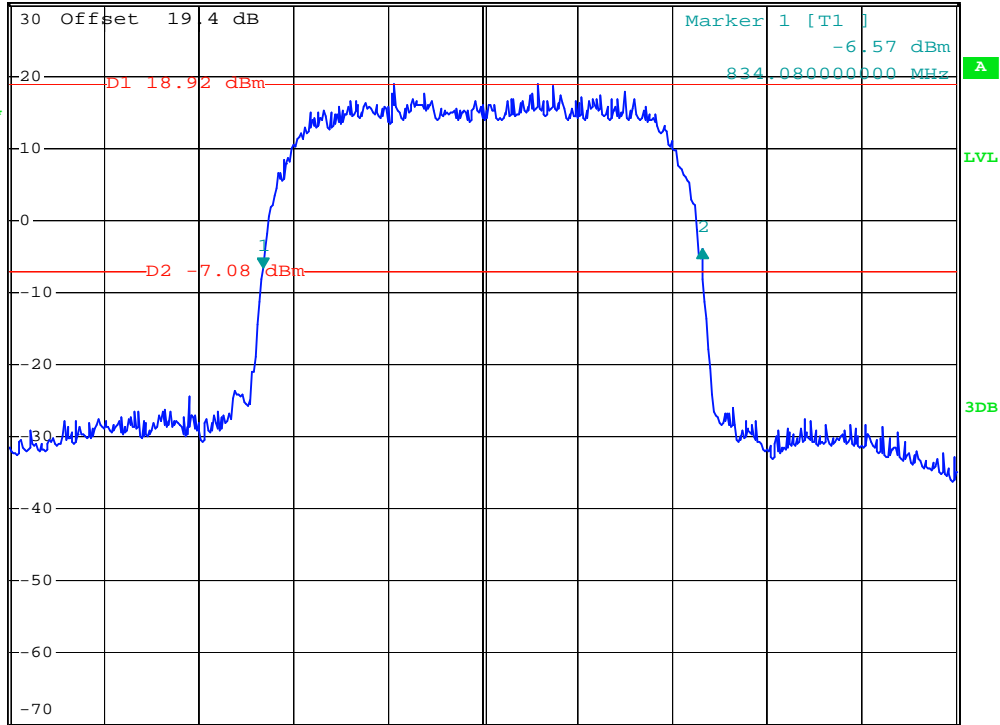

Center 836.4 MHz

1 MHz/

Span 10 MHz

Date: 17.FEB.2008 16:36:16



- Test Mode : WCDMA Band V CH4233 26dB Bandwidth
- Power State : High



*RBW 100 kHz Delta 2 [T1]
 *VBW 300 kHz -0.23 dB
 *SWT 300 ms 4.640000000 MHz

Ref 30 dBm

*Att 30 dB

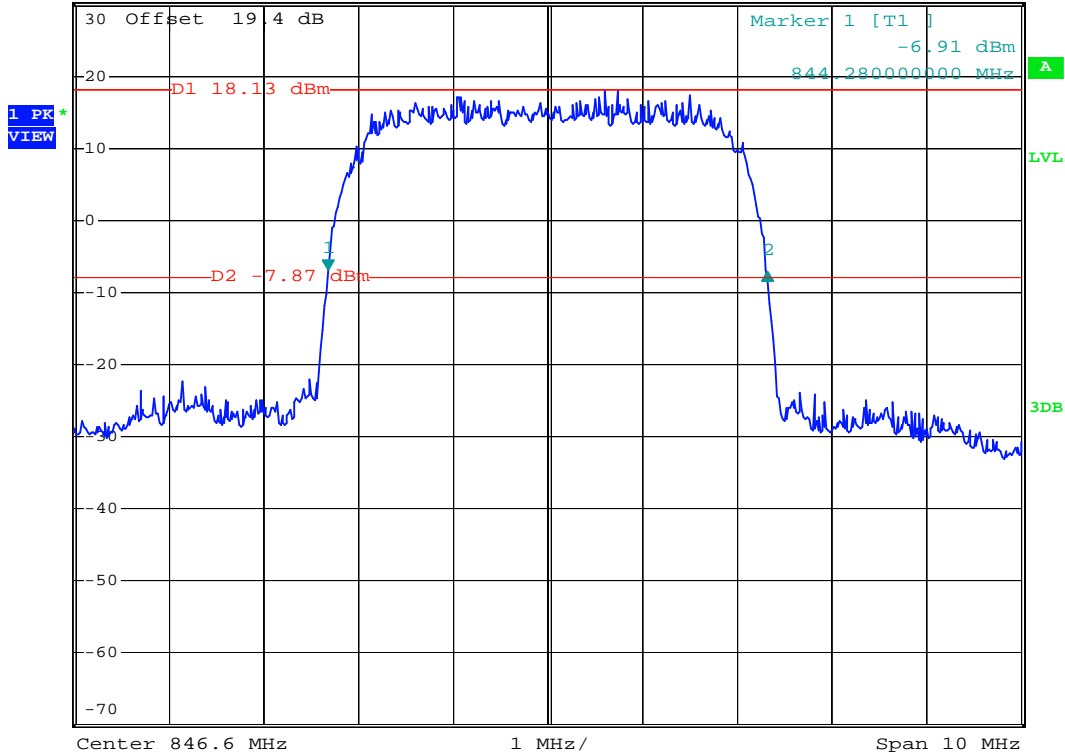

Date: 17.FEB.2008 16:37:45



- Test Mode : WCDMA Band V CH4233 Higher Band Edge
- Power State : High



Ref 30 dBm *Att 30 dB *RBW 100 kHz Marker 1 [T1]
*VBW 100 kHz -28.25 dBm
*SWT 300 ms 849.01000000 MHz

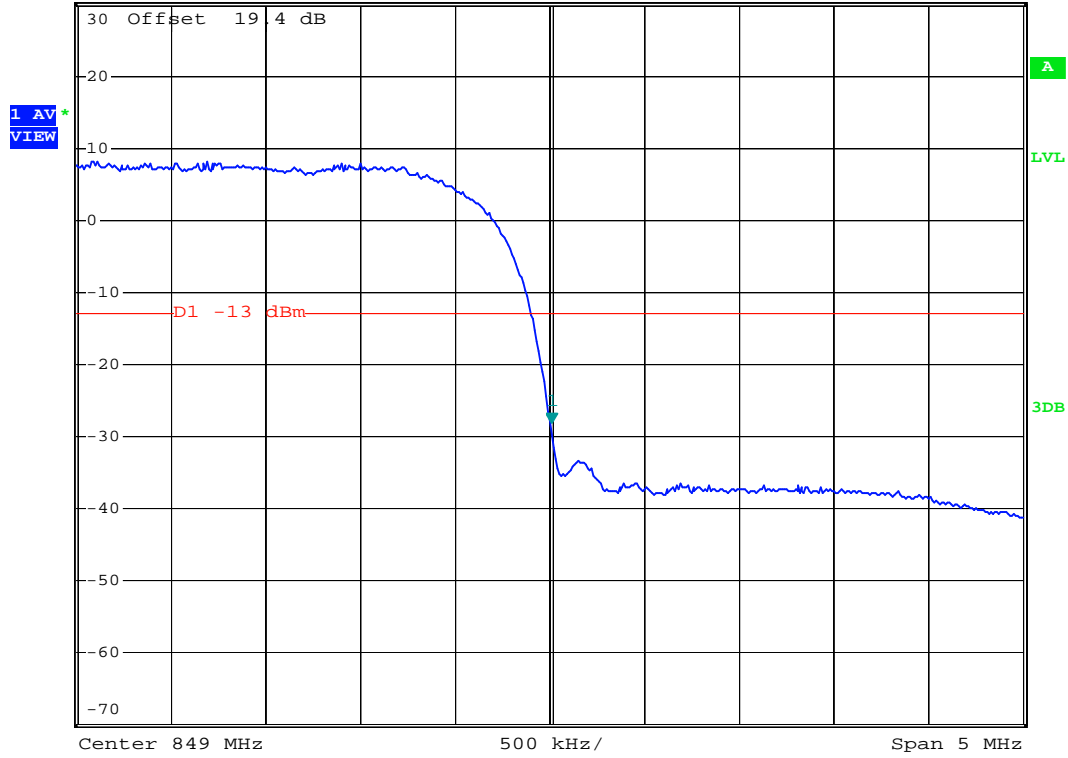

Date: 17.FEB.2008 17:02:37



- Mode 6
- Test Mode : WCDMA Band V (HSDPA) CH4132 Lower Band Edge
- Power State : High



Ref 30 dBm *Att 30 dB *RBW 100 kHz Marker 1 [T1]
*VBW 100 kHz -27.20 dBm
*SWT 300 ms 823.99000000 MHz

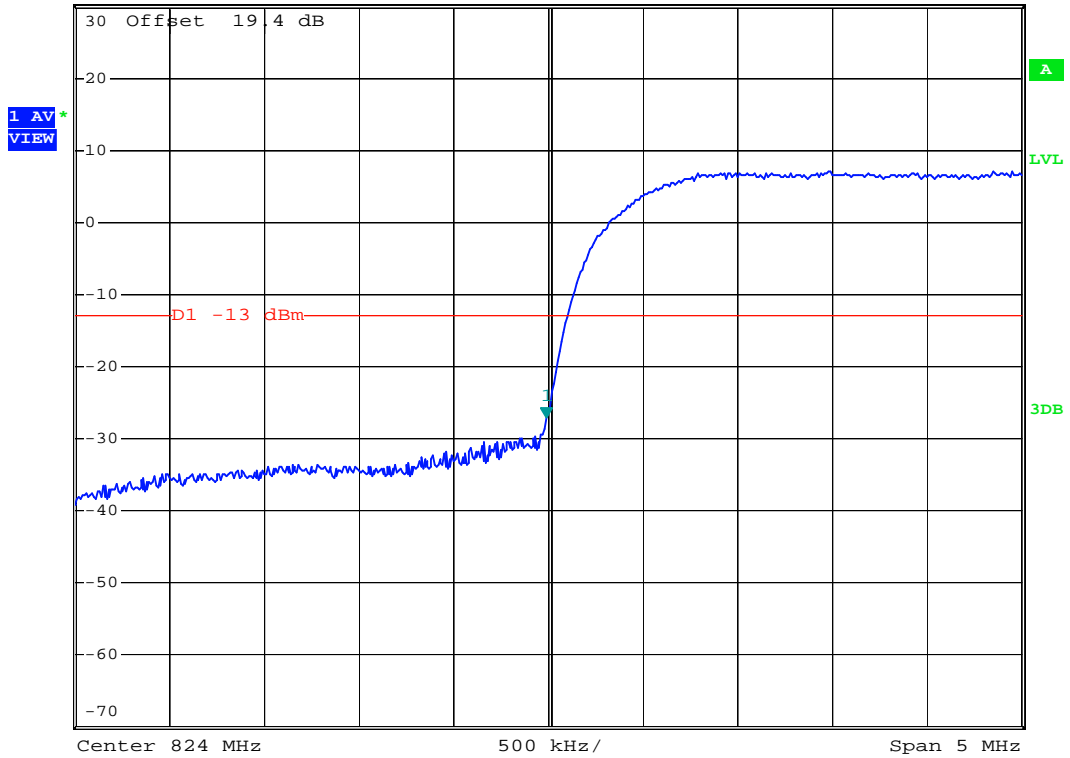

Date: 17.FEB.2008 17:32:12



Test Mode : WCDMA Band V (HSDPA) CH4132 99% Occupied Bandwidth

- Power State : High

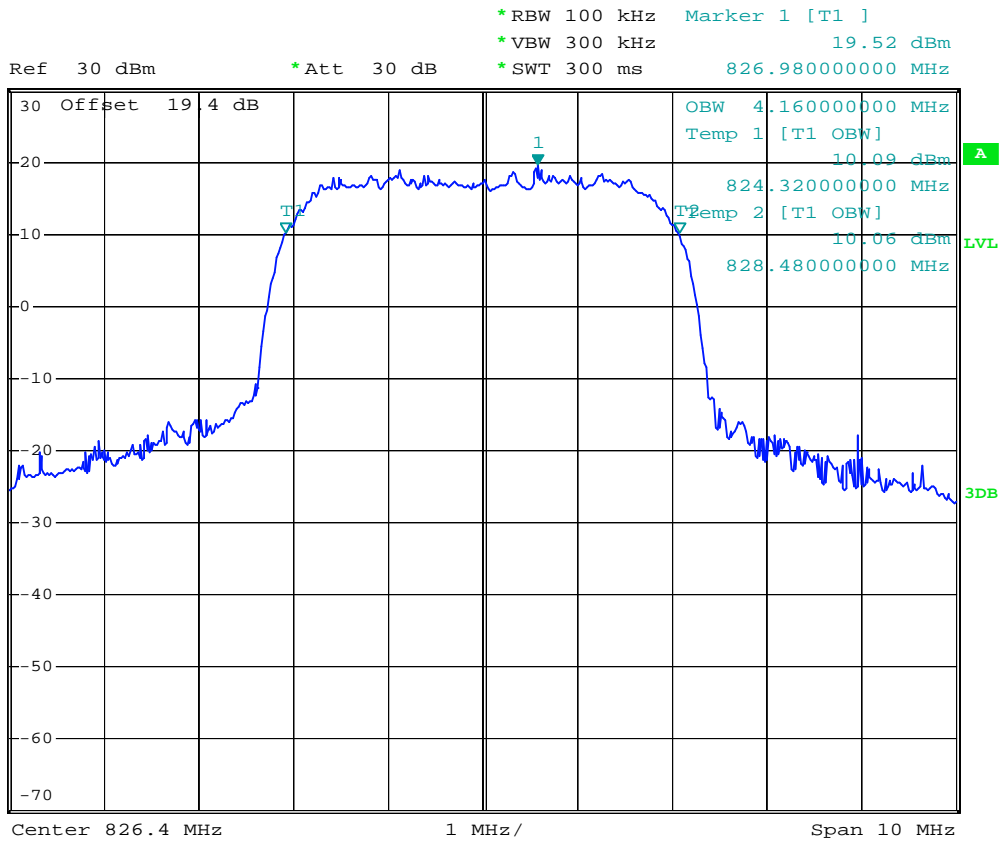

Date: 17.FEB.2008 17:36:57



- Test Mode : WCDMA Band V (HSDPA) CH4182 99% Occupied Bandwidth
- Power State : High

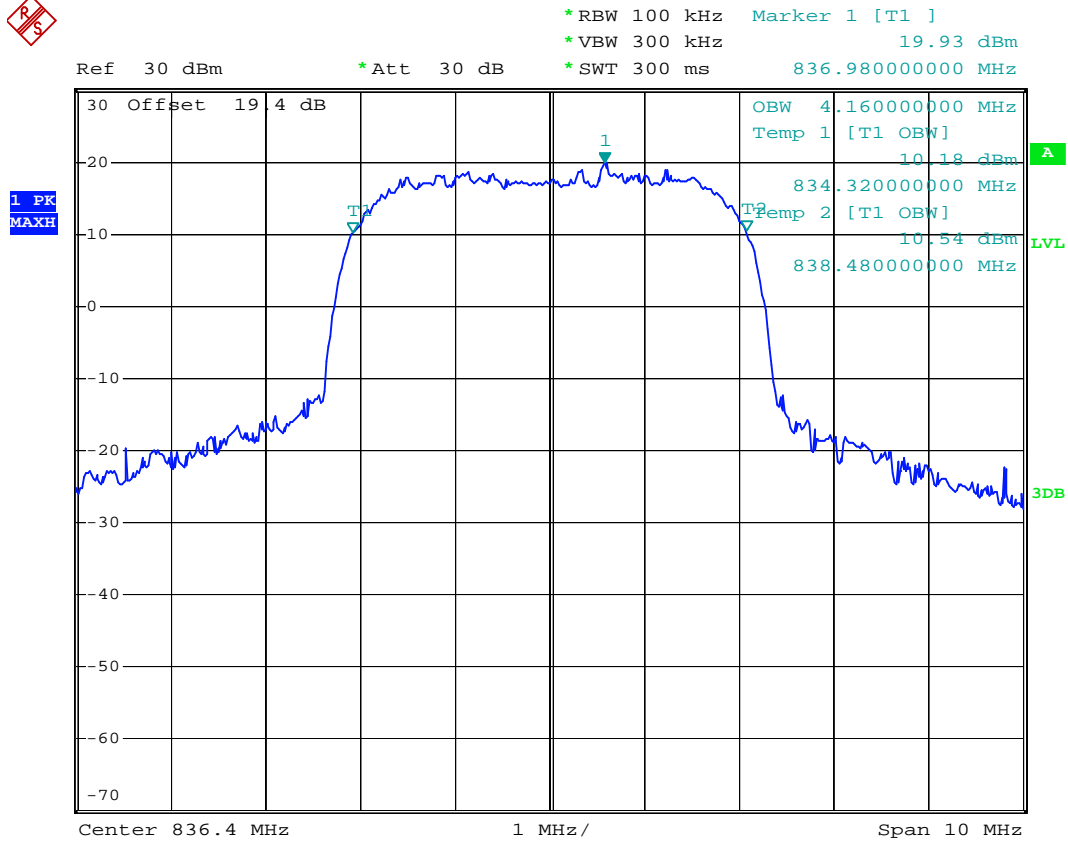

Date: 17.FEB.2008 17:36:23



- Test Mode : WCDMA Band V (HSDPA) CH4233 99% Occupied Bandwidth
- Power State : High

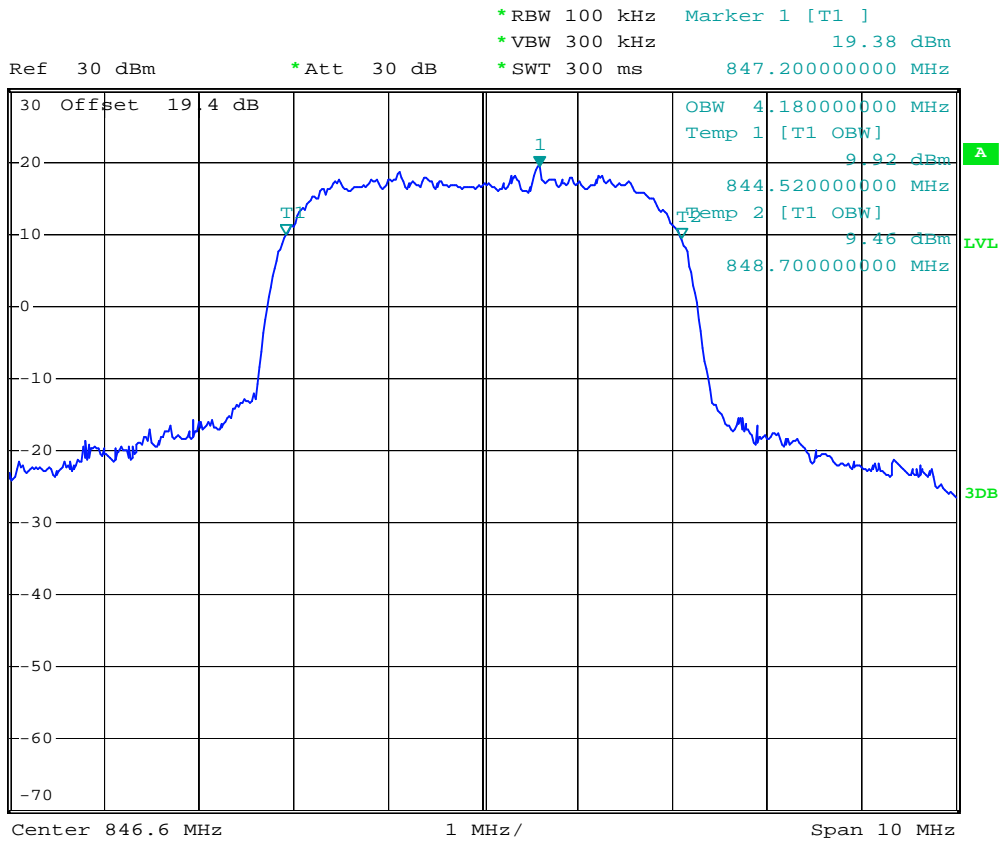

Date: 17.FEB.2008 17:35:46



- Test Mode : WCDMA Band V (HSDPA) CH4132 26dB Bandwidth
- Power State : High



*RBW 100 kHz Delta 2 [T1]
 *VBW 300 kHz 1.96 dB
 *SWT 300 ms 4.660000000 MHz

Ref 30 dBm

*Att 30 dB

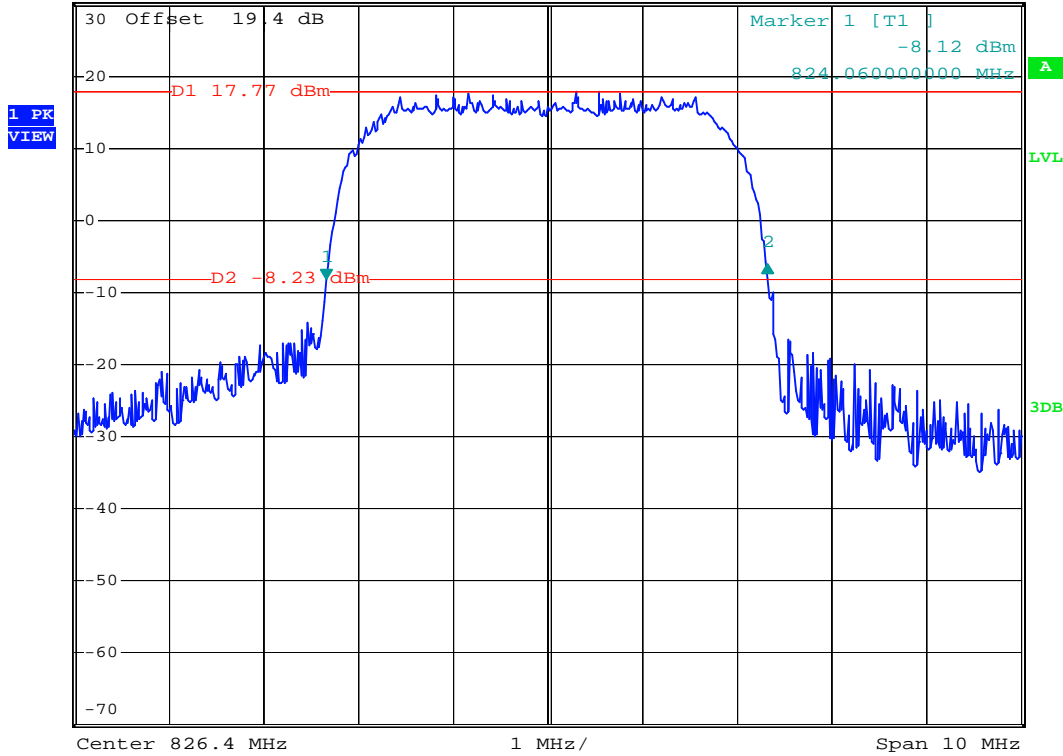

Date: 17.FEB.2008 17:28:01



- Test Mode : WCDMA Band V (HSDPA) CH4182 26dB Bandwidth
- Power State : High

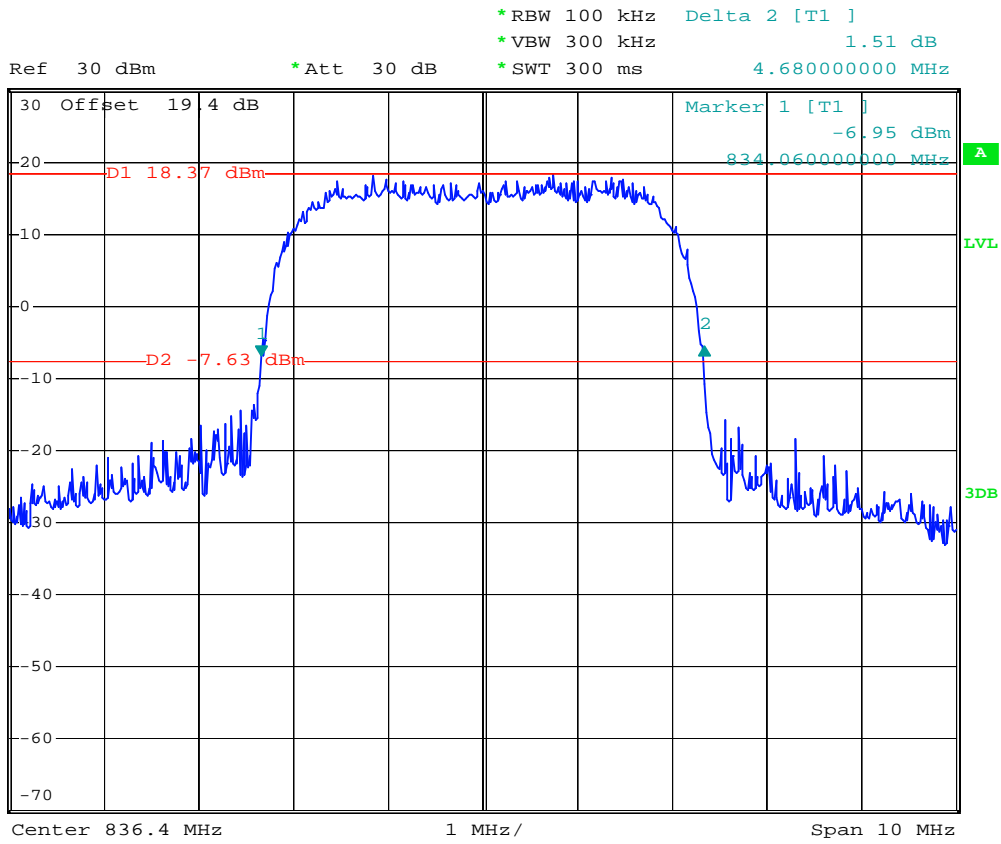

Date: 17.FEB.2008 17:29:07



- Test Mode : WCDMA Band V (HSDPA) CH4233 26dB Bandwidth
- Power State : High

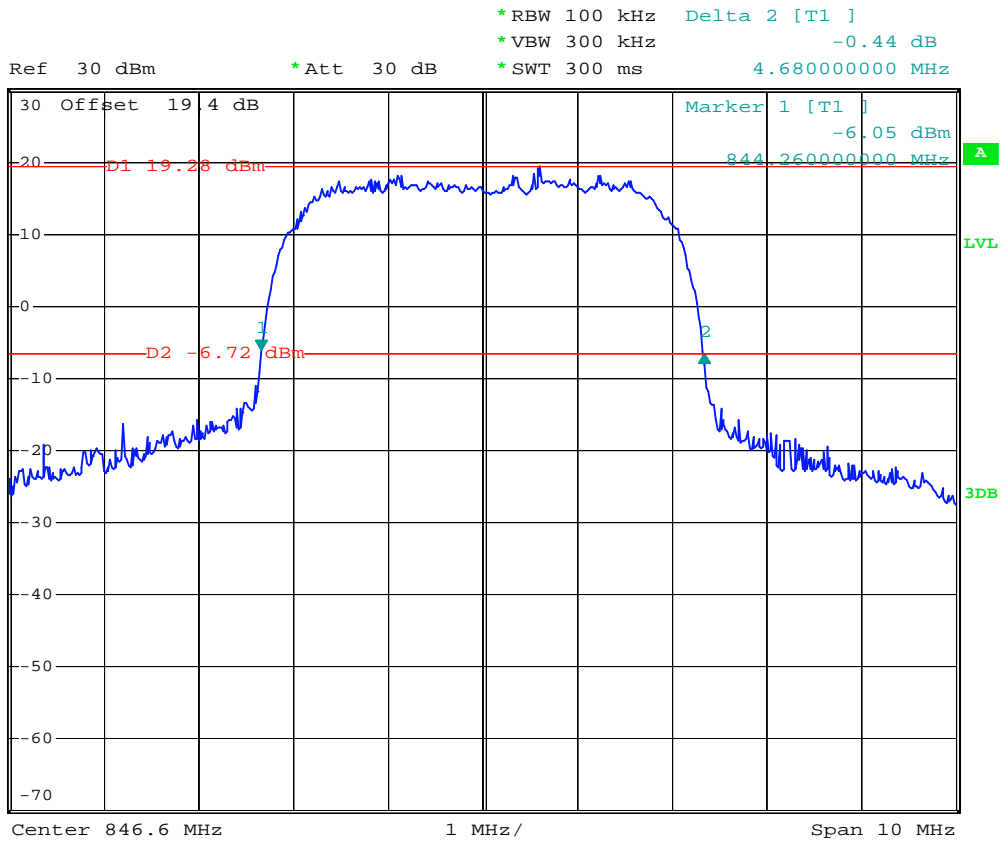

Date: 17.FEB.2008 17:30:11



- Test Mode : WCDMA Band V (HSDPA) CH4233 Higher Band Edge
- Power State : High

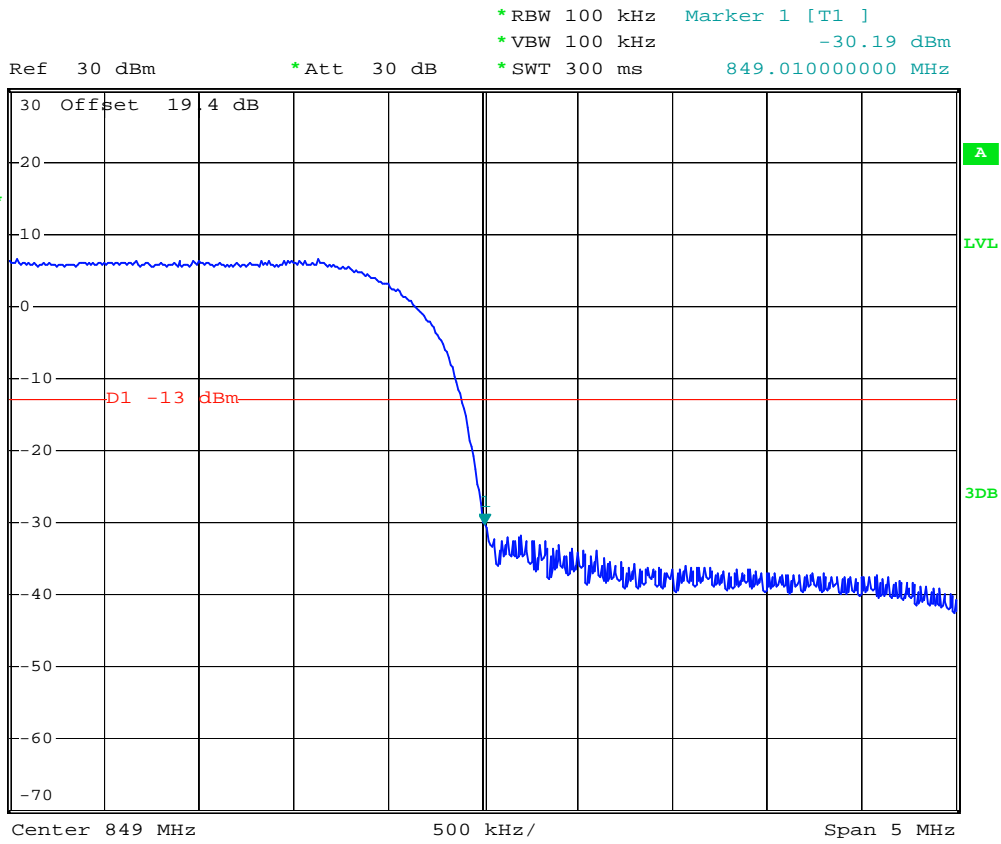

Date: 17.FEB.2008 17:31:33



- Test Mode : WCDMA Band II CH9400 99% Occupid Bandwidth
- Power State : High

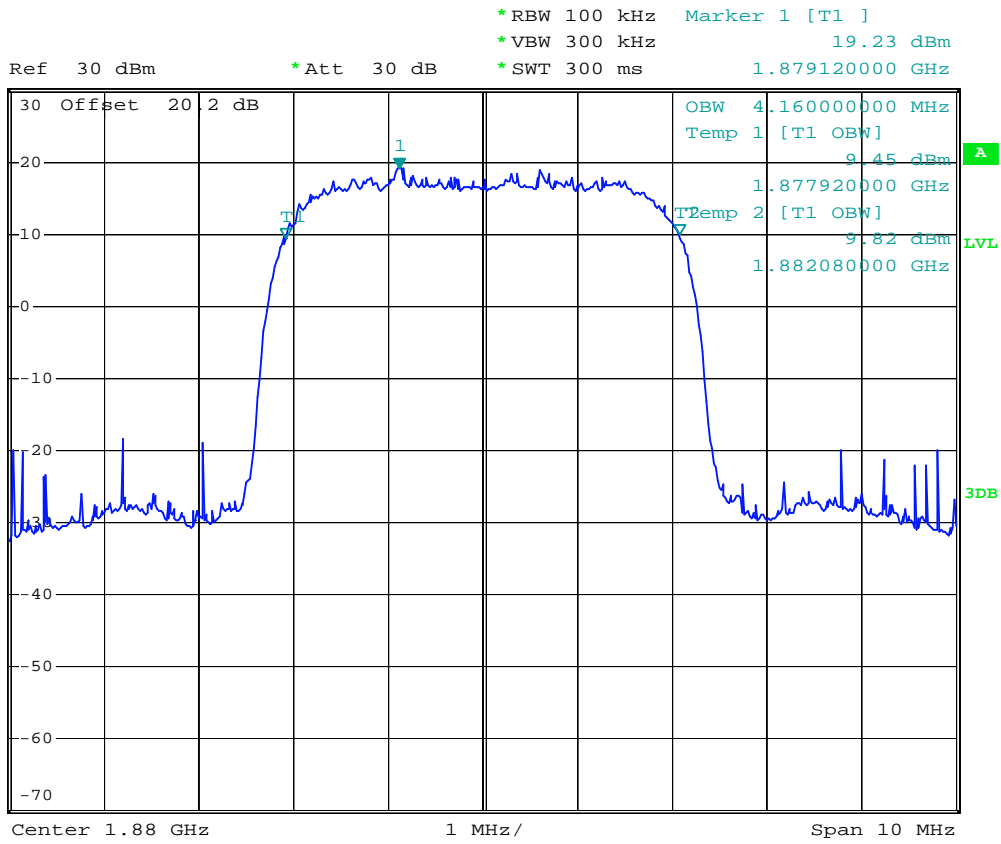

Date: 2.MAR.2008 12:56:47



- Test Mode : WCDMA Band II CH9262 26dB Bandwidth
- Power State : High



*RBW 100 kHz Delta 2 [T1]
 *VBW 300 kHz 1.08 dB
 *SWT 300 ms 4.640000000 MHz

Ref 30 dBm

*Att 30 dB

1 PK VIEW

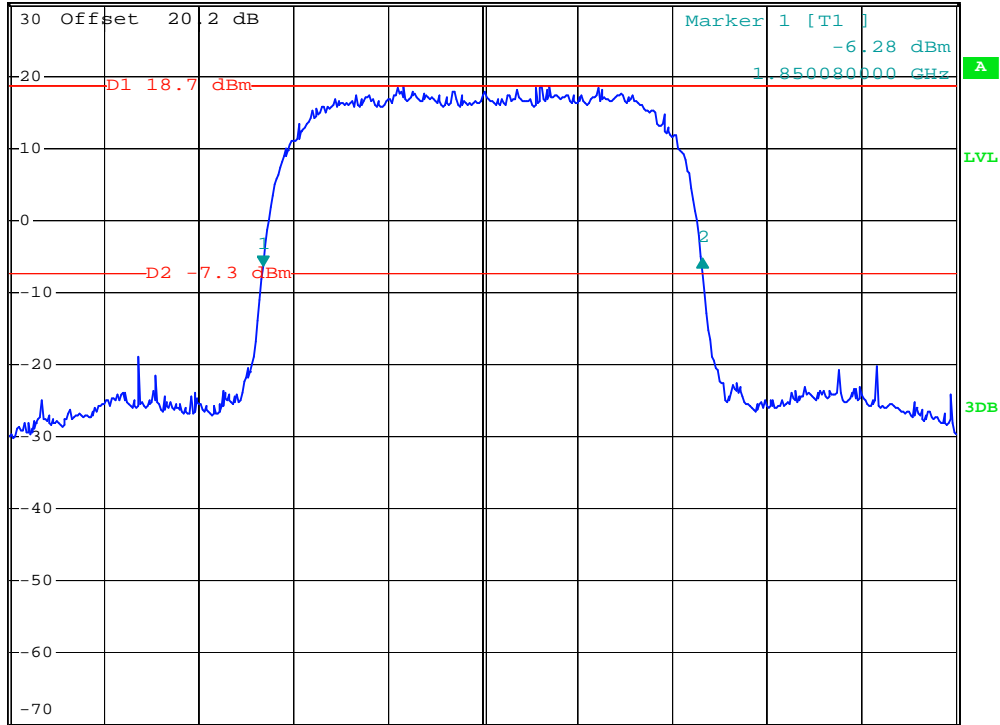

Center 1.8524 GHz

1 MHz/

Span 10 MHz

Date: 2.MAR.2008 12:49:40



- Test Mode : WCDMA Band II CH9400 26dB Bandwidth
- Power State : High



*RBW 100 kHz Delta 2 [T1]
 *VBW 300 kHz 0.67 dB
 *SWT 300 ms 4.660000000 MHz

Ref 30 dBm

*Att 30 dB

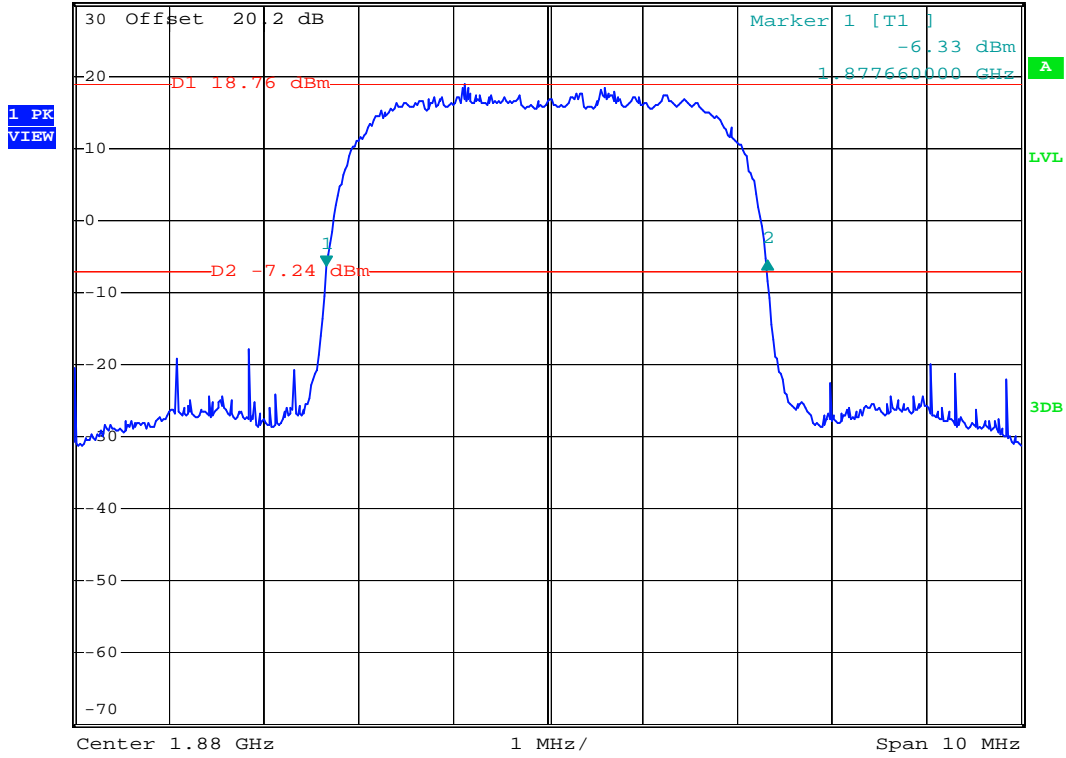

Date: 2.MAR.2008 12:50:32



- Test Mode : WCDMA Band II CH9538 26dB Bandwidth
- Power State : High

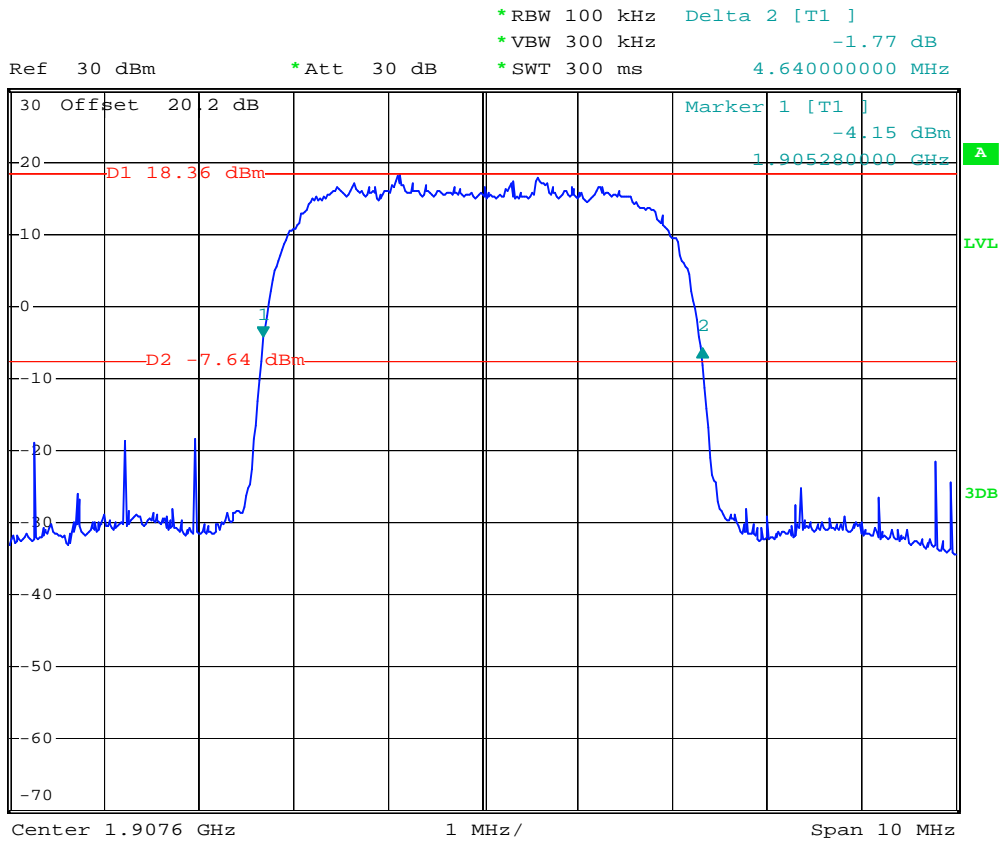

Date: 2.MAR.2008 12:54:24



- Test Mode : WCDMA Band II CH9538 Higher Band Edge
- Power State : High

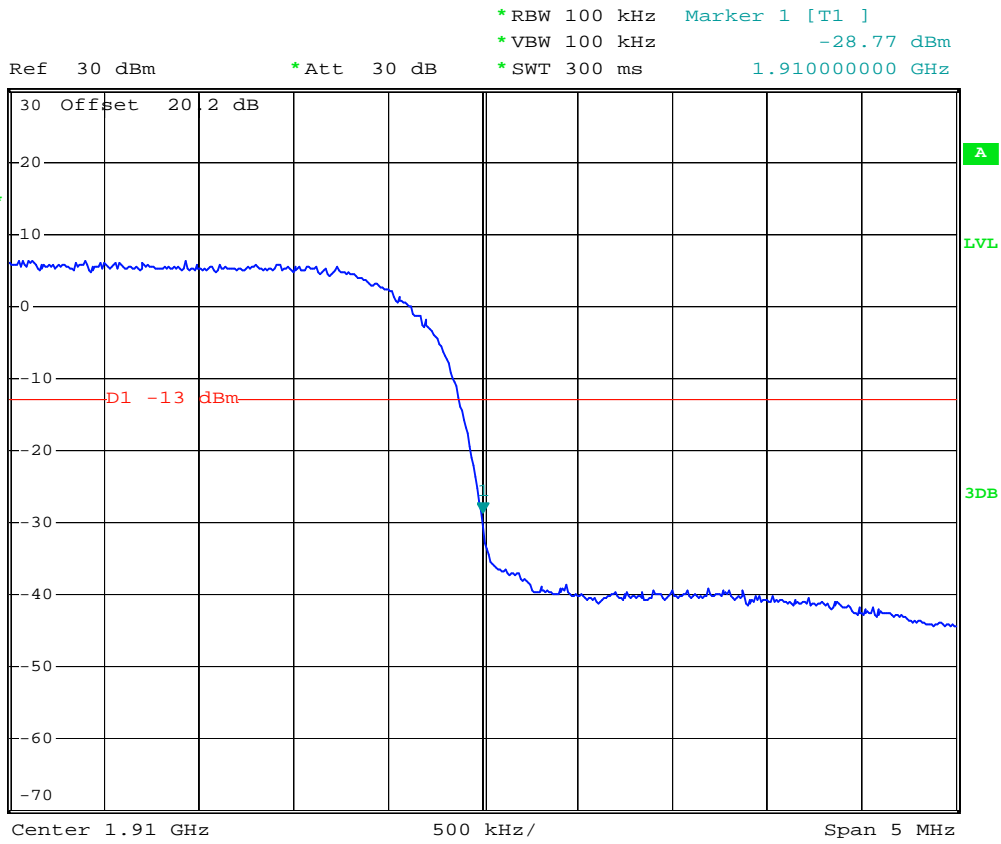

Date: 2.MAR.2008 13:06:41



- Mode 8
- Test Mode : WCDMA Band II (HSDPA) CH9262 Lower Band Edge
- Power State : High



Ref 30 dBm *Att 30 dB *RBW 100 kHz Marker 1 [T1]
*VBW 100 kHz -27.36 dBm
*SWT 300 ms 1.85000000 GHz

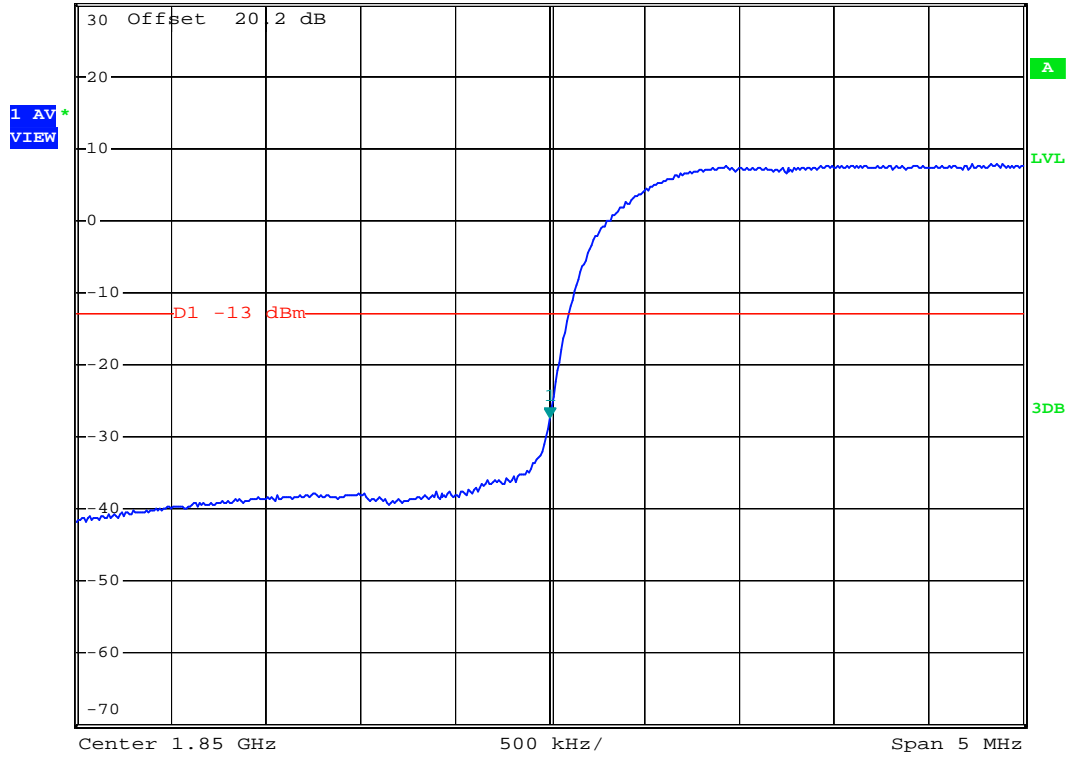

Date: 2.MAR.2008 13:22:25



- Test Mode : WCDMA Band II (HSDPA) CH9262 26dB Bandwidth
- Power State : High

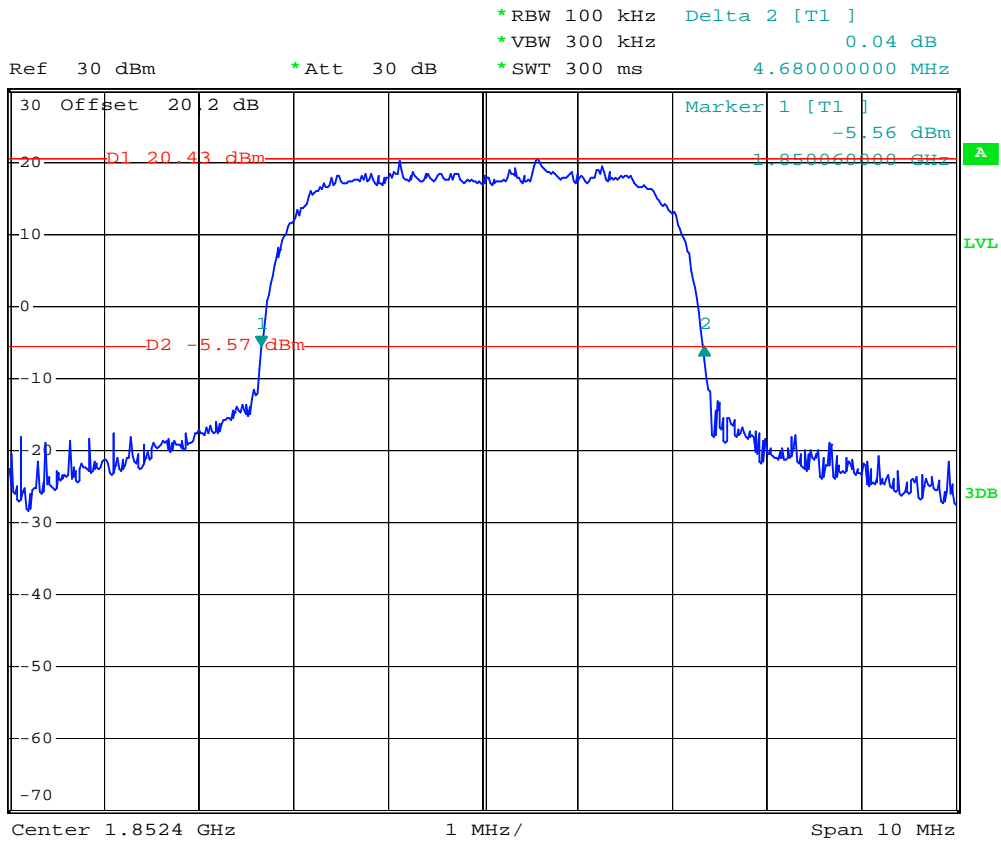

Date: 2.MAR.2008 13:17:31



- Test Mode : WCDMA Band II (HSDPA) CH9400 26dB Bandwidth
- Power State : High

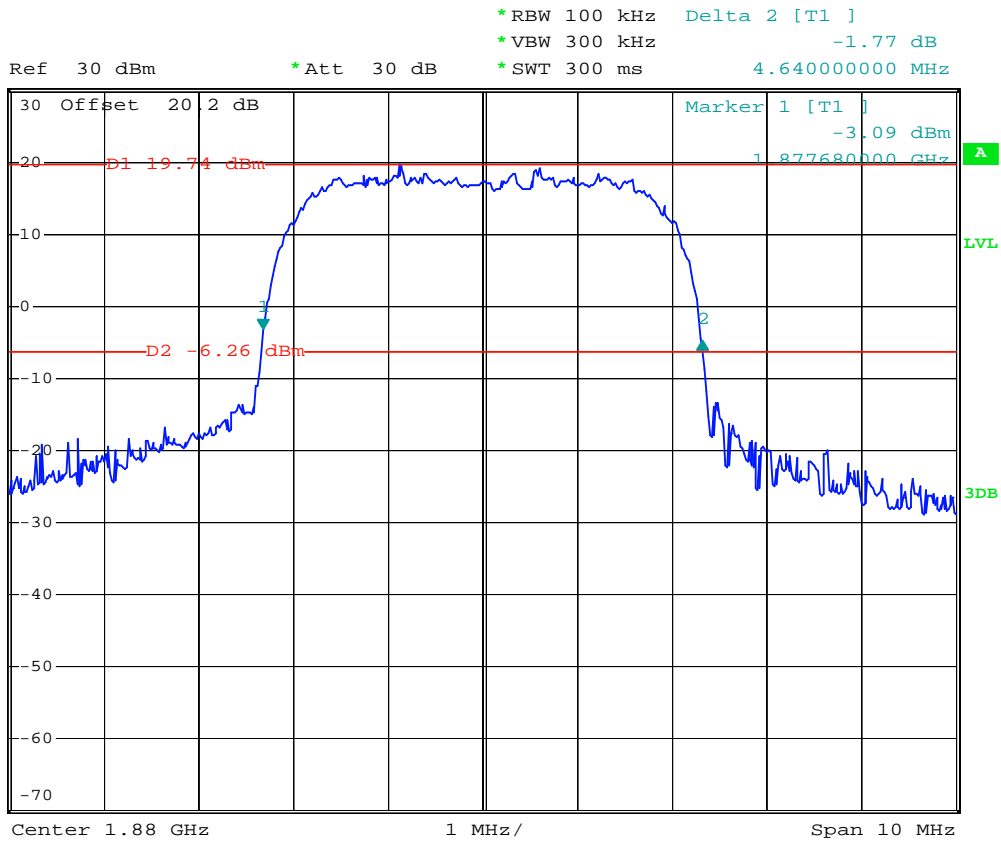

Date: 2.MAR.2008 13:18:30



- Test Mode : WCDMA Band II (HSDPA) CH9538 26dB Bandwidth
- Power State : High

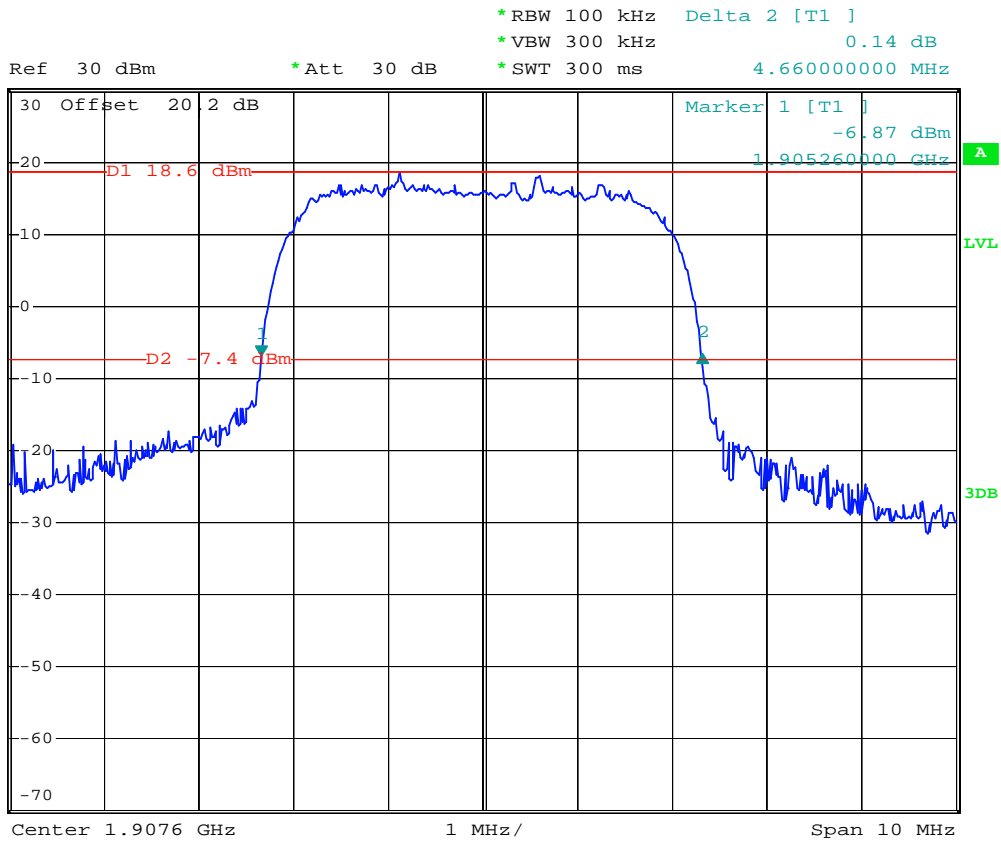

Date: 2.MAR.2008 13:19:35



- Test Mode : WCDMA Band II (HSDPA) CH9538 Higher Band Edge
- Power State : High

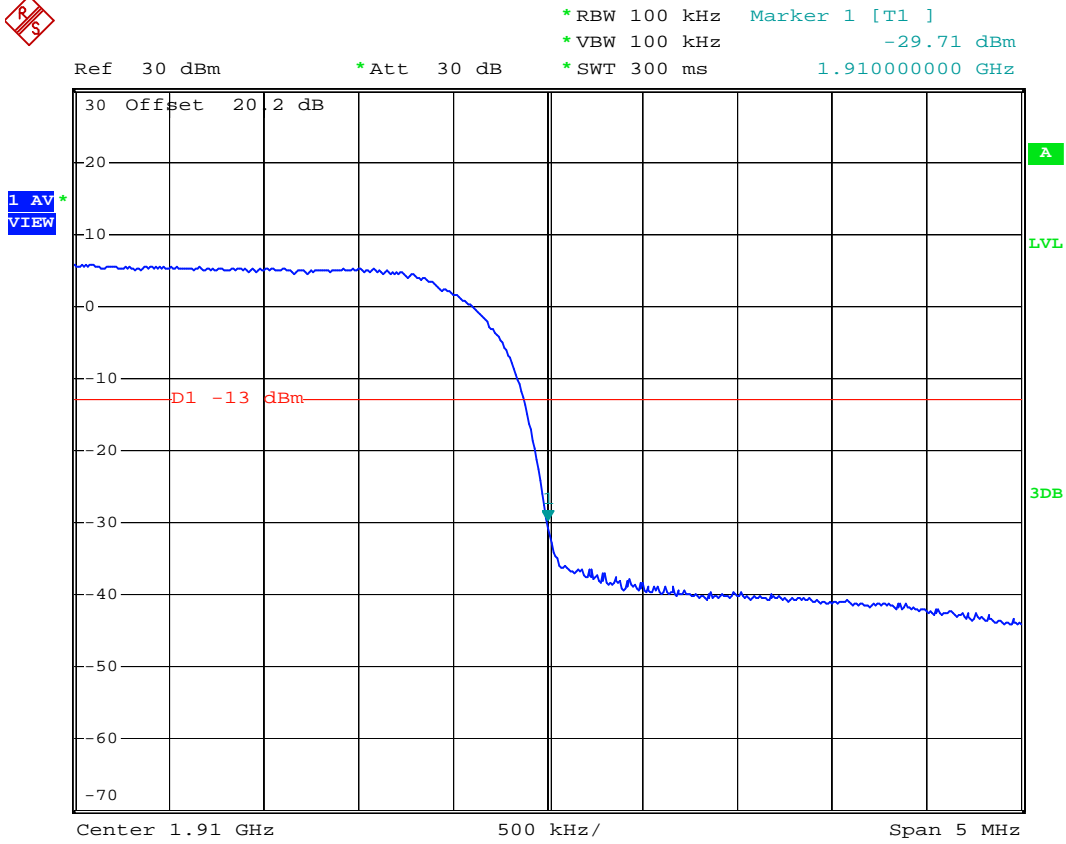

Date: 2.MAR.2008 13:22:53

4.5 Conducted Emission

4.5.1 Measurement Instruments

As described in chapter 5 of this test report.

4.5.2 Test Procedure

- a. The EUT was connected to Spectrum Analyzer and Base Station via power divider.
- b. The middle channel for the highest RF power within the transmitting frequency was measured.
- c. The conducted spurious emission for the whole frequency range was taken.

4.5.3 Test Setup Layout

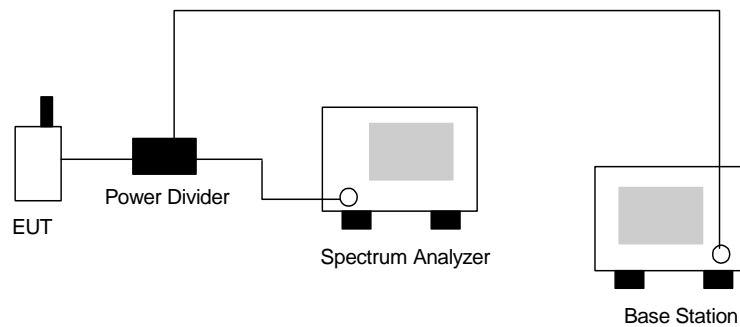



4.5.4 Test Result

- Mode 1
- Test Mode : GSM850 (GSM) CH189
- Frequency Range : 30M-1G

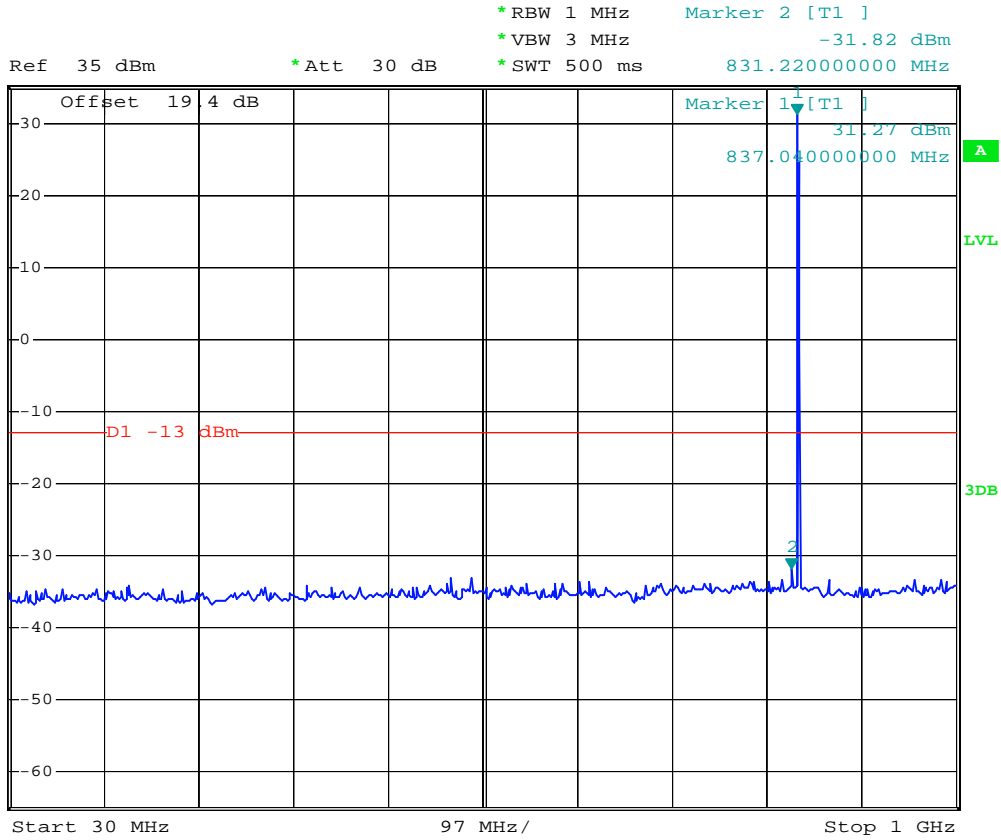

Date: 9.MAR.2008 01:26:57



- Test Mode : GSM850 (GSM) CH189
- Frequency Range : 1G-3G



Ref 0 dBm *Att 0 dB *RBW 1 MHz Marker 1 [T1]
 *VBW 3 MHz -38.62 dBm
 *SWT 500 ms 2.512000000 GHz

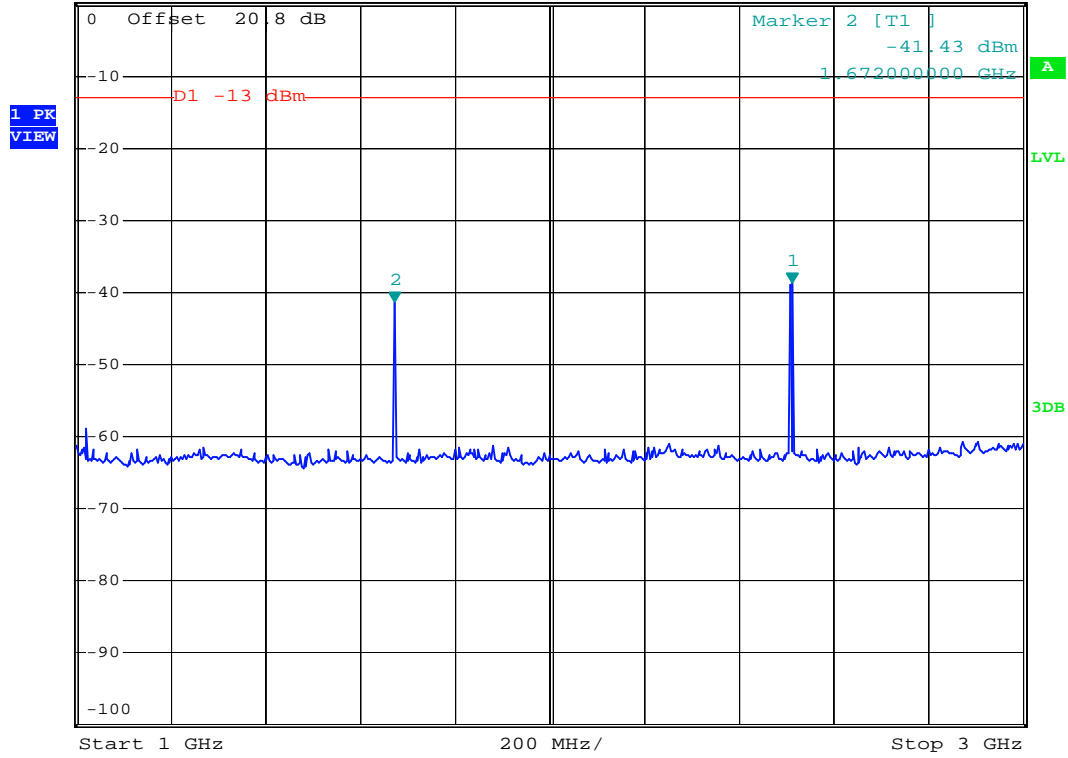

Date: 2.MAR.2008 15:27:05



- Test Mode : GSM850 (GSM) CH189
- Frequency Range : 3G-7G



*RBW 1 MHz Marker 1 [T1]
 *VBW 3 MHz -43.26 dBm
 *SWT 500 ms 4.184000000 GHz

Ref 0 dBm

*Att 0 dB

1 PK
VIEW

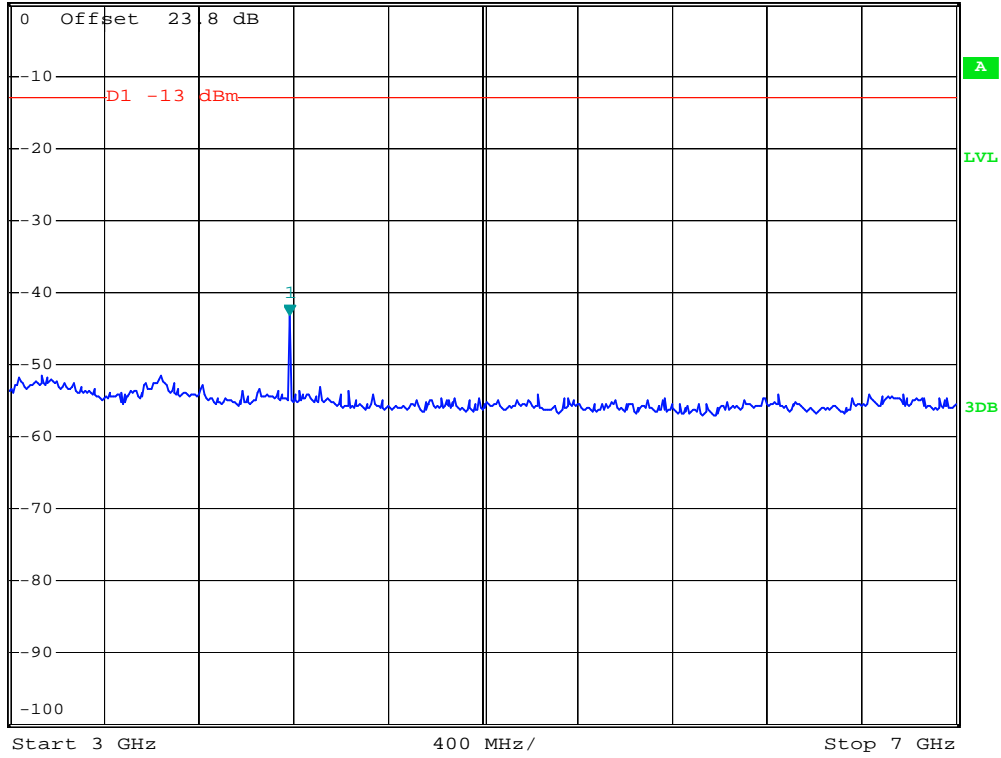

Date: 17.FEB.2008 11:31:10



- Test Mode : GSM850 (GSM) CH189
- Frequency Range : 7G-9G

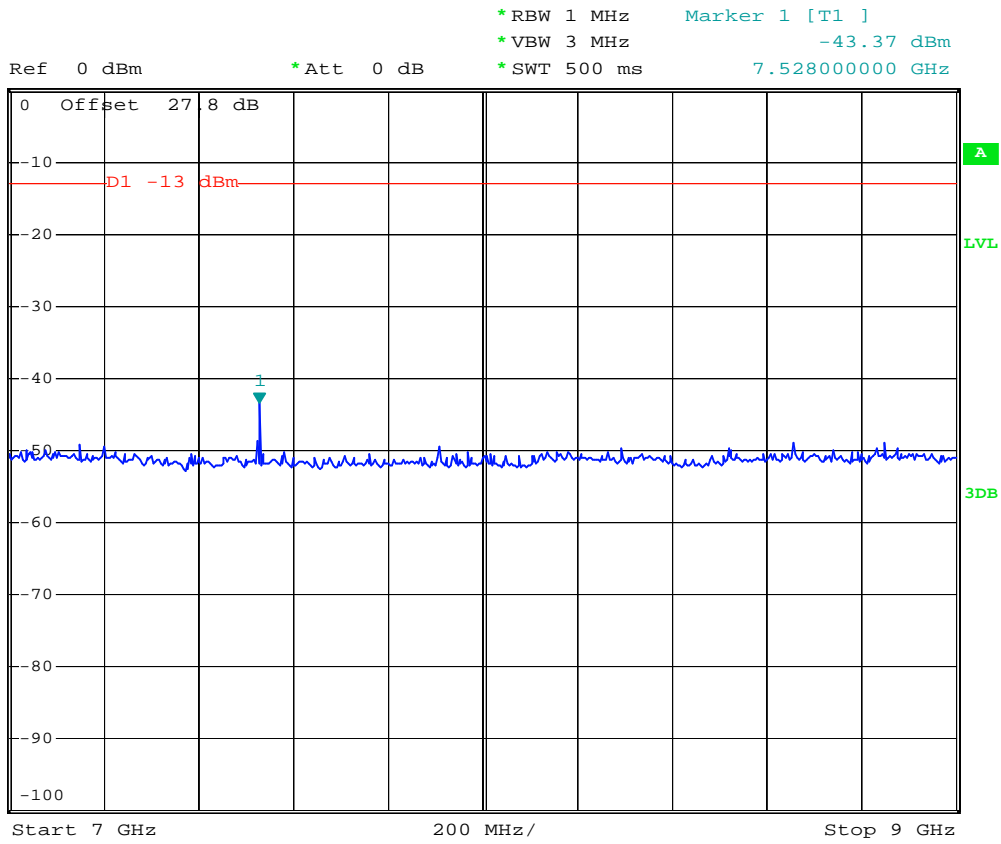

Date: 17.FEB.2008 11:32:04



- Mode 2
- Test Mode : GSM850 (EDGE) CH189
- Frequency Range : 30M-1G



Ref 35 dBm *Att 30 dB *RBW 1 MHz Marker 2 [T1]
 *VBW 3 MHz -32.78 dBm
 *SWT 500 ms 695.420000000 MHz

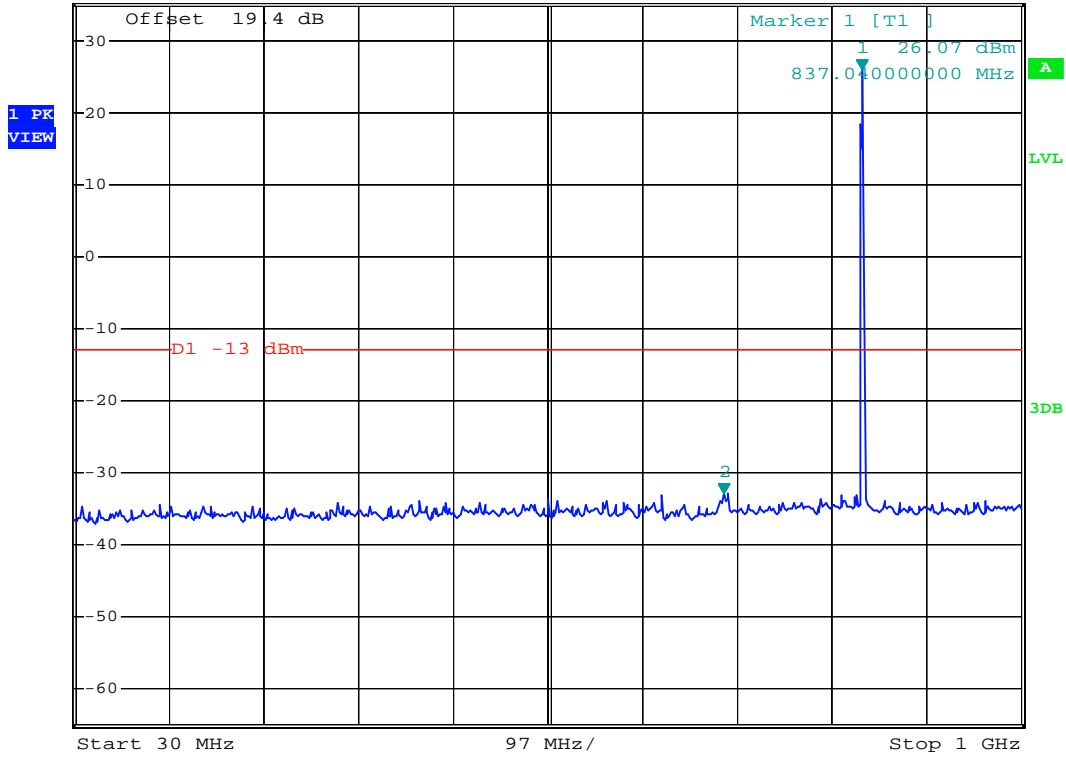

Date: 2.MAR.2008 15:35:08



- Test Mode : GSM850 (EDGE) CH189
- Frequency Range : 1G-3G



Ref 0 dBm *Att 0 dB *RBW 1 MHz Marker 2 [T1]
 *VBW 3 MHz -45.44 dBm
 *SWT 500 ms 1.672000000 GHz

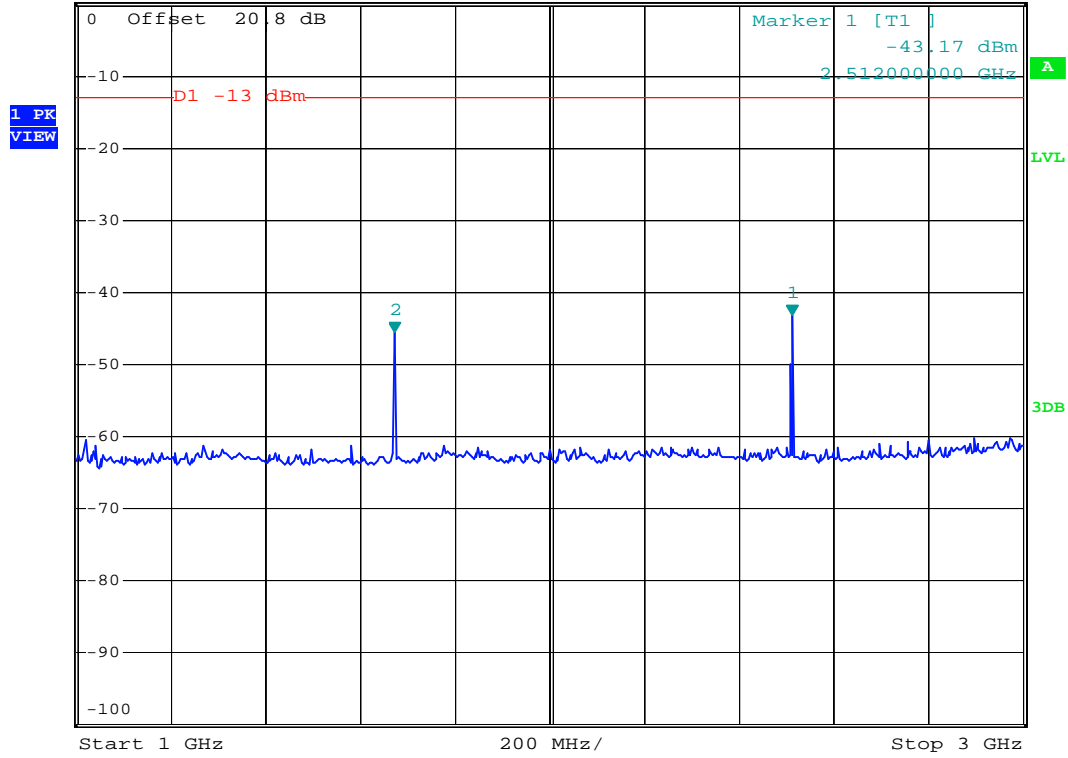

Date: 2.MAR.2008 15:28:38



- Test Mode : GSM850 (EDGE) CH189
- Frequency Range : 3G-7G

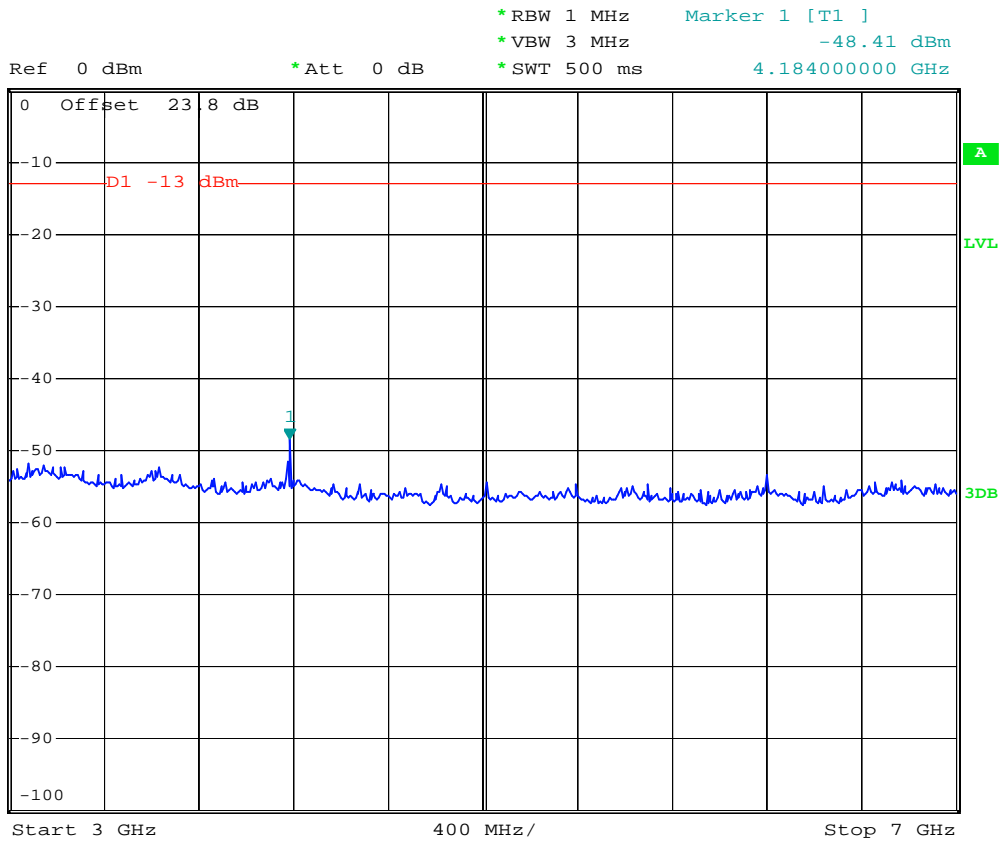

Date: 17.FEB.2008 12:34:59



- Test Mode : GSM850 (EDGE) CH189
- Frequency Range : 7G-9G

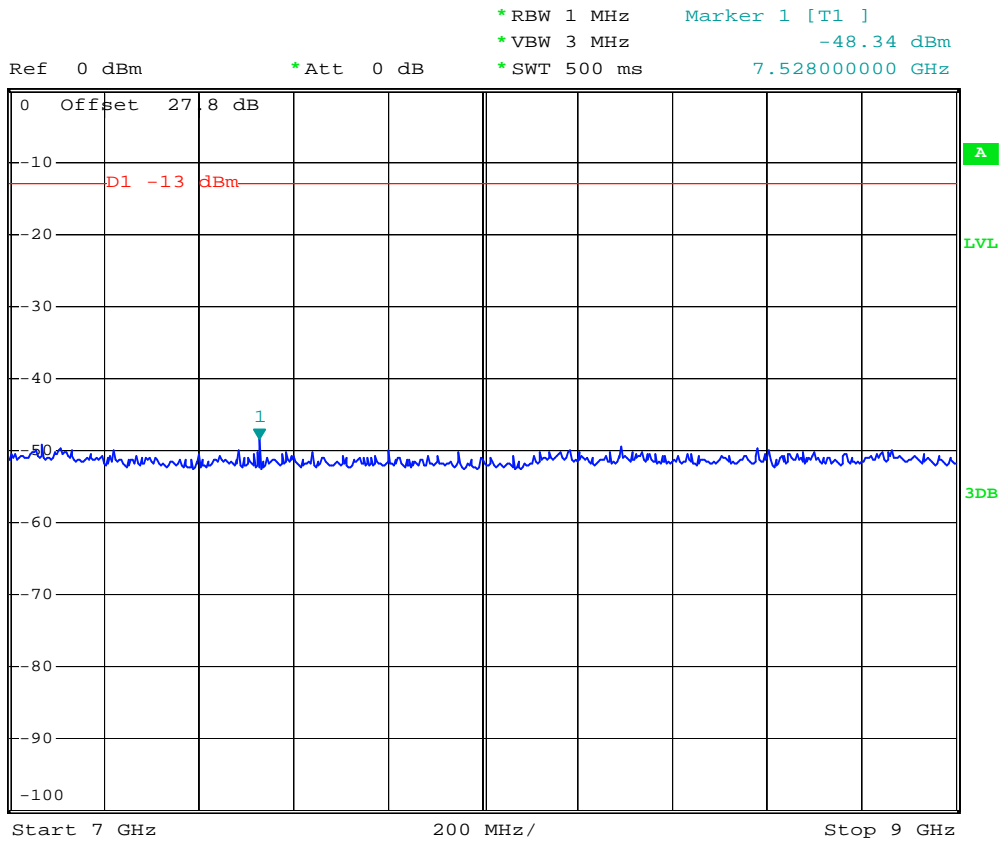

Date: 17.FEB.2008 12:27:31



- Test Mode : PCS1900 (GSM) CH661
- Frequency Range : 1G-3G



Ref 35 dBm *Att 30 dB *RBW 1 MHz Marker 2 [T1]
 *VBW 3 MHz -30.63 dBm
 *SWT 500 ms 2.288000000 GHz

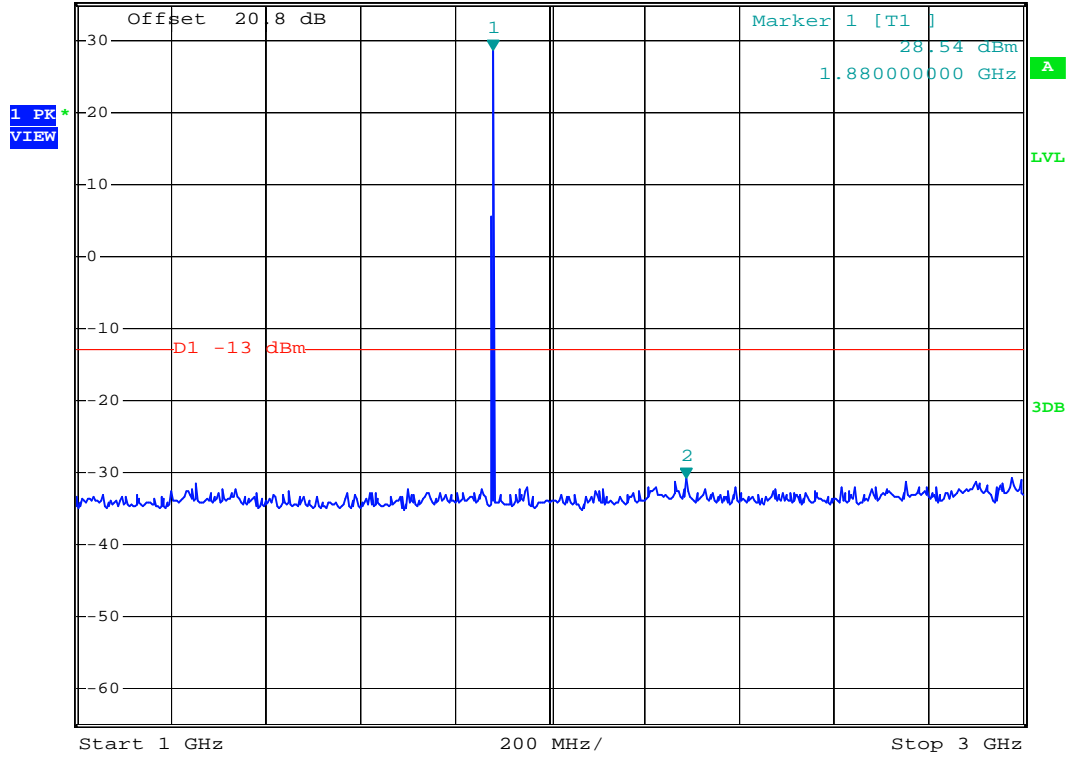

Date: 7.MAR.2008 05:13:58



- Test Mode : PCS1900 (GSM) CH661
- Frequency Range : 3G-7G



*RBW 1 MHz Marker 4 [T1]
 *VBW 3 MHz -53.02 dBm
 *Att 0 dB 6.560000000 GHz
 *SWT 500 ms

Ref 0 dBm

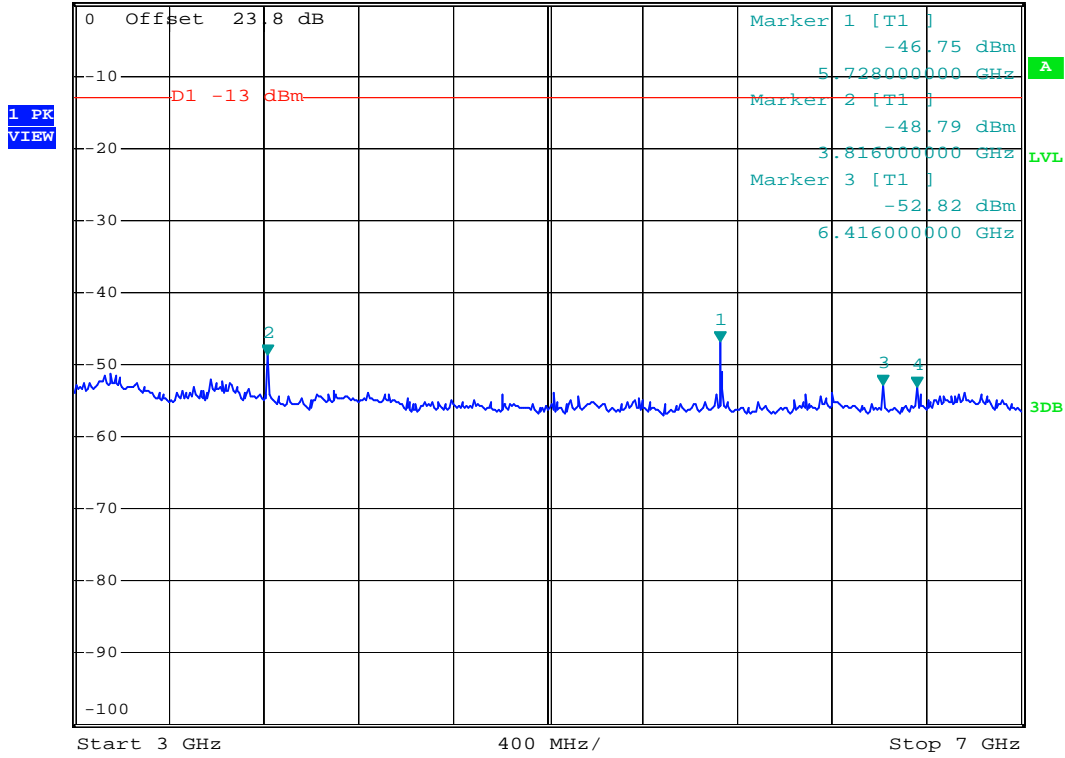

Date: 17.FEB.2008 15:39:01



- Test Mode : PCS1900 (GSM) CH661
- Frequency Range : 7G-13.6G

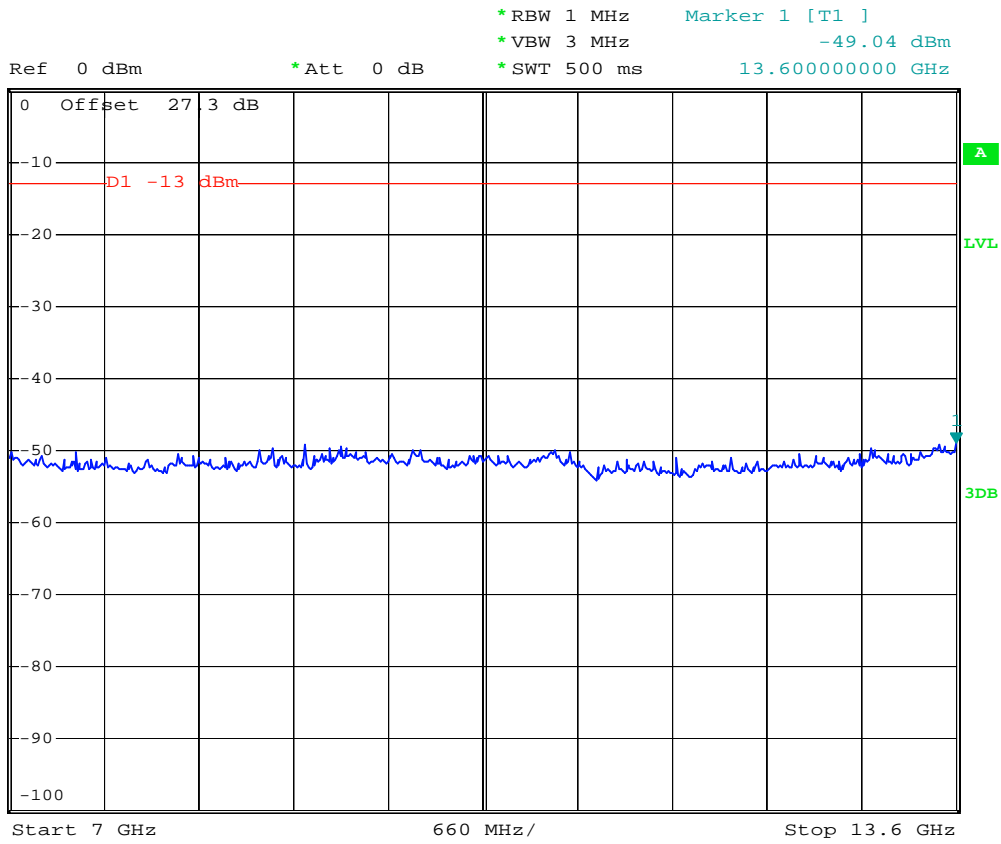

Date: 17.FEB.2008 15:40:31



- Test Mode : PCS1900 (GSM) CH661
- Frequency Range : 13.6G-19.1G

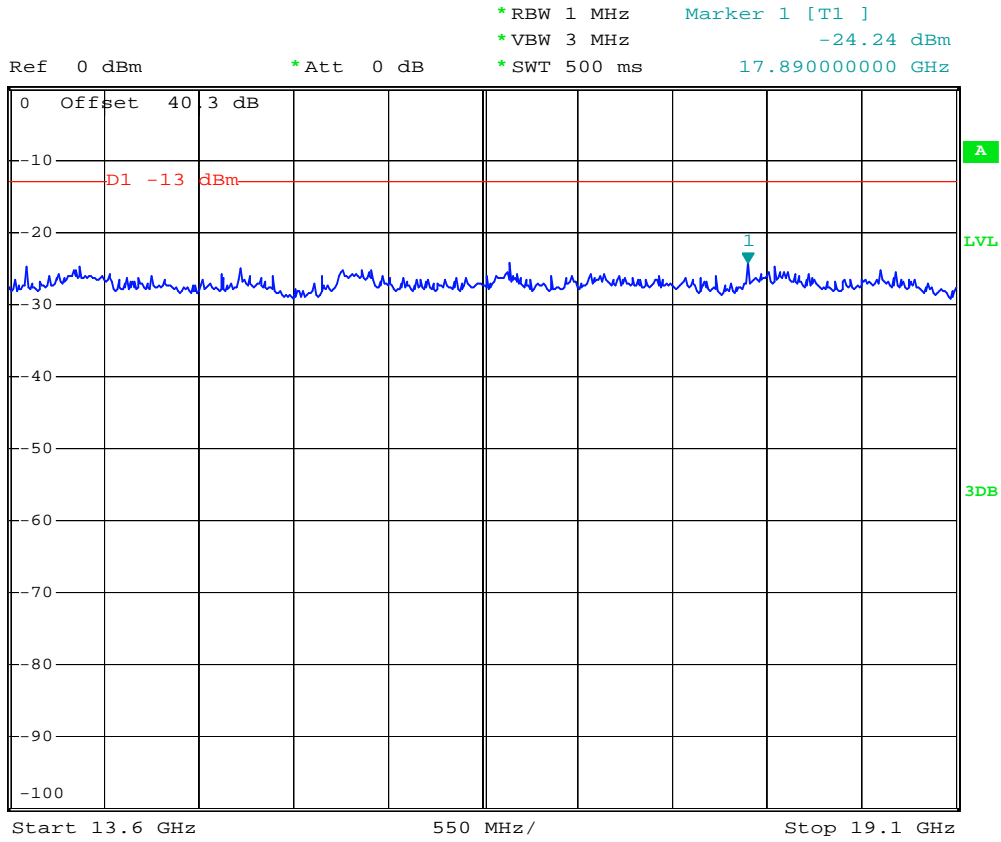

Date: 2.MAR.2008 15:19:57



- Mode 4
- Test Mode : PCS1900 (EDGE) CH661
- Frequency Range : 30M-1G



Ref 35 dBm *Att 30 dB *RBW 1 MHz Marker 1 [T1]
 *VBW 3 MHz -32.59 dBm
 *SWT 500 ms 701.24000000 MHz

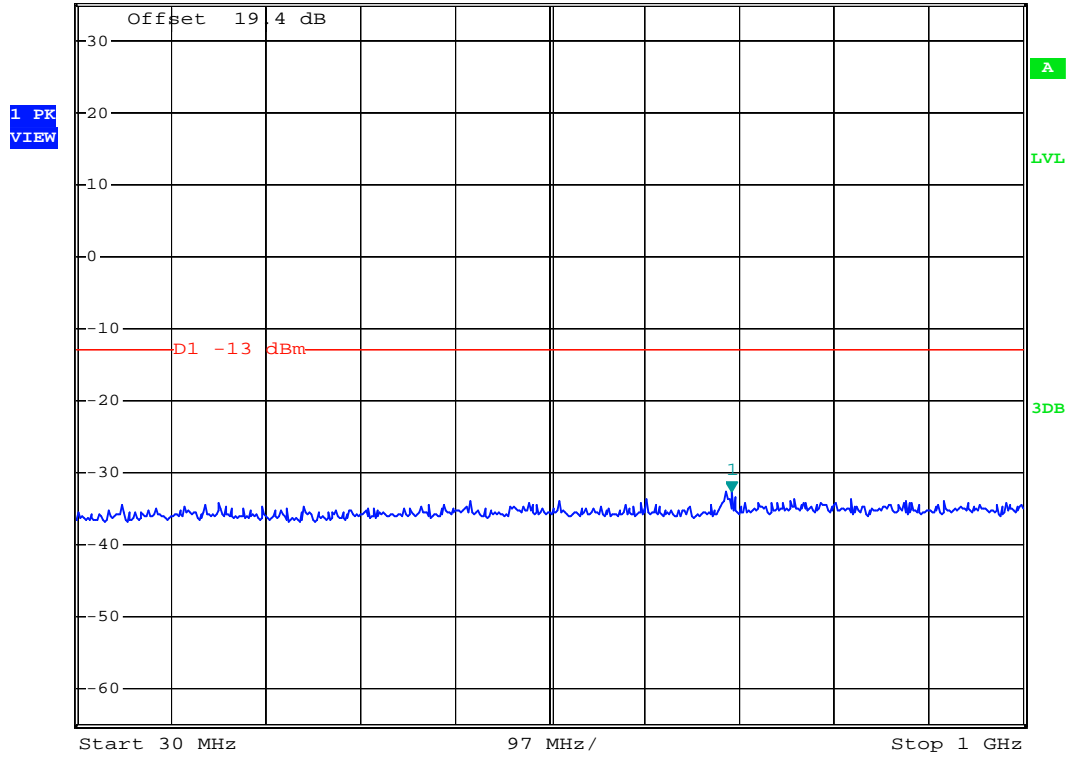

Date: 2.MAR.2008 15:04:19



- Test Mode : PCS1900 (EDGE) CH661
- Frequency Range : 1G-3G



Ref 35 dBm *Att 30 dB *RBW 1 MHz Marker 2 [T1]
 *VBW 3 MHz -30.07 dBm
 *SWT 500 ms 2.960000000 GHz

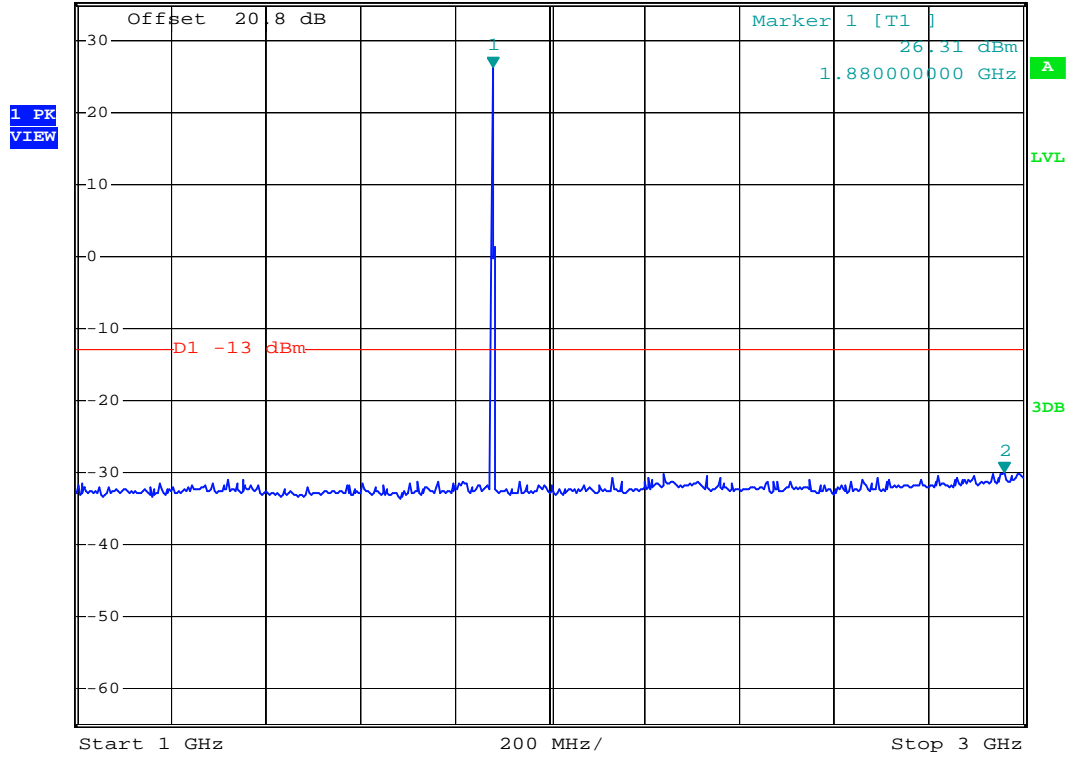

Date: 7.MAR.2008 05:18:40



- Test Mode : PCS1900 (EDGE) CH661
- Frequency Range : 3G-7G



*RBW 1 MHz Marker 2 [T1]
 *VBW 3 MHz -50.13 dBm
 *SWT 500 ms 5.640000000 GHz

Ref 0 dBm

*Att 0 dB

1 PK VIEW

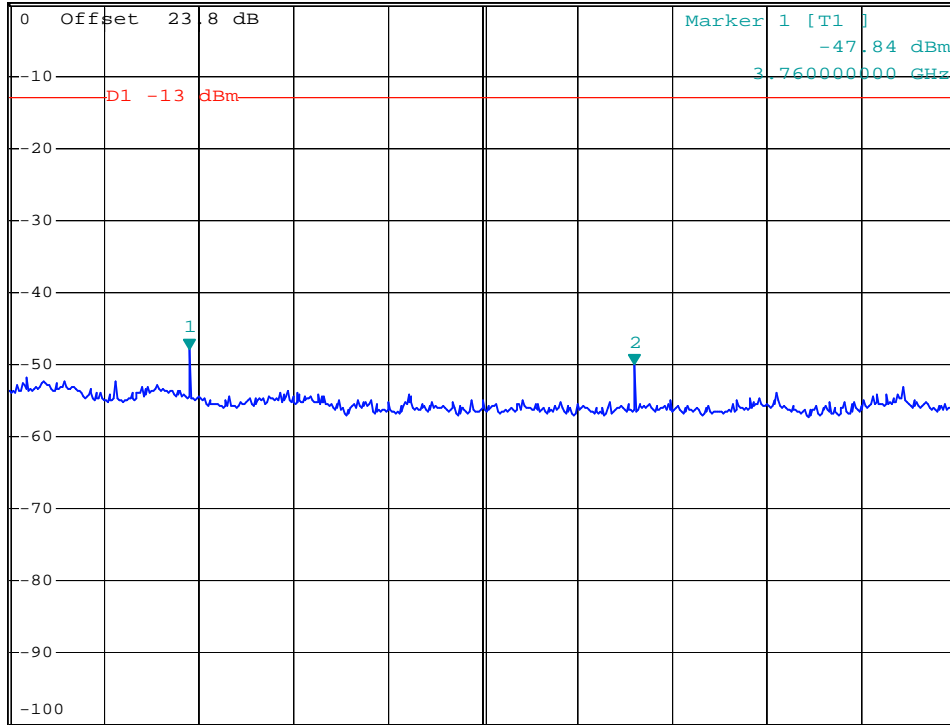

Start 3 GHz

400 MHz/

Stop 7 GHz

Date: 17.FEB.2008 16:20:54



- Test Mode : PCS1900 (EDGE) CH661
- Frequency Range : 7G-13.6G



Ref 0 dBm *Att 0 dB *RBW 1 MHz Marker 1 [T1]
*VBW 3 MHz -49.19 dBm
*SWT 500 ms 13.494400000 GHz

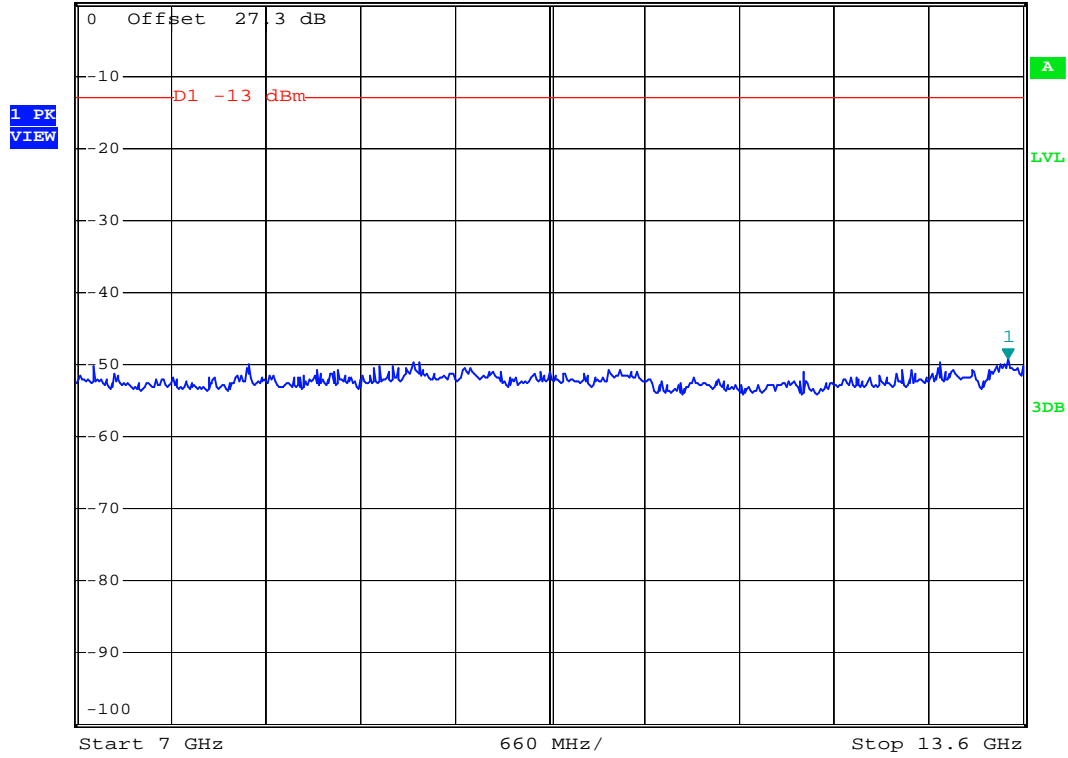

Date: 17.FEB.2008 16:21:46



- Test Mode : PCS1900 (EDGE) CH661
- Frequency Range : 13.6G-19.1G

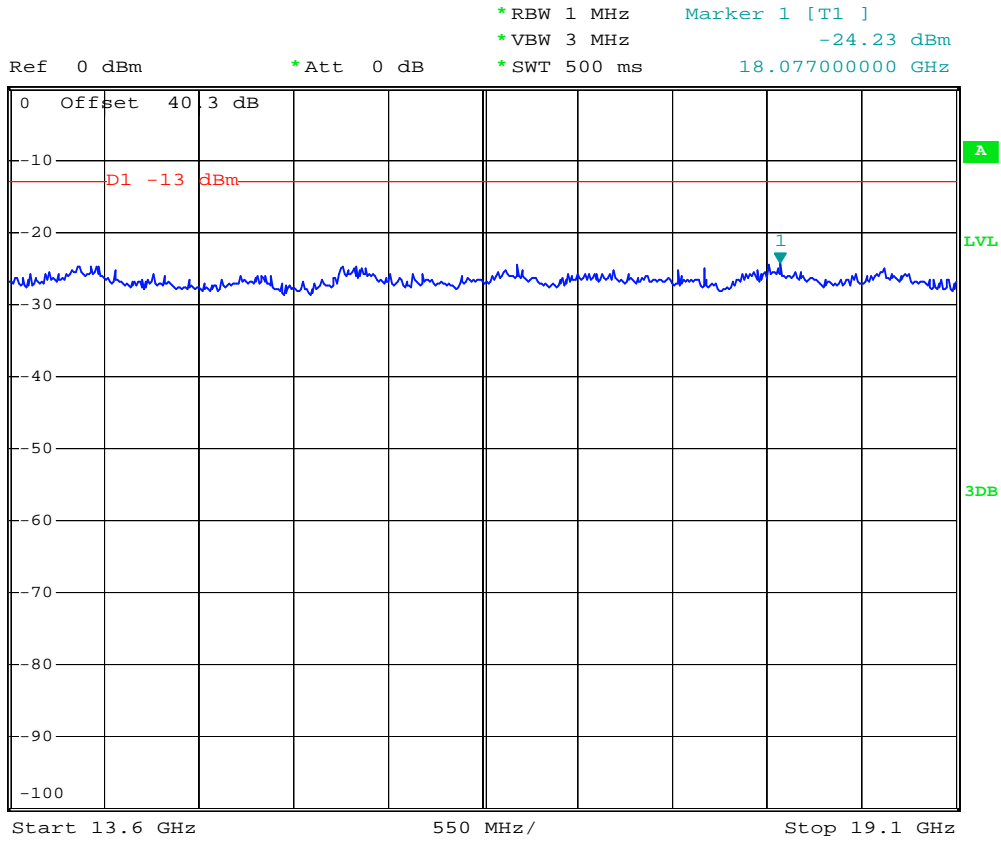

Date: 2.MAR.2008 15:20:22



- Mode 5
- Test Mode : WCDMA Band V CH4182
- Frequency Range : 30M-1G



Ref 30 dBm *Att 30 dB *RBW 1 MHz Marker 1 [T1]
*VBW 3 MHz 22.91 dBm
*SWT 500 ms 838.98000000 MHz

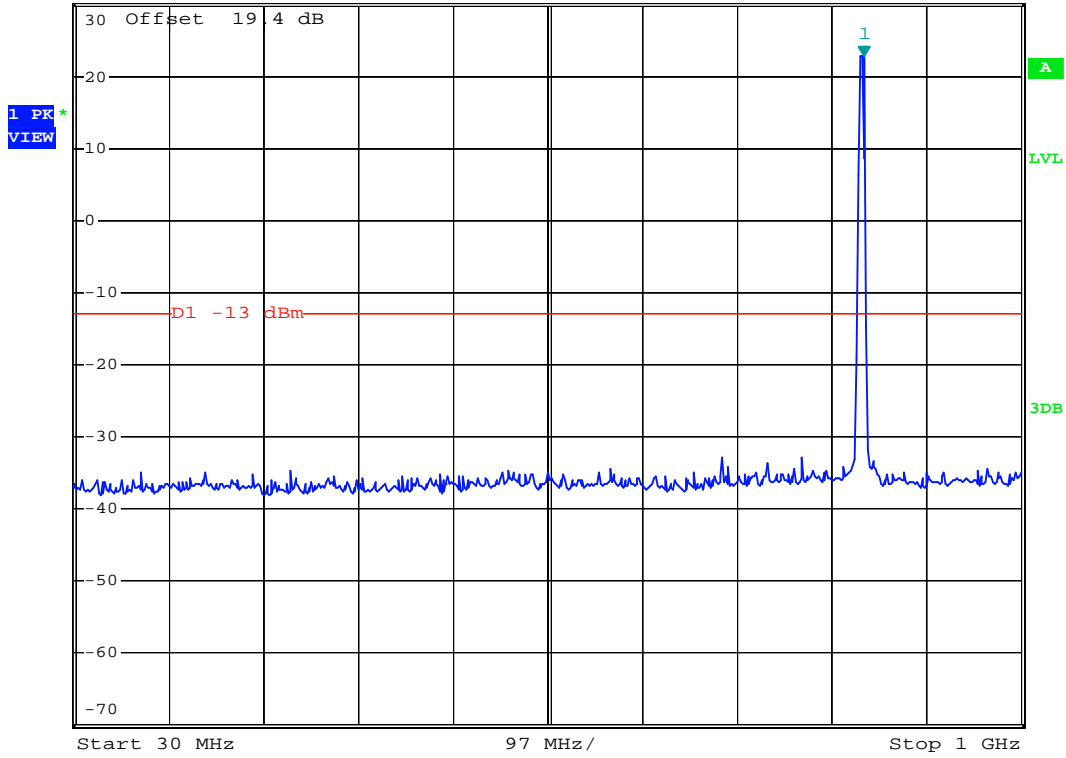

Date: 9.MAR.2008 03:26:21



- Test Mode : WCDMA Band V CH4182
- Frequency Range : 1G-3G



*RBW 1 MHz Marker 2 [T1]
 *VBW 3 MHz -57.24 dBm
 *SWT 500 ms 1.676000000 GHz

Ref 0 dBm

*Att 0 dB

1 PK
VIEW

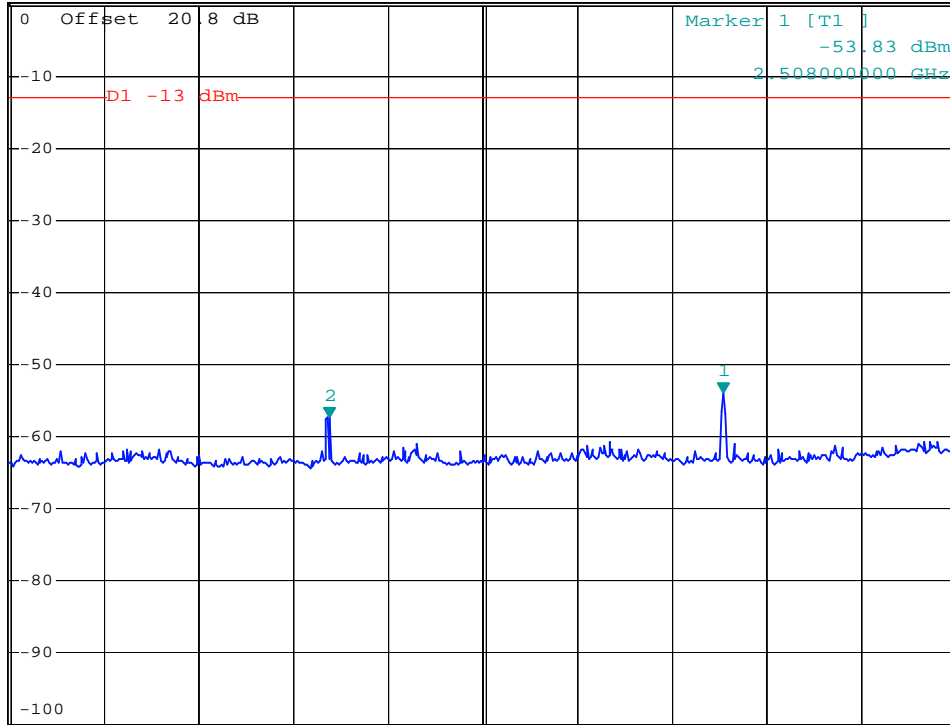

Start 1 GHz

200 MHz/

Stop 3 GHz

Date: 2.MAR.2008 14:12:36



- Test Mode : WCDMA Band V CH4182
- Frequency Range : 3G-7G

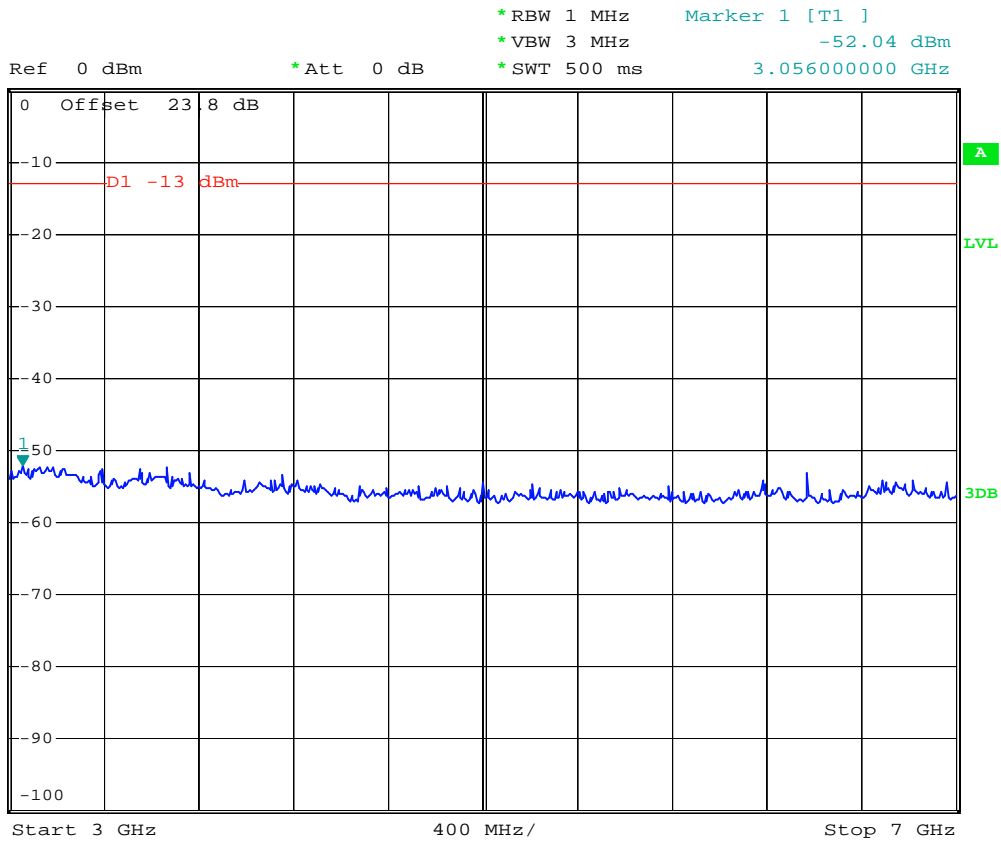

Date: 17.FEB.2008 17:08:50



- Test Mode : WCDMA Band V CH4182
- Frequency Range : 7G-9G

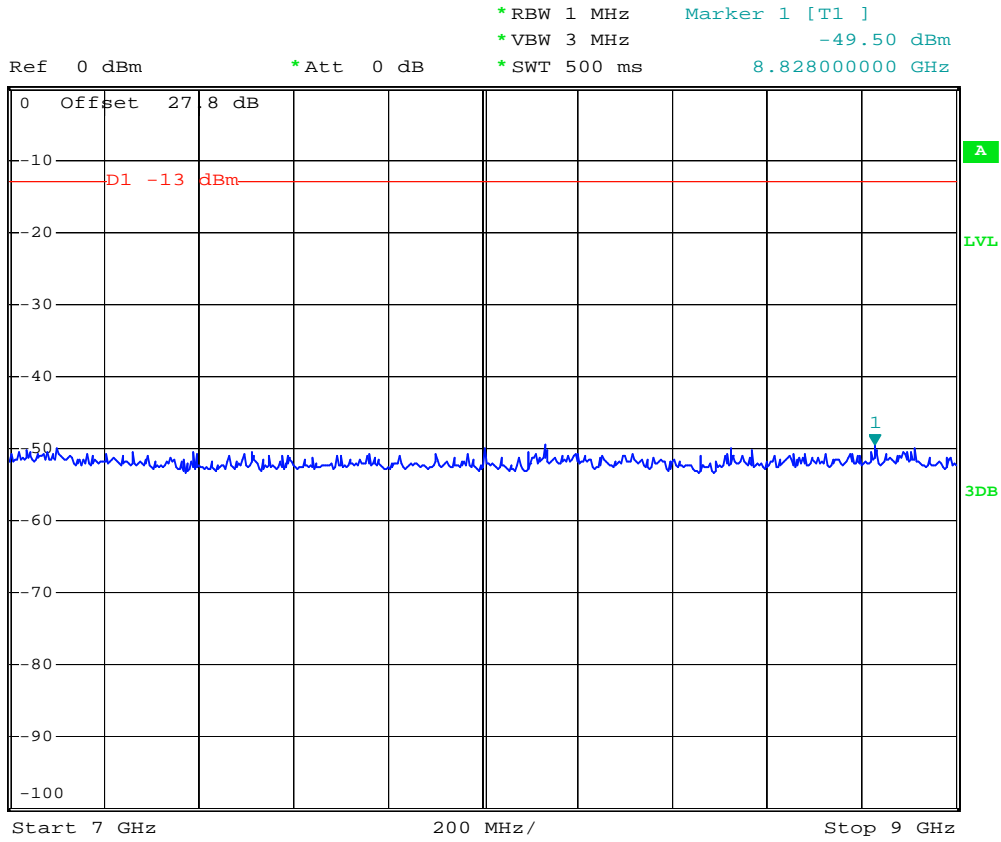

Date: 17.FEB.2008 17:09:42



- Test Mode : WCDMA Band V (HSDPA) CH4182
- Frequency Range : 1G-3G



Ref 0 dBm *Att 0 dB *RBW 1 MHz Marker 2 [T1]
 *VBW 3 MHz -57.31 dBm
 *SWT 500 ms 1.672000000 GHz

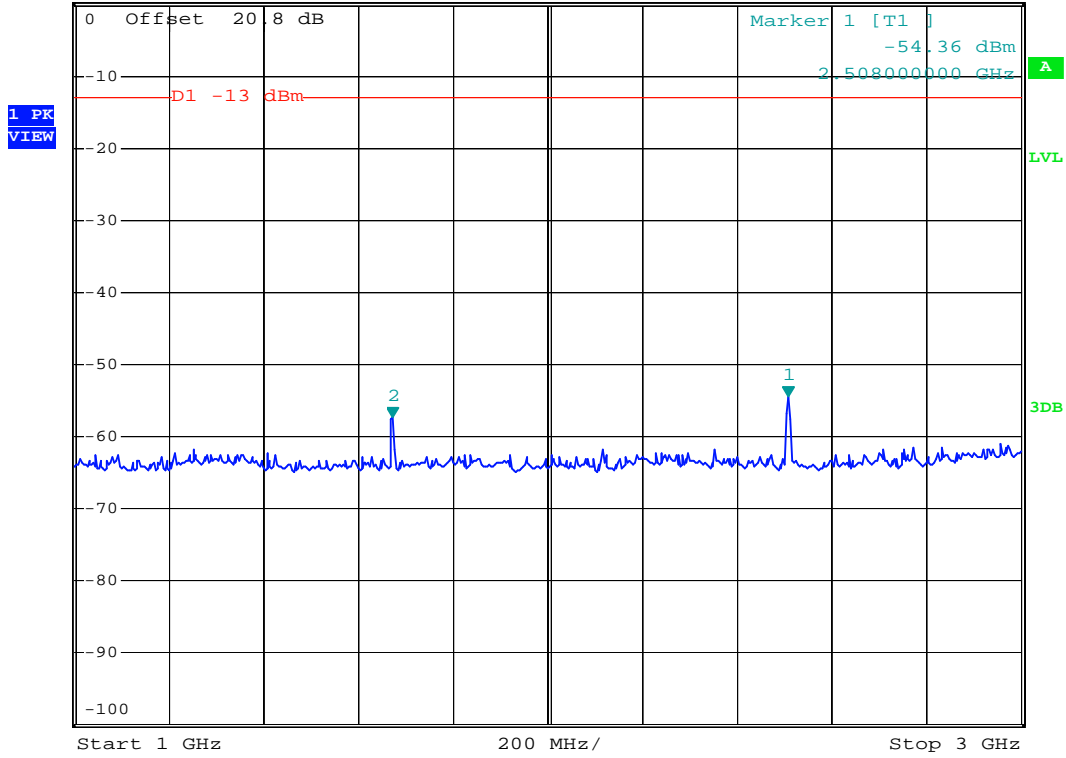

Date: 2.MAR.2008 14:13:10



- Test Mode : WCDMA Band V (HSDPA) CH4182
- Frequency Range : 3G-7G

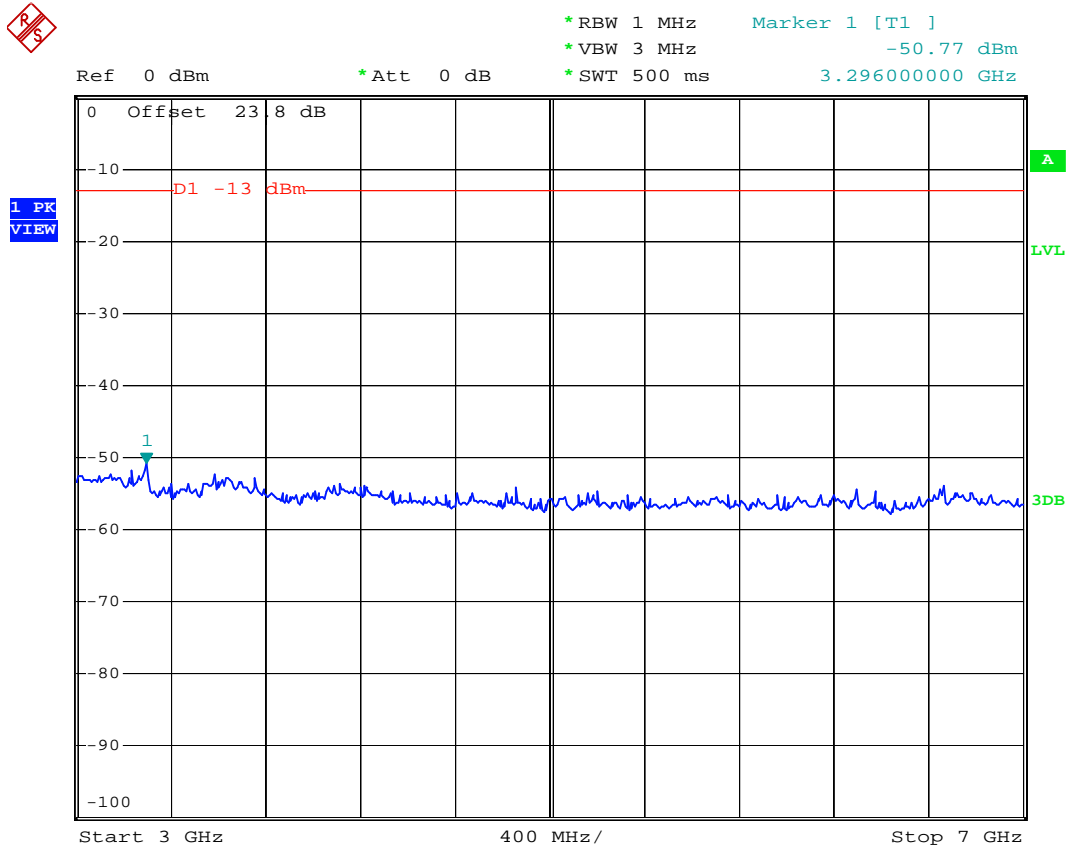

Date: 17.FEB.2008 17:40:39



- Test Mode : WCDMA Band V (HSDPA) CH4182
- Frequency Range : 7G-9G



*RBW 1 MHz Marker 1 [T1]
 *VBW 3 MHz -49.14 dBm
 *SWT 500 ms 8.172000000 GHz

Ref 0 dBm

*Att 0 dB

1 PK
VIEW

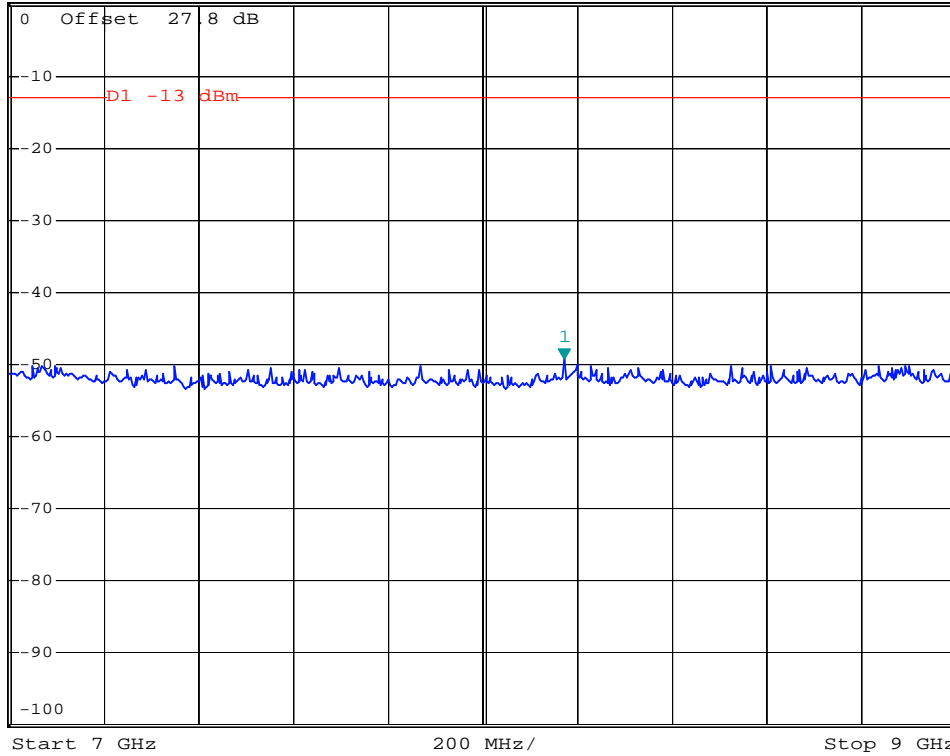

Date: 17.FEB.2008 17:41:31



- Mode 7
- Test Mode : WCDMA Band II CH9400
- Frequency Range : 30M-1G

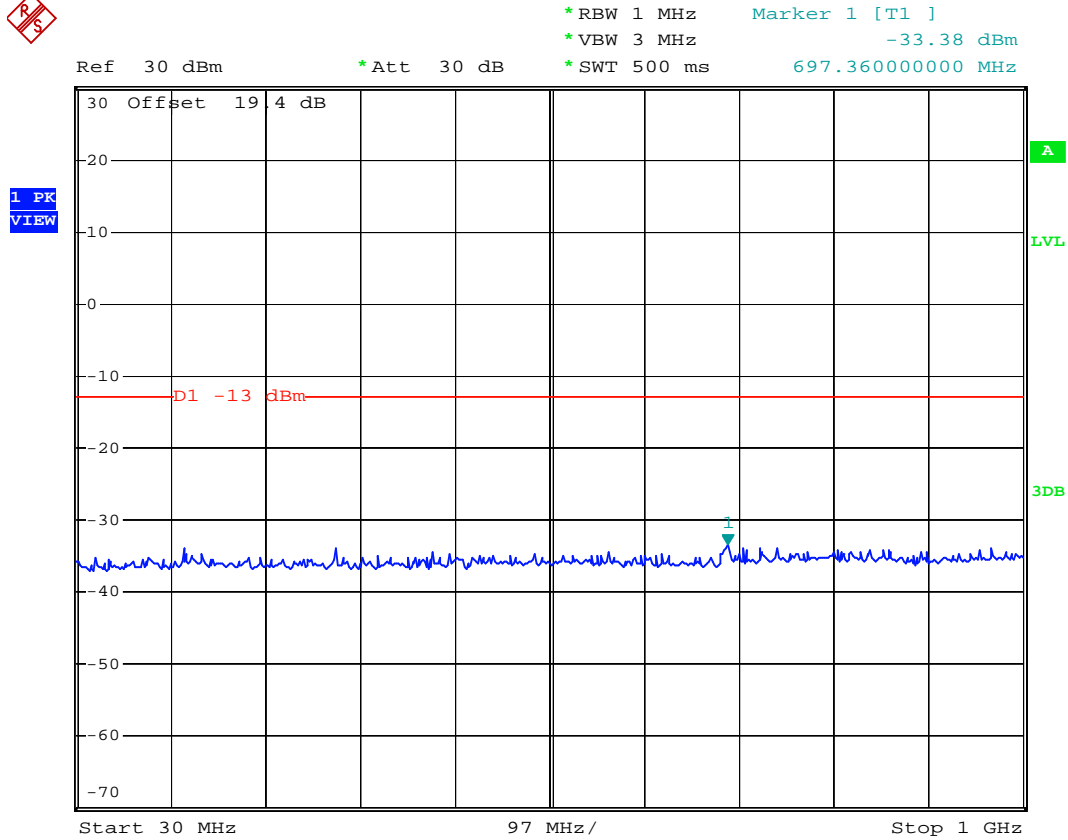

Date: 2.MAR.2008 14:40:17



- Test Mode : WCDMA Band II CH9400
- Frequency Range : 1G-3G

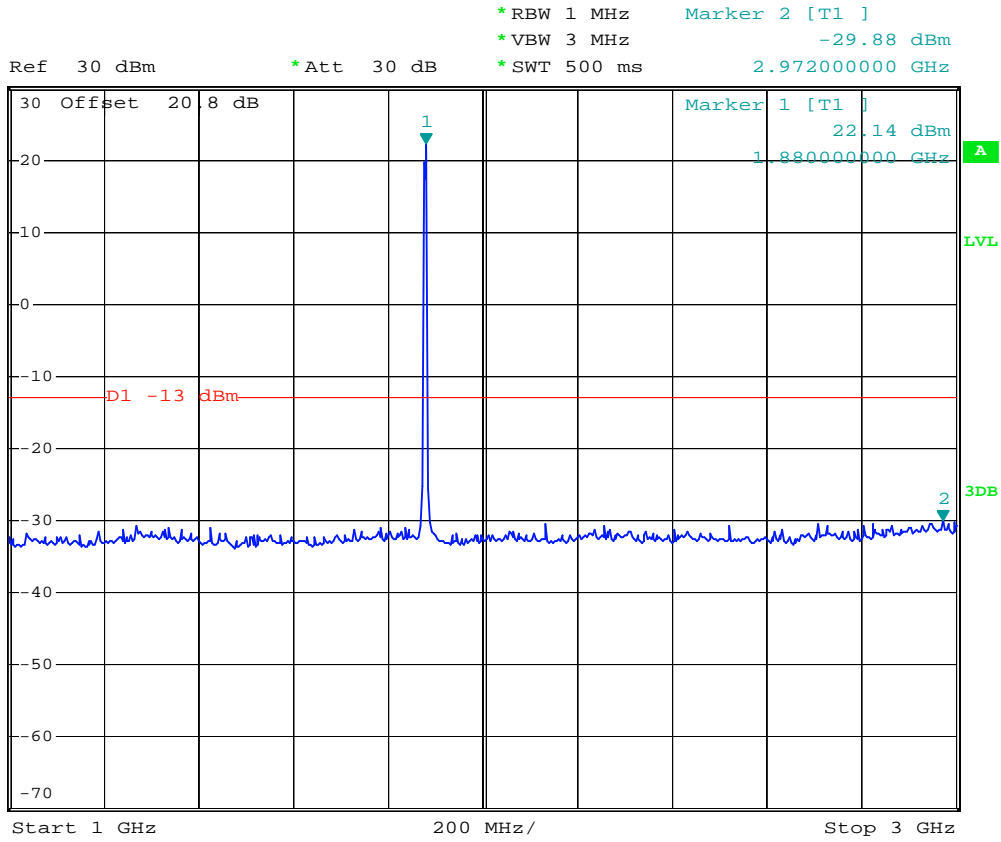

Date: 9.MAR.2008 03:13:19



- Test Mode : WCDMA Band II CH9400
- Frequency Range : 3G-7G

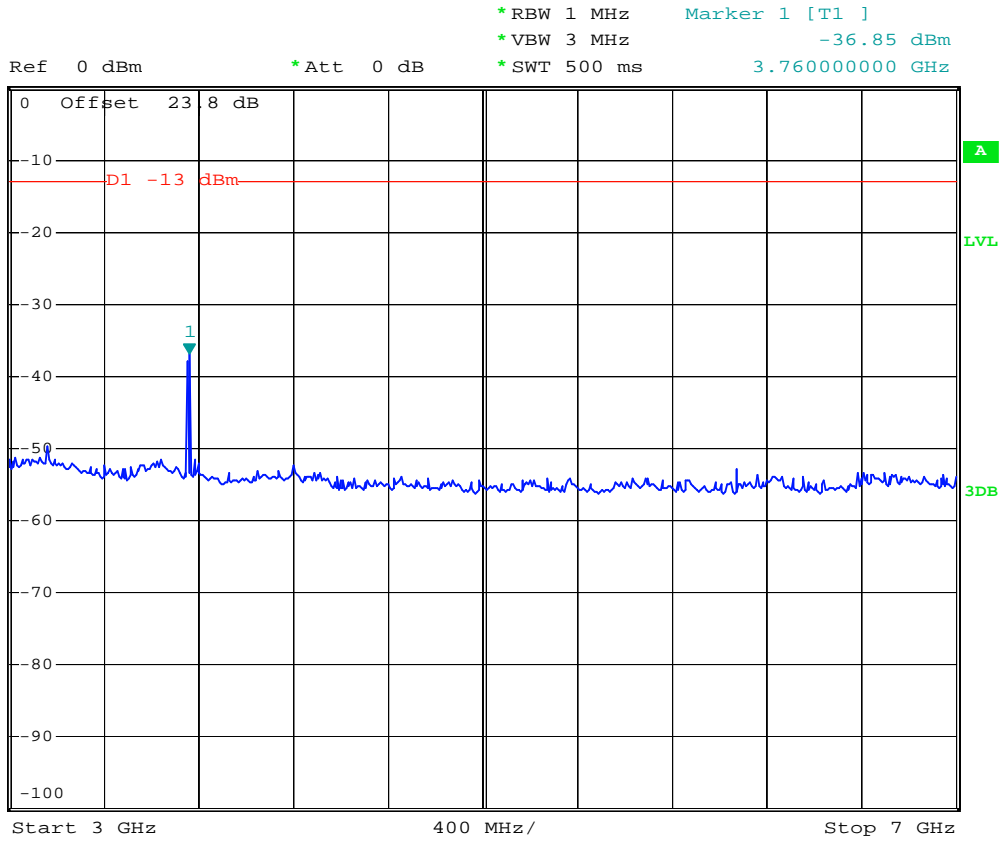

Date: 2.MAR.2008 14:47:27



- Test Mode : WCDMA Band II CH9400
- Frequency Range : 7G-13.6G



*RBW 1 MHz Marker 1 [T1]
 *VBW 3 MHz -48.61 dBm
 *SWT 500 ms 13.600000000 GHz

Ref 0 dBm

*Att 0 dB

1 PK
VIEW

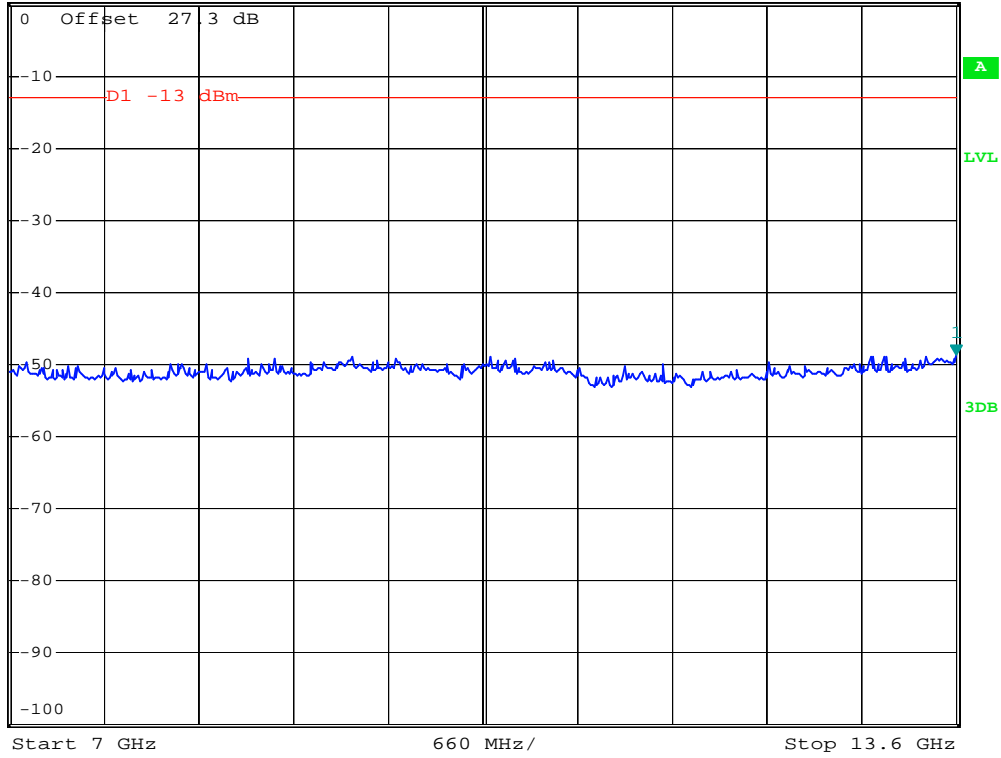

Date: 2.MAR.2008 14:48:07



- Test Mode : WCDMA Band II CH9400
- Frequency Range : 13.6G-19.1G

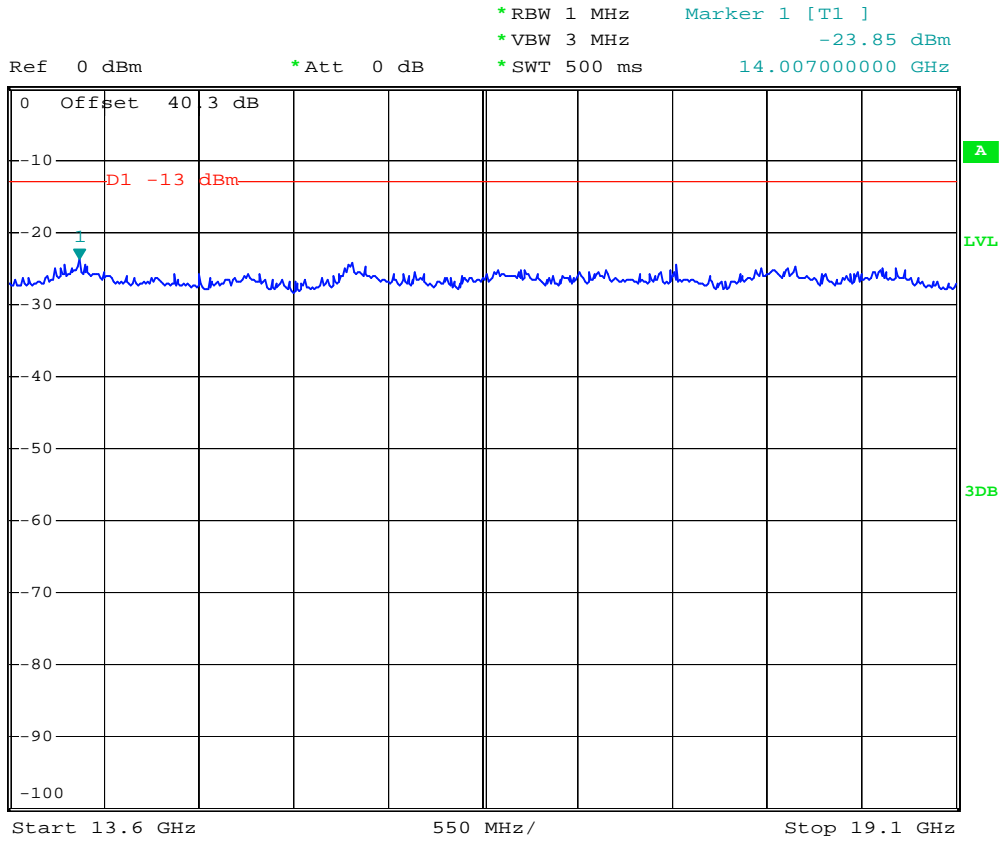

Date: 2.MAR.2008 14:50:37



- Mode 8
- Test Mode : WCDMA Band II (HSDPA) CH9400
- Frequency Range : 30M-1G



Ref 30 dBm *Att 30 dB *RBW 1 MHz Marker 1 [T1]
 *VBW 3 MHz -33.65 dBm
 *SWT 500 ms 693.48000000 MHz

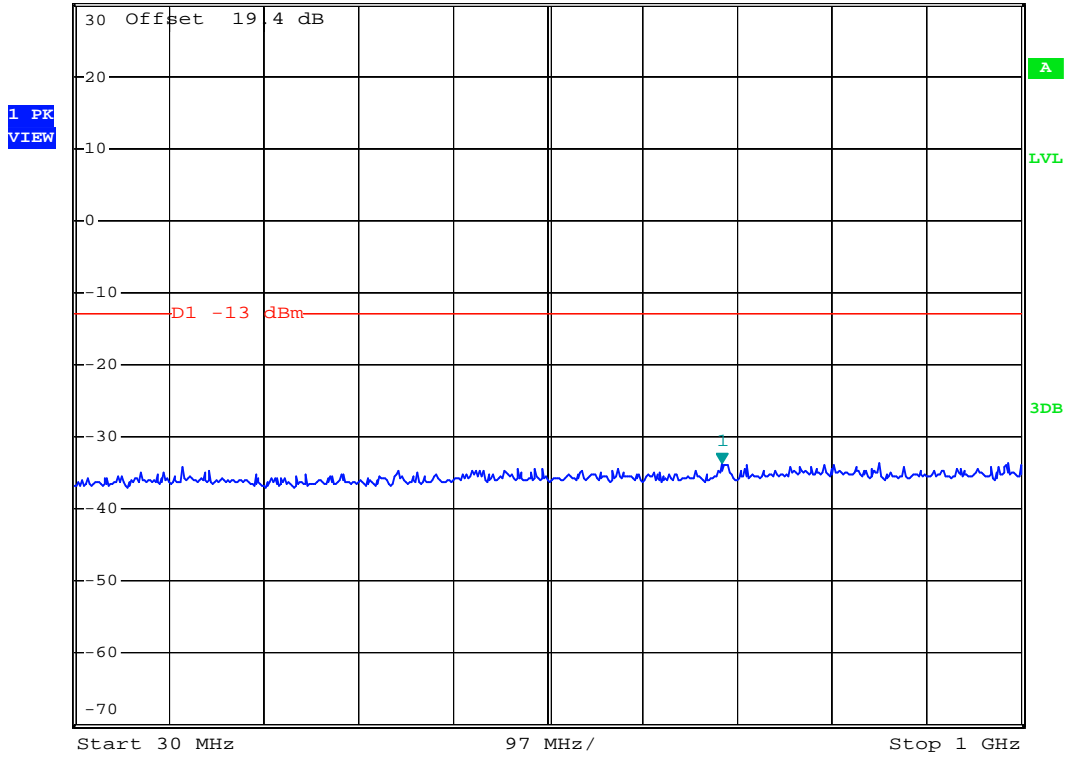

Date: 2.MAR.2008 14:38:16



- Test Mode : WCDMA Band II (HSDPA) CH9400
- Frequency Range : 1G-3G

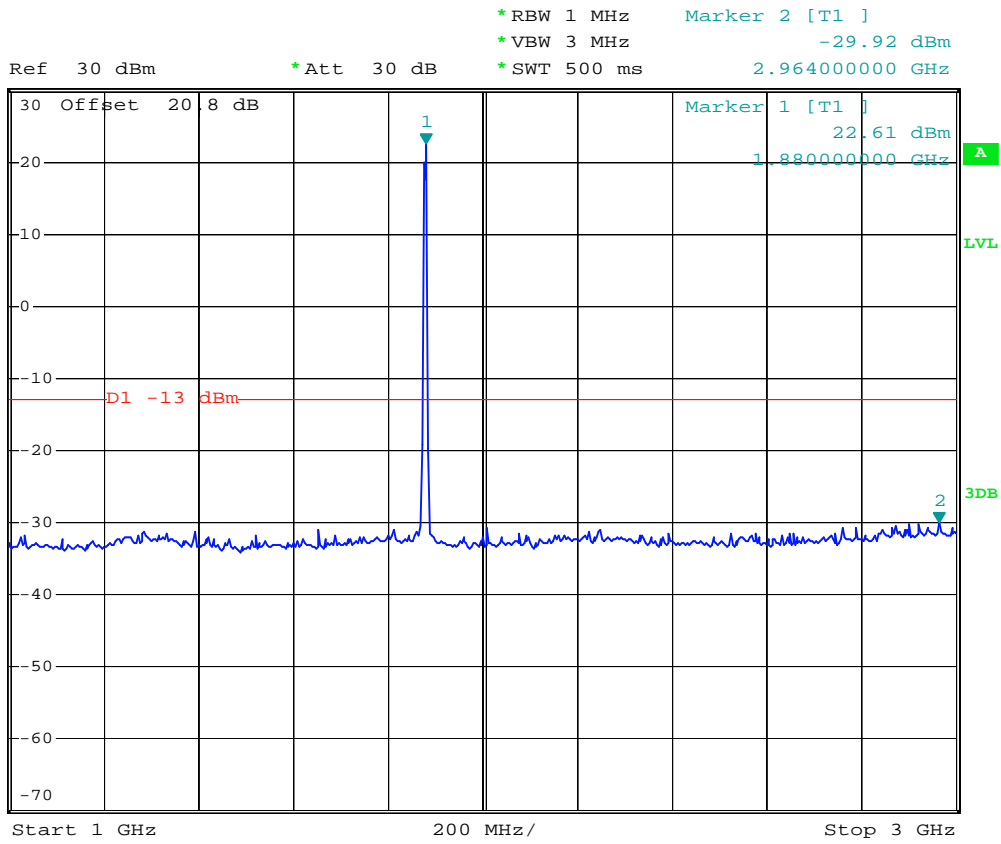

Date: 9.MAR.2008 03:18:52



- Test Mode : WCDMA Band II (HSDPA) CH9400
- Frequency Range : 3G-7G

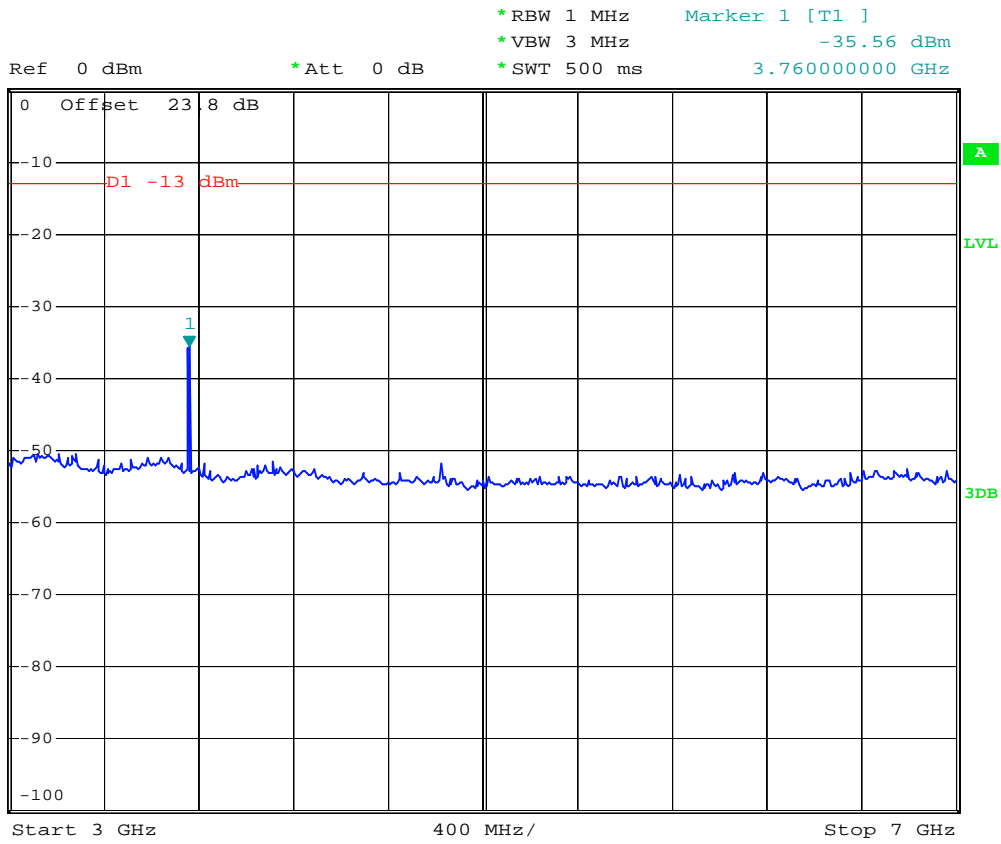

Date: 2.MAR.2008 14:46:51



- Test Mode : WCDMA Band II (HSDPA) CH9400
- Frequency Range : 7G-13.6G

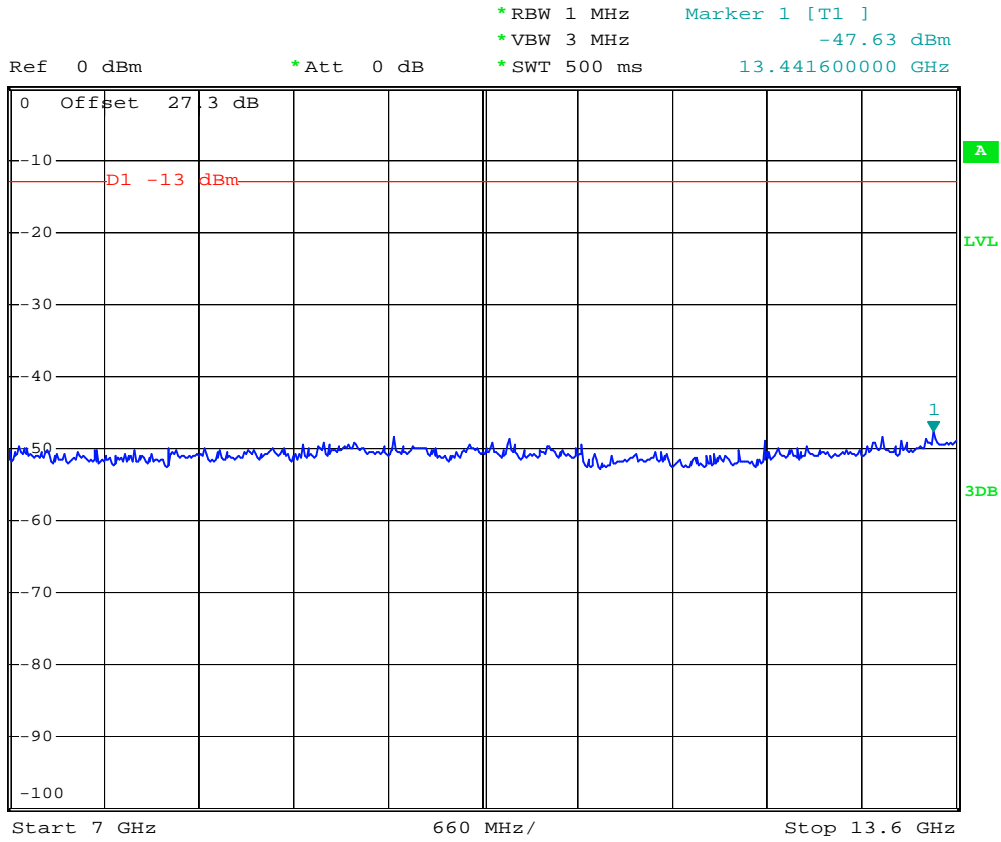

Date: 2.MAR.2008 14:48:48



- Test Mode : WCDMA Band II (HSDPA) CH9400
- Frequency Range : 13.6G-19.1G

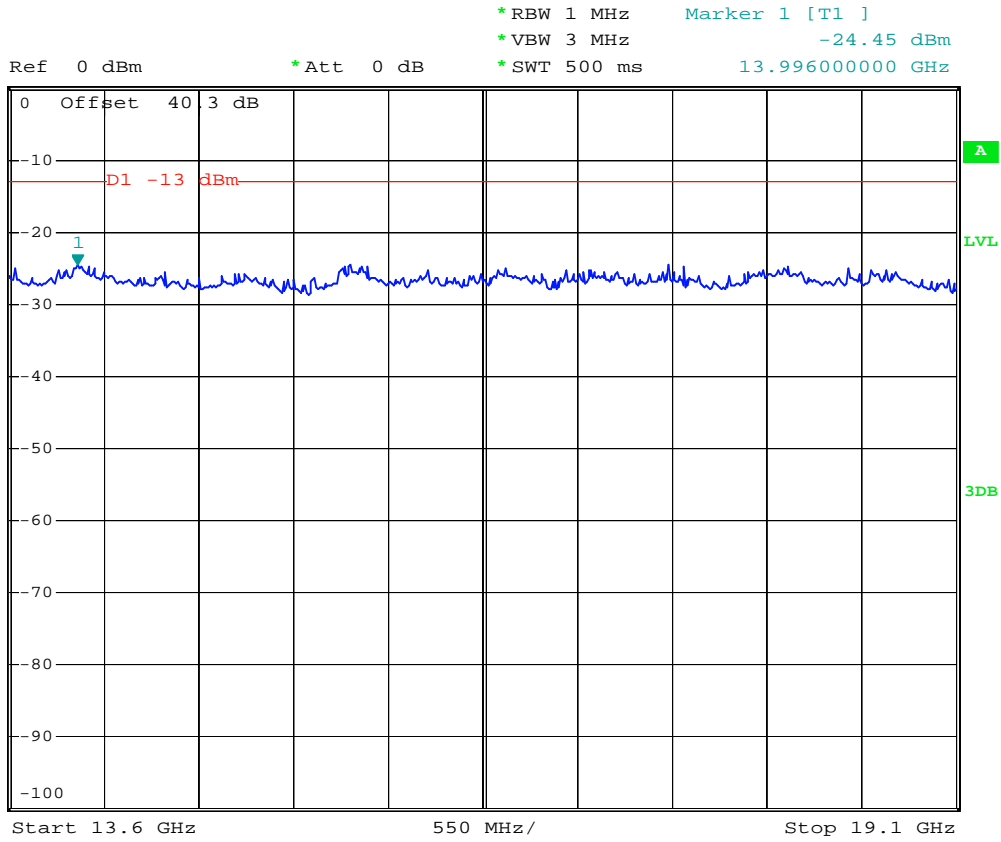

Date: 2.MAR.2008 14:49:50

4.6 Field Strength of Spurious Radiation

Equivalent isotropic radiated Power Measurements by substitution method according to ANSI/TIA/EIA-603-C.

4.6.1 Measurement Instruments

As described in chapter 5 of this test report.

4.6.2 Test Procedure

- a. The EUT was placed on a rotatable wooden table with 0.8 meter about ground.
- b. The EUT was set 3 meters from the receiving antenna which was mounted on the antenna tower.
- c. The table was rotated 360 degrees to determine the position of the highest spurious emission.
- d. The height of the receiving antenna is varied between one meter and four meters to reach the maximum spurious emission for both horizontal and vertical polarizations.
- e. Taking the record of maximum spurious emission.
- f. A Horn antenna was substituted in place of the EUT and was driven by a signal generator.
- g. Tune the output power of signal generator to the same emission level with EUT maximum spurious emission.
- h. Taking the record of output power at antenna port.
- i. Repeat step 7 to step 8 for another polarization.
- j. Emission level (dBm) = output power + substitution Gain.

4.6.3 Test Setup Layout

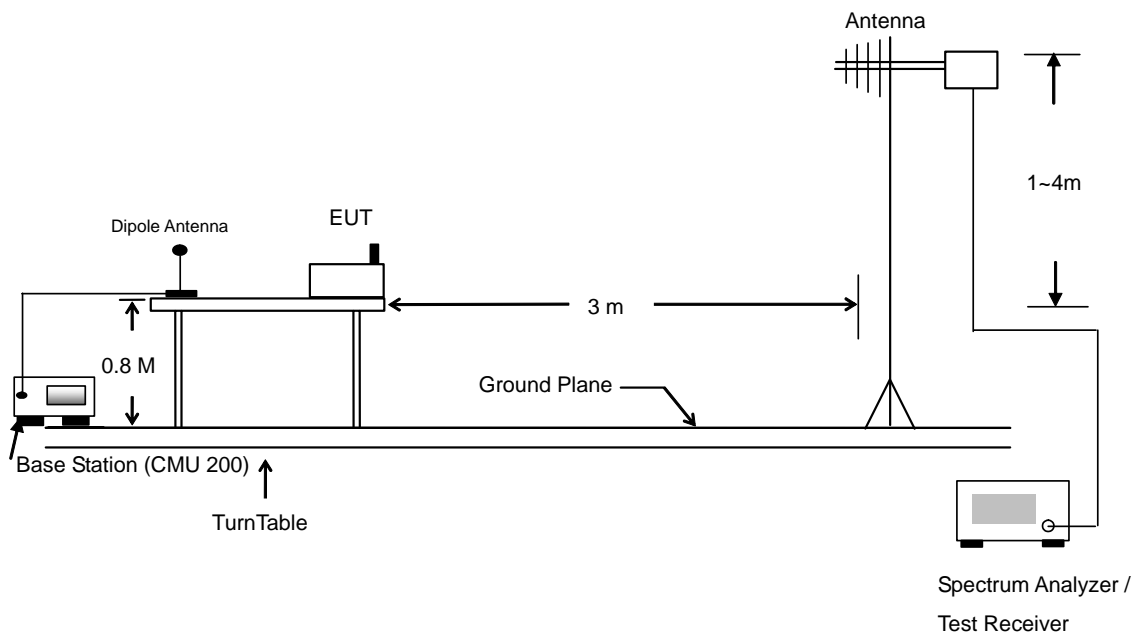



4.6.4 Test Data

Mode 1

Horizontal Polarization

Date: 2008-02-16

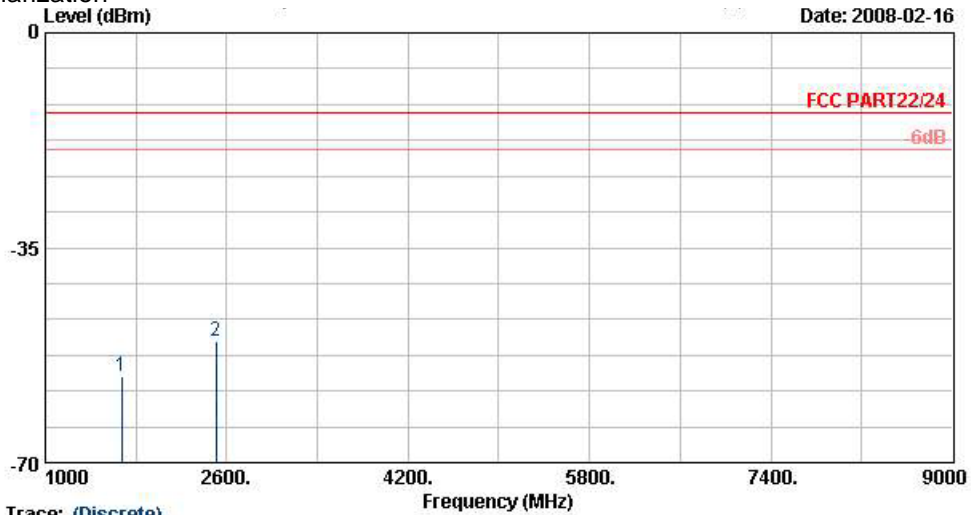

Trace: (Discrete)

Site : D3CH06-HY
 Condition : FCC PART22/24 ETRP-071107 HORIZONTAL
 EUT : Notebook
 Power : 120Vac/60Hz
 Model : FG 821323
 Memo : GSM 850 Link ; CH189 + Adaptor
 S/N : P601T-121STD1256

Frequency (MHz)	ERP (dBm)	Limit (dBm)	SPA Reading (dBm)	S.G. Power (dBm)	TX Cable loss (dB)	TX Antenna Gain (dBi)	Polarization (H/V)	Result
1672	-55.95	-13	-54.95	-55.1	5.05	6.35	H	Pass
2506	-50.35	-13	-54.06	-50.4	5.93	8.13	H	Pass

Remark : Spurious emissions within 30-1000MHz were found more than 20dB below limit line.



Vertical Polarization

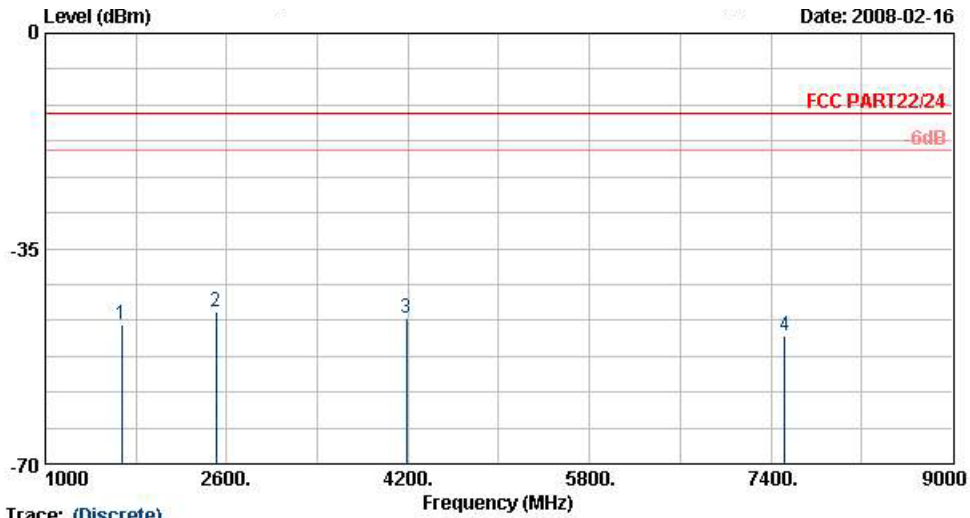

Trace: (Discrete)

Site : 03CH06-HY
 Condition : FCC PART22/24 ETRP-071107 VERTICAL
 EUT : Notebook
 Power : 120Vac/60Hz
 Model : FC 821323
 Memo : GSM 850 Link ; CH189 + Adaptor
 S/N : P601T-121STD1256

Frequency (MHz)	ERP (dBm)	Limit (dBm)	SPA Reading (dBm)	S.G. Power (dBm)	TX Cable loss (dB)	TX Antenna Gain (dBi)	Polarization (H/V)	Result
1672	-47.45	-13	-48.39	-46.6	5.05	6.35	V	Pass
2506	-45.25	-13	-52.66	-45.3	5.93	8.13	V	Pass
4185	-46.35	-13	-55.27	-47.3	7.52	10.62	V	Pass
7520	-49.16	-13	-59.73	-44.2	10.21	7.4	V	Pass

Remark : Spurious emissions within 30-1000MHz were found more than 20dB below limit line.



Mode 2

Horizontal Polarization

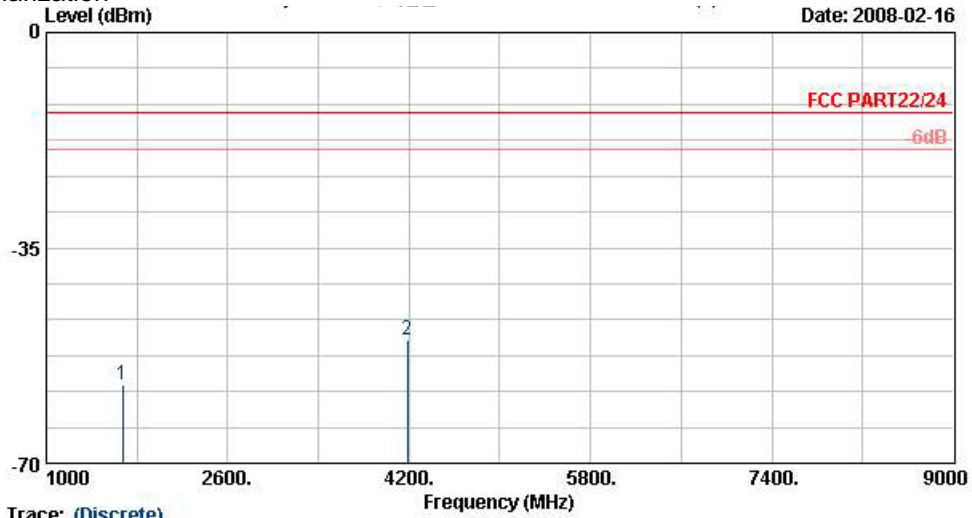

Trace: (Discrete)
 Site : 03CH06-HY
 Condition : FCC PART22/24 ETRP-071107 HORIZONTAL
 EUT : Notebook
 Power : 120Vac/60Hz
 Model : FC 821323
 Memo : EDGE Link ; CH189 + Adaptor
 S/N : P601T-121STD1256

Frequency (MHz)	ERP (dBm)	Limit (dBm)	SPA Reading (dBm)	S.G. Power (dBm)	TX Cable loss (dB)	TX Antenna Gain (dBi)	Polarization (H/V)	Result
1672	-57.35	-13	-56.51	-56.5	5.05	6.35	H	Pass
4185	-49.95	-13	-58.19	-50.9	7.52	10.62	H	Pass

Remark : Spurious emissions within 30-1000MHz were found more than 20dB below limit line.



Vertical Polarization

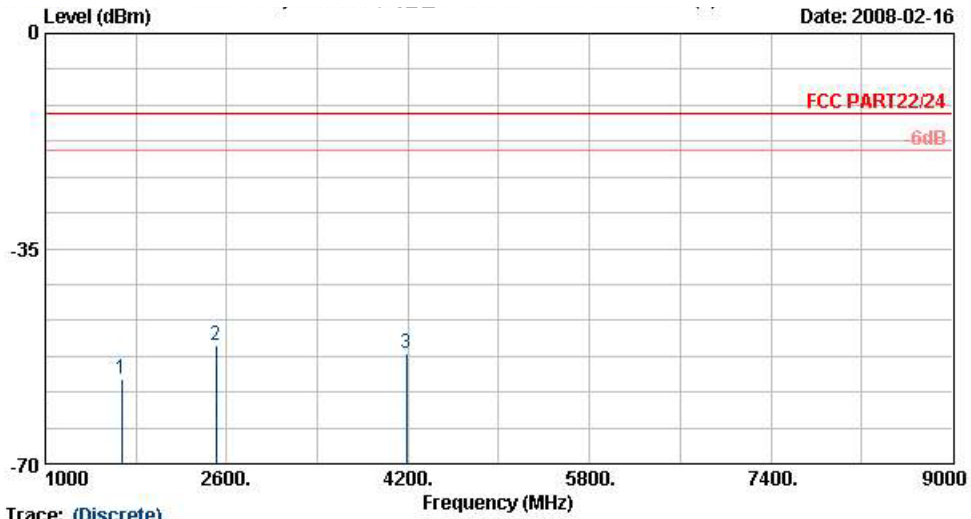

Date: 2008-02-16

Trace: (Discrete)

Site : 03CH06-HY
 Condition : FCC PART22/24 EIRP-071107 VERTICAL
 EUT : Notebook
 Power : 120Vac/60Hz
 Model : FG 821323
 Memo : EDGE Link : CH189 + Adaptor
 S/N : P601T-121STD1256

Frequency (MHz)	ERP (dBm)	Limit (dBm)	SPA Reading (dBm)	S.G. Power (dBm)	TX Cable loss (dB)	TX Antenna Gain (dBi)	Polarization (H/V)	Result
1672	-56.15	-13	-55.17	-55.3	5.05	6.35	V	Pass
2506	-50.65	-13	-56.57	-50.7	5.93	8.13	V	Pass
4185	-52.15	-13	-59.41	-53.1	7.52	10.62	V	Pass

Remark : Spurious emissions within 30-1000MHz were found more than 20dB below limit line.



Mode 3

Horizontal Polarization

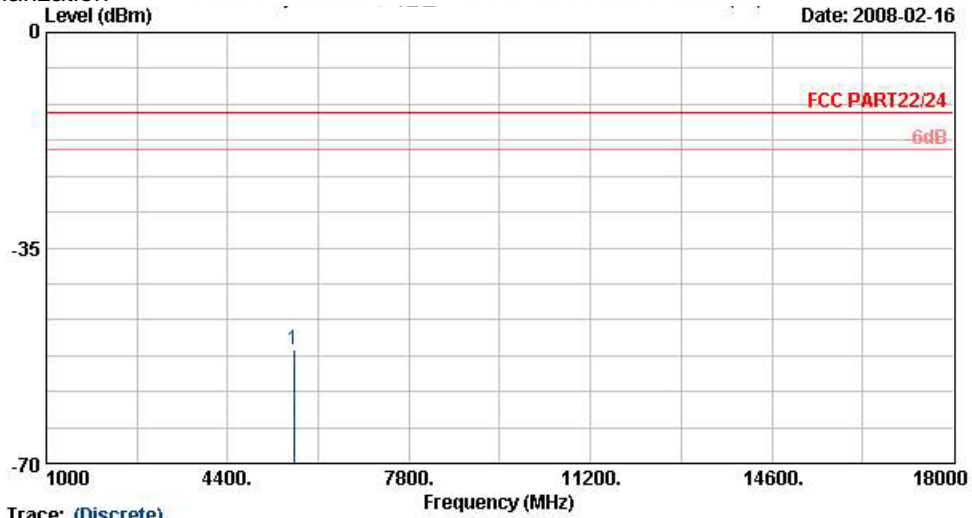

Trace: (Discrete)
 Site : 03CH06-HY
 Condition : FCC PART22/24 ETRP-071107 HORIZONTAL
 EUT : Notebook
 Power : 120Vac/60Hz
 Model : FC 821323
 Memo : PCS1900 Link ; CH661 + Adaptor
 S/N : P601T-121STD1256

Frequency (MHz)	ERP (dBm)	Limit (dBm)	SPA Reading (dBm)	S.G. Power (dBm)	TX Cable loss (dB)	TX Antenna Gain (dBi)	Polarization (H/V)	Result
5636	-51.41	-13	-60.78	-53.2	8.77	10.56	H	Pass

Remark : Spurious emissions within 30-1000MHz were found more than 20dB below limit line.



Vertical Polarization

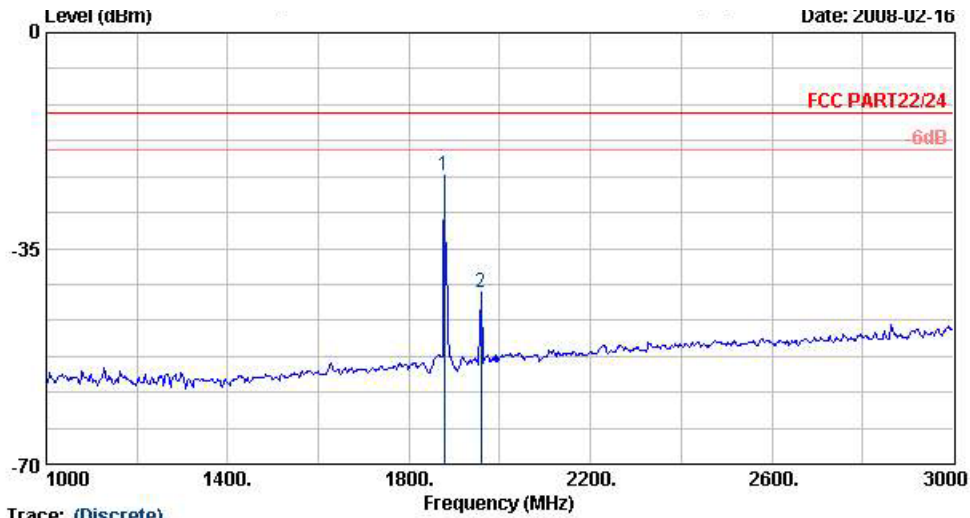

Trace: (Discrete)
Site : 03CH06-HY
Condition : FCC PART22/24 ETRP-071107 VERTICAL
EUT : Notebook
Power : 120Vac/60Hz
Model : FG 621323
Memo : EDGE Link ; CH661 + Adaptor
S/N : P601T-121STD1256

Remark : 1. #1 MS Signal.

2. #2 BS Signal.

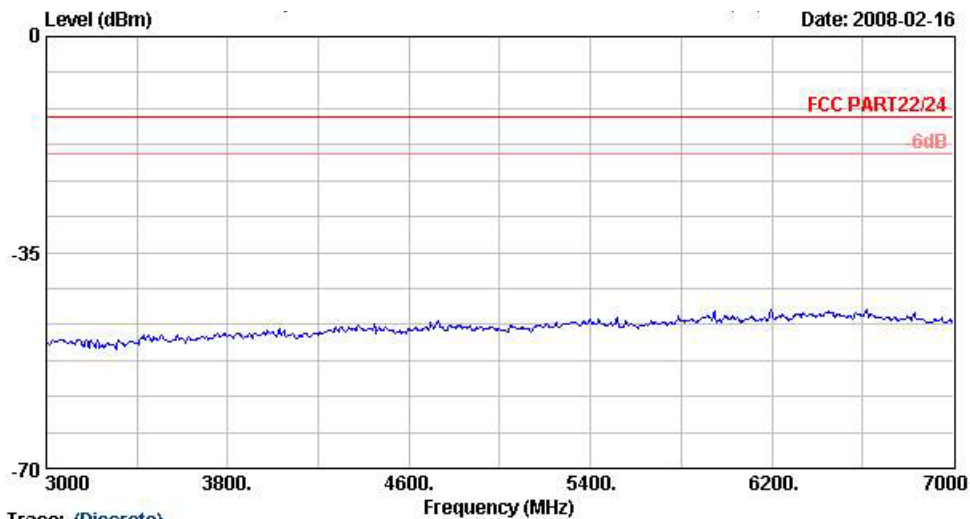

Trace: (Discrete)
Site : 03CH06-HY
Condition : FCC PART22/24 ETRP-071107 VERTICAL
EUT : Notebook
Power : 120Vac/60Hz
Model : FG 621323
Memo : PCS1900 Link ; CH661 + Adaptor
S/N : P601T-121STD1256

Remark : The spurious emission is too low to be taken.

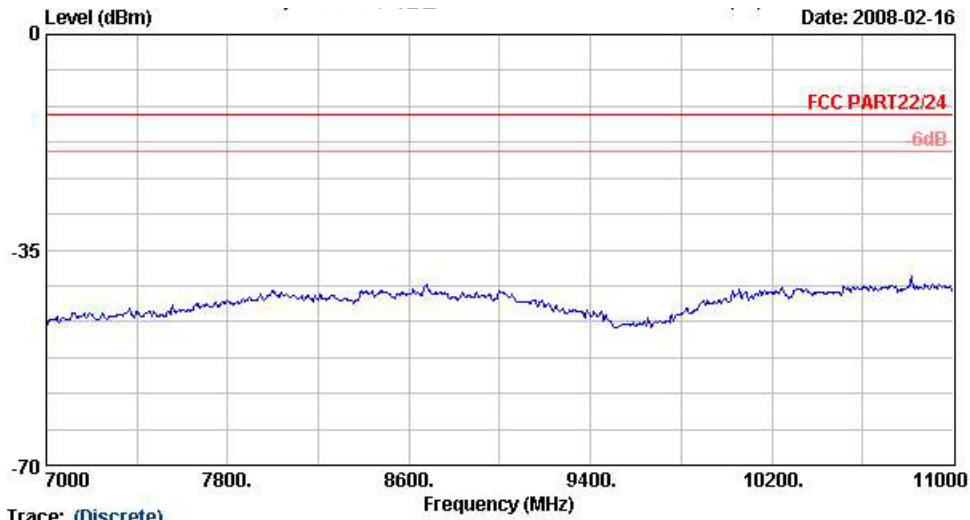

Trace: (Discrete)

Site : 03CH06-HY
Condition : FCC PART22/24 ETRP-071107 VERTICAL
EUT : Notebook
Power : 120Vac/60Hz
Model : FG 621323
Memo : PCS1900 Link ; CH661 + Adaptor
S/N : P601T-121STD1256

Remark : The spurious emission is too low to be taken.

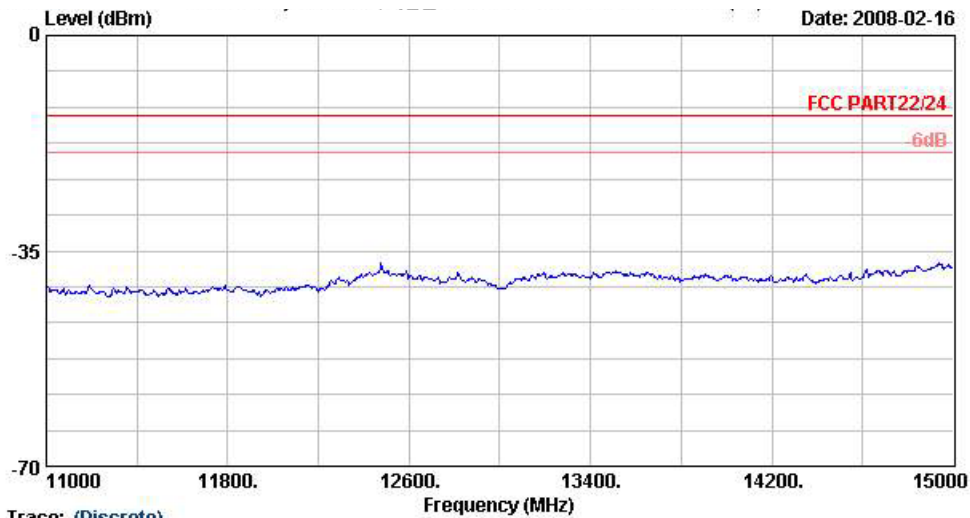

Trace: (Discrete)

Site : 03CH06-HY
Condition : FCC PART22/24 ETRP-071107 VERTICAL
EUT : Notebook
Power : 120Vac/60Hz
Model : FG 621323
Memo : PCS1900 Link ; CH661 + Adaptor
S/N : P601T-121STD1256

Remark : The spurious emission is too low to be taken.

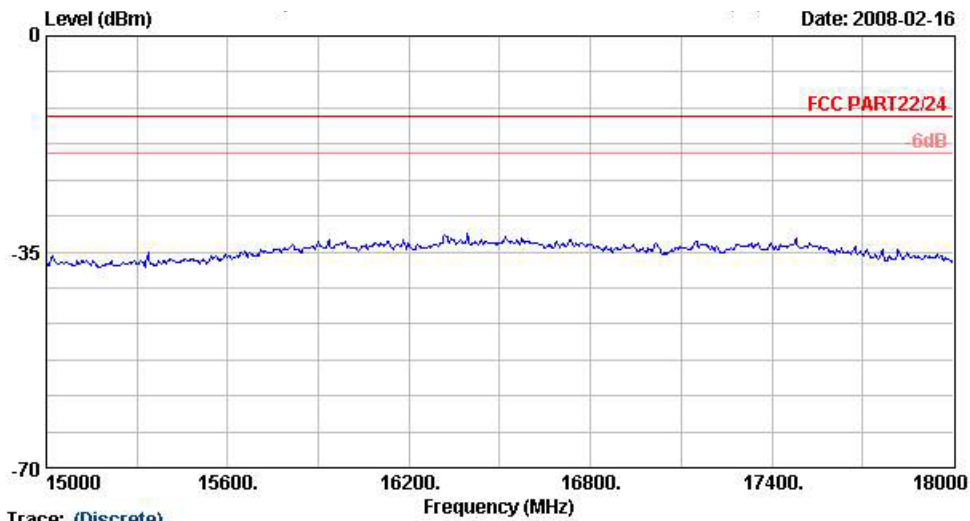

Trace: (Discrete)

Site : 03CH06-HY
Condition : FCC PART22/24 ETRP-071107 VERTICAL
EUT : Notebook
Power : 120Vac/60Hz
Model : FG 821323
Memo : PCS1900 Link ; CH661 + Adaptor
S/N : P601T-121STD1256

Remark : The spurious emission is too low to be taken.



Mode 4

Horizontal Polarization

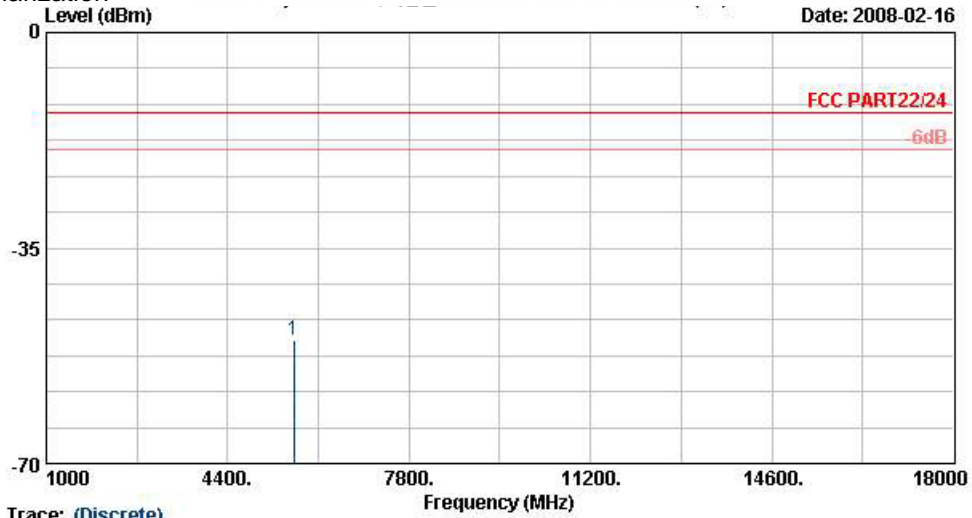

Trace: (Discrete)
 Site : 03CH06-HY
 Condition : FCC PART22/24 ETRP-071107 HORIZONTAL
 EUT : Notebook
 Power : 120Vac/60Hz
 Model : FC 821323
 Memo : EDGE Link ; CH661 + Adaptor
 S/N : P601T-121STD1256

Frequency (MHz)	ERP (dBm)	Limit (dBm)	SPA Reading (dBm)	S.G. Power (dBm)	TX Cable loss (dB)	TX Antenna Gain (dBi)	Polarization (H/V)	Result
5636	-49.91	-13	-59.93	-51.7	8.77	10.56	H	Pass

Remark : Spurious emissions within 30-1000MHz were found more than 20dB below limit line.



Vertical Polarization

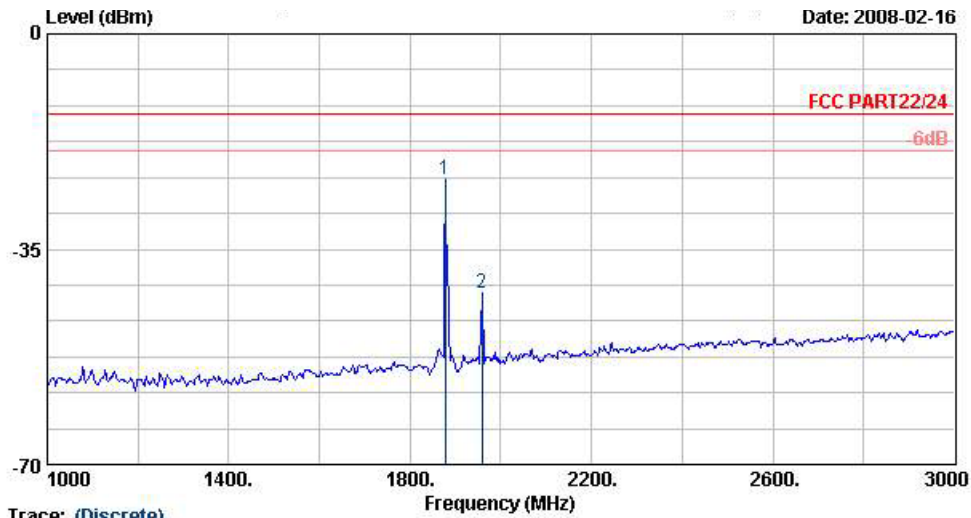

Trace: (Discrete)

Site : 03CH06-HY
Condition : FCC PART22/24 ETRP-071107 VERTICAL
EUT : Notebook
Power : 120Vac/60Hz
Model : FG 621323
Memo : PCS1000 Link ; CH661 + Adaptor
S/N : P601T-121STD1256

Remark : 1. #1 MS Signal.

2. #2 BS Signal.

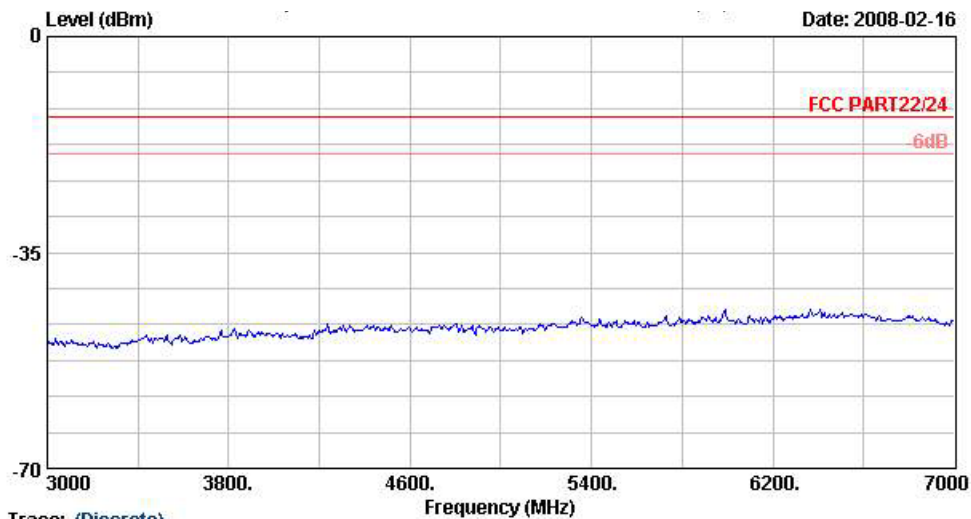

Trace: (Discrete)

Site : 03CH06-HY
Condition : FCC PART22/24 ETRP-071107 VERTICAL
EUT : Notebook
Power : 120Vac/60Hz
Model : FG 621323
Memo : EDGE Link ; CH661 + Adaptor
S/N : P601T-121STD1256

Remark : The spurious emission is too low to be taken.

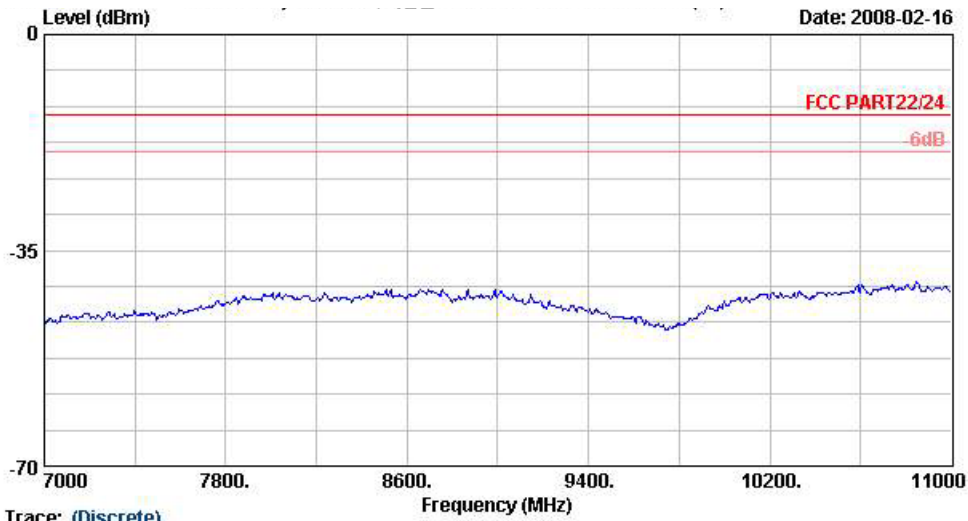

Trace: (Discrete)

Site : 03CH06-HY
Condition : FCC PART22/24 ETRP-071107 VERTICAL
EUT : Notebook
Power : 120Vac/60Hz
Model : FG 821323
Memo : EDGE Link : CH661 + Adaptor
S/N : P601T-121STD1256

Remark : The spurious emission is too low to be taken.

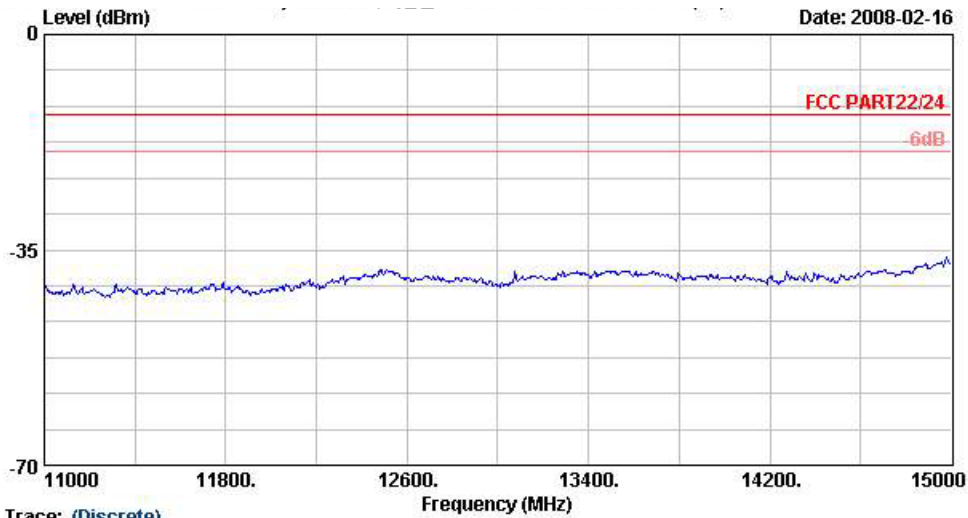

Trace: (Discrete)

Site : 03CH06-HY
Condition : FCC PART22/24 ETRP-071107 VERTICAL
EUT : Notebook
Power : 120Vac/60Hz
Model : FG 821323
Memo : EDGE Link : CH661 + Adaptor
S/N : P601T-121STD1256

Remark : The spurious emission is too low to be taken.

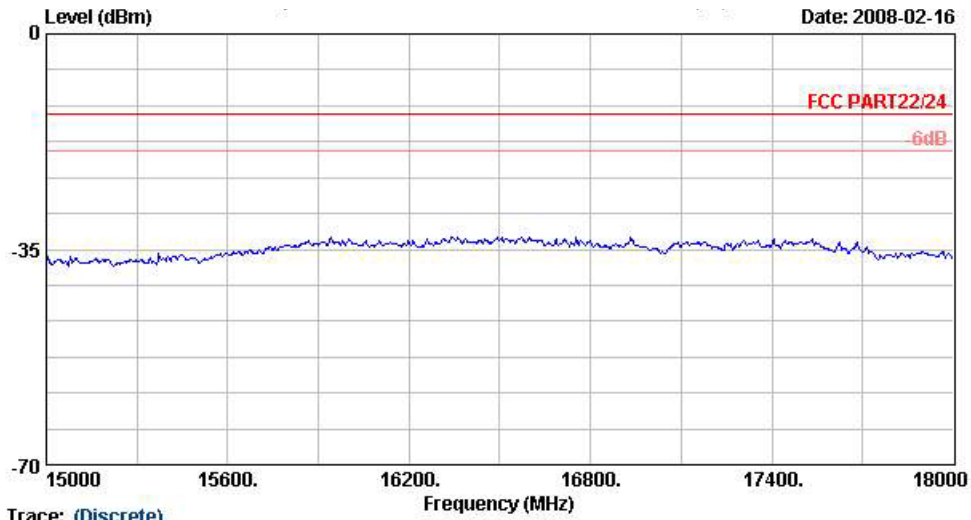

Trace: (Discrete)

Site : 03CH06-HY
Condition : FCC PART22/24 ETRP-071107 VERTICAL
EUT : Notebook
Power : 120Vac/60Hz
Model : FG 821323
Memo : EDGE Link : CH661 + Adaptor
S/N : P60IT-121STD1256

Remark : The spurious emission is too low to be taken.



Mode 5
Horizontal Polarization

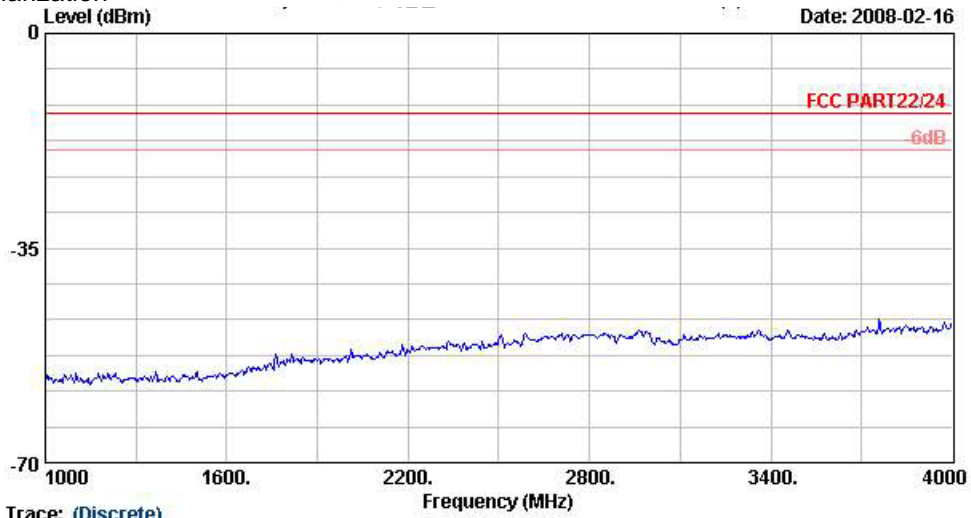

Trace: (Discrete)
Site : 03CH06-HY
Condition : FCC PART22/24 ETRP-071107 HORIZONTAL
EUT : Notebook
Power : 120Vac/60Hz
Model : FG 821323
Memo : WCDMA Link ; CH4182 + Adaptor
S/N : P601T-121STD1256

Remark : The spurious emission is too low to be taken.

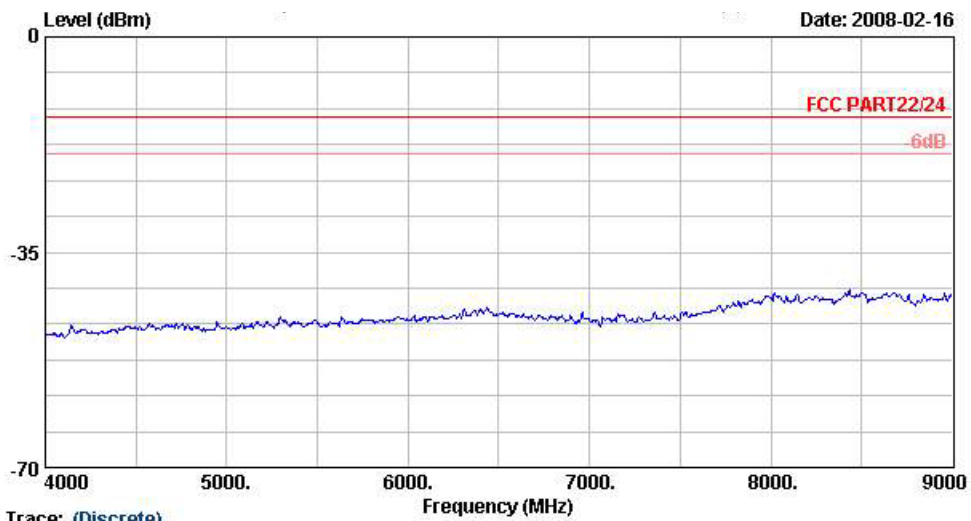

Trace: (Discrete)
Site : 03CH06-HY
Condition : FCC PART22/24 ETRP-071107 HORIZONTAL
EUT : Notebook
Power : 120Vac/60Hz
Model : FG 821323
Memo : WCDMA Link ; CH4182 + Adaptor
S/N : P601T-121STD1256

Remark : The spurious emission is too low to be taken.



Vertical Polarization

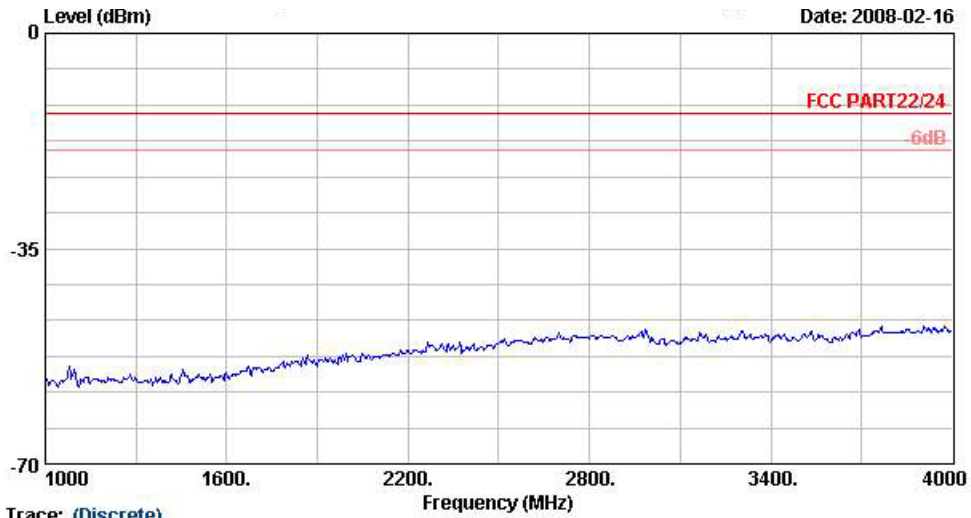

Trace: (Discrete)
Site : 03CH06-HY
Condition : FCC PART22/24 ETRP-071107 VERTICAL
EUT : Notebook
Power : 120Vac/60Hz
Model : FC 821323
Memo : WCDMA Link ; CH4182 + Adaptor
S/N : P601T-121STD1256

Remark : The spurious emission is too low to be taken.

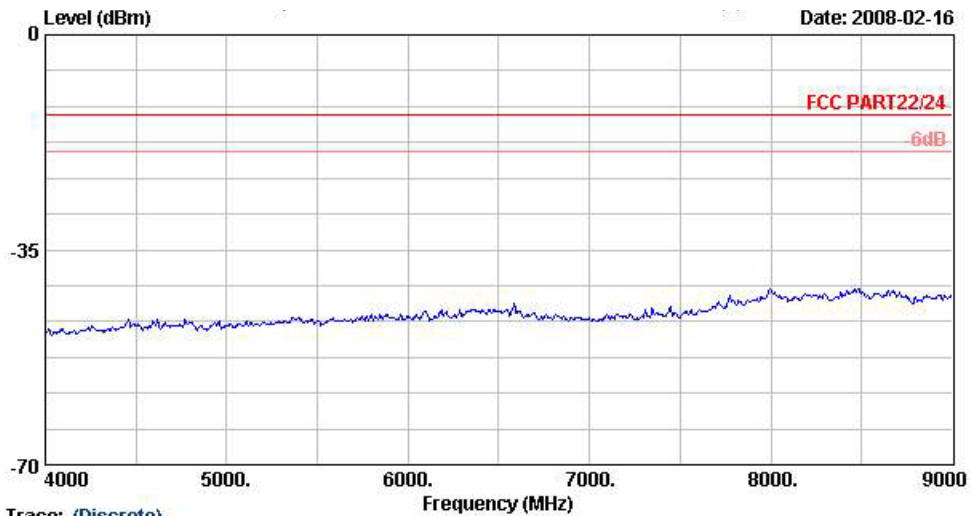

Trace: (Discrete)
Site : 03CH06-HY
Condition : FCC PART22/24 ETRP-071107 VERTICAL
EUT : Notebook
Power : 120Vac/60Hz
Model : FC 821323
Memo : WCDMA Link ; CH4182 + Adaptor
S/N : P601T-121STD1256

Remark : The spurious emission is too low to be taken.



Mode 6

Horizontal Polarization

Date: 2008-02-16

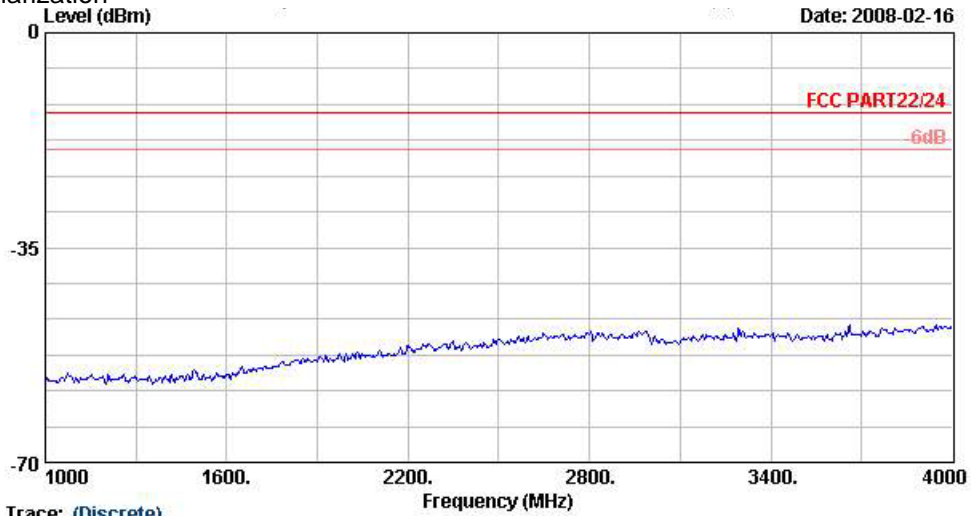

Trace: (Discrete)

Site : 03CH06-HY
Condition : FCC PART22/24 ETRP-071107 HORIZONTAL
EUT : Notebook
Power : 120Vac/60Hz
Model : FG 821323
Memo : HSDPA Link ; CH4182 + Adaptor
S/N : P601T-121STD1256

Remark : The spurious emission is too low to be taken.

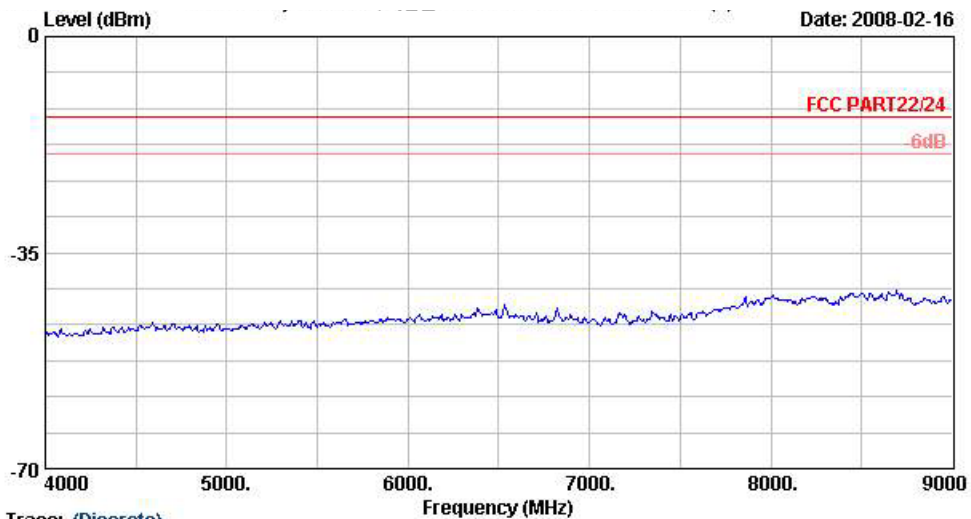

Trace: (Discrete)

Site : 03CH06-HY
Condition : FCC PART22/24 ETRP-071107 HORIZONTAL
EUT : Notebook
Power : 120Vac/60Hz
Model : FG 821323
Memo : HSDPA Link ; CH4182 + Adaptor
S/N : P601T-121STD1256

Remark : The spurious emission is too low to be taken.



Vertical Polarization

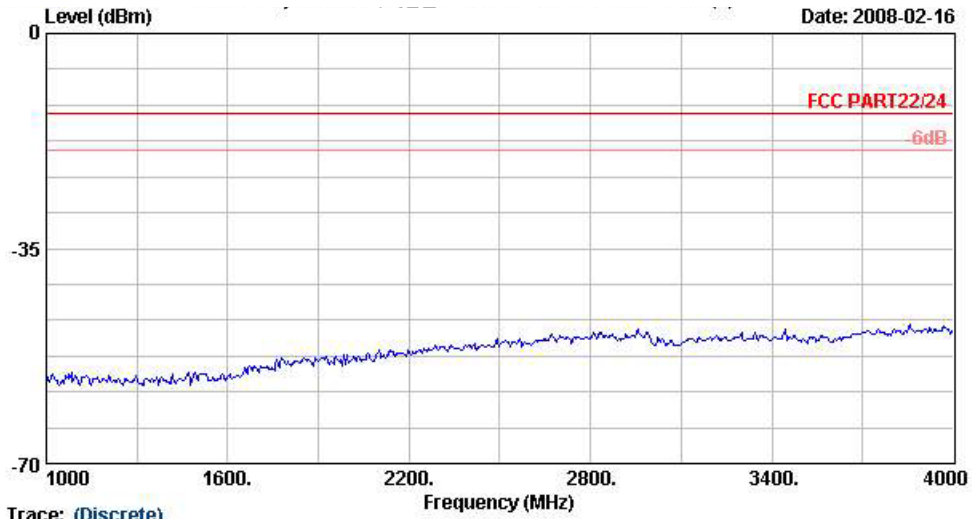

Trace: (Discrete)

Site : 03CH06-HY
Condition : FCC PART22/24 ETRP-071107 VERTICAL
EUT : Notebook
Power : 120Vac/60Hz
Model : FG 821323
Memo : HSDPA Link ; CH4182 + Adaptor
S/N : P601T-121STD1256

Remark : The spurious emission is too low to be taken.

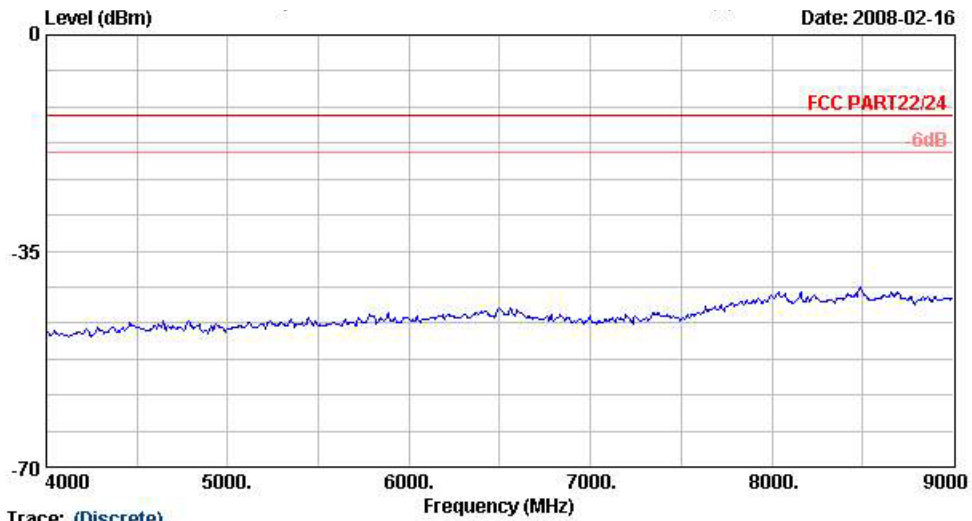

Trace: (Discrete)

Site : 03CH06-HY
Condition : FCC PART22/24 ETRP-071107 VERTICAL
EUT : Notebook
Power : 120Vac/60Hz
Model : FG 821323
Memo : HSDPA Link ; CH4182 + Adaptor
S/N : P601T-121STD1256

Remark : The spurious emission is too low to be taken.



Mode 7

Horizontal Polarization

Date: 2008-02-16

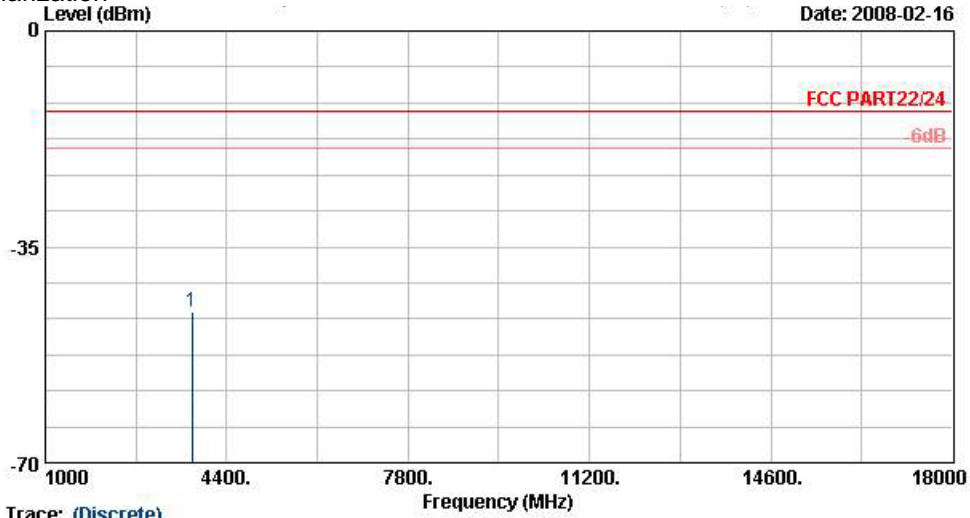

Trace: (Discrete)

Site : 03CH06-HY
 Condition : FCC PART22/24 ETRP-071107 HORIZONTAL
 EUT : Notebook
 Power : 120Vac/60Hz
 Model : FC 821323
 Memo : WCDMA Link ; CH9400 + Adaptor
 S/N : P601T-121STD1256

Frequency (MHz)	ERP (dBm)	Limit (dBm)	SPA Reading (dBm)	S.G. Power (dBm)	TX Cable loss (dB)	TX Antenna Gain (dBi)	Polarization (H/V)	Result
3756	-45.57	-13	-54.33	-49.5	7.17	11.1	H	Pass

Remark : Spurious emissions within 30-1000MHz were found more than 20dB below limit line.



Vertical Polarization

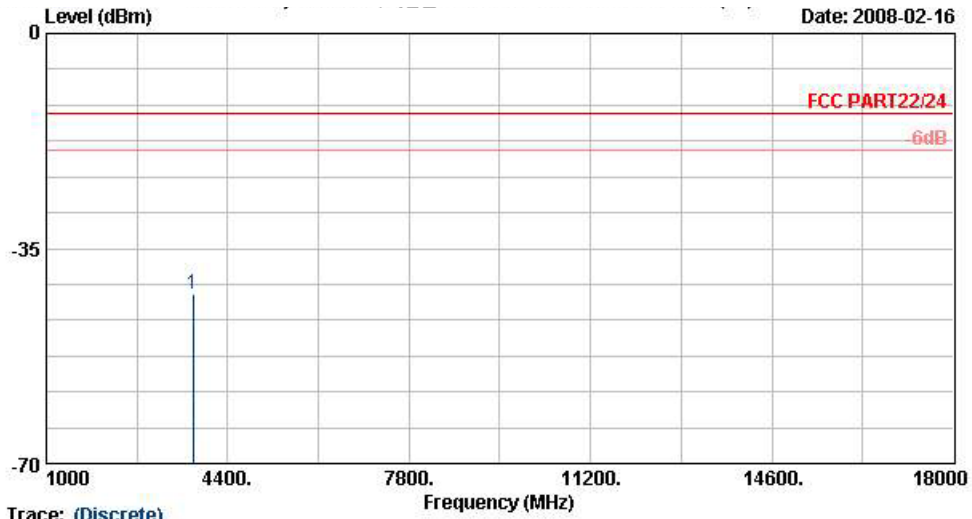

Trace: (Discrete)

Site : 03CH06-HY
 Condition : FCC PART22/24 EIRP-071107 VERTICAL
 EUT : Notebook
 Power : 120Vac/60Hz
 Model : FC 821323
 Memo : WCDMA Link ; CH0400 + Adaptor
 S/N : P601T-121STD1256

Frequency (MHz)	ERP (dBm)	Limit (dBm)	SPA Reading (dBm)	S.G. Power (dBm)	TX Cable loss (dB)	TX Antenna Gain (dBi)	Polarization (H/V)	Result
3756	-42.47	-13	-53.13	-46.4	7.17	11.1	V	Pass

Remark : Spurious emissions within 30-1000MHz were found more than 20dB below limit line.



Mode 8

Horizontal Polarization

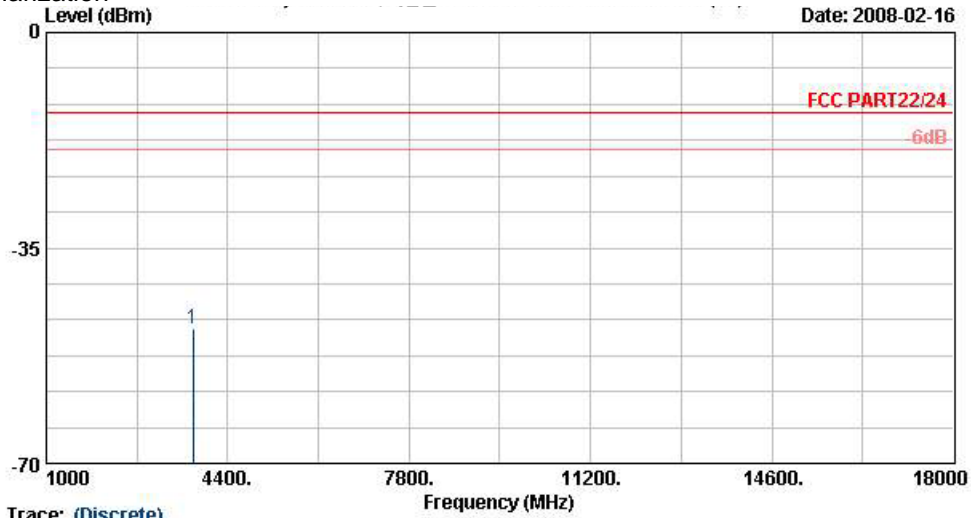

Trace: (Discrete)

Site : 03CH06-HY
 Condition : FCC PART22/24 ETRP-071107 HORIZONTAL
 EUT : Notebook
 Power : 120Vac/60Hz
 Model : FC 821323
 Memo : HSDPA Link ; CH9400 + Adaptor
 S/N : P601T-121STD1256

Frequency (MHz)	ERP (dBm)	Limit (dBm)	SPA Reading (dBm)	S.G. Power (dBm)	TX Cable loss (dB)	TX Antenna Gain (dBi)	Polarization (H/V)	Result
3756	-48.17	-13	-56.23	-52.1	7.17	11.1	H	Pass

Remark : Spurious emissions within 30-1000MHz were found more than 20dB below limit line.



Vertical Polarization

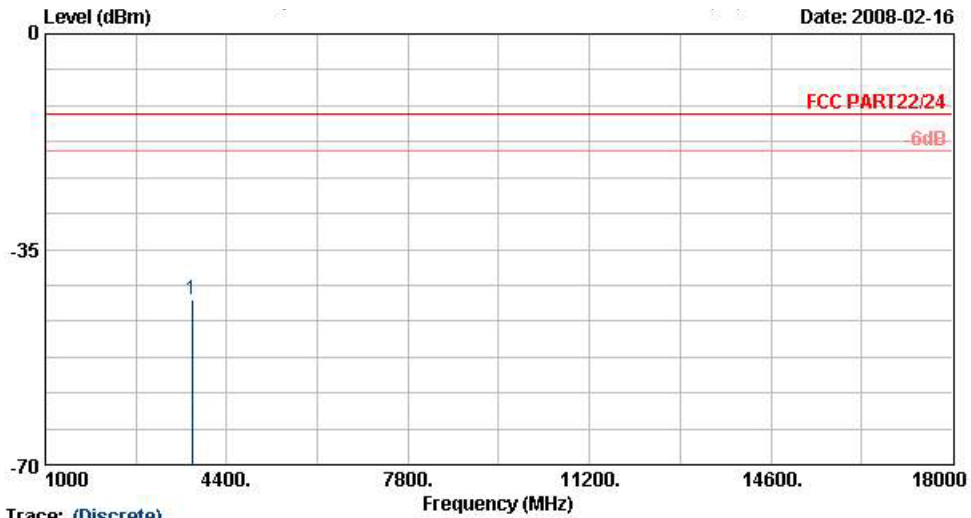

Trace: (Discrete)
 Site : 03CH06-HY
 Condition : FCC PART22/24 EIRP-071107 VERTICAL
 EUT : Notebook
 Power : 120Vac/60Hz
 Model : FC 821323
 Memo : HSDPA Link ; CH0400 + Adaptor
 S/N : P601T-121STD1256

Frequency (MHz)	ERP (dBm)	Limit (dBm)	SPA Reading (dBm)	S.G. Power (dBm)	TX Cable loss (dB)	TX Antenna Gain (dBi)	Polarization (H/V)	Result
3756	-43.07	-13	-53.64	-47	7.17	11.1	V	Pass

Remark : Spurious emissions within 30-1000MHz were found more than 20dB below limit line.

4.7 Frequency Stability (Temperature Variation)

4.7.1 Measurement Instrument

As described in chapter 5 of this test report.

4.7.2 Test Procedure

- a. The EUT and test equipment were set up as shown on the following section.
- b. With all power removed, the temperature was decreased to -30°C and permitted to stabilize for three hours. Power was applied and the maximum change in frequency was noted within one minute.
- c. With power OFF, the temperature was raised in 10°C steps. The sample was permitted to stabilize at each step for at least one-half hour. Power was applied and the maximum frequency change was noted within one minute.
- d. The temperature tests were performed for the worst case.
- e. Test data was recorded.

4.7.3 Test Setup Layout

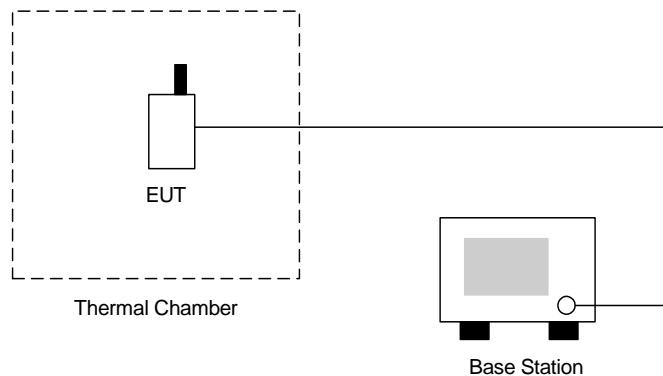



4.7.4 Test Result

• Test Mode : GSM850 (GSM) CH189

Temperature()	Change (Hz)	Change (ppm)	Limit (ppm)	Result
-30	-36	-0.02	2.5	Passed
-20	19	0.02		
-10	22	0.03		
0	20	0.02		
10	24	0.03		
20	17	0.02		
30	14	0.02		
40	11	0.01		
50	9	0.01		

• Test Mode : GSM850 (EDGE) CH189

Temperature()	Change (Hz)	Change (ppm)	Limit (ppm)	Result
-30	14	0.01	2.5	Passed
-20	16	0.02		
-10	-38	-0.04		
0	24	0.03		
10	-17	-0.02		
20	-37	-0.04		
30	-33	-0.04		
40	-39	-0.05		
50	-46	-0.05		



• Test Mode : PCS1900 (GSM) CH661

Temperature()	Change (Hz)	Change (ppm)	Limit (ppm)	Result
-30	-41	-0.02	2.5	Passed
-20	-46	-0.02		
-10	48	0.03		
0	-40	-0.02		
10	-54	-0.03		
20	-48	-0.03		
30	-41	-0.02		
40	-34	-0.02		
50	-28	-0.01		

• Test Mode : PCS1900 (EDGE) CH661

Temperature()	Change (Hz)	Change (ppm)	Limit (ppm)	Result
-30	30	0.02	2.5	Passed
-20	-33	-0.02		
-10	-49	-0.03		
0	-37	-0.02		
10	-42	-0.02		
20	-45	-0.02		
30	-51	-0.03		
40	-47	-0.02		
50	-61	-0.03		

• Test Mode : WCDMA Band V CH4182

Temperature()	Change (Hz)	Change (ppm)	Limit (ppm)	Result
-30	12	0.01	2.5	Passed
-20	-11	-0.01		
-10	-18	-0.02		
0	-14	-0.02		
10	-16	-0.02		
20	-18	-0.02		
30	-13	-0.02		
40	-14	-0.02		
50	-20	-0.02		



• Test Mode : WCDMA Band V (HSDPA) CH4182

Temperature()	Change (Hz)	Change (ppm)	Limit (ppm)	Result
-30	20	0.02	2.5	Passed
-20	-19	-0.02		
-10	-22	-0.03		
0	18	0.02		
10	-11	-0.01		
20	-10	-0.01		
30	15	0.02		
40	13	0.02		
50	17	0.02		

• Test Mode : WCDMA Band II CH9400

Temperature()	Change (Hz)	Change (ppm)	Limit (ppm)	Result
-30	-35	-0.02	2.5	Passed
-20	20	0.01		
-10	-24	-0.01		
0	-19	-0.01		
10	17	0.01		
20	39	0.02		
30	-15	-0.01		
40	21	0.01		
50	-29	-0.02		

• Test Mode : WCDMA Band II (HSDPA) CH9400

Temperature()	Change (Hz)	Change (ppm)	Limit (ppm)	Result
-30	32	0.02	2.5	Passed
-20	29	0.02		
-10	26	0.01		
0	-22	-0.01		
10	-28	-0.01		
20	26	0.01		
30	21	0.01		
40	-25	-0.01		
50	-30	-0.02		

4.8 Frequency Stability (Voltage Variation)

4.8.1 Measurement Instrument

As described in chapter 5 of this test report.

4.8.2 Test Procedure

- a. The EUT was placed in a temperature chamber at $25\pm 5^{\circ}\text{C}$ and connected as the following section.
- b. The power supply voltage to the EUT was varied from BEP to 115% of the nominal value measured at the input to the EUT.
- c. The variation in frequency was measured for the worst case.

4.8.3 Test Setup Layout

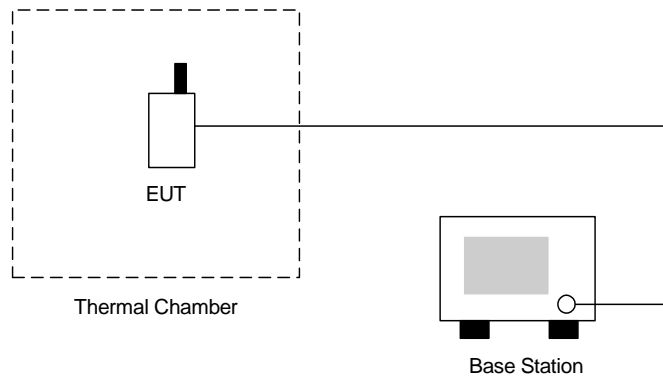

4.8.4 Test Result

- Test Mode : GSM850 (GSM) CH189

Voltage(Volt)	Change (Hz)	Change (ppm)	Limit (ppm)	Result
230	26	0.03	2.5	Passed
BEP	30	0.04		
253	28	0.03		

- Test Mode : GSM850 (EDGE) CH189

Voltage(Volt)	Change (Hz)	Change (ppm)	Limit (ppm)	Result
230	18	0.02	2.5	Passed
BEP	26	0.03		
253	21	0.02		



- Test Mode : PCS1900 (GSM) CH661

Voltage(Volt)	Change (Hz)	Change (ppm)	Limit (ppm)	Result
230	-54	-0.03	2.5	Passed
BEP	-48	-0.03		
253	-52	-0.03		

- Test Mode : PCS1900 (EDGE) CH661

Voltage(Volt)	Change (Hz)	Change (ppm)	Limit (ppm)	Result
230	-27	-0.01	2.5	Passed
BEP	-30	-0.02		
253	-29	-0.02		

- Test Mode : WCDMA Band V CH4182

Voltage(Volt)	Change (Hz)	Change (ppm)	Limit (ppm)	Result
230	-13	-0.02	2.5	Passed
BEP	-17	-0.02		
253	10	0.01		

- Test Mode : WCDMA Band V (HSDPA) CH4182

Voltage(Volt)	Change (Hz)	Change (ppm)	Limit (ppm)	Result
230	-12	-0.01	2.5	Passed
BEP	14	0.02		
253	18	0.02		

- Test Mode : WCDMA Band II CH9400

Voltage(Volt)	Change (Hz)	Change (ppm)	Limit (ppm)	Result
230	-23	-0.01	2.5	Passed
BEP	19	0.01		
253	24	0.01		

- Test Mode : WCDMA Band II (HSDPA) CH9400

Voltage(Volt)	Change (Hz)	Change (ppm)	Limit (ppm)	Result
230	-22	-0.01	2.5	Passed
BEP	29	0.02		
253	25	0.01		

Remark:

- Normal Voltage= 230V.
- Battery End Point (BEP)= 207V.



5. List of Measurement Equipments

Instrument	Manufacturer	Model No.	Serial No.	Characteristics	Calibration Date	Due Date	Remark
Spectrum Analyzer	Agilent	E4408B	MY44211028	9KHz-26.5GHz	Oct. 17, 2007	Oct. 16, 2008	Radiation (03CH06-HY)
EMI Test Receiver	R&S	ESCS30	100356	9KHz-2.75GHz	Jul. 26, 200	Jul. 25, 2008	Radiation (03CH06-HY)
Bilog Antenna	SCHAFFNER	CBL6112B	2885	30MHz -2GHz	Nov. 01, 2007	Nov. 30, 2008	Radiation (03CH06-HY)
Double Ridge Horn Antenna	Com-Power	AH118	071025	1G~18G	Jun. 04, 2007	Jun. 03, 2008	Radiation (03CH06-HY)
SHF-EHF Horn	SCHWARZBEC K	BBHA 9170	9170-249	14G - 40G	Nov. 20, 2006	Nov. 19, 2008	Radiation (03CH06-HY)
Pre Amplifier	Agilent	8449B	3008A01917	1G - 26.5G	Nov. 22, 2007	Nov. 21, 2008	Radiation (03CH06-HY)
PreAmplifier	EMEC	PA303	PA303-SMA-059	100K~3GHz	Nov. 26, 2007	Nov. 25, 2008	Radiation (03CH06-HY)
Base Station Simulator	R & S	CMU200	103937	Third-Band	Oct. 19, 2007	Oct. 18, 2008	Radiation (03CH06-HY)
Thermal Chamber	Tenyi technology	TTH-D35P	TBN-930701	N/A	Aug. 02, 2007	Aug. 01, 2008	Conduction (TH02-HY)
Spectrum	R&S	FSP40	100055	9KHz~40GHz	Jun. 25, 2007	Jun. 24, 2008	Conduction (TH02-HY)
Bluetooth Test	ANRITSU	MT8852A	6K00003939	N/A	N/A	N/A	Conduction (TH02-HY)
Power Divider	ARRA	5200-1	3871	N/A	Oct. 01, 2007	Sep. 30, 2008	Conduction (TH02-HY)
DC Power Supply	TOPWARD	3303D	740889	N/A	May 25, 2007	May 24, 2009	Conduction (TH02-HY)
Power Meter	Agilent	E4416A	GB41292344	N/A	Feb. 21, 2008	Feb. 20, 2009	Conduction (TH02-HY)
Power Sensor	Agilent	E9327A	US40441548	N/A	Feb. 21, 2008	Feb. 20, 2009	Conduction (TH02-HY)

6. Uncertainty Evaluation

Uncertainty of Radiated Emission Measurement (30MHz ~ 1000MHz)

Contribution	Uncertainty of x_i		$u(x_i)$
	dB	Probability Distribution	
Receiver reading	0.41	Normal(k=2)	0.21
Antenna factor calibration	0.83	Normal(k=2)	0.42
Cable loss calibration	0.25	Normal(k=2)	0.13
Pre Amplifier Gain calibration	0.27	Normal(k=2)	0.14
RCV/SPA specification	2.50	Rectangular	0.72
Antenna Factor Interpolation for Frequency	1.00	Rectangular	0.29
Site imperfection	1.43	Rectangular	0.83
Mismatch	+0.39/-0.41	U-shaped	0.28
Combined standard uncertainty Uc(y)	1.27		
Measuring uncertainty for a level of confidence of 95% U=2Uc(y)	2.54		

Uncertainty of Radiated Emission Measurement (1GHz ~ 40GHz)

Contribution	Uncertainty of x_i		$u(x_i)$	C_i	$C_i * u(x_i)$
	dB	Probability Distribution			
Receiver reading	±0.10	Normal(k=1)	0.10	1	0.10
Antenna factor calibration	±1.70	Normal(k=2)	0.85	1	0.85
Cable loss calibration	±0.50	Normal(k=2)	0.25	1	0.25
Receiver Correction	±2.00	Rectangular	1.15	1	1.15
Antenna Factor Directional	±1.50	Rectangular	0.87	1	0.87
Site imperfection	±2.80	Triangular	1.14	1	1.14
Mismatch Receiver VSWR $\Gamma_1 = 0.197$ Antenna VSWR $\Gamma_2 = 0.194$ Uncertainty = $20 \log(1 - \Gamma_1 * \Gamma_2 * \Gamma_3)$	+0.34/-0.35	U-shaped	0.244	1	0.244
Combined standard uncertainty Uc(y)	2.36				
Measuring uncertainty for a level of confidence of 95% U=2Uc(y)	4.72				

END OF TEST REPORT