

# TEST REPORT

of

## Dynamic Frequency Selection

Product : **Notebook Personal Computer**

Model(s): **V100**

(with SIERRA HSDPA Module, Model:MC8775V)

(with WLAN a/b/g Module, INTEL, Model:WM3945ABG)

(with Bluetooth Module, BILLIONTON, Model:GUBTCR42M)

Brand: **GETAC**

Applicant: **MITAC Technology Corporation**

Address: **4F, No.1, R&D Road 2,  
Hsinchu Science-Based industrial Park,  
Taiwan,R. O. C.**

Test Performed by:

**International Standards Laboratory**

<Lung-Tan LAB>

\*Site Registration No.

BSMI: SL2-IN-E-0013; TAF: 0997;IC: IC4164-1 ;

VCCI: R-1435, C-1440, T-299, R-2598, C-2845; NEMKO: ELA 113B

\*Address:

No. 120, Lane 180, San Ho Tsuen, Hsin Ho Rd.

Lung-Tan Hsiang, Tao Yuan County 325, Taiwan

\*Tel : 886-3-407-1718; Fax: 886-3-407-1738

Report No.: **ISL-07LR034FCDFS**

Issue Date : **2008/05/12**

## Contents of Report

1.	General .....	1
1.1	Certification of Accuracy of Test Data .....	1
1.2	Applicant & Manufacturer Information .....	2
1.3	Test Results Summary .....	2
2.	Description of Equipment Under Test (EUT) .....	3
3.	Description of Support Equipment.....	7
3.1	Description of Support Equipment .....	7
3.2	Software for Controlling Support Unit.....	7
3.2.1	I/O Cable Condition of EUT and Support Units.....	7
4.	TEST RESULTS (Dynamic Frequency Selection).....	8
4.1	Test Limits and Radar Signal Parameter .....	9
4.1.1	Interference Threshold.....	9
4.1.2	DFS Response Requirement .....	10
4.1.3	The Radar Test Waveform.....	11
4.1.4	Test Procedure .....	12
4.1.5	Test Configuration .....	12
4.1.6	List of Measurement .....	13
4.1.7	Test Results.....	13
4.1.8	Channel Closing Transmission Time and Channel Move Time .....	15
5.	Appendix .....	22
5.1	Test Equipment List .....	22

## 1. General

### 1.1 Certification of Accuracy of Test Data

<b>Standards:</b>	CFR 47 Part 15 Subpart E (Section 15.407)
<b>Test Procedure:</b>	ANSI C63.4:2003
<b>Equipment Tested:</b>	Notebook Personal Computer
<b>Model:</b>	V100
<b>Applied by:</b>	MITAC Technology Corporation
<b>Sample received Date</b>	2007/10/26
<b>Release Date</b>	2008/05/12
<b>Test Result</b>	PASS
<b>Test Site:</b>	Chamber 02, Conduction 02
<b>Temperature</b>	Refer to each site test data
<b>Humidity:</b>	Refer to each site test data
<b>Test Engineer:</b>	

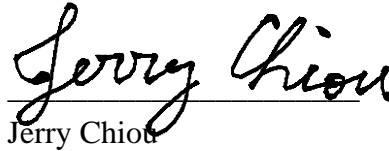
  
Jerry Chiu

All the tests in this report have been performed and recorded in accordance with the standards described above and performed by an independent electromagnetic compatibility consultant, International Standards Laboratory.

The test results contained in this report accurately represent the measurements of the characteristics and the energy generated by sample equipment under test at the time of the test. The sample equipment tested as described in this report is in compliance with the limits of above standards.

Approve & Signature

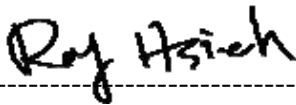

Roy Hsieh / Manager

Test results given in this report apply only to the specific sample(s) tested under stated test conditions. This report shall not be reproduced other than in full without the explicit written consent of ISL. This report totally contains 24 pages, including 1 cover page, 1 contents page, and 22 pages for the test description.

This test data shown below is traceable to NIST or national or international standard. International Standards Laboratory certifies that no party to this application has been denied the FCC benefits pursuant to Section 5301 of the Anti-Drug Abuse Act of 1988, 21 U.S.C. 853(a).

## 1.2 Applicant & Manufacturer Information

Applicant: Mitac Technology Corp  
No. 1, R&D 2nd RD., Hsin-Chu Science Based Industrial Park  
Hsin-Chu Hsien,  
Taiwan

Manufacturer 1: Mitac Technology Corp  
No. 1, R&D 2nd RD., Hsin-Chu Science Based Industrial Park  
Hsin-Chu Hsien,  
Taiwan

Manufacturer 2: Getac Technology (Kunshan) Co., Ltd  
No. 269, 2nd Road, Export Processing Zone,  
Changjiang South, Road,  
Kunshan, Jiangsu, P.R.C Zip code: 215300

## 1.3 Test Results Summary

The 802.11a functions of EUT has been tested to the FCC regulations listed below:

Tested Standards: 47 CFR Part 15 Subpart E			
Standard Section	Test Type	Result	Remarks
15.407 (h)	Dynamic Frequency Selection	Pass	

## 2. Description of Equipment Under Test (EUT)

Description:	Notebook Personal Computer
Condition:	Pre-Production
Model:	V100
Brand:	GETAC
Wireless LAN Module:	Intel, Model: WM3945ABG (MOW1 Driver:V.11.1.1.1)
Bluetooth Module:	BILLIONTON (Model:GUBTCR42M)
Frequency Range of 802.11a:	5150 - 5250 MHz 5250 - 5350 MHz 5725 - 5850 MHz
Frequency Range of 802.11b/g:	2400 - 2483.5 MHz
Frequency Range of Bluetooth:	2400 - 2483.5 MHz
Support channel:	
802.11a Normal mode	13 Channels
802.11b/g	11 Channels
Bluetooth	79 Channels
Modulation Skill:	
802.11a	OFDM (6 Mbps – 54 Mbps)
802.11b	DBPSK(1Mbps), DQPSK(2Mbps), CCK(5.5/11Mbps)
802.11g	OFDM (6M - 54Mbps)
Bluetooth	GFSK (1Mbps) DQPSK(2Mbps), 8DPSK(3Mbps)
Antennas Type:	
WLAN Right antenna:	PIFA (P/N: IA-060076) White made by JOINSON ELECTRONICS MFG. CO., LTD
WLAN Left antenna:	PIFA (P/N: IA-060239) Black made by JOINSON ELECTRONICS MFG. CO., LTD
Bluetooth antenna:	PIFA Antenna(P/N: IA060093), made by JOINSON ELECTRONICS MFG. CO.,LTD.
Antenna Connected:	Connected to RF connector on the PCB of the Bluetooth or WLAN module .The user is not possible to change the antenna without disassembling the notebook computer.
Antenna peak Gain:	
WLAN Right antenna	1.61dBi(11b,11g), 2.45dBi(11a)
WLAN Left antenna	-0.55 dBi (11b,11g), 3.97 dBi (11a)
Bluetooth antenna	-0.8 dBi
Power Type of wireless module:	3.3V DC from Notebook PC
Power Type of Bluetooth module:	3.3V DC from Notebook PC

The channel and the operation frequency of 802.11a listed below:

Channel	Frequency(MHz)	Channel	Frequency(MHz)
01	5180	02	5200
03	5220	04	5240
05	5260	06	5280
07	5300	08	5320
09	5745	10	5765
11	5785	12	5805
13	5825		

The channel and the operation frequency of 802.11b and 802.11g listed below:

Channel	Frequency(MHz)	Channel	Frequency(MHz)
01	2412	07	2442
02	2417	08	2447
03	2422	09	2452
04	2427	10	2457
05	2432	11	2462
06	2437		

The channels and the operation frequency of Bluetooth listed below:

Channel	Frequency(MHz)	Channel	Frequency(MHz)
00	2402	01	2403
02	2404	03	2405
04	2406	05	2407
.....			
75	2477	76	2478
77	2479	78	2480

WWAN HW version	SIERRA,Model:MC5725V, REV2.0
WWAN TX Frequency	CDMA2000 Cellular : 824MHz~849MHz CDMA2000 PCS : 1850MHz ~ 1910MHz
WWAN Rx Frequency	CDMA2000 Cellular : 869MHz~894MHz CDMA2000 PCS : 1930MHz ~ 1990MHz
WWAN Antenna Type	PIFA Antenna
WWAN Antenna Gain	0.52dBi (850MHz), 2.06dBi(1900MHz)
WWAN Type of Antenna Connector	I-PEX

CPU:	Genuine intel U2500 1.2GHz
Adapter Type:	Auto Switching AC Adapter 100-240V,1.2A 50-60Hz EPS (Model: F10903-A)
Hard Disk Driver:	Toshiba (Model:MK8032GSX) 80G or Toshiba (Model:MK1234GSX) 120G Conexant (Model: RD-02-D330)
Modem Card:	
USB Connector:	two 4 pin
RJ11 Connector:	one 2 pin
Serial Port:	two 9 pin
RJ45 Connector:	one 8 pin
Line out Port:	one
Line-in Port:	one
SD Card Port:	one
PCMCIA Slot:	two
DC IN Port:	one
Battery:	MITAC(Model: BP-LC2600/33-0151), 11.1Vdc, 7800mAh
LCD:	Toshiba(Model: LTD104KA1S) or Toshiba(Model: LTD121EXEV)
DDR:	Infineon(Model:PC2-4200S-444-11-A0) 512M Hnnix(Model:PC2-5300S555-12) 1G
Power Cord:	Non-shielded, Detachable

Test configuration:

configuration	LCD	CPU	Adapter Type	Hard Disk	Modem Card	Wireless LAN Card	Battery	DDR
1	Toshiba( Model: LTD104 KA1S)	Genuine intel U2500 1.2GHz	EPS (Model: F10903-A)	Toshiba (Model:MK1234GSX ) 120G	Conexant (Model: RD-02-D330)	Intel(Model :WM3945 ABG)	MITAC(M odel:BP-L C2600/33-0 151)	Hnnix(M odel:PC2 -5300S5 55-12)
2	Toshiba( Model: LTD121E XEV)	Genuine intel U2500 1.2GHz	EPS (Model: F10903-A)	Toshiba (Model:MK1234GSX ) 120G	Conexant (Model: RD-02-D330)	Intel(Model :WM3945 ABG)	MITAC(M odel:BP-L C2600/33-0 151)	Hnnix(M odel:PC2 -5300S5 55-12)

All types of LCD 、 CPU 、 Adapter Type 、 Hard Disk 、 Modem Card 、 Wireless LAN Card 、 Battery 、 DDR with related components have been tested, only shown the worst data using the following configuration in this report.

configuration	LCD	CPU	Adapter Type	Hard Disk	Modem Card	Wireless LAN Card	Battery	DDR
2	Toshiba( Model: LTD121E XEV)	Genuine intel U2500 1.2GHz	EPS (Model: F10903-A)	Toshiba (Model:MK1234GSX ) 120G	Conexant (Model: RD-02-D330)	Intel(Model :WM3945 ABG)	MITAC(M odel:BP-L C2600/33-0 151)	Hnnix(M odel:PC2 -5300S5 55-12)

**EMI Noise Source:**

- GPS board Crystal: 12MHz(X1)
- Touch Panel board Crystal:7.372MHz(X1)
- SD card board Crystal:12MHz(X2)
- Main board Crystal:25MHz(X3),10MHz(X2),14.318MHz(X501)
- Clock Generator: U514

**EMI Solution:**

1. Adding shielded tape on LCD Signal cable
2. Adding Gasket on LCD Signal cable
3. Adding Gasket on LCD Panel around
4. Adding Gasket on Bluetooth Module
5. Adding aluminum foil on 3GCDMA antenna
6. Adding Copper on Main board
7. Adding Copper on Modem Card
8. Adding Gasket on Main board
9. Adding Gasket on Modem Card
10. Adding Core(A5 FS 16\*5\*12) on LAN Signal cable
11. Adding Core(A3 FS 15\*3\*11) on Modem Card Signal cable
12. Adding Core(K5B RH 6.35\*15.8\*3.3) on DC IN Jack
13. Adding aluminum foil on Case
14. Adding Core(FPC 40\*2.7\*12-K) on Keyboard Signal cable
15. Adding Core(RC 16\*28\*9 -M2) on Adapter Type Signal cable



### 3. Description of Support Equipment

#### 3.1 Description of Support Equipment

Unit	Model Serial No.	Brand	Power Cord	FCC ID
802.11a/b/g Access Point (for DFS test)	AIR-AP1242AG-A-K9 S/N: FTX1120B6SQ	Cisco	Non-shielded, Detachable	LDK102056
Notebook Personal Computer (for DFS test)	X40 S/N: NA	IBM	Non-shielded Detachable	FCC DOC

#### 3.2 Software for Controlling Support Unit

Test programs exercising various part of EUT were used. The programs were executed as follows:

- A. Read and write to the disk drives.
- B. The RF software makes the transmitter continuously sending RF signals
- C. Eut link to the support PC , and play the “TestFile.mpeg” (NTIA approved) which save at the support PC (for DFS test).
- D. Repeat the above steps.

	Filename	Issued Date
Media player with the V2.61 Codec package (for DFS test)	mplayerc.exe	--
CRTU 3945ABG version 4.0.18.0000	CRTU.exe	2005/10/16

#### 3.2.1 I/O Cable Condition of EUT and Support Units

Description	Path	Cable Length	Cable Type	Connector Type
AC Power Cord*2	110V (~240V) to AC Power Cord Inlet (3-pin)	1.8M	Nonshielded, Detachable	Plastic Head
LAN Cable	AP to Support PC LAN port	1.5M	Nonshielded, Detachable	Plastic Head

#### 4. TEST RESULTS (Dynamic Frequency Selection)

Tables 1 lists the DFS related essential requirements and their applicability for each of the operational modes.

The manufacturer shall state whether the EUT is capable of operating as a Master and/or a Slave. If the EUT is capable of operating in more than one operating mode then each operating mode shall be tested separately.

**Table 1: Applicability of DFS Requirements Prior to Use of a Channel**

Requirement	Operational Mode		
	Master	Slave (without radar detection)	Slave (with radar detection)
Non-Occupancy Period	V	NA	V
DFS Detection Threshold	V	NA	V
Channel Availability Check Time	V	NA	NA
Uniform Spreading	V	NA	NA
U-NII Detection Bandwidth	V	NA	V

**Table 2: Applicability of DFS requirements during normal operation**

Requirement	Operational Mode		
	Master	Slave (without radar detection)	Slave (with radar detection)
DFS Detection Threshold	V	NA	V
Channel Closing Transmission Time	V	V	V
Channel Move Time	V	V	V
U-NII Detection Bandwidth	V	NA	V

**Table 3: Operating frequency range of EUT.**

Operational Mode	Operating Frequency Range	
	5250~5350MHz	5470~5725MHz
Master	NA	NA
Slave (without radar detection)	V	NA
Slave (with radar detection)	NA	NA

## 4.1 Test Limits and Radar Signal Parameter

### 4.1.1 Interference Threshold

#### DFS Detection Thresholds for Master Devices and Client Devices With Radar Detection.

Maximum Transmit Power	Value (See Notes 1 and 2)
>200mW (>23dBm)	-64dBm
<200mW (<23dBm)	-62dBm

Note 1: This is the level at the input of the receiver assuming a 0 dBi receive antenna.

Note 2: Throughout these test procedures an additional 1 dB has been added to the amplitude of the test transmission waveforms to account for variations in measurement equipment. This will ensure that the test signal is at or above the detection threshold level to trigger a DFS response.

#### 4.1.2 DFS Response Requirement

##### DFS Response Requirement Values.

Parameter	Value
Non-occupancy period	Minimum 30 minutes
Channel Availability Check Time	60 seconds
Channel Move Time	10 seconds See Note 1.
Channel Closing Transmission Time	200 milliseconds + an aggregate of 60 milliseconds over remaining 10 second period. See Notes 1 and 2.
U-NII Detection Bandwidth	Minimum 80% of the UNII 99% transmission power bandwidth. See Note 3.
<p><b>Note 1:</b> The instant that the Channel Move Time and the Channel Closing Transmission Time begins is as follows:</p> <ul style="list-style-type: none"> <li>● For the Short Pulse Radar Test Signals this instant is the end of the Burst.</li> <li>● For the Frequency Hopping radar Test Signal, this instant is the end of the last radar Burst generated.</li> <li>● For the Long Pulse Radar Test Signal this instant is the end of the 12 second period defining the Radar Waveform.</li> </ul> <p><b>Note 2:</b> The Channel Closing Transmission Time is comprised of 200 milliseconds starting at the beginning of the Channel Move Time plus any additional intermittent control signals required to facilitate a Channel move (an aggregate of 60 milliseconds) during the remainder of the 10 second period. The aggregate duration of control signals will not count quiet periods in between transmissions.</p> <p><b>Note 3:</b> During the U-NII Detection Bandwidth detection test, radar type 1 is used and for each frequency step the minimum percentage of detection is 90 percent. Measurements are performed with no data traffic.</p>	

### 4.1.3 The Radar Test Waveform

Step intervals of 0.1 microsecond for Pulse Width, 1 microsecond for PRI, 1 MHz for chirp width and 1 for the number of pulses will be utilized for the random determination of specific test waveforms.

**Table 6 – Short Pulse Radar Test Waveforms**

Radar Type	Pulse Width (μsec)	PRI (μsec)	Number of Pulses	Minimum Percentage of Successful Detection	Minimum Number of Trials
1	1	1428	18	60%	30
2	1-5	150-230	23-29	60%	30
3	6-10	200-500	16-18	60%	30
4	11-20	200-500	12-16	60%	30
Aggregate (Radar Types 1-4)				80%	120

**Long Pulse Radar Test Waveform**

Radar Type	Pulse Width (μsec)	Chirp Width (MHz)	PRI (μsec)	Number of Pulses per Burst	Number of Burst	Minimum Percentage of Successful Detection	Minimum Number of Trials
5	50-100	5-20	1000-2000	1-3	8-20	80%	30

**Frequency Hopping Radar Test Waveform**

Radar Type	Pulse Width (μsec)	PRI (μsec)	Pulse per Hop	Hopping Rate (kHz)	Hopping Sequence Length (msec)	Minimum Percentage of Successful Detection	Minimum Number of Trials
6	1	333	9	0.333	300	70%	30

#### 4.1.4 Test Procedure

1. The measured channel is 5320MHz. The radar signal was the same as transmitted channels, and injected into the antenna port of AP (master) with interference threshold power level, measured the channel closing transmission time and channel move time. The slave transfers the test data to master, the transmitted duty cycle is 10%.  
\*Eut link to the support PC , and play the “TestFile.mpeg” (NTIA approved) which save at the support PC.
2. Exchange the position of Master and Client, and repeat Step 1: master to recheck the transfer data near Client.

#### 4.1.5 Test Configuration

##### Setup for Client with injection at the Master (Step 1: master)

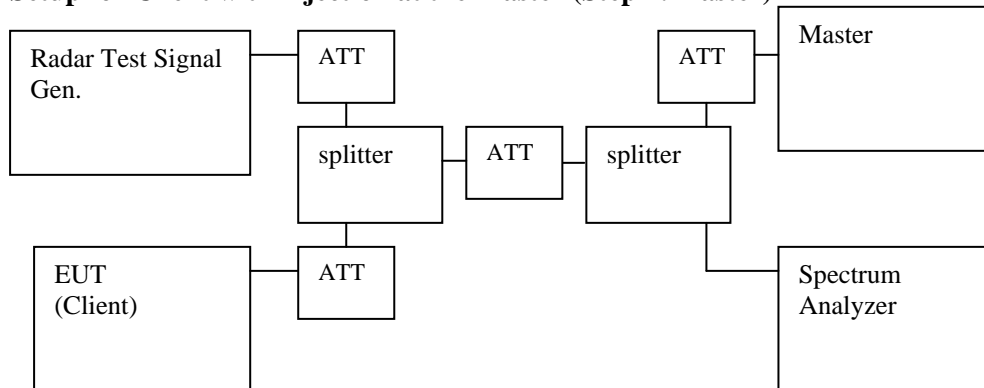

##### Setup for Client with injection at the Client (Step 2: Slave)

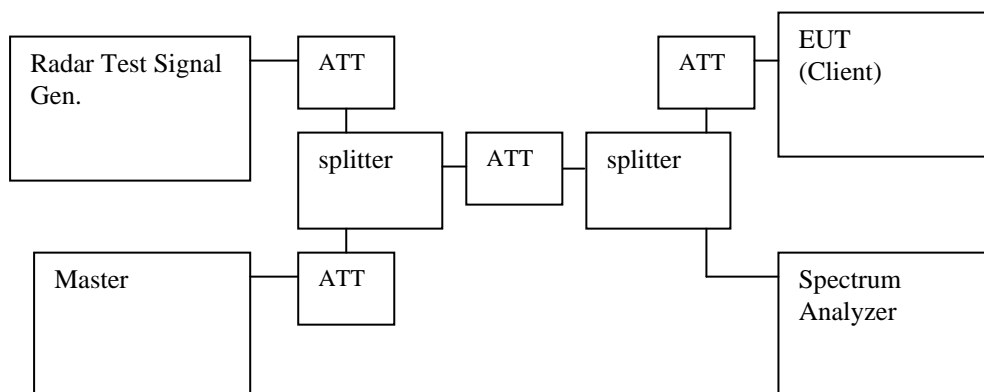

#### 4.1.6 List of Measurement

Clause	Requirement	Test Parameter	Remarks	Pass / Fail
4.6.2.3	Channel Shutdown	Channel Closing Transmission Time	Applicable	Pass
		Channel Move Time	Applicable	Pass

**NOTE:** This EUT is capable of operating as a Slave (without radar detection).

#### 4.1.7 Test Results

##### 4.1.7.1 Detection Threshold Values Injected Into AP

The Required detection threshold is -58dBm (= -62 +1+3)dBm. The Radar Burst signal level to the AP connector is -59dBm. The tested level is lower than required level hence it provides margin to the limit.

5320MHz Radar Signal 1(Step 1: master)

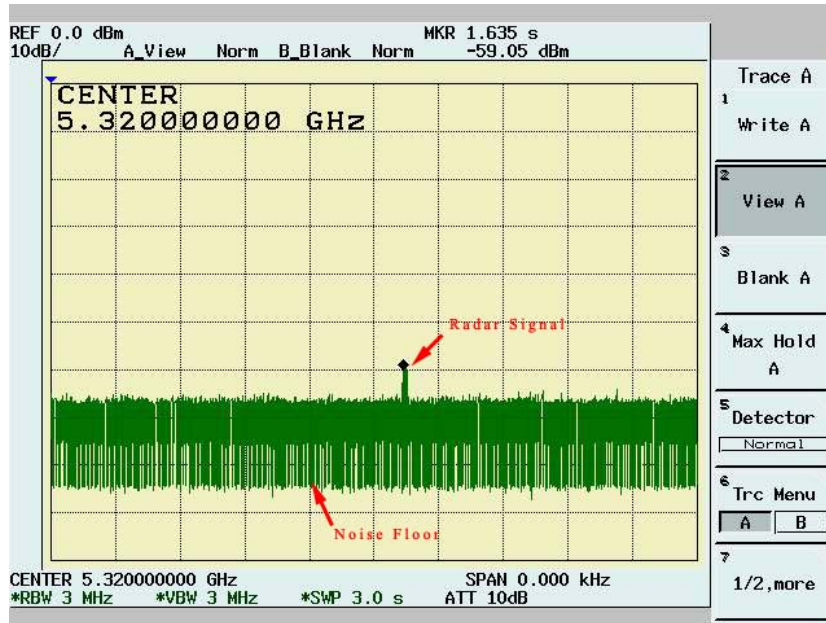

5320MHz Radar Signal 1(Step 2: Slave)

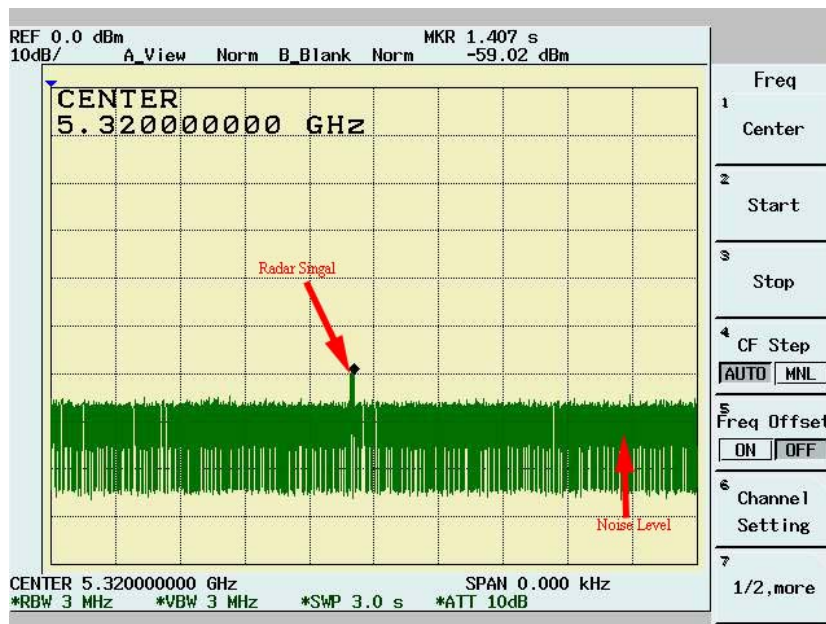



### 4.1.8 Channel Closing Transmission Time and Channel Move Time

The channel closing time is aggregated duration of all transmissions from the EUT during the channel move time. The Aggregate duration of all transmission of the EUT does not include quiet periods in between transmissions of the EUT.

**<Test Data>**

5320MHz Radar Signal 1(Step 1: master)

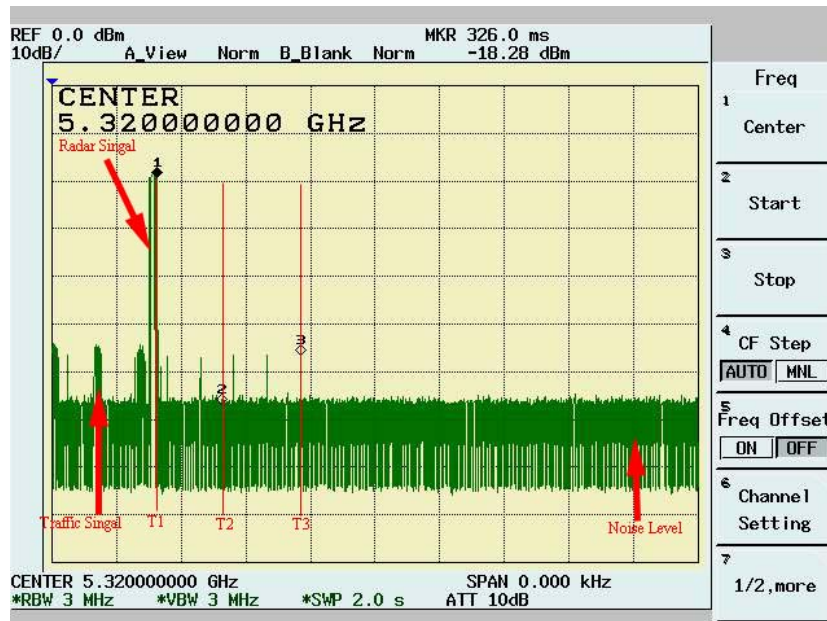
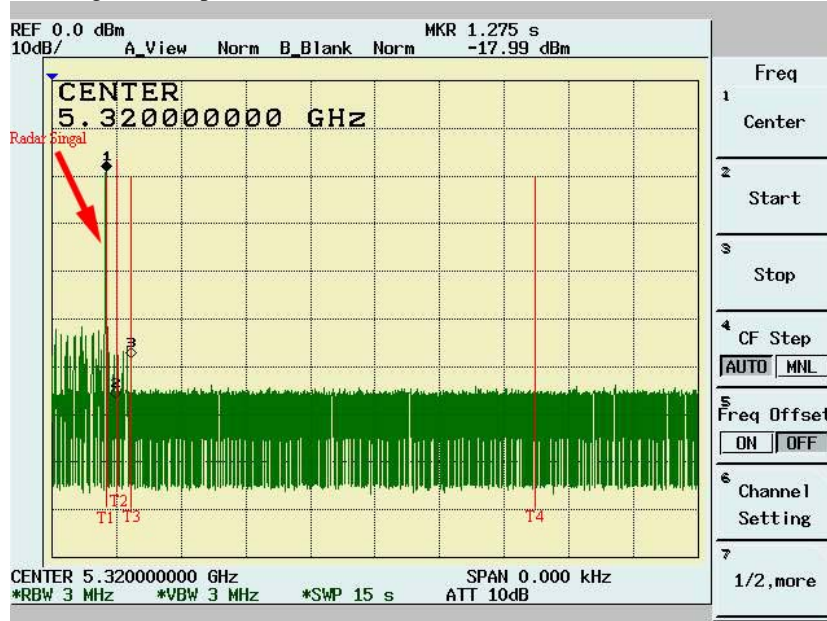

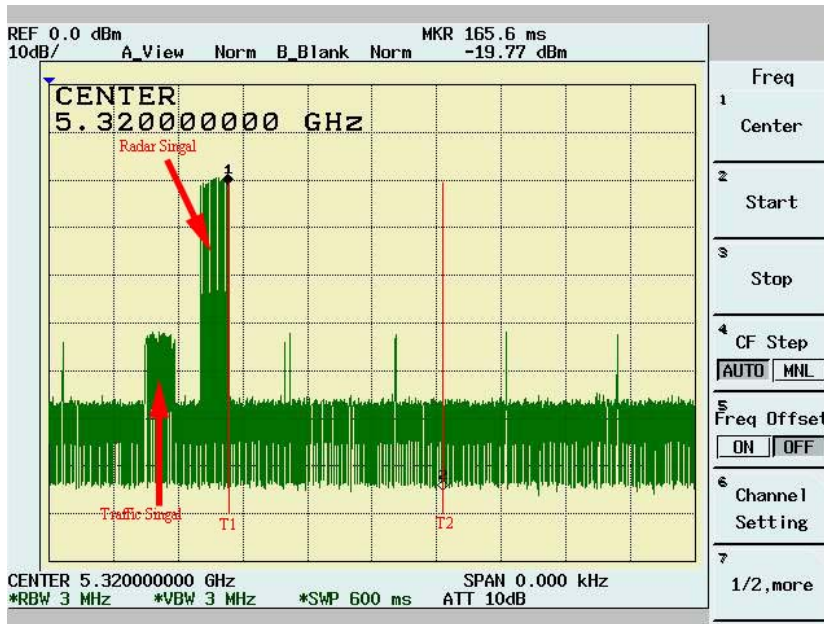

T1: Channel moving start.

T2: Normal transmissions complete.

T3: Channel moving complete.

T4: Channel moving time limit.

T3 – T1: Channel moving time = 540ms

T2 – T1: 200ms

NOTE: T1 denotes the start of Channel Move Time upon the end of the last Radar burst. T2 denotes the data transmission time of 200ms from T1. T3 denotes the 10 second from T1 to observe the aggregate duration of transmissions.

Frequency : 5320

Radar Type 1 Statistical Performances				
Trial #	Pulse Width	PRI (usec)	Number of Pulses	Detection
1	1	1428	18	Yes
2	1	1428	18	Yes
3	1	1428	18	Yes
4	1	1428	18	Yes
5	1	1428	18	Yes
6	1	1428	18	Yes
7	1	1428	18	Yes
8	1	1428	18	Yes
9	1	1428	18	No
10	1	1428	18	Yes
11	1	1428	18	Yes
12	1	1428	18	Yes
13	1	1428	18	Yes
14	1	1428	18	Yes
15	1	1428	18	Yes
16	1	1428	18	Yes
17	1	1428	18	Yes
18	1	1428	18	Yes
19	1	1428	18	Yes
20	1	1428	18	Yes
21	1	1428	18	Yes
22	1	1428	18	No
23	1	1428	18	Yes
24	1	1428	18	Yes
25	1	1428	18	Yes
26	1	1428	18	Yes
27	1	1428	18	Yes
28	1	1428	18	Yes
29	1	1428	18	No
30	1	1428	18	Yes
Detection Rate(%):				90.00

5320MHz Radar Signal 1(Step 2: Slave)

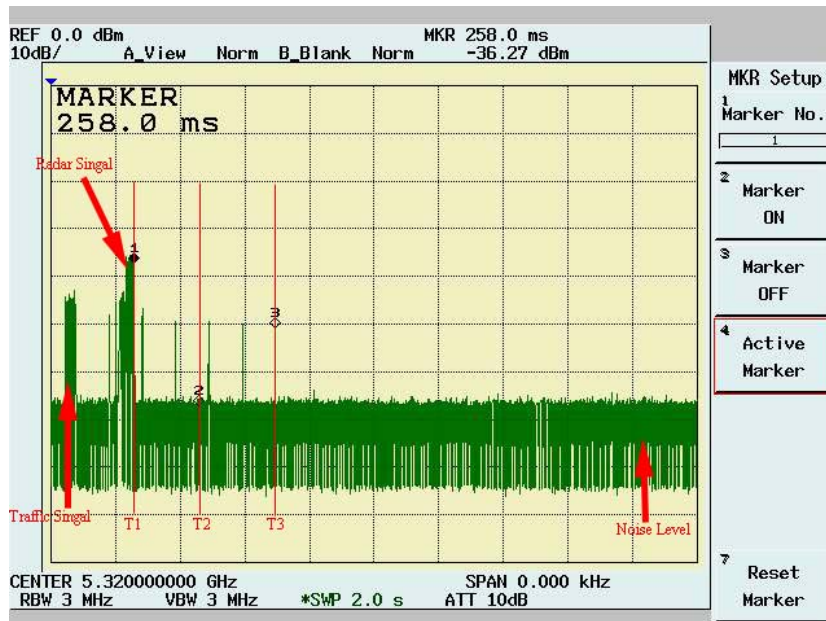
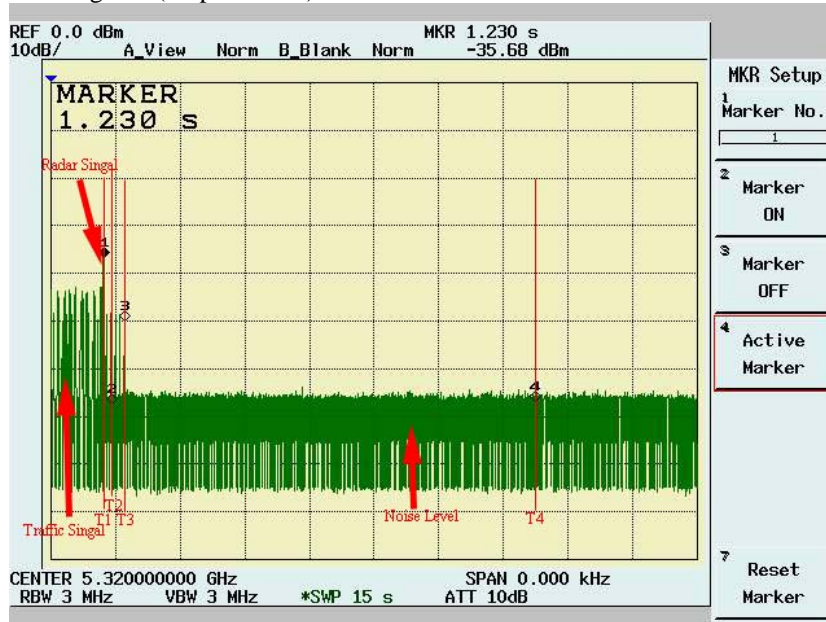

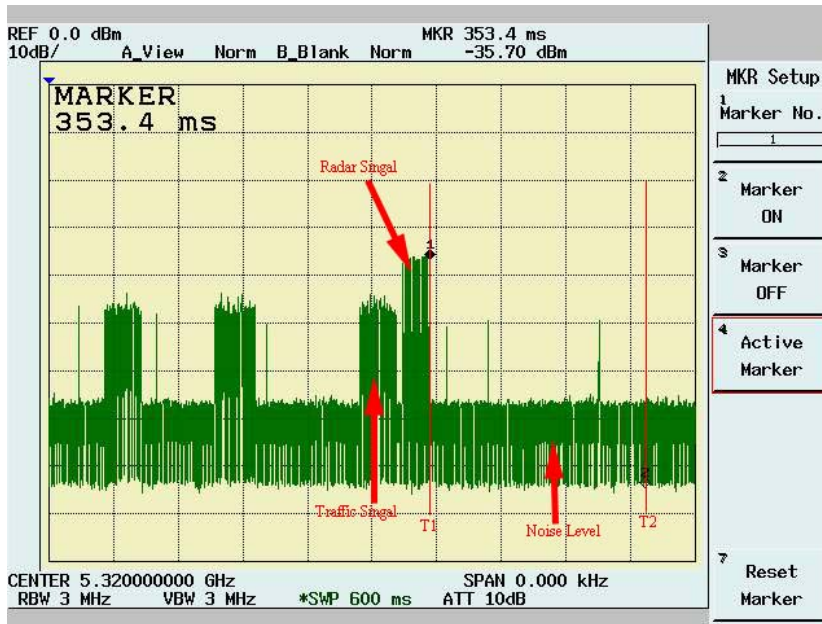

T1: Channel moving start.

T2: Normal transmissions complete.

T3: Channel moving complete.

T4: Channel moving time limit.

T3 – T1: Channel moving time = 540ms

T2 – T1: 200ms

NOTE: T1 denotes the start of Channel Move Time upon the end of the last Radar burst. T2 denotes the data transmission time of 200ms from T1. T3 denotes the 10 second from T1 to observe the aggregate duration of transmissions.

Frequency : 5320

Radar Type 1 Statistical Performances				
Trial #	Pulse Width	PRI (usec)	Number of Pulses	Detection
1	1	1428	18	Yes
2	1	1428	18	Yes
3	1	1428	18	No
4	1	1428	18	Yes
5	1	1428	18	Yes
6	1	1428	18	Yes
7	1	1428	18	No
8	1	1428	18	Yes
9	1	1428	18	Yes
10	1	1428	18	Yes
11	1	1428	18	Yes
12	1	1428	18	Yes
13	1	1428	18	Yes
14	1	1428	18	Yes
15	1	1428	18	Yes
16	1	1428	18	Yes
17	1	1428	18	No
18	1	1428	18	Yes
19	1	1428	18	Yes
20	1	1428	18	Yes
21	1	1428	18	Yes
22	1	1428	18	Yes
23	1	1428	18	Yes
24	1	1428	18	Yes
25	1	1428	18	Yes
26	1	1428	18	Yes
27	1	1428	18	Yes
28	1	1428	18	No
29	1	1428	18	Yes
30	1	1428	18	Yes
Detection Rate(%):				86.67



#### 4.1.8.1.1 Non-Occupancy Period Measurement

The operating channel frequency is 5320 MHz. The test result is more than 30 minutes. The EUT detected the radar signal and change to another transmitted channel. The EUT did not return to original operating on a channel 5320 MHz.

5320MHz Radar Signal 1(Step 1)

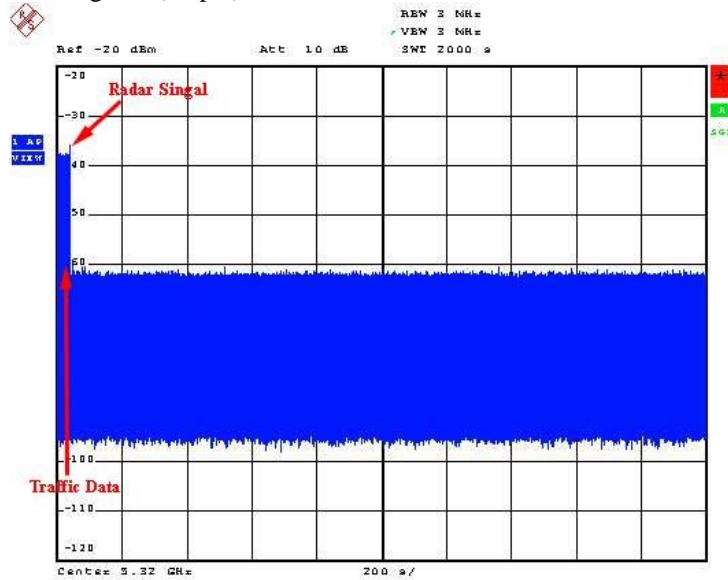

5320MHz Radar Signal 1(Step 2)

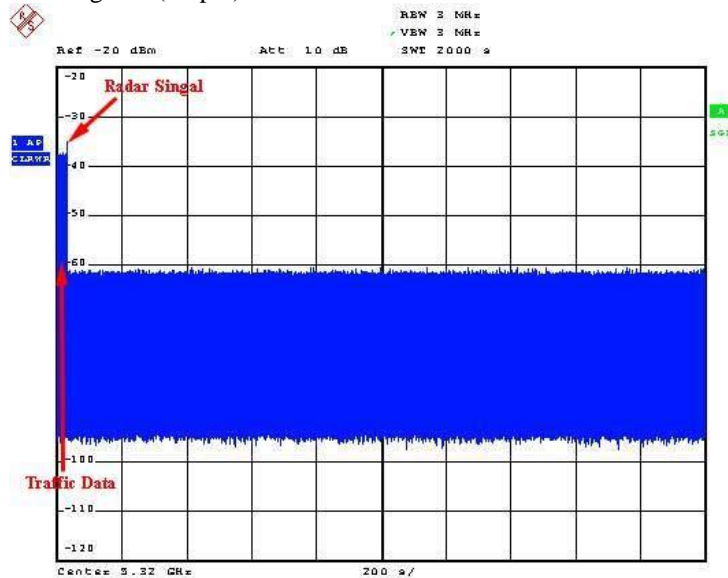

## 5. Appendix

### 5.1 Test Equipment List

Location	Equipment Name	Brand	Model	S/N	Last Cal. Date	Next Cal. Date
Conduction	Coaxial Cable 1F-C2	Harbourindustries	RG400	1F-C2	02/13/2008	02/13/2009
Conduction	Digital Hygro-Thermometer Conduct	MicroLife	HT-2126G	ISL-Conduction02	12/26/2007	12/26/2008
Conduction	EMI Receiver 07	Schwarzbeck Mess-Elektronik	FCKL 1528	1528-201	08/31/2007	08/30/2008
Conduction	LISN 01	R&S	ESH2-Z5	890485/013	01/03/2008	01/03/2009
Conduction	LISN 06	R&S	ESH3-Z5	828874/009	12/14/2007	12/14/2008
Radiation	BILOG Antenna 08	Schaffner	CBL6112B	2756	06/13/2007	06/12/2008
Radiation	Coaxial Cable Chmb 02-10M	Belden	RG-8/U	Chmb 02-10M	02/13/2008	02/12/2009
Radiation	Digital Hygro-Thermometer Chmb 02	MicroLife	HT-2126G	Chmb 02	12/26/2006	12/26/2008
Radiation	EMI Receiver 02	HP	85460A	3448A00183	12/29/2007	12/28/2008
Radiation	Spectrum Analyzer 13	Advantest	R3132	121200411	03/16/2008	03/15/2009
Radiation	Horn Antenna 02	Com-Power	AH-118	10088	01/14/2008	01/14/2009
Radiation	Horn Antenna 04	Com-Power	AH-826	081-001	03/13/2008	03/13/2009
Radiation	Horn Antenna 05	Com-Power	AH-640	100A	11/16/2007	11/15/2008
Radiation	Microwave Cable RF SK-01	HUBER+SUHNERAG.	Sucoflex 102	22139 /2	06/01/2007	06/01/2008
Radiation	Preamplifier 09	MITEQ	AFS44-00102	858687	04/02/2008	04/02/2009
Radiation	Preamplifier 10	MITEQ	JS-26004000-27-5A	818471	12/28/2007	12/28/2008
Radiation	High Pass Filter 01	HEWLETT-PACKARD	84300-80038	001	N/A	N/A
Radiation	High Pass Filter 02	HEWLETT-PACKARD	84300-80039	005	N/A	N/A
Radiation	Spectrum Analyzer 14	Advantest	R3182	140600028	12/06/2007	12/06/2008
Radiation	Spectrum Analyzer 19	R&S	FSP40	100116	09/12/2007	09/12/2008
Radiation	Vector Singal Generator	R&S	SMU200A	102330	03/08/2008	03/08/2009

Note: Calibration is traceable to NIST or national or international standards.