

TEST REPORT

of

FCC Part 15 Subpart B & E

<Tested with WLAN Module-802.11a (5150MHz-5350MHz)>

Product : **Notebook Personal Computer**

Model(s): **V100**

(with SIERRA EVDO Module, Model:MC5725V)

(with WLAN a/b/g Module, INTEL, Model:WM3945ABG)

(with Bluetooth Module, BILLIONTON, Model:GUBTCR42M)

Brand: **GETAC**

Applicant: **MITAC Technology Corporation**

Address: **4F, No.1, R&D Road 2,
Hsinchu Science-Based industrial Park,
Hsinchu 300
Taiwan**

Test Performed by:

International Standards Laboratory

<Lung-Tan LAB>

*Site Registration No.

BSMI: SL2-IN-E-0013; TAF: 0997

IC: IC4164-1; VCCI: R-1435, C-1440, T-299; NEMKO: ELA 113B

*Address:

No. 120, Lane 180, San Ho Tsuen, Hsin Ho Rd.

Lung-Tan Hsiang, Tao Yuan County 325, Taiwan

*Tel : 886-3-407-1718; Fax: 886-3-407-1738

Report No.: **ISL-07LR033FCA**

Issue Date : **2008/01/30**

Contents of Report

1.	General	1
1.1	Certification of Accuracy of Test Data	1
1.2	Applicant & Manufacturer Information	2
1.3	Test Results Summary	2
2.	Description of Equipment Under Test (EUT)	3
3.	Description of Support Equipment.....	8
3.1	Description of Support Equipment	8
3.1.1	Software for Controlling Support Unit	8
3.1.2	I/O Cable Condition of EUT and Support Units.....	9
4.	Test Results (802.11a).....	10
4.1	Maximum Peak Output Power [Section 15.407 (a)(1)(2)(3)]	10
4.1.1	Test Procedure	10
4.1.2	Test Setup	10
4.1.3	Test Data: (Normal Mode).....	10
4.2	Peak Power Spectral Density [Section 15.407(a)(1)(2)(3)]	14
4.2.1	Test Procedure	14
4.2.2	Test Setup	14
4.2.3	Test Data: (Normal Mode).....	14
4.2.4	Test Data: (Turbo Mode).....	14
4.3	Peak Power Excursion Measurement [Section 15.407(a)(6)]	18
4.3.1	Test Procedure	18
4.3.2	Test Setup	18
4.3.3	Test Data: (Normal Mode).....	18
4.4	Powerline Conducted Emissions [Section 15.207 & 15.407 (b)(5)]	22
4.4.1	EUT Configuration	22
4.4.2	Test Procedure	22
4.4.3	EMI Receiver/Spectrum Analyzer Configuration (for the frequencies tested).....	22
4.4.4	Test Data:.....	23
4.5	Radiated Emission Measurement [Section 15.209 & 15.407(b)(5)]	25
4.5.1	EUT Configuration	25
4.5.2	Test Procedure	25
4.5.3	EMI Receiver/Spectrum Analyzer Configuration	25
4.5.4	Test Data (30MHz – 1GHz)	26
4.5.5	Test Data (1GHz – 40 GHz, Transmitting)	28
4.6	Band Edge Measurement (Section 15.407 (b) (1) (2)).....	40
4.6.1	Test Procedure (Conducted)	40
4.6.2	Test Setup (Conducted)	40
4.6.3	Test Data (conducted):.....	40
4.6.4	Bandedge Measurement Test Procedure (Radiated).....	42
4.6.5	Test Setup (Radiated)	43
4.6.6	Test Data (Radiated):	44
4.7	RF Exposure Measurement [Section 15.407(f)(4) & 1.1307(b)]	47
4.8	Frequency Stability [Section 15.407(g)]	48
4.8.1	Limits of Frequency Stability Measurement.....	48
4.8.2	Test Procedure	48
4.8.3	Test Setup	48
4.8.4	Test Data.....	49
5.	Appendix	50
5.1	Appendix A: Measurement Procedure for Power line Conducted Emissions.....	50
5.2	Appendix B: Test Procedure for Radiated Emissions	51
5.3	Appendix C: Test Equipment	52
5.3.1	Test Equipment List.....	52
5.3.2	Software for Controlling Spectrum/Receiver and Calculating Test Data	52

5.4	Appendix D: Layout of EUT and Support Equipment.....	53
5.4.1	General Conducted Test Configuration.....	53
5.4.2	General Radiation Test Configuration.....	54
5.5	Appendix E: Accuracy of Measurement	55
5.6	Appendix F: Photographs of EUT Configuration Test Set Up.....	56
5.7	Appendix G: Antenna Specification.....	59

1. General

1.1 Certification of Accuracy of Test Data

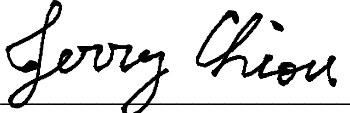
Standards:	CFR 47 Part 15 Subpart B Class B CFR 47 Part 15 Subpart E (Section 15.407)
Test Procedure:	ANSI C63.4:2003
Equipment Tested:	Notebook Personal Computer
Model:	V100
Applied by:	MITAC Technology Corporation
Sample received Date:	2007/10/26
Final Test Date :	2008/01/30
Test Result	PASS
Test Site:	Chamber 02, Conduction 02
Temperature	Refer to each site test data
Humidity:	Refer to each site test data
Test Engineer:	 Jerry Chiou

All the tests in this report have been performed and recorded in accordance with the standards described above and performed by an independent electromagnetic compatibility consultant, International Standards Laboratory.

The test results contained in this report accurately represent the measurements of the characteristics and the energy generated by sample equipment under test at the time of the test. The sample equipment tested as described in this report is in compliance with the limits of above standards.

Approve & Signature

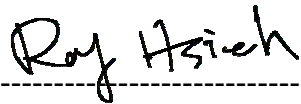

Roy Hsieh / Manager

Test results given in this report apply only to the specific sample(s) tested under stated test conditions. This report shall not be reproduced other than in full without the explicit written consent of ISL. This report totally contains 62 pages, including 1 cover page, 2 contents page, and 59 pages for the test description.

This test data shown below is traceable to NIST or national or international standard. International Standards Laboratory certifies that no party to this application has been denied the FCC benefits pursuant to Section 5301 of the Anti-Drug Abuse Act of 1988, 21 U.S.C. 853(a).

1.2 Applicant & Manufacturer Information

Applicant: Mitac Technology Corp
No. 1, R&D 2nd RD., Hsin-Chu Science Based Industrial Park
Hsin-Chu Hsien,
Taiwan

Manufacturer 1: Mitac Technology Corp
No. 1, R&D 2nd RD., Hsin-Chu Science Based Industrial Park
Hsin-Chu Hsien,
Taiwan

Manufacturer 2: Getac Technology (Kunshan) Co., Ltd
No. 269, 2nd Road, Export Processing Zone,
Changjiang South, Road,
Kunshan, Jiangsu, P.R.C Zip code: 215300

1.3 Test Results Summary

The 802.11a functions of EUT has been tested to the FCC regulations listed below:

Tested Standards: 47 CFR Part 15 Subpart E			
Standard Section	Test Type	Result	Remarks
15.407 (a)(1)(2)(3)	Peak Transmit Power	Pass	
15.407 (a)(1)(2)(3)	Peak Power Spectral Density	Pass	
15.407 (a)(6)	Peak Power Excursion	Pass	
15.407 (b)(5)	AC Power Line Emissions	Pass	
15.407 (b)(5)	Radiated Emissions 30MHz – 40 GHz	Pass	
15.407(f)	Radiation exposure	Pass	SAR report attached
15.407 (g)	Frequency Stability	Pass	

2. Description of Equipment Under Test (EUT)

Description:	Notebook Personal Computer
Condition:	Pre-Production
Model:	V100
Brand:	GETAC
Wireless LAN Module:	Intel, Model: WM3945ABG
Bluetooth Module:	BILLIONTON (Model:GUBTCR42M)
Frequency Range of 802.11a:	5150 - 5250 MHz 5250 - 5350 MHz 5725 - 5850 MHz
Frequency Range of 802.11b/g:	2400 - 2483.5 MHz
Frequency Range of Bluetooth:	2400 - 2483.5 MHz
Support channel:	
802.11a Normal mode	13 Channels
802.11b/g	11 Channels
Bluetooth	79 Channels
Modulation Skill:	
802.11a	OFDM (6 Mbps – 54 Mbps)
802.11b	DBPSK(1Mbps), DQPSK(2Mbps), CCK(5.5/11Mbps)
802.11g	OFDM (6M - 54Mbps)
Bluetooth	GFSK (1Mbps) DQPSK(2Mbps), 8DPSK(3Mbps)
Antennas Type:	
WLAN Right antenna:	PIFA (P/N: IA-060076) White made by JOINSOON ELECTRONICS MFG. CO., LTD
WLAN Left antenna:	PIFA (P/N: IA-060239) Black made by JOINSOON ELECTRONICS MFG. CO., LTD
Bluetooth antenna:	PIFA Antenna(P/N: IA060093), made by JOINSOON ELECTRONICS MFG. CO.,LTD.
Antenna Connected:	Connected to RF connector on the PCB of the Bluetooth or WLAN module .The user is not possible to change the antenna without disassembling the notebook computer.
Antenna peak Gain:	
WLAN Right antenna	1.61dBi(11b,11g), 2.45dBi(11a)
WLAN Left antenna	-0.55 dBi (11b,11g), 3.97 dBi (11a)
Bluetooth antenna	-0.8 dBi
Power Type of wireless module:	3.3V DC from Notebook PC
Power Type of Bluetooth module:	3.3V DC from Notebook PC

The channel and the operation frequency of 802.11a listed below:

Channel	Frequency(MHz)	Channel	Frequency(MHz)
01	5180	02	5200
03	5220	04	5240
05	5260	06	5280
07	5300	08	5320
09	5745	10	5765
11	5785	12	5805
13	5825		

The channel and the operation frequency of 802.11b and 802.11g listed below:

Channel	Frequency(MHz)	Channel	Frequency(MHz)
01	2412	07	2442
02	2417	08	2447
03	2422	09	2452
04	2427	10	2457
05	2432	11	2462
06	2437		

The channels and the operation frequency of Bluetooth listed below:

Channel	Frequency(MHz)	Channel	Frequency(MHz)
00	2402	01	2403
02	2404	03	2405
04	2406	05	2407
.....			
75	2477	76	2478
77	2479	78	2480

WWAN HW version	SIERRA,Model:MC5725V, REV2.0
WWAN TX Frequency	CDMA2000 Cellular : 824MHz~849MHz CDMA2000 PCS : 1850MHz ~ 1910MHz
WWAN Rx Frequency	CDMA2000 Cellular : 869MHz~894MHz CDMA2000 PCS : 1930MHz ~ 1990MHz
WWAN Antenna Type	PIFA Antenna
WWAN Antenna Gain	0.52dBi (850MHz), 2.06dBi(1900MHz)
WWAN Type of Antenna Connector	I-PEX

CPU:	Genuine intel U2500 1.2GHz
Adapter Type:	Auto Switching AC Adapter 100-240V,1.2A 50-60Hz EPS (Model: F10903-A)
Hard Disk Driver:	Toshiba (Model:MK8032GSX) 80G or Toshiba (Model:MK1234GSX) 120G
Modem Card:	Conexant (Model: RD-02-D330)
Wireless LAN Card:	Intel(Model:WM3945ABG)
Bluetooth module:	BILLIONTON(Model:GUBTCR42M)
USB Connector:	two 4 pin
RJ11 Connector:	one 2 pin
Serial Port:	two 9 pin
RJ45 Connector:	one 8 pin
Line out Port:	one
Line-in Port:	one
SD Card Port:	one
PCMCIA Slot:	two
DC IN Port:	one
Battery:	MITAC(Model: BP-LC2600/33-0151), 11.1Vdc, 7800mAh
LCD:	Toshiba(Model: LTD104KA1S) or Toshiba(Model: LTD121EXEV)
DDR:	Infineon(Model:PC2-4200S-444-11-A0) 512M Hnnix(Model:PC2-5300S555-12) 1G
Power Cord:	Non-shielded, Detachable

Test configuration:

configuration	LCD	CPU	Adapter Type	Hard Disk	Modem Card	Wireless LAN Card	Battery	DDR
1	Toshiba(Model: LTD104 KA1S)	Genuine intel U2500 1.2GHz	EPS (Model: F10903-A)	Toshiba (Model:MK1234GSX) 120G	Conexant (Model: RD-02-D330)	Intel(Model :WM3945 ABG)	MITAC(M odel:BP-L C2600/33-0 151)	Hnnix(M odel:PC2 -5300S5 55-12)
2	Toshiba(Model: LTD121E XEV)	Genuine intel U2500 1.2GHz	EPS (Model: F10903-A)	Toshiba (Model:MK1234GSX) 120G	Conexant (Model: RD-02-D330)	Intel(Model :WM3945 ABG)	MITAC(M odel:BP-L C2600/33-0 151)	Hnnix(M odel:PC2 -5300S5 55-12)

All types of LCD 、 CPU 、 Adapter Type 、 Hard Disk 、 Modem Card 、 Wireless LAN Card 、 Battery 、 DDR with related components have been tested, only shown the worst data using the following configuration in this report.

configuration	LCD	CPU	Adapter Type	Hard Disk	Modem Card	Wireless LAN Card	Battery	DDR
2	Toshiba(Model: LTD121E XEV)	Genuine intel U2500 1.2GHz	EPS (Model: F10903-A)	Toshiba (Model:MK1234GSX) 120G	Conexant (Model: RD-02-D330)	Intel(Model :WM3945 ABG)	MITAC(M odel:BP-L C2600/33-0 151)	Hnnix(M odel:PC2 -5300S5 55-12)

EMI Noise Source:

- GPS board Crystal: 12MHz(X1)
- Touch Panel board Crystal:7.372MHz(X1)
- SD card board Crystal:12MHz(X2)
- Main board Crystal:25MHz(X3),10MHz(X2),14.318MHz(X501)
- Clock Generator: U514

EMI Solution:

1. Adding shielded tape on LCD Signal cable
2. Adding Gasket on LCD Signal cable
3. Adding Gasket on LCD Panel around
4. Adding Gasket on Bluetooth Module
5. Adding aluminum foil on 3GCDMA antenna
6. Adding Copper on Main board
7. Adding Copper on Modem Card
8. Adding Gasket on Main board
9. Adding Gasket on Modem Card
10. Adding Core(A5 FS 16*5*12) on LAN Signal cable
11. Adding Core(A3 FS 15*3*11) on Modem Card Signal cable
12. Adding Core(K5B RH 6.35*15.8*3.3) on DC IN Jack
13. Adding aluminum foil on Case
14. Adding Core(FPC 40*2.7*12-K) on Keyboard Signal cable
15. Adding Core(RC 16*28*9 -M2) on Adapter Type Signal cable

Maximum Peak Output Power

802.11a (dBm)							
Freq.	Bit rate (mbps)						
(MHz)	6	9	12	18	24	36	54
5180	8.32	8.3	8.28	8.26	8.31	8.26	8.22
5200	8.47	8.44	8.27	8.04	8.06	7.56	7.15
5240	10.86	10.6	10.33	10.15	10.1	9.6	9.18
5260	10.41	10.4	10.28	9.91	9.93	9.33	8.95
5280	9.6	9.51	9.33	9.15	9.07	8.59	8.15
5320	9.58	9.56	9.35	9.04	9.15	9.12	9.26
5745	14.05	14.05	13.96	13.94	13.97	13.54	13.1
5785	14.36	14.35	14.17	13.97	13.83	13.27	13
5825	14.45	14.02	13.79	12.98	13.52	12.47	12.05

3. Description of Support Equipment

3.1 Description of Support Equipment

Unit	Model Serial No.	Brand	Power Cord	FCC ID
Aceex Modem	DM1414 S/N: 0301000557	Aceex	Nonshielded Detachable	FCC DOC
Aceex Modem	DM1414 S/N: 0301000557	Aceex	Nonshielded Detachable	FCC DOC
Bluetooth test set	Mt8852B S/N: 6K00004613	Anritsu	Shielded Detachable	NA
External Hard Disk Case	F12-UF S/N: NA	TeraSys	Nonshielded Detachable	FCC DOC
External Hard Disk Case	F12-UF S/N: NA	TeraSys	Nonshielded Detachable	FCC DOC
ATA Microphone and HeadSet	1221K S/N: NA	ATA	NA	FCC DOC

3.1.1 Software for Controlling Support Unit

Test programs exercising various part of EUT were used. The programs were executed as follows:

- A. Read and write to the disk drives.
- B. The RF software makes the transmitter continuously sending RF signals
- C. Repeat the above steps.

	Filename	Issued Date
CRTU 3945ABG version 4.0.18.0000	CRTU.exe	2005/10/16

3.1.2 I/O Cable Condition of EUT and Support Units

Description	Path	Cable Length	Cable Type	Connector Type
AC Power Cord	110V (~240V) to EUT SPS	1.8M	Nonshielded, Detachable	Plastic Head
AC Power Cord	110V (~240V) to BT test set SPS	1.8M	Shielded, Detachable	Plastic Head
Modem Data Cable*2	Modem to PC COM 1 port	1.5M	Shielded, Detachable	Metal Head
USB Data Cable*2	USB external hard disk to EUT USB Port	1.8M	Shielded, Un-detachable	Metal Head
Audio Data Cable	Microphone and HeadSet to EUT Line In Port and Line Out Port	1.8M	Non-shielded, Un-Detachable	Plastic Head

4. Test Results (802.11a)

4.1 Maximum Peak Output Power [Section 15.407 (a)(1)(2)(3)]

4.1.1 Test Procedure

The transmitter output of EUT was connected to the peak power analyzer.

4.1.2 Test Setup

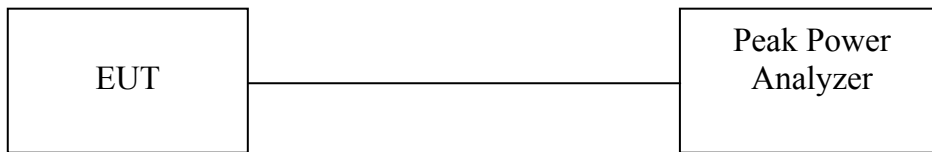

Frequency Band	Limit
5.15 – 5.25 GHz	The lesser of 50mW (17dBm) or 4dBm+10logB
5.25 – 5.35GHz	The lesser of 250mW (24dBm) or 11dBm+10logB
5.725-5.825GHz	The lesser of 1W (30dBm) or 17dBm+10logB

NOTE: B is the 26dB emission bandwidth in MHz

4.1.3 Test Data: (Normal Mode)

Maximum Peak Output Power

Temperature (° C): 25

Test Engineer: Jerry Chiou Humidity (%): 50

Frequency (MHz)	Peak Power Output (dBm)	26 dBc BW/Limit MHz/dBm	The lesser Limit (dBm)	Pass/Fail
5180	8.32	23.45/ 17.70	17.00	Pass
5200	8.47	23.45/ 17.71	17.00	Pass
5240	10.86	23.59/ 17.73	17.00	Pass
5260	10.41	23.59/ 24.73	24.00	Pass
5280	9.6	23.59/ 24.71	24.00	Pass
5320	9.58	23.59/ 24.73	24.00	Pass

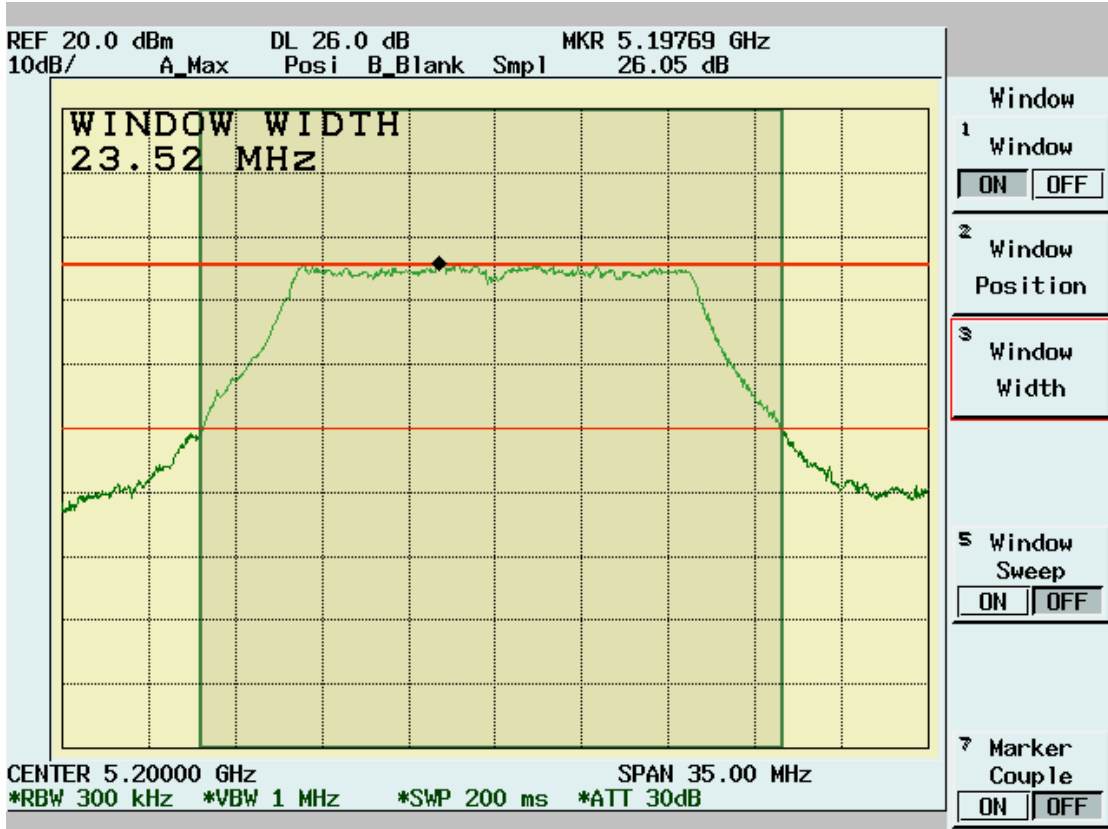
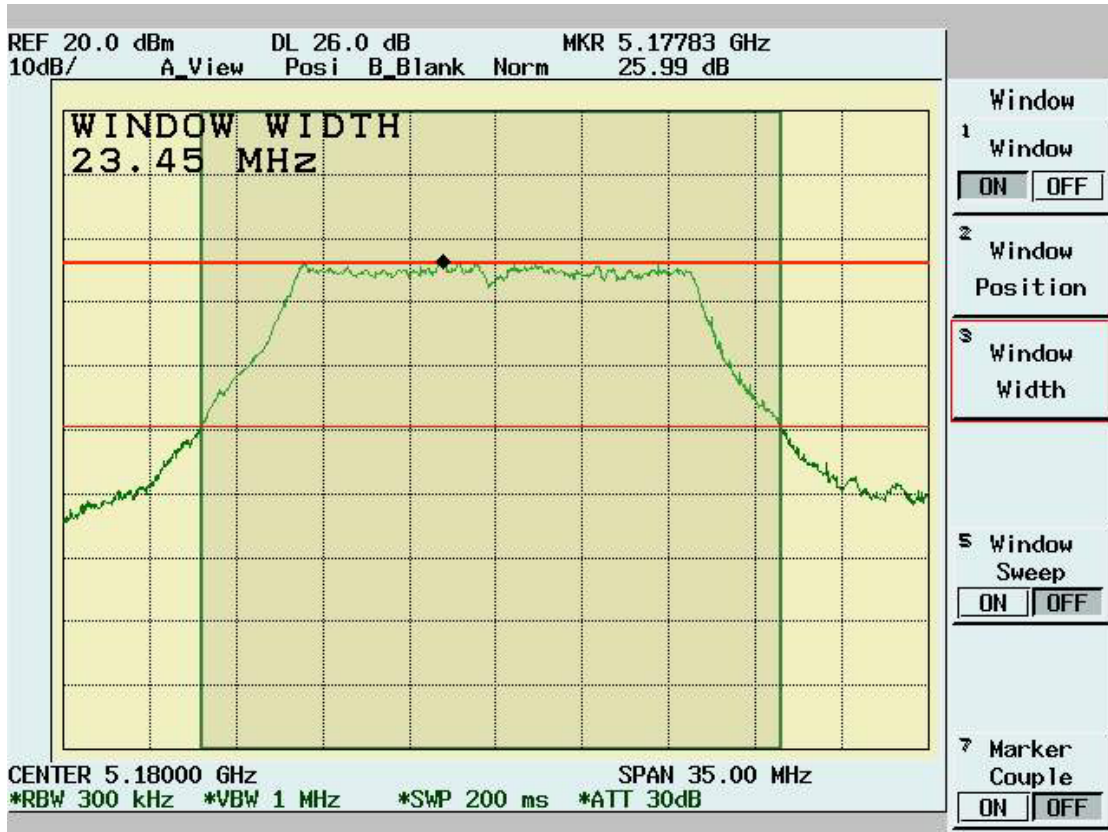

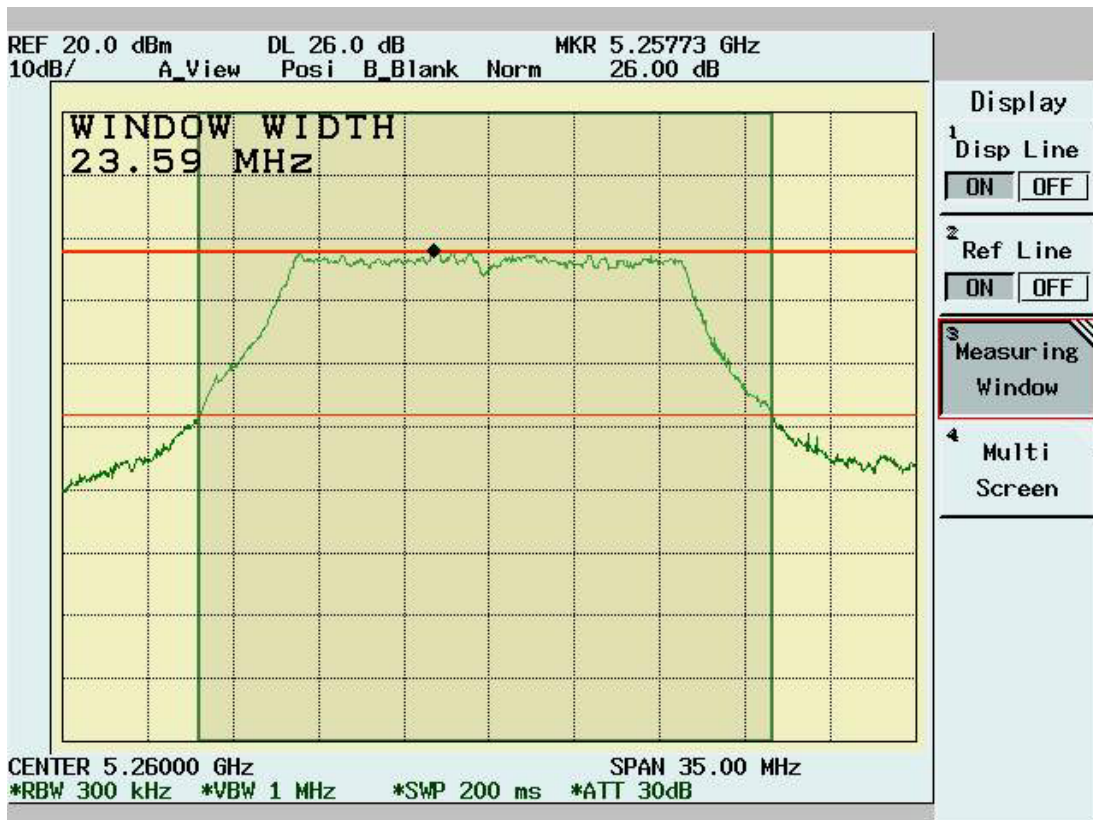
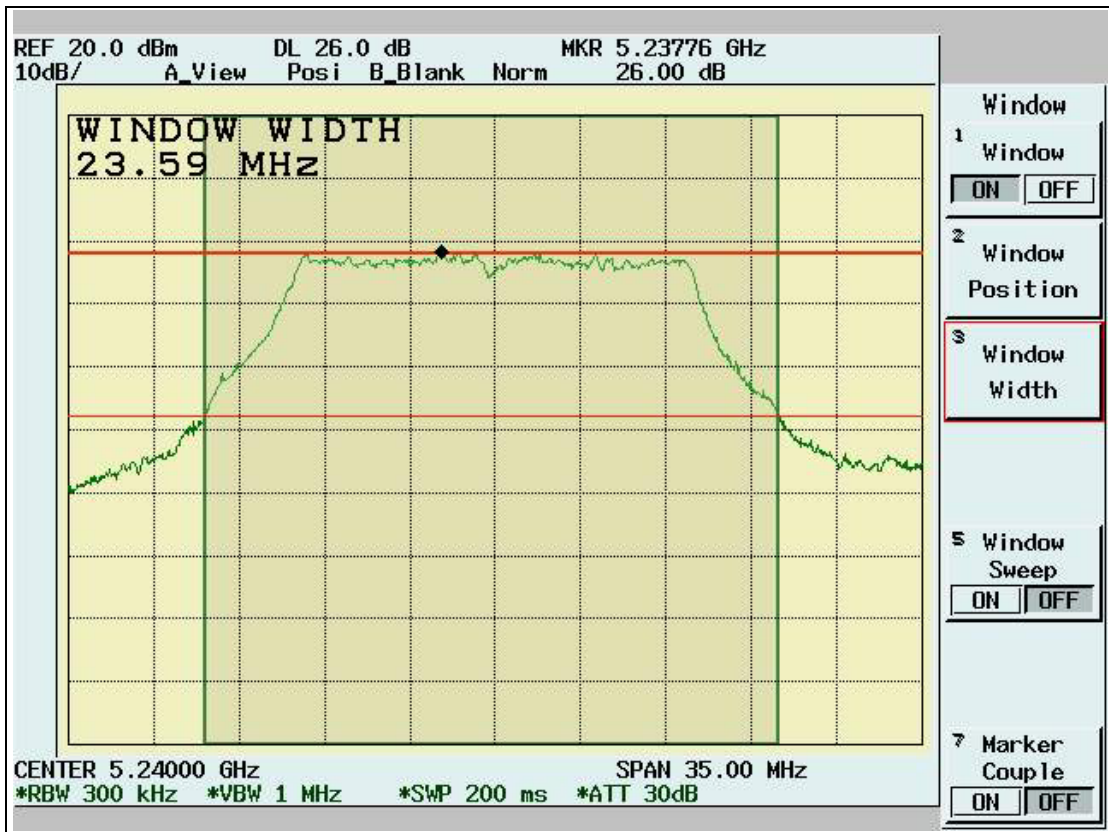

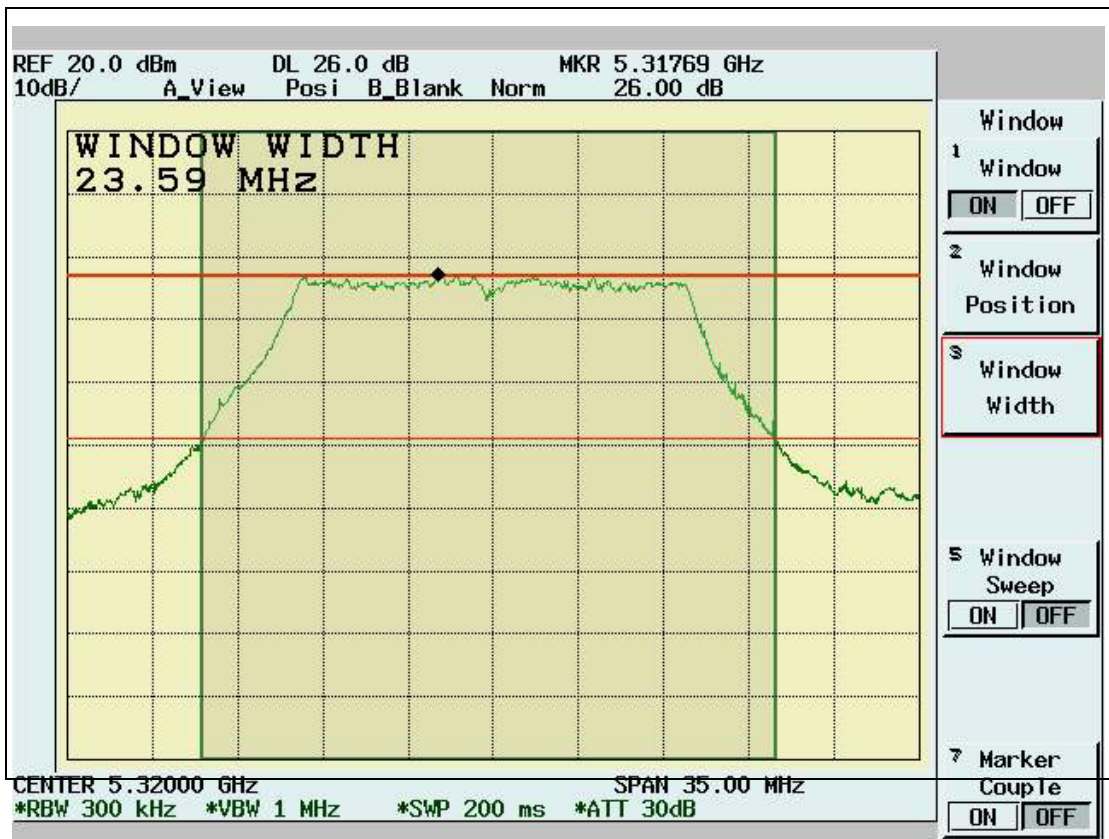
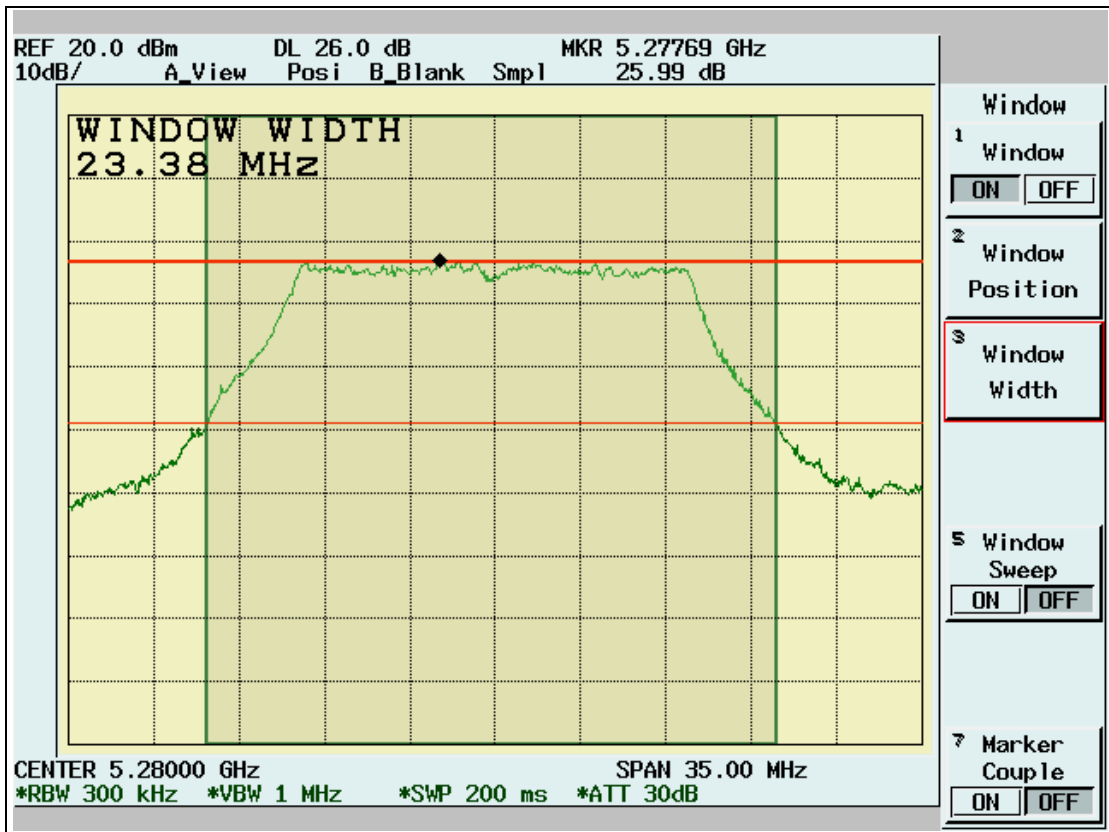

4.2 Peak Power Spectral Density [Section 15.407(a)(1)(2)(3)]

4.2.1 Test Procedure

1. The Transmitter output of EUT was connected to the spectrum analyzer.
Equipment mode: Spectrum analyzer
Detector function: Peak mode
SPAN: 30MHz or 50MHz
RBW: 1MHz
VBW: 3MHz
Sweep time: 30 or 50 sec.
Center frequency: fundamental frequency tested
2. Peak search was read to the peak power after maximum hold function is completed.

4.2.2 Test Setup



4.2.3 Test Data: (Normal Mode)

Maximum Peak Output Power Density

Temperature (° C):

25

Test Engineer:

Jerry Chiou

Humidity (%):

50

Frequency (MHz)	Spectrum Reading (dBm)	Cable Loss(dB)	Peak Power Output (dBm/MHz)	Limit (dBm/MHz)	Pass/Fail
5180	0.55	1.20	1.75	4.00	Pass
5200	-0.20	1.20	1.00	4.00	Pass
5240	1.89	1.20	3.09	4.00	Pass
5260	1.73	1.20	2.93	11.00	Pass
5280	1.20	1.20	2.40	11.00	Pass
5320	1.13	1.20	2.33	11.00	Pass

4.2.4 Test Data: (Turbo Mode)

Maximum Peak Output Power Density

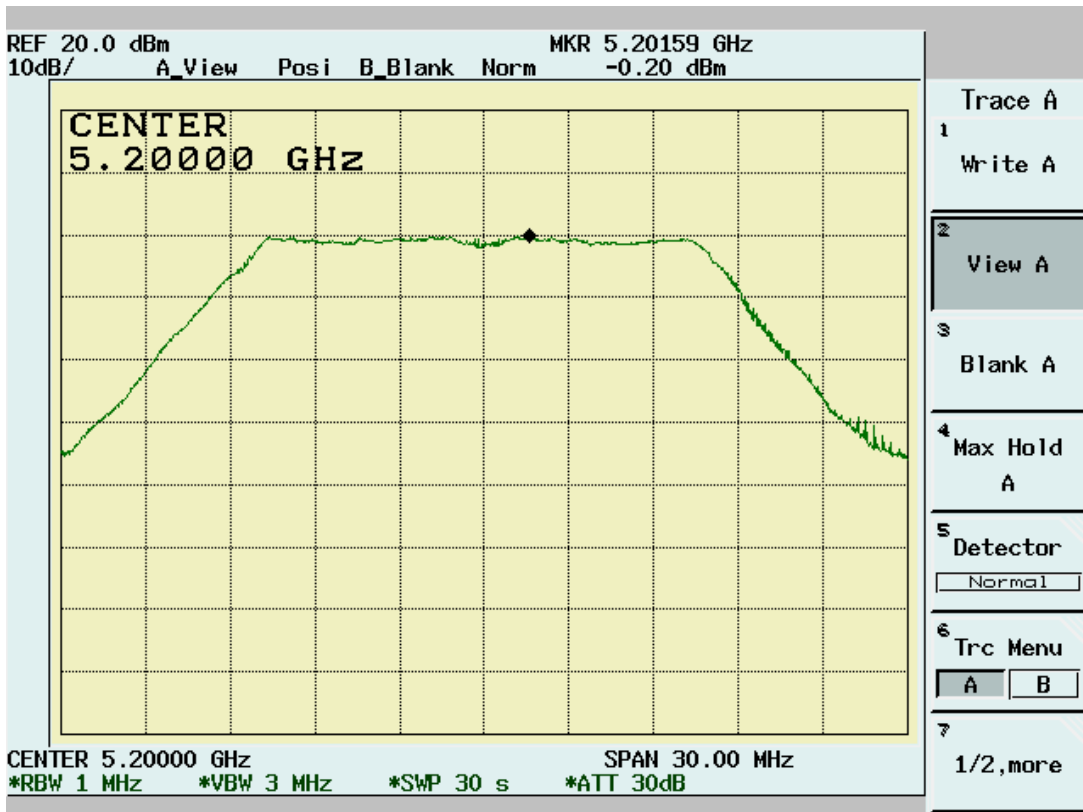



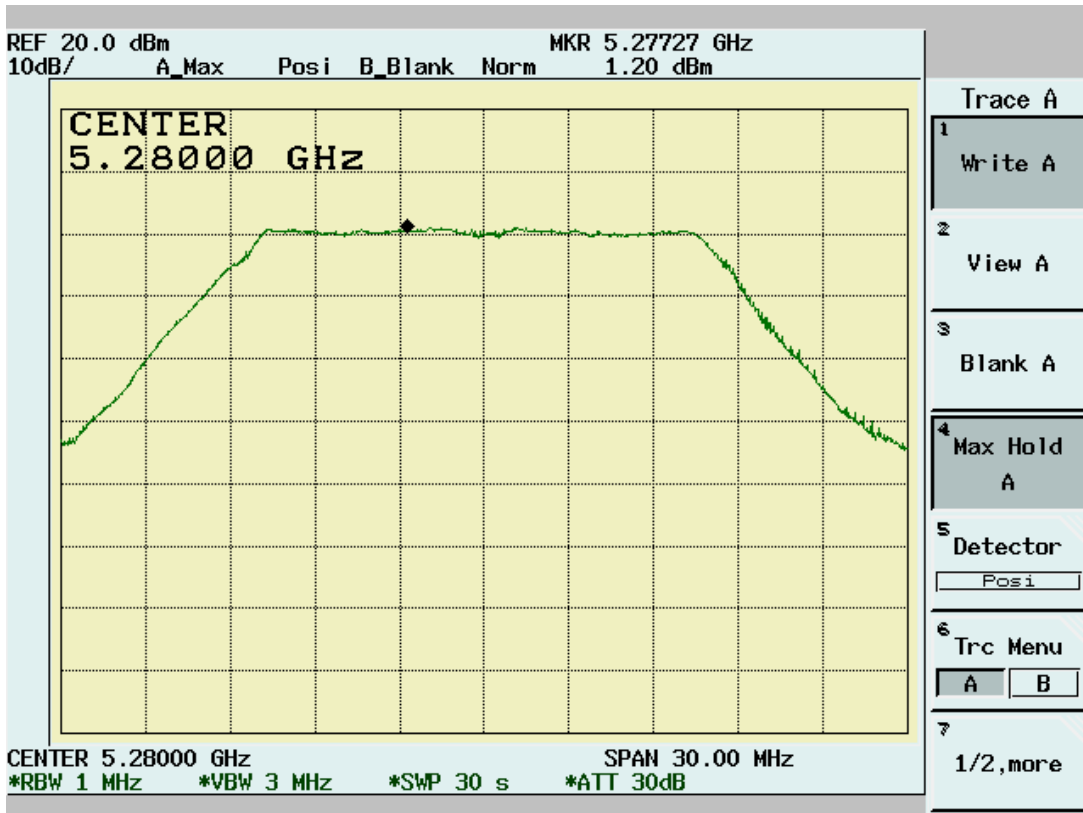

4.3 Peak Power Excursion Measurement [Section 15.407(a)(6)]

4.3.1 Test Procedure

1. The Transmitter output of EUT was connected to the spectrum analyzer.
2. Frequency SPAN of Spectrum: 30MHz or 50MHz.
3. Trace 1 : RBW: 1MHz, VBW: 3MHz. Using positive detector and Max -hold
4. Trace 2 : RBW: 1MHz, VBW: 3MHz. Using Sample detector and Max-hold
5. Record the largest difference between Trace 1 and Trace 2.

4.3.2 Test Setup

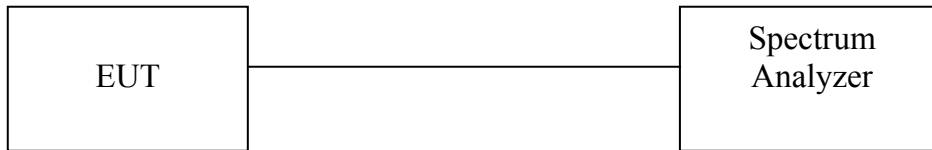

4.3.3 Test Data: (Normal Mode)

Peak Power Excursion

Temperature (° C): 25

Test Engineer: Jerry Chiou Humidity (%): 50

Frequency (MHz)	Peak Power Excursion (dBm)	Limit (dBm)	Pass/Fail
5180	7.55	13	Pass
5200	8.26	13	Pass
5240	8.51	13	Pass
5260	8.67	13	Pass
5280	8.54	13	Pass
5320	8.45	13	Pass

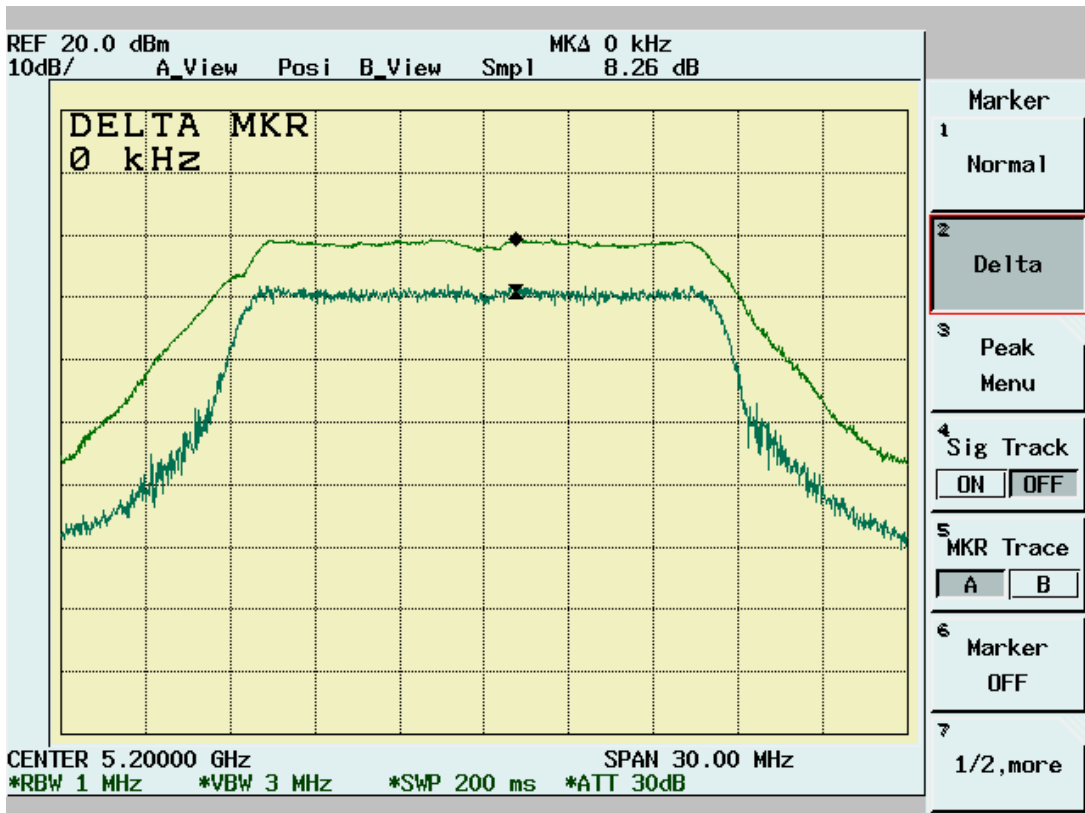
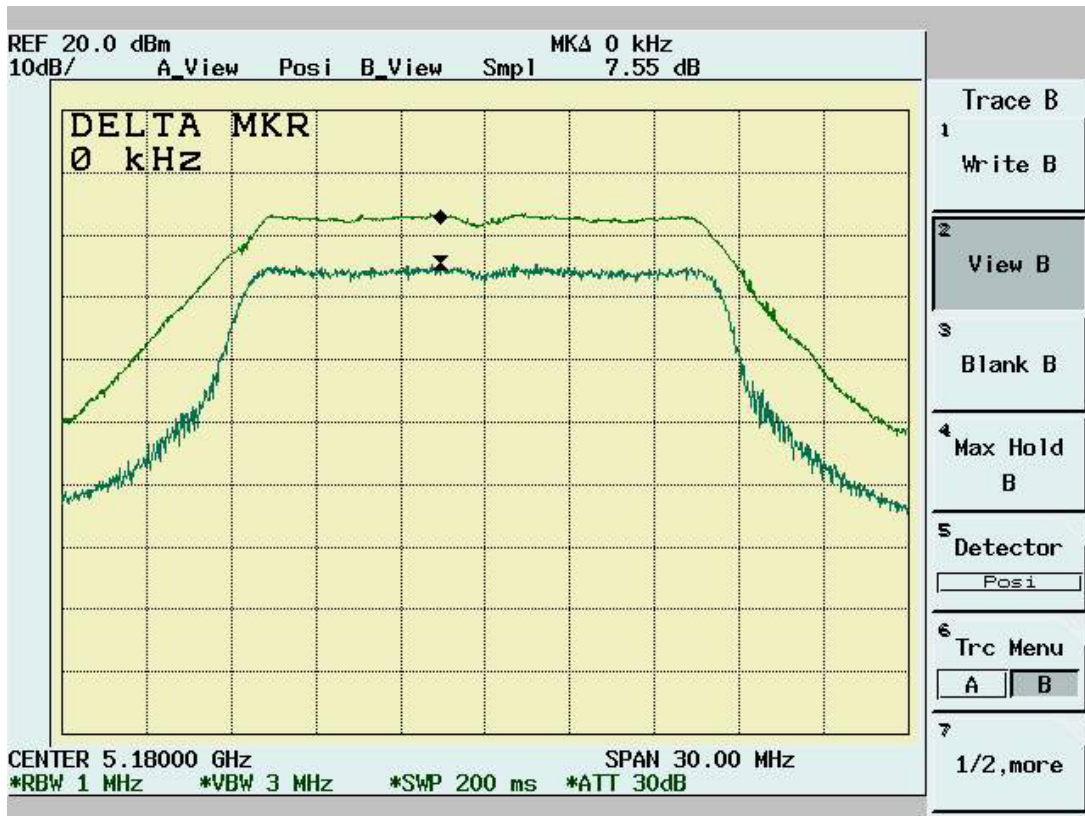

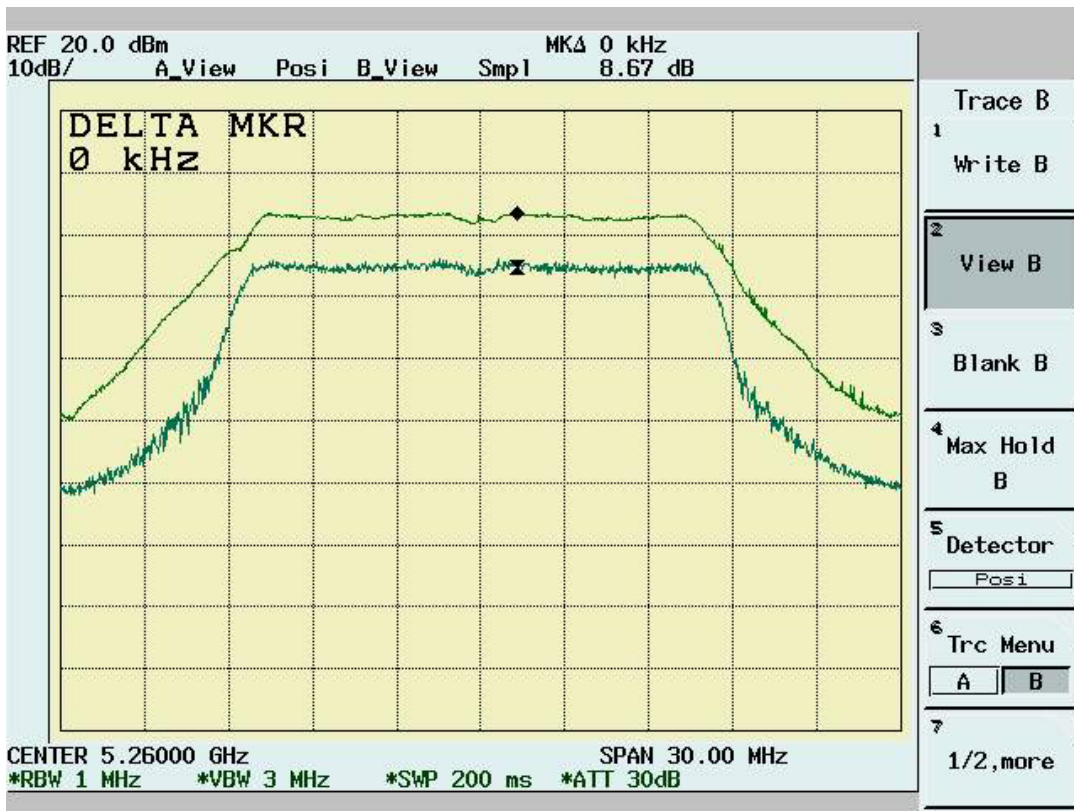

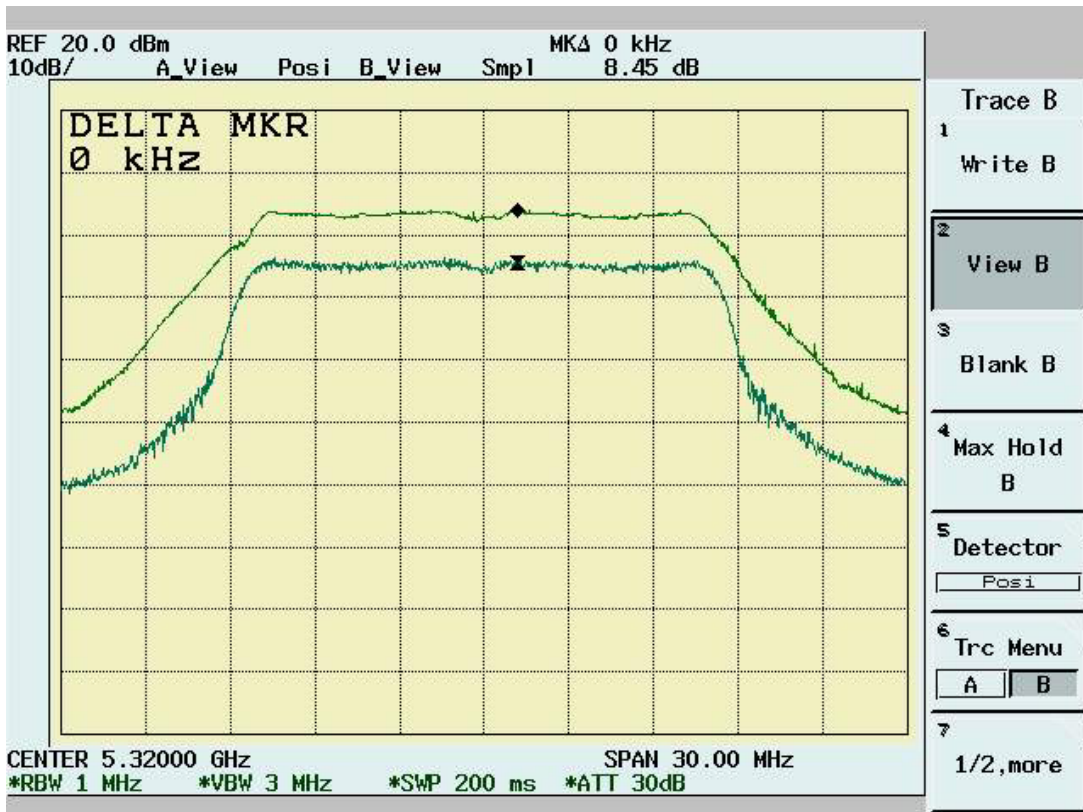
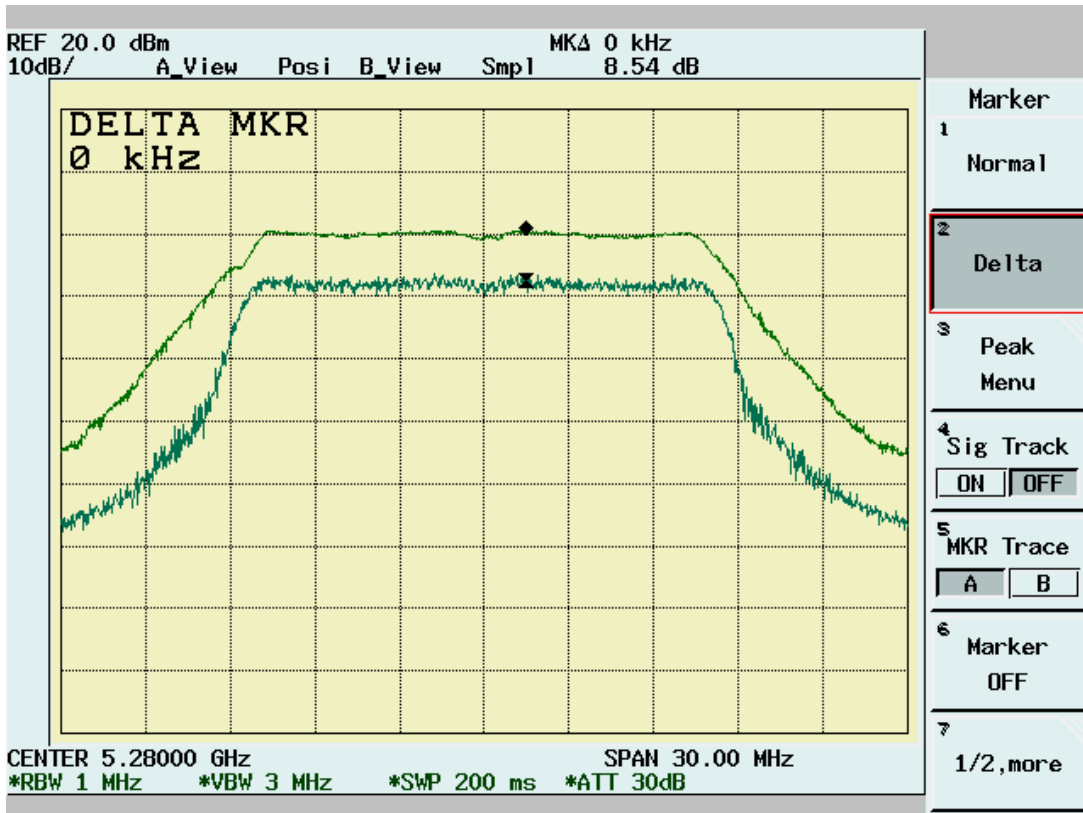

4.4 Powerline Conducted Emissions [Section 15.207 & 15.407 (b)(5)]

4.4.1 EUT Configuration

The EUT was set up on the non-conductive table that is 1.0 by 1.5 meter, 80cm above ground. The wall of the shielded room was located 40cm to the rear of the EUT.

Power to the EUT was provided through the LISN. The impedance vs. frequency characteristic of the LISN is complied with the limit used.

Both lines (neutral and hot) were connected to the LISN in series at testing. A coaxial-type connector which provides one 50 ohms terminating impedance was provided for connecting the test instrument. The excess length of the power cord was folded back and forth at the center of the lead so as to form a bundle not exceeding 40cm in length.

Any changes made to the configuration, or modifications made to the EUT, during testing are noted in the following test record.

If the EUT is a Personal Computer or a peripheral of personal computer, and the personal computer has an auxiliary AC outlet which can be used for providing power to an external monitor, then all measurements will be made with the monitor power from first the computer-mounted AC outlet and then a floor-mounted AC outlet.

4.4.2 Test Procedure

The system was set up as described above, with the EMI diagnostic software running. The main power line conducted EMI tests were run on the hot and neutral conductors of the power cord and the results were recorded. The effect of varying the position of the interface cables has been investigated to find the configuration that produces maximum emission.

At the frequencies where the peak values of the emissions were higher than 6dB below the applicable limits, the emissions were also measured with the quasi-peak detectors. At the frequencies where the quasi-peak values of the emissions were higher than 6dB below the applicable average limits, the emissions were also measured with the average detectors.

The highest emissions were analyzed in details by operating the spectrum analyzer in fixed tuned mode to determine the nature of the emissions and to provide information which could be useful in reducing their amplitude.

4.4.3 EMI Receiver/Spectrum Analyzer Configuration (for the frequencies tested)

Frequency Range:	150 KHz--30MHz
Detector Function:	Quasi-Peak/Average
Bandwidth (RBW):	9KHz

4.4.4 Test Data:

Power Line Conducted Emissions (Hot)

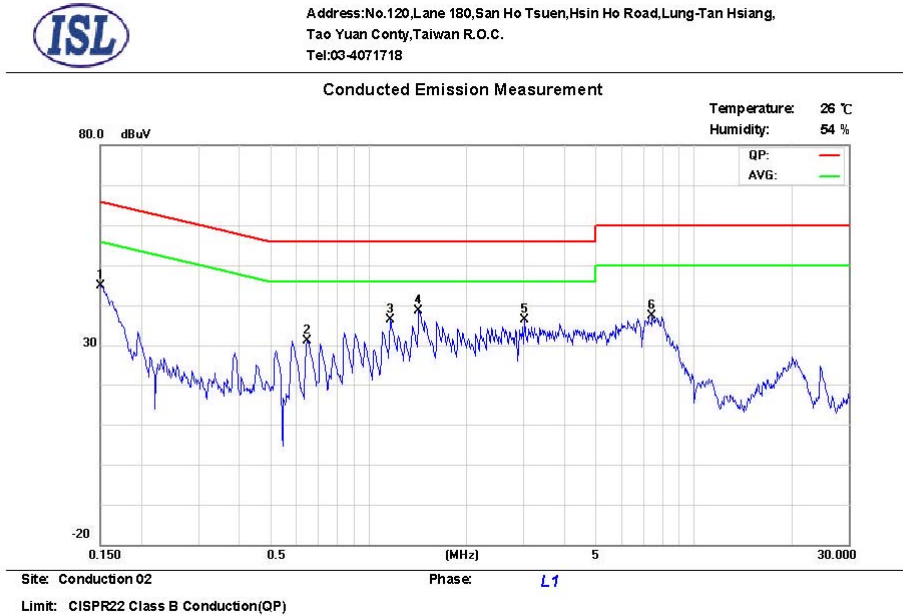

Frequency MHz	LISN Loss dB	Cable Loss dB	QP Correct dBuV	QP Limit dBuV	QP Margin dB	AVG Correct. dBuV	AVG Limit dBuV	AVG Margin dB	Note
0.1500	0.1	0.02	43.20	66.0	-22.8	40.00	56.0	-16.0	
0.6474	0.2	0.07	34.30	56.0	-21.7	31.90	46.0	-14.1	
1.1657	0.2	0.07	38.00	56.0	-18.0	34.70	46.0	-11.3	
* 1.4257	0.2	0.08	42.00	56.0	-14.0	37.20	46.0	-8.80	
3.0253	0.3	0.12	26.20	56.0	-29.8	22.20	46.0	-23.8	
7.4465	0.46	0.18	37.80	60.0	-22.2	36.30	50.0	-13.7	

*:Maximum data x:Over limit

Power Line Conducted Emissions (Neutral)



Address: No.120, Lane 180, San Ho Tsuen, Hsin Ho Road, Lung-Tan Hsiang,
Tao Yuan Conty, Taiwan R.O.C.
Tel: 03-4071718

Conducted Emission Measurement

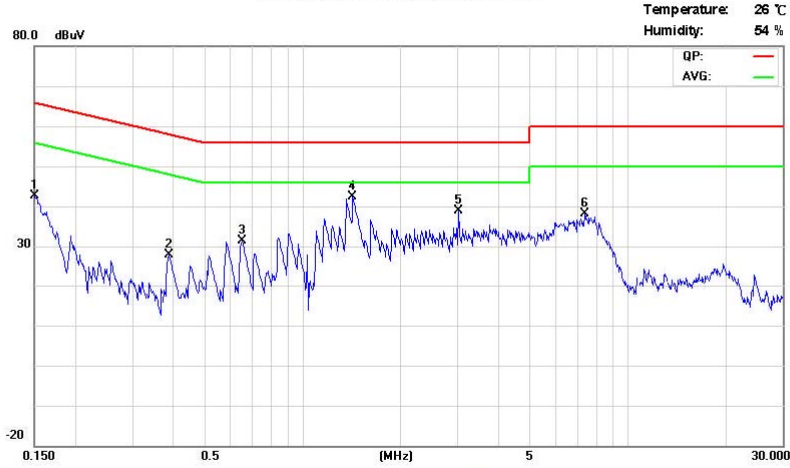

Site: Conduction 02

Phase: N

Limit: CISPR22 Class B Conduction(QP)

Frequency MHz	LISN Loss dB	Cable Loss dB	QP Correct dBuV	QP Limit dBuV	QP Margin dB	AVG Correct. dBuV	AVG Limit dBuV	AVG Margin dB	Note
0.1500	0.1	0.02	42.60	66.0	-23.4	39.60	56.0	-16.4	
0.3893	0.19	0.09	28.70	58.0	-29.3	26.90	48.0	-21.1	
0.6543	0.2	0.07	24.00	56.0	-32.0	19.90	46.0	-26.1	
* 1.4257	0.2	0.08	44.10	56.0	-11.9	40.40	46.0	-5.60	
3.0253	0.2	0.12	26.10	56.0	-29.9	22.40	46.0	-23.6	
7.3680	0.31	0.18	35.40	60.0	-24.6	30.60	50.0	-19.4	

*Maximum data x:Over limit

NOTE: Margin = Amplitude + Insertion Loss- Limit
A margin of -8dB means that the emission is 8dB below the limit

4.5 Radiated Emission Measurement [Section 15.209 & 15.407(b)(5)]

4.5.1 EUT Configuration

The equipment under test was set up on the 10 meter chamber with measurement distance of 3 meters. The EUT was placed on a non-conductive table 80cm above ground.

Any changes made to the configuration, or modifications made to the EUT, during testing are noted in the following test record.

4.5.2 Test Procedure

The system was set up as described above, with the EMI diagnostic software running. We found the maximum readings by varying the height of antenna and then rotating the turntable. Both polarization of antenna, horizontal and vertical, are measured.

30M to 1GHz: The highest emissions between 30 MHz to 1000 MHz were also analyzed in details by operating the spectrum analyzer and/or EMI receiver in quasi-peak mode to determine the precise amplitude of the emissions. While doing so, the interconnecting cables and major parts of the system were moved around, the antenna height was varied between one and four meters, its polarization was varied between vertical and horizontal, and the turntable was slowly rotated, to maximize the emission.

1GHz – 40GHz: The highest emissions were also analyzed in details by operating the spectrum analyzer and/or EMI receiver in peak mode to determine the precise amplitude of the emission. While doing so, the interconnecting cables and major parts of the system were moved around, the antenna height was varied between one and four meters, its polarization was varied between vertical and horizontal, and the turntable was slowly rotated, to maximize the emission. During test the EMI receiver and spectrum was setup according to para. 6.5.3.

For the test of 2nd to 10th harmonics frequencies, the equipment setup was also refer to para.6.5.3. The frequencies were tested using Peak mode first, if the test data is higher than the emissions limit, an additional measurement using Average mode will be performed and the average reading will be compared to the limit and record in test report.

4.5.3 EMI Receiver/Spectrum Analyzer Configuration

Frequency Range Tested:	30MHz~1000MHz
Detector Function:	Quasi-Peak Mode
Resolution Bandwidth (RBW):	120KHz
Video Bandwidth (VBW)	1MHz
Frequency Range Tested:	1GHz – 40 GHz
Detector Function:	Peak Mode
Resolution Bandwidth (RBW):	1MHz
Video Bandwidth (VBW)	3MHz
Frequency Range Tested:	30MHz – 40 GHz
Detector Function:	Average Mode
Resolution Bandwidth (RBW):	1MHz
Video Bandwidth (VBW)	10 Hz

4.5.4 Test Data (30MHz – 1GHz) .

30M – 1GHz Open Field Radiated Emissions (Horizontal)

Operator: Jerry Chiou

Temperature (C): 25

Humidity (%): 63

Frequency MHz	Rx Amp. (dBuV)	Ant Fact (dB/m)	CableLoss (dB)	PreAmpGain (dB)	Correc. Emi. (dBuV/m)	Limit (dBuV/m)	Margin (dB)	Ant. Pos. (cm)	Table Pos. (deg)
59.1	19.28	6.72	1.33	0	27.33	40	-12.67	96	245
68.8	22.93	6.16	1.51	0	30.6	40	-9.4	96	219
88.2	23.45	8.54	1.67	0	33.66	43.5	-9.84	96	219
95.96	18.16	9.91	1.79	0	29.87	43.5	-13.63	96	35
99.84	14.61	10.57	1.92	0	27.11	43.5	-16.39	96	35
102.75	14.55	11.1	1.93	0	27.57	43.5	-15.93	96	61
105.66	14.84	11.62	1.93	0	28.38	43.5	-15.12	96	35
111.48	18.73	12.43	1.9	0	33.06	43.5	-10.44	96	61
158.04	21.85	10.12	2.36	0	34.33	43.5	-9.17	96	219
177.44	16.34	9.35	2.49	0	28.17	43.5	-15.33	96	193
197.81	21.01	9.16	2.6	0	32.76	43.5	-10.74	96	245
202.66	22.27	9.17	2.63	0	34.07	43.5	-9.43	96	245

30M – 1GHz Open Field Radiated Emissions (Vertical)

Operator: Jerry Chiou

Temperature (C): 25

Humidity (%): 63

Frequency MHz	Rx Amp. (dBuV)	Ant Fact (dB/m)	CableLoss (dB)	PreAmpGain (dB)	Corrct. Emi. (dBuV/m)	Limit (dBuV/m)	Margin (dB)	Ant. Pos. (cm)	Table Pos. (deg)
70.74	22.55	6.16	1.55	0	30.25	40	-9.75	96	245
89.17	23.28	8.73	1.66	0	33.68	43.5	-9.82	96	219
95.96	18.13	9.91	1.79	0	29.84	43.5	-13.66	96	35
105.66	15.46	11.62	1.93	0	29.01	43.5	-14.49	96	35
108.57	14.66	12.14	1.94	0	28.74	43.5	-14.76	96	61
111.48	15.78	12.43	1.9	0	30.12	43.5	-13.38	96	61
155.13	17.7	10.15	2.31	0	30.16	43.5	-13.34	96	219
159.98	17.04	10.1	2.39	0	29.53	43.5	-13.97	96	219
162.89	17.05	9.93	2.39	0	29.37	43.5	-14.13	96	219
197.81	16.45	9.16	2.6	0	28.2	43.5	-15.3	96	245
202.66	16.3	9.17	2.63	0	28.1	43.5	-15.4	96	245
334.58	13.27	14.03	3.3	0	30.6	46	-15.4	96	140

NOTE: Margin=Corrected Amplitude–Limit

Corrected Amplitude = Radiated Amplitude + Antenna Correction Factor + Cable Loss - Pre-Amplifier Gain

A margin of -8dB means that the emission is 8dB below the limit

All frequencies from 30MHz to 1GHz have been tested

4.5.5 Test Data (1GHz – 40 GHz, Transmitting) .

1GHz~ 40 GHz (Horizontal), 5180 MHz

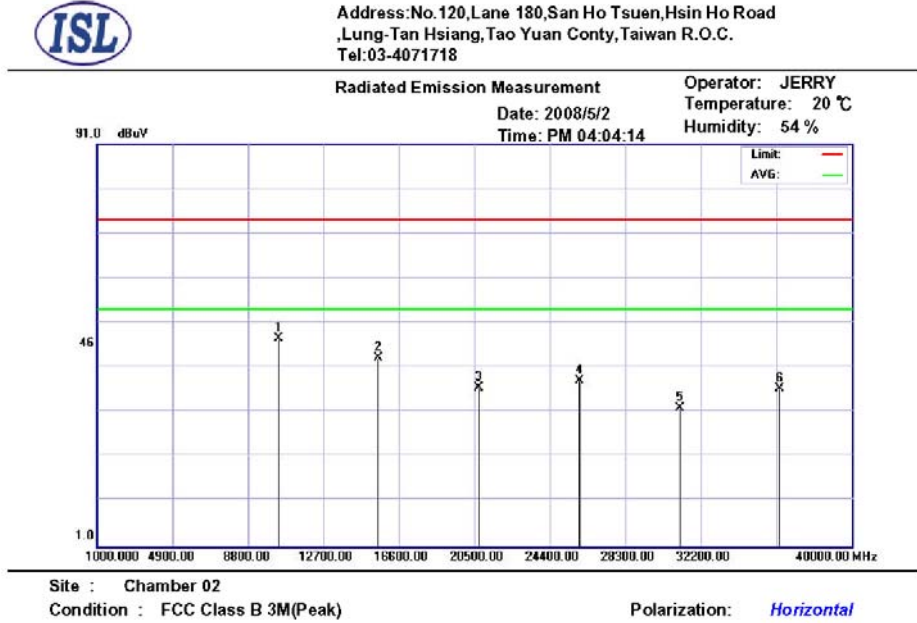

Mk.	Frequency (MHz)	RX_R (dBuV)	Ant_F (dB)	Cab_L (dB)	PreAmp (dB)	Emission (dBuV)	Limit (dBuV)	Margin (dB)	Ant.Pos (cm)	Tab.Pos (deg.)	Detector
*	10360.000	32.31	39.86	4.18	28.93	47.42	74.00	-26.58	100	34	peak
	15540.000	29.39	38.86	5.05	30.02	43.28	74.00	-30.72	189	316	peak
	20720.000	25.59	33.58	5.89	28.59	36.47	74.00	-37.53	273	39	peak
	25900.000	24.63	34.06	5.51	26.14	38.06	74.00	-35.94	100	272	peak
	31080.000	25.22	37.02	5.02	35.35	31.91	74.00	-42.09	199	107	peak
	36260.000	25.03	38.54	5.57	32.94	36.20	74.00	-37.80	160	190	peak

*:Maximum data x:Over limit !:over margin

1GHz~ 40 GHz (Vertical), 5180 MHz



Address: No.120, Lane 180, San Ho Tsuen, Hsin Ho Road
, Lung-Tan Hsiang, Tao Yuan Conty, Taiwan R.O.C.
Tel: 03-4071718

Radiated Emission Measurement

Operator: JERRY

Date: 2008/5/2

Temperature: 20 °C

Time: PM 04:05:32

Humidity: 54 %

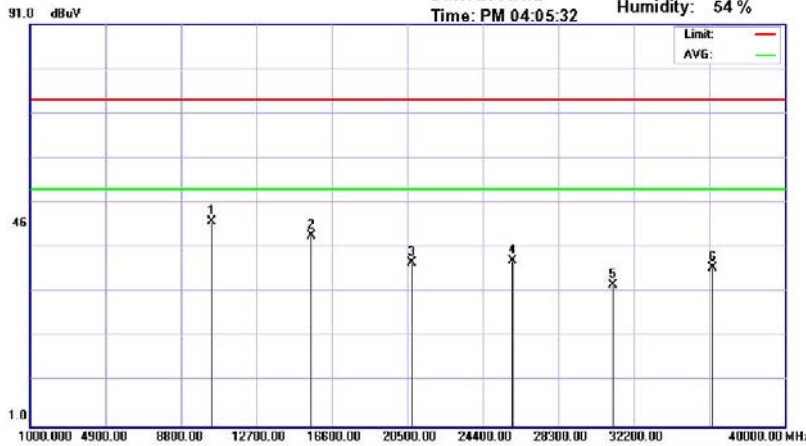

Site : Chamber 02

Condition : FCC Class B 3M(Peak)

Polarization: Vertical

Mk.	Frequency (MHz)	RX_R (dBuV)	Ant_F (dB)	Cab_L (dB)	PreAmp (dB)	Emission (dBuV)	Limit (dBuV)	Margin (dB)	Ant.Pos (cm)	Tab.Pos (deg.)	Detector
*	10360.000	31.63	39.86	4.18	28.93	46.74	74.00	-27.26	382	188	peak
	15540.000	29.67	38.86	5.05	30.02	43.56	74.00	-30.44	173	13	peak
	20720.000	26.64	33.58	5.89	28.59	37.52	74.00	-36.48	274	328	peak
	25900.000	24.61	34.06	5.51	26.14	38.04	74.00	-35.96	100	292	peak
	31080.000	25.95	37.02	5.02	35.35	32.64	74.00	-41.36	206	224	peak
	36260.000	25.34	38.54	5.57	32.94	36.51	74.00	-37.49	300	314	peak

*:Maximum data x:Over limit !:over margin

NOTE: “ * ”: Fundamental Frequency; “ pk ”: peak reading; “ av ”: average reading

The Spectrum noise level+Correction Factor<Limit-6 dB

Margin = Corrected Amplitude – Limit

Corrected Amplitude=Radiated Amplitude+Antenna Correction Factor+Cable Loss-Pre-Amplifier Gain

A margin of -8dB means that the emission is 8dB below the limit.

All frequencies from 1GHz to 40 GHz have been tested.

1GHz~ 40 GHz (Horizontal), 5200 MHz



Address: No. 120, Lane 180, San Ho Tsuen, Hsin Ho Road
, Lung-Tan Hsiang, Tao Yuan Conty, Taiwan R.O.C.
Tel: 03-4071718

Radiated Emission Measurement

Date: 2008/5/2
Time: PM 04:06:55

Operator: JERRY
Temperature: 20 °C
Humidity: 54 %

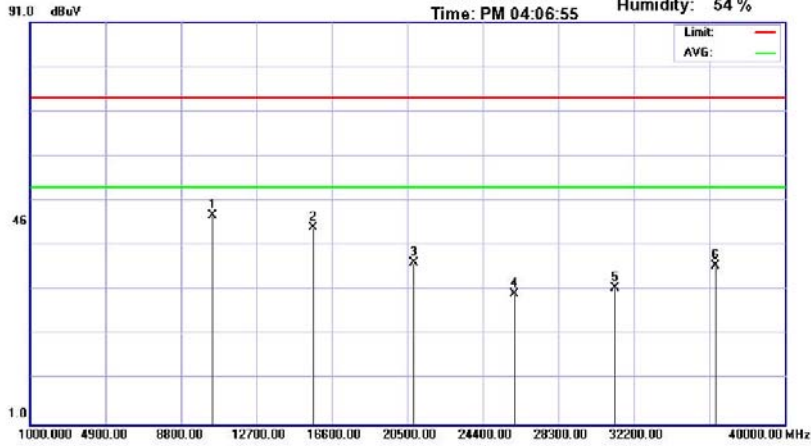

Site : Chamber 02

Condition : FCC Class B 3M(Peak)

Polarization: *Horizontal*

Mk.	Frequency (MHz)	RX_R (dBuV)	Ant_F (dB)	Cab_L (dB)	PreAmp (dB)	Emission (dBuV)	Limit (dBuV)	Margin (dB)	Ant.Pos (cm)	Tab.Pos (deg.)	Detector
*	10400.000	32.62	39.84	4.19	28.98	47.67	74.00	-26.33	100	252	peak
	15600.000	30.99	38.96	5.07	30.04	44.98	74.00	-29.02	100	330	peak
	20800.000	25.97	33.64	5.9	28.48	37.03	74.00	-36.97	361	218	peak
	26000.000	16.09	34.1	5.53	25.6	30.12	74.00	-43.88	240	165	peak
	31200.000	24.73	36.9	5.1	35.28	31.45	74.00	-42.55	306	248	peak
	36400.000	25.39	38.46	5.47	32.8	36.52	74.00	-37.48	132	203	peak

*:Maximum data x:Over limit !:over margin

1GHz~ 40 GHz (Vertical), 5200 MHz

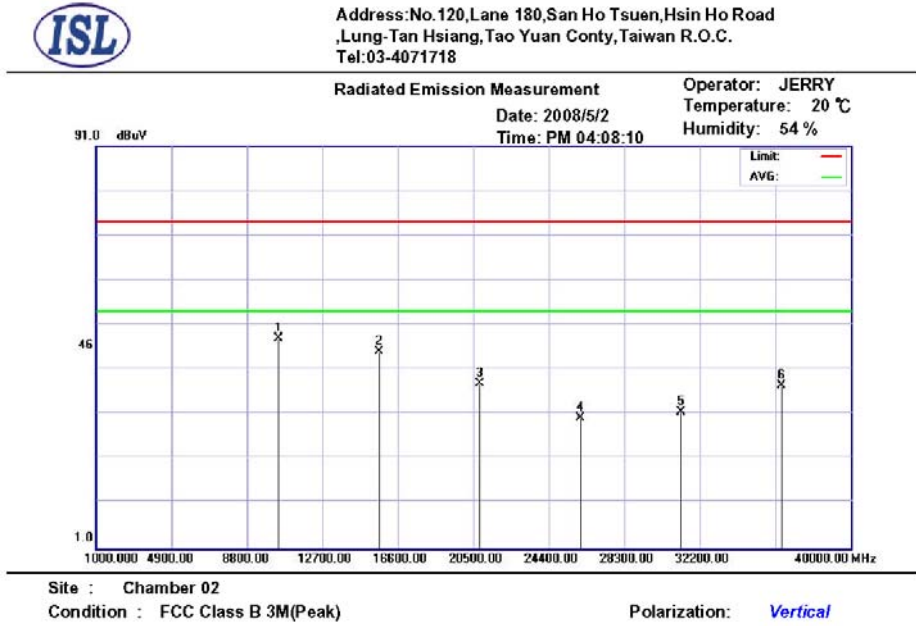

Mk.	Frequency (MHz)	RX_R (dBuV)	Ant_F (dB)	Cab_L (dB)	PreAmp (dB)	Emission (dBuV)	Limit (dBuV)	Margin (dB)	Ant.Pos (cm)	Tab.Pos (deg.)	Detector
*	10400.000	32.84	39.84	4.19	28.98	47.89	74.00	-26.11	172	74	peak
	15600.000	30.99	38.96	5.07	30.04	44.98	74.00	-29.02	296	326	peak
	20800.000	26.79	33.64	5.9	28.48	37.85	74.00	-36.15	307	188	peak
	26000.000	16.09	34.1	5.53	25.6	30.12	74.00	-43.88	261	83	peak
	31200.000	24.77	36.9	5.1	35.28	31.49	74.00	-42.51	168	96	peak
	36400.000	26.30	38.46	5.47	32.8	37.43	74.00	-36.57	187	11	peak

*:Maximum data x:Over limit !:over margin

NOTE: “ * ”: Fundamental Frequency; “ pk ”: peak reading; “ av ”: average reading
 The Spectrum noise level+Correction Factor<Limit-6 dB
 Margin = Corrected Amplitude – Limit
 Corrected Amplitude=Radiated Amplitude+Antenna Correction Factor+Cable Loss-Pre-Amplifier Gain
 A margin of -8dB means that the emission is 8dB below the limit.
All frequencies from 1GHz to 40 GHz have been tested.

1GHz~ 40 GHz (Horizontal), 5240 MHz

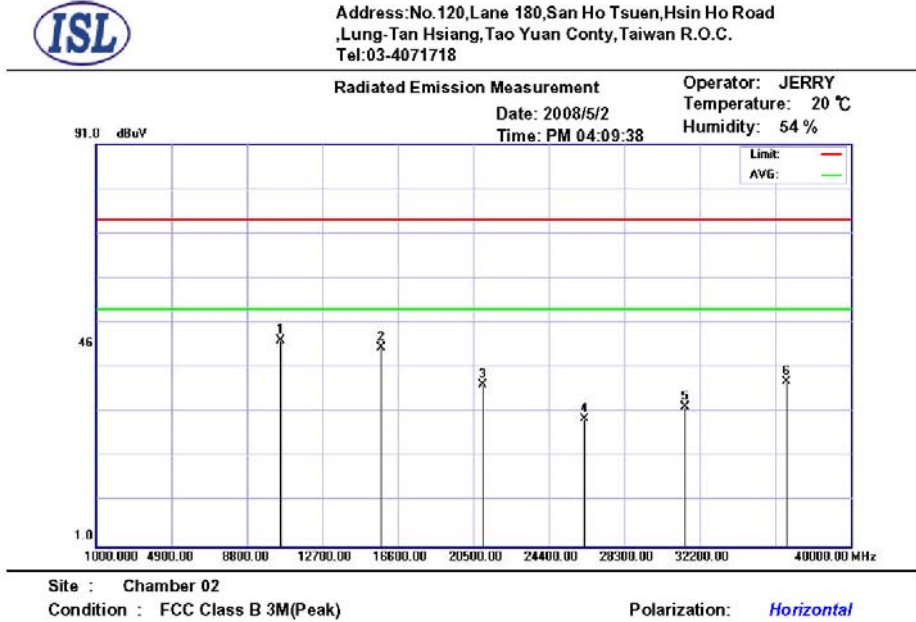

Mk.	Frequency (MHz)	RX_R (dBuV)	Ant_F (dB)	Cab_L (dB)	PreAmp (dB)	Emission (dBuV)	Limit (dBuV)	Margin (dB)	Ant.Pos (cm)	Tab.Pos (deg.)	Detector
*	10480.000	32.01	39.81	4.21	29.08	46.95	74.00	-27.05	289	251	peak
	15720.000	31.26	39.15	5.11	30.09	45.43	74.00	-28.57	212	350	peak
	20960.000	25.69	33.77	5.92	28.26	37.12	74.00	-36.88	134	254	peak
	26200.000	25.20	34.22	5.55	35.5	29.47	74.00	-44.53	216	39	peak
	31440.000	25.47	36.66	5.25	35.14	32.24	74.00	-41.76	100	40	peak
	36680.000	26.50	38.44	5.27	32.48	37.73	74.00	-36.27	149	342	peak

*:Maximum data x:Over limit !:over margin

1GHz~ 40 GHz (Vertical), 5240 MHz

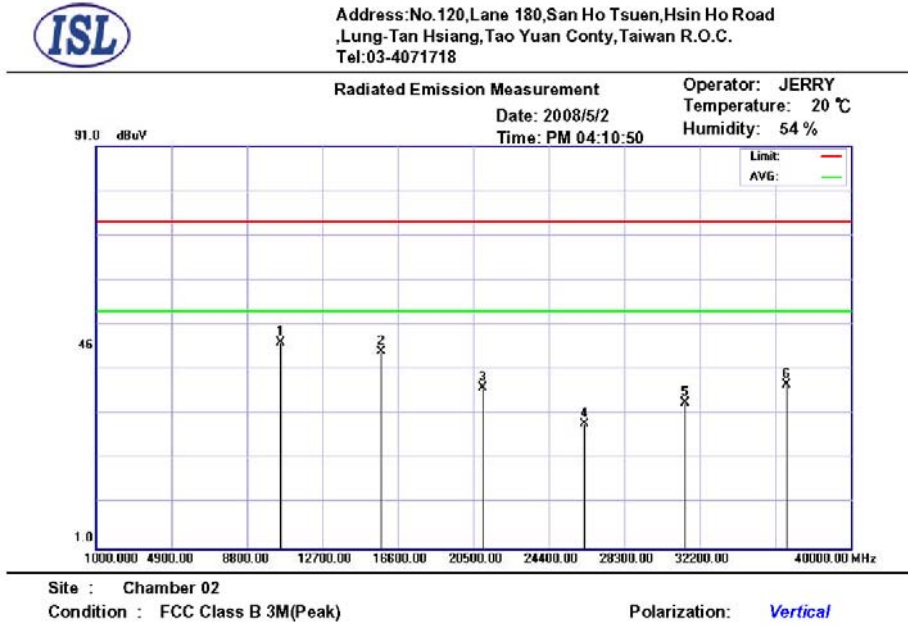

Mk.	Frequency (MHz)	RX_R (dBuV)	Ant_F (dB)	Cab_L (dB)	PreAmp (dB)	Emission (dBuV)	Limit (dBuV)	Margin (dB)	Ant.Pos (cm)	Tab.Pos (deg.)	Detector
*	10480.000	32.17	39.81	4.21	29.08	47.11	74.00	-26.89	341	206	peak
	15720.000	30.73	39.15	5.11	30.09	44.90	74.00	-29.10	134	303	peak
	20960.000	25.43	33.77	5.92	28.26	36.86	74.00	-37.14	239	166	peak
	26200.000	24.45	34.22	5.55	35.5	28.72	74.00	-45.28	267	57	peak
	31440.000	26.80	36.66	5.25	35.14	33.57	74.00	-40.43	397	7	peak
	36680.000	26.27	38.44	5.27	32.48	37.50	74.00	-36.50	382	34	peak

*:Maximum data x:Over limit !:over margin

NOTE: “ * ”: Fundamental Frequency; “ pk ”: peak reading; “ av ”: average reading
 The Spectrum noise level+Correction Factor<Limit-6 dB
 Margin = Corrected Amplitude – Limit
 Corrected Amplitude=Radiated Amplitude+Antenna Correction Factor+Cable Loss-Pre-Amplifier Gain
 A margin of -8dB means that the emission is 8dB below the limit.
All frequencies from 1GHz to 40 GHz have been tested.

1GHz~ 40 GHz (Horizontal), 5260 MHz



Address: No.120, Lane 180, San Ho Tsuen, Hsin Ho Road
, Lung-Tan Hsiang, Tao Yuan Conty, Taiwan R.O.C.
Tel: 03-4071718

Radiated Emission Measurement

Date: 2008/5/2
Time: PM 04:13:15

Operator: JERRY
Temperature: 20 °C
Humidity: 54 %

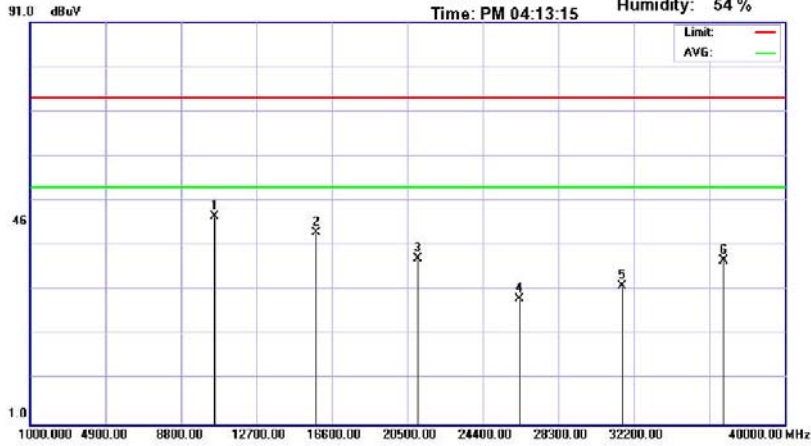

Site : Chamber 02

Condition : FCC Class B 3M(Peak)

Polarization: *Horizontal*

Mk.	Frequency (MHz)	RX_R (dBuV)	Ant_F (dB)	Cab_L (dB)	PreAmp (dB)	Emission (dBuV)	Limit (dBuV)	Margin (dB)	Ant.Pos (cm)	Tab.Pos (deg.)	Detector
*	10520.000	32.53	39.79	4.21	29.14	47.39	74.00	-26.61	139	194	peak
	15780.000	29.70	39.25	5.12	30.11	43.96	74.00	-30.04	100	249	peak
	21040.000	26.45	33.74	5.94	28.16	37.97	74.00	-36.03	377	170	peak
	26300.000	24.80	34.28	5.57	35.6	29.05	74.00	-44.95	100	89	peak
	31560.000	25.12	36.65	5.33	35.05	32.05	74.00	-41.95	218	288	peak
	36820.000	26.33	38.46	5.17	32.32	37.64	74.00	-36.36	213	188	peak

*:Maximum data x:Over limit !:over margin

1GHz~ 40 GHz (Vertical), 5260 MHz

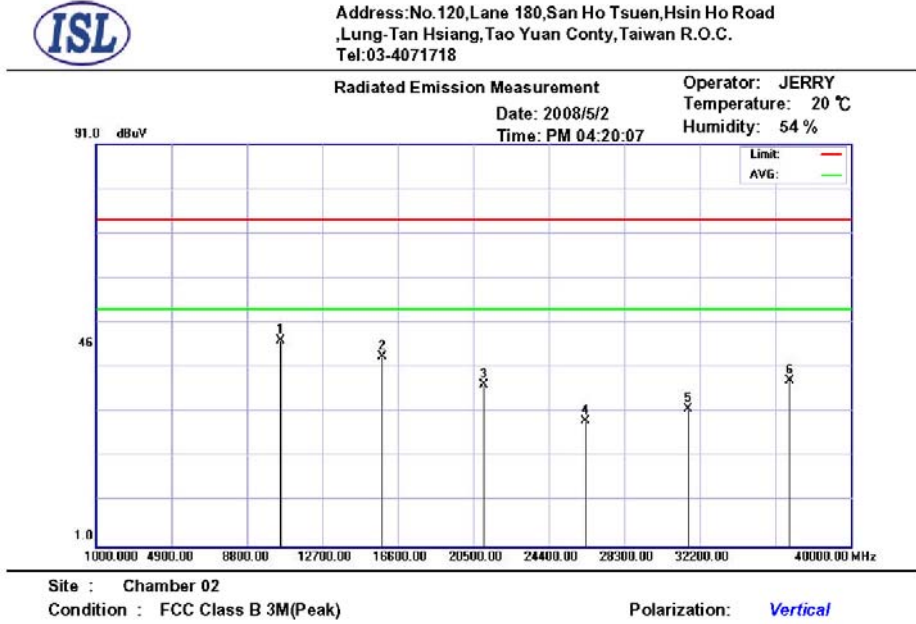

Mk.	Frequency (MHz)	RX_R (dBuV)	Ant_F (dB)	Cab_L (dB)	PreAmp (dB)	Emission (dBuV)	Limit (dBuV)	Margin (dB)	Ant.Pos (cm)	Tab.Pos (deg.)	Detector
*	10520.000	32.20	39.79	4.21	29.14	47.06	74.00	-26.94	244	277	peak
	15780.000	29.15	39.25	5.12	30.11	43.41	74.00	-30.59	245	47	peak
	21040.000	25.58	33.74	5.94	28.16	37.10	74.00	-36.90	135	55	peak
	26300.000	24.75	34.28	5.57	35.6	29.00	74.00	-45.00	219	58	peak
	31560.000	24.77	36.65	5.33	35.05	31.70	74.00	-42.30	100	286	peak
	36820.000	26.76	38.46	5.17	32.32	38.07	74.00	-35.93	288	106	peak

*:Maximum data x:Over limit !:over margin

NOTE: “ * ”: Fundamental Frequency; “ pk ”: peak reading; “ av ”: average reading
 The Spectrum noise level+Correction Factor<Limit-6 dB
 Margin = Corrected Amplitude – Limit
 Corrected Amplitude=Radiated Amplitude+Antenna Correction Factor+Cable Loss-Pre-Amplifier Gain
 A margin of -8dB means that the emission is 8dB below the limit.
All frequencies from 1GHz to 40 GHz have been tested.

1GHz~ 40 GHz (Horizontal), 5280 MHz



Address: No. 120, Lane 180, San Ho Tsuen, Hsin Ho Road
, Lung-Tan Hsiang, Tao Yuan Conty, Taiwan R.O.C.
Tel: 03-4071718

Radiated Emission Measurement

Date: 2008/5/2
Time: PM 04:21:45

Operator: JERRY
Temperature: 20 °C
Humidity: 54 %

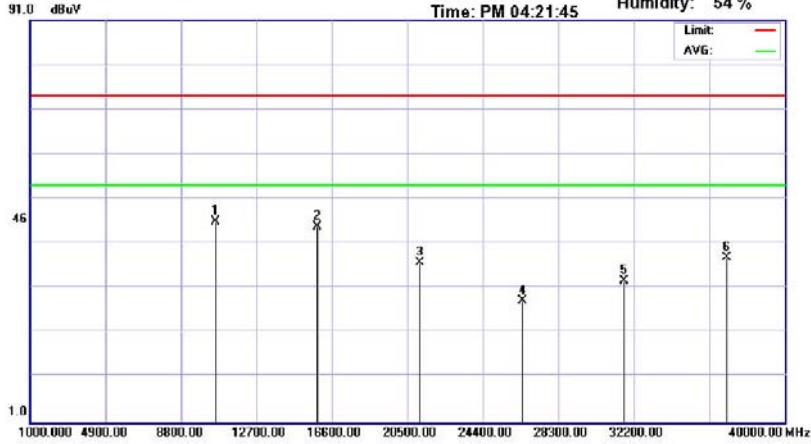

Site : Chamber 02

Condition : FCC Class B 3M(Peak)

Polarization: *Horizontal*

Mk.	Frequency (MHz)	RX_R (dBuV)	Ant_F (dB)	Cab_L (dB)	PreAmp (dB)	Emission (dBuV)	Limit (dBuV)	Margin (dB)	Ant.Pos (cm)	Tab.Pos (deg.)	Detector
*	10560.000	31.15	39.76	4.22	29.23	45.90	74.00	-28.10	132	91	peak
	15840.000	30.47	39.34	5.14	30.14	44.81	74.00	-29.19	257	257	peak
	21120.000	25.20	33.63	5.95	28.08	36.70	74.00	-37.30	224	25	peak
	26400.000	23.96	34.34	5.58	35.7	28.18	74.00	-45.82	100	208	peak
	31680.000	25.40	36.74	5.41	34.96	32.59	74.00	-41.41	100	110	peak
	36960.000	26.33	38.49	5.07	32.15	37.74	74.00	-36.26	270	91	peak

*:Maximum data x:Over limit !:over margin

1GHz~ 40 GHz (Vertical) , 5280 MHz

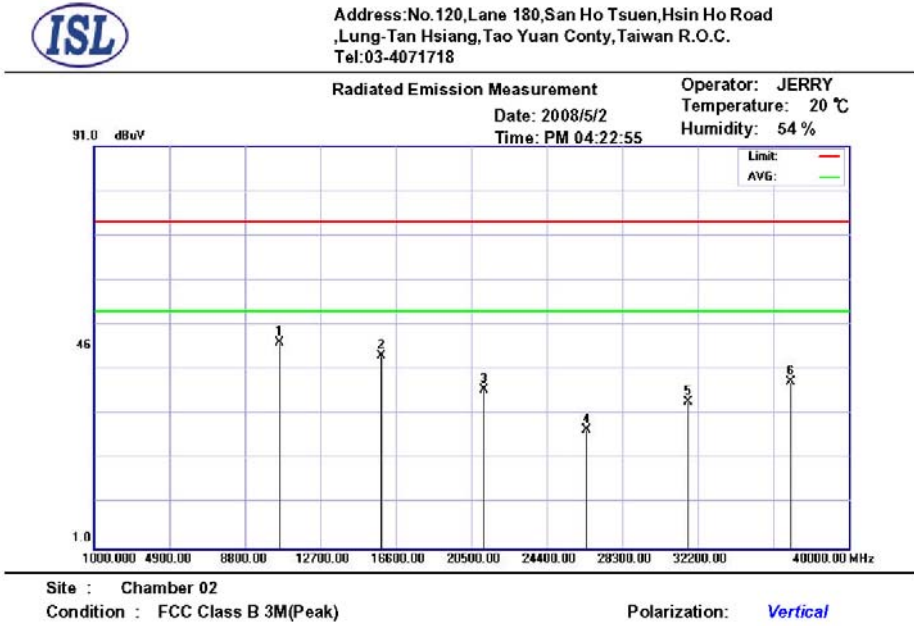

Mk.	Frequency (MHz)	RX_R (dBuV)	Ant_F (dB)	Cab_L (dB)	PreAmp (dB)	Emission (dBuV)	Limit (dBuV)	Margin (dB)	Ant.Pos (cm)	Tab.Pos (deg.)	Detector
*	10560.000	32.18	39.76	4.22	29.23	46.93	74.00	-27.07	100	286	peak
	15840.000	29.70	39.34	5.14	30.14	44.04	74.00	-29.96	227	306	peak
	21120.000	25.03	33.63	5.95	28.08	36.53	74.00	-37.47	100	350	peak
	26400.000	23.15	34.34	5.58	35.7	27.37	74.00	-46.63	345	325	peak
	31680.000	26.47	36.74	5.41	34.96	33.66	74.00	-40.34	100	36	peak
	36960.000	26.76	38.49	5.07	32.15	38.17	74.00	-35.83	100	105	peak

*:Maximum data x:Over limit !:over margin

NOTE: “ * ”: Fundamental Frequency; “ pk ”: peak reading; “ av ”: average reading
 The Spectrum noise level+Correction Factor<Limit-6 dB
 Margin = Corrected Amplitude – Limit
 Corrected Amplitude=Radiated Amplitude+Antenna Correction Factor+Cable Loss-Pre-Amplifier Gain
 A margin of -8dB means that the emission is 8dB below the limit.
All frequencies from 1GHz to 40 GHz have been tested.

1GHz~ 40 GHz (Horizontal), 5320 MHz



Address: No. 120, Lane 180, San Ho Tsuen, Hsin Ho Road
, Lung-Tan Hsiang, Tao Yuan Conty, Taiwan R.O.C.
Tel: 03-4071718

Radiated Emission Measurement

Date: 2008/5/2
Time: PM 04:25:26

Operator: JERRY
Temperature: 20 °C
Humidity: 54 %

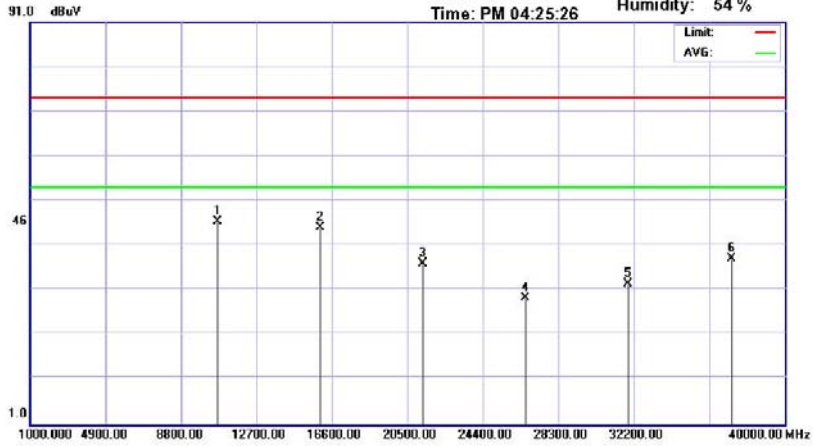

Site : Chamber 02

Condition : FCC Class B 3M(Peak)

Polarization: *Horizontal*

Mk.	Frequency (MHz)	RX_R (dBuV)	Ant_F (dB)	Cab_L (dB)	PreAmp (dB)	Emission (dBuV)	Limit (dBuV)	Margin (dB)	Ant.Pos (cm)	Tab.Pos (deg.)	Detector
*	10640.000	31.87	39.72	4.24	29.41	46.42	74.00	-27.58	333	89	peak
	15960.000	30.43	39.54	5.18	30.18	44.97	74.00	-29.03	100	242	peak
	21280.000	25.33	33.41	5.97	27.92	36.79	74.00	-37.21	204	51	peak
	26600.000	24.77	34.68	5.6	35.78	29.27	74.00	-44.73	146	146	peak
	31920.000	24.69	36.94	5.56	34.76	32.43	74.00	-41.57	329	240	peak
	37240.000	26.32	38.79	4.92	32	38.03	74.00	-35.97	100	321	peak

*:Maximum data x:Over limit !:over margin

1GHz~ 40 GHz (Vertical) , 5320 MHz

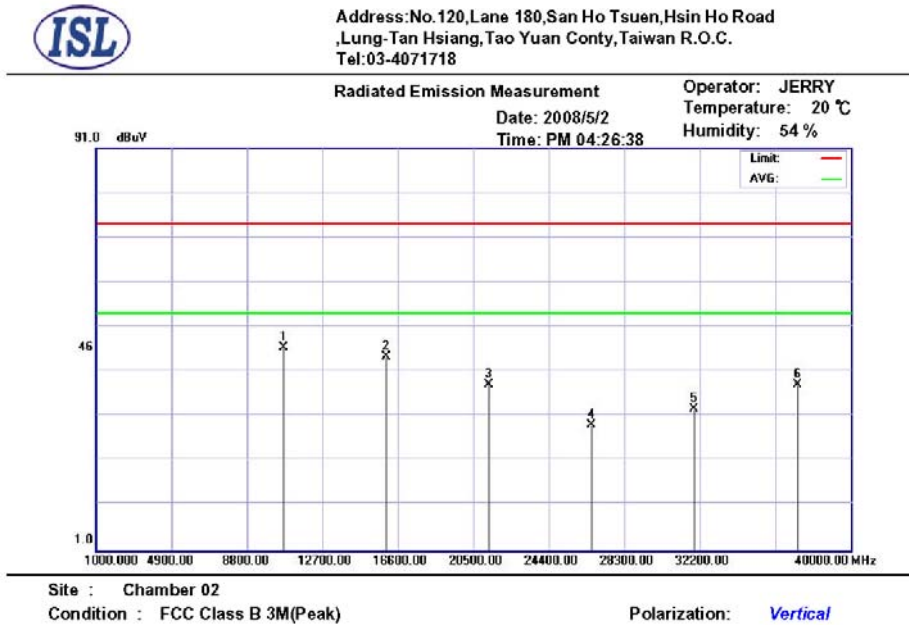

Mk.	Frequency (MHz)	RX_R (dBuV)	Ant_F (dB)	Cab_L (dB)	PreAmp (dB)	Emission (dBuV)	Limit (dBuV)	Margin (dB)	Ant.Pos (cm)	Tab.Pos (deg.)	Detector
*	10640.000	31.79	39.72	4.24	29.41	46.34	74.00	-27.66	100	349	peak
	15960.000	29.77	39.54	5.18	30.18	44.31	74.00	-29.69	107	136	peak
	21280.000	26.52	33.41	5.97	27.92	37.98	74.00	-36.02	119	240	peak
	26600.000	24.58	34.68	5.6	35.78	29.08	74.00	-44.92	133	198	peak
	31920.000	24.95	36.94	5.56	34.76	32.69	74.00	-41.31	194	60	peak
	37240.000	26.29	38.79	4.92	32	38.00	74.00	-36.00	326	355	peak

*:Maximum data x:Over limit !:over margin

NOTE: “ * ”: Fundamental Frequency; “ pk ”: peak reading; “ av ”: average reading
 The Spectrum noise level+Correction Factor<Limit-6 dB
 Margin = Corrected Amplitude – Limit
 Corrected Amplitude=Radiated Amplitude+Antenna Correction Factor+Cable Loss-Pre-Amplifier Gain
 A margin of -8dB means that the emission is 8dB below the limit.
All frequencies from 1GHz to 40 GHz have been tested.

4.6 Band Edge Measurement (Section 15.407 (b) (1) (2))

4.6.1 Test Procedure (Conducted)

1. The Transmitter output of EUT was connected to the spectrum analyzer.
Equipment mode: Spectrum analyzer

Peak Mode:	
SPAN	100MHz
RBW	1MHz
VBW	1MHz
Sweep Time	200msec.

2. Using Peak Search to read the peak power of Carrier frequencies after Maximum Hold function is completed.
3. Find the next peak frequency outside the operation frequency band.

4.6.2 Test Setup (Conducted)

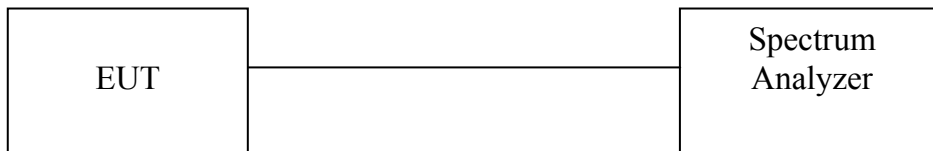

4.6.3 Test Data (conducted):

Band Edge measurement (Conducted)

Temperature (° C): 25

Test Engineer: Jerry Chiou Humidity (%): 50

Outside Channel	Frequency (MHz)	Spectrum Reading (dBuV)	Corrected Factor (dB)	Corrected Emissions (dBuV EIRP)	Limit: (dBuV EIRP)	Pass or Fail
Normal Mode						
1	5145.4	60.07	1.1	61.17	80	Pass
8	5350.4	61.31	1.1	62.41	80	Pass

NOTE: Corrected Emissions=Spectrum + Corrected Factor
Corrected Factor=Cable Loss+Antenna Peak Gain (dBi)

Band Edge Conducted measurement (5180 MHz)

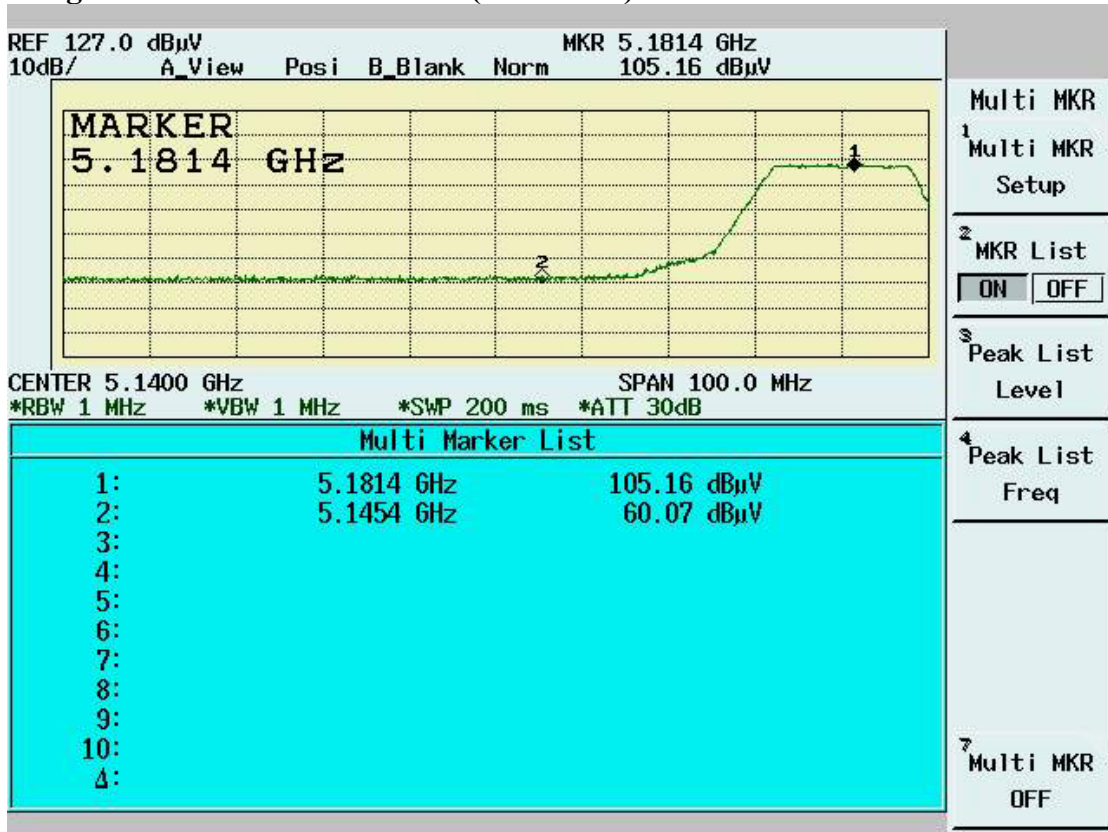

Band Edge Conducted Measurement (5320 MHz)

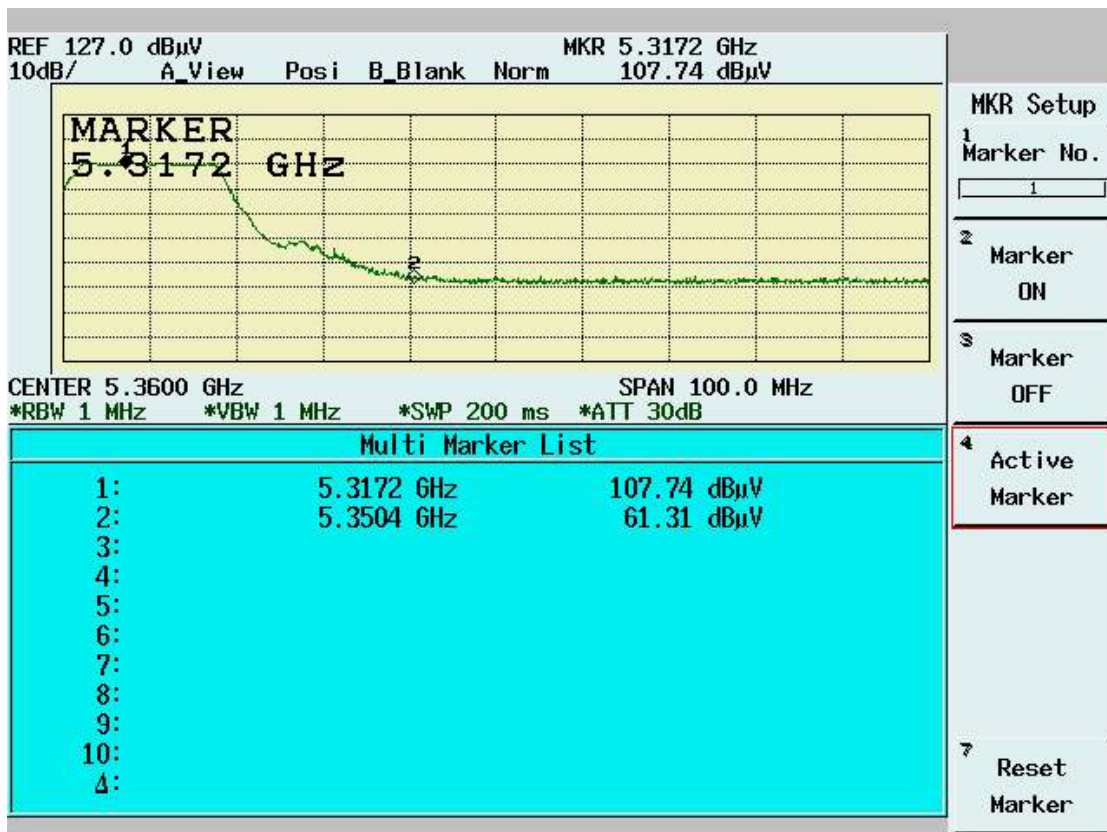

4.6.4 Bandedge Measurement Test Procedure (Radiated)

1. Antenna and Turntable test procedure same as Radiated Emissions measurement listed in Para. 6.5

Equipment mode: Spectrum analyzer

Peak Mode:	
SPAN	100MHz
RBW	1MHz
VBW	3MHz
Sweep Time	200msec.
AVE Mode:	
SPAN	100MHz
RBW	1MHz
VBW	10Hz
Sweep Time	20 sec.

2. Using Peak Search to read the peak power of Carrier frequencies after Maximum Hold function is completed.
3. Find the next peak frequency outside the operation frequency band.
4. Get the spectrum reading after Maximum Hold function is completed.

4.6.5 Test Setup (Radiated)

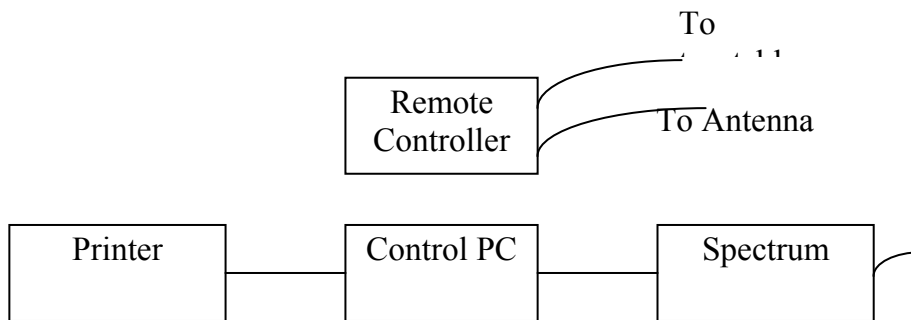
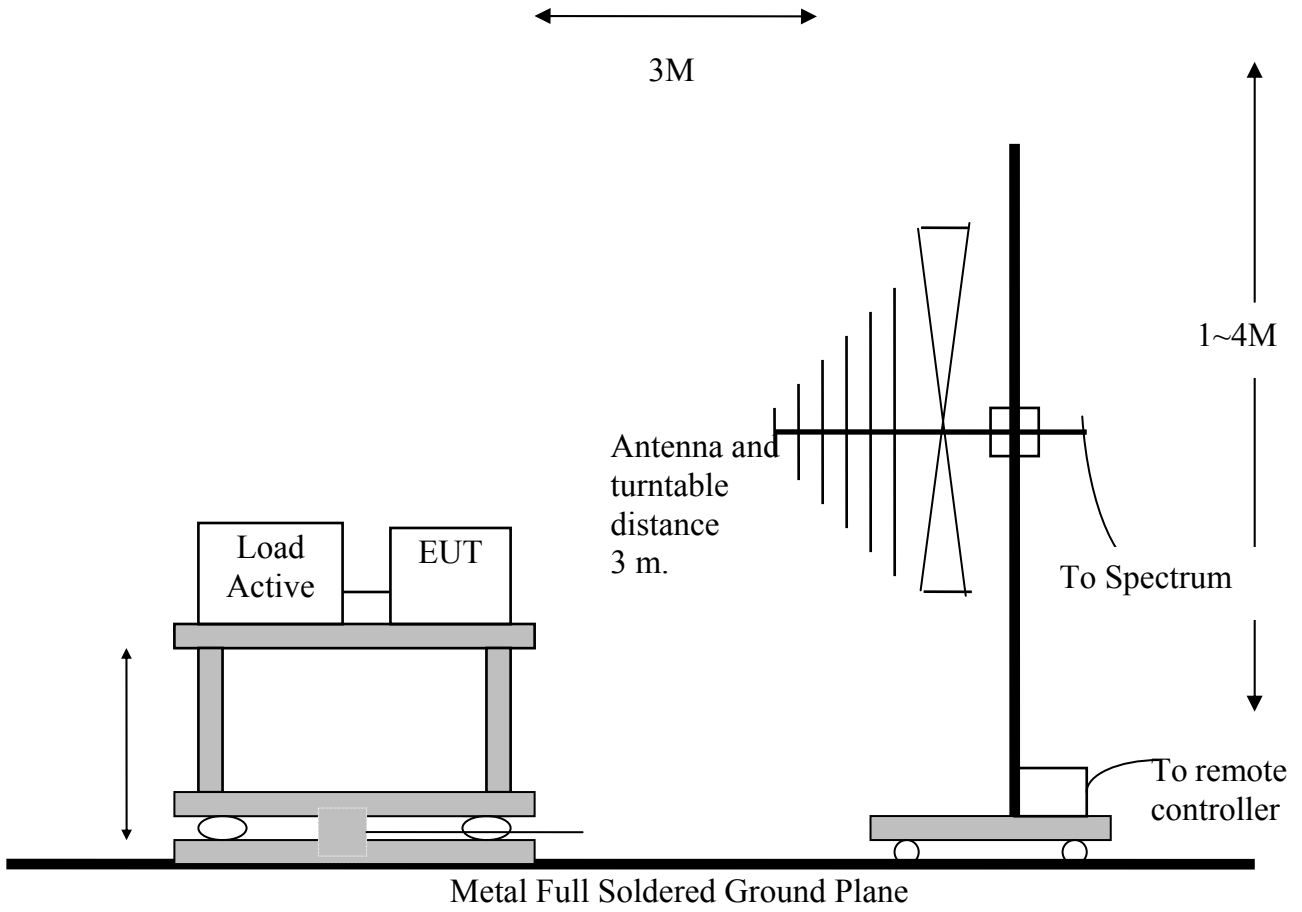

4.6.6 Test Data (Radiated):

Band Edge measurement (Radiated)

Temperature (deg. C): 25

Test Engineer: Jerry Chiou

Humidity (%): 50

Outside Channel (Normal)	Frequency (MHz)	Spectrum Reading (dBuV)	Correction Factor (dB/m)	Emission Level (dBuV/m)	Limit (dBuV/m)	Pass/Fail
1 (Peak)	5149.7	21.21	39.03	60.24	74	Pass
1 (Average)	5150	8.73	39.03	47.76	54	Pass
8 (Peak)	5350.1	21.51	39.34	60.85	74	Pass
8 (Average)	5350	9.13	39.34	48.47	54	Pass

NOTE: “pk”: peak reading; “av”: average reading

Emission Level=Spectrum Reading+Correction Factor

Correction Factor =Antenna Factor+cable loss

Both Horizontal and Vertical polarization have been tested and the worst data is listed above.

Band Edge measurement for radiated emission in Restricted Band(Radiated) Normal Mode(5180 MHz) Peak data

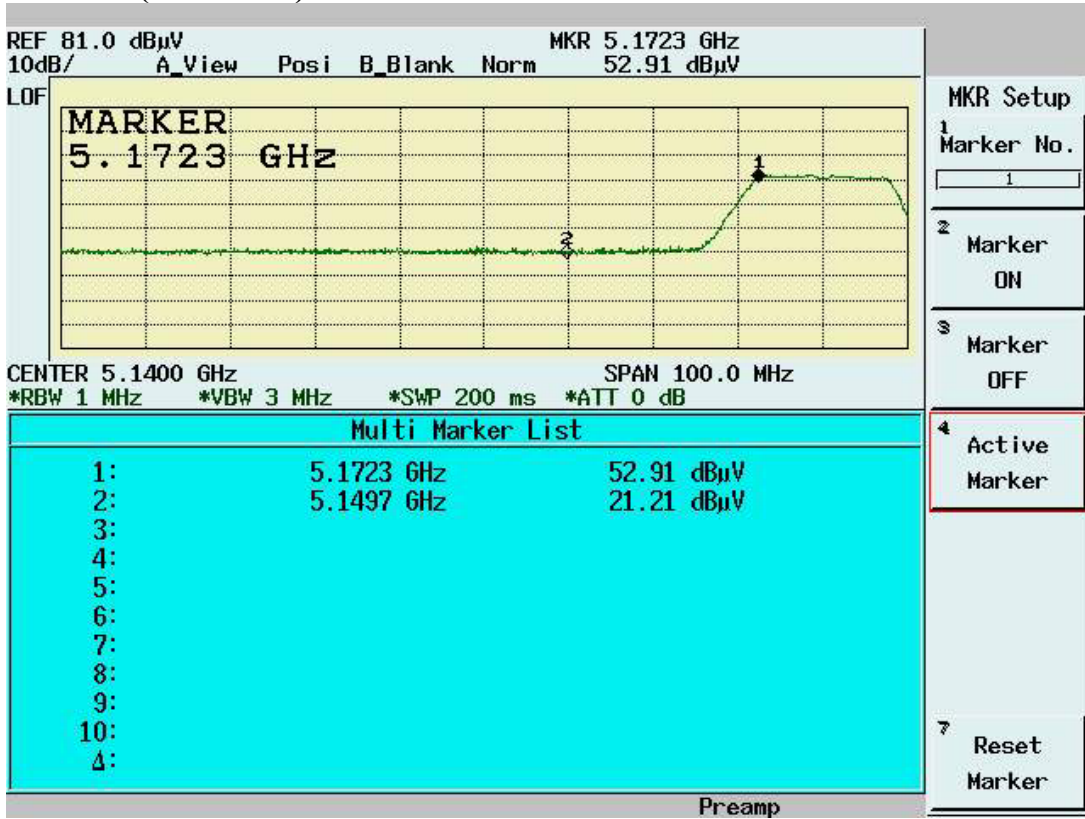

Normal Mode (5180 MHz) Average Data

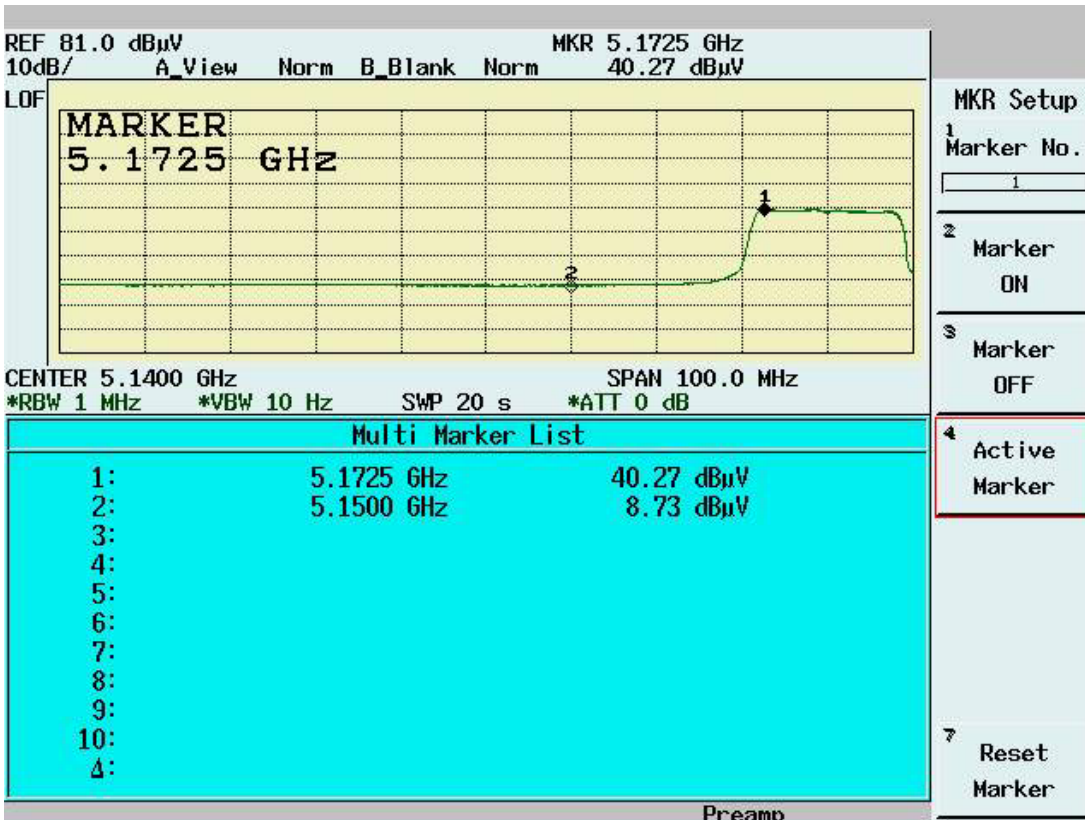

Normal Mode (5320MHz) Peak data

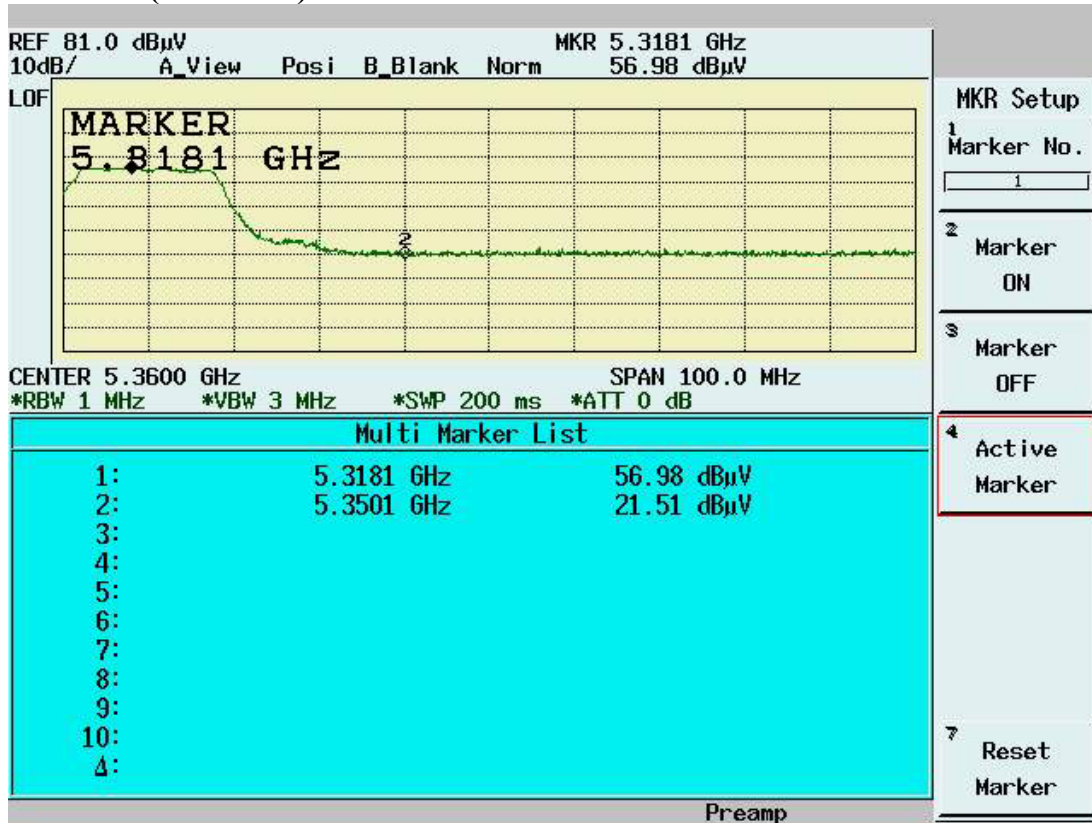

Normal Mode (5320MHz) Average data

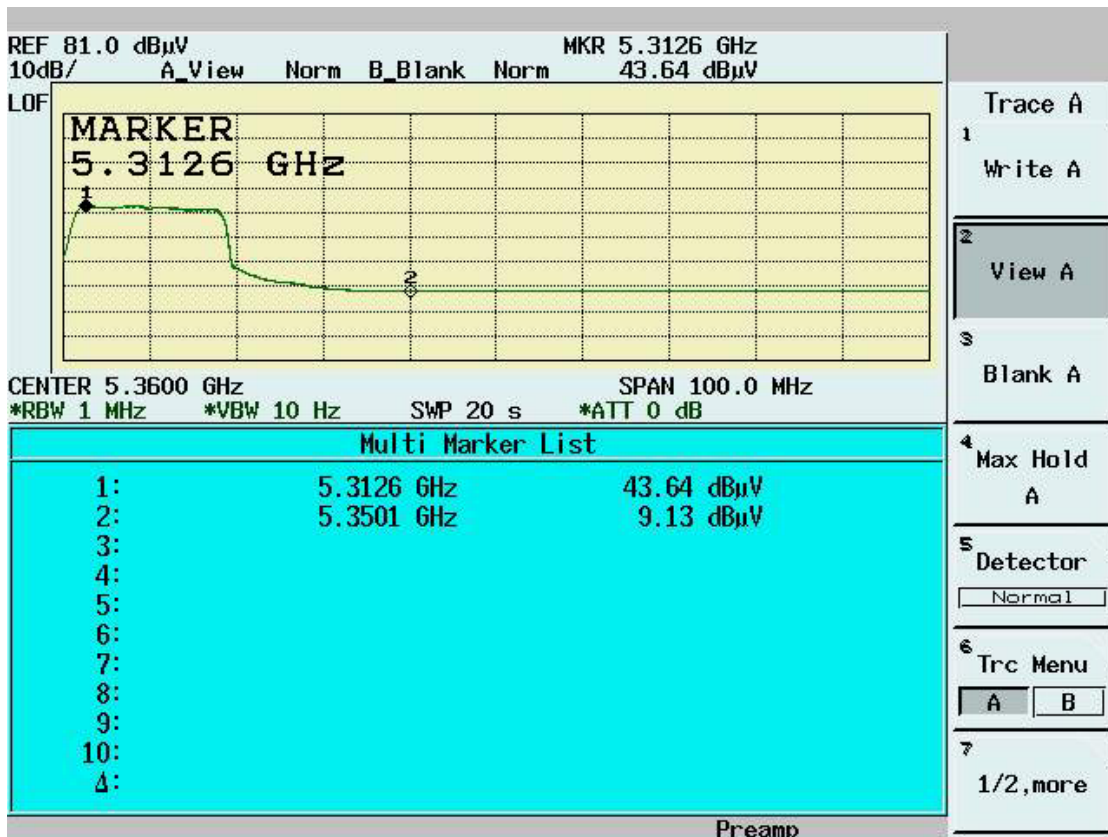

4.7 RF Exposure Measurement [Section 15.407(f)(4) & 1.1307(b)]

Refer to SAR Test Report

4.8 Frequency Stability [Section 15.407(g)]

4.8.1 Limits of Frequency Stability Measurement

The frequency tolerance of the carrier signal shall be maintained within +/- 0.02% of the operating frequency over the operation temperature range of EUT (0°C~35°C), and variation in the primary supply voltage from 85% to 115% of the rated supply voltage (115V AC) at 20°C.

4.8.2 Test Procedure

1. The EUT was placed in the Temperature/Humidity Chamber and powered by a Voltage/Frequency Power converter.
2. Connect the RF output of EUT to Spectrum. Turn on the EUT.
3. Turn the EUT off and set the chamber to the highest temperature specified.
4. Allow sufficient time (approximately 30 min) for the chamber temperature to stabilize. Turn the EUT on and measure the operating frequency after 2, 5, 10 minutes.
5. Set the Voltage/Frequency Power Converter to 85% and 115% of supply voltage, then repeat step 2, 3, 4 respectively.
6. Repeat step 2, 3, 4, 5 with the temperature of chamber set to the lowest temperature.
7. Repeat step 2, 3, 4, 5 with the temperature of chamber set to 20°C.

4.8.3 Test Setup

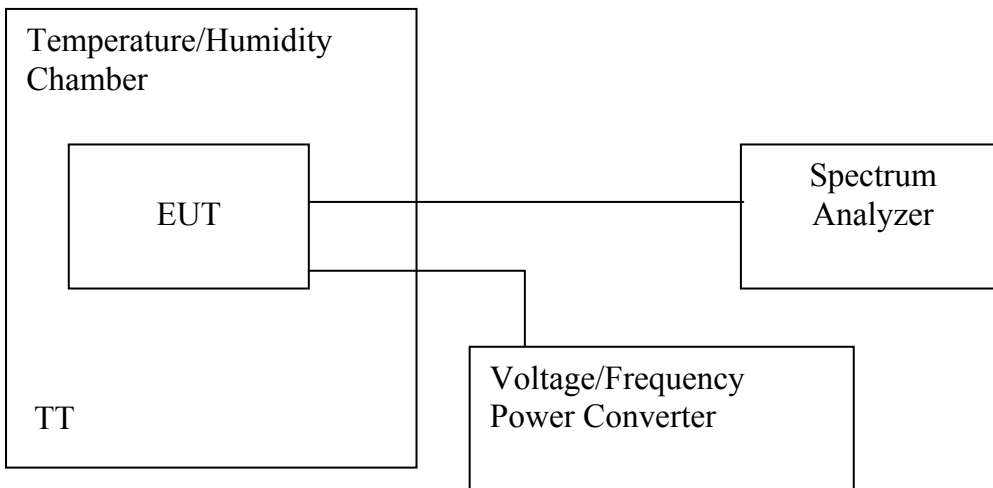

4.8.4 Test Data

Test Engineer: Jerry Chiou

Operating Frequency:		5320 (Mhz)							
Temp.	Power Supply	0 minutes		2 minutes		5 minutes		10 minutes	
(⁰ C)	(V AC)	(MHz)	(%)	(MHz)	(%)	(MHz)	(%)	(MHz)	
50	138	5319.9620	-0.0007	5319.9610	-0.0007	5319.9720	-0.0005	5319.9410	-0.0011
	120	5319.9660	-0.0006	5319.9460	-0.0010	5319.9810	-0.0004	5319.9620	-0.0007
	102	5319.9640	-0.0007	5319.9410	-0.0011	5319.9820	-0.0003	5319.9660	-0.0006
20	138	5319.9420	-0.0011	5319.9600	-0.0008	5319.9730	-0.0005	5319.9610	-0.0007
	120	5319.9420	-0.0011	5319.9640	-0.0007	5319.9560	-0.0008	5319.9980	0.0000
	102	5319.9410	-0.0011	5319.9580	-0.0008	5319.9340	-0.0012	5319.9660	-0.0006
-30	138	5319.9690	-0.0006	5319.9640	-0.0007	5320.0290	0.0005	5319.9520	-0.0009
	120	5319.9600	-0.0008	5319.9550	-0.0008	5319.9810	-0.0004	5319.9930	-0.0001
	102	5319.9570	-0.0008	5319.9950	-0.0001	5319.9960	-0.0001	5319.9940	-0.0001

5. Appendix

5.1 Appendix A: Measurement Procedure for Power line Conducted Emissions

The measurements are performed in a 3.5m x 3.4m x 2.5m shielded room, which referred as Conduction 01 test site, or a 3m x 3m x 2.3m test site, which referred as Conduction 02 test site. The EUT was placed on non-conduction 1.0m x 1.5m table, which is 0.8 meters above an earth-grounded.

Power to the EUT was provided through the LISN which has the Impedance (50ohm/50uH) vs. Frequency Characteristic in accordance with the required standard. Power to the LISNs were filtered to eliminate ambient signal interference and these filters were bonded to the ground plane. Peripheral equipment required to provide a functional system (support equipment) for EUT testing was powered from the second LISN through a ganged, metal power outlet box which is bonded to the ground plane at the LISN.

If the EUT is supplied with a flexible power cord, the power cord length in excess of the distance separating the EUT from the LISN shall be folded back and forth at the center of the lead so as to form a bundle not exceeding 40cm in length. If the EUT is provided with a permanently coiled power cord, bundling of the cord is not required. If the EUT is supplied without a power cord, the EUT shall be connected to the LISN by a power cord of the type specified by the manufacturer which shall not be longer than 1 meter. The excess power cord shall be bundled as described above. If a non-flexible power cord is provided with the EUT, it shall be cut to the length necessary to attach the EUT to the LISN and shall not be bundled.

The interconnecting cables were arranged and moved to get the maximum emission. Both the line of power cord, hot and neutral, were measured.

The highest emissions were analyzed in details by operating the spectrum analyzer in fixed tuned mode to determine the nature of the emissions and to provide information which could be useful in reducing their amplitude.

5.2 Appendix B: Test Procedure for Radiated Emissions

Preliminary Measurements in the Anechoic Chamber

The radiated emissions are initially measured in the anechoic chamber at a measurement distance of 3 meters. Desktop EUT are placed on a wooden stand 0.8 meter in height. The measurement antenna is 3 meters from the EUT. The test setup in anechoic chamber is the same as open site. The turntable rotated 360°. The antenna height is varied from 1-2.5m. The primary objective of the radiated measurements in the anechoic chamber is to identify the frequency spectrum in the absence of the electromagnetic environment existing on the open test site. The frequencies can then be pre-selected on the open test site to obtain the corresponding amplitude. The initial scan is made with the spectrum analyzer in automatic sweep mode. The spectrum peaks are then measured manually to determine the exact frequencies.

Measurements on the Open Site or 10m EMC Chamber

The radiated emissions test will then be repeated on the open site or 10m EMC chamber to measure the amplitudes accurately and without the multiple reflections existing in the shielded room. The EUT and support equipment are set up on the turntable of one of the 3 or 10 meter open field sites. Desktop EUT are set up on a wooden stand 0.8 meter above the ground.

For the initial measurements, the receiving antenna is varied from 1-4 meter height and is changed in the vertical plane from vertical to horizontal polarization at each frequency. Both readings are recorded with the quasi-peak detector with 120KHz bandwidth. For frequency between 30 MHz and 1000MHz, the reading is recorded with peak detector or quasi-peak detector. For frequency above 1 GHz, the reading is recorded with peak detector or average detector with 1 MHz bandwidth.

At the highest amplitudes observed, the EUT is rotated in the horizontal plane while changing the antenna polarization in the vertical plane to maximize the reading. The interconnecting cables were arranged and moved to get the maximum emission. Once the maximum reading is obtained, the antenna elevation and polarization will be varied between specified limits to maximize the readings.

5.3 Appendix C: Test Equipment

5.3.1 Test Equipment List

Location	Equipment Name	Brand	Model	S/N	Last Cal. Date	Next Cal. Date
Conduction	Coaxial Cable 1F-C2	Harbourindustries	RG400	1F-C2	02/13/2007	02/13/2008
Conduction	Digital Hygro-Thermometer Conduct	MicroLife	HT-2126G	ISL-Conduction02	12/26/2007	12/26/2008
Conduction	EMI Receiver 07	Schwarzbeck Mess-Elektronik	FCKL 1528	1528-201	08/31/2007	08/30/2008
Conduction	LISN 01	R&S	ESH2-Z5	890485/013	01/03/2008	01/03/2009
Conduction	LISN 06	R&S	ESH3-Z5	828874/009	12/14/2007	12/14/2008
Radiation	BILOG Antenna 08	Schaffner	CBL6112B	2756	06/13/2007	06/12/2008
Radiation	Coaxial Cable Chmb 02-10M	Belden	RG-8/U	Chmb 02-10M	02/13/2007	02/12/2008
Radiation	Digital Hygro-Thermometer Chmb 02	MicroLife	HT-2126G	Chmb 02	12/26/2007	12/26/2008
Radiation	EMI Receiver 02	HP	85460A	3448A00183	12/29/2007	12/28/2008
Radiation	Spectrum Analyzer 13	Advantest	R3132	121200411	03/16/2007	03/15/2008
Radiation	Horn Antenna 02	Com-Power	AH-118	10088	01/14/2008	01/14/2009
Radiation	Horn Antenna 04	Com-Power	AH-826	081-001	03/13/2007	03/13/2008
Radiation	Horn Antenna 05	Com-Power	AH-640	100A	11/16/2007	11/15/2008
Radiation	Microwave Cable RF SK-01	HUBER+SUHNERAG.	Sucoflex 102	22139 /2	06/01/2007	06/01/2008
Radiation	Preamplifier 09	MITEQ	AFS44-00102 650-40-10P-44	858687	04/02/2007	04/02/2008
Radiation	Preamplifier 10	MITEQ	JS-26004000-2 7-5A	818471	12/28/2007	12/28/2008
Radiation	High Pass Filter 01	HEWLETT-PACKARD	84300-80038	001	N/A	N/A
Radiation	High Pass Filter 02	HEWLETT-PACKARD	84300-80039	005	N/A	N/A
Radiation	Spectrum Analyzer 14	Advantest	R3182	140600028	12/06/2007	12/06/2008

Note: Calibration is traceable to NIST or national or international standards.

5.3.2 Software for Controlling Spectrum/Receiver and Calculating Test Data

Radiation/Conduction	Filename	Version	Issued Date
Conduction	Tile.exe	1.12E	7/7/2000
Radiation	Tile.exe	1.12C	6/16/2000

5.4 Appendix D: Layout of EUT and Support Equipment

5.4.1 General Conducted Test Configuration

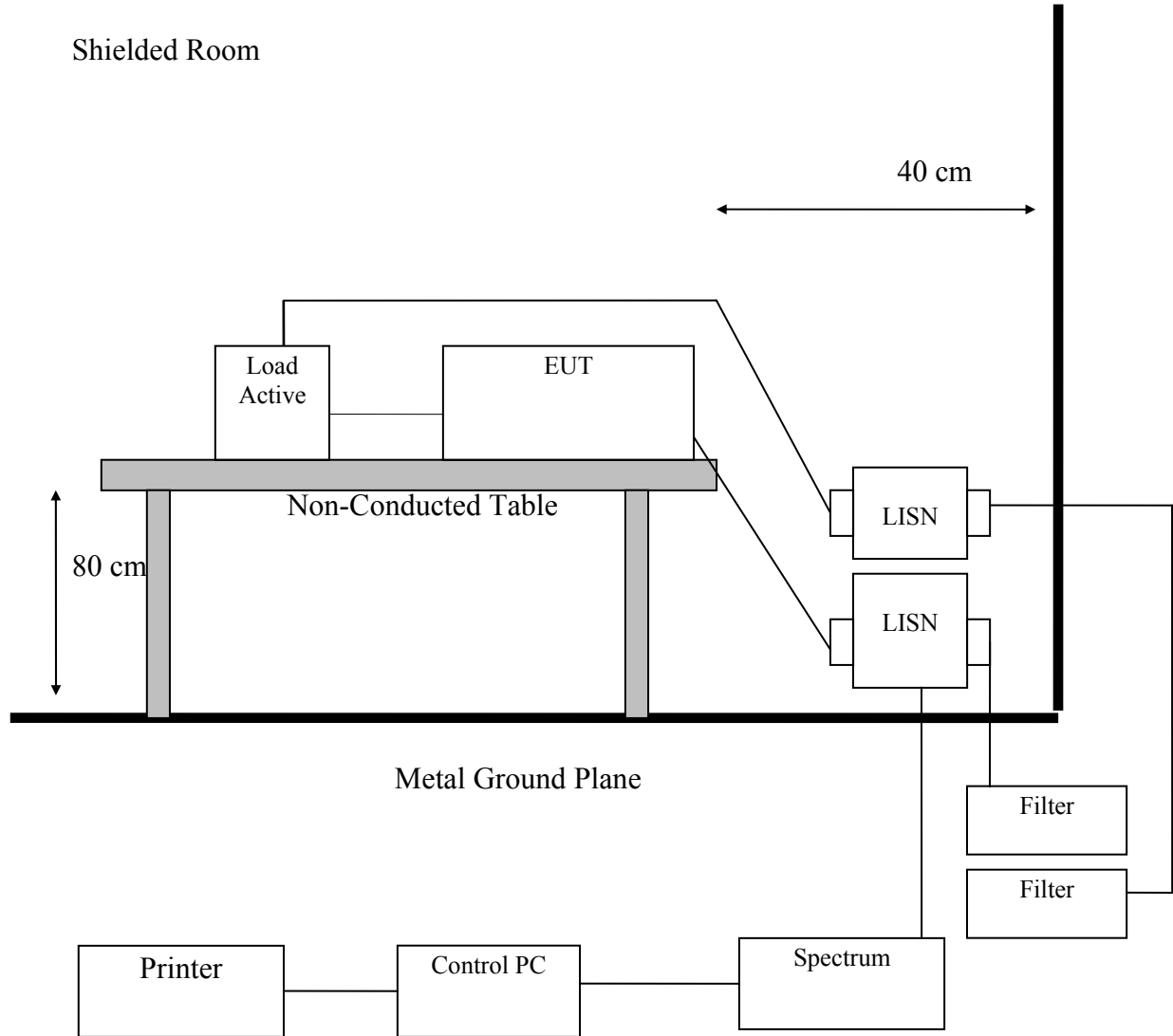

5.4.2 General Radiation Test Configuration

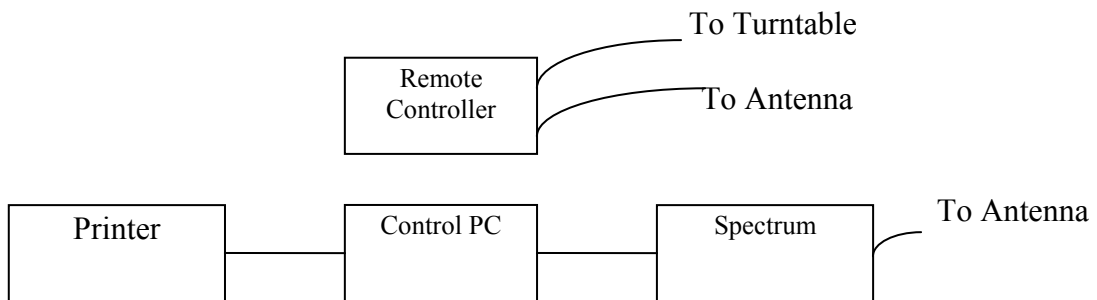
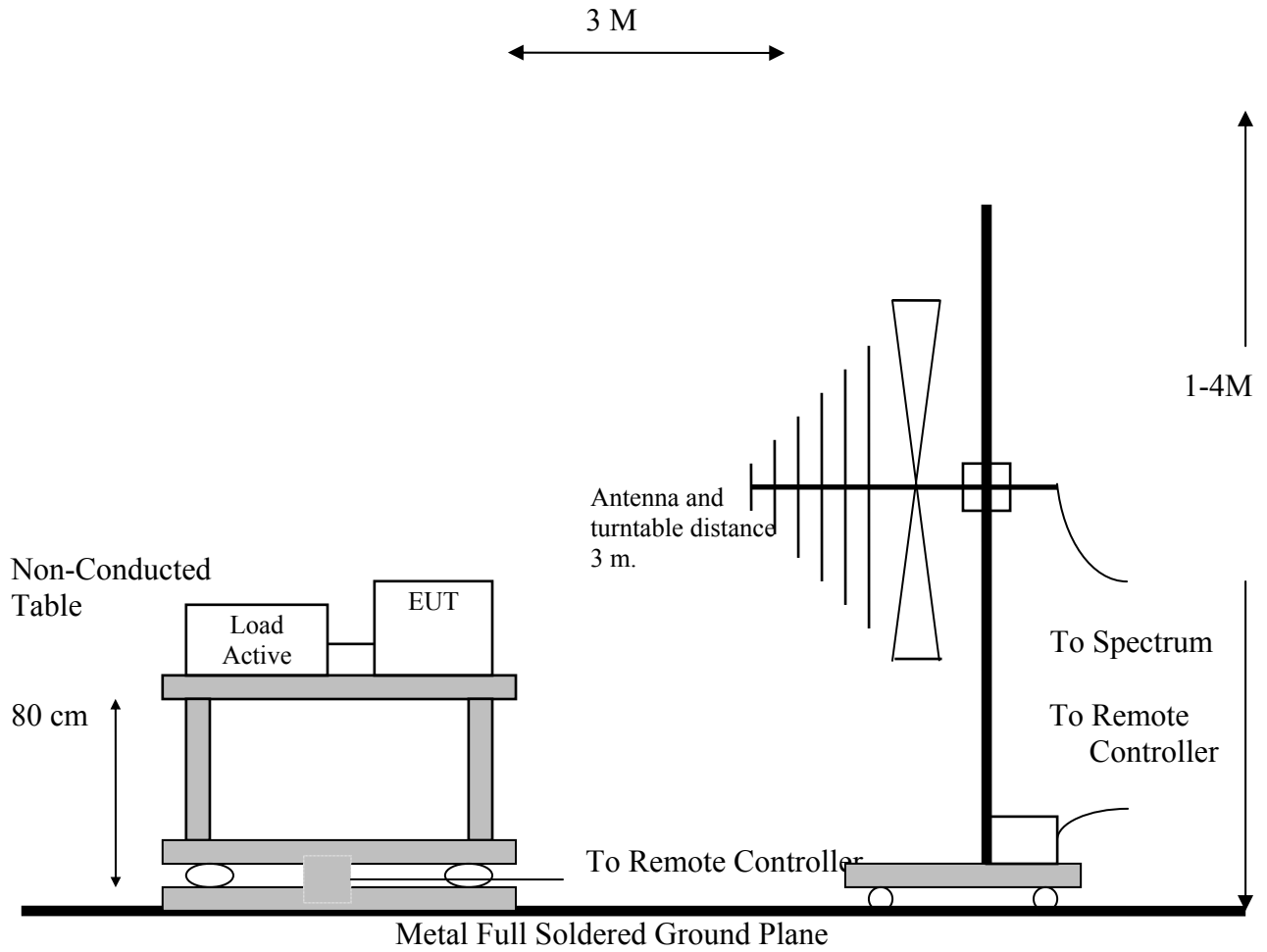

5.5 Appendix E: Accuracy of Measurement

The measurement uncertainty refers to CISPR 16-4-2:2003. The coverage factor $k = 2$ yields approximately a 95 % level of confidence.

<Conduction 02>: $\pm 1.77\text{dB}$

<Chamber 02 (10M)>
30MHz~1GHz: $\pm 2.56\text{dB}$

5.6 Appendix F: Photographs of EUT Configuration Test Set Up

The Front View of Highest Conducted Set-up For EUT



The Back View of Highest Conducted Set-up For EUT

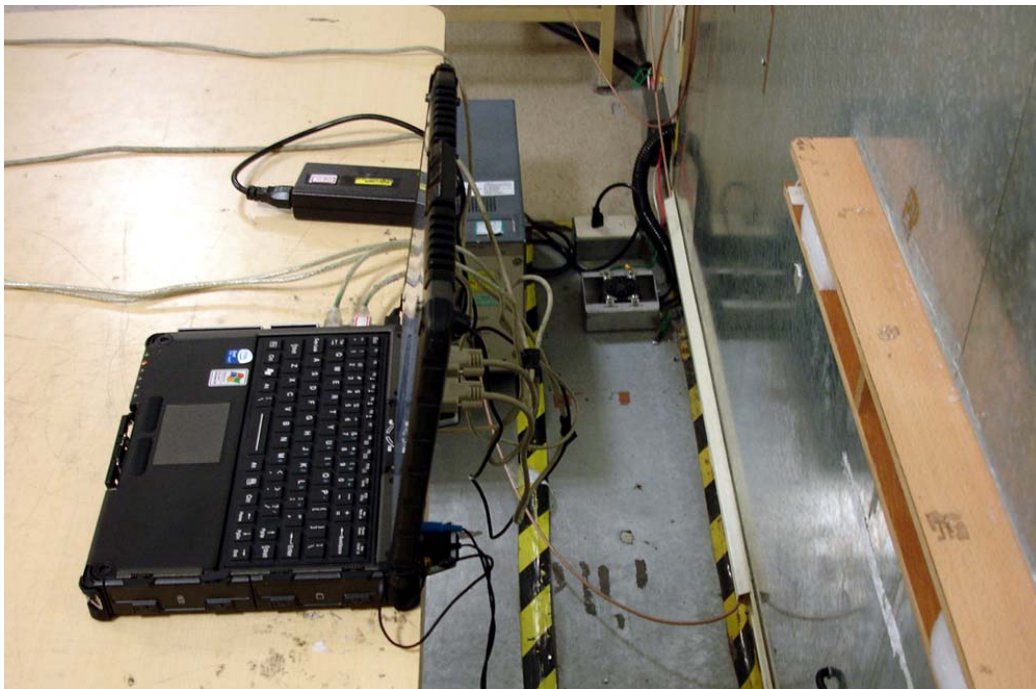

The Front View of Highest Radiated Set-up For EUT

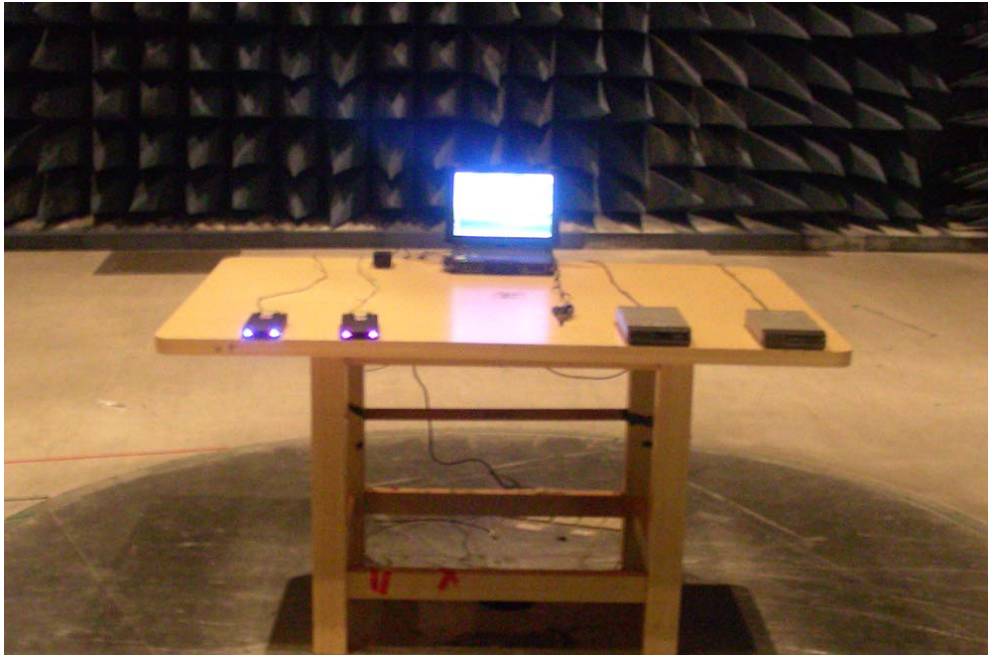

The Back View of Highest Radiated Set-up For EUT

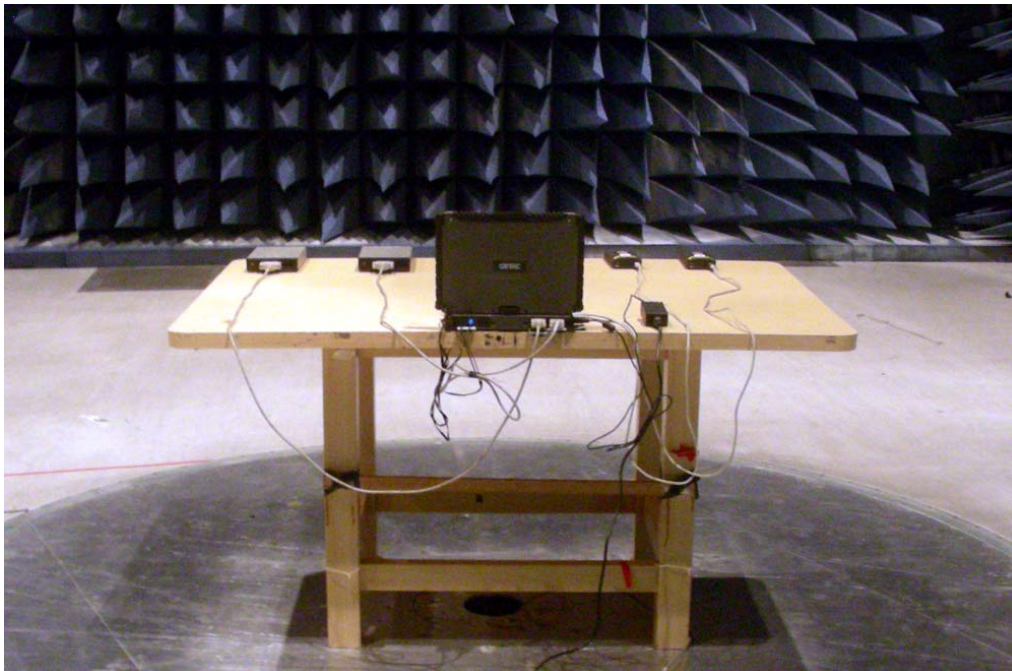

5.7 Appendix G: Antenna Specification

Please refer to the attached file.