

3.1 5200 MHz 802.11a Main Ant. , EUT Position: Back

Measurement Date : 29-Jan-2007
Crest Factor : 1
Area Scan : 5x7x1 : Measurement x=10mm, y=10mm, z=4mm
Zoom Scan : 9x9x13 : Measurement x=4mm, y=4mm, z=2.5mm
DUT Position : Touch
Channel : Low - 5180MHz
Power Drift-Start : 0.041 W/kg
Power Drift-Finish: 0.040 W/kg
Power Drift (%) : -2.441

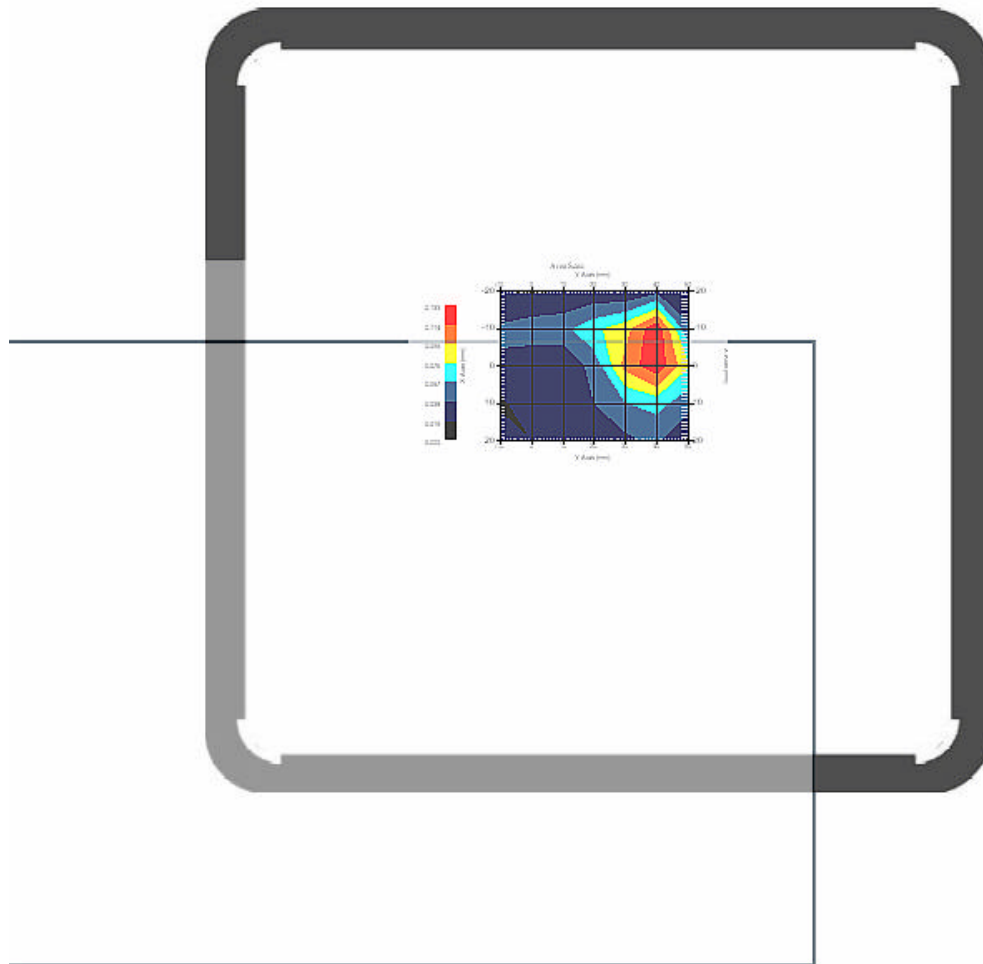

1 gram SAR value : 0.128 W/kg
10 gram SAR value : 0.077 W/kg
Area Scan Peak SAR : 0.131 W/kg
Zoom Scan Peak SAR : 0.170 W/kg

Area Scan Plot

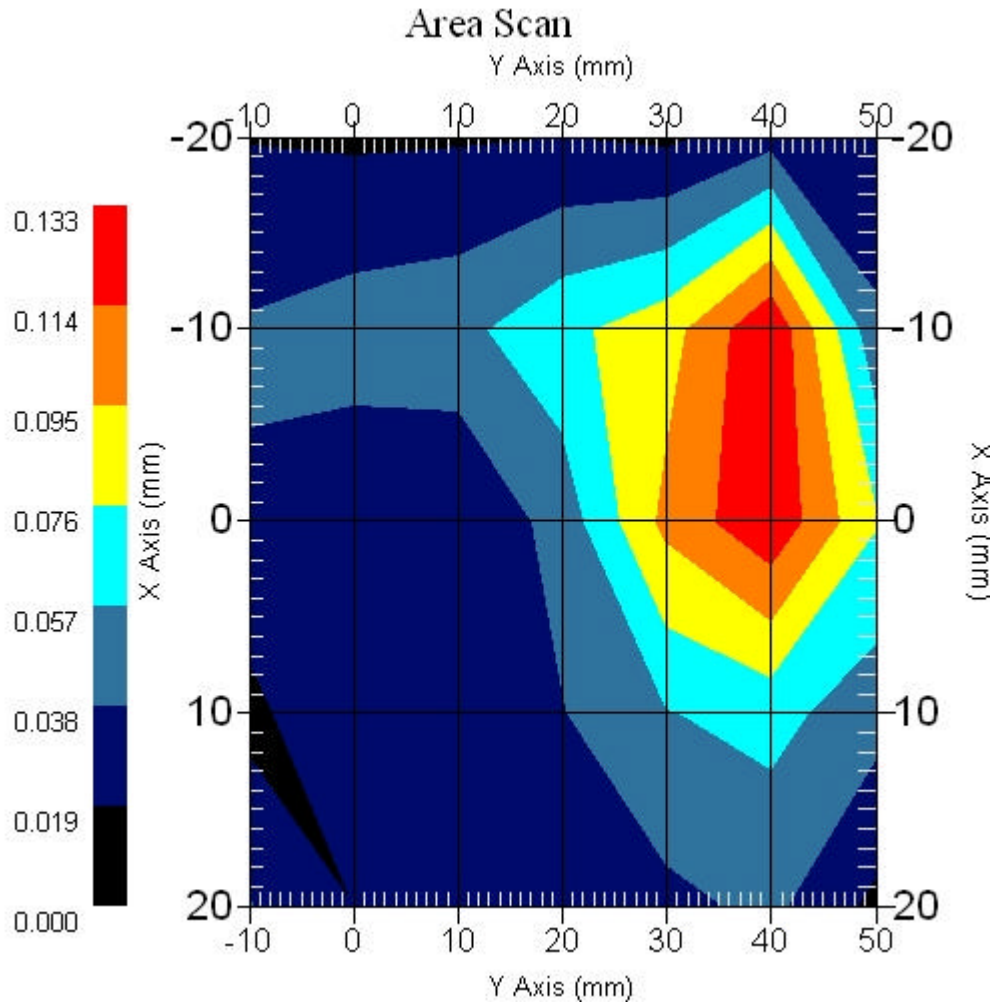

3.2 5200 MHz 802.11a Main Ant. , EUT Position: Back

Measurement Date : 29-Jan-2007
Crest Factor : 1
Area Scan : 5x7x1 : Measurement x=10mm, y=10mm, z=4mm
Zoom Scan : 9x9x13 : Measurement x=4mm, y=4mm, z=2.5mm
DUT Position : Touch
Channel : Mid - 5240MHz
Power Drift-Start : 0.074 W/kg
Power Drift-Finish: 0.073 W/kg
Power Drift (%) : -1.857

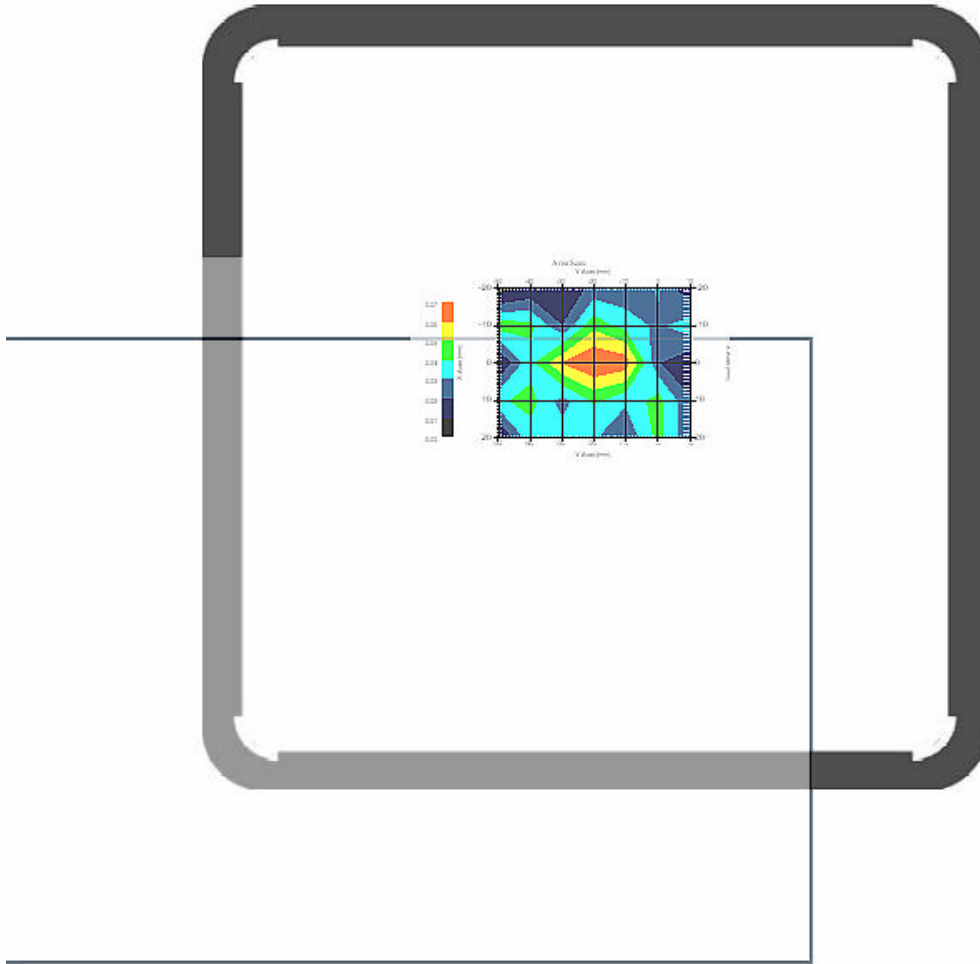

1 gram SAR value : 0.069 W/kg
10 gram SAR value : 0.029 W/kg
Area Scan Peak SAR : 0.073 W/kg
Zoom Scan Peak SAR : 0.166 W/kg

Area Scan Plot

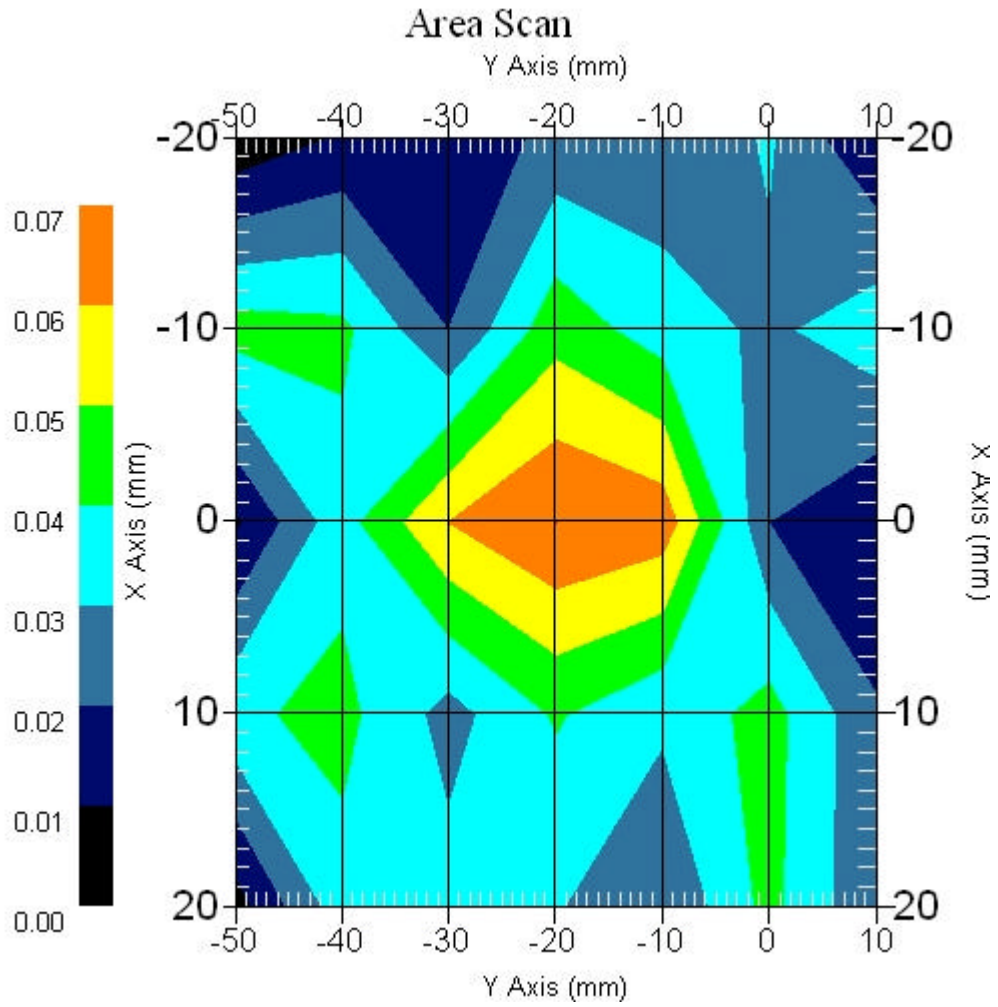

3.3 5200 MHz 802.11a Main Ant. , EUT Position: Back

Measurement Date : 29-Jan-2007
Crest Factor : 1
Area Scan : 5x7x1 : Measurement x=10mm, y=10mm, z=4mm
Zoom Scan : 9x9x13 : Measurement x=4mm, y=4mm, z=2.5mm

DUT Position : Touch
Channel : Mid - 5260MHz

Power Drift-Start : 0.058 W/kg
Power Drift-Finish: 0.057 W/kg
Power Drift (%) : -2.435

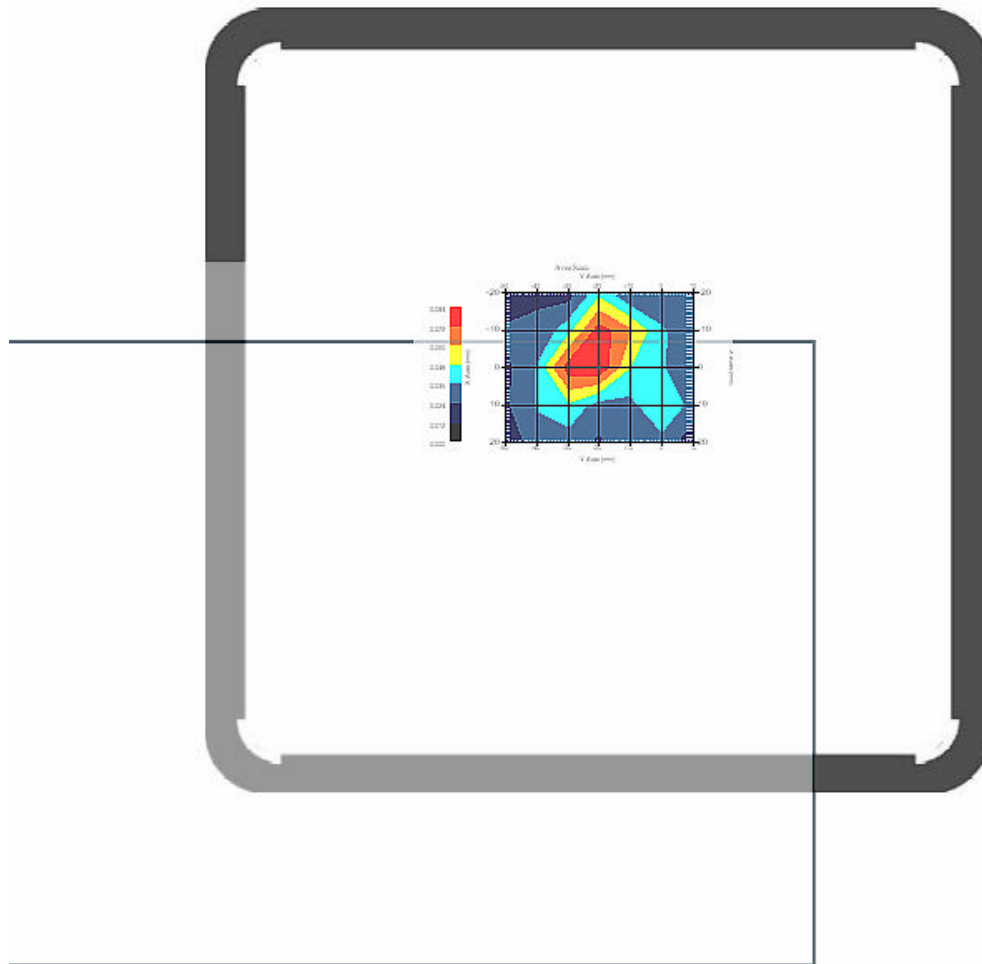

1 gram SAR value : 0.101 W/kg
10 gram SAR value : 0.062 W/kg
Area Scan Peak SAR : 0.092 W/kg
Zoom Scan Peak SAR : 0.189 W/kg

Area Scan Plot

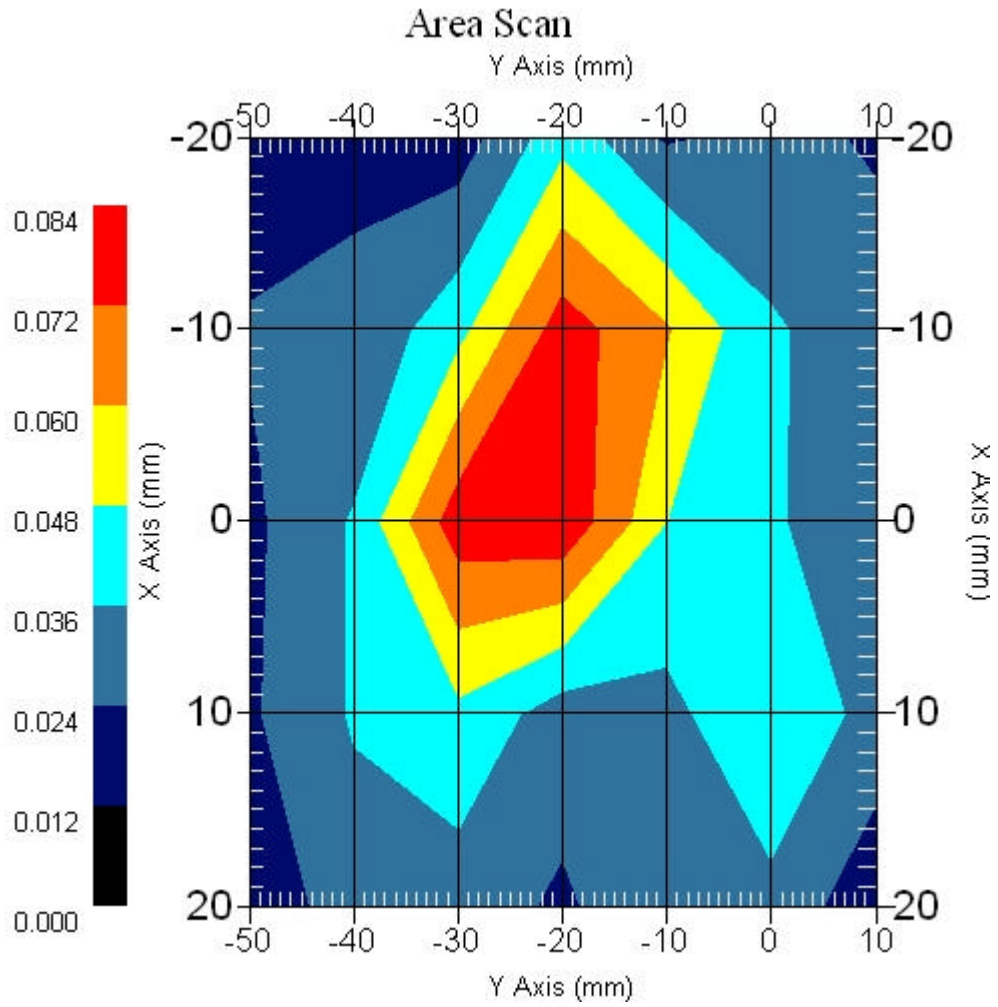

3.4 5200 MHz 802.11a Main Ant. , EUT Position: Back

Measurement Date : 29-Jan-2007
Crest Factor : 1
Area Scan : 5x7x1 : Measurement x=10mm, y=10mm, z=4mm
Zoom Scan : 9x9x13 : Measurement x=4mm, y=4mm, z=2.5mm

DUT Position : Touch
Channel : High - 5320MHz

Power Drift-Start : 0.082 W/kg
Power Drift-Finish: 0.084 W/kg
Power Drift (%) : 2.441

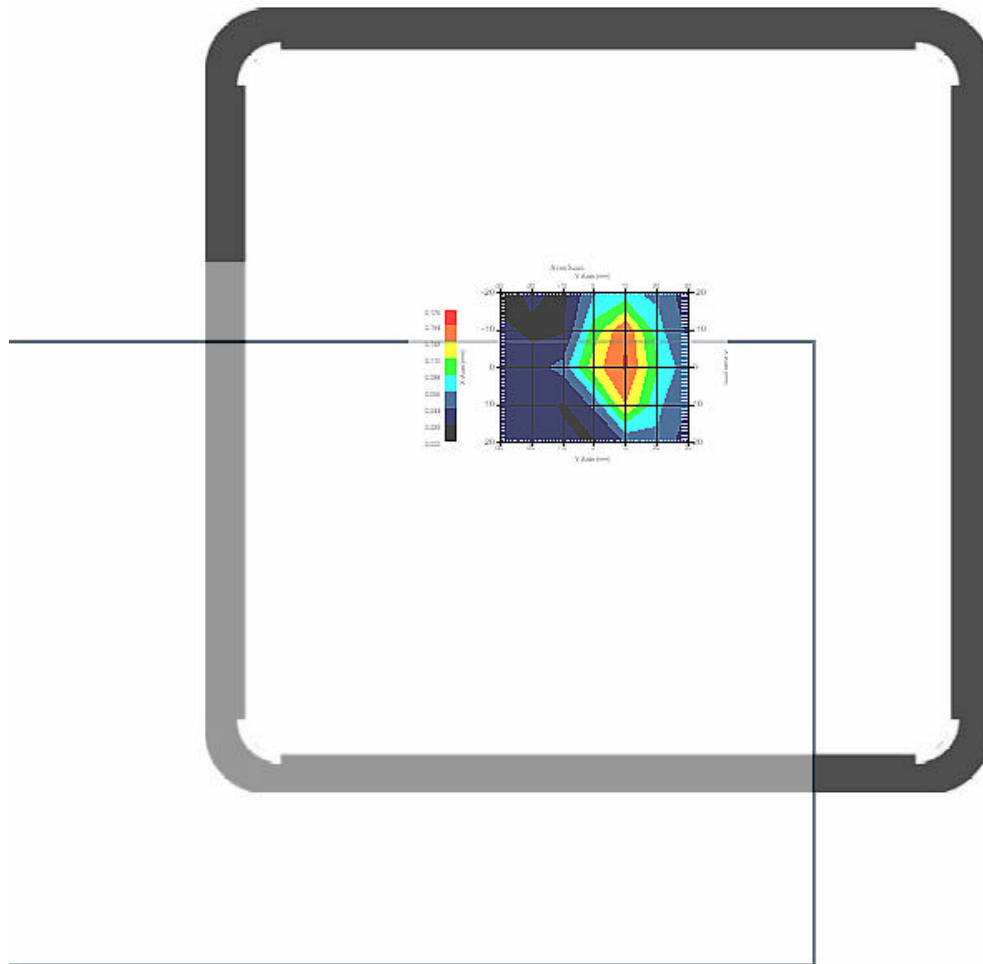

1 gram SAR value : 0.142 W/kg
10 gram SAR value : 0.081 W/kg
Area Scan Peak SAR : 0.156 W/kg
Zoom Scan Peak SAR : 0.340 W/kg

Area Scan Plot

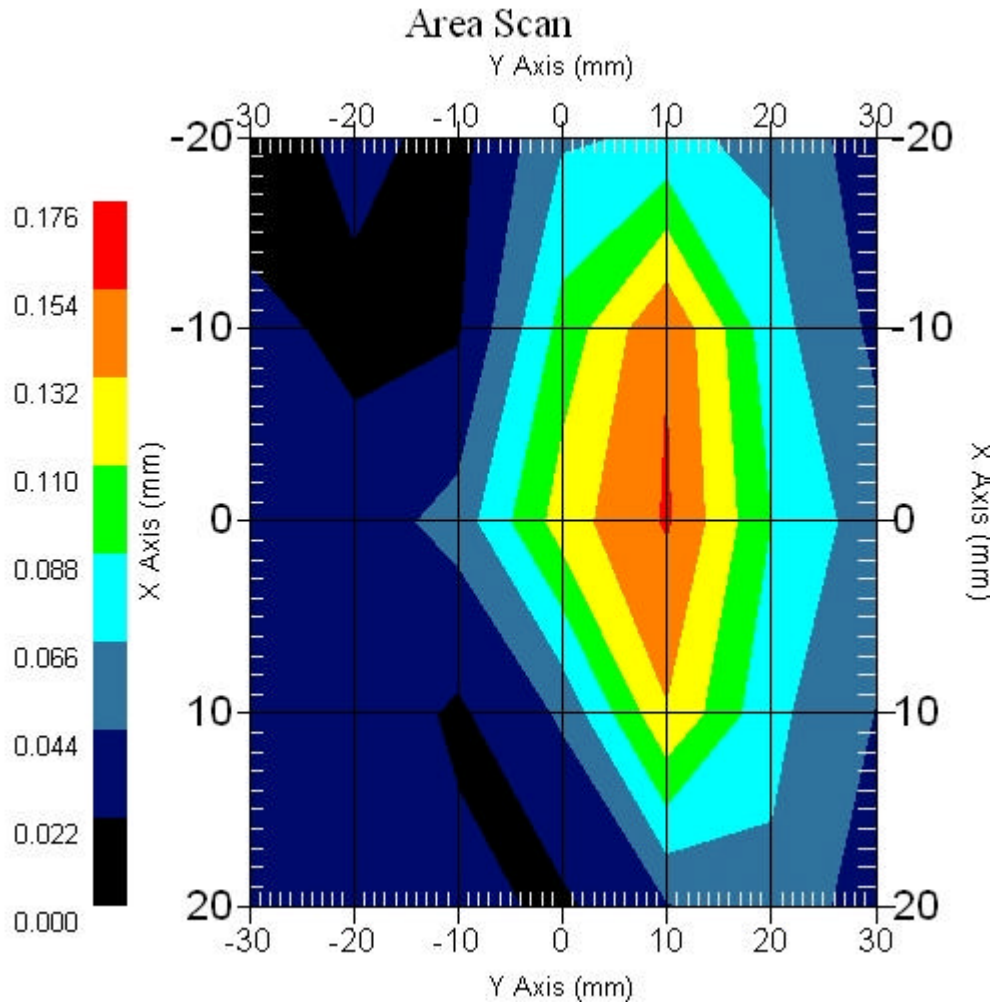

3.5 5200 MHz 802.11a Main Ant. , EUT Position: Top

Measurement Date : 29-Jan-2007
Crest Factor : 1
Area Scan : 5x7x1 : Measurement x=10mm, y=10mm, z=4mm
Zoom Scan : 9x9x13 : Measurement x=4mm, y=4mm, z=2.5mm

DUT Position : Touch
Channel : Mid - 5240MHz

Power Drift-Start : 0.076 W/kg
Power Drift-Finish: 0.073 W/kg
Power Drift (%) : -3.949

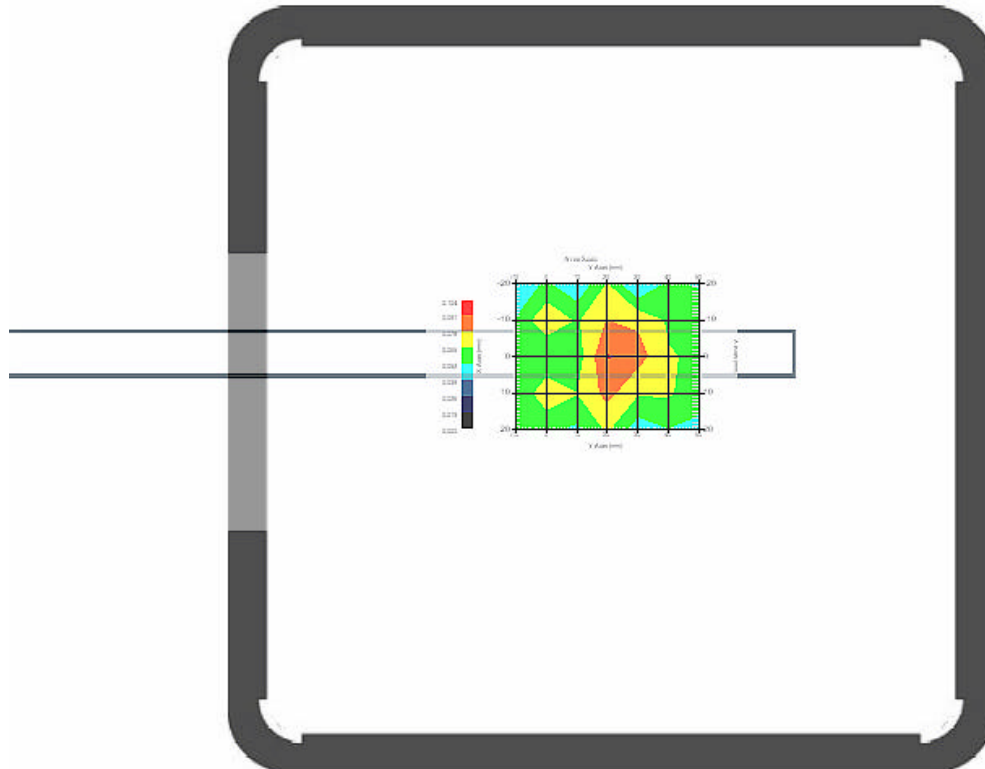

1 gram SAR value : 0.080 W/kg
10 gram SAR value : 0.063 W/kg
Area Scan Peak SAR : 0.092 W/kg
Zoom Scan Peak SAR : 0.160 W/kg

Area Scan Plot

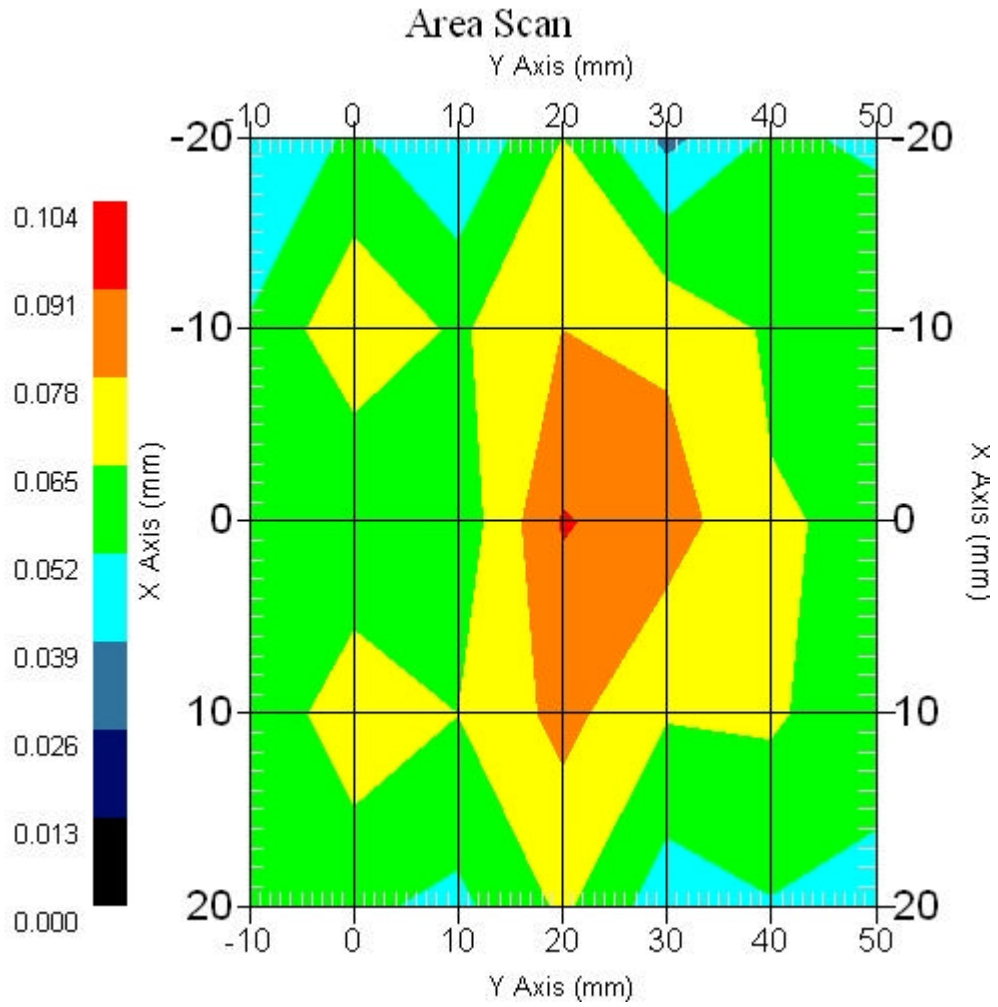

3.6 5200 MHz 802.11a Main Ant. , EUT Position: Top

Measurement Date : 29-Jan-2007
Crest Factor : 1
Area Scan : 5x7x1 : Measurement x=10mm, y=10mm, z=4mm
Zoom Scan : 9x9x13 : Measurement x=4mm, y=4mm, z=2.5mm

DUT Position : Touch
Channel : Mid - 5260MHz

Power Drift-Start : 0.030 W/kg
Power Drift-Finish: 0.031 W/kg
Power Drift (%) : 3.336

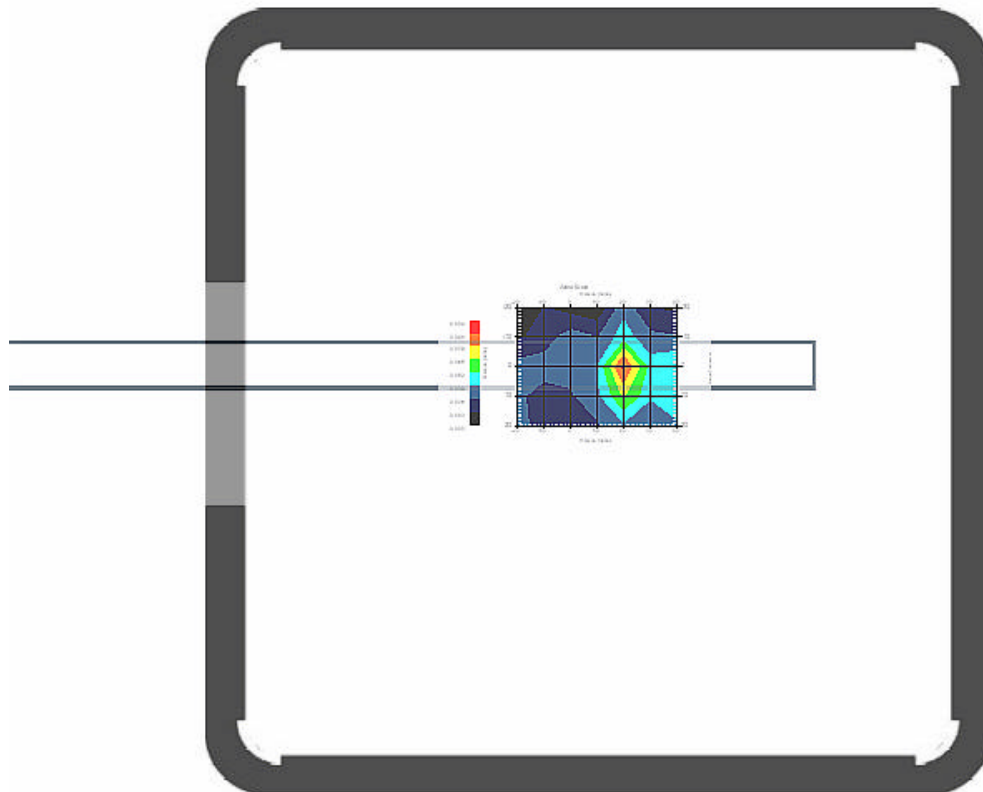

1 gram SAR value : 0.054 W/kg
10 gram SAR value : 0.045 W/kg
Area Scan Peak SAR : 0.094 W/kg
Zoom Scan Peak SAR : 0.132 W/kg

Area Scan Plot

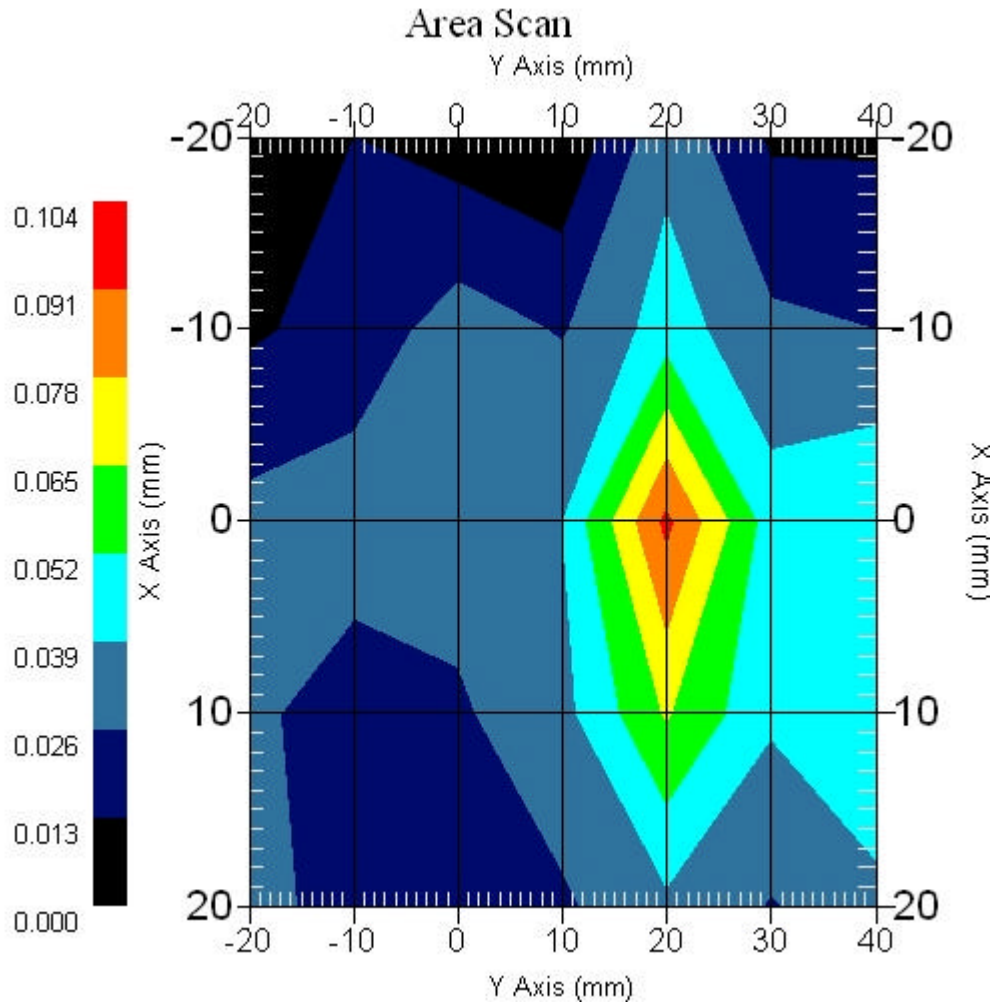

3.7 5200 MHz 802.11a Main Ant. , EUT Position: Front

Measurement Date : 29-Jan-2007
Crest Factor : 1
Area Scan : 5x7x1 : Measurement x=10mm, y=10mm, z=4mm
Zoom Scan : 9x9x13 : Measurement x=4mm, y=4mm, z=2.5mm
DUT Position : Touch
Channel : Mid - 5240MHz
Power Drift-Start : 0.082 W/kg
Power Drift-Finish: 0.079 W/kg
Power Drift (%) : -3.658

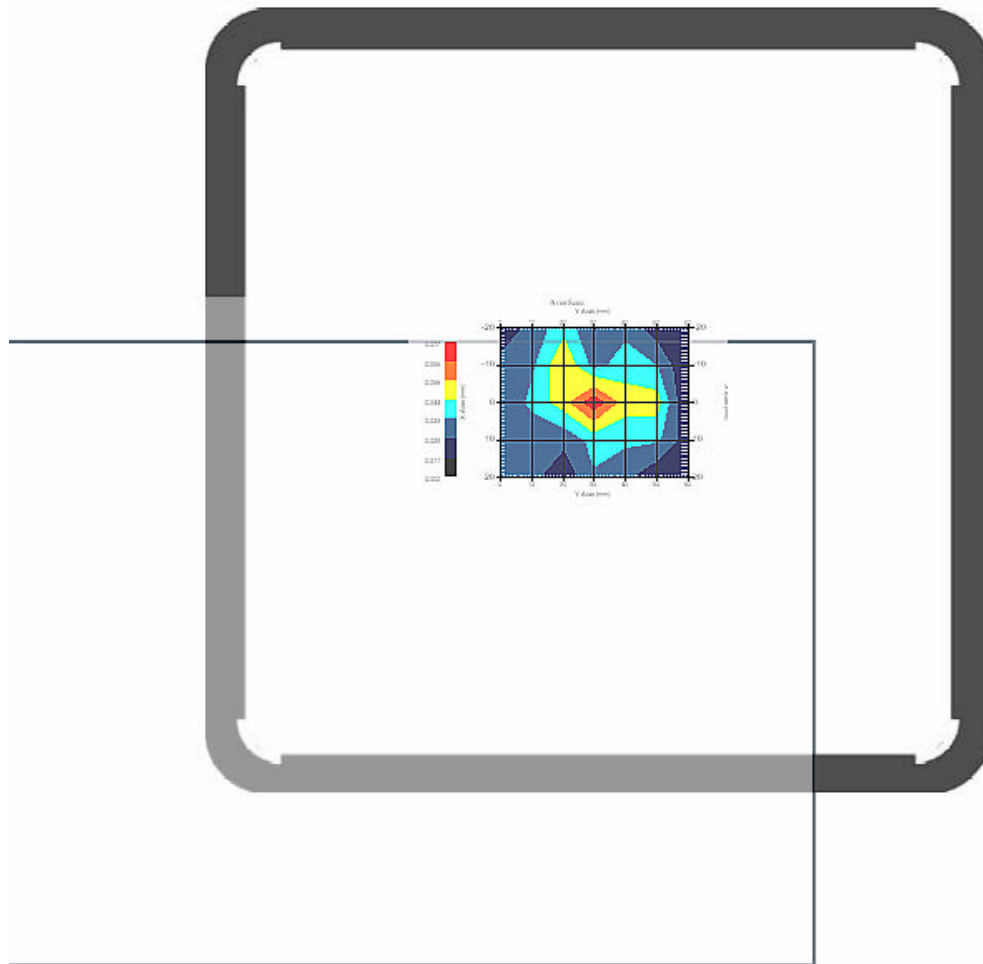

1 gram SAR value : 0.073 W/kg
10 gram SAR value : 0.042 W/kg
Area Scan Peak SAR : 0.074 W/kg
Zoom Scan Peak SAR : 0.170 W/kg

Area Scan Plot

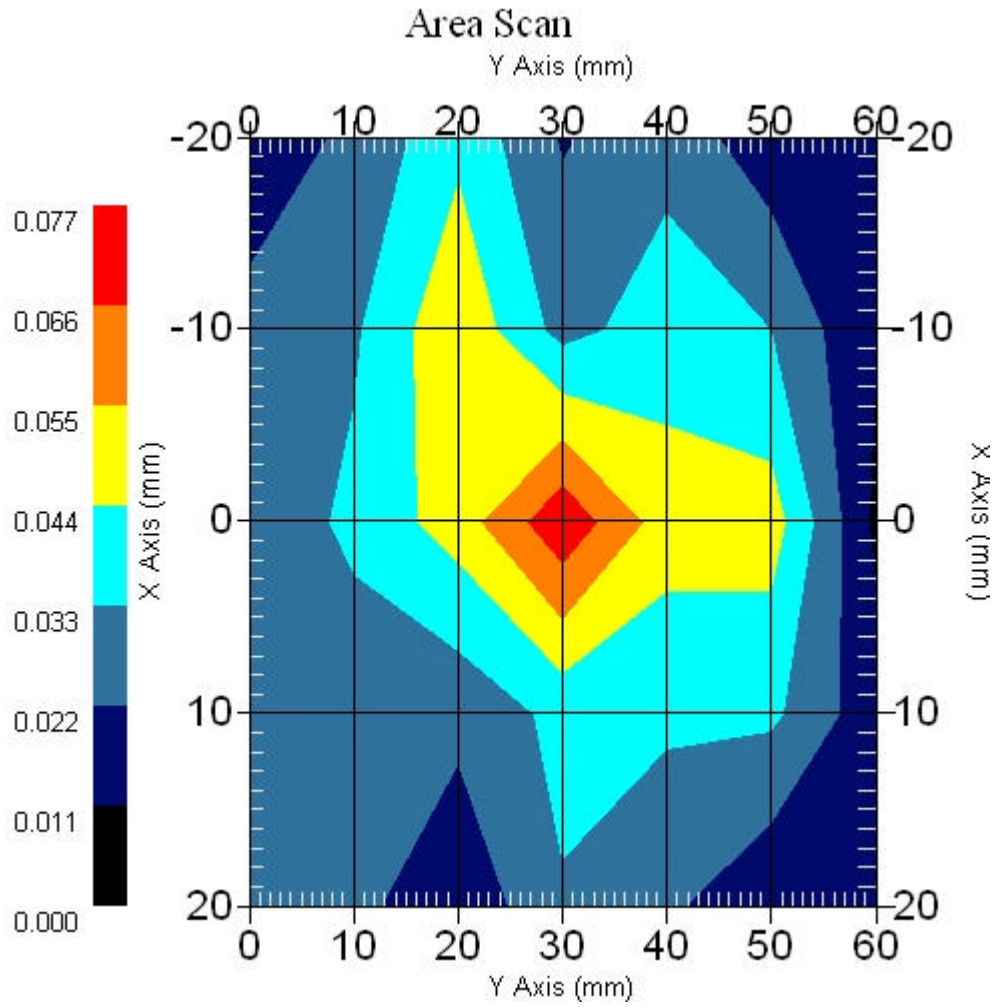

3.8 5200 MHz 802.11a Main Ant. , EUT Position: Front

Measurement Date : 29-Jan-2007
Crest Factor : 1
Area Scan : 5x7x1 : Measurement x=10mm, y=10mm, z=4mm
Zoom Scan : 9x9x13 : Measurement x=4mm, y=4mm, z=2.5mm

DUT Position : Touch
Channel : Mid - 5260MHz

Power Drift-Start : 0.052 W/kg
Power Drift-Finish: 0.051 W/kg
Power Drift (%) : -1.925

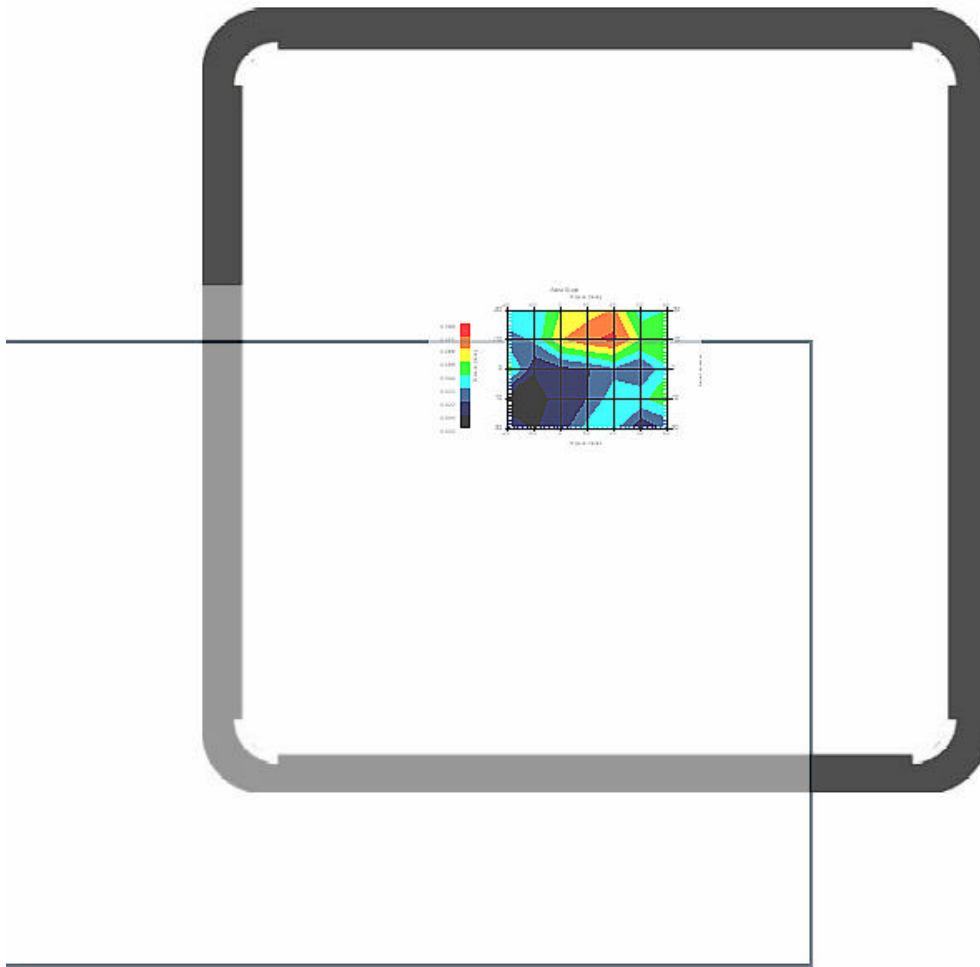

1 gram SAR value : 0.064 W/kg
10 gram SAR value : 0.040 W/kg
Area Scan Peak SAR : 0.080 W/kg
Zoom Scan Peak SAR : 0.150 W/kg

Area Scan Plot

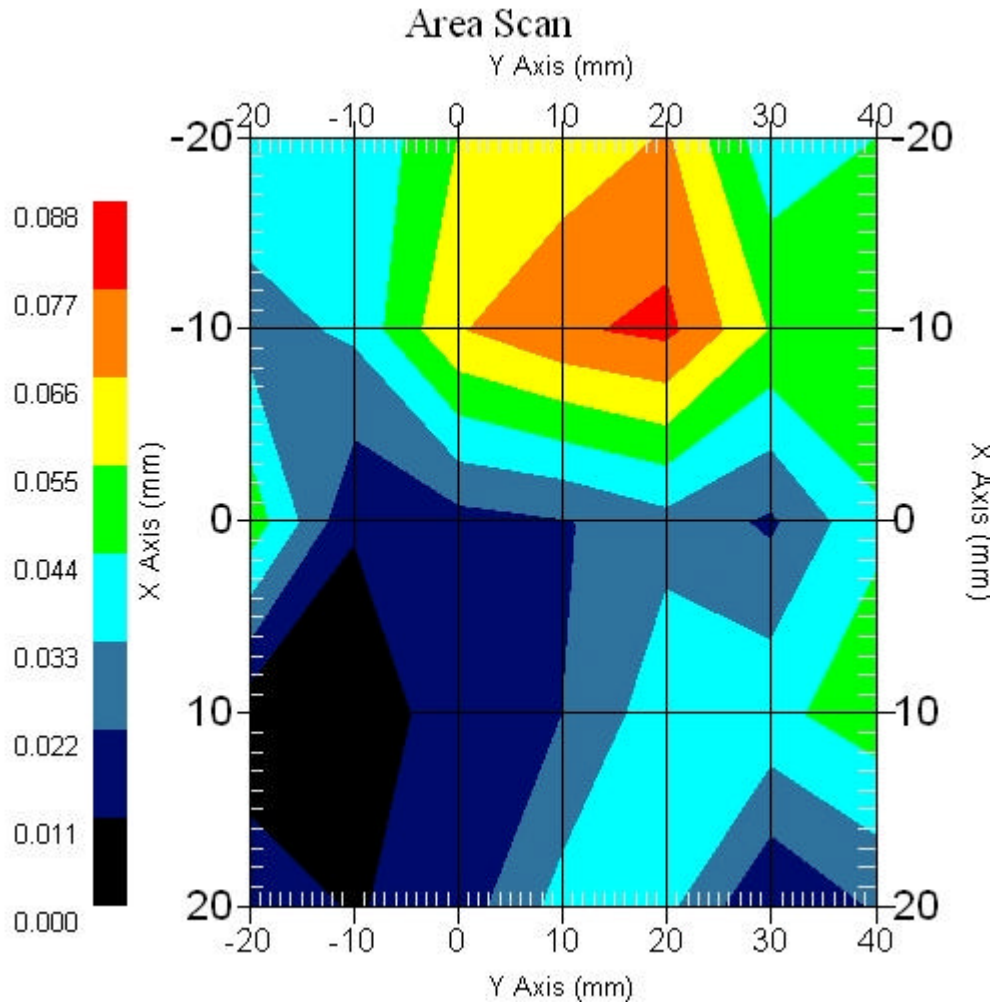

3.9 5200 MHz 802.11a Aux. Ant. , EUT Position: Back

Measurement Date : 29-Jan-2007
Crest Factor : 1
Area Scan : 5x7x1 : Measurement x=10mm, y=10mm, z=4mm
Zoom Scan : 9x9x13 : Measurement x=4mm, y=4mm, z=2.5mm

DUT Position : Touch
Channel : Mid - 5240MHz

Power Drift-Start : 0.063 W/kg
Power Drift-Finish: 0.061 W/kg
Power Drift (%) : -3.178

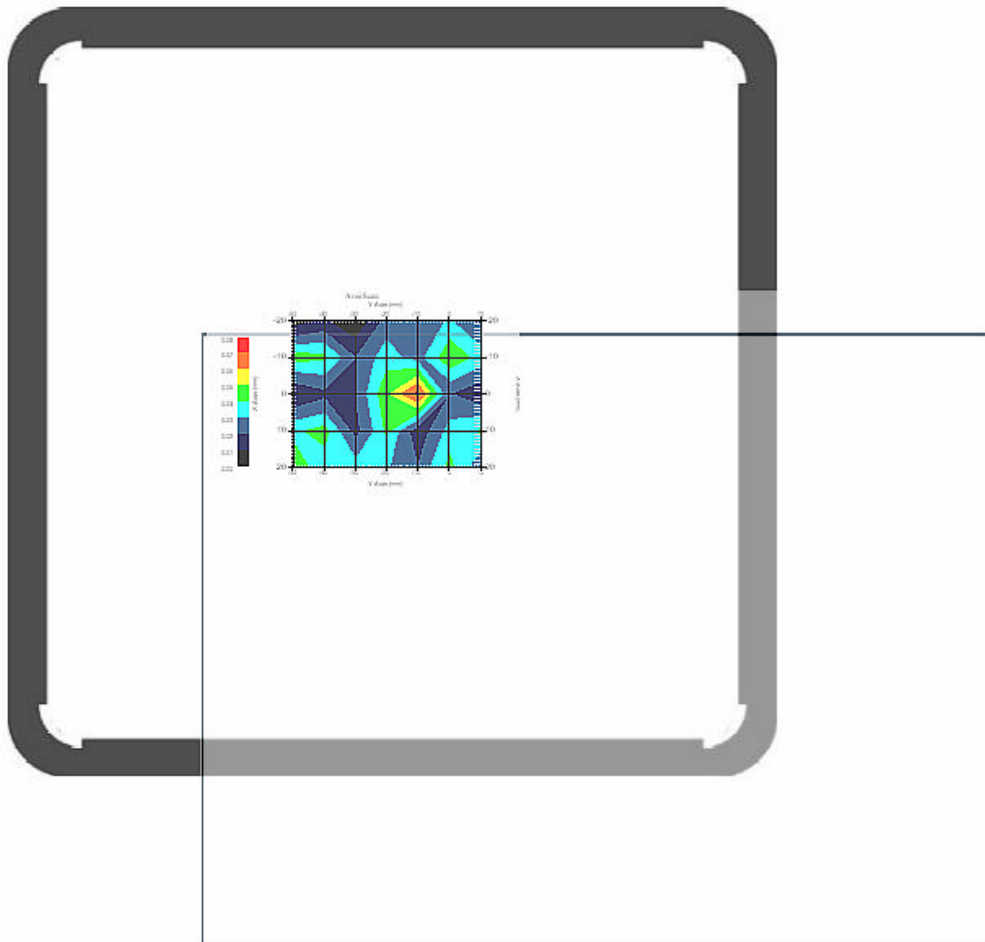

1 gram SAR value : 0.057 W/kg
10 gram SAR value : 0.020 W/kg
Area Scan Peak SAR : 0.073 W/kg
Zoom Scan Peak SAR : 0.132 W/kg

Area Scan Plot

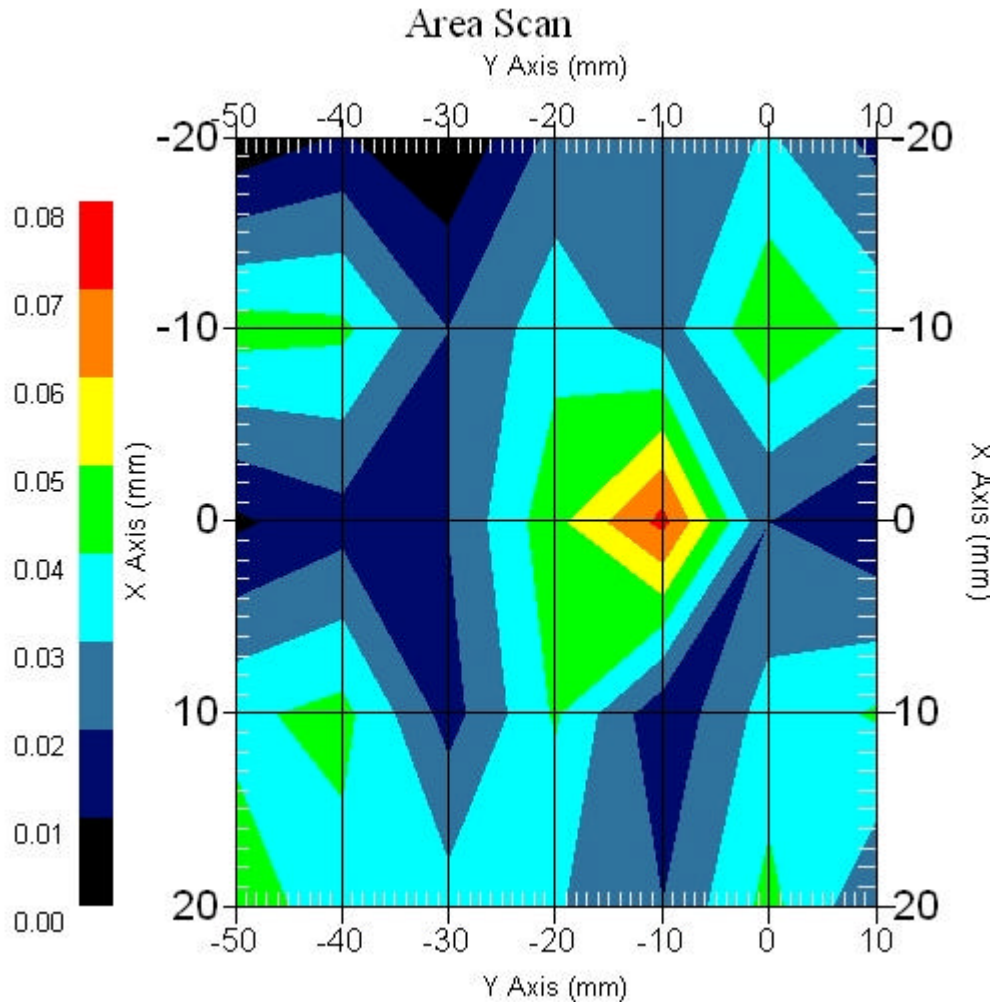

3.10 5200 MHz 802.11a Main Ant. , EUT Position: Back

Measurement Date : 29-Jan-2007
Crest Factor : 1
Area Scan : 5x7x1 : Measurement x=10mm, y=10mm, z=4mm
Zoom Scan : 9x9x13 : Measurement x=4mm, y=4mm, z=2.5mm

DUT Position : Touch
Channel : Mid - 5260MHz

Power Drift-Start : 0.058 W/kg
Power Drift-Finish: 0.056 W/kg
Power Drift (%) : -3.449

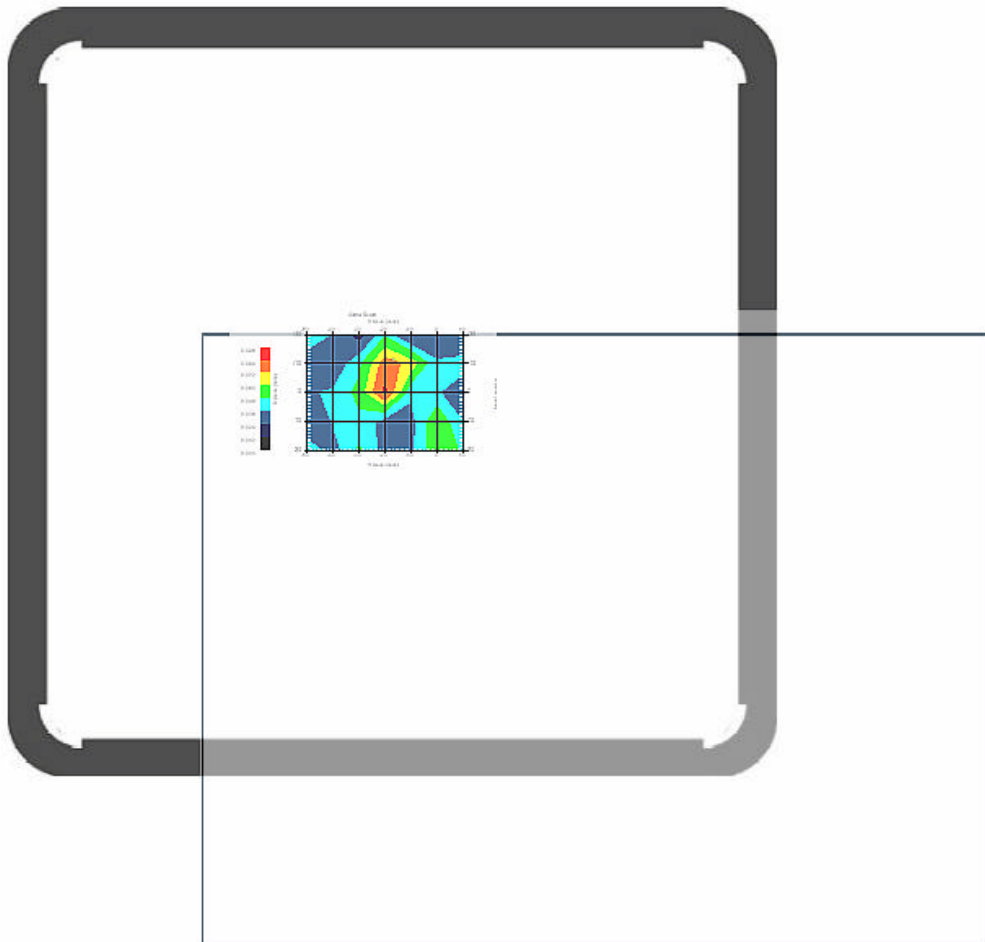

1 gram SAR value : 0.096 W/kg
10 gram SAR value : 0.050 W/kg
Area Scan Peak SAR : 0.087 W/kg
Zoom Scan Peak SAR : 0.180 W/kg

Area Scan Plot

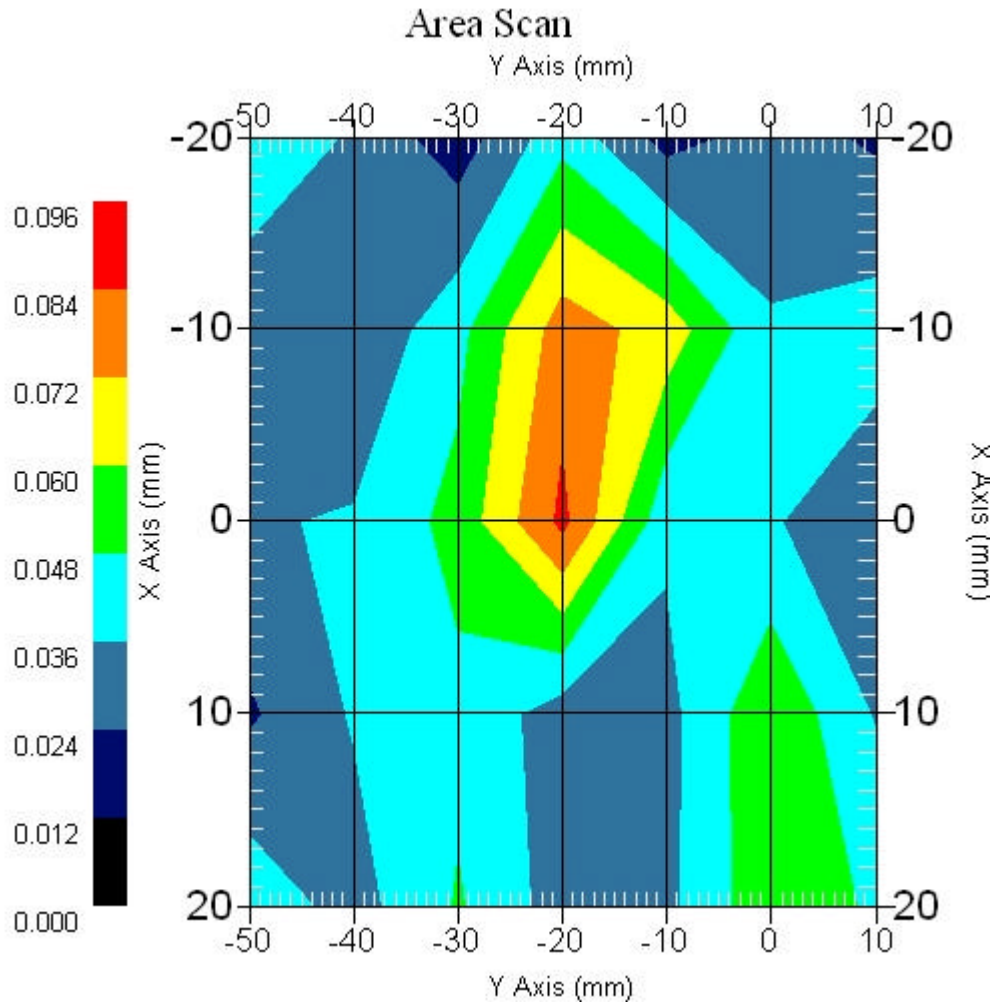

3.11 Z-Axis plot

Frequency: 5200 MHz 802.11a Main Ant. , EUT Position: Back

SAR-Z Axis
at Hotspot x:-13.60 y:19.80

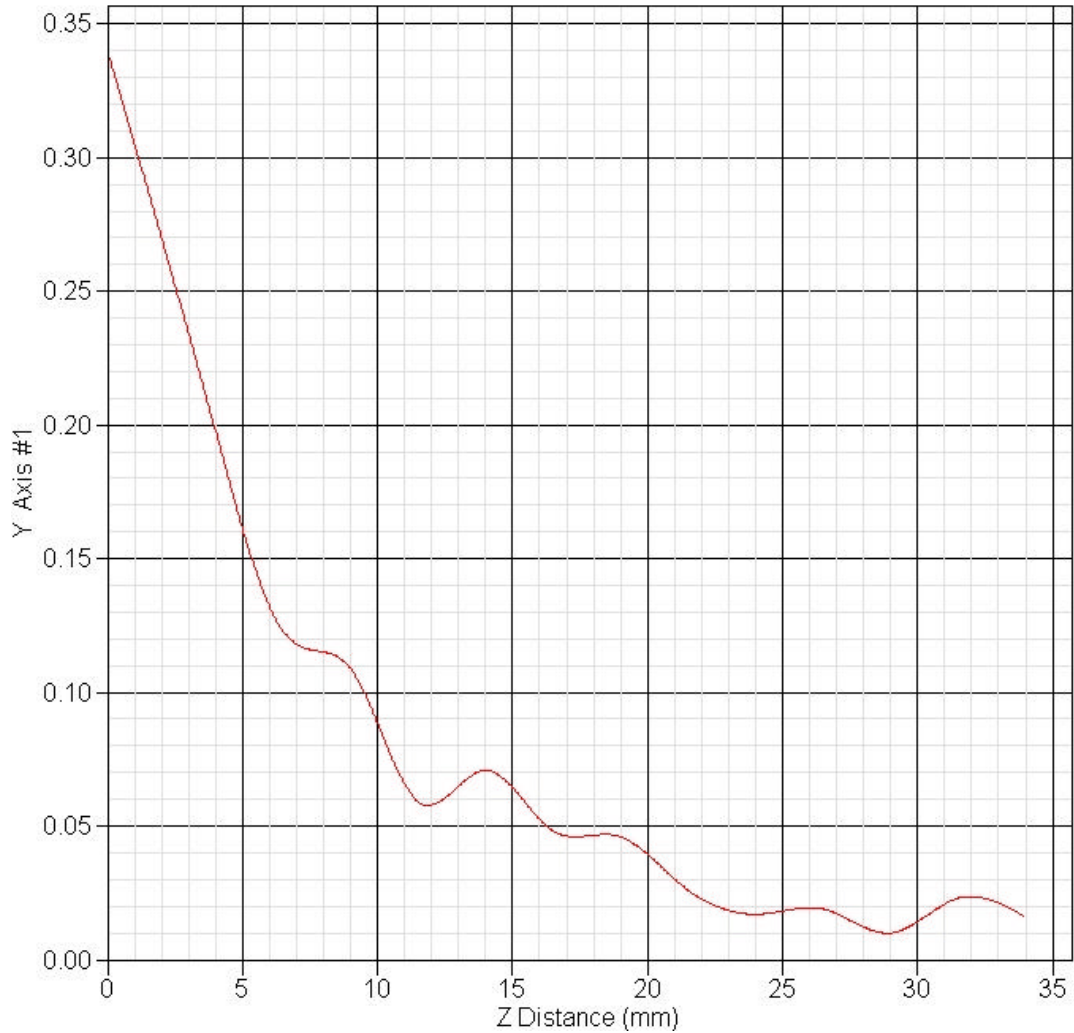



4 SAR measurement Data

SAR Test Report

Report Date : 29-Jan-2007
Measurement Date : 29-Jan-2007

Product Data

Device Name : V100
Serial No. : 11.a-Back
Type : Other
Frequency : 5800.00 MHz
Drift Time : 0 min(s)
Length : 225 mm
Width : 290 mm
Depth : 5 mm
Antenna Type : Internal

Phantom Data

Name : APREL-Uni
Type : Uni-Phantom
Size (mm) : 280 x 280 x 200
Location : Center

Tissue Data

Type : BODY
Serial No. : 5800-B-AU-19
Frequency : 5800.00 MHz
Last Calib. Date : 29-Jan-2007
Temperature : 22.00 °C
Ambient Temp. : 22.30 °C
Humidity : 45.00 RH%
Epsilon : 47.550 F/m
Sigma : 5.880 S/m
Density : 1000.00 kg/cu. m

Probe Data

Name : E-field Probe
Model : ALS-E-020
Type : E-Field Triangle
Serial No. : 266
Last Calib. Date : 22-Jun-2006
Frequency : 5800.00 MHz
Duty Cycle Factor: 1
Conversion Factor: 4.2
Probe Sensitivity: 1.20 1.20 1.20 $\mu\text{V}/(\text{V}/\text{m})^2$
Compression Point: 95.00 mV
Offset : 2.44 mm

4.1 5800 MHz 802.11a Main Ant. , EUT Position: Back

Measurement Date : 29-Jan-2007
Crest Factor : 1
Area Scan : 5x7x1 : Measurement x=10mm, y=10mm, z=4mm
Zoom Scan : 9x9x13 : Measurement x=4mm, y=4mm, z=2.5mm

DUT Position : Touch
Channel : Low - 5745MHz

Power Drift-Start : 0.088 W/kg
Power Drift-Finish: 0.086 W/kg
Power Drift (%) : -2.278

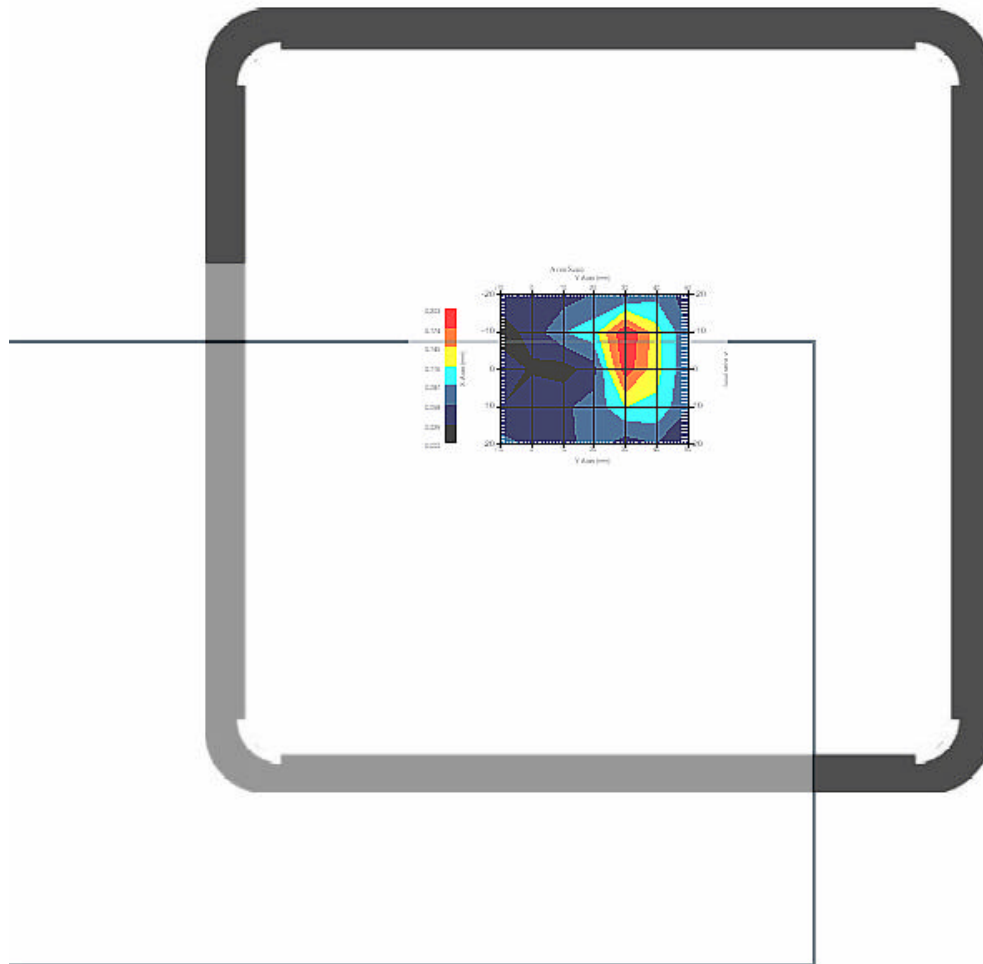

1 gram SAR value : 0.207 W/kg
10 gram SAR value : 0.110 W/kg
Area Scan Peak SAR : 0.200 W/kg
Zoom Scan Peak SAR : 0.530 W/kg

Area Scan Plot

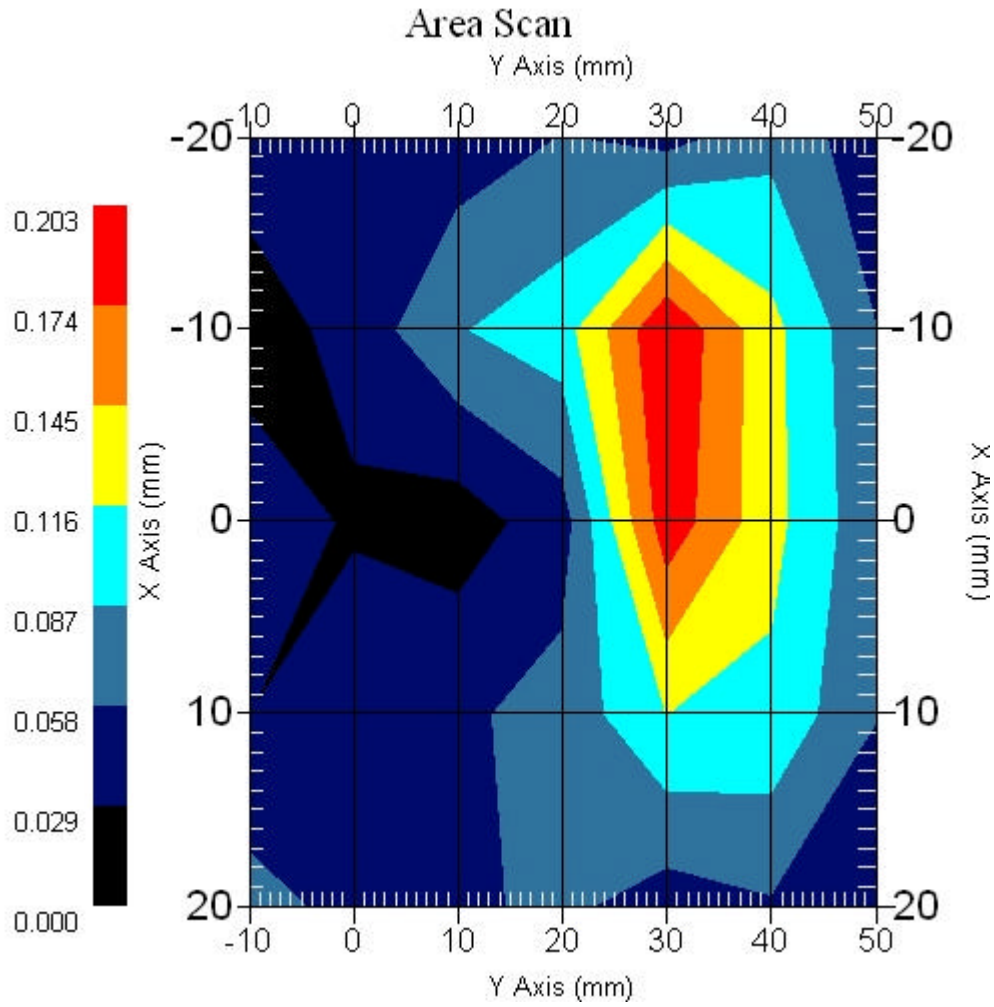

4.2 5800 MHz 802.11a Main Ant. , EUT Position: Back

Measurement Date : 29-Jan-2007
Crest Factor : 1
Area Scan : 4x7x1 : Measurement x=10mm, y=10mm, z=4mm
Zoom Scan : 9x9x13 : Measurement x=4mm, y=4mm, z=2.5mm

DUT Position : Touch
Channel : Mid - 5785MHz

Power Drift-Start : 0.054 W/kg
Power Drift-Finish: 0.055 W/kg
Power Drift (%) : 1.855

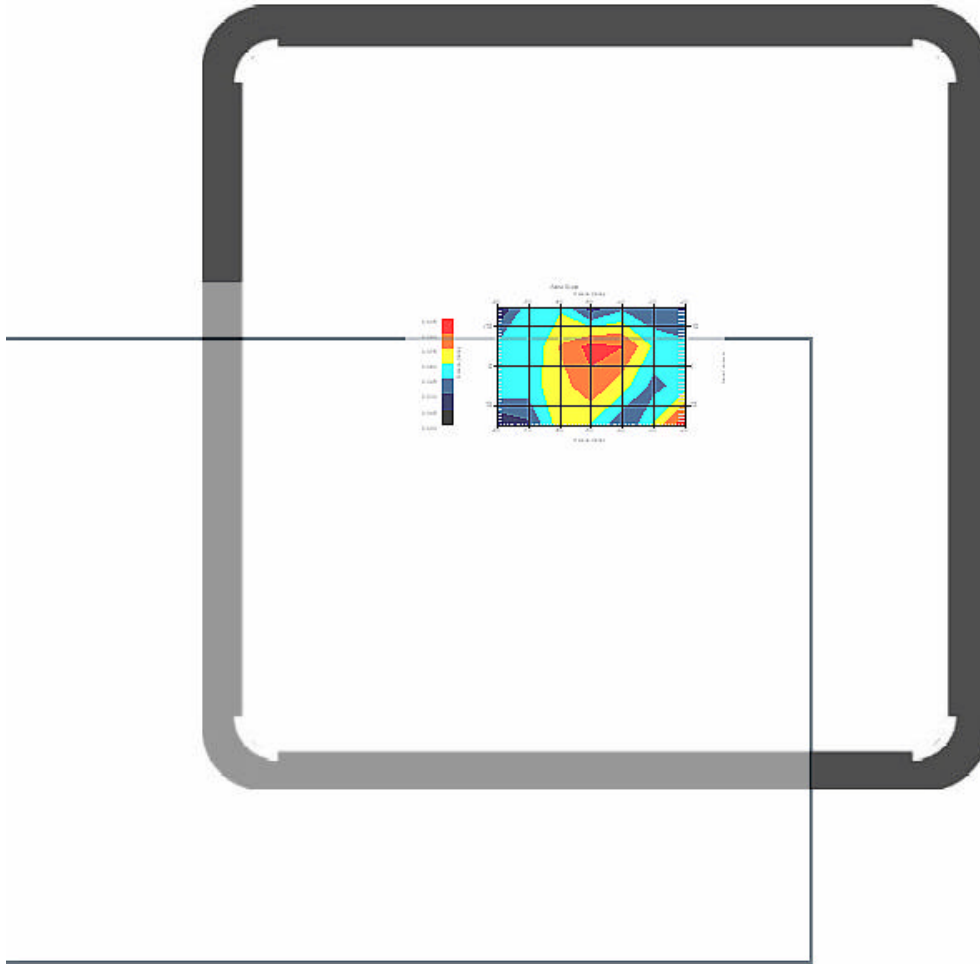

1 gram SAR value : 0.139 W/kg
10 gram SAR value : 0.088 W/kg
Area Scan Peak SAR : 0.105 W/kg
Zoom Scan Peak SAR : 0.321 W/kg

Area Scan Plot

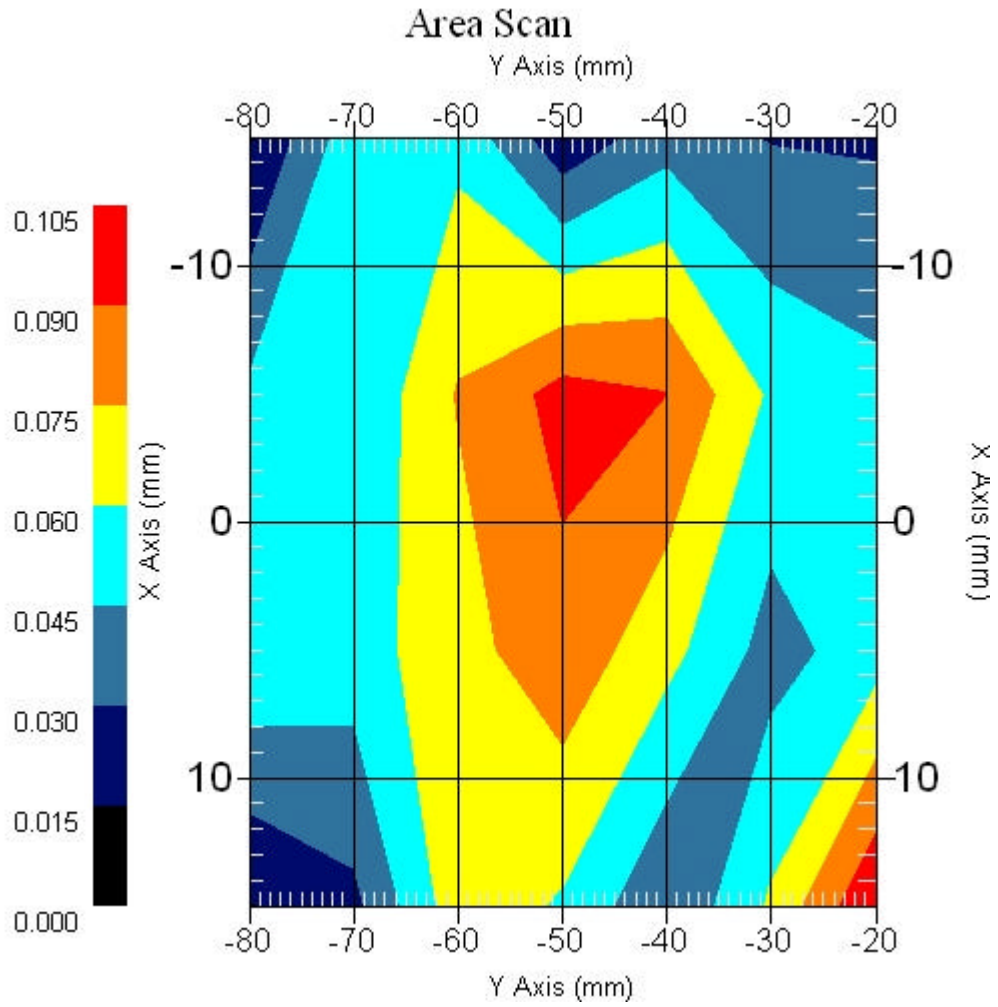

4.3 5800 MHz 802.11a Main Ant. , EUT Position: Back

Measurement Date : 29-Jan-2007
Crest Factor : 1
Area Scan : 5x7x1 : Measurement x=10mm, y=10mm, z=4mm
Zoom Scan : 9x9x13 : Measurement x=4mm, y=4mm, z=2.5mm

DUT Position : Touch
Channel : High - 5825MHz

Power Drift-Start : 0.077 W/kg
Power Drift-Finish: 0.078 W/kg
Power Drift (%) : 1.299

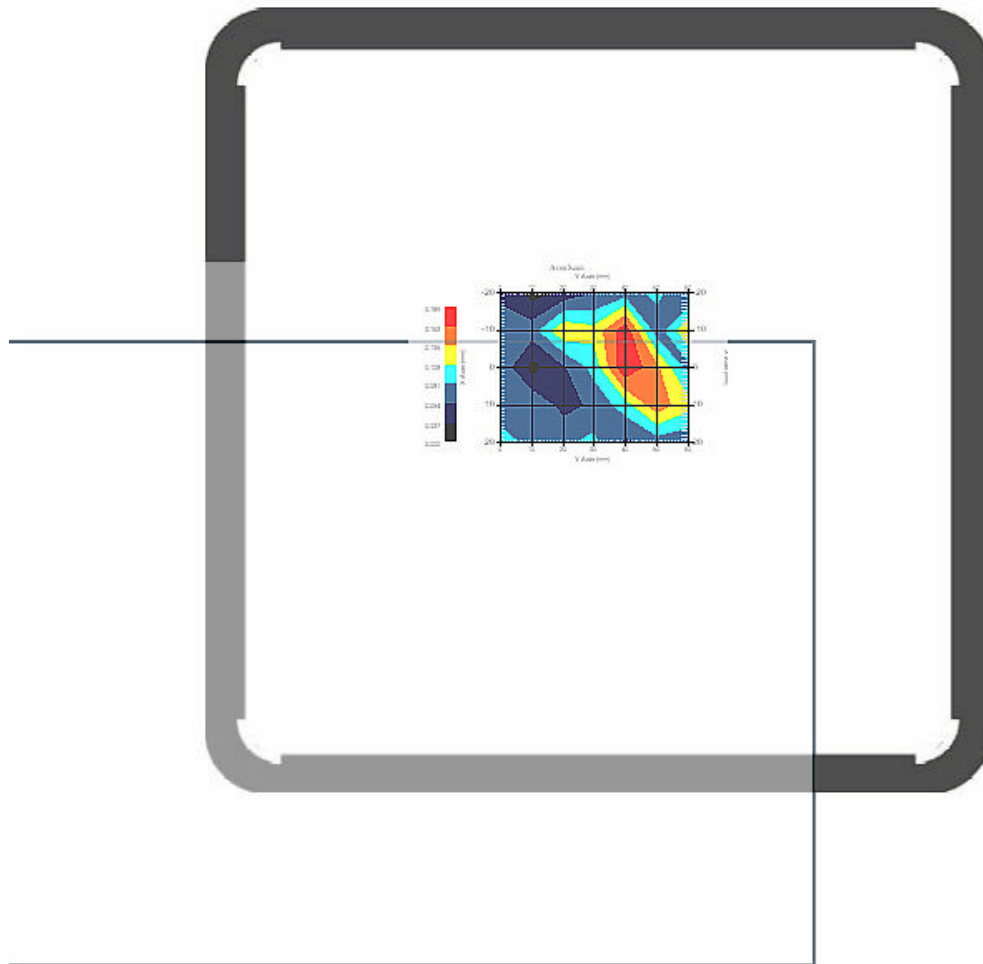

1 gram SAR value : 0.217 W/kg
10 gram SAR value : 0.133 W/kg
Area Scan Peak SAR : 0.202 W/kg
Zoom Scan Peak SAR : 0.520 W/kg

Area Scan Plot

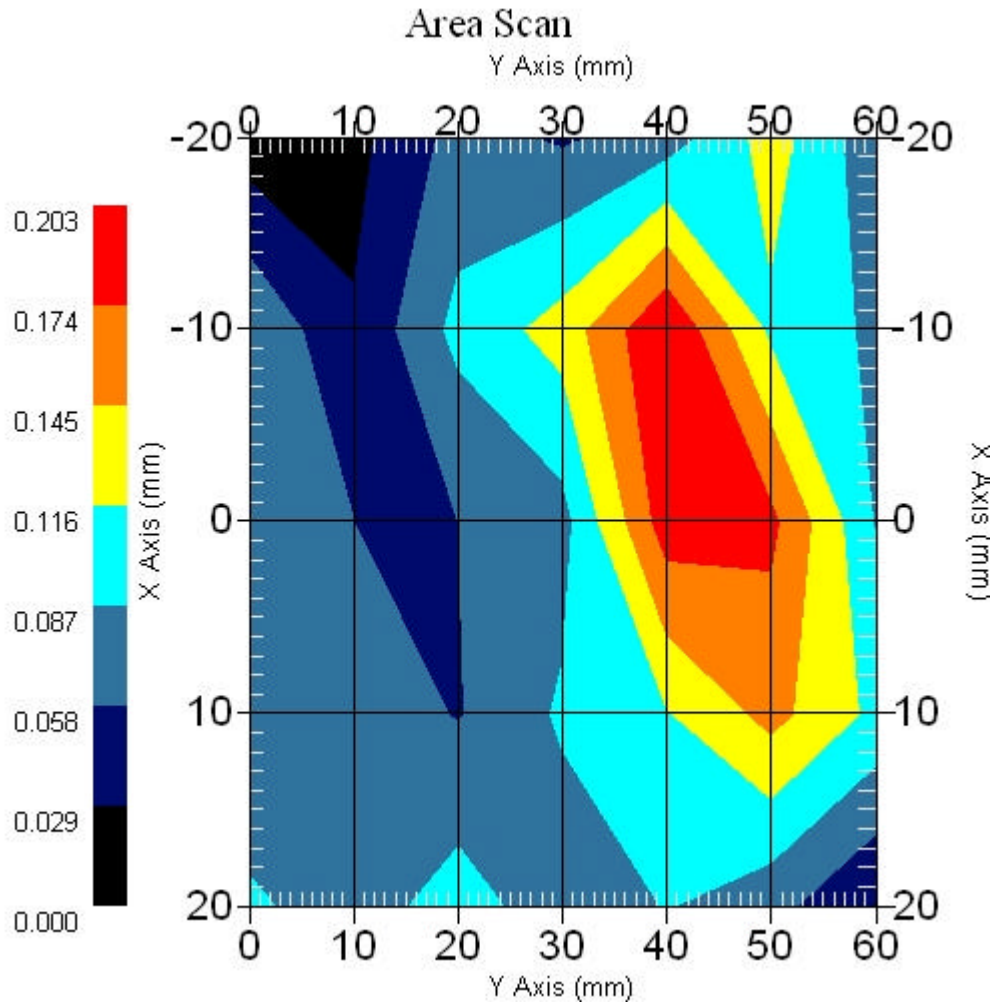

4.4 5800 MHz 802.11a Main Ant. , EUT Position: Top

Measurement Date : 29-Jan-2007
Crest Factor : 1
Area Scan : 5x7x1 : Measurement x=10mm, y=10mm, z=4mm
Zoom Scan : 9x9x13 : Measurement x=4mm, y=4mm, z=2.5mm

DUT Position : Touch
Channel : Mid - 5785MHz

Power Drift-Start : 0.077 W/kg
Power Drift-Finish: 0.076 W/kg
Power Drift (%) : -1.301

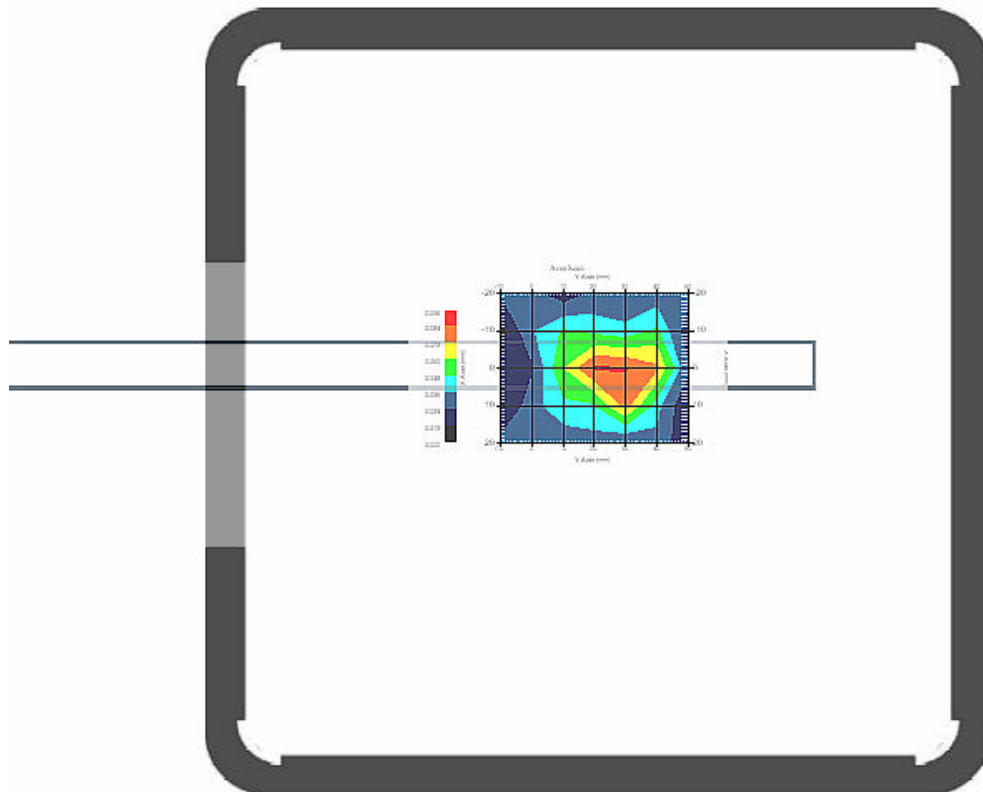

1 gram SAR value : 0.103 W/kg
10 gram SAR value : 0.040 W/kg
Area Scan Peak SAR : 0.085 W/kg
Zoom Scan Peak SAR : 0.160 W/kg

Area Scan Plot

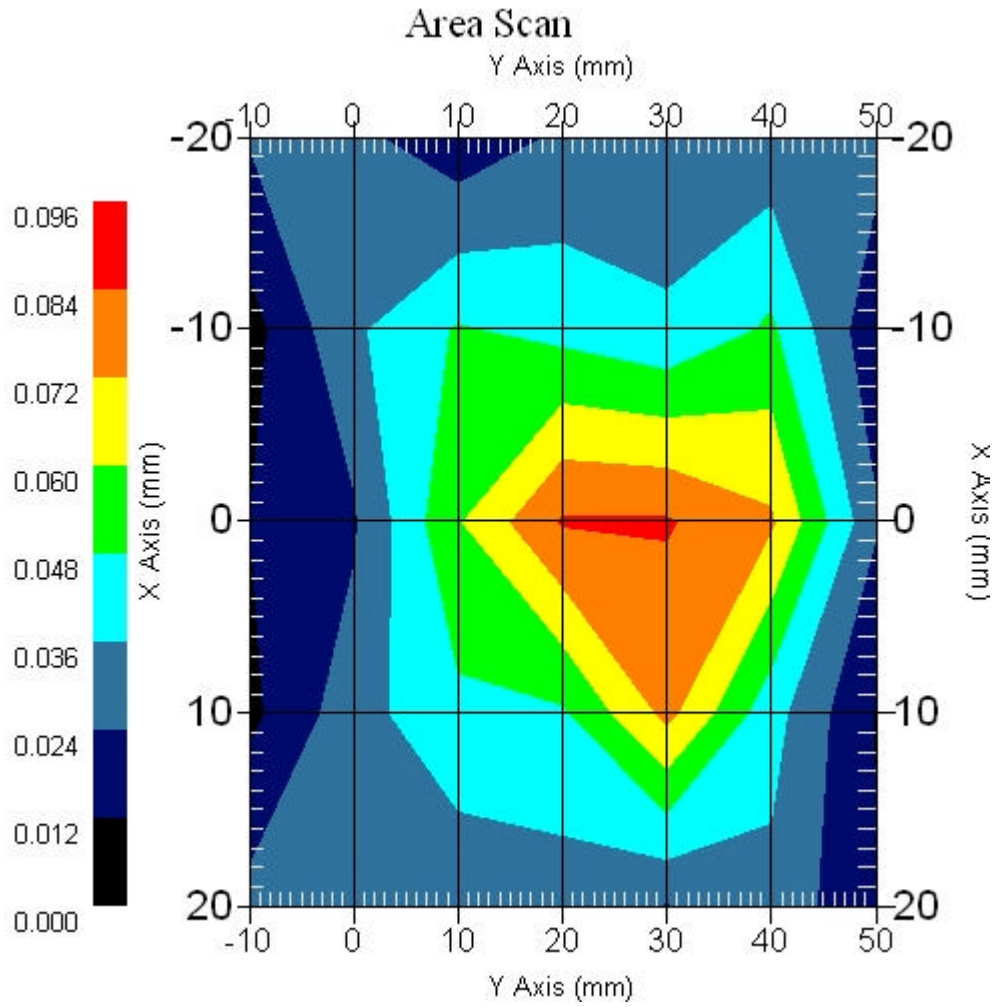

4.5 5800 MHz 802.11a Main Ant. , EUT Position: Front

Measurement Date : 29-Jan-2007
Crest Factor : 1
Area Scan : 5x7x1 : Measurement x=10mm, y=10mm, z=4mm
Zoom Scan : 9x9x13 : Measurement x=4mm, y=4mm, z=2.5mm

DUT Position : Touch
Channel : Mid - 5785MHz

Power Drift-Start : 0.053 W/kg
Power Drift-Finish: 0.051 W/kg
Power Drift (%) : -3.776

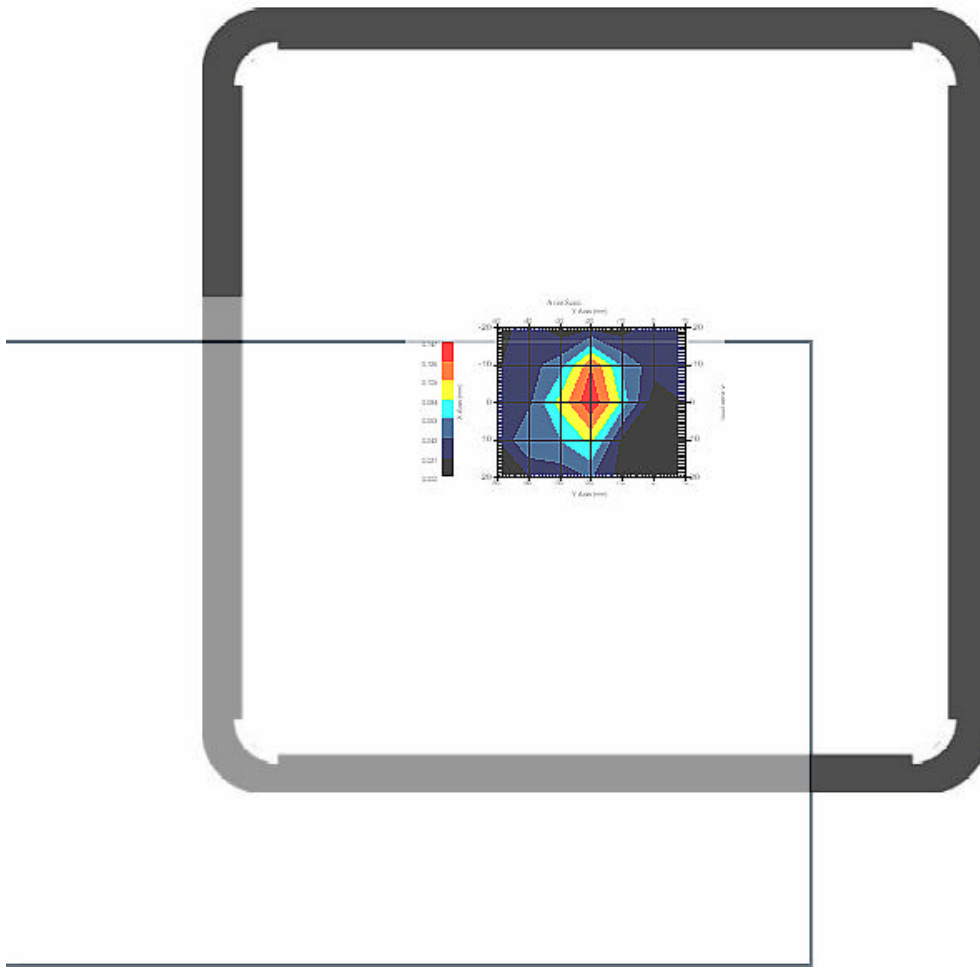

1 gram SAR value : 0.114 W/kg
10 gram SAR value : 0.072 W/kg
Area Scan Peak SAR : 0.144 W/kg
Zoom Scan Peak SAR : 0.256 W/kg

Area Scan Plot

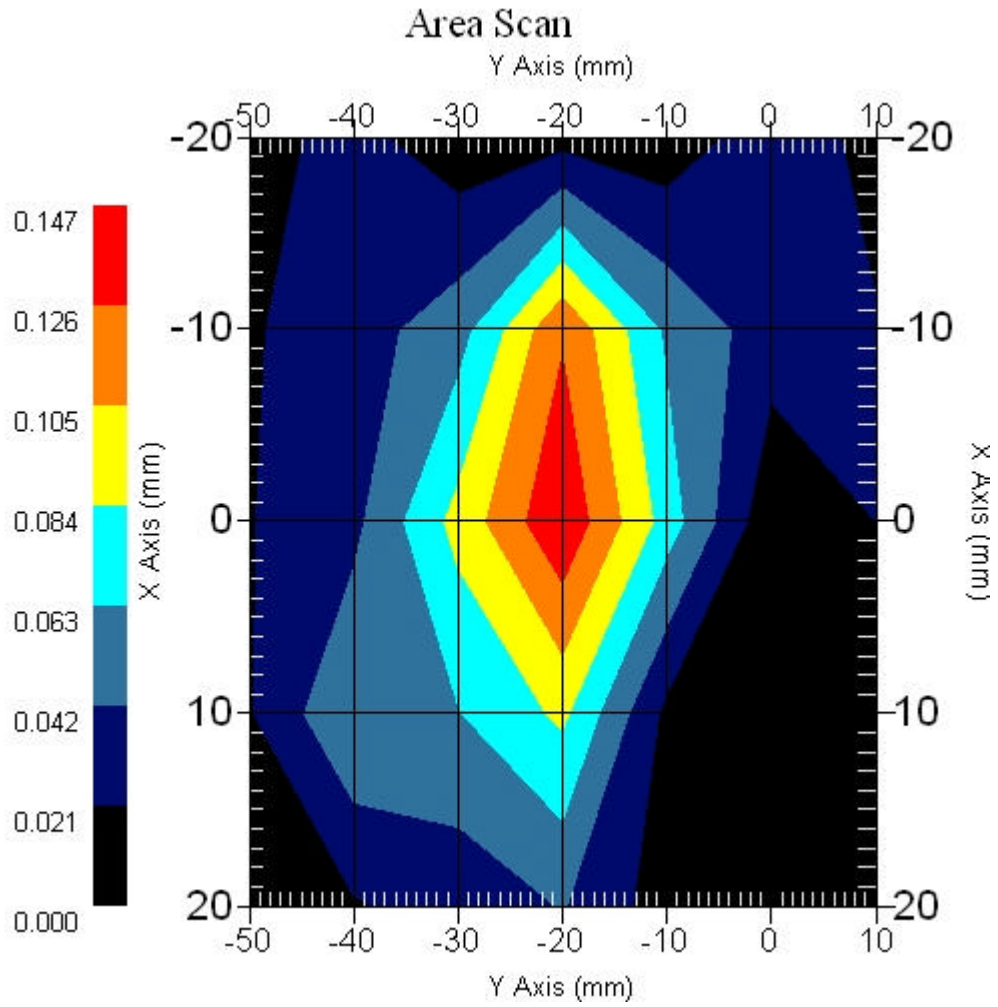

4.6 5800 MHz 802.11a Aux. Ant. , EUT Position: Back

Measurement Date : 29-Jan-2007
Crest Factor : 1
Area Scan : 5x7x1 : Measurement x=10mm, y=10mm, z=4mm
Zoom Scan : 9x9x13 : Measurement x=4mm, y=4mm, z=2.5mm

DUT Position : Touch
Channel : High - 5825MHz

Power Drift-Start : 0.094 W/kg
Power Drift-Finish: 0.096 W/kg
Power Drift (%) : 2.129

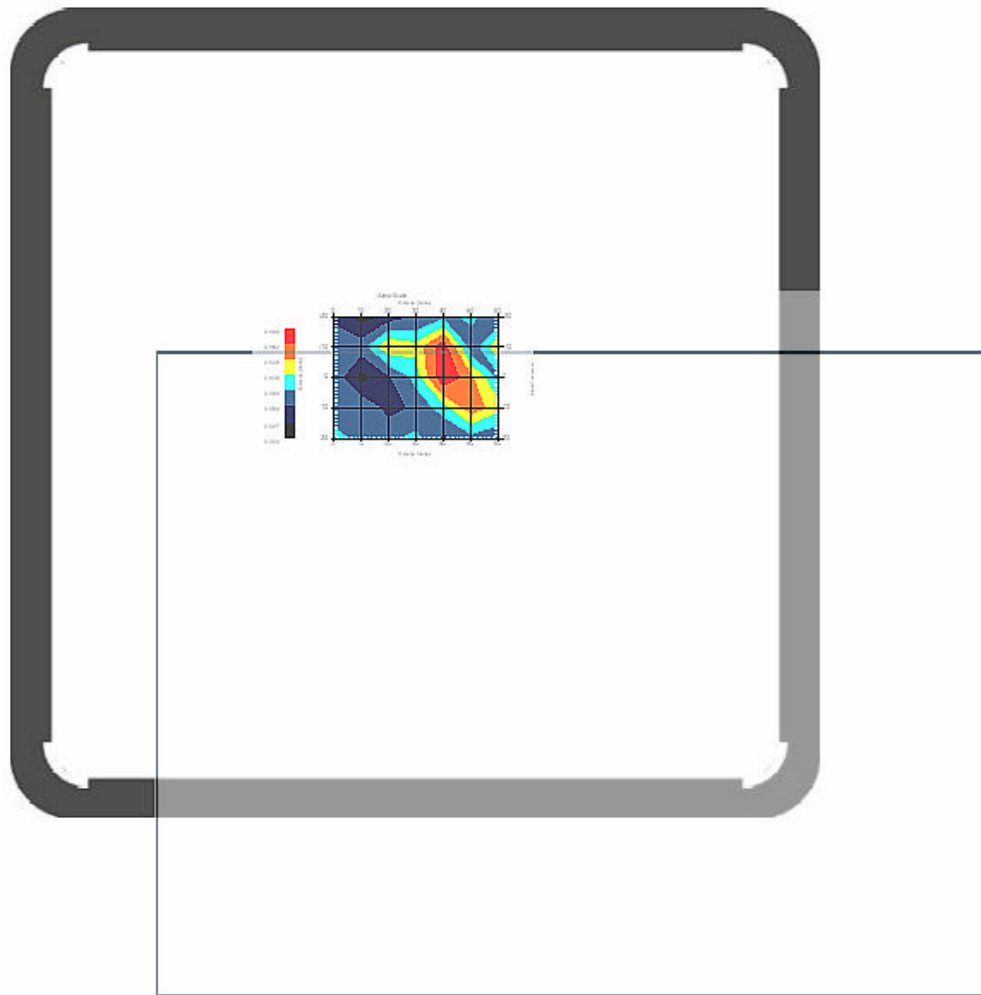

1 gram SAR value : 0.182 W/kg
10 gram SAR value : 0.115 W/kg
Area Scan Peak SAR : 0.188 W/kg
Zoom Scan Peak SAR : 0.430 W/kg

Area Scan Plot

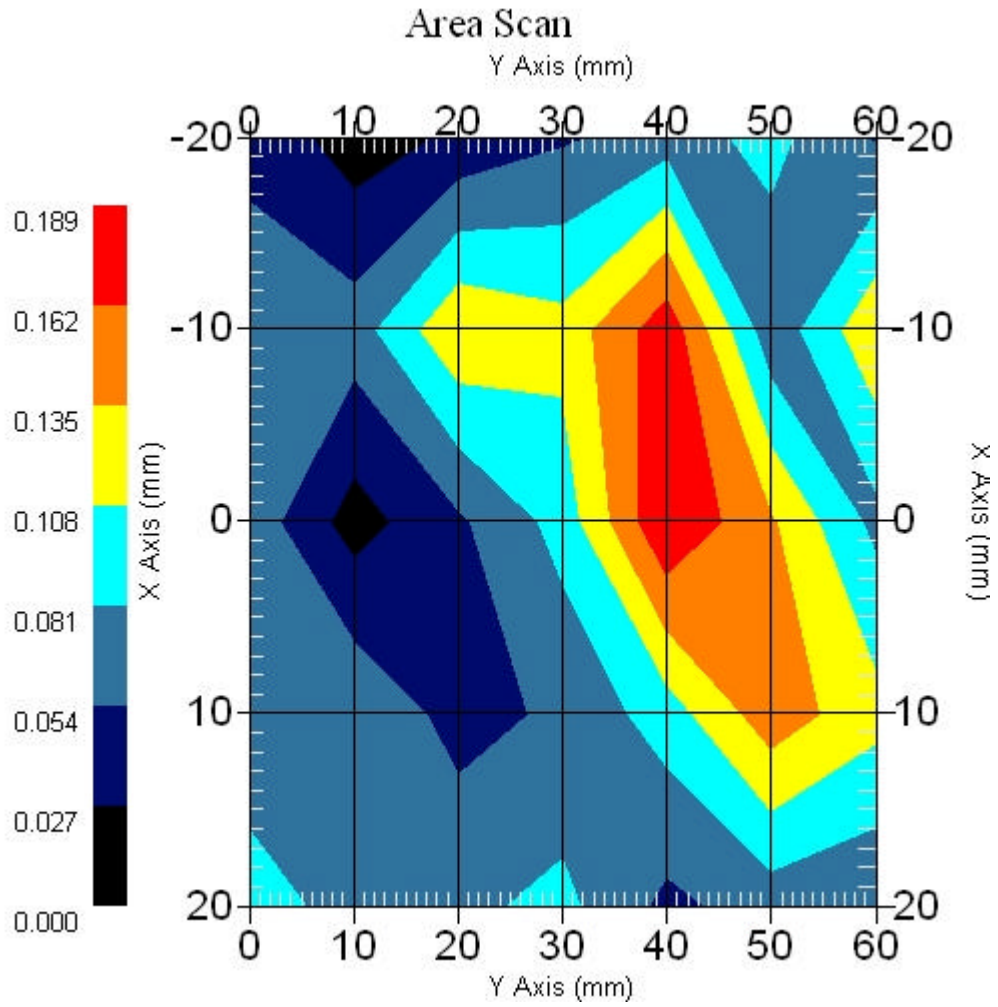

4.8 Z-Axis plot

Frequency: 5800 MHz 802.11a Main Ant. , EUT Position: Back

SAR-Z Axis
at Hotspot x:-1.70 y:43.80

