

# Appendix D

## SAR measurement Data

*of*

*Product Name*

**Notebook Personal Computer**

*Model*

**V100**

**(With WLAN & Bluetooth Module)**



## 1 SAR measurement Data

### SAR Test Report

Report Date : 25-Jan-2007  
Measurement Date : 25-Jan-2007

#### Product Data

Device Name : V100  
Serial No. : 11.b-Back  
Type : Other  
Frequency : 2450.00 MHz  
Max. Transmit Pwr : 0.028 W  
Drift Time : 0 min(s)  
Length : 225 mm  
Width : 290 mm  
Depth : 5 mm  
Antenna Type : Internal

#### Phantom Data

Name : APREL-Uni  
Type : Uni-Phantom  
Size (mm) : 280 x 280 x 200  
Location : Center

#### Tissue Data

Type : BODY  
Serial No. : 2450BODY  
Frequency : 2450.00 MHz  
Last Calib. Date : 25-Jan-2007  
Temperature : 21.60 °C  
Ambient Temp. : 21.80 °C  
Humidity : 43.00 RH%  
Epsilon : 51.28 F/m  
Sigma : 1.98 S/m  
Density : 1000.00 kg/cu. m

#### Probe Data

Name : E-field Probe  
Model : ALS-E-020  
Type : E-Field Triangle  
Serial No. : 266  
Last Calib. Date : 22-Jun-2006  
Frequency : 2450.00 MHz  
Duty Cycle Factor: 1  
Conversion Factor: 5.02  
Probe Sensitivity: 1.20 1.20 1.20  $\mu\text{V}/(\text{V}/\text{m})^2$   
Compression Point: 95.00 mV  
Offset : 2.44 mm

### 1.1 2450 MHz 802.11b Main Ant. , EUT Position: Back

Measurement Date : 25-Jan-2007  
Crest Factor : 1  
Area Scan : 5x8x1 : Measurement x=15mm, y=15mm, z=4mm  
Zoom Scan : 7x7x7 : Measurement x=5mm, y=5mm, z=5mm  
DUT Position : Touch  
Channel : Low - 2412MHz  
Power Drift-Start : 0.030 W/kg  
Power Drift-Finish: 0.029 W/kg  
Power Drift (%) : -3.169

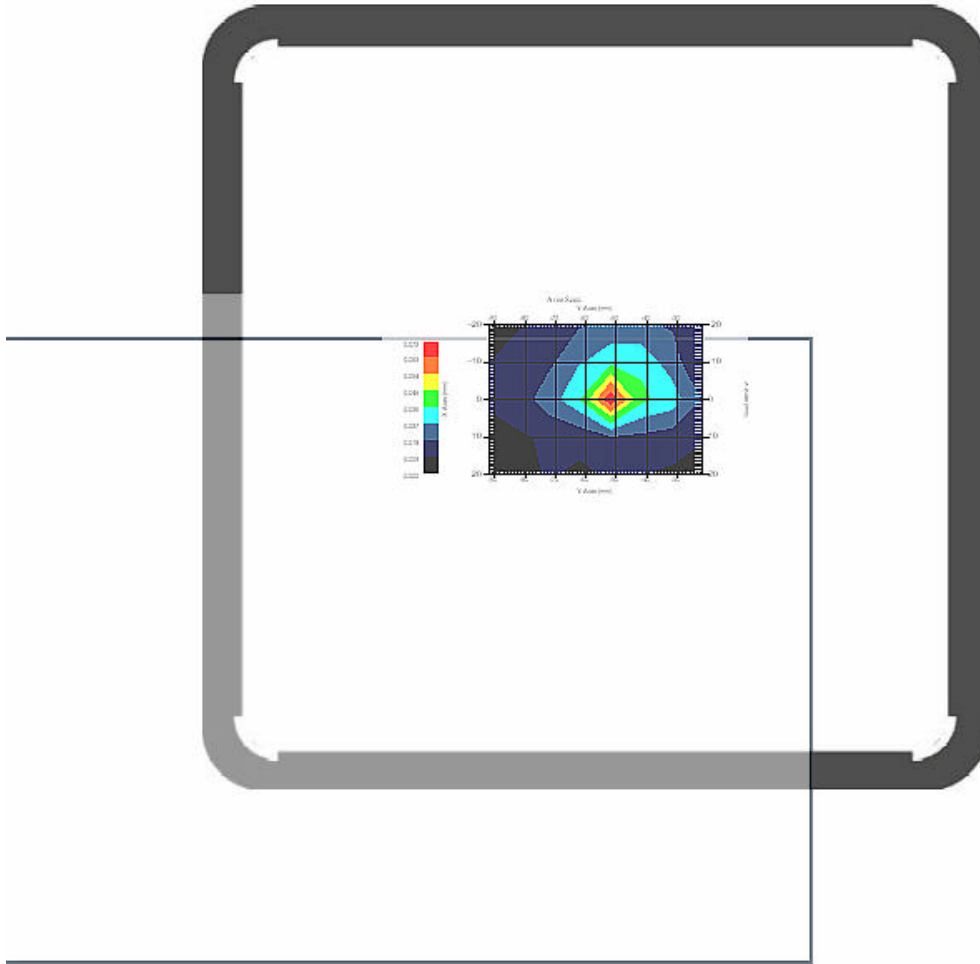

1 gram SAR value : 0.065 W/kg  
10 gram SAR value : 0.035 W/kg  
Area Scan Peak SAR : 0.070 W/kg  
Zoom Scan Peak SAR : 0.120 W/kg

### Area Scan Plot

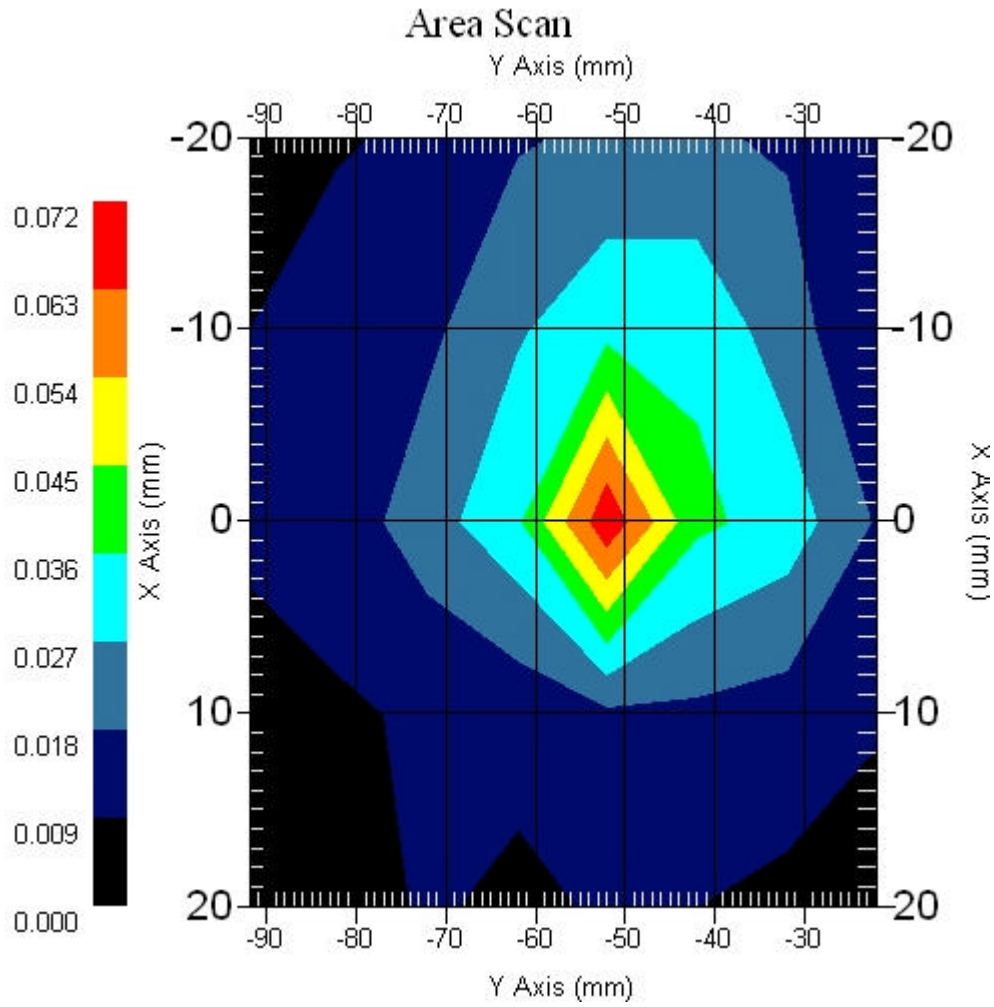

## 1.2 2450 MHz 802.11b Main Ant. , EUT Position: Back

Measurement Date : 25-Jan-2007  
Crest Factor : 1  
Area Scan : 5x7x1 : Measurement x=10mm, y=10mm, z=4mm  
Zoom Scan : 7x7x7 : Measurement x=5mm, y=5mm, z=5mm  
  
DUT Position : Touch  
Channel : Mid - 2437MHz  
  
Power Drift-Start : 0.047 W/kg  
Power Drift-Finish: 0.045 W/kg  
Power Drift (%) : -3.256

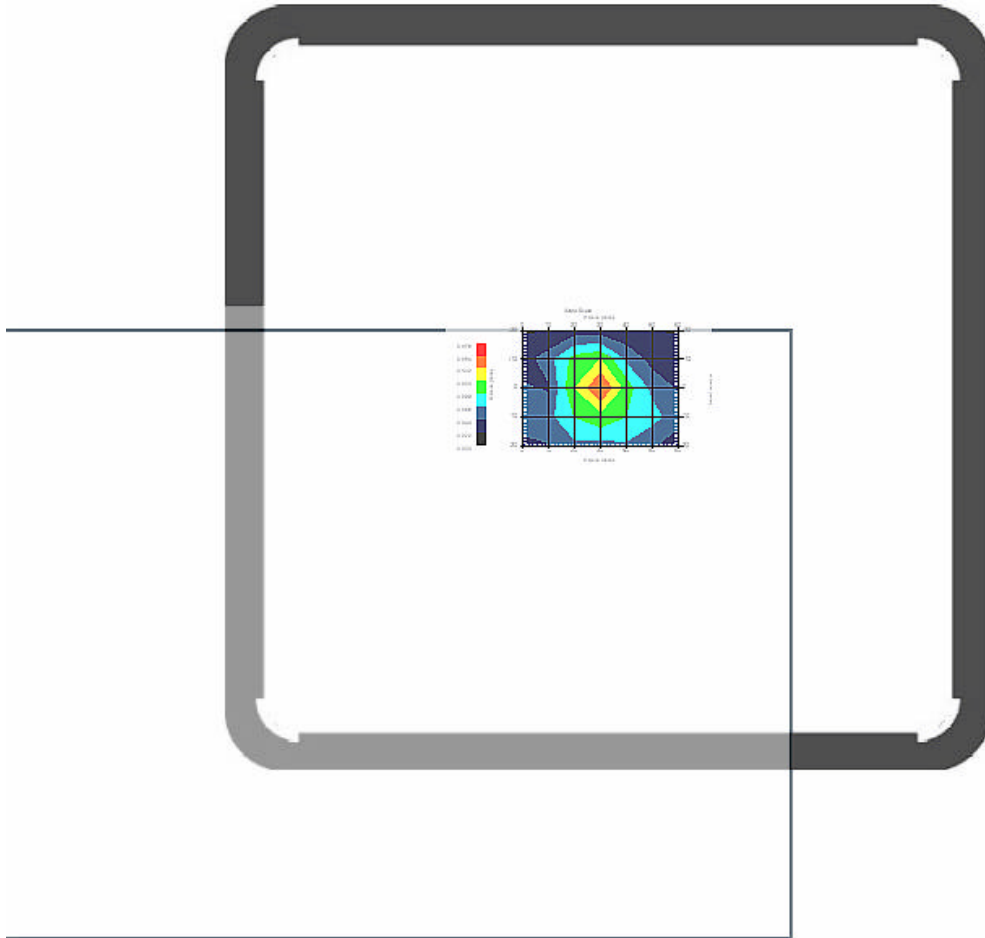

1 gram SAR value : 0.130 W/kg  
10 gram SAR value : 0.071 W/kg  
Area Scan Peak SAR : 0.155 W/kg  
Zoom Scan Peak SAR : 0.240 W/kg

### Area Scan Plot

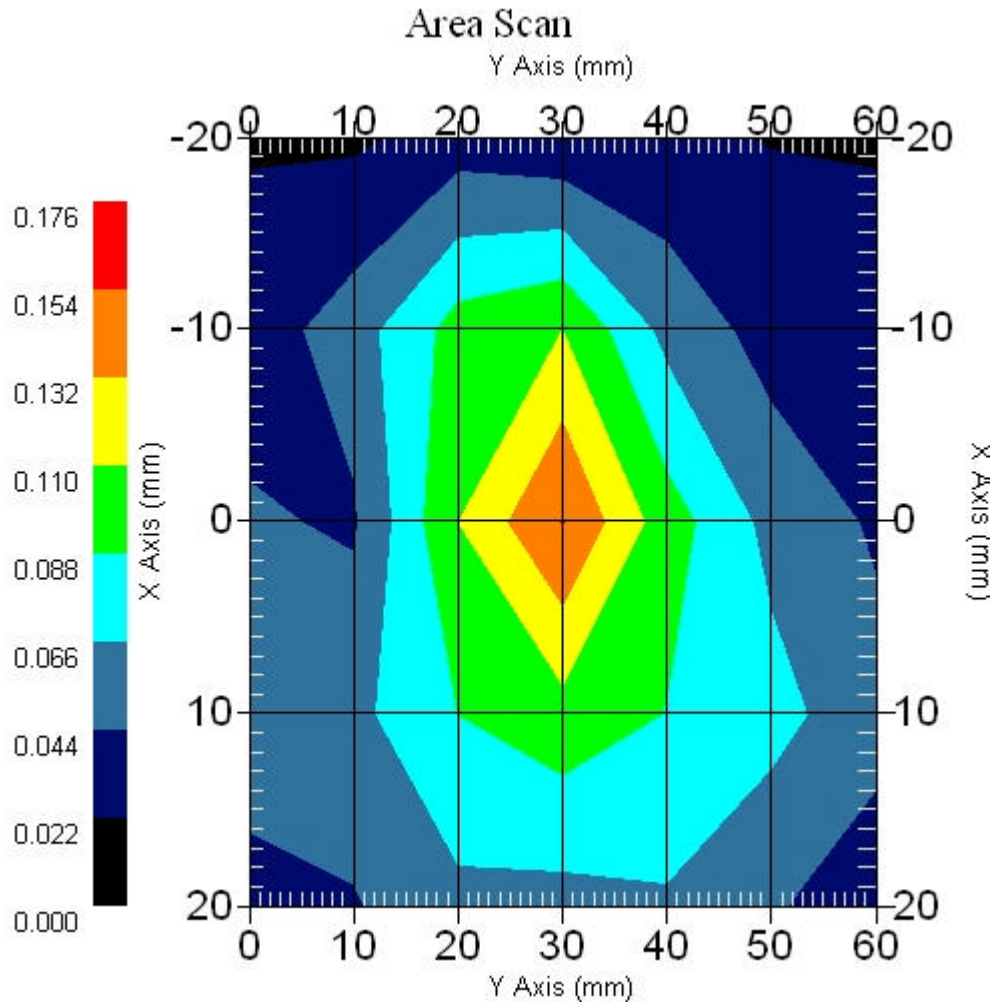

### 1.3 2450 MHz 802.11b Main Ant. , EUT Position: Back

Measurement Date : 25-Jan-2007  
Crest Factor : 1  
Area Scan : 5x7x1 : Measurement x=10mm, y=10mm, z=4mm  
Zoom Scan : 7x7x7 : Measurement x=5mm, y=5mm, z=5mm  
  
DUT Position : Touch  
Channel : High - 2462MHz  
  
Power Drift-Start : 0.039 W/kg  
Power Drift-Finish: 0.038 W/kg  
Power Drift (%) : -2.568

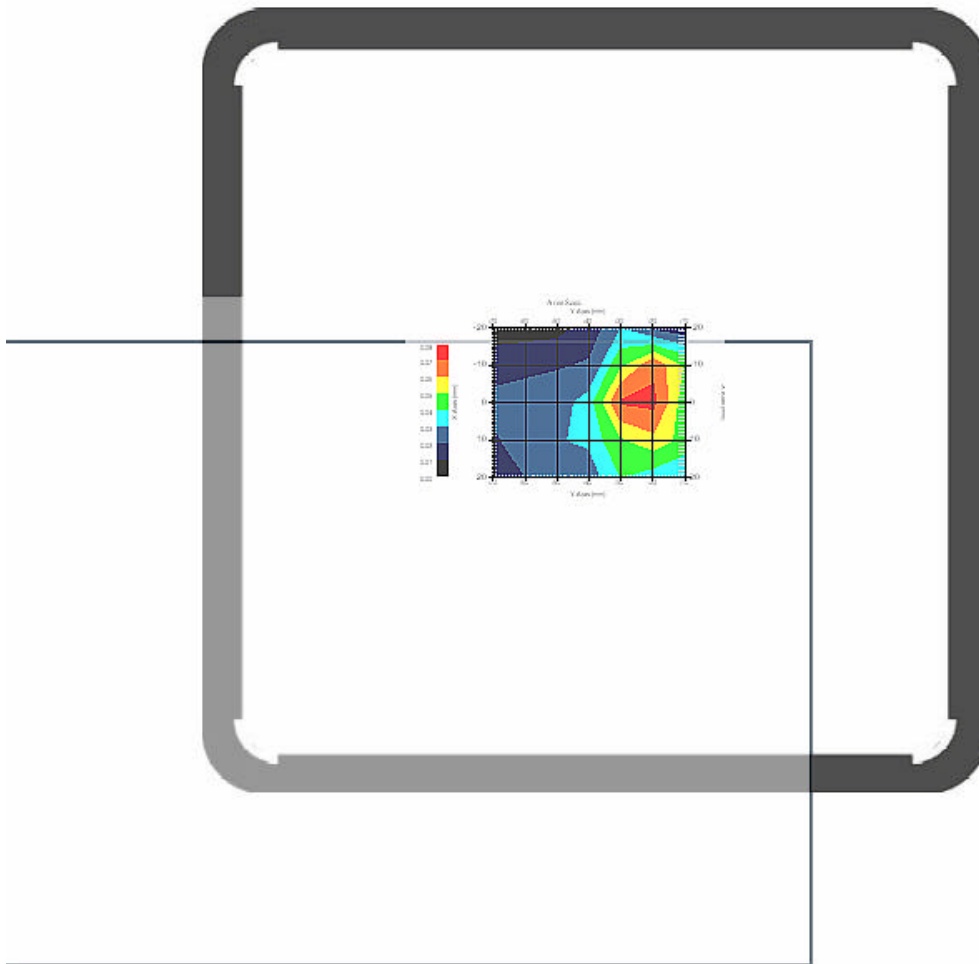

1 gram SAR value : 0.068 W/kg  
10 gram SAR value : 0.036 W/kg  
Area Scan Peak SAR : 0.073 W/kg  
Zoom Scan Peak SAR : 0.140 W/kg

### Area Scan Plot

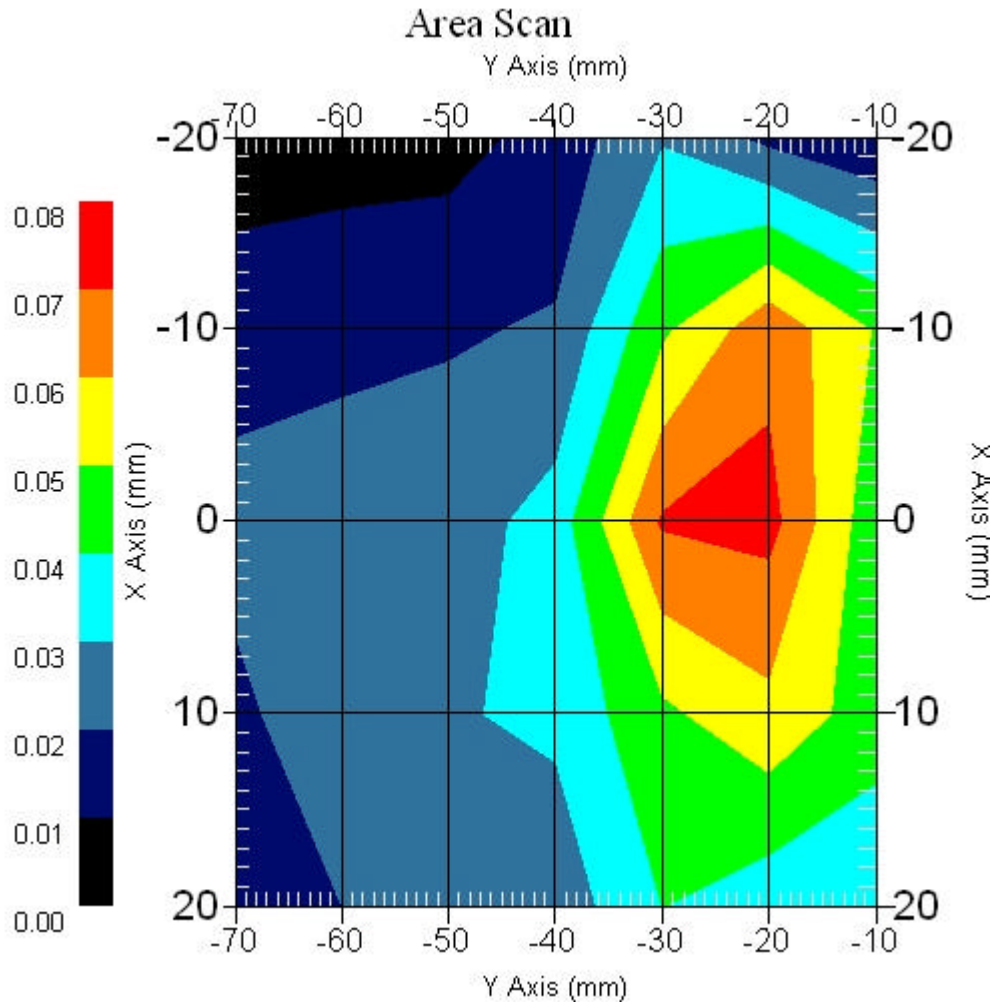



### 1.4 2450 MHz 802.11b Main Ant. , EUT Position: Top

Measurement Date : 25-Jan-2007  
Crest Factor : 1  
Area Scan : 5x8x1 : Measurement x=15mm, y=15mm, z=4mm  
Zoom Scan : 7x7x7 : Measurement x=5mm, y=5mm, z=5mm  
  
DUT Position : Touch  
Channel : Mid - 2437MHz  
  
Power Drift-Start : 0.020 W/kg  
Power Drift-Finish: 0.020 W/kg  
Power Drift (%) : -1.631

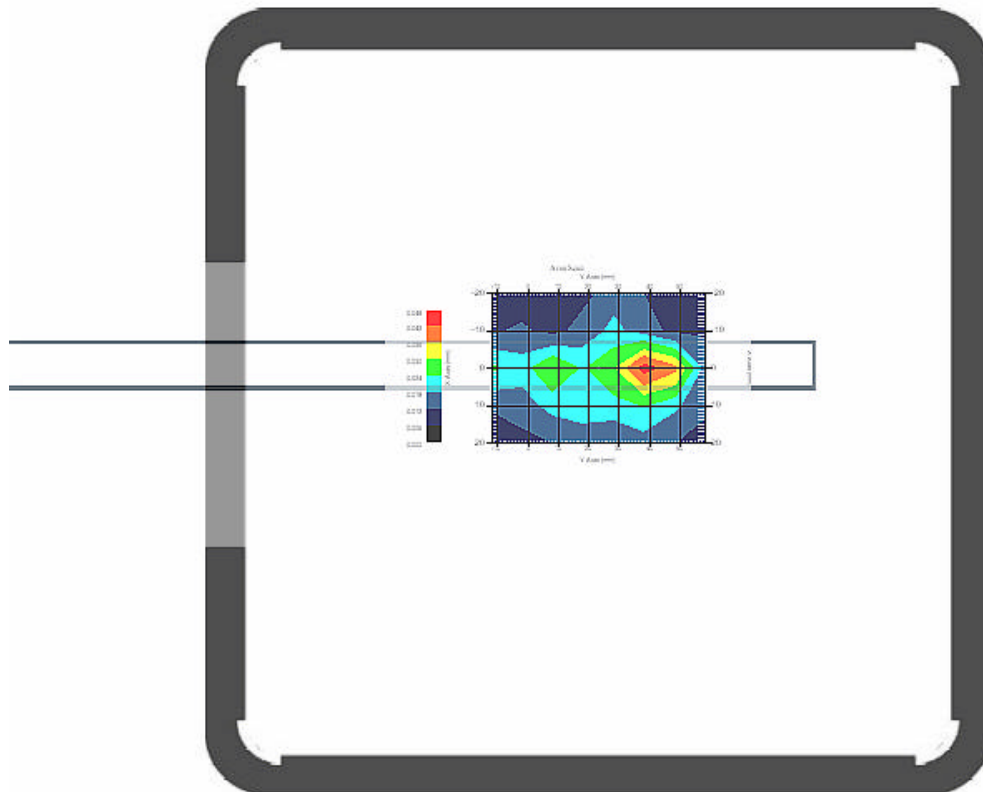

1 gram SAR value : 0.043 W/kg  
10 gram SAR value : 0.028 W/kg  
Area Scan Peak SAR : 0.045 W/kg  
Zoom Scan Peak SAR : 0.090 W/kg

### Area Scan Plot

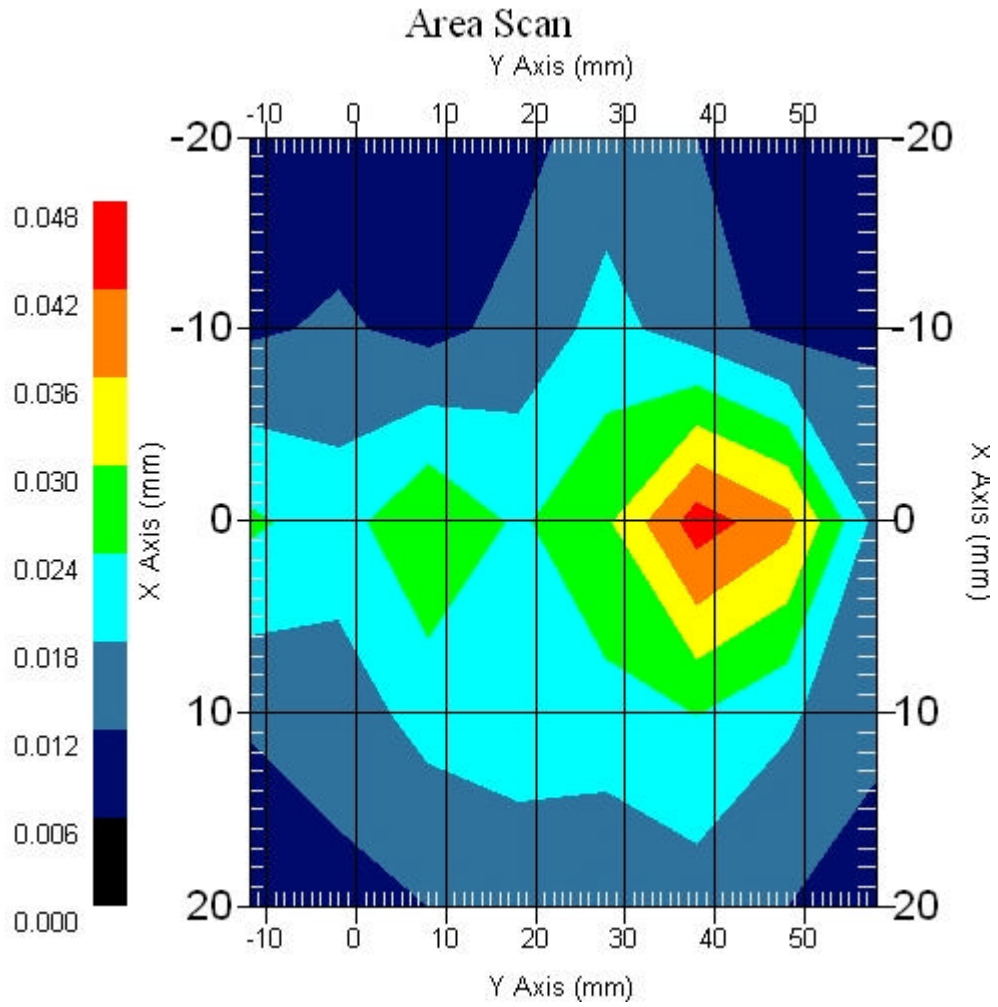

### 1.5 2450 MHz 802.11b Main Ant. , EUT Position: Front

Measurement Date : 25-Jan-2007  
Crest Factor : 1  
Area Scan : 3x8x1 : Measurement x=15mm, y=15mm, z=4mm  
Zoom Scan : 7x7x7 : Measurement x=5mm, y=5mm, z=5mm  
  
DUT Position : Touch  
Channel : Mid - 2437MHz  
  
Power Drift-Start : 0.028 W/kg  
Power Drift-Finish: 0.027 W/kg  
Power Drift (%) : -3.571

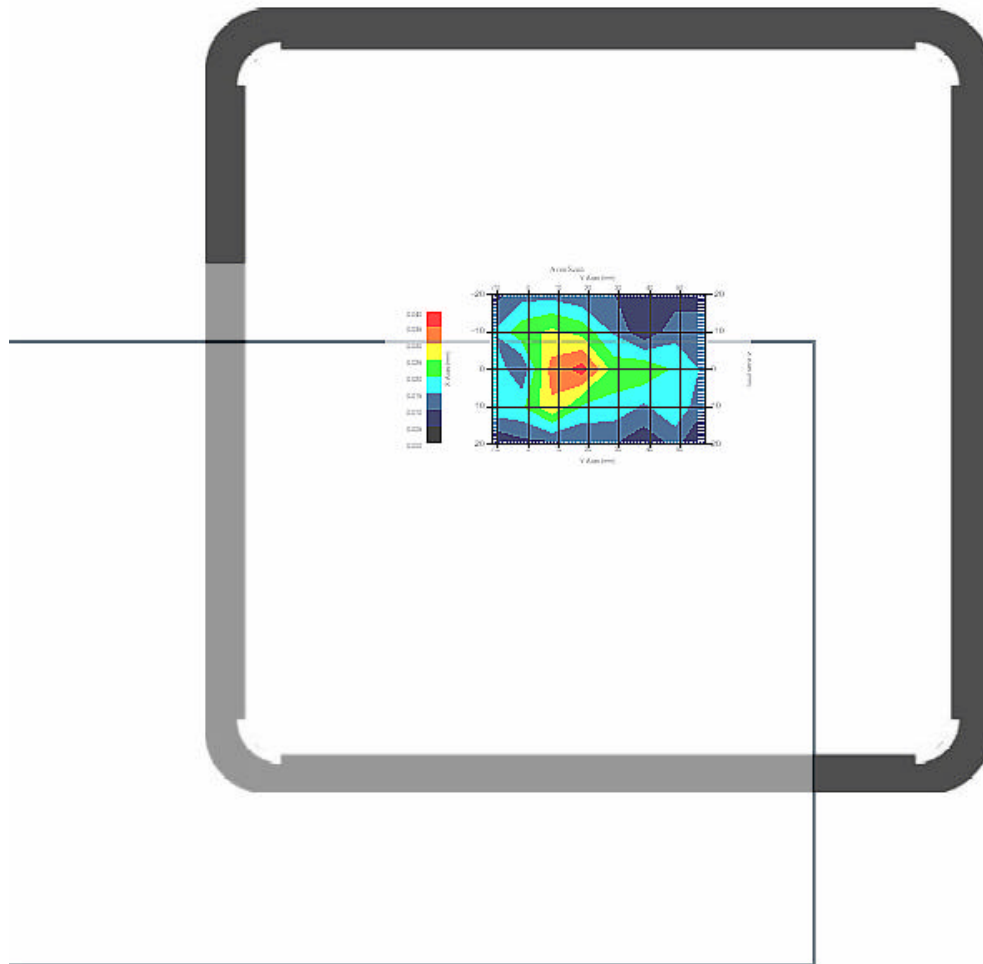

1 gram SAR value : 0.040 W/kg  
10 gram SAR value : 0.029 W/kg  
Area Scan Peak SAR : 0.037 W/kg  
Zoom Scan Peak SAR : 0.070 W/kg

### Area Scan Plot

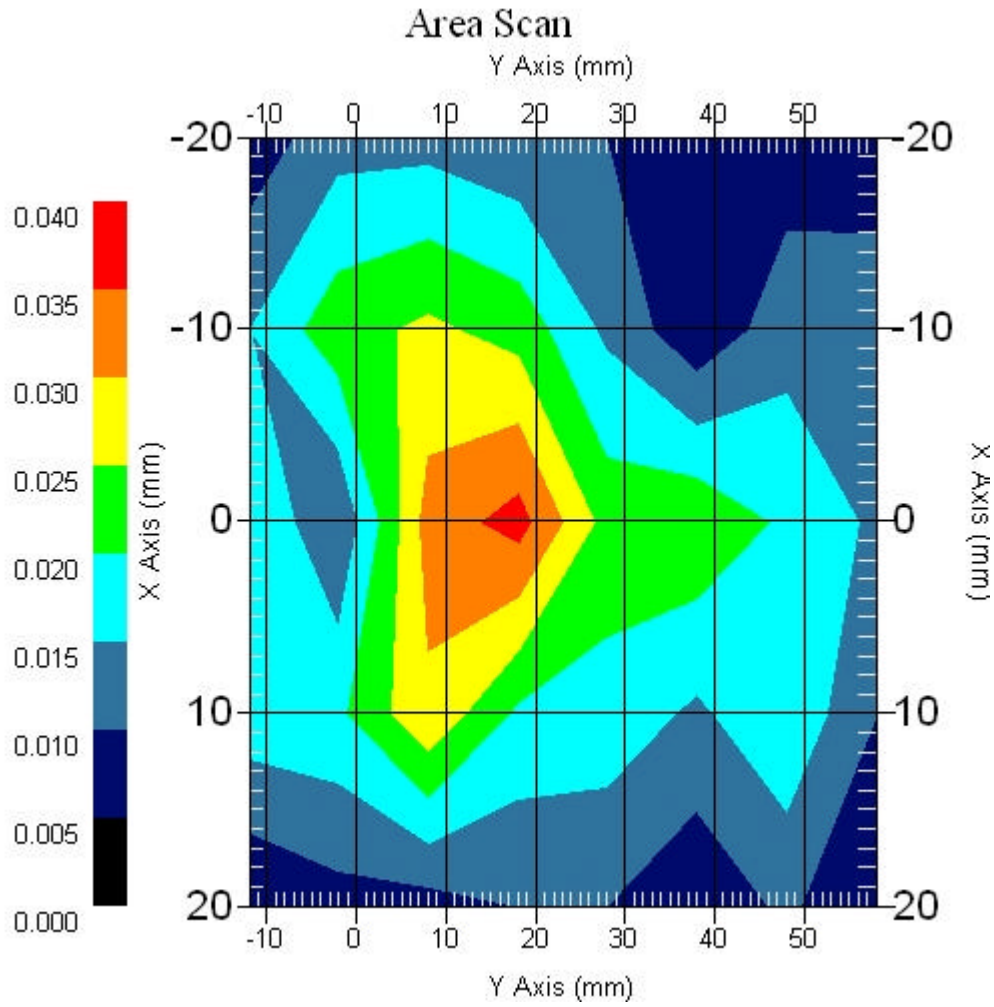

### 1.6 2450 MHz 802.11b Aux. Ant. , EUT Position: Back

Measurement Date : 25-Jan-2007  
Crest Factor : 1  
Area Scan : 5x7x1 : Measurement x=15mm, y=15mm, z=4mm  
Zoom Scan : 7x7x7 : Measurement x=5mm, y=5mm, z=5mm

DUT Position : Touch  
Channel : Mid - 2437MHz

Power Drift-Start : 0.028 W/kg  
Power Drift-Finish: 0.027 W/kg  
Power Drift (%) : -2.949

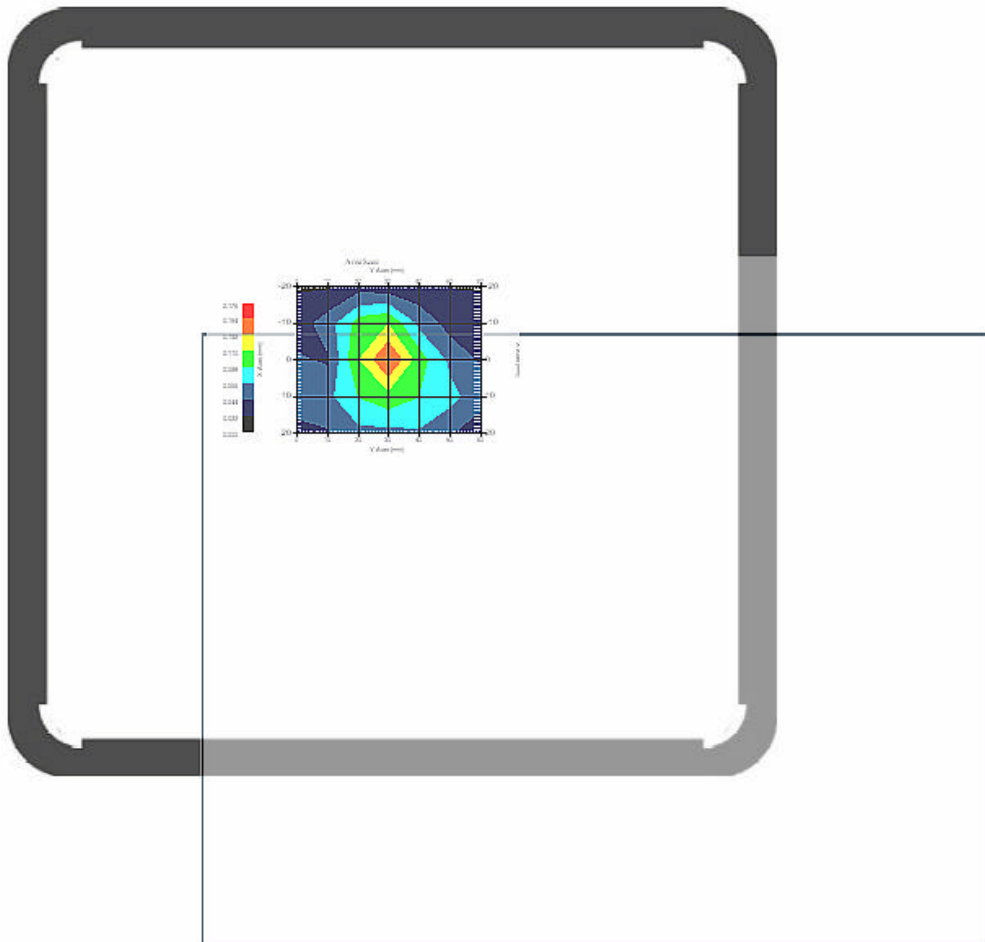

1 gram SAR value : 0.059 W/kg  
10 gram SAR value : 0.035 W/kg  
Area Scan Peak SAR : 0.053 W/kg  
Zoom Scan Peak SAR : 0.100 W/kg

### Area Scan Plot

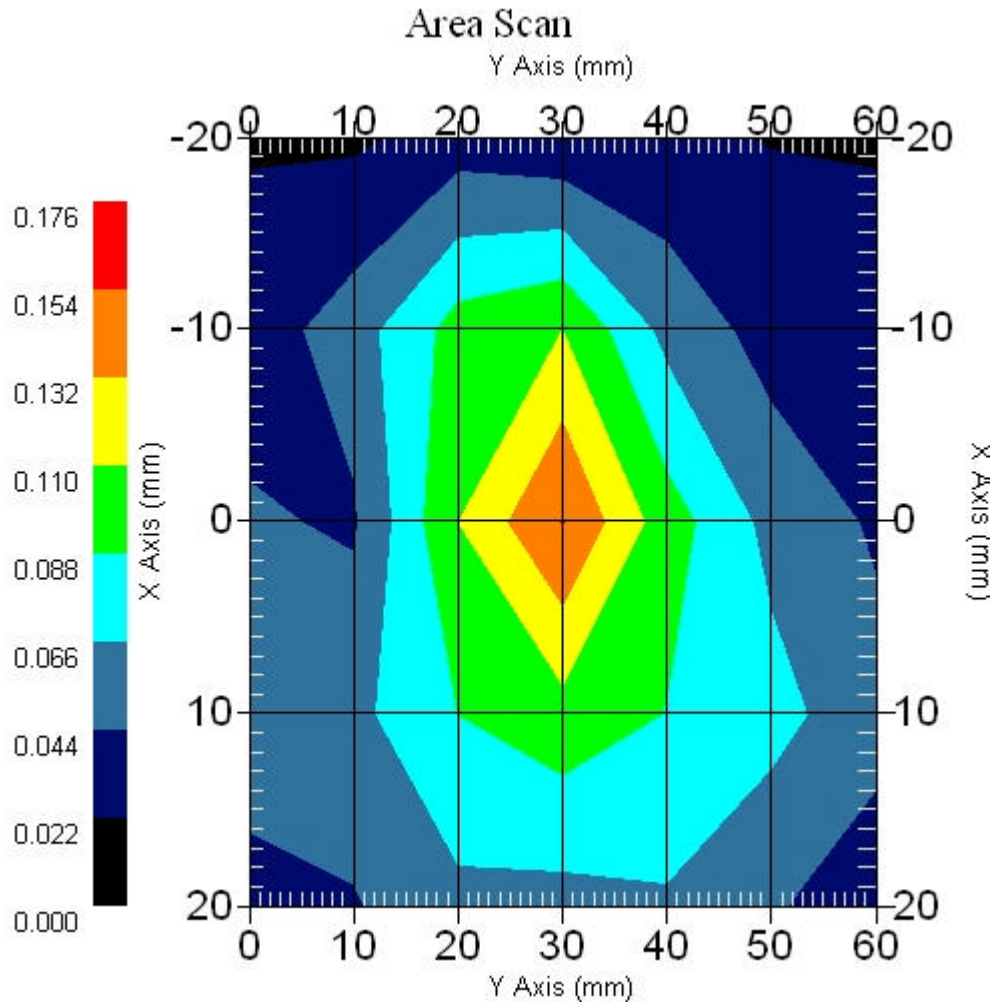

### 1.8 Z-Axis plot

Frequency: 2450 MHz 802.11b Main Ant. , EUT Position: Back

SAR-Z Axis  
at Hotspot x:0.20 y:29.70

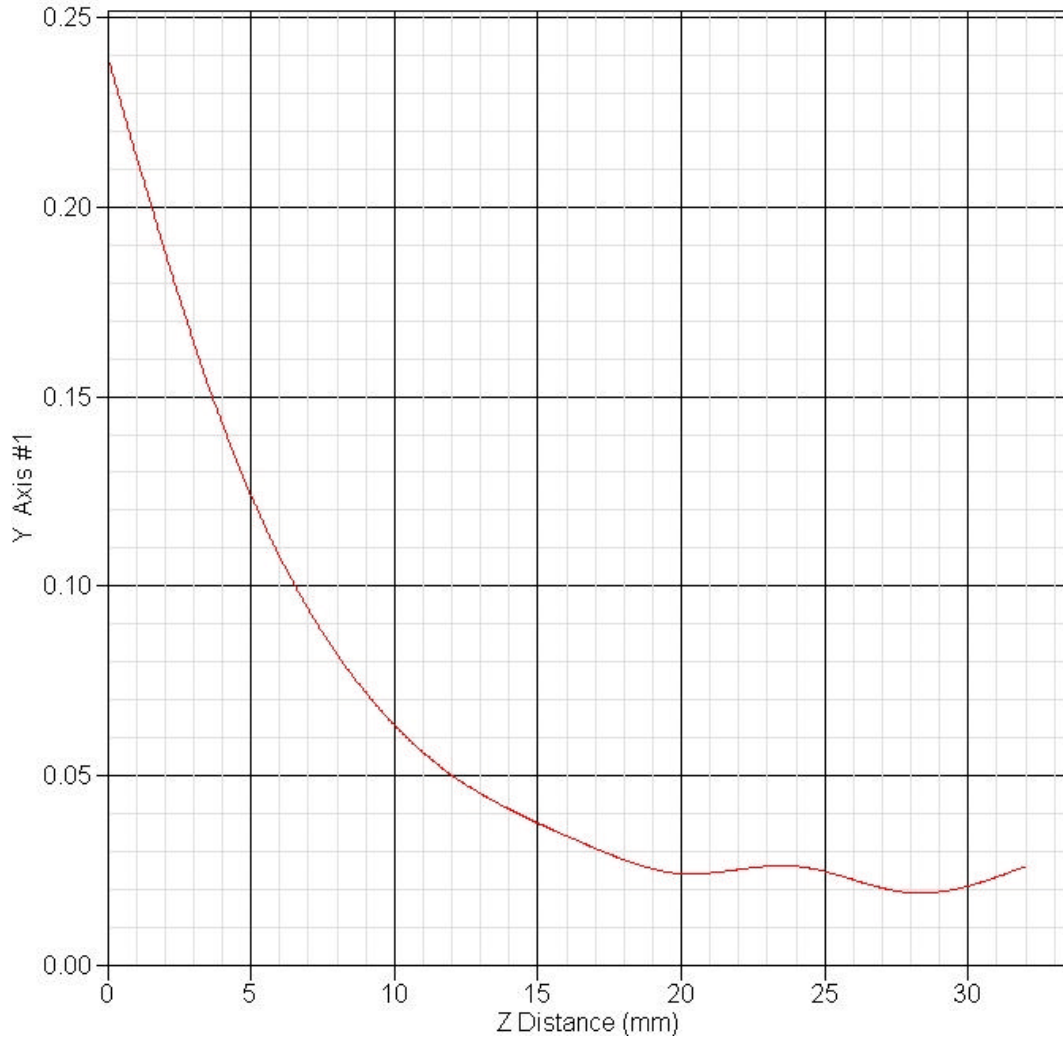



## 2 SAR measurement Data

### SAR Test Report

Report Date : 25-Jan-2007  
Measurement Date : 25-Jan-2007

#### Product Data

Device Name : V100  
Serial No. : 11.g-Back  
Type : Other  
Frequency : 2450.00 MHz  
Max. Transmit Pwr : 0.03 W  
Drift Time : 0 min(s)  
Length : 225 mm  
Width : 290 mm  
Depth : 5 mm  
Antenna Type : Internal

#### Phantom Data

Name : APREL-Uni  
Type : Uni-Phantom  
Size (mm) : 280 x 280 x 200  
Location : Center

#### Tissue Data

Type : BODY  
Serial No. : 2450BODY  
Frequency : 2450.00 MHz  
Last Calib. Date : 25-Jan-2007  
Temperature : 21.60 °C  
Ambient Temp. : 21.80 °C  
Humidity : 43.00 RH%  
Epsilon : 51.28 F/m  
Sigma : 1.98 S/m  
Density : 1000.00 kg/cu. m

#### Probe Data

Name : E-field Probe  
Model : ALS-E-020  
Type : E-Field Triangle  
Serial No. : 266  
Last Calib. Date : 22-Jun-2006  
Frequency : 2450.00 MHz  
Duty Cycle Factor: 1  
Conversion Factor: 5.02  
Probe Sensitivity: 1.20 1.20 1.20  $\mu\text{V}/(\text{V}/\text{m})^2$   
Compression Point: 95.00 mV  
Offset : 1.56 mm



## 2.1 2450 MHz 802.11g Main Ant. , EUT Position: Back

Measurement Date : 25-Jan-2007  
Crest Factor : 1  
Area Scan : 5x7x1 : Measurement x=10mm, y=10mm, z=4mm  
Zoom Scan : 7x7x7 : Measurement x=5mm, y=5mm, z=5mm

DUT Position : Touch  
Channel : Low - 2412Mhz

Power Drift-Start : 0.106 W/kg  
Power Drift-Finish: 0.104 W/kg  
Power Drift (%) : -1.869

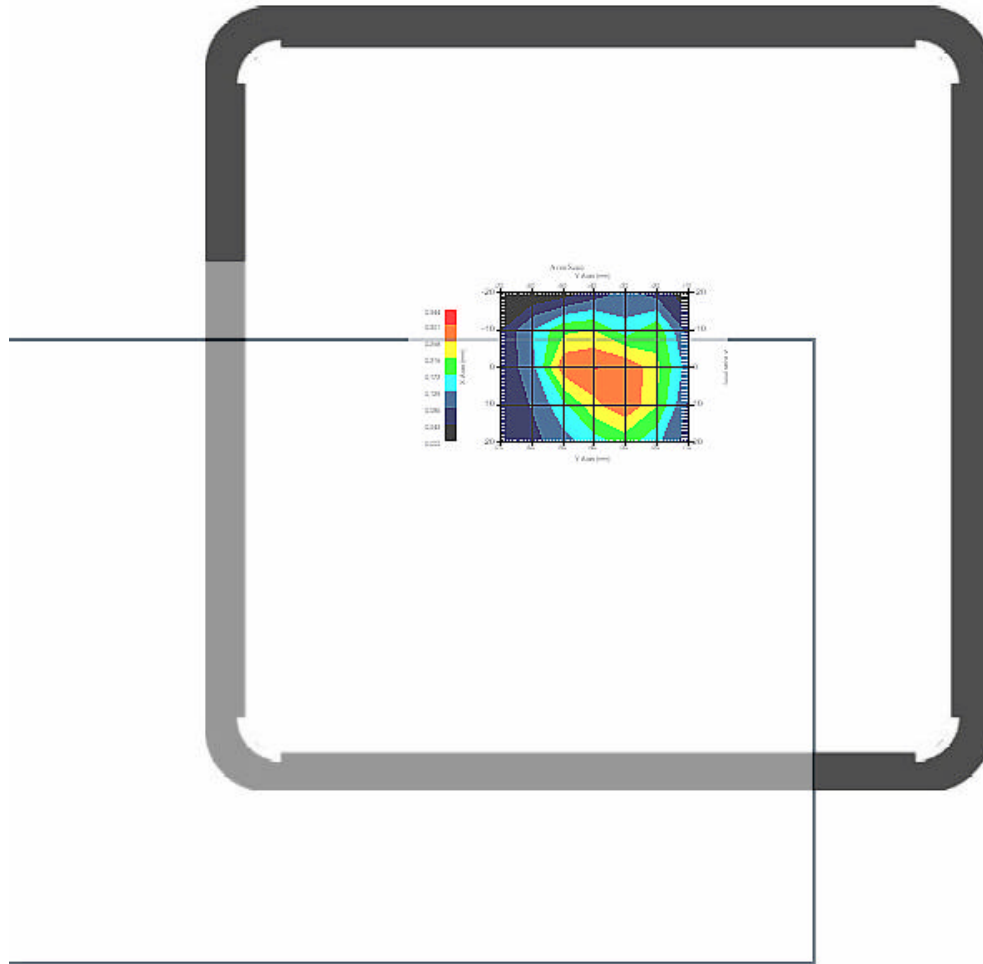

1 gram SAR value : 0.339 W/kg  
10 gram SAR value : 0.182 W/kg  
Area Scan Peak SAR : 0.303 W/kg  
Zoom Scan Peak SAR : 0.614 W/kg

### Area Scan Plot

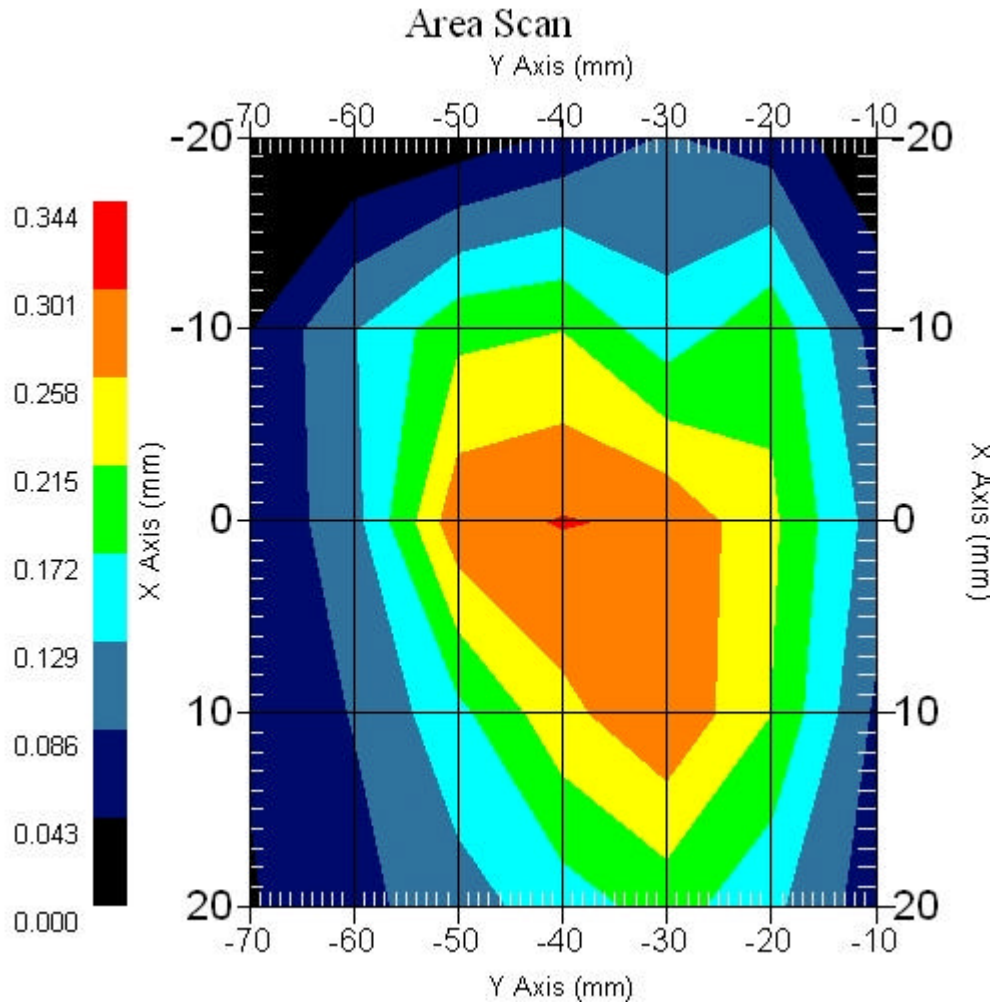

## 2.2 2450 MHz 802.11g Main Ant. , EUT Position: Back

Measurement Date : 25-Jan-2007  
Crest Factor : 1  
Area Scan : 5x7x1 : Measurement x=10mm, y=10mm, z=4mm  
Zoom Scan : 7x7x7 : Measurement x=5mm, y=5mm, z=5mm

DUT Position : Touch  
Channel : Mid - 2412MHz

Power Drift-Start : 0.150 W/kg  
Power Drift-Finish: 0.147 W/kg  
Power Drift (%) : -2.005

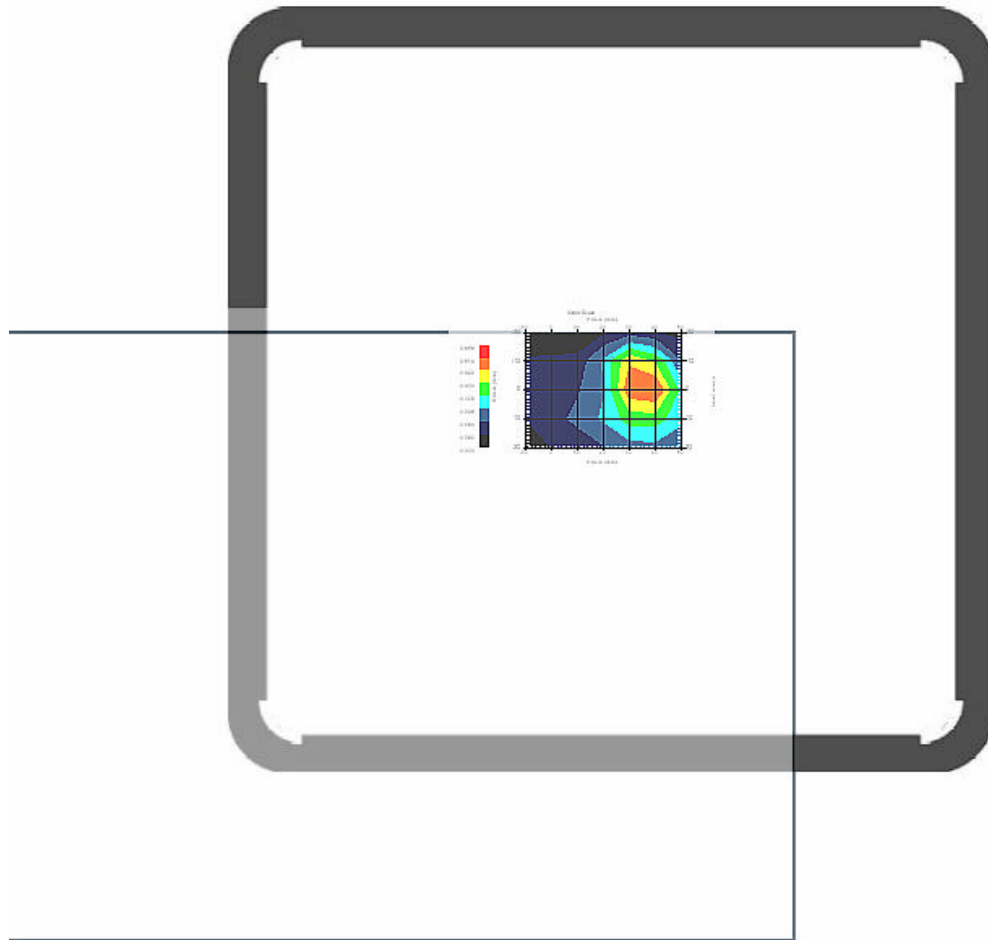

1 gram SAR value : 0.487 W/kg  
10 gram SAR value : 0.228 W/kg  
Area Scan Peak SAR : 0.575 W/kg  
Zoom Scan Peak SAR : 1.010 W/kg

### Area Scan Plot

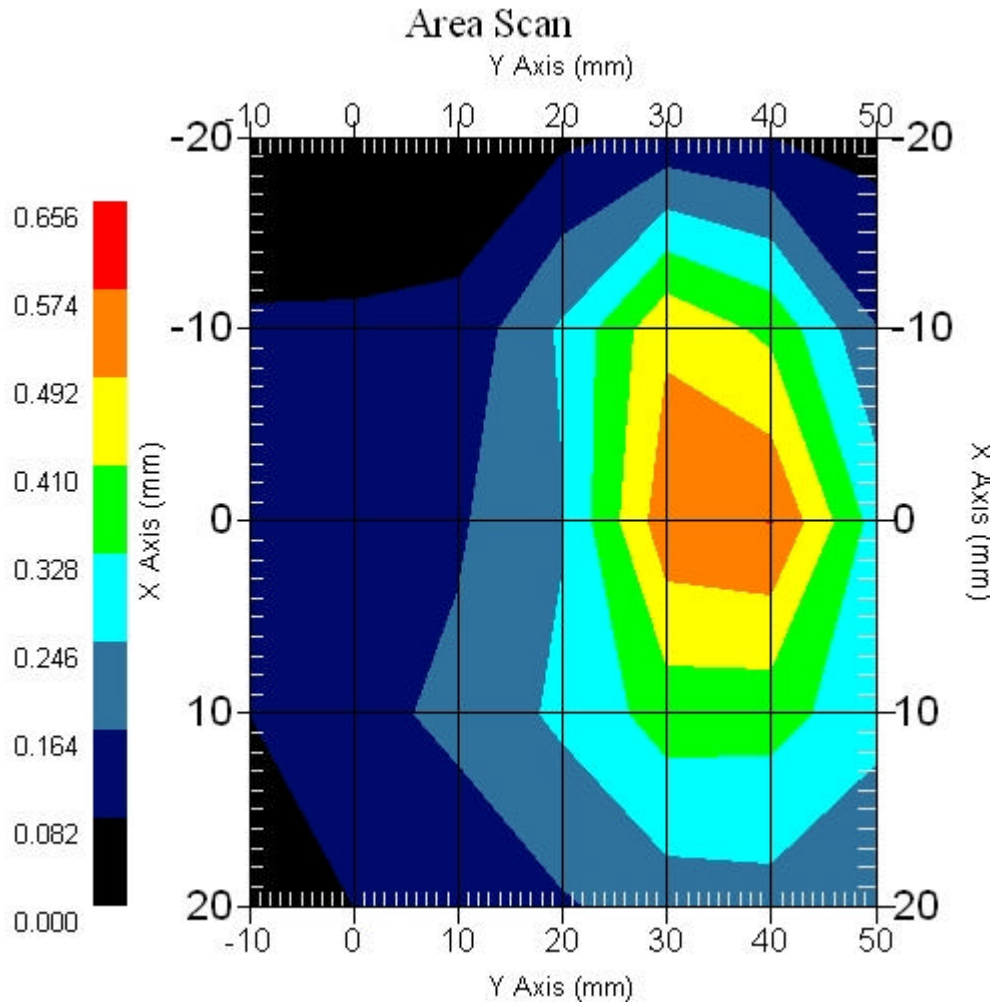

### 2.3 2450 MHz 802.11g Main Ant. , EUT Position: Back

Measurement Date : 25-Jan-2007  
Crest Factor : 1  
Area Scan : 5x7x1 : Measurement x=10mm, y=10mm, z=4mm  
Zoom Scan : 7x7x7 : Measurement x=5mm, y=5mm, z=5mm

DUT Position : Touch  
Channel : High - 2462MHz

Power Drift-Start : 0.077 W/kg  
Power Drift-Finish: 0.074 W/kg  
Power Drift (%) : -3.898

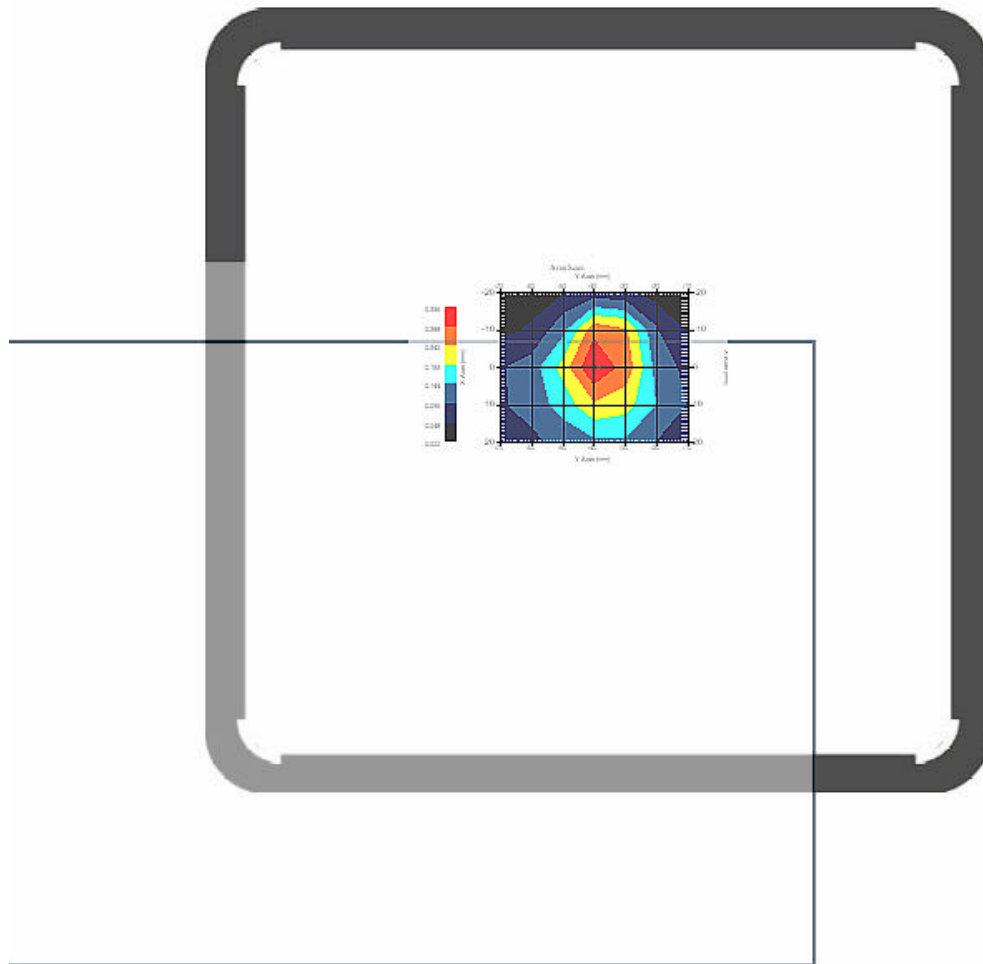

1 gram SAR value : 0.298 W/kg  
10 gram SAR value : 0.153 W/kg  
Area Scan Peak SAR : 0.336 W/kg  
Zoom Scan Peak SAR : 0.560 W/kg

### Area Scan Plot

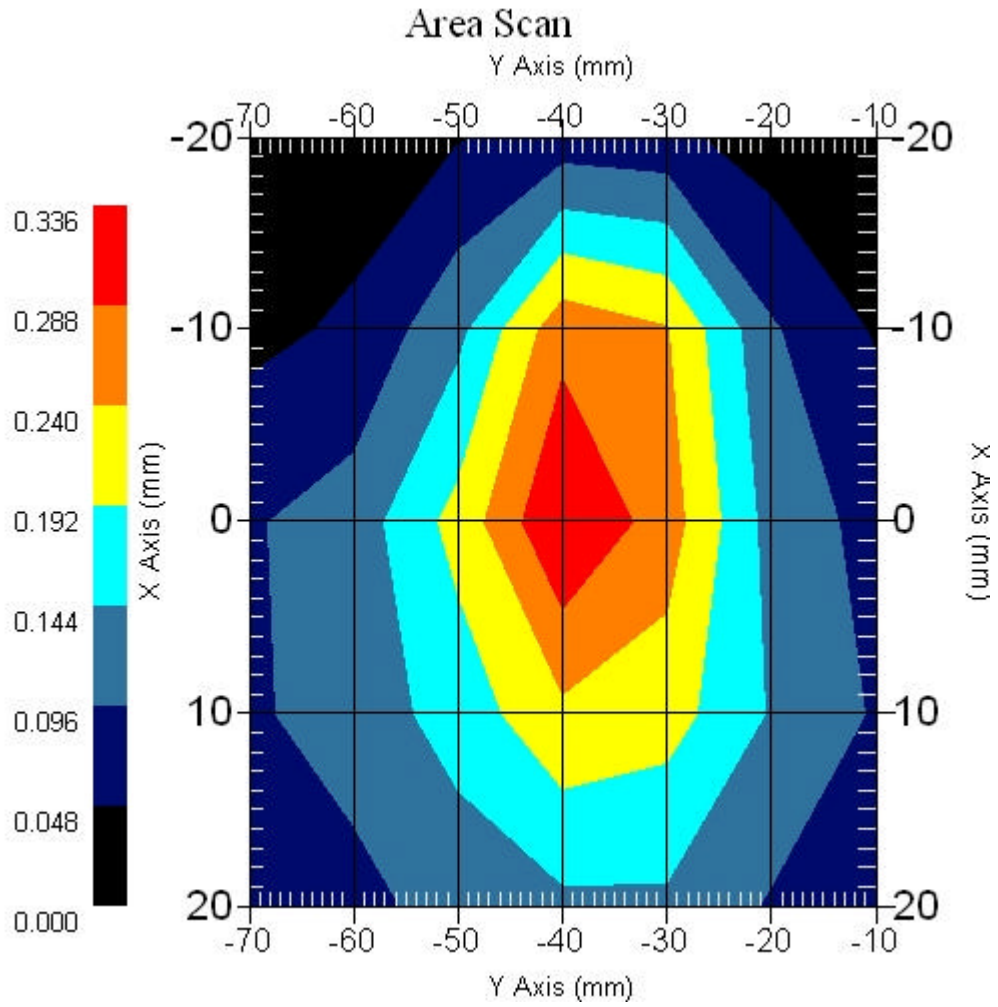

## 2.4 2450 MHz 802.11g Main Ant. , EUT Position: Top

Measurement Date : 25-Jan-2007  
Crest Factor : 1  
Area Scan : 5x7x1 : Measurement x=10mm, y=10mm, z=4mm  
Zoom Scan : 7x7x7 : Measurement x=5mm, y=5mm, z=5mm

DUT Position : Touch  
Channel : Mid - 2437MHz

Power Drift-Start : 0.075 W/kg  
Power Drift-Finish: 0.073 W/kg  
Power Drift (%) : -2.667

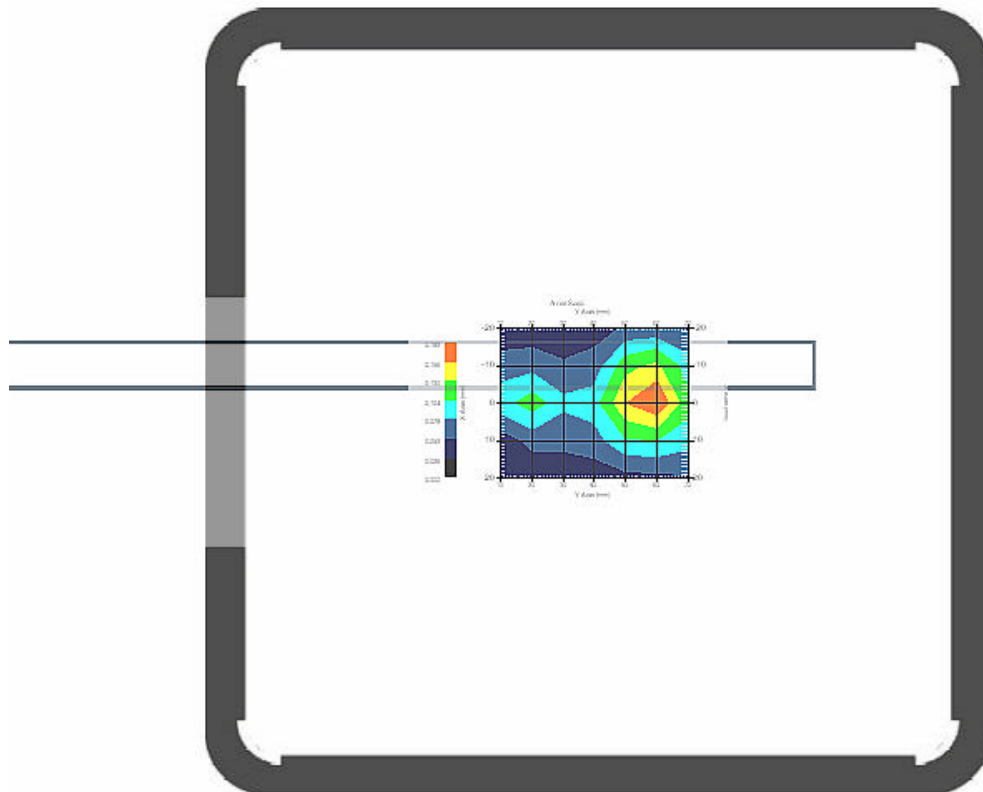

1 gram SAR value : 0.150 W/kg  
10 gram SAR value : 0.081 W/kg  
Area Scan Peak SAR : 0.182 W/kg  
Zoom Scan Peak SAR : 0.290 W/kg

### Area Scan Plot

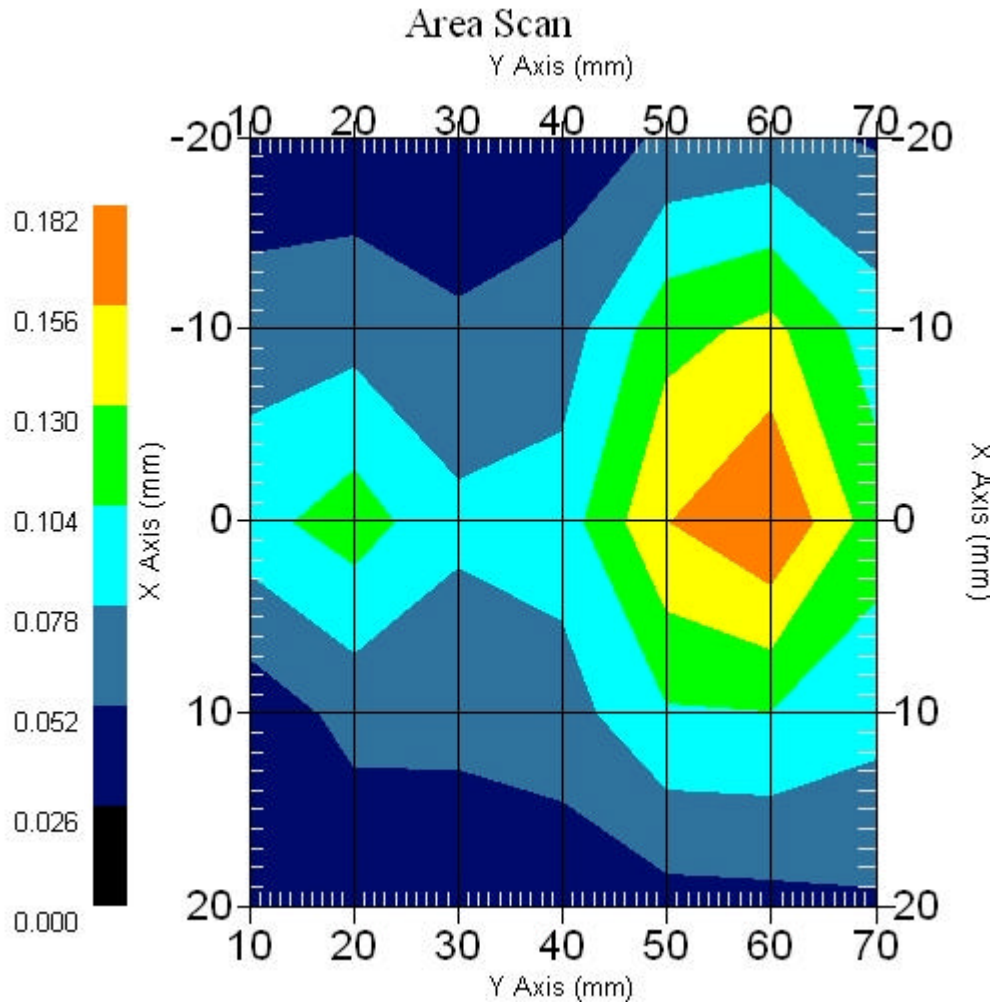



## 2.5 2450 MHz 802.11g Main Ant. , EUT Position: Front

Measurement Date : 25-Jan-2007  
Crest Factor : 1  
Area Scan : 5x7x1 : Measurement x=10mm, y=10mm, z=4mm  
Zoom Scan : 7x7x7 : Measurement x=5mm, y=5mm, z=5mm  
  
DUT Position : Touch  
Channel : Mid - 2437MHz  
  
Power Drift-Start : 0.072 W/kg  
Power Drift-Finish: 0.073 W/kg  
Power Drift (%) : 0.972

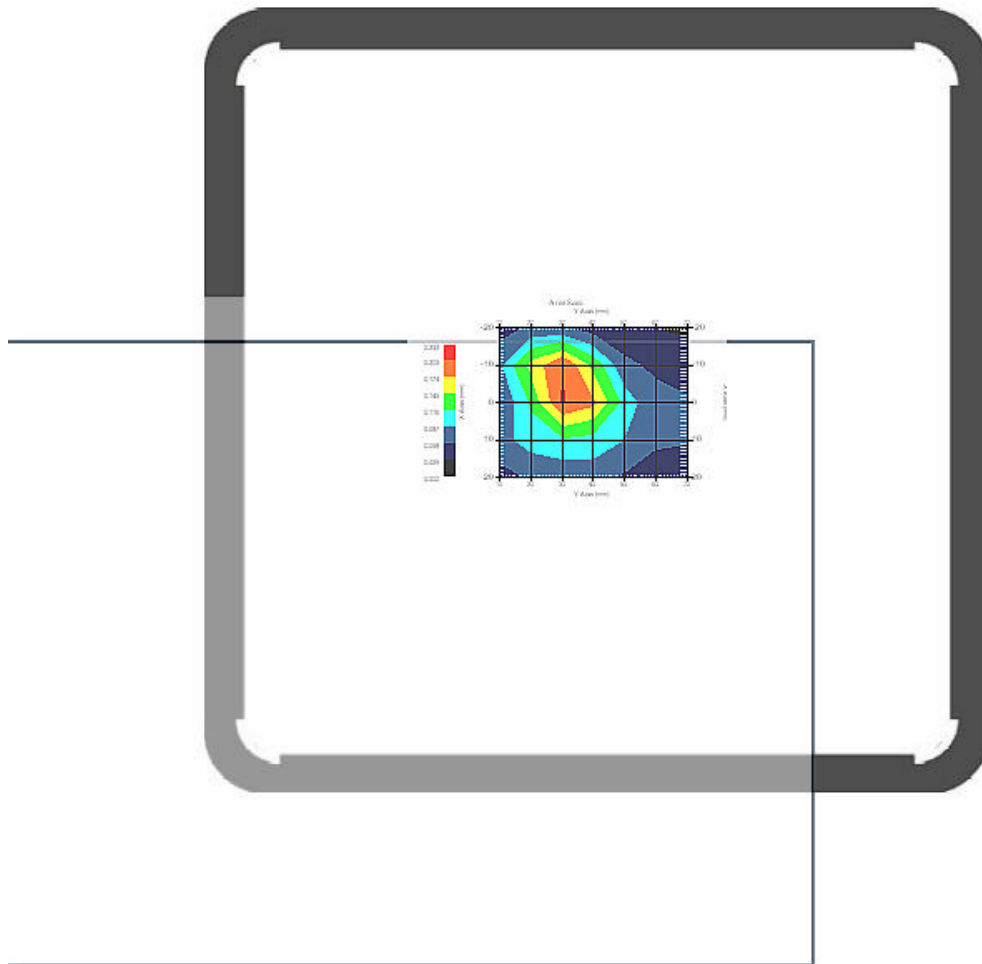

1 gram SAR value : 0.192 W/kg  
10 gram SAR value : 0.095 W/kg  
Area Scan Peak SAR : 0.205 W/kg  
Zoom Scan Peak SAR : 0.390 W/kg

### Area Scan Plot

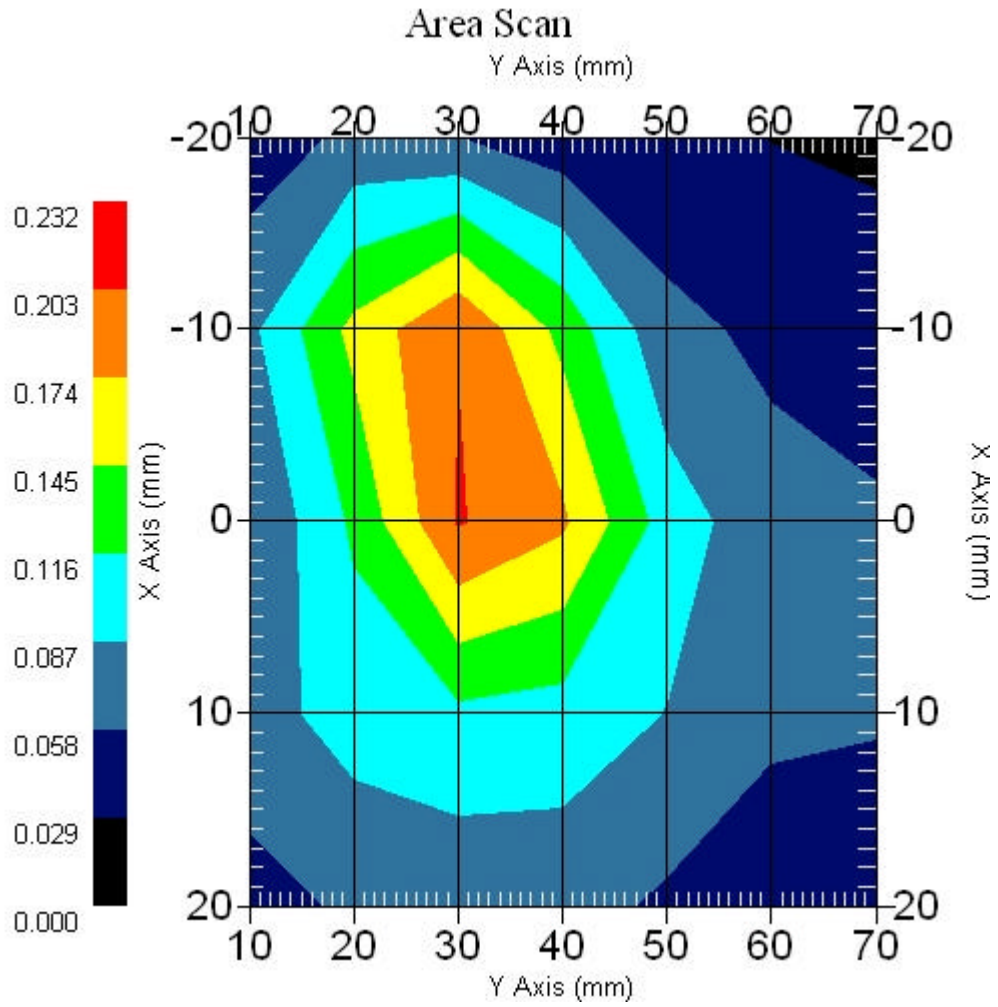

## 2.6 2450 MHz 802.11g Aux. Ant. , EUT Position: Back

Measurement Date : 25-Jan-2007  
Crest Factor : 1  
Area Scan : 5x7x1 : Measurement x=10mm, y=10mm, z=4mm  
Zoom Scan : 7x7x7 : Measurement x=5mm, y=5mm, z=5mm

DUT Position : Touch  
Channel : Mid - 2437MHz

Power Drift-Start : 0.087 W/kg  
Power Drift-Finish: 0.089 W/kg  
Power Drift (%) : 2.299

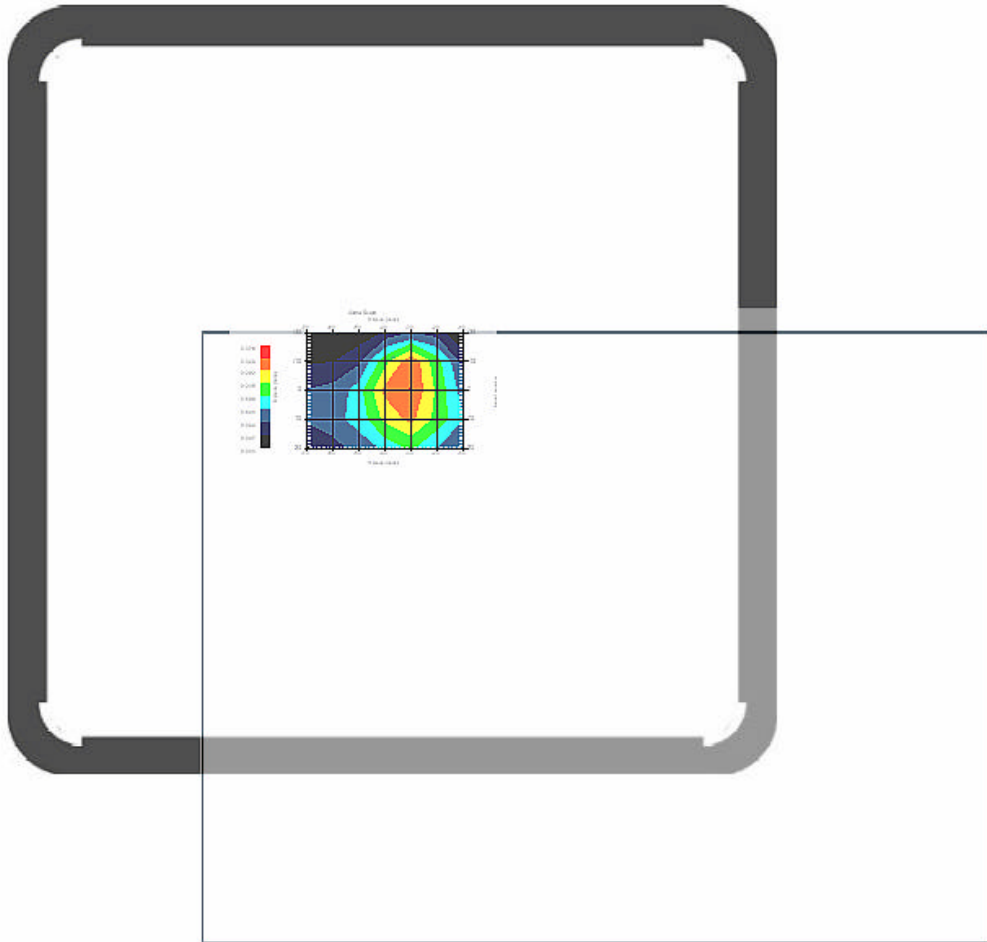

1 gram SAR value : 0.356 W/kg  
10 gram SAR value : 0.187 W/kg  
Area Scan Peak SAR : 0.331 W/kg  
Zoom Scan Peak SAR : 0.650 W/kg

### Area Scan Plot

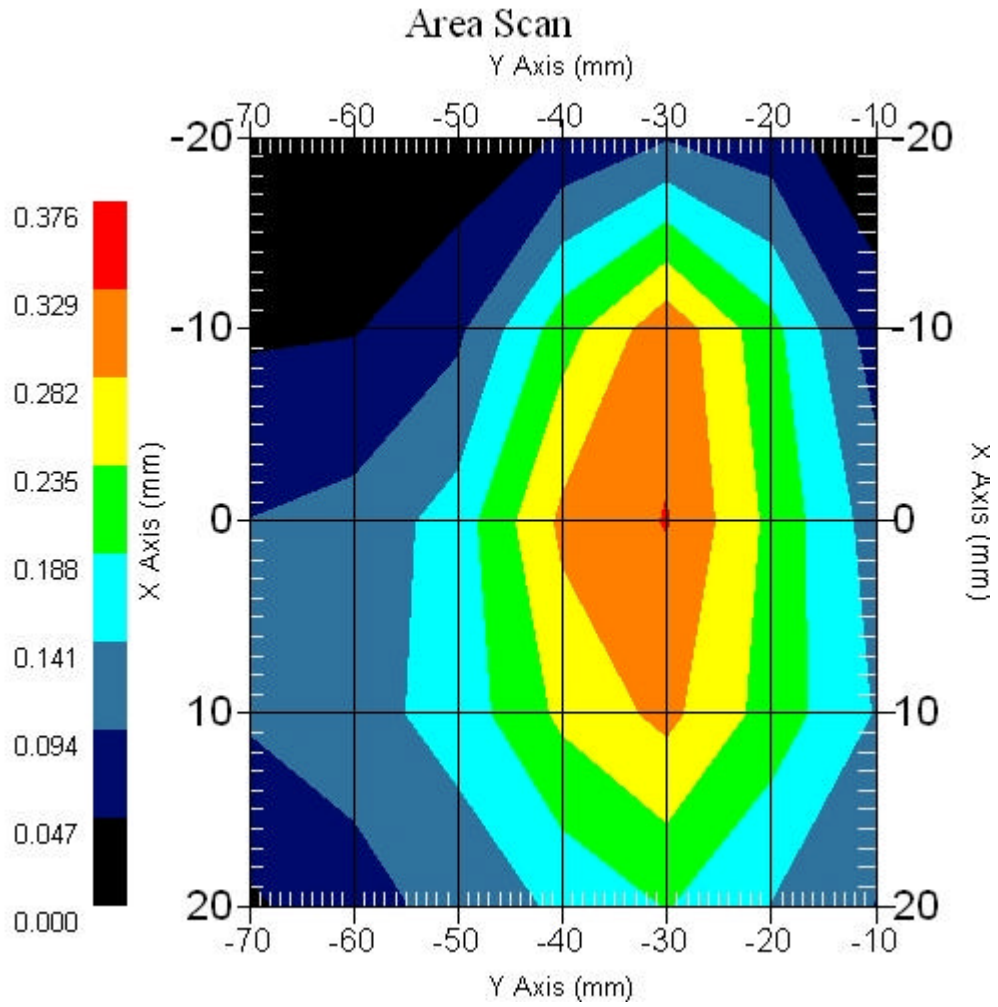

## 2.8 Z-Axis plot

Frequency: 2450 MHz 802.11g Main Ant. , EUT Position: Back

SAR-Z Axis  
at Hotspot x:0.30 y:31.80

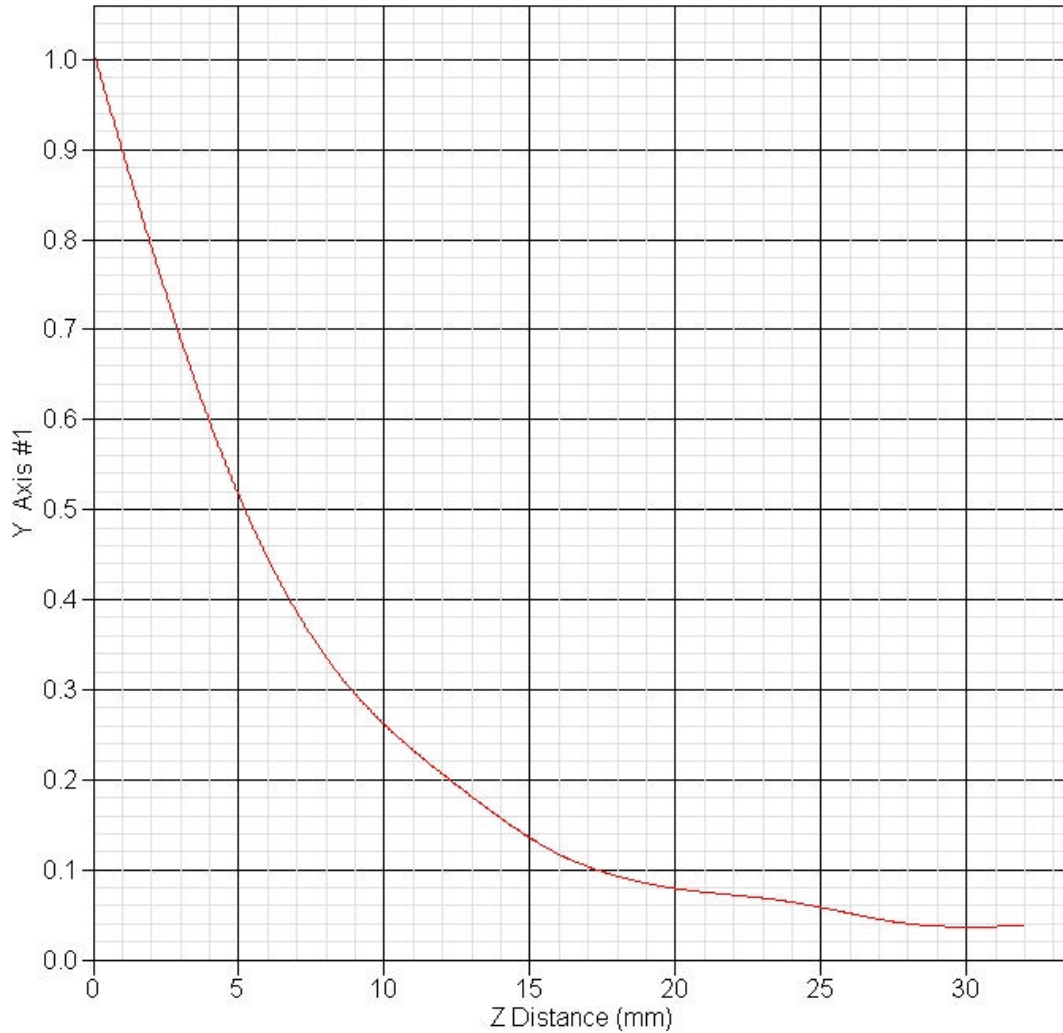



### 3 SAR measurement Data

#### SAR Test Report

Report Date : 29-Jan-2007  
Measurement Date : 29-Jan-2007

##### Product Data

Device Name : V100  
Serial No. : 11.a-Back  
Type : Other  
Frequency : 5200.00 MHz  
Drift Time : 0 min(s)  
Length : 225 mm  
Width : 290 mm  
Depth : 5 mm  
Antenna Type : Internal

##### Phantom Data

Name : APREL-Uni  
Type : Uni-Phantom  
Size (mm) : 280 x 280 x 200  
Location : Center

##### Tissue Data

Type : BODY  
Serial No. : 5200-B-AU-18  
Frequency : 5200.00 MHz  
Last Calib. Date : 29-Jan-2007  
Temperature : 22.00 °C  
Ambient Temp. : 22.30 °C  
Humidity : 45.00 RH%  
Epsilon : 48.540 F/m  
Sigma : 5.190 S/m  
Density : 1000.00 kg/cu. m

##### Probe Data

Name : E-field Probe  
Model : ALS-E-020  
Type : E-Field Triangle  
Serial No. : 266  
Last Calib. Date : 22-Jun-2006  
Frequency : 5200.00 MHz  
Duty Cycle Factor: 1  
Conversion Factor: 4.4  
Probe Sensitivity: 1.20 1.20 1.20  $\mu\text{V}/(\text{V}/\text{m})^2$   
Compression Point: 95.00 mV  
Offset : 2.44 mm