

5180 MHz:



5240 MHz:



5260 MHz:



5320 MHz:



### 6.3. Peak Power Excursion Measurement [Section 15.407(a)(6) ]

#### 6.3.1. Test Procedure

1. The Transmitter output of EUT was connected to the spectrum analyzer.
2. Frequency SPAN of Spectrum: 30MHz or 50MHz.
3. Trace 1 : RBW: 1MHz, VBW: 3MHz. Using positive detector and Max -hold
4. Trace 2 : RBW: 1MHz, VBW: 3MHz. Using Power average mode 100 times
5. Record the largest difference between Trace 1 and Trace 2.

#### 6.3.2. Test Setup

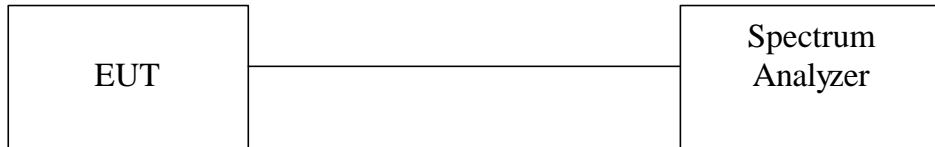

#### 6.3.3. Test Data: (Normal Mode)

##### Peak Power Excursion

Temperature (deg. C): 25

Test Engineer: Jerry Chiou

Humidity (%): 50

Channel	Frequency (Mhz)	Peak Power Excursion (dBm)	Limit dBm	Pass/Fail
1	5180	7.55	13	Pass
4	5240	8.51	13	Pass
5	5260	8.67	13	Pass
8	5320	8.45	13	Pass

5180 MHz:

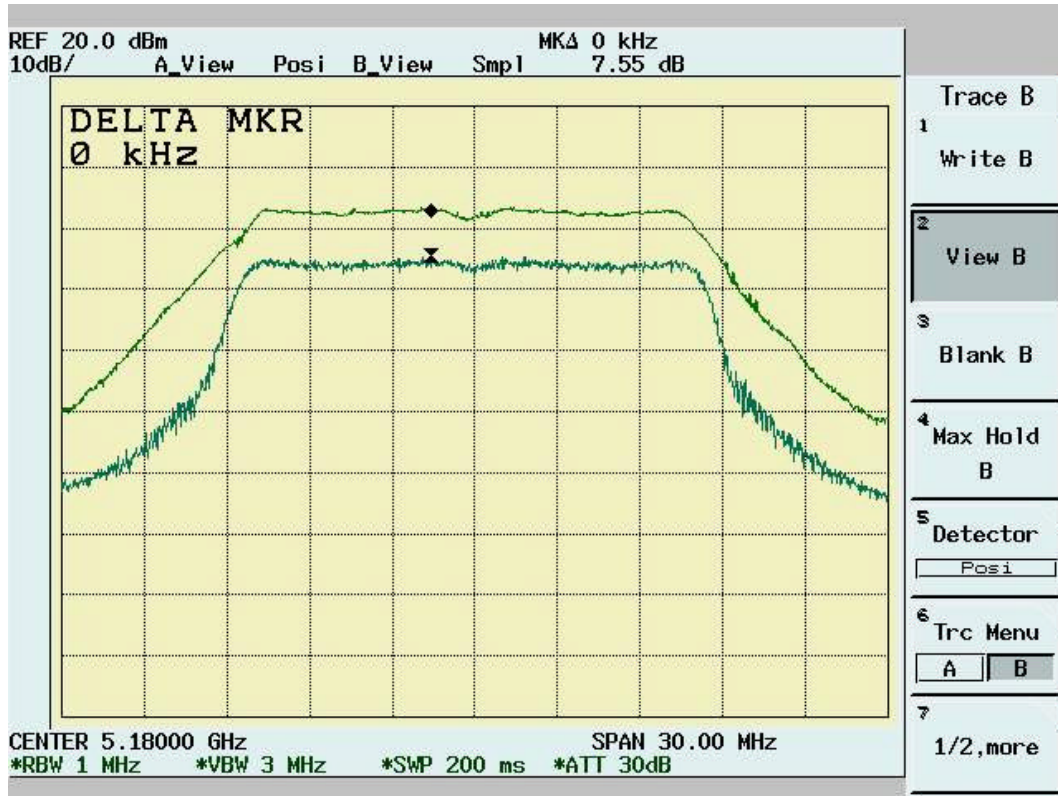

5240 MHz:



5260 MHz:

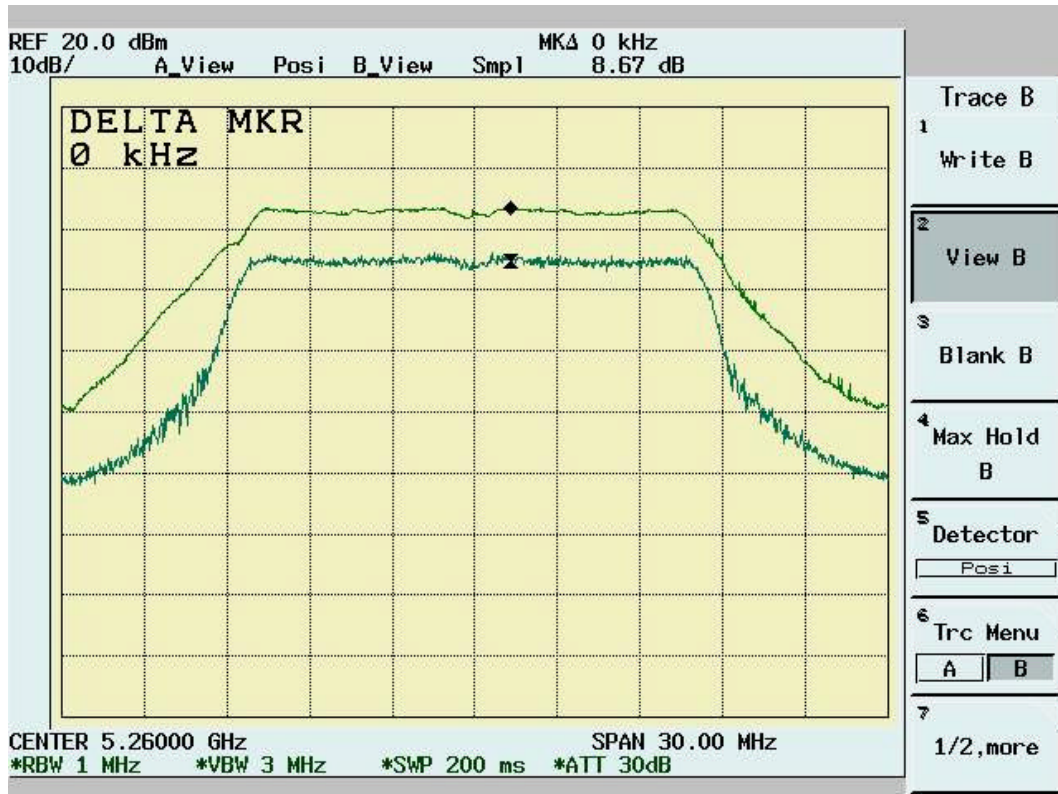

5320 MHz:



## 6.4. Powerline Conducted Emissions

[Section 15.207 & 15.407 (b)(5) ]

### 6.4.1. EUT Configuration

The EUT was set up on the non-conductive table that is 1.0 by 1.5 meter, 80cm above ground. The wall of the shielded room was located 40cm to the rear of the EUT.

Power to the EUT was provided through the LISN. The impedance vs. frequency characteristic of the LISN is complied with the limit used.

Both lines (neutral and hot) were connected to the LISN in series at testing. A coaxial-type connector which provides one 50 ohms terminating impedance was provided for connecting the test instrument. The excess length of the power cord was folded back and forth at the center of the lead so as to form a bundle not exceeding 40cm in length.

Any changes made to the configuration, or modifications made to the EUT, during testing are noted in the following test record.

If the EUT is a Personal Computer or a peripheral of personal computer, and the personal computer has an auxiliary AC outlet which can be used for providing power to an external monitor, then all measurements will be made with the monitor power from first the computer-mounted AC outlet and then a floor-mounted AC outlet.

### 6.4.2. Test Procedure

The system was set up as described above, with the EMI diagnostic software running. The main power line conducted EMI tests were run on the hot and neutral conductors of the power cord and the results were recorded. The effect of varying the position of the interface cables has been investigated to find the configuration that produces maximum emission.

At the frequencies where the peak values of the emissions were higher than 6dB below the applicable limits, the emissions were also measured with the quasi-peak detectors. At the frequencies where the quasi-peak values of the emissions were higher than 6dB below the applicable average limits, the emissions were also measured with the average detectors.

The highest emissions were analyzed in details by operating the spectrum analyzer in fixed tuned mode to determine the nature of the emissions and to provide information which could be useful in reducing their amplitude.

### 6.4.3. EMI Receiver/Spectrum Analyzer Configuration (for the frequencies tested)

Frequency Range:	150 KHz--30MHz
Detector Function:	Quasi-Peak/Average
Bandwidth (RBW):	9KHz

6.4.4. Test Data: Power Line Conducted Emissions (Hot)

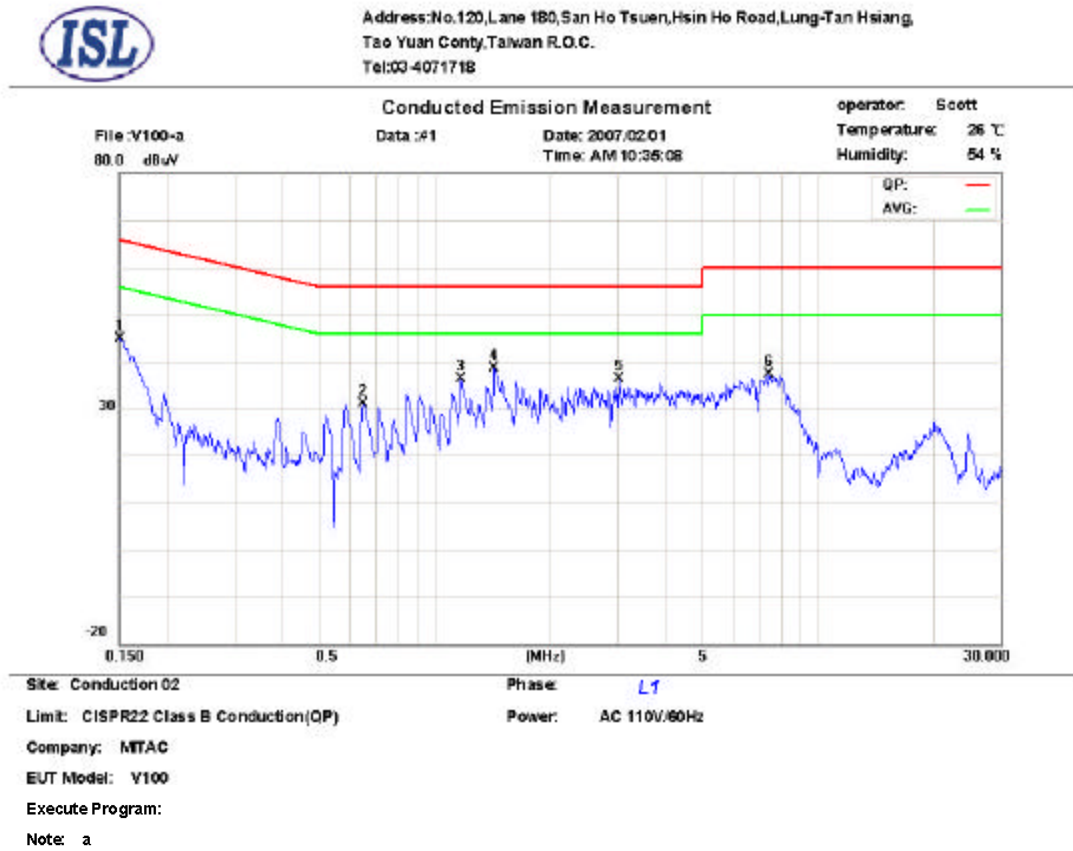

Frequency MHz	LISN Loss dB	Cable Loss dB	QP Correct dBuV	QP Limit dBuV	QP Margin dB	AVG Correct dBuV	AVG Limit dBuV	AVG Margin dB	Note
0.1500	0.1	0.02	43.20	66.0	-22.8	40.00	56.0	-16.0	
0.6474	0.2	0.07	34.30	56.0	-21.7	31.90	46.0	-14.1	
1.1657	0.2	0.07	38.00	56.0	-18.0	34.70	46.0	-11.3	
* 1.4257	0.2	0.08	42.00	56.0	-14.0	37.20	46.0	-8.80	
3.0253	0.3	0.12	26.20	56.0	-29.8	22.20	46.0	-23.8	
7.4465	0.46	0.18	37.80	60.0	-22.2	36.30	50.0	-13.7	

\*:Maximum data x:Over limit

Power Line Conducted Emissions (Neutral)



Address: No.120, Lane 180, San Ho Tsuen, Hsin Ho Road, Lung-Tan Hsiang,  
Tao Yuan Conty, Taiwan R.O.C.  
Tel:09-4071718

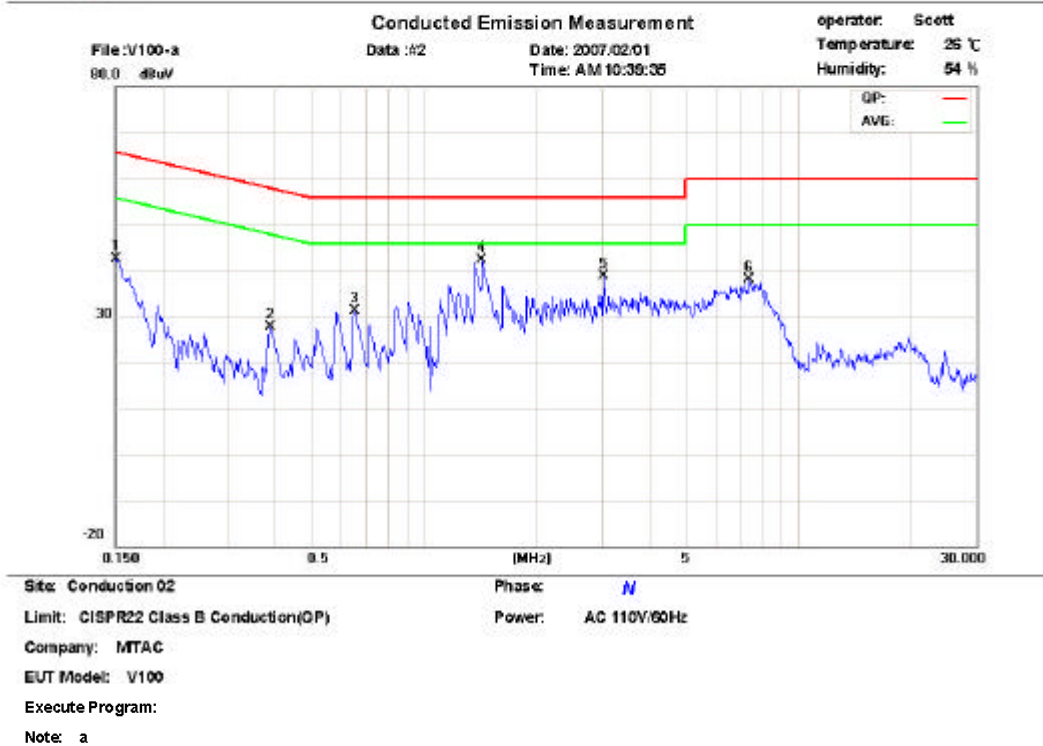

Frequency MHz	LISN Loss dB	Cable Loss dB	OP Correct dBuV	OP Limit dBuV	OP Margin dB	AVG Correct dBuV	AVG Limit dBuV	AVG Margin dB	Note
0.1500	0.1	0.02	42.60	66.0	-23.4	39.60	56.0	-16.4	
0.3893	0.19	0.09	28.70	58.0	-29.3	26.90	48.0	-21.1	
0.6543	0.2	0.07	24.00	56.0	-32.0	19.90	46.0	-26.1	
* 1.4257	0.2	0.08	44.10	56.0	-11.9	40.40	46.0	-5.60	
3.0253	0.2	0.12	26.10	56.0	-29.9	22.40	46.0	-23.6	
7.3680	0.31	0.18	35.40	60.0	-24.6	30.60	50.0	-19.4	

\*:Maximum data    x:Over limit

\* NOTE: Mode and Channel 1, 2, 3,4,5 of Turbo Mode to get the maximum reading of all these channels  
Margin = Amplitude + Insertion Loss- Limit  
A margin of -8dB means that the emission is 8dB below the limit



## 6.5. Radiated Emission Measurement [Section 15.209 & 15.407(b)(5)]

### 6.5.1. EUT Configuration

The equipment under test was set up on the 10 meter chamber with measurement distance of 3 meters. The EUT was placed on a non-conductive table 80cm above ground.

Any changes made to the configuration, or modifications made to the EUT, during testing are noted in the following test record.

### 6.5.2. Test Procedure

The system was set up as described above, with the EMI diagnostic software running. We found the maximum readings by varying the height of antenna and then rotating the turntable. Both polarization of antenna, horizontal and vertical, are measured.

30M to 1GHz: The highest emissions between 30 MHz to 1000 MHz were also analyzed in details by operating the spectrum analyzer and/or EMI receiver in quasi-peak mode to determine the precise amplitude of the emissions. While doing so, the interconnecting cables and major parts of the system were moved around, the antenna height was varied between one and four meters, its polarization was varied between vertical and horizontal, and the turntable was slowly rotated, to maximize the emission.

1GHz – 40GHz: The highest emissions were also analyzed in details by operating the spectrum analyzer and/or EMI receiver in peak mode to determine the precise amplitude of the emission. While doing so, the interconnecting cables and major parts of the system were moved around, the antenna height was varied between one and four meters, its polarization was varied between vertical and horizontal, and the turntable was slowly rotated, to maximize the emission. During test the EMI receiver and spectrum was setup according to para. 6.5.3.

For the test of 2<sup>nd</sup> to 10<sup>th</sup> harmonics frequencies , the equipment setup was also refer to para.6.5.3. The frequencies were tested using Peak mode first, if the test data is higher than the emissions limit, an additional measurement using Average mode will be performed and the average reading will be compared to the limit and record in test report.

### 6.5.3. EMI Receiver/Spectrum Analyzer Configuration

Frequency Range Tested:	30MHz~1000MHz
Detector Function:	Quasi-Peak Mode
Resolution Bandwidth (RBW):	120KHz
Video Bandwidth (VBW)	1MHz
Frequency Range Tested:	1GHz – 40 GHz
Detector Function:	Peak Mode
Resolution Bandwidth (RBW):	1MHz
Video Bandwidth (VBW)	3MHz
Frequency Range Tested:	30MHz – 40 GHz
Detector Function:	Average Mode
Resolution Bandwidth (RBW):	1MHz
Video Bandwidth (VBW)	10 Hz

6.5.4. Test Data (30MHz – 1GHz) .

**30M – 1GHz Open Field Radiated Emissions (Horizontal)**

Operator:JerryChiou  
 Temperature(C):25  
 Humidity(%):63

Frequency MHz	RxAmp. (dBuV)	AntFact (dB/m)	CableLoss (dB)	PreAmpGain (dB)	Corrct.Emi. (dBuV/m)	Limit (dBuV/m)	Margin (dB)	Ant.Pos (cm)	TablePos (deg)
59.1	19.28	6.72	1.33	0.00	27.33	40.00	-12.67	96.00	245.00
68.8	22.93	6.16	1.51	0.00	30.60	40.00	-9.40	96.00	219.00
88.2	23.45	8.54	1.67	0.00	33.66	43.50	-9.84	96.00	219.00
95.96	18.16	9.91	1.79	0.00	29.87	43.50	-13.63	96.00	35.00
99.84	14.61	10.57	1.92	0.00	27.11	43.50	-16.39	96.00	35.00
102.75	14.55	11.10	1.93	0.00	27.57	43.50	-15.93	96.00	61.00
105.66	14.84	11.62	1.93	0.00	28.38	43.50	-15.12	96.00	35.00
111.48	18.73	12.43	1.90	0.00	33.06	43.50	-10.44	96.00	61.00
158.04	21.85	10.12	2.36	0.00	34.33	43.50	-9.17	96.00	219.00
177.44	16.34	9.35	2.49	0.00	28.17	43.50	-15.33	96.00	193.00
197.81	21.01	9.16	2.60	0.00	32.76	43.50	-10.74	96.00	245.00
202.66	22.27	9.17	2.63	0.00	34.07	43.50	-9.43	96.00	245.00

**30M – 1GHz Open Field Radiated Emissions (Vertical)**

Operator:JerryChiou  
 Temperature(C):25  
 Humidity(%):63

Frequency MHz	RxAmp. (dBuV)	AntFact (dB/m)	CableLoss (dB)	PreAmpGain (dB)	Corrct.Emi. (dBuV/m)	Limit (dBuV/m)	Margin (dB)	Ant.Pos (cm)	TablePos. (deg)
70.74	22.55	6.16	1.55	0.00	30.25	40.00	-9.75	96.00	245.00
89.17	23.28	8.73	1.66	0.00	33.68	43.50	-9.82	96.00	219.00
95.96	18.13	9.91	1.79	0.00	29.84	43.50	-13.66	96.00	35.00
105.66	15.46	11.62	1.93	0.00	29.01	43.50	-14.49	96.00	35.00
108.57	14.66	12.14	1.94	0.00	28.74	43.50	-14.76	96.00	61.00
111.48	15.78	12.43	1.90	0.00	30.12	43.50	-13.38	96.00	61.00
155.13	17.70	10.15	2.31	0.00	30.16	43.50	-13.34	96.00	219.00
159.98	17.04	10.10	2.39	0.00	29.53	43.50	-13.97	96.00	219.00
162.89	17.05	9.93	2.39	0.00	29.37	43.50	-14.13	96.00	219.00
197.81	16.45	9.16	2.60	0.00	28.20	43.50	-15.30	96.00	245.00
202.66	16.30	9.17	2.63	0.00	28.10	43.50	-15.40	96.00	245.00
334.58	13.27	14.03	3.30	0.00	30.60	46.00	-15.40	96.00	140.00

\* NOTE: During the pre-test, the EUT has been tested for Channel 1, 4, 5, 8, 9, 12 of Normal Mode and Channel 1, 2, 3, 4, 5 of Turbo mode and transmit from Main and Aux antenna respectively to get all the critical emission frequencies. In the final test all the critical emission frequencies has been tested and the test data are listed above.

Margin=Corrected Amplitude–Limit

Corrected Amplitude = Radiated Amplitude + Antenna Correction Factor + Cable Loss - Pre-Amplifier Gain

A margin of -8dB means that the emission is 8dB below the limit

**All frequencies from 30MHz to 1GHz have been tested**

**6.5.5. Test Data ( 1GHz – 40 GHz, Transmitting ) .**

**1GHz~ 40 GHz (Horizontal), Normal Mode, 5180 MHz**

Operator:JerryChiou

RBW:1MHz  
Humidity(%):57  
Temperature(C):22

Frequency	Rx_R.	Ant_F.	Cab_L.	PreAmpl	Emission	Limit	Margin	A.Tower	T.Table
MHz	dBuV	dB/m	dB	dB	dBuV/m	dBuV/m	dB	cm	deg
7559.84	30.96pk	39.98	2.26	26.51	46.69pk	54.00av	-7.31	100	191

**1GHz~ 40 GHz (Vertical), Normal Mode, 5180 MHz**

Operator:JerryChiou

RBW:1MHz  
Humidity(%):57  
Temperature(C):22

Frequency	Rx_R.	Ant_F.	Cab_L.	PreAmpl	Emission	Limit	Margin	A.Tower	T.Table
MHz	dBuV	dB/m	dB	dB	dBuV/m	dBuV/m	dB	cm	deg
1330.87	43.11pk	26.02	2.21	23.88	47.46pk	54.00av	-6.54	101	89

Note: “ \* ”: Fundamental Frequency

“ pk ”: peak reading

“ av ”: average reading

The Spectrum noise level+Correction Factor<Limit-6 dB

Margin = Corrected Amplitude – Limit

Corrected Amplitude=Radiated Amplitude+Antenna Correction Factor+Cable Loss-Pre-Amplifier Gain

A margin of -8dB means that the emission is 8dB below the limit.

**All frequencies from 1GHz to 40 GHz have been tested.**

**1GHz~ 40 GHz (Horizontal), Normal Mode, 5240 MHz**

Operator:JerryChiou

RBW:1MHz  
Humidity(%):57  
Temperature(C):22

Frequency	Rx_R.	Ant_F.	Cab_L.	PreAmpl	Emission	Limit	Margin	A.Tower	T.Table
MHz	dBuV	dB/m	dB	dB	dBuV/m	dBuV/m	dB	cm	deg
5416.38	35.75pk	35.93	2.83	27.49	47.02pk	54.00av	-6.98	100	120

**1GHz~ 40 GHz (Vertical), Normal Mode, 5240 MHz**

Operator:JerryChiou

RBW:1MHz  
Humidity(%):57  
Temperature(C):22

Frequency	Rx_R.	Ant_F.	Cab_L.	PreAmpl	Emission	Limit	Margin	A.Tower	T.Table
MHz	dBuV	dB/m	dB	dB	dBuV/m	dBuV/m	dB	cm	deg
5035.16	36.24pk	35.63	2.25	27.26	46.86pk	54.00av	-7.14	100	10

Note: “\*” : Fundamental Frequency

“pk”: peak reading

“av”: average reading

The Spectrum noise level+Correction Factor<Limit-6 dB

Margin = Corrected Amplitude – Limit

Corrected Amplitude=Radiated Amplitude+Antenna Correction Factor+Cable Loss-Pre-Amplifier Gain

A margin of -8dB means that the emission is 8dB below the limit.

**All frequencies from 1GHz to 40 GHz have been tested.**

**1GHz~ 40 GHz (Horizontal), Normal Mode, 5260 MHz**

Operator:JerryChiou

RBW:1MHz  
Humidity(%):57  
Temperature(C):22

Frequency	Rx_R.	Ant_F.	Cab_L.	PreAmpl	Emission	Limit	Margin	A.Tower	T.Table
MHz	dBuV	dB/m	dB	dB	dBuV/m	dBuV/m	dB	cm	deg
5042.36	37.30pk	35.63	2.27	27.27	47.93pk	54.00av	-6.07	100	12

**1GHz~ 40 GHz (Vertical), Normal Mode, 5260 MHz**

Operator:JerryChiou

RBW:1MHz  
Humidity(%):57  
Temperature(C):22

Frequency	Rx_R.	Ant_F.	Cab_L.	PreAmpl	Emission	Limit	Margin	A.Tower	T.Table
MHz	dBuV	dB/m	dB	dB	dBuV/m	dBuV/m	dB	cm	deg
5330.07	35.90pk	35.86	2.81	27.44	47.13pk	54.00av	-6.87	100	95

Note: “ \* ”: Fundamental Frequency

“ pk ”: peak reading

“ av ”: average reading

The Spectrum noise level+Correction Factor<Limit-6 dB

Margin = Corrected Amplitude – Limit

Corrected Amplitude=Radiated Amplitude+Antenna Correction Factor+Cable Loss-Pre-Amplifier Gain

A margin of -8dB means that the emission is 8dB below the limit.

**All frequencies from 1GHz to 40 GHz have been tested.**

**1GHz~ 40 GHz (Horizontal), Normal Mode, 5320 MHz**

Operator:JerryChiou

RBW:1MHz  
Humidity(%):57  
Temperature(C):22

Frequency	Rx_R.	Ant_F.	Cab_L.	PreAmpl	Emission	Limit	Margin	A.Tower	T.Table
MHz	dBuV	dB/m	dB	dB	dBuV/m	dBuV/m	dB	cm	deg
5071.13	39.64pk	35.66	2.34	27.28	50.35pk	54.00av	-3.65	100	20

**1GHz~ 40 GHz (Vertical), Normal Mode, 5320 MHz**

Operator:JerryChiou

RBW:1MHz  
Humidity(%):57  
Temperature(C):22

Frequency	Rx_R.	Ant_F.	Cab_L.	PreAmpl	Emission	Limit	Margin	A.Tower	T.Table
MHz	dBuV	dB/m	dB	dB	dBuV/m	dBuV/m	dB	cm	deg
5099.9	38.55pk	35.68	2.40	27.30	49.33pk	54.00av	-4.67	100	29

Note: “ \* ”: Fundamental Frequency

“ pk ”: peak reading

“ av ”: average reading

The Spectrum noise level+Correction Factor<Limit-6 dB

Margin = Corrected Amplitude – Limit

Corrected Amplitude=Radiated Amplitude+Antenna Correction Factor+Cable Loss-Pre-Amplifier Gain

A margin of -8dB means that the emission is 8dB below the limit.

**All frequencies from 1GHz to 40 GHz have been tested.**

**6.6. Band Edge Measurement (Section 15.407 (b) (1) (2))**

**6.6.1. Test Procedure (Conducted)**

1. The Transmitter output of EUT was connected to the spectrum analyzer.  
Equipment mode: Spectrum analyzer

Peak Mode:	
SPAN	100MHz
RBW	1MHz
VBW	1MHz
Sweep Time	200msec.

2. Using Peak Search to read the peak power of Carrier frequencies after Maximum Hold function is completed.
3. Find the next peak frequency outside the operation frequency band.

**6.6.2. Test Setup (Conducted)**

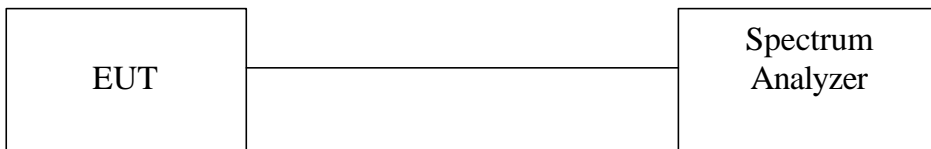

**6.6.3. Test Data (conducted):**

**Band Edge measurement (Conducted)**

Temperature (deg. C): 25

Test Engineer: Jerry Chiou Humidity (%): 50

Outside Channel	Frequency (MHz)	Spectrum Reading (dBuV)	Corrected Factor (dB)	Corrected Emissions (dBuV EIRP)	Limit: (dBuV EIRP)	Pass or Fail
<b>Normal Mode</b>						
1	5145.4	60.07	5.17	65.24	80	Pass
8	5350.4	61.31	5.17	66.48	80	Pass

Note: Corrected Emissions=Spectrum + Corrected Factor  
 Corrected Factor=Cable Loss+Antenna Peak Gain (dBi)

**Band Edge Conducted measurement (Normal Mode Channel 1)**

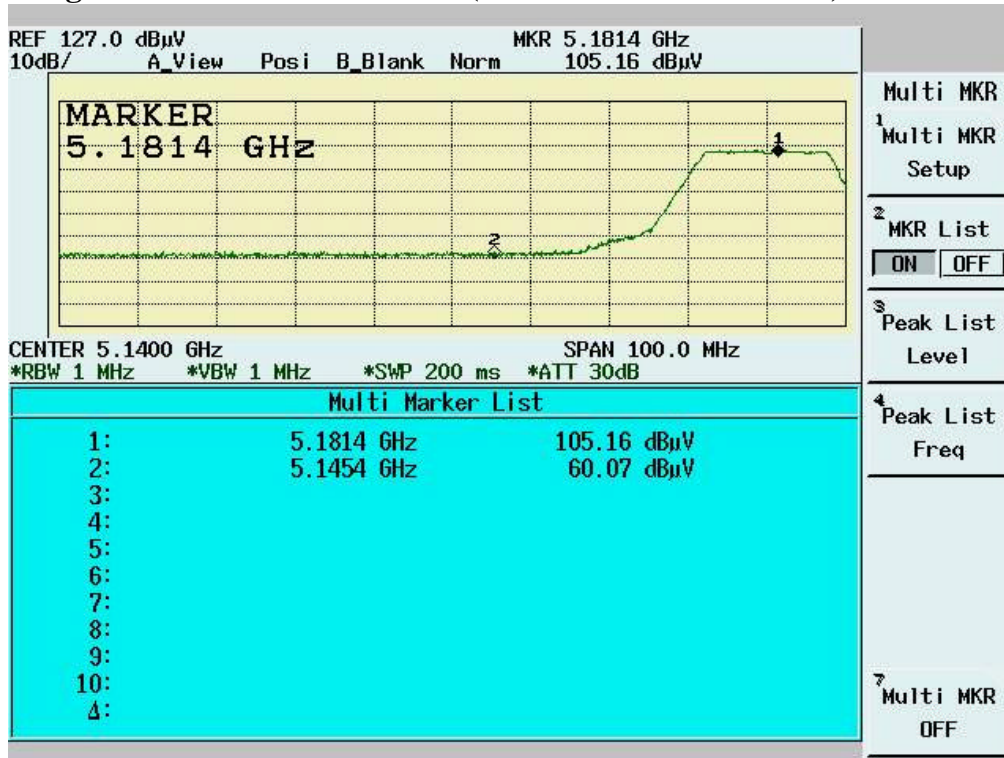

**Band Edge Conducted Measurement (Normal Mode Channel 8)**

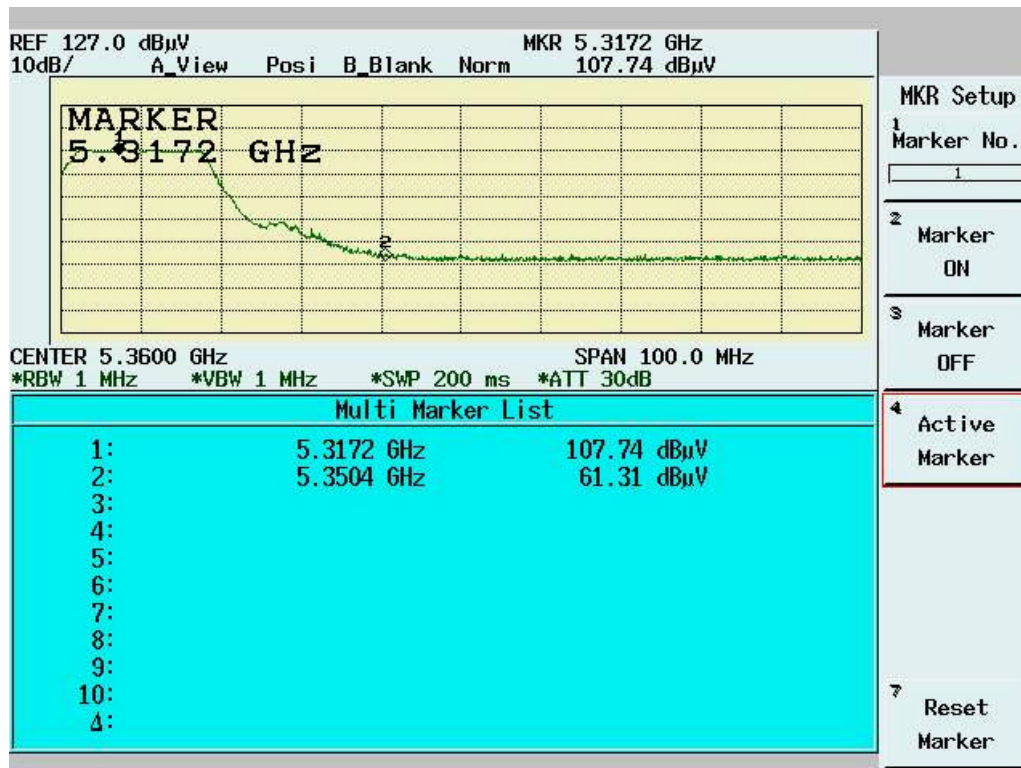



#### 6.6.4. Bandedge Measurement Test Procedure (Radiated)

1. Antenna and Turntable test procedure same as Radiated Emissions measurement listed in Para. 6.5  
Equipment mode: Spectrum analyzer

Peak Mode:	
SPAN	100MHz
RBW	1MHz
VBW	3MHz
Sweep Time	200msec.
AVE Mode:	
SPAN	100MHz
RBW	1MHz
VBW	10Hz
Sweep Time	20 sec.

2. Using Peak Search to read the peak power of Carrier frequencies after Maximun Hold function is completed.
3. Find the next peak frequency outside the operation frequency band.
4. Get the spectrum reading after Maximun Hold function is completed.

### 6.6.5. Test Setup (Radiated)

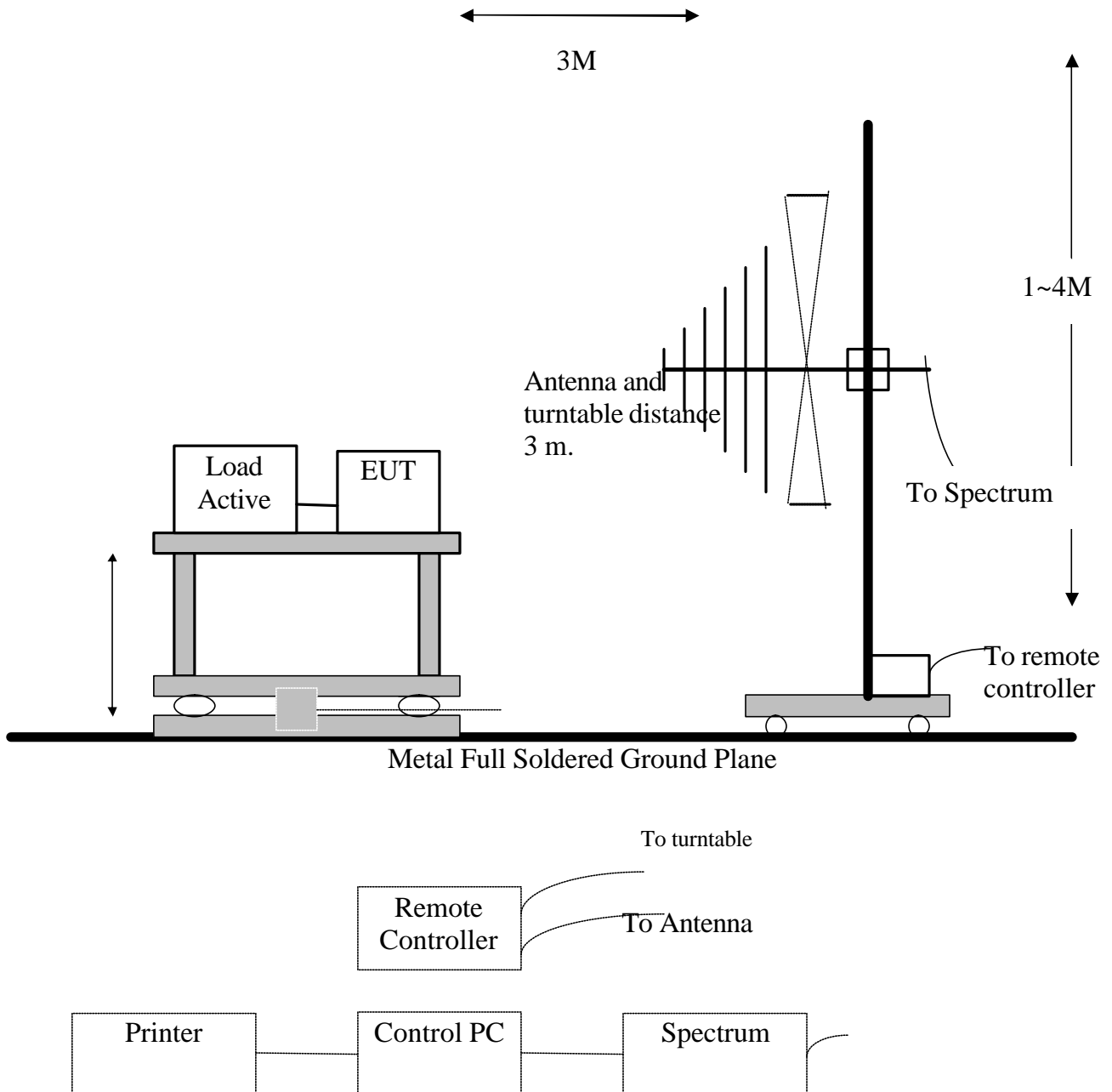

**6.6.6. Test Data (Radiated):**

**Band Edge measurement (Radiated)**

Temperature (deg. C): 25

Test Engineer: Jerry Chiou

Humidity (%): 50

Outside Channel (Normal)	Frequency (MHz)	Spectrum Reading (dBuV)	Correction Factor (dB/m)	Emission Level (dBuV/m)	Limit (dBuV/m)	Pass/Fail
1 (Peak)	5149.7	21.21	39.03	60.24	74	Pass
1 (Average)	5150	8.73	39.03	47.76	54	Pass
8 (Peak)	5350.1	21.51	39.34	60.85	74	Pass
8 (Average)	5350	9.13	39.34	48.47	54	Pass

**Note:** "pk": peak reading  
 "av": average reading  
 Emission Level=Spectrum Reading+Correction Factor  
 Correction Factor =Antenna Factor+cable loss  
 Both Horizontal and Vertical polarization have been tested and the worst data is listed above.

**Restricted Band Radiated measurement –5150MHz**

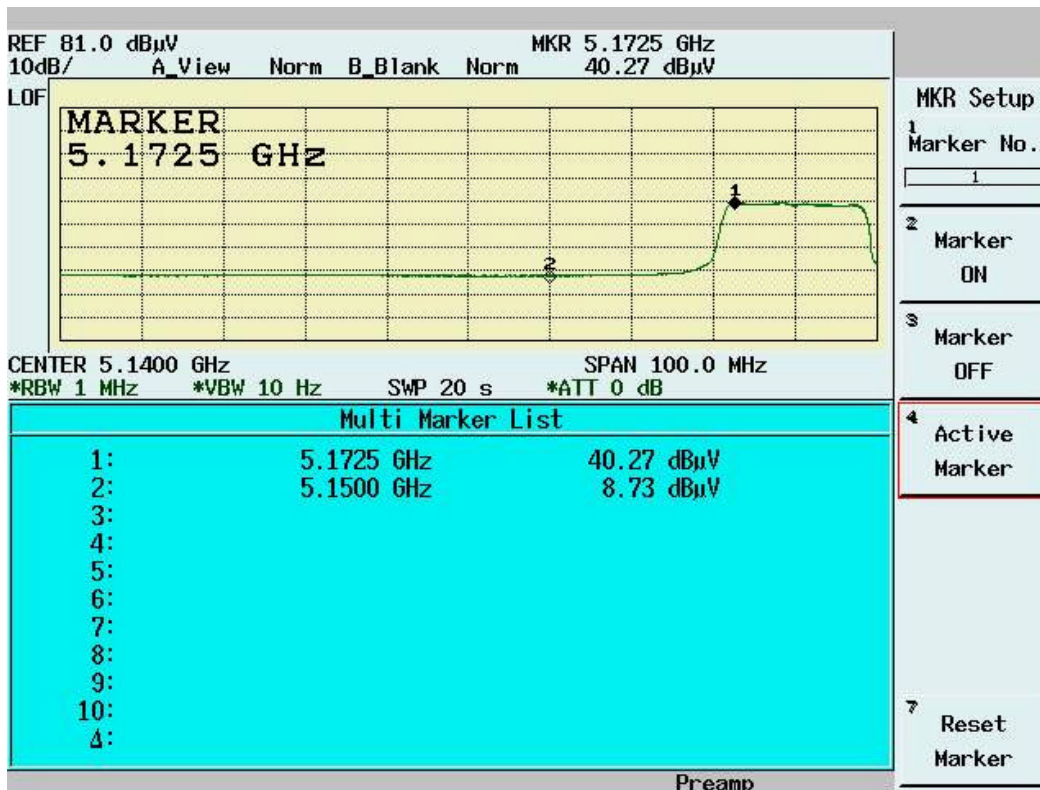
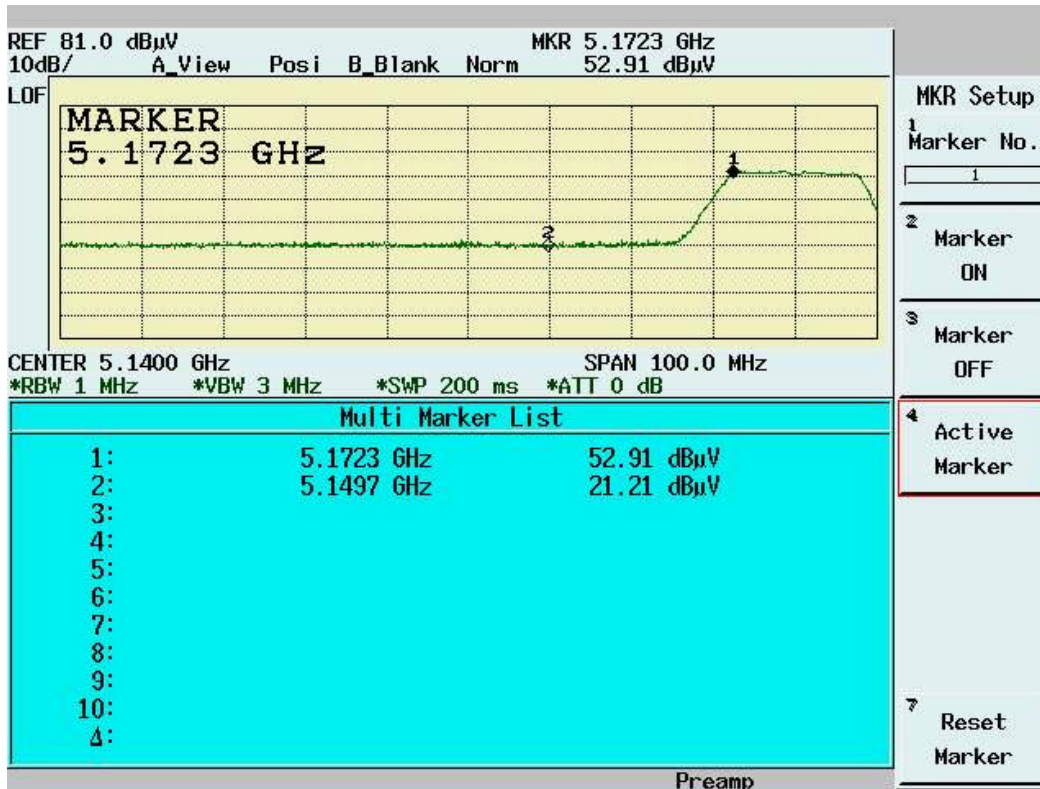

Restricted Band Radiated measurement –5320MHz

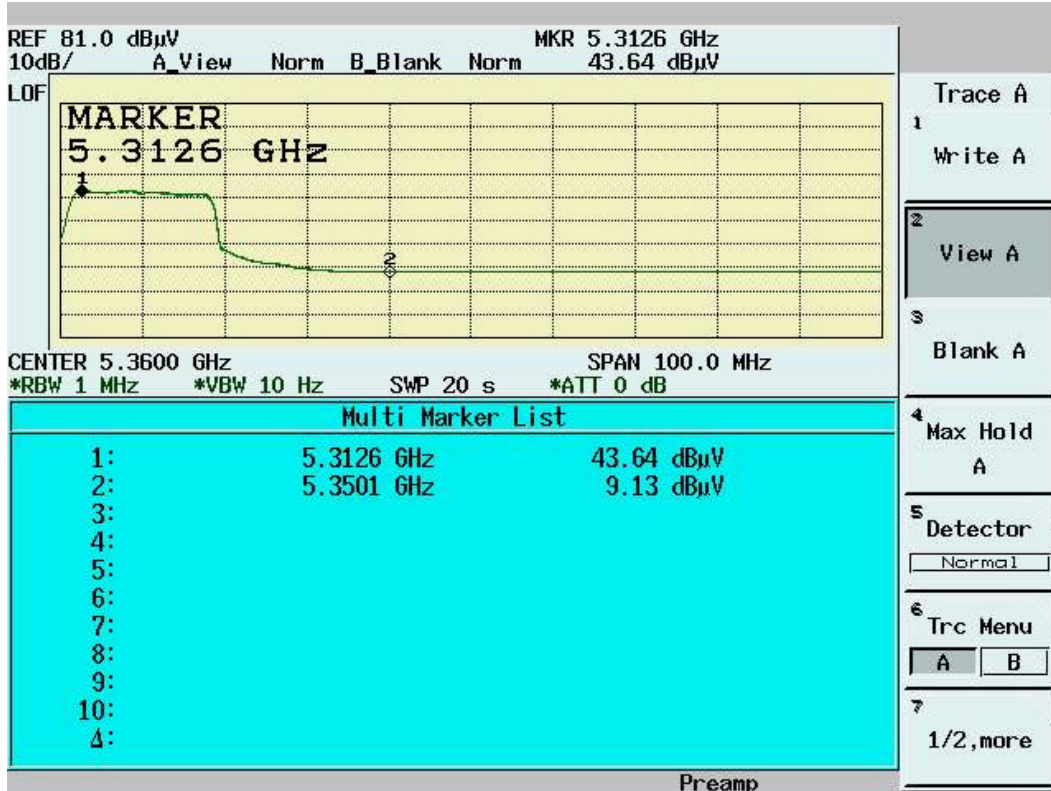
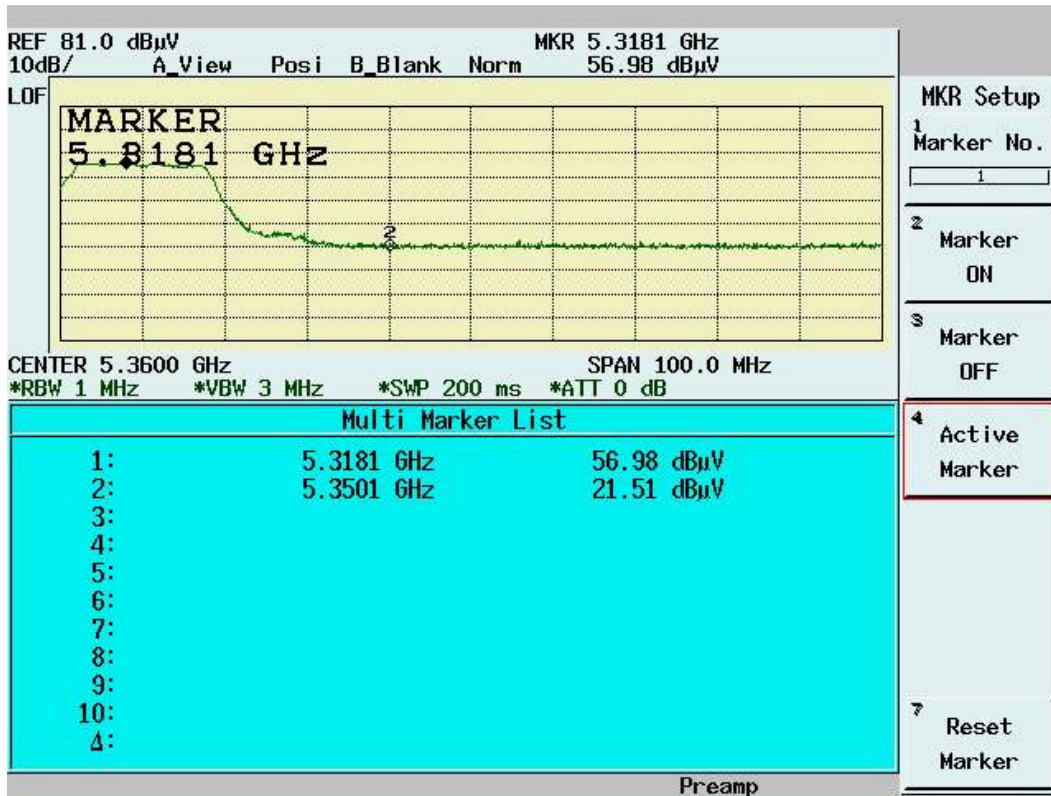

## **6.7. RF Exposure Measurement [Section 15.407(f)(4) & 1.1307(b)]**

Refer to SAR Test Report

## 6.8. Frequency Stability [Section 15.407(g)]

### 6.8.1. Limits of Frequency Stability Measurement

The frequency tolerance of the carrier signal shall be maintained within +/- 0.02% of the operating frequency over the operation temperature range of EUT (0°C~35°C), and variation in the primary supply voltage from 85% to 115% of the rated supply voltage (120V AC) at 20°C.

### 6.8.2. Test Procedure

1. The EUT was placed in the Temperature/Humidity Chamber and powered by a Voltage/Frequency Power converter.
2. Connect the RF output of EUT to Spectrum. Turn on the EUT.
3. Turn the EUT off and set the chamber to the highest temperature specified.
4. Allow sufficient time (approximately 30 min) for the chamber temperature to stabilize. Turn the EUT on and measure the operating frequency after 2, 5, 10 minutes.
5. Set the Voltage/Frequency Power Converter to 85% and 115% of supply voltage, then repeat step 2, 3, 4 respectively.
6. Repeat step 2, 3, 4, 5 with the temperature of chamber set to the lowest temperature.
7. Repeat step 2, 3, 4, 5 with the temperature of chamber set to 20°C.

### 6.8.3. Test Setup

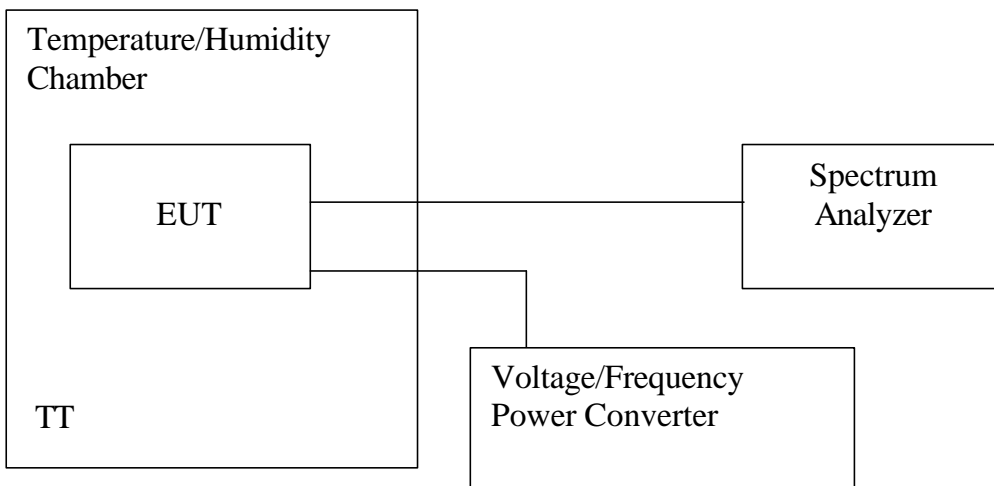

### 6.8.4. Test Data

Test Engineer: Jerry Chiou

Operating Frequency:		5320 (Mhz)							
Temp.	Power Supply	0 minutes		2 minutes		5 minutes		10 minutes	
( <sup>0</sup> C)	(V AC)	(MHz)	(%)	(MHz)	(%)	(MHz)	(%)	(MHz)	
50	138	5319.9620	-0.0007	5319.9610	-0.0007	5319.9720	-0.0005	5319.9410	-0.0011
	120	5319.9660	-0.0006	5319.9460	-0.0010	5319.9810	-0.0004	5319.9620	-0.0007
	102	5319.9640	-0.0007	5319.9410	-0.0011	5319.9820	-0.0003	5319.9660	-0.0006
20	138	5319.9420	-0.0011	5319.9600	-0.0008	5319.9730	-0.0005	5319.9610	-0.0007
	120	5319.9420	-0.0011	5319.9640	-0.0007	5319.9560	-0.0008	5319.9980	0.0000
	102	5319.9410	-0.0011	5319.9580	-0.0008	5319.9340	-0.0012	5319.9660	-0.0006
-30	138	5319.9690	-0.0006	5319.9640	-0.0007	5320.0290	0.0005	5319.9520	-0.0009
	120	5319.9600	-0.0008	5319.9550	-0.0008	5319.9810	-0.0004	5319.9930	-0.0001
	102	5319.9570	-0.0008	5319.9950	-0.0001	5319.9960	-0.0001	5319.9940	-0.0001



## 6.9. Transmitter Power Control (TPC)

### 6.9.1. Limit:

Frequency Range (MHz)	Mean EIRP Limit (Highest power level)	Mean EIRP Limit (Lowest power level)
5150 - 5350, 5470 - 5725	30 dBm e.i.r.p.	24 dBm e.i.r.p.
5150 - 5350, 5470 - 5725	Less than 27 dBm e.i.r.p.	NA.

### 6.9.2. Test data

Temp. ( ):25

Test Engr: Jerry Chiou

Humidity (%):55

Test conditions	Effective Radiated Power (dBm e.i.r.p.)			
	5180Mhz	5240Mhz	5260Mhz	5320Mhz
	AV	AV	AV	AV
<b>Highest Power Level</b>	11.39	13.85	13.43	12.61
<b>Lowest Power Level</b>	NA	NA	NA	NA

Note1: Measurement uncertainty=+/-0.5dB

Note 2: AV=Average Power

## 6.10. Dynamic Frequency Selection (DFS)

Refer to DFS Test Report

## 7. Appendix

### 7.1. Appendix A: Measurement Procedure for Power line Conducted Emissions

The measurements are performed in a 3.5m x 3.4m x 2.5m shielded room, which referred as Conduction 01 test site, or a 3m x 3m x 2.3m test site, which referred as Conduction 02 test site. The EUT was placed on non-conduction 1.0m x 1.5m table, which is 0.8 meters above an earth-grounded.

Power to the EUT was provided through the LISN which has the Impedance (50ohm/50uH) vs. Frequency Characteristic in accordance with the required standard. Power to the LISNs were filtered to eliminate ambient signal interference and these filters were bonded to the ground plane. Peripheral equipment required to provide a functional system (support equipment) for EUT testing was powered from the second LISN through a ganged, metal power outlet box which is bonded to the ground plane at the LISN.

If the EUT is supplied with a flexible power cord, the power cord length in excess of the distance separating the EUT from the LISN shall be folded back and forth at the center of the lead so as to form a bundle not exceeding 40cm in length. If the EUT is provided with a permanently coiled power cord, bundling of the cord is not required. If the EUT is supplied without a power cord, the EUT shall be connected to the LISN by a power cord of the type specified by the manufacturer which shall not be longer than 1 meter. The excess power cord shall be bundled as described above. If a non-flexible power cord is provided with the EUT, it shall be cut to the length necessary to attach the EUT to the LISN and shall not be bundled.

The interconnecting cables were arranged and moved to get the maximum emission. Both the line of power cord, hot and neutral, were measured.

The highest emissions were analyzed in details by operating the spectrum analyzer in fixed tuned mode to determine the nature of the emissions and to provide information which could be useful in reducing their amplitude.

## 7.2. Appendix B: Test Procedure for Radiated Emissions

### Preliminary Measurements in the Anechoic Chamber

The radiated emissions are initially measured in the anechoic chamber at a measurement distance of 3 meters. Desktop EUT are placed on a wooden stand 0.8 meter in height. The measurement antenna is 3 meters from the EUT. The test setup in anechoic chamber is the same as open site. The turntable rotated 360°. The antenna height is varied from 1-2.5m. The primary objective of the radiated measurements in the anechoic chamber is to identify the frequency spectrum in the absence of the electromagnetic environment existing on the open test site. The frequencies can then be pre-selected on the open test site to obtain the corresponding amplitude. The initial scan is made with the spectrum analyzer in automatic sweep mode. The spectrum peaks are then measured manually to determine the exact frequencies.

### Measurements on the Open Site or 10m EMC Chamber

The radiated emissions test will then be repeated on the open site or 10m EMC chamber to measure the amplitudes accurately and without the multiple reflections existing in the shielded room. The EUT and support equipment are set up on the turntable of one of the 3 or 10 meter open field sites. Desktop EUT are set up on a wooden stand 0.8 meter above the ground.

For the initial measurements, the receiving antenna is varied from 1-4 meter height and is changed in the vertical plane from vertical to horizontal polarization at each frequency. Both readings are recorded with the quasi-peak detector with 120KHz bandwidth. For frequency between 30 MHz and 1000MHz, the reading is recorded with peak detector or quasi-peak detector. For frequency above 1 GHz, the reading is recorded with peak detector or average detector with 1 MHz bandwidth.

At the highest amplitudes observed, the EUT is rotated in the horizontal plane while changing the antenna polarization in the vertical plane to maximize the reading. The interconnecting cables were arranged and moved to get the maximum emission. Once the maximum reading is obtained, the antenna elevation and polarization will be varied between specified limits to maximize the readings.

### 7.3. Appendix C: Test Equipment

#### Test Equipment List

Location	Equipment Name	Brand	Model	S/N	Last Cal. Date	Next Cal. Date
Conduction	Coaxial Cable 1F-C2	Harbourindustries	RG400	1F-C2	05/20/2006	05/20/2007
Conduction	Digital Hygro-Thermometer Conduct	MicroLife	HT-2126G	ISL-Conduction02	11/30/2006	11/30/2007
Conduction	EMI Receiver 02	HP	85460A	3448A00183	10/01/2006	10/01/2007
Conduction	LISN 01	R&S	ESH2-Z5	890485/013	05/05/2006	05/05/2007
Conduction	LISN 06	R&S	ESH3-Z5	828874/009	12/13/2006	12/13/2007
Radiation	BILOG Antenna 08	Schaffner	CBL6112B	2756	06/07/2006	06/07/2007
Radiation	Coaxial Cable Chmb 02-10M	Belden	RG-8/U	Chmb 02-10M	12/28/2006	12/28/2007
Radiation	Digital Hygro-Thermometer Chmb 02	MicroLife	HT-2126G	Chmb 02	11/30/2006	12/30/2007
Radiation	EMI Receiver 03	HP	85460A	3448A00209	04/01/2006	04/01/2007
Radiation	Spectrum Analyzer 13	Advantest	R3132	121200411	02/17/2006	02/17/2007
Radiation	Horn Antenna 02	Com-Power	AH-118	10088	07/22/2006	07/22/2006
Radiation	Horn Antenna 04	Com-Power	AH-826	081-001	01/13/2006	01/13/2007
Radiation	Horn Antenna 05	Com-Power	AH-640	100A	09/30/2006	09/30/2007
Radiation	Microwave Cable RF SK-01	HUBER+SUHNERAG.	Sucoflex 102	22139 /2	07/07/2006	07/07/2007
Chamber 05	Peak Power Analyzer	HP	8990A	3621A01269	03/28/2006	03/28/2007
Chamber 05	Power Sensor Radar	HP	84815A	3318A01828	03/28/2006	03/28/2007
Radiation	Preamplifier 02	MITEQ	AFS44-00102 650-40-10P-44	728229	11/28/2006	11/28/2007
Radiation	Preamplifier 10	MITEQ	JS-26004000-27-5A	818471	11/22/2006	11/22/2007
Radiation	High Pass Filter 01	HEWLETT-PACKARD	84300-80038	001	N/A	N/A
Radiation	High Pass Filter 02	HEWLETT-PACKARD	84300-80039	005	N/A	N/A
Radiation	Spectrum Analyzer 14	Advantest	R3182	140600028	11/22/2006	11/22/2007

Note: Calibration is traceable to NIST or national or international standards.

#### Software for Controlling Spectrum/Receiver and Calculating Test Data

Radiation/Conduction	Filename	Version	Issued Date
Conduction	Tile.exe	1.12E	7/7/2000
Radiation	Tile.exe	1.12C	6/16/2000

### 7.4. Appendix D: Layout of EUT and Support Equipment

#### General Conducted Test Configuration

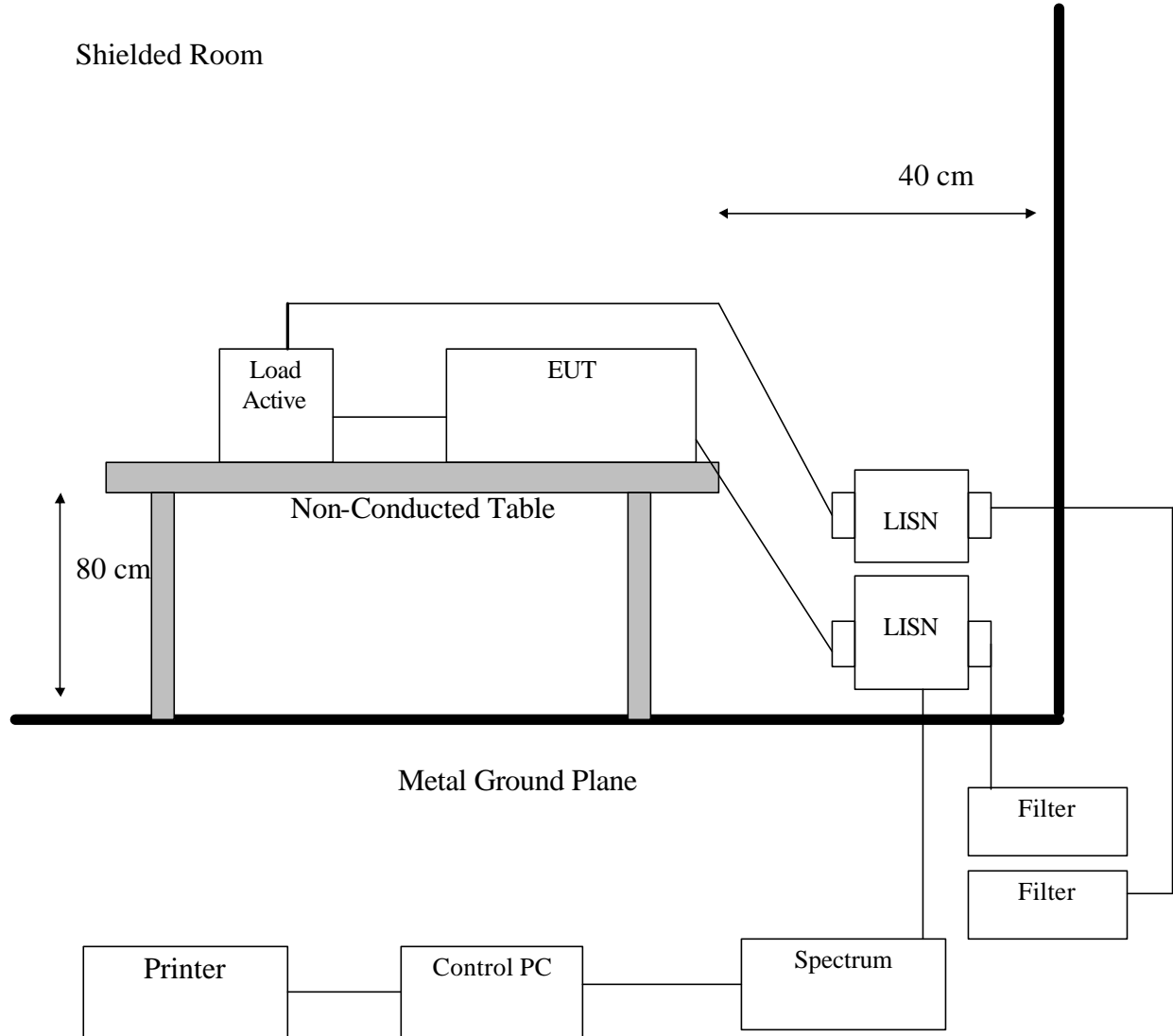

**General Radiation Test Configuration**

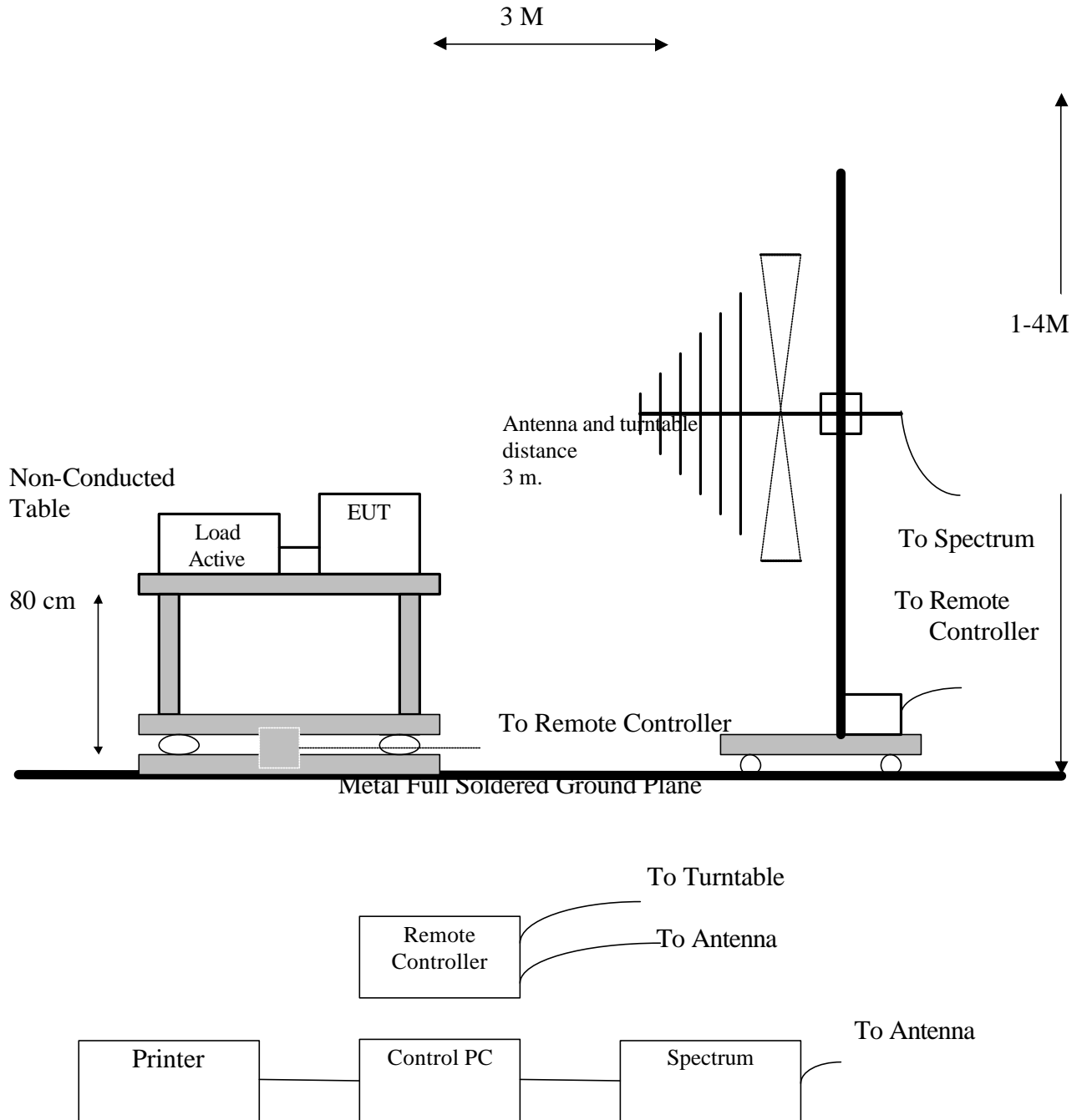

## 7.5. Appendix E: Description of Support Equipment

### Description of Support Equipment

#### Support Unit 1.

Description:	Aceex Modem (for serial interface port)
Model Number:	DM1414
Serial Number:	0301000558
Power Supply Type:	Linear, Power Adapter ( AC to AC Xfmr, Wall Mounted Type )
Power Cord:	Nonshielded, Without Grounding Pin
FCC ID:	IFAXDM1414

#### Support Unit 2.

Description:	Aceex Modem (for serial interface port)
Model Number:	DM1414
Serial Number:	0301000557
Power Supply Type:	Linear, Power Adapter ( AC to AC Xfmr, Wall Mounted Type )
Power Cord:	Nonshielded, Without Grounding Pin
FCC ID:	IFAXDM1414

#### Support Unit 3.

Description:	External Hard Disk Case
Manufacturer :	TeraSys
Model Number:	F12-UF
Serial Number	NA
Power Supply Type:	YHI(Model:YS-1015U12)
1394 Port:	one 6-Pins
USB:	one 4-Pins
Power In:	one
Power Cable:	Non-shielded, Detachable, (Can Dismantle)



## Support Unit 4.

Description:	External Hard Disk Case
Manufacturer :	TeraSys
Model Number:	F12-UF
Serial Number	NA
Power Supply Type:	YHI(Model:YS-1015U12)
1394 Port:	one 6-Pins
USB:	one 4-Pins
Power In:	one
Power Cable:	Non-shielded, Detachable, (Can Dismantle)

## Support Unit 5.

Description:	ATA Microphone and HeadSet
Model Number:	1221K
Serial Number:	N/A
Power Supply Type:	N/A
Power Cord:	N/A
FCC ID:	N/A

### Software for Controlling Support Unit

Test programs exercising various part of EUT were used. The programs were executed as follows:

- A. Read and write to the disk drives.
- B. Send H pattern to the serial port device (Modem).
- C. Send H pattern to the serial port device (Modem).
- D. Read and write data the external hard disk through EUT USB port.
- E. Send audio signal to the Microphone and HeadSet through Headphone Port.
- F. Receive audio signal from Microphone and HeadSet through Microphone Port.
- G. The RF software makes the transmitter continuously sending RF signals
- H. Repeat the above steps.

	Filename	Issued Date
CRTU 3945ABG version 4.0.18.0000	CRTU.exe	2005/10/16
Modem 1	Hm.bat	8/20/1991
Modem 1	Hm.bat	8/20/1991
Headphone	Wmplay.exe	12/16/2002

**I/O Cable Condition of EUT and Support Units**

Description	Path	Cable Length	Cable Type	Connector Type
AC Power Cord	110V (~240V) to AC Power Cord Inlet (3-pin)	1.8M	Nonshielded, Detachable	Plastic Head
Modem Data Cable*2	Modem to PC COM 1 port	1.5M	Shielded, Detachable	Metal Head
USB Data Cable*2	USB external hard disk to EUT USB Port	1.8M	Shielded, Un-detachable	Metal Head
Audio Data Cable	Microphone and HeadSet to EUT Line In Port and Line Out Port	1.8M	Non-shielded, Un-Detachable	Plastic Head

### 7.6. Appendix F: Accuracy of Measurement

Test Site: Conduction 02

Item	Source of Uncertainty	Probability Distribution	Total Uncertainties (dB)		Standard Uncertainty (dB)	
			k	Value	k	Value
1	Systematic Effects: (Assessment from 20 repeat observation; 1 reading on EUT)	Normal	k=2	0.104	k=1	0.052
2	Random Effects: (Assessment from 20 random observations; 1 reading on EUT)	Normal	k=2	0.330	k=1	0.165
3	Receiver Calibration	Rectangular	k=1.73	1.000	k=1	0.577
4	LISN Factor Calibration	Normal	k=2	1.200	k=1	0.600
5	Cable Loss Calibration	Normal	k=2	1.000	k=1	0.500
6	Combined Standard Uncertainty $U_c(y)$	Normal			k=1	0.850
7	<b>Total Uncertainty @95% mim. Confidence Level</b>	<b>Normal</b>	<b>k=2</b>	<b>1.701</b>		

Measurement Uncertainty Calculations:

$$U_c(y) = \text{square root} ( u_1(y)^2 + u_2(y)^2 + \dots + u_n(y)^2 )$$

$$U = 2 * U_c(y)$$

Note: The measurement Uncertainties mentioned above also refer to NIS 81-1994 of NAMAS :  
The treatment of Uncertainty in EMC Measurement.

Test Site: Chamber 02-3M

Item	Source of Uncertainty	Probability Distribution	Total Uncertainties (dB)		Standard Uncertainty (dB)	
			k	Value	k	Value
1	Systematic Effects: (Assessment from 20 repeat observation; 1 reading on EUT)	Normal	k=2	0.067	k=1	0.034
2	Random Effects: (Assessment from 20 random observations; 1 reading on EUT)	Normal	k=2	0.103	k=1	0.052
3	Receiver Calibration	Rectangular	k=1.73	1.000	k=1	0.577
4	Antenna Factor Calibration	Normal	k=2	1.700	k=1	0.850
5	Cable Loss Calibration	Normal	k=2	1.000	k=1	0.500
6	Combined Standard Uncertainty Uc(y)	Normal			k=1	1.029
7	<b>Total Uncertainty @95% mim. Confidence Level</b>	<b>Normal</b>	<b>k=2</b>	<b>2.059</b>		

Measurement Uncertainty Calculations:

$$U_c(y) = \text{square root} ( u_1(y)^2 + u_2(y)^2 + \dots + u_n(y)^2 )$$

$$U = 2 * U_c(y)$$

Note: The measurement Uncertainties mentioned above also refer to NIS 81-1994 of NAMAS :  
The treatment of Uncertainty in EMC Measurement.

## 7.7. Appendix G: Photographs of EUT Configuration Test Set Up

The Front View of Highest Conducted Set-up For EUT

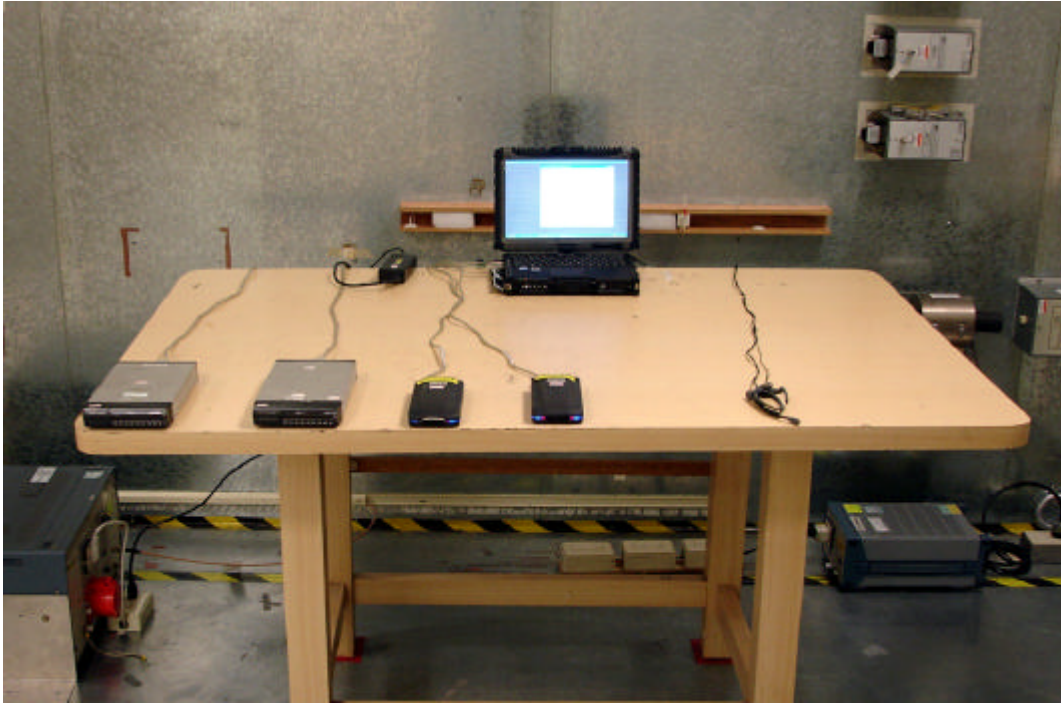

The Back View of Highest Conducted Set-up For EUT

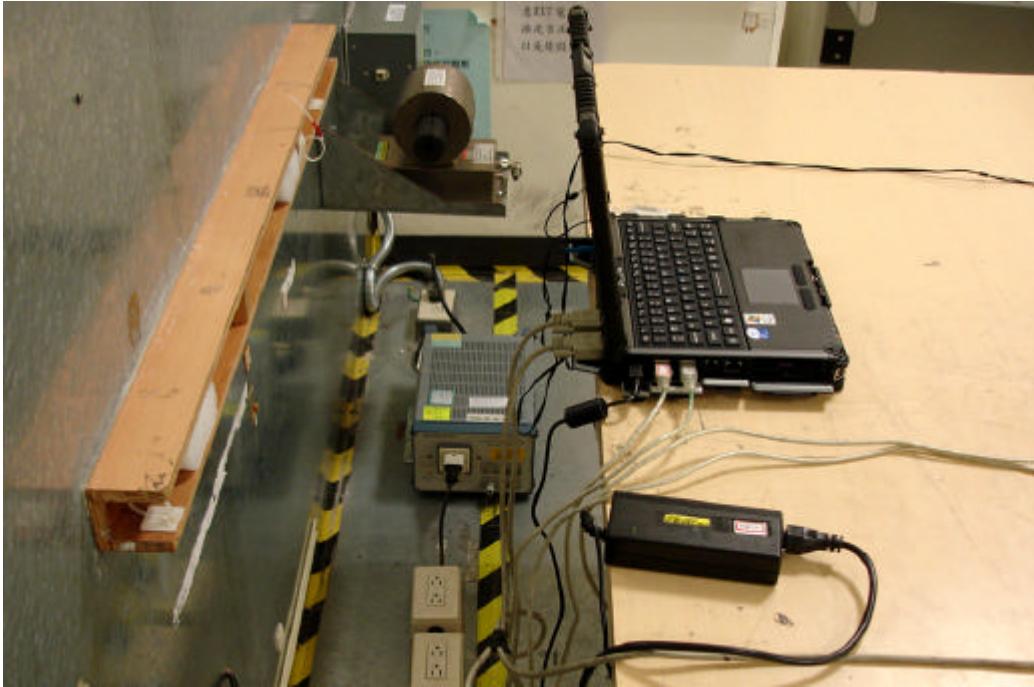

The Front View of Highest Radiated Set-up For EUT

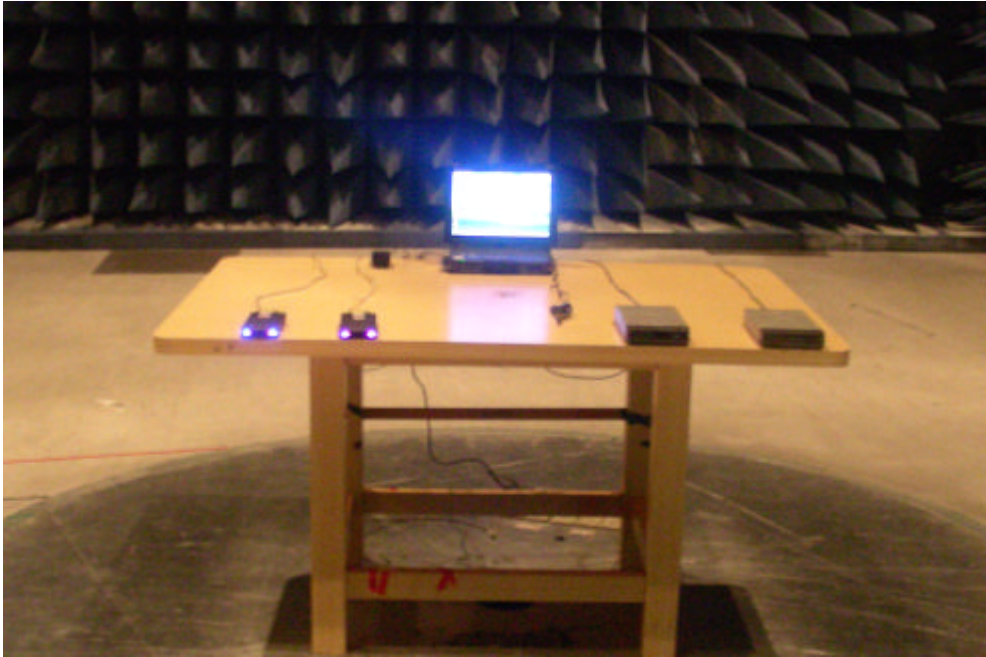

The Back View of Highest Radiated Set-up For EUT

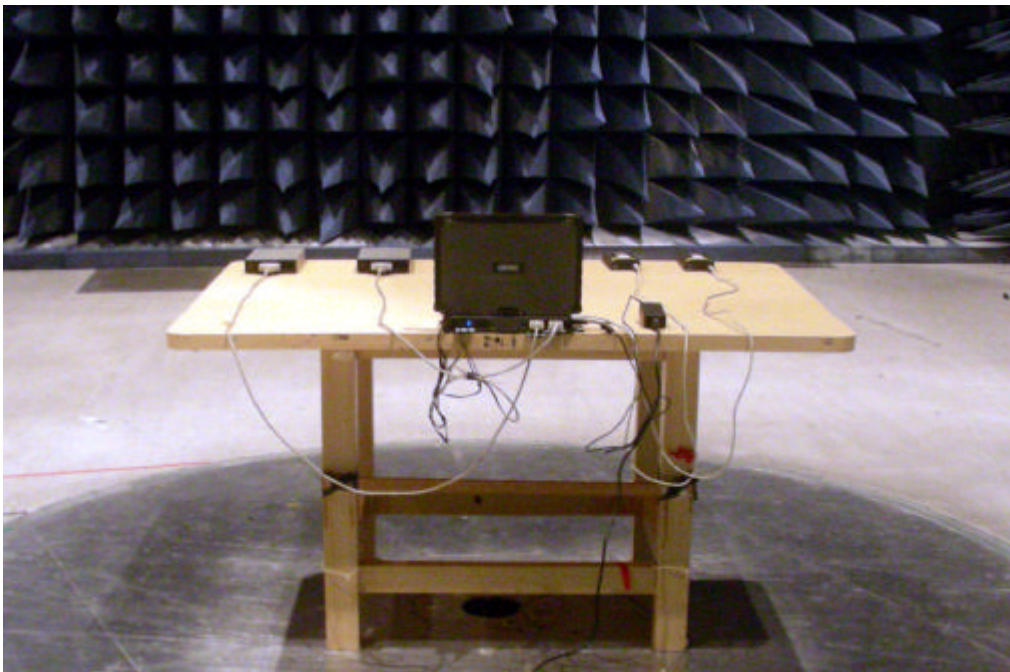



## 7.8. Appendix H: Antenna Spec.

Please refer to the attached file.