

Appendix D

SAR measurement Data

of

Product Name

Notebook Personal Computer

Model

V100



1 SAR measurement Data

SAR Test Report

Report Date : 25-Jan-2007
Measurement Date : 25-Jan-2007

Product Data

Device Name : V100
Serial No. : 11.b-Back
Type : Other
Frequency : 2450.00 MHz
Max. Transmit Pwr : 0.028 W
Drift Time : 0 min(s)
Length : 225 mm
Width : 290 mm
Depth : 5 mm
Antenna Type : Internal

Phantom Data

Name : APREL-Uni
Type : Uni-Phantom
Size (mm) : 280 x 280 x 200
Location : Center

Tissue Data

Type : BODY
Serial No. : 2450BODY
Frequency : 2450.00 MHz
Last Calib. Date : 25-Jan-2007
Temperature : 21.60 °C
Ambient Temp. : 21.80 °C
Humidity : 43.00 RH%
Epsilon : 51.28 F/m
Sigma : 1.98 S/m
Density : 1000.00 kg/cu. m

Probe Data

Name : E-field Probe
Model : ALS-E-020
Type : E-Field Triangle
Serial No. : 266
Last Calib. Date : 22-Jun-2006
Frequency : 2450.00 MHz
Duty Cycle Factor: 1
Conversion Factor: 5.02
Probe Sensitivity: 1.20 1.20 1.20 $\mu\text{V}/(\text{V}/\text{m})^2$
Compression Point: 95.00 mV
Offset : 2.44 mm

1.1 2450 MHz 802.11b Main Ant. , EUT Position: Back

Measurement Data

Crest Factor : 1
Area Scan : 5x8x1 : Measurement x=15mm, y=15mm, z=4mm
Zoom Scan : 7x7x7 : Measurement x=5mm, y=5mm, z=5mm

DUT Position : Touch
Channel : Low - 2412MHz

Power Drift-Start : 0.030 W/kg
Power Drift-Finish: 0.029 W/kg
Power Drift (%) : -3.169

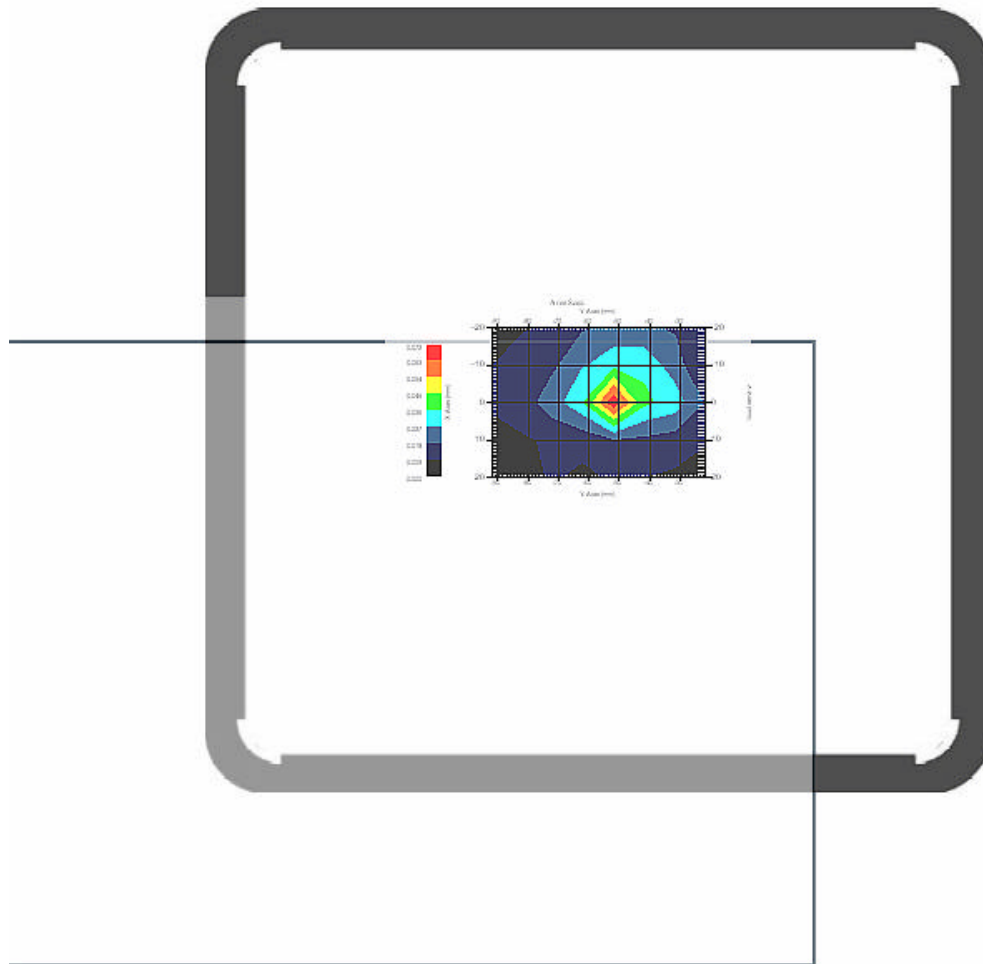

1 gram SAR value : 0.065 W/kg
10 gram SAR value : 0.035 W/kg
Area Scan Peak SAR : 0.070 W/kg
Zoom Scan Peak SAR : 0.120 W/kg

Area Scan Plot

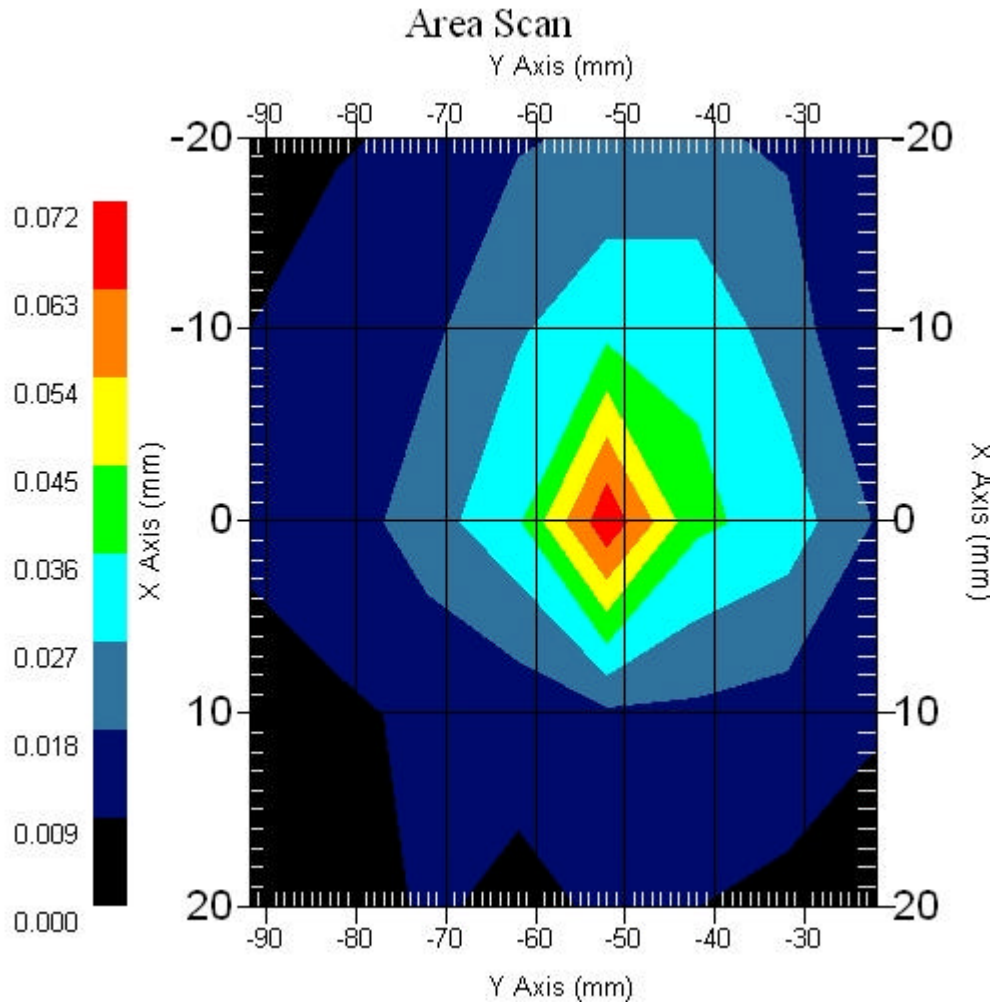

1.2 2450 MHz 802.11b Main Ant. , EUT Position: Back

Measurement Data

Crest Factor : 1
Area Scan : 5x7x1 : Measurement x=10mm, y=10mm, z=4mm
Zoom Scan : 7x7x7 : Measurement x=5mm, y=5mm, z=5mm

DUT Position : Touch
Channel : Mid - 2437MHz

Power Drift-Start : 0.047 W/kg
Power Drift-Finish: 0.045 W/kg
Power Drift (%) : -3.256

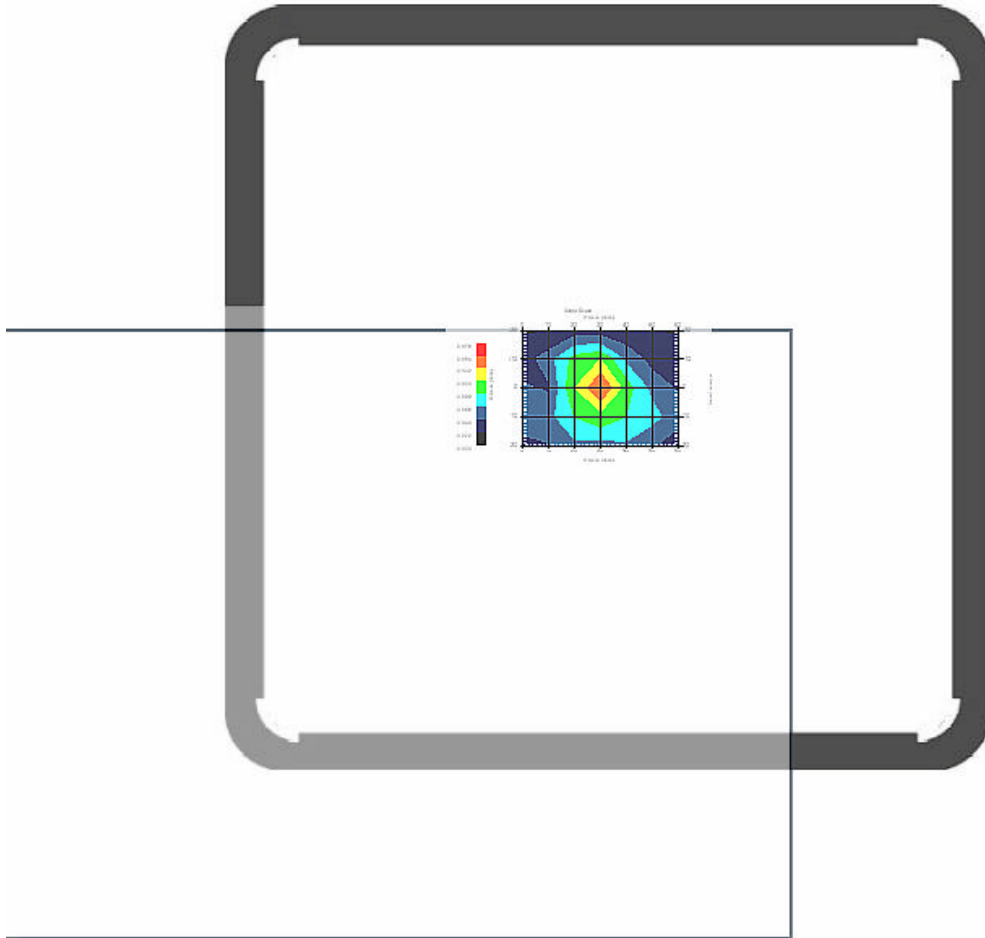

1 gram SAR value : 0.130 W/kg
10 gram SAR value : 0.071 W/kg
Area Scan Peak SAR : 0.155 W/kg
Zoom Scan Peak SAR : 0.240 W/kg

Area Scan Plot

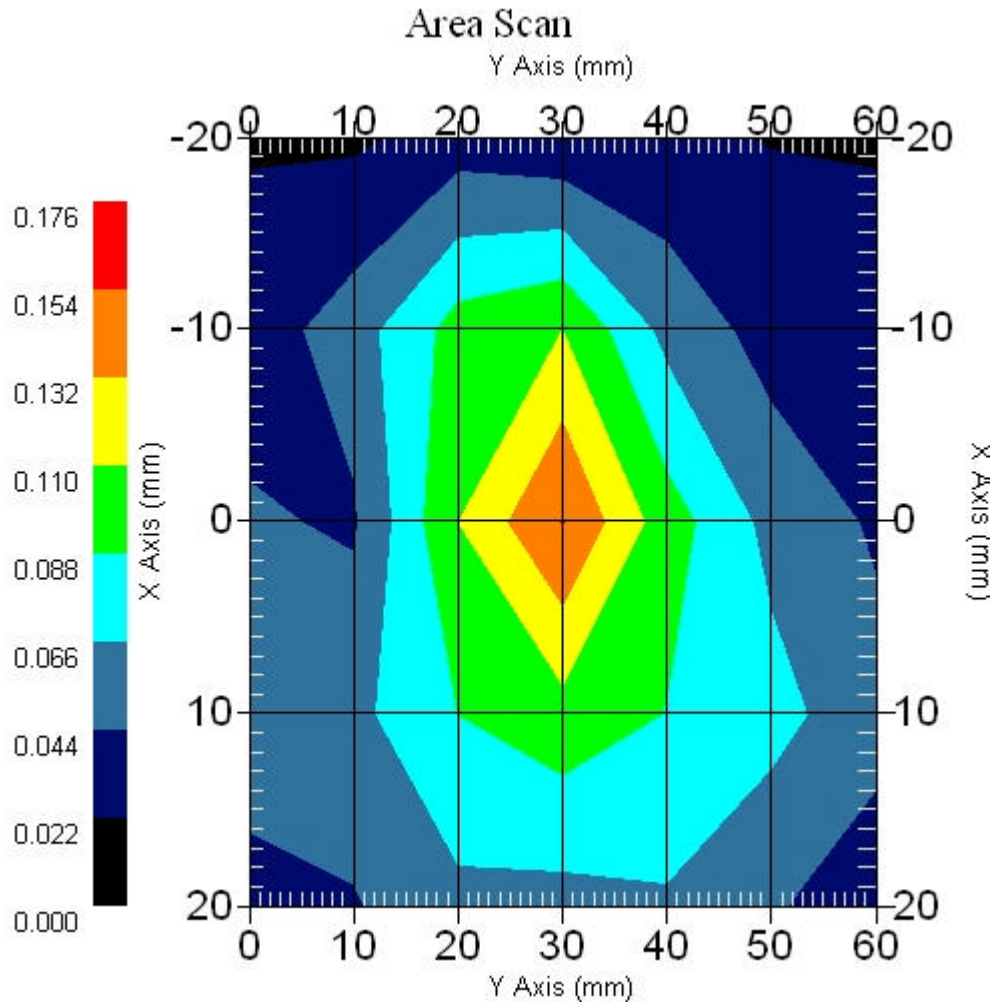

1.3 2450 MHz 802.11b Main Ant. , EUT Position: Back

Measurement Data

Crest Factor : 1
Area Scan : 5x7x1 : Measurement x=10mm, y=10mm, z=4mm
Zoom Scan : 7x7x7 : Measurement x=5mm, y=5mm, z=5mm

DUT Position : Touch
Channel : High - 2462MHz

Power Drift-Start : 0.039 W/kg
Power Drift-Finish: 0.038 W/kg
Power Drift (%) : -2.568

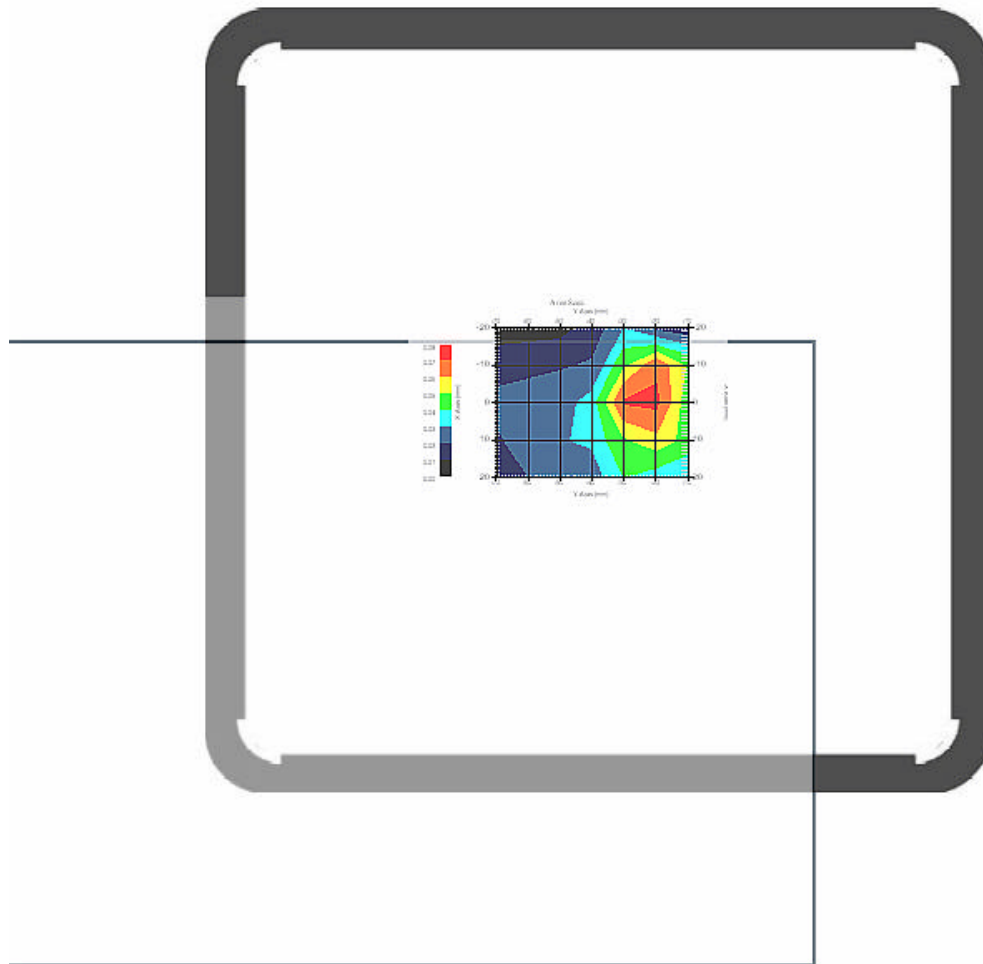

1 gram SAR value : 0.068 W/kg
10 gram SAR value : 0.036 W/kg
Area Scan Peak SAR : 0.073 W/kg
Zoom Scan Peak SAR : 0.140 W/kg

Area Scan Plot

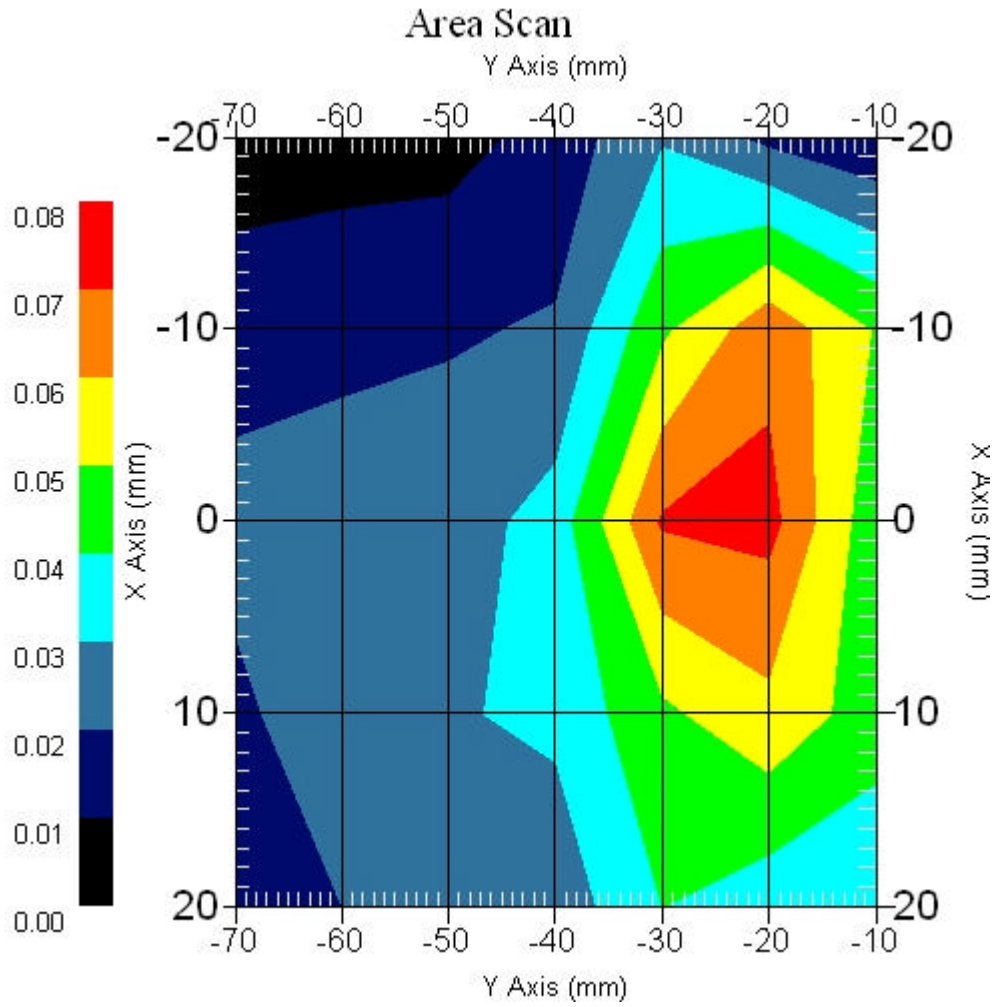

1.4 2450 MHz 802.11b Main Ant. , EUT Position: Top

Measurement Data

Crest Factor : 1
Area Scan : 5x8x1 : Measurement x=15mm, y=15mm, z=4mm
Zoom Scan : 7x7x7 : Measurement x=5mm, y=5mm, z=5mm

DUT Position : Touch
Channel : Mid - 2437MHz

Power Drift-Start : 0.020 W/kg
Power Drift-Finish: 0.020 W/kg
Power Drift (%) : -1.631

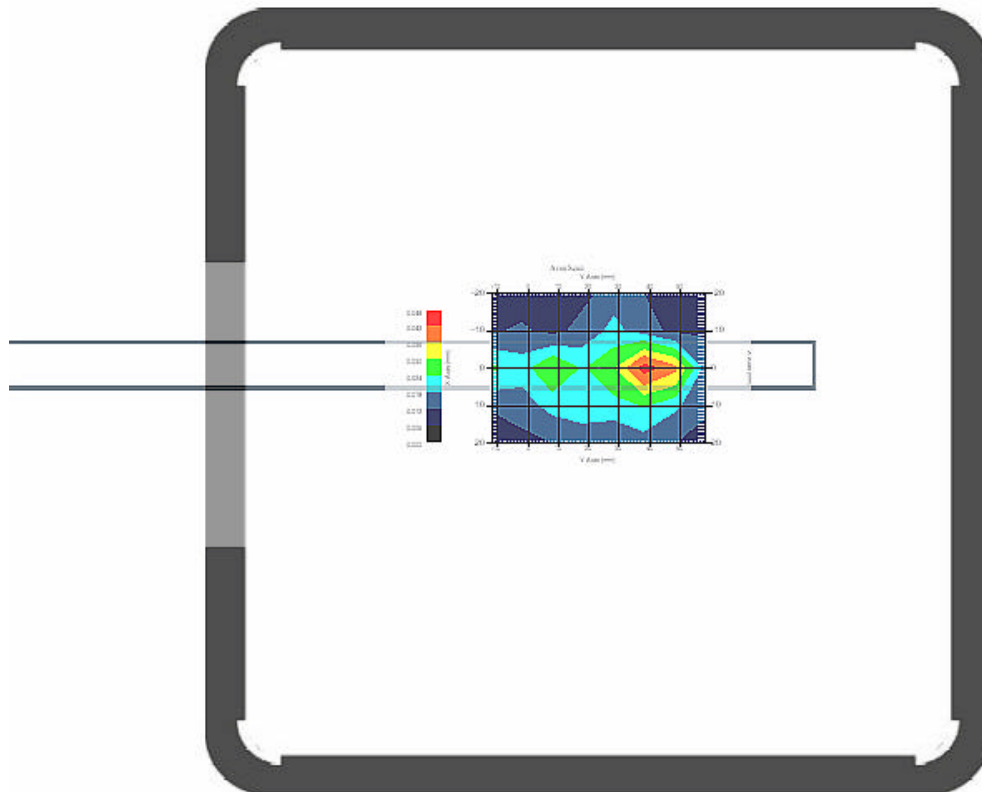

1 gram SAR value : 0.043 W/kg
10 gram SAR value : 0.028 W/kg
Area Scan Peak SAR : 0.045 W/kg
Zoom Scan Peak SAR : 0.090 W/kg

Area Scan Plot

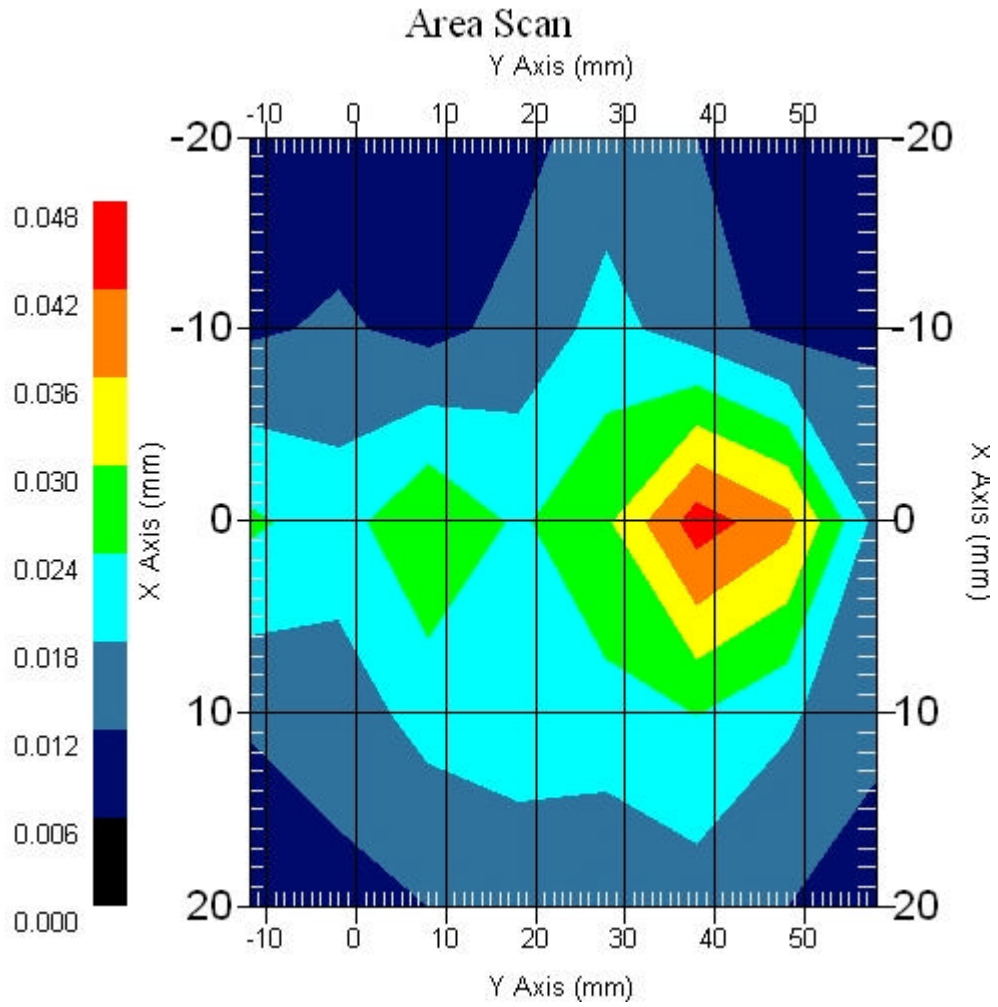

1.5 2450 MHz 802.11b Main Ant. , EUT Position: Front

Measurement Data

Crest Factor : 1
Area Scan : 3x8x1 : Measurement x=15mm, y=15mm, z=4mm
Zoom Scan : 7x7x7 : Measurement x=5mm, y=5mm, z=5mm

DUT Position : Touch
Channel : Mid - 2437MHz

Power Drift-Start : 0.028 W/kg
Power Drift-Finish: 0.027 W/kg
Power Drift (%) : -3.571

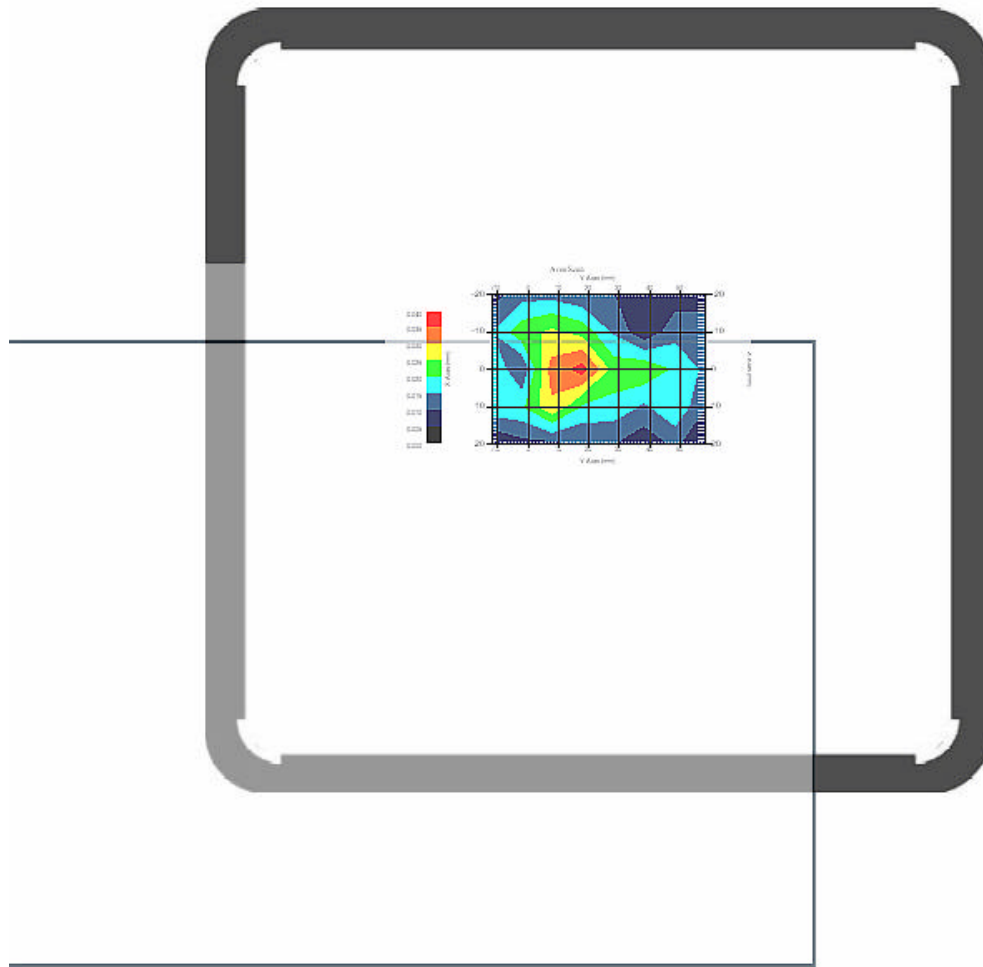

1 gram SAR value : 0.040 W/kg
10 gram SAR value : 0.029 W/kg
Area Scan Peak SAR : 0.037 W/kg
Zoom Scan Peak SAR : 0.070 W/kg

Area Scan Plot

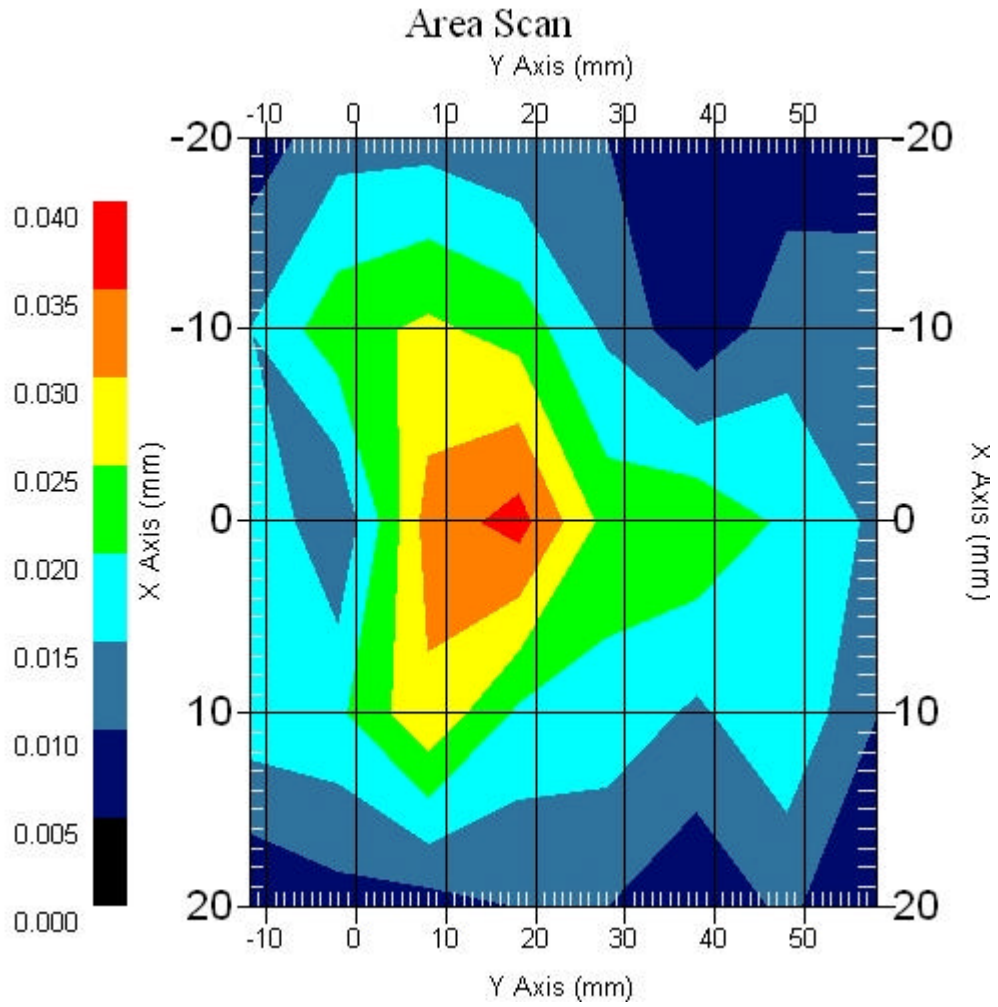

1.6 2450 MHz 802.11b Aux. Ant. , EUT Position: Back

Measurement Data

Crest Factor : 1
Area Scan : 5x7x1 : Measurement x=15mm, y=15mm, z=4mm
Zoom Scan : 7x7x7 : Measurement x=5mm, y=5mm, z=5mm

DUT Position : Touch
Channel : Mid - 2437MHz

Power Drift-Start : 0.028 W/kg
Power Drift-Finish: 0.027 W/kg
Power Drift (%) : -2.949

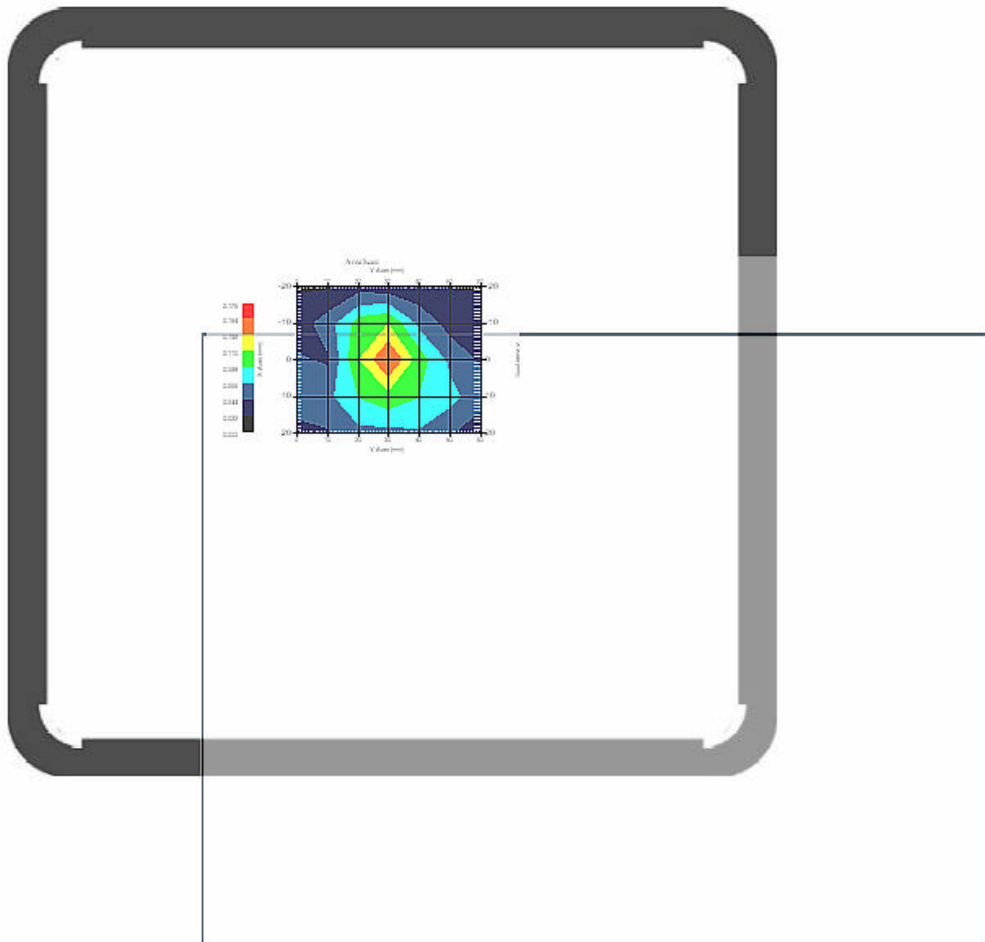

1 gram SAR value : 0.059 W/kg
10 gram SAR value : 0.035 W/kg
Area Scan Peak SAR : 0.053 W/kg
Zoom Scan Peak SAR : 0.100 W/kg

Area Scan Plot

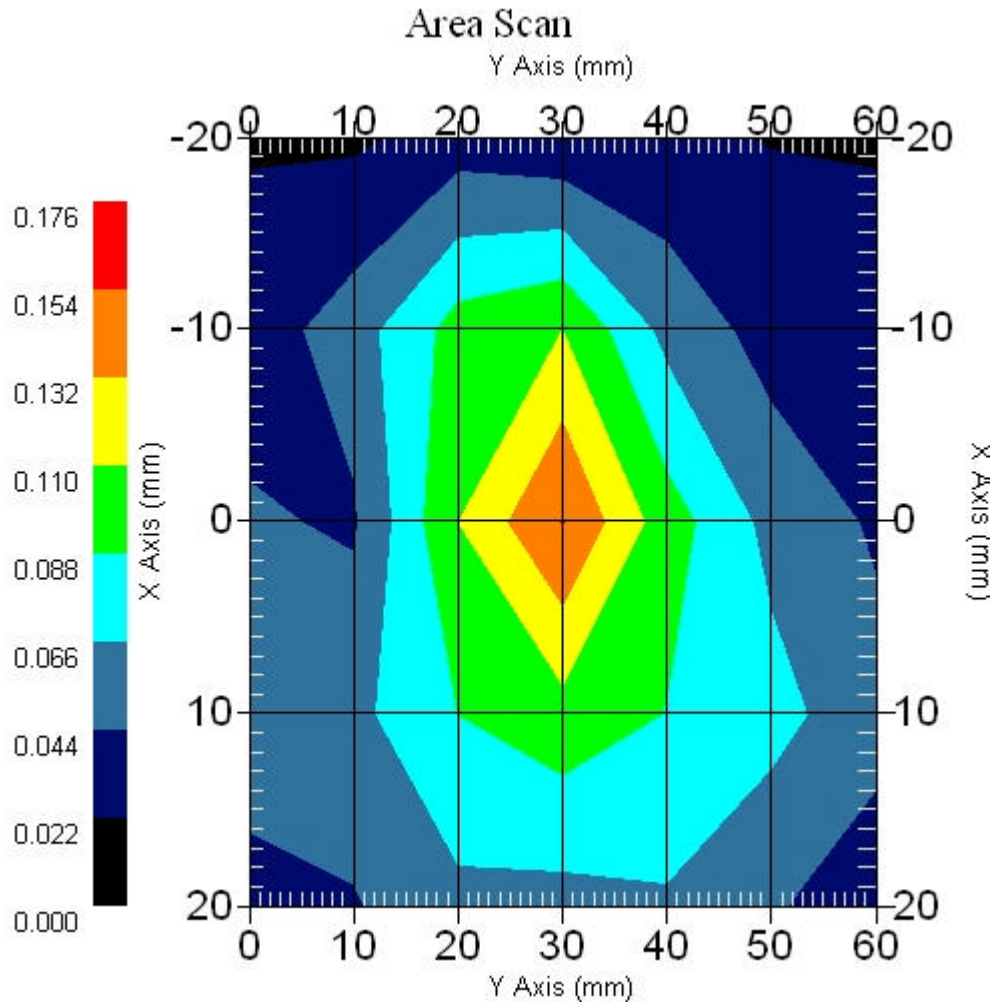

1.8 Z-Axis plot

Frequency: 2450 MHz 802.11b Main Ant. , EUT Position: Back

SAR-Z Axis
at Hotspot x:0.20 y:29.70

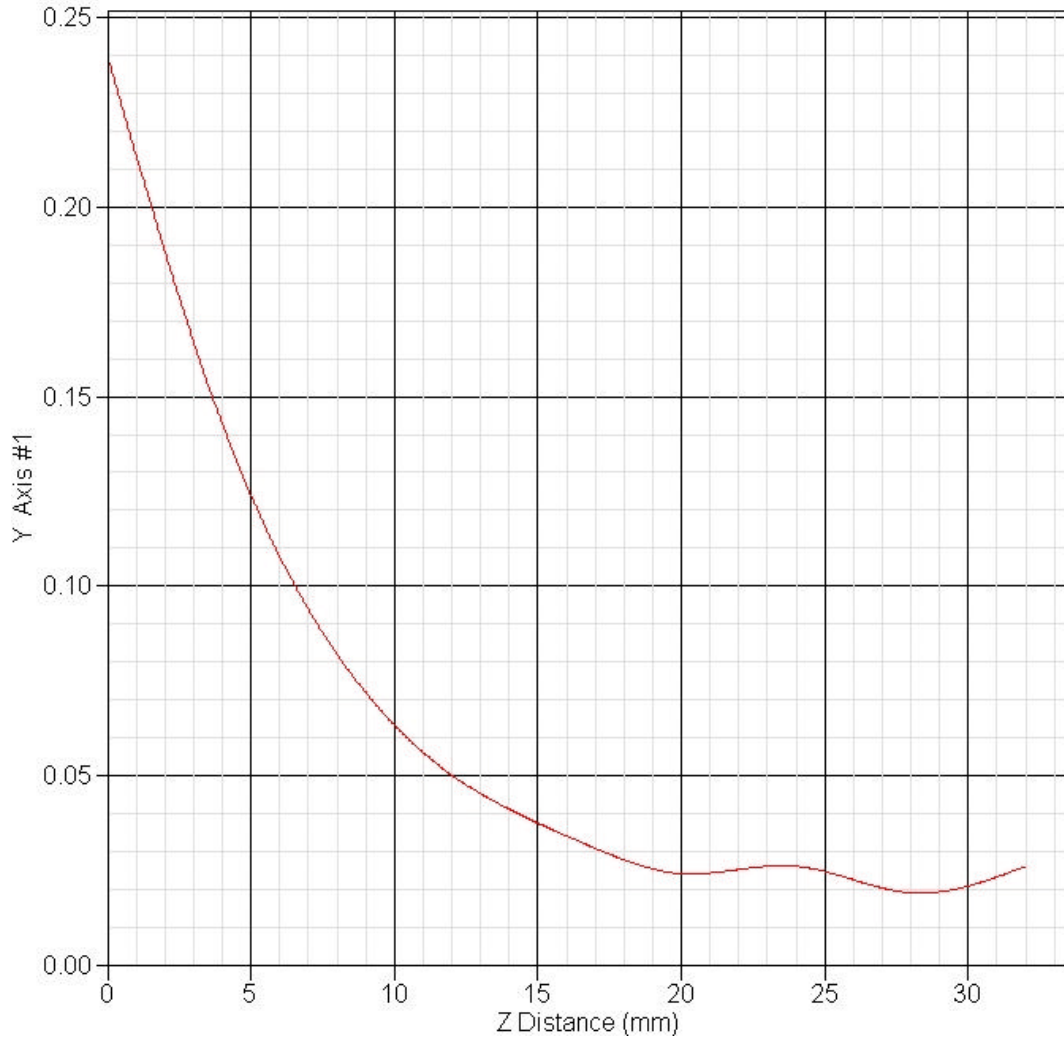



2 SAR measurement Data

SAR Test Report

Report Date : 25-Jan-2007
Measurement Date : 25-Jan-2007

Product Data

Device Name : V100
Serial No. : 11.g-Back
Type : Other
Frequency : 2450.00 MHz
Max. Transmit Pwr : 0.03 W
Drift Time : 0 min(s)
Length : 225 mm
Width : 290 mm
Depth : 5 mm
Antenna Type : Internal

Phantom Data

Name : APREL-Uni
Type : Uni-Phantom
Size (mm) : 280 x 280 x 200
Location : Center

Tissue Data

Type : BODY
Serial No. : 2450BODY
Frequency : 2450.00 MHz
Last Calib. Date : 25-Jan-2007
Temperature : 21.60 °C
Ambient Temp. : 21.80 °C
Humidity : 43.00 RH%
Epsilon : 51.28 F/m
Sigma : 1.98 S/m
Density : 1000.00 kg/cu. m

Probe Data

Name : E-field Probe
Model : ALS-E-020
Type : E-Field Triangle
Serial No. : 266
Last Calib. Date : 22-Jun-2006
Frequency : 2450.00 MHz
Duty Cycle Factor: 1
Conversion Factor: 5.02
Probe Sensitivity: 1.20 1.20 1.20 $\mu\text{V}/(\text{V}/\text{m})^2$
Compression Point: 95.00 mV
Offset : 1.56 mm

2.1 2450 MHz 802.11g Main Ant. , EUT Position: Back

Measurement Data

Crest Factor : 1
Area Scan : 5x7x1 : Measurement x=10mm, y=10mm, z=4mm
Zoom Scan : 7x7x7 : Measurement x=5mm, y=5mm, z=5mm

DUT Position : Touch
Channel : Low - 2412Mhz

Power Drift-Start : 0.106 W/kg
Power Drift-Finish: 0.104 W/kg
Power Drift (%) : -1.869

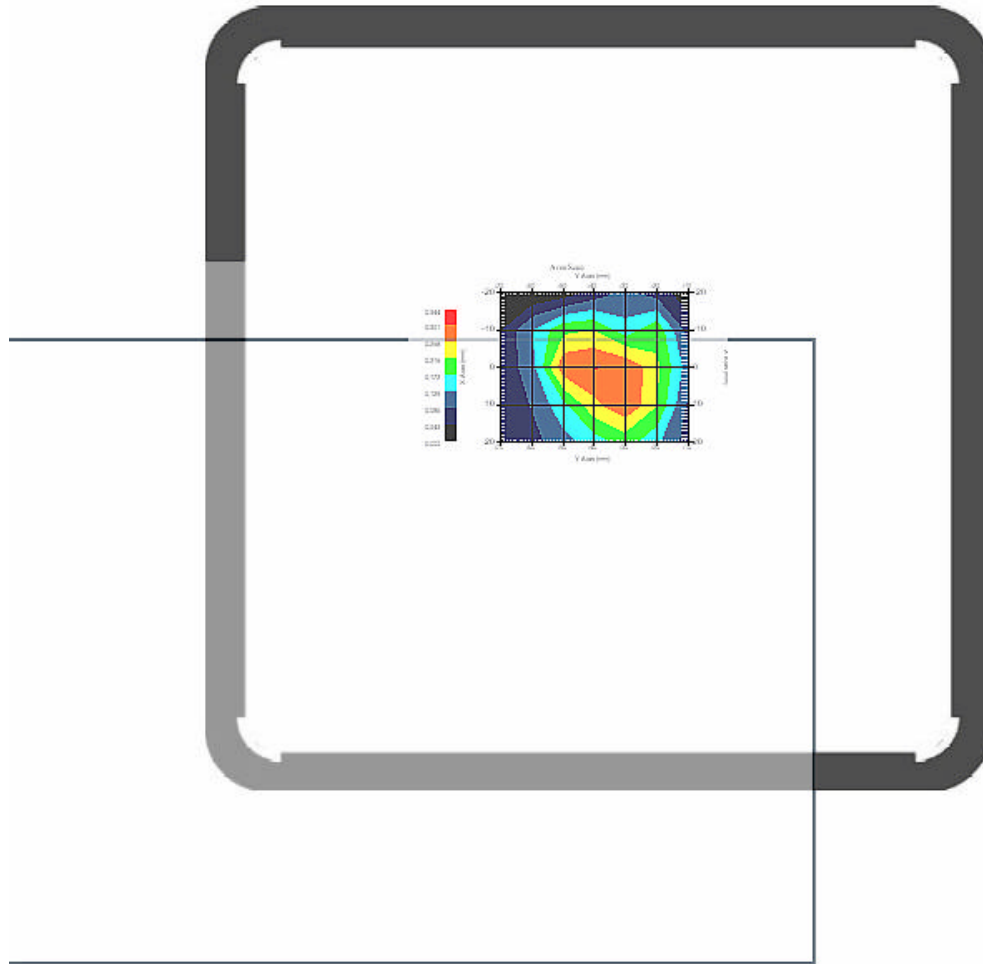

1 gram SAR value : 0.339 W/kg
10 gram SAR value : 0.182 W/kg
Area Scan Peak SAR : 0.303 W/kg
Zoom Scan Peak SAR : 0.614 W/kg

Area Scan Plot

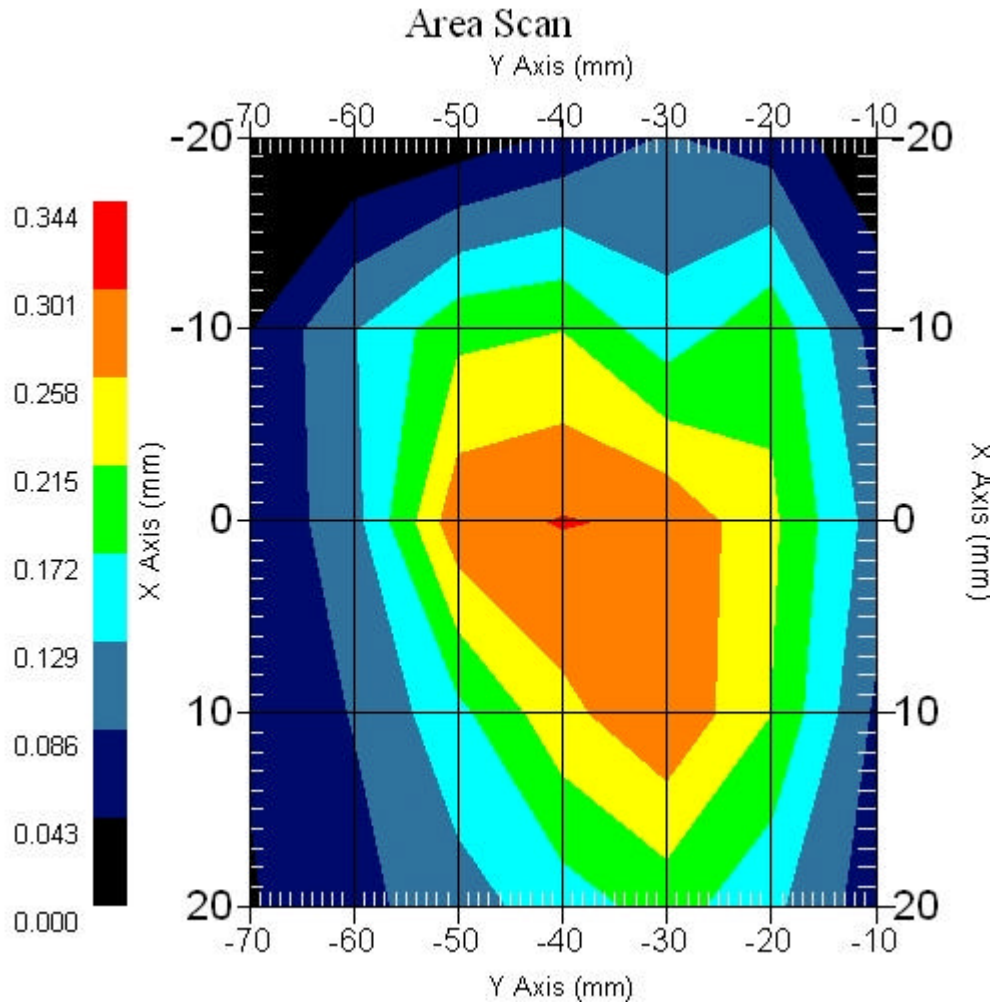

2.2 2450 MHz 802.11g Main Ant. , EUT Position: Back

Measurement Data

Crest Factor : 1
Area Scan : 5x7x1 : Measurement x=10mm, y=10mm, z=4mm
Zoom Scan : 7x7x7 : Measurement x=5mm, y=5mm, z=5mm

DUT Position : Touch
Channel : Mid - 2412MHz

Power Drift-Start : 0.150 W/kg
Power Drift-Finish: 0.147 W/kg
Power Drift (%) : -2.005

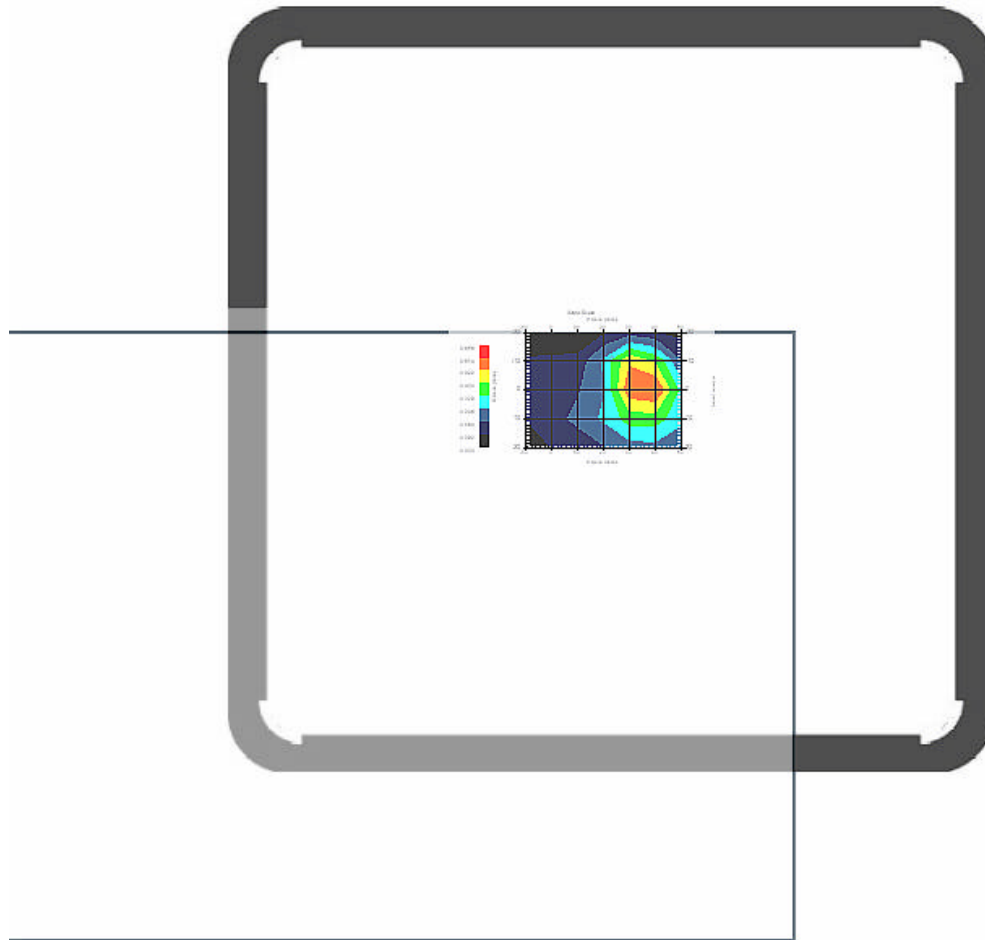

1 gram SAR value : 0.487 W/kg
10 gram SAR value : 0.228 W/kg
Area Scan Peak SAR : 0.575 W/kg
Zoom Scan Peak SAR : 1.010 W/kg

Area Scan Plot

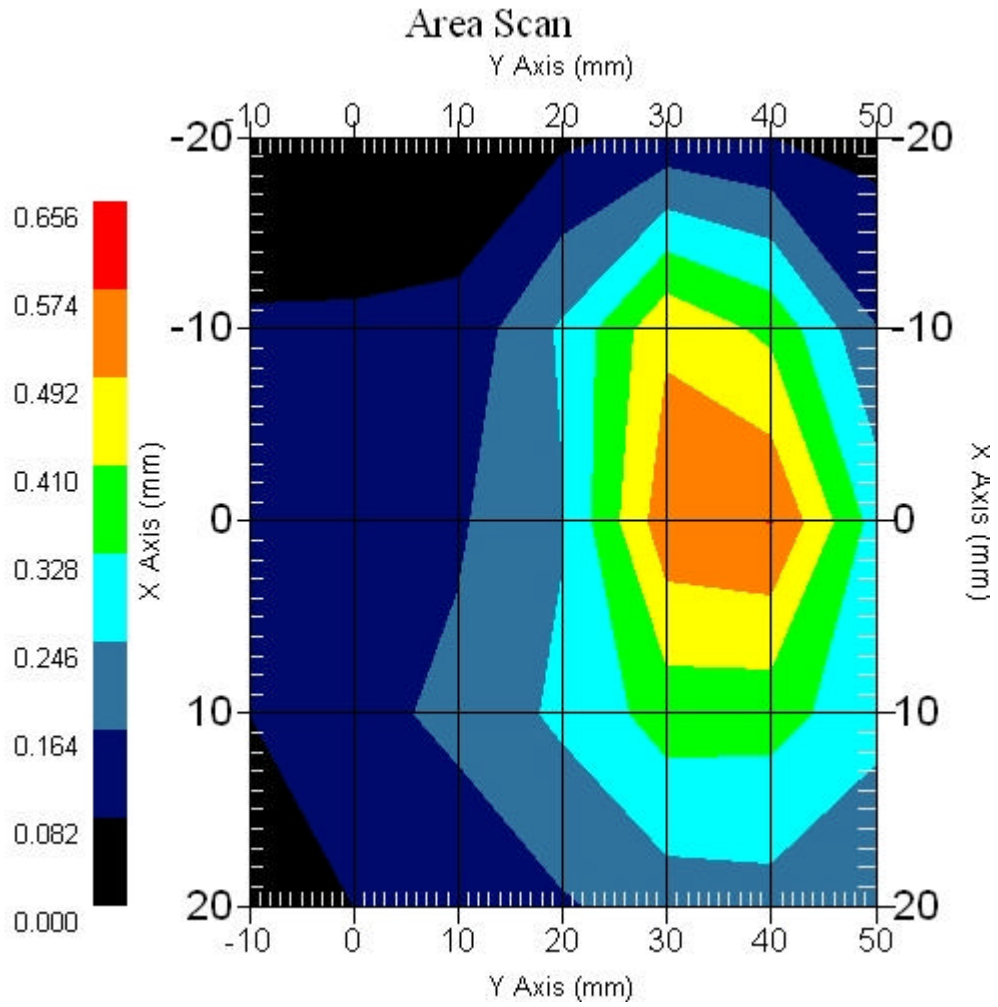

2.3 2450 MHz 802.11g Main Ant. , EUT Position: Back

Measurement Data

Crest Factor : 1
Area Scan : 5x7x1 : Measurement x=10mm, y=10mm, z=4mm
Zoom Scan : 7x7x7 : Measurement x=5mm, y=5mm, z=5mm

DUT Position : Touch
Channel : High - 2462MHz

Power Drift-Start : 0.077 W/kg
Power Drift-Finish: 0.074 W/kg
Power Drift (%) : -3.898

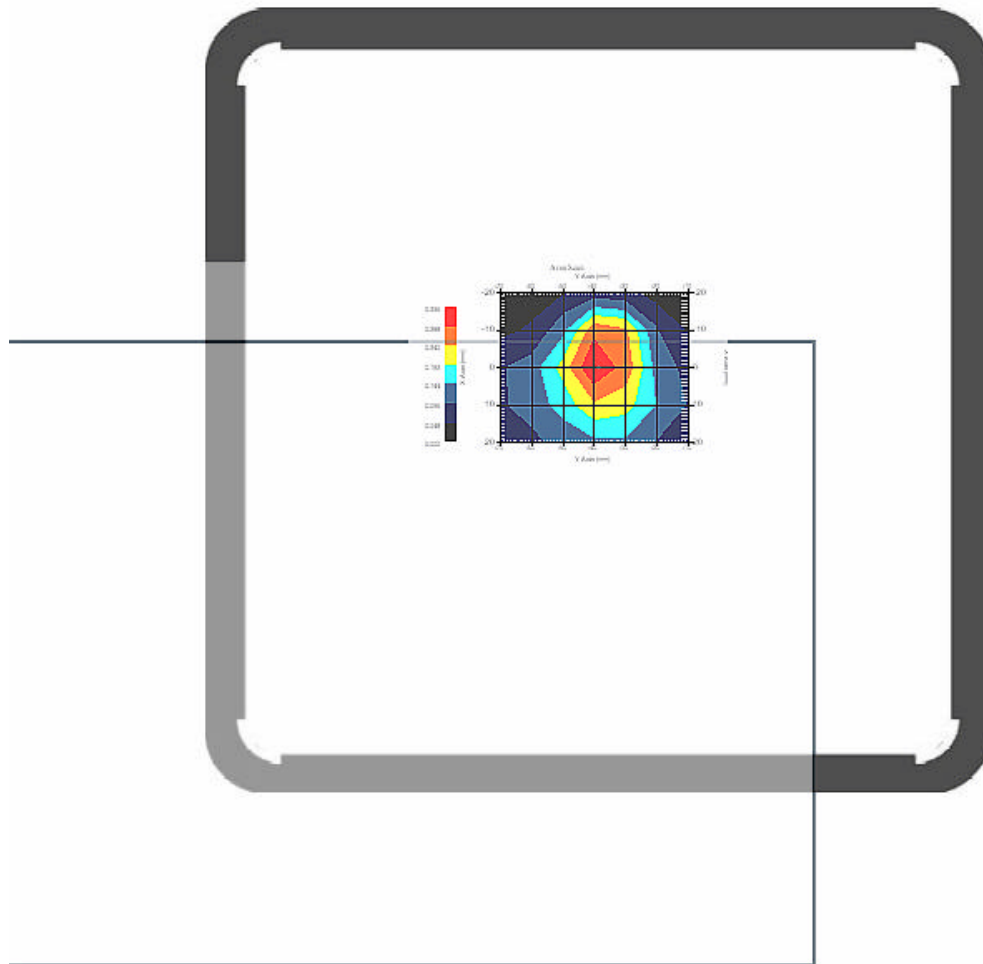

1 gram SAR value : 0.298 W/kg
10 gram SAR value : 0.153 W/kg
Area Scan Peak SAR : 0.336 W/kg
Zoom Scan Peak SAR : 0.560 W/kg

Area Scan Plot

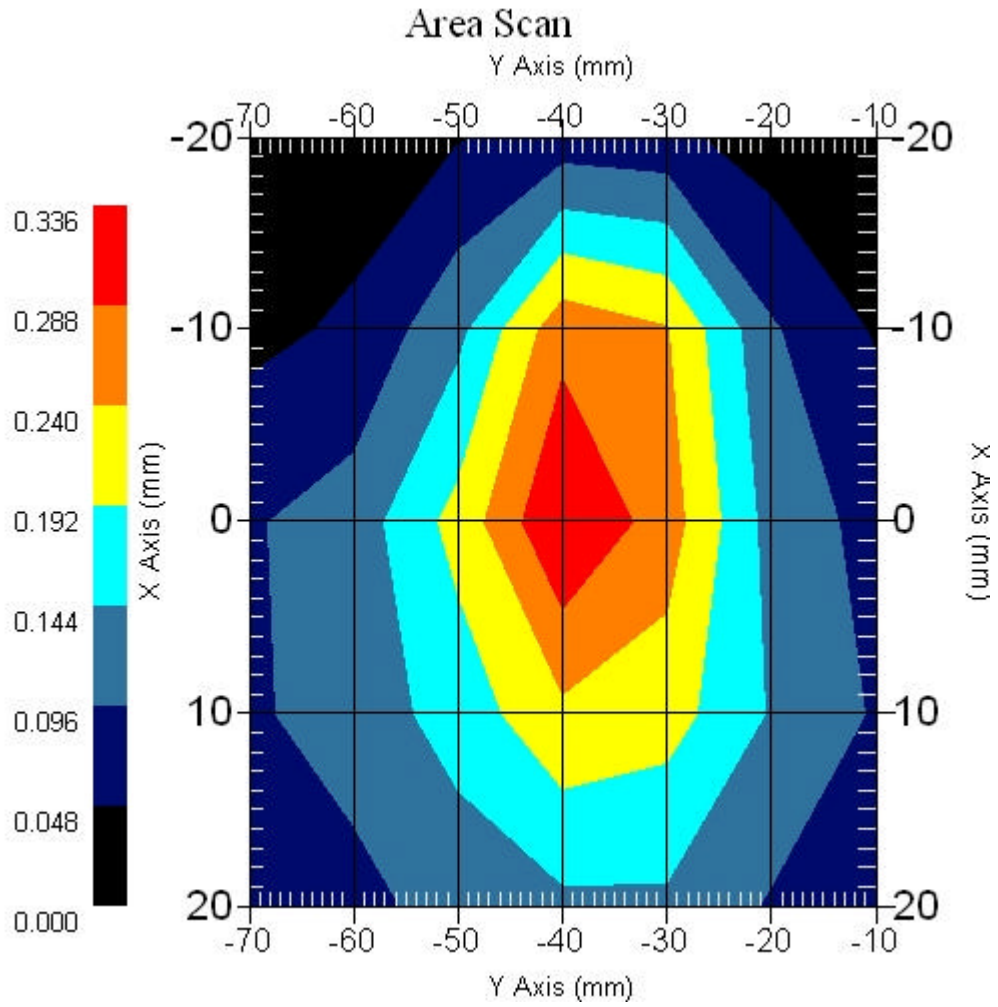

2.4 2450 MHz 802.11g Main Ant. , EUT Position: Top

Measurement Data

Crest Factor : 1
Area Scan : 5x7x1 : Measurement x=10mm, y=10mm, z=4mm
Zoom Scan : 7x7x7 : Measurement x=5mm, y=5mm, z=5mm

DUT Position : Touch
Channel : Mid - 2437MHz

Power Drift-Start : 0.075 W/kg
Power Drift-Finish: 0.073 W/kg
Power Drift (%) : -2.667

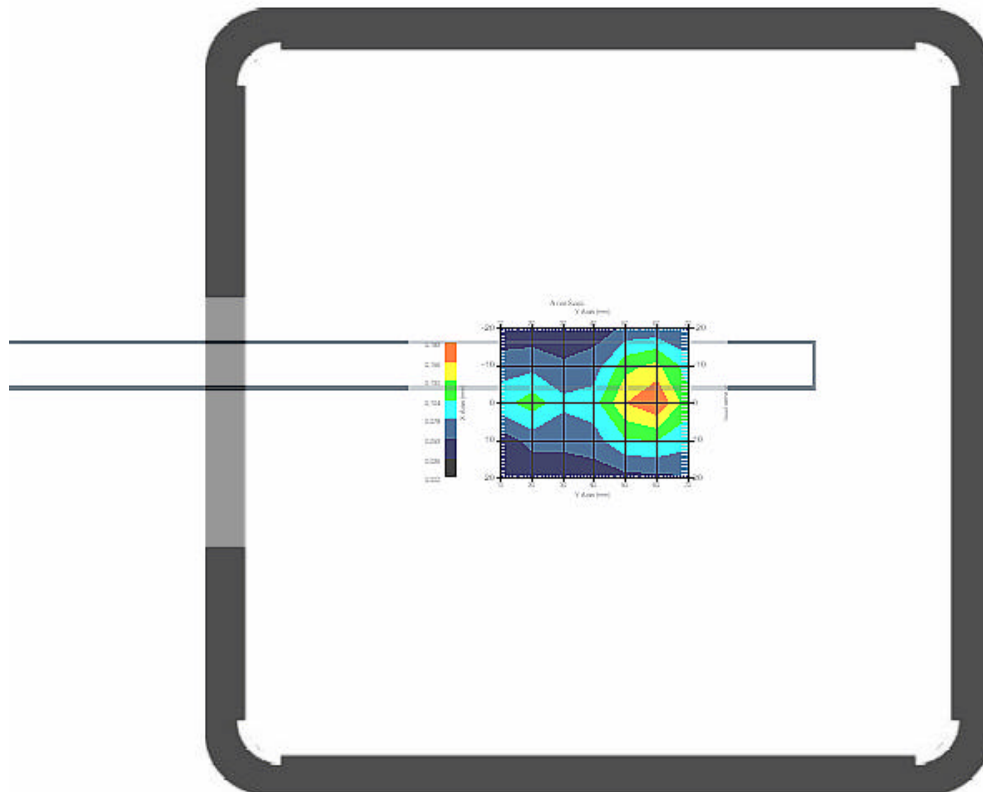

1 gram SAR value : 0.150 W/kg
10 gram SAR value : 0.081 W/kg
Area Scan Peak SAR : 0.182 W/kg
Zoom Scan Peak SAR : 0.290 W/kg

Area Scan Plot

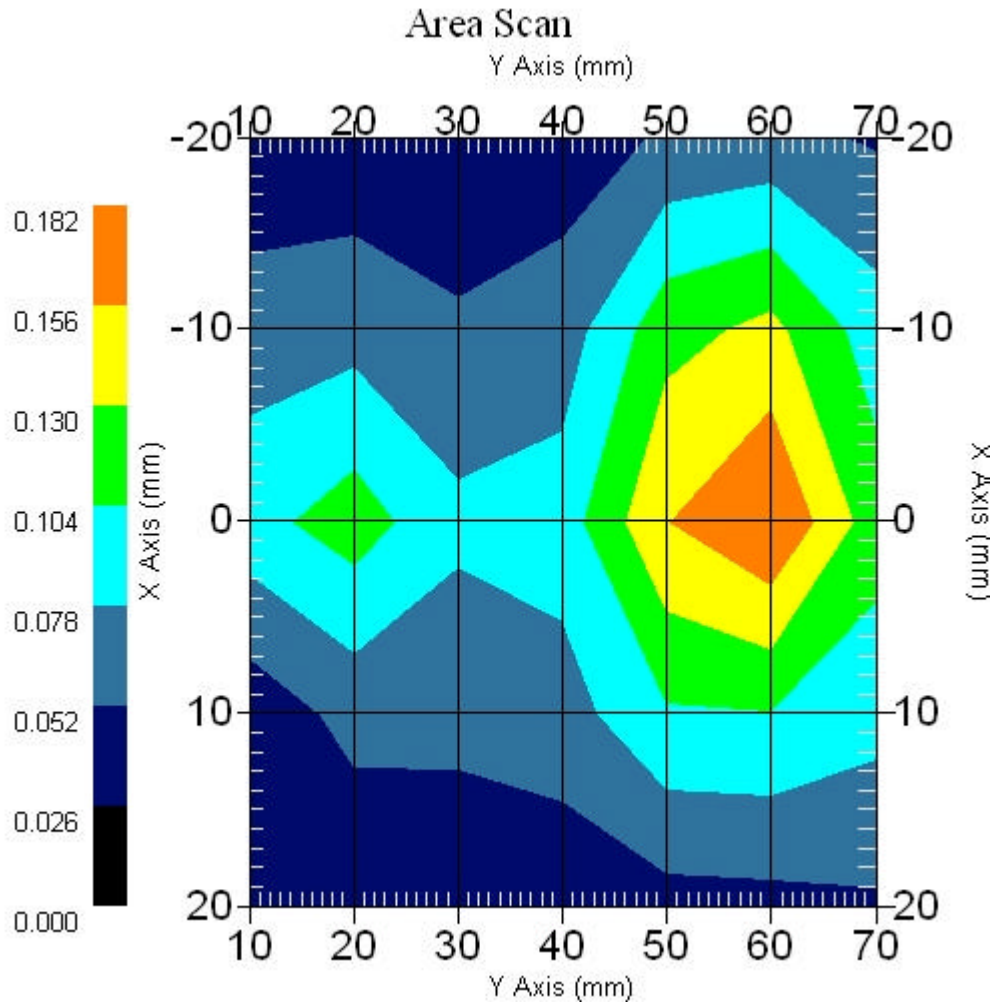

2.5 2450 MHz 802.11g Main Ant. , EUT Position: Front

Measurement Data

Crest Factor : 1
Area Scan : 5x7x1 : Measurement x=10mm, y=10mm, z=4mm
Zoom Scan : 7x7x7 : Measurement x=5mm, y=5mm, z=5mm

DUT Position : Touch
Channel : Mid - 2437MHz

Power Drift-Start : 0.072 W/kg
Power Drift-Finish: 0.073 W/kg
Power Drift (%) : 0.972

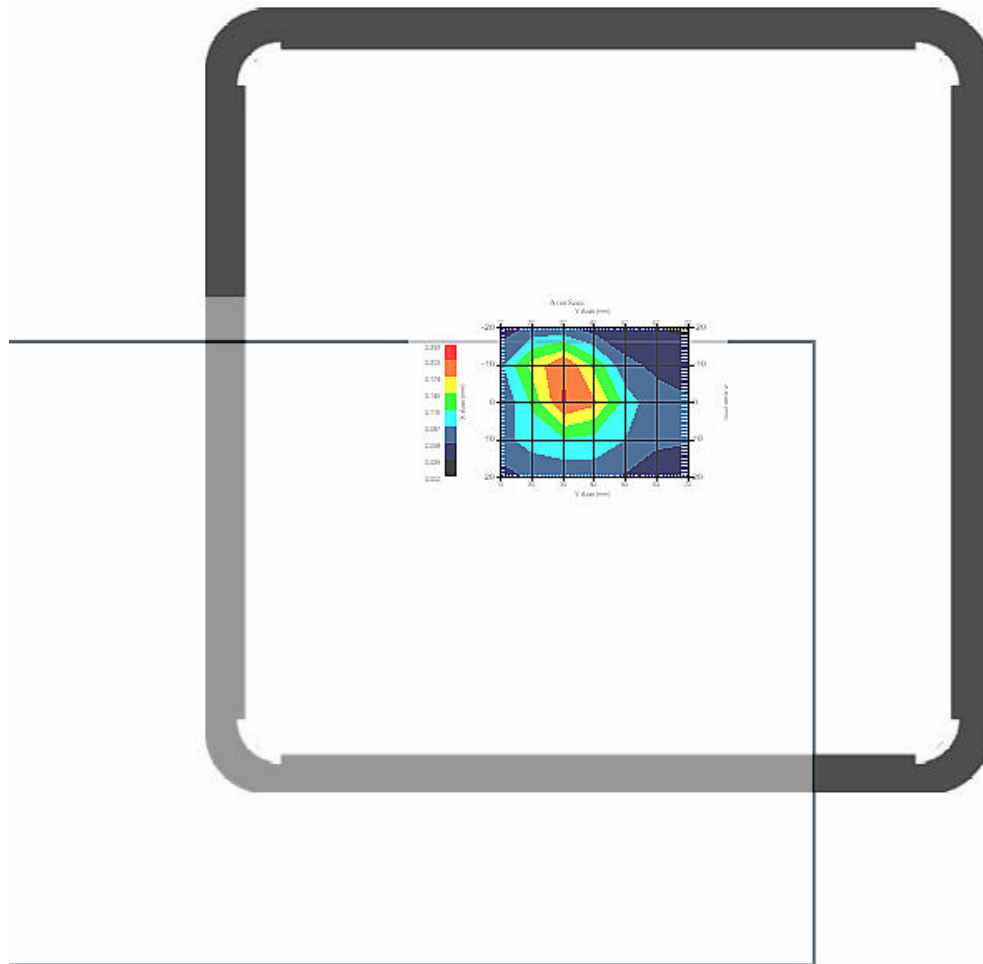

1 gram SAR value : 0.192 W/kg
10 gram SAR value : 0.095 W/kg
Area Scan Peak SAR : 0.205 W/kg
Zoom Scan Peak SAR : 0.390 W/kg

Area Scan Plot

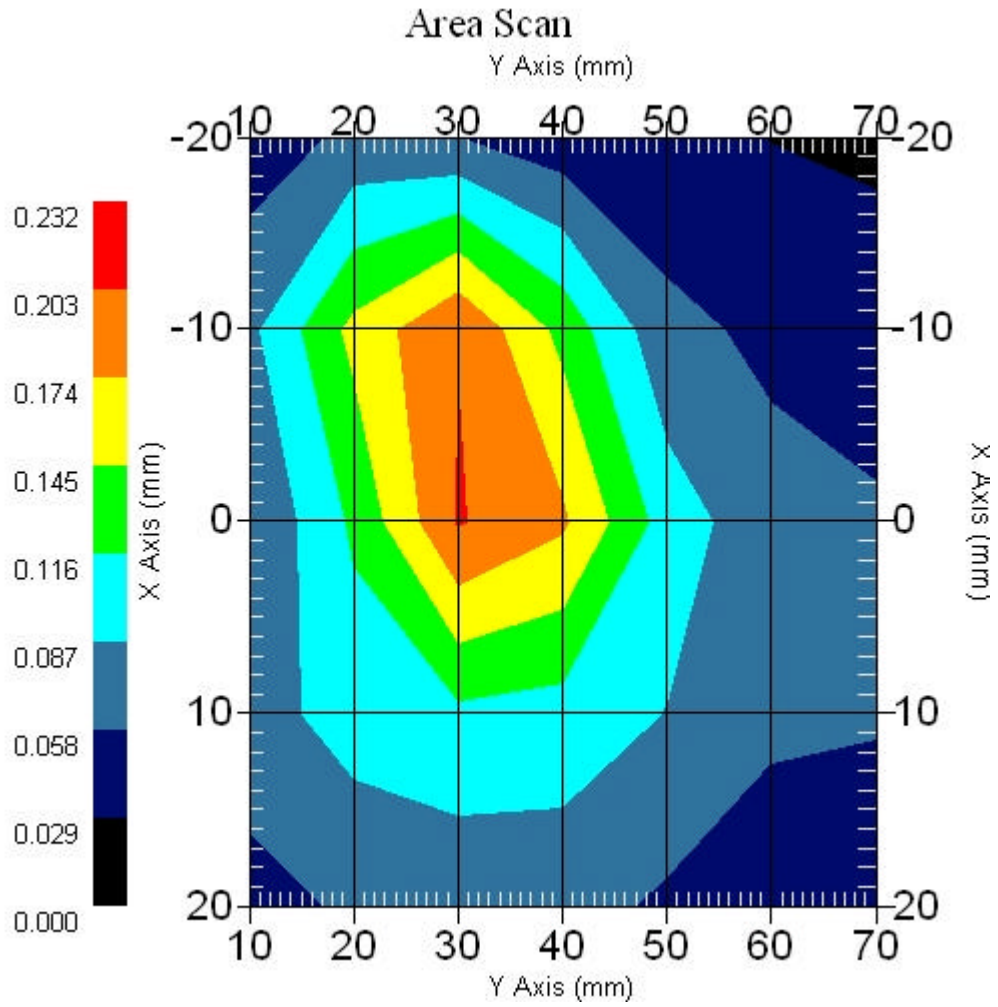

2.6 2450 MHz 802.11g Aux. Ant. , EUT Position: Back

Measurement Data

Crest Factor : 1
Area Scan : 5x7x1 : Measurement x=10mm, y=10mm, z=4mm
Zoom Scan : 7x7x7 : Measurement x=5mm, y=5mm, z=5mm

DUT Position : Touch
Channel : Mid - 2437MHz

Power Drift-Start : 0.087 W/kg
Power Drift-Finish: 0.089 W/kg
Power Drift (%) : 2.299

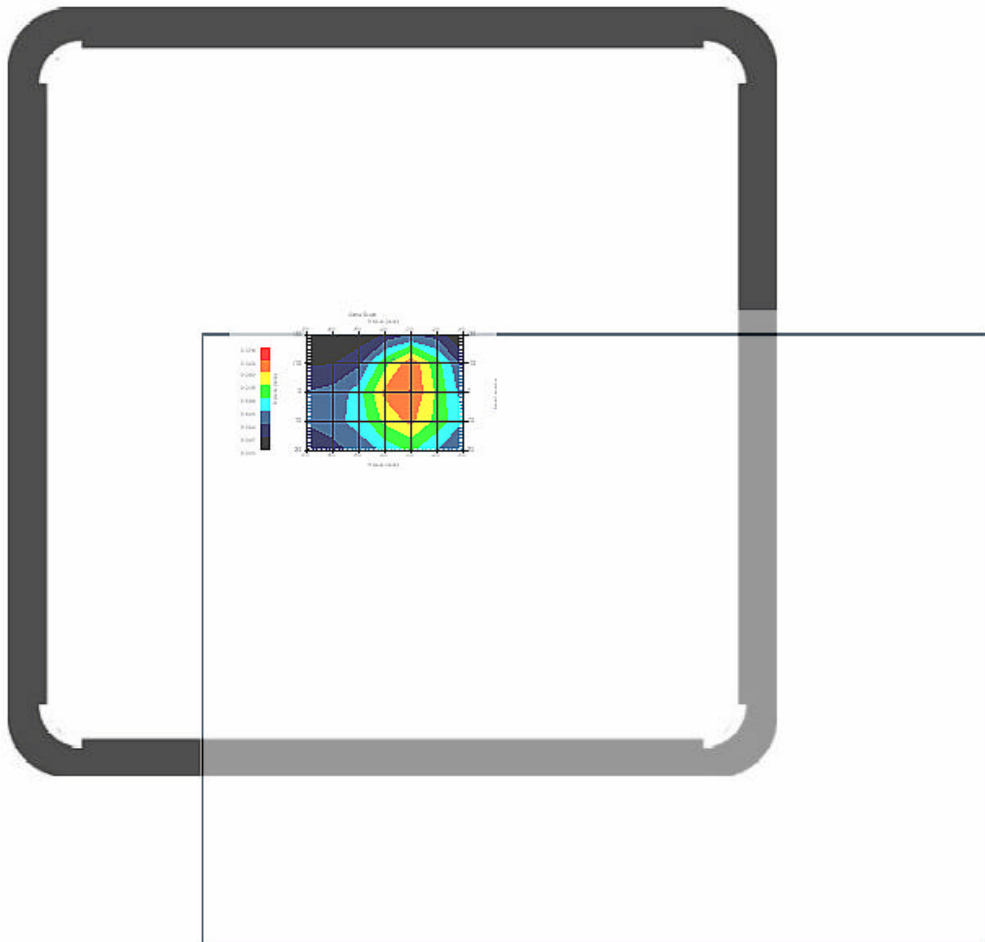

1 gram SAR value : 0.356 W/kg
10 gram SAR value : 0.187 W/kg
Area Scan Peak SAR : 0.331 W/kg
Zoom Scan Peak SAR : 0.650 W/kg

Area Scan Plot

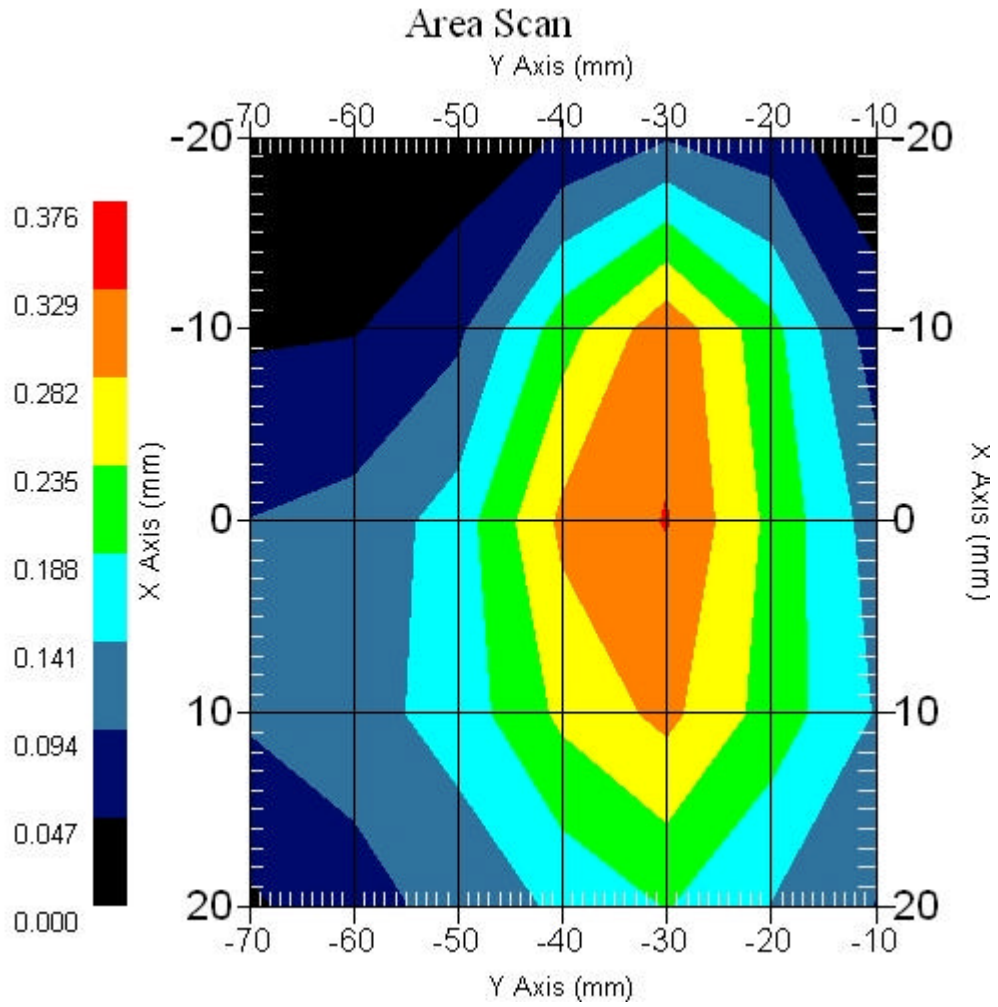

2.8 Z-Axis plot

Frequency: 2450 MHz 802.11g Main Ant. , EUT Position: Back

SAR-Z Axis
at Hotspot x:0.30 y:31.80

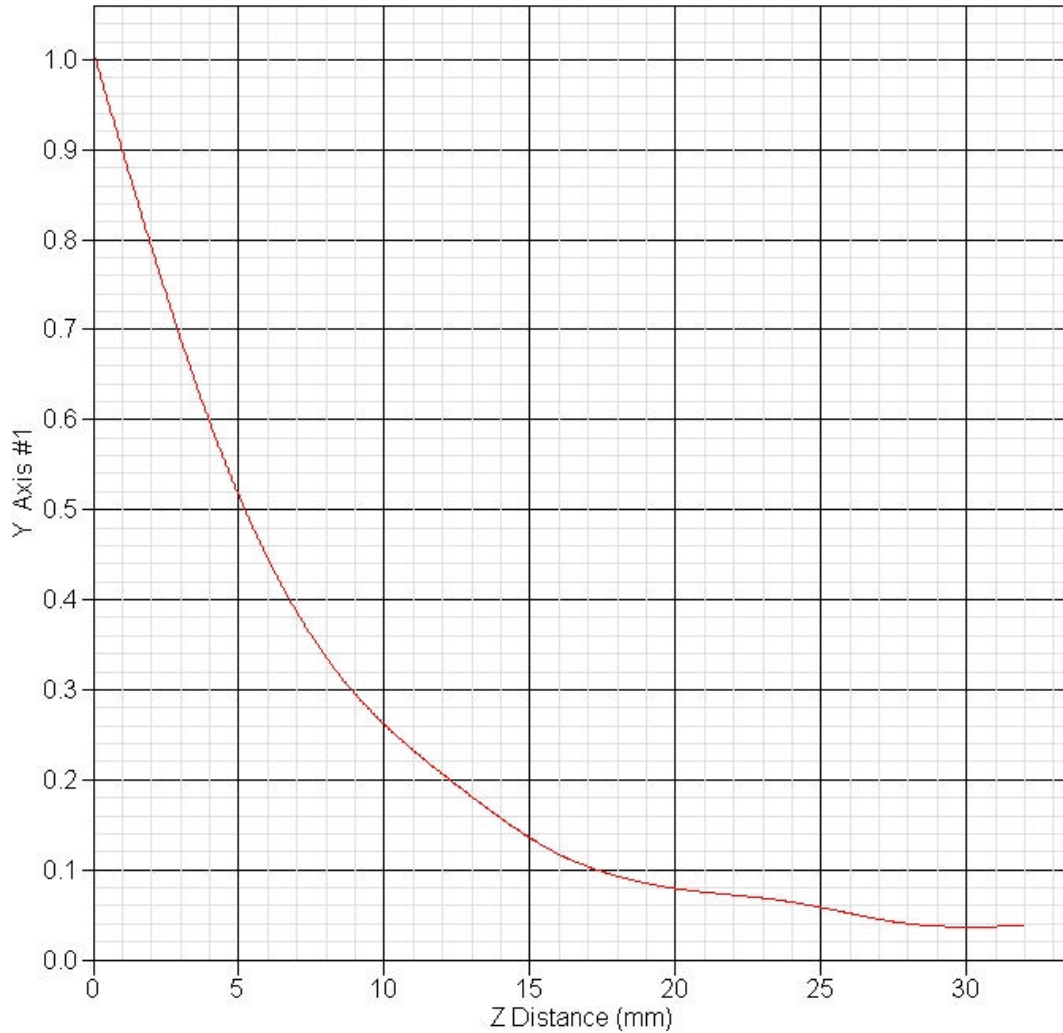



3 SAR measurement Data

SAR Test Report

Report Date : 29-Jan-2007
Measurement Date : 29-Jan-2007

Product Data

Device Name : V100
Serial No. : 11.a-Back
Type : Other
Frequency : 5200.00 MHz
Drift Time : 0 min(s)
Length : 225 mm
Width : 290 mm
Depth : 5 mm
Antenna Type : Internal

Phantom Data

Name : APREL-Uni
Type : Uni-Phantom
Size (mm) : 280 x 280 x 200
Location : Center

Tissue Data

Type : BODY
Serial No. : 5200-B-AU-18
Frequency : 5200.00 MHz
Last Calib. Date : 29-Jan-2007
Temperature : 22.00 °C
Ambient Temp. : 22.30 °C
Humidity : 45.00 RH%
Epsilon : 48.540 F/m
Sigma : 5.190 S/m
Density : 1000.00 kg/cu. m

Probe Data

Name : E-field Probe
Model : ALS-E-020
Type : E-Field Triangle
Serial No. : 266
Last Calib. Date : 22-Jun-2006
Frequency : 5200.00 MHz
Duty Cycle Factor: 1
Conversion Factor: 4.4
Probe Sensitivity: 1.20 1.20 1.20 $\mu\text{V}/(\text{V}/\text{m})^2$
Compression Point: 95.00 mV
Offset : 2.44 mm