



# 建舜電子製造股份有限公司

JOINSOON ELECTRONICS MFG. CO., LTD

## 目錄

## INDEX

1.Coverage .....	1
2.Quick Reference Date.....	2
3.Product Drawing.....	3
4. Specification Performance.....	4~6
5. Mechanical Dimensions.....	7
6.Test Results.....	8~10
7. Antenna Testing Conditions.....	11~21
8.Antenna Packaging.....	20
9.Material Identification.....	23~37

承認序號 (APPROVAL SHEET NO.)	APP-Q040179			發行日期 (RELEASED DATE)
品名規格 (DESCRIPTION)	NoteBook DualBand PIFA Antenna			
檔案號碼 (FILE NO.)	IQ-040783	版次 (REV)	A	
工程師 (ENGINEER)				
品保確認 (QC. CHK.)				
工程確認 (ENG. CHK.)				



**QUICK REFERENCE DATA**

<b>Antenna Patch Dimension</b>	44*4.9*4.45 mm E-BOOK PIFA Antenna
<b>E-BOOK LCD Cable Length</b>	175mm, Color Gray
<b>Connector</b>	I-PEX
<b>Peak Gain</b>	-3.0    Peak Gain    4.0 dBi
<b>VSWR</b>	2.0
<b>Polarization</b>	Linear
<b>Impedance</b>	50
<b>Operating Temperature</b>	-40~90
<b>Maximum Power</b>	1W

一、成品圖

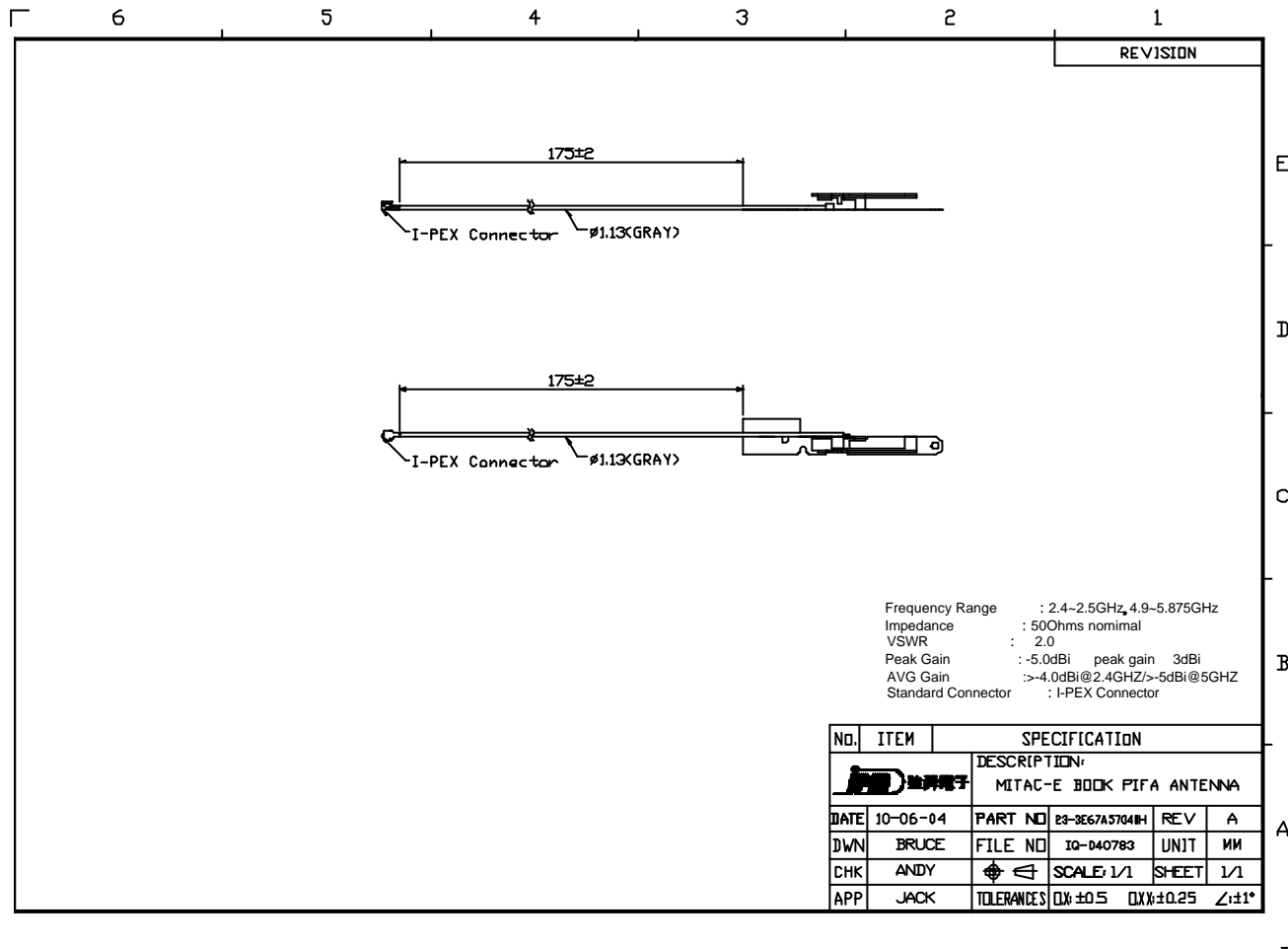



二、

**天線製品規格**

**ANTENNA APPROVAL SHEET**

**1. 一般事項(Generation)**

- 1.1 適用範圍  
 此樣式表適用於 JEM 開發之 ISM /UNII Band 的無線通訊系統所使用之天線。  
 Application Field: This approval sheet only use for JEM development Wireless LAN antenna of ISM/UNII Band.
- 1.2 使用溫度範圍  
 -20 ~ 65  
 Operation : -20 ~ 65
- 1.3 保存溫度範圍  
 -30 ~ 75  
 Storage : -30 ~ 75
- 1.4 測試狀態  
 溫度 5 ~ 35 、相對濕度 45 ~ 85%、氣壓 860 ~ 1060 hpa 的標準狀態下進行測試。但是若對測試結果有質疑的話，可以於溫度 20 ± 2 、相對濕度 65 ± 5%、氣壓 860 ~ 1060hpa 的基準狀態進行測試。  
 Test Condition: T=5 ~ 35 , Humidity=45 ~ 85%. If any doubt and you could test under the following standard T= 20 ± 2 , Humidity = 65±5% , Atmosphere=860 ~ 1060hpa

**2. 外觀、構造、尺寸 (Appearance , Construction , Dimension)**

- 2.1 外觀  
 各部位的修飾加工良好，沒有對於機能有害的生鏽、裂痕、瑕疵等等情形。  
 Appearance : Good manufacture of each parts and without rusting,cracking,defect...etc to damage product.
- 2.2 機能、尺寸  
 依據各個製品圖。  
 Construction, Dimension: According to each product drawing

**3. 機械性能 Mechanical Performance**

	項目 ITEM	測試條件 TEST CONDITION	規格 SPECIFICATION
3.1	抗振性 Vibration	振擺的比率 : 10 ~ 55 ~ 10 Hz/分 總振幅 : 1.5 mm X、Y、Z 方向各 2 小時 (總計 6 小時) Ratio: 10-50-10 Hz/minute. Vibration amplitude:1.5 mm To vibrate 2 hrs on X,Y,Z direction(Totally 6 hrs)	外觀、構造無異常 機械性能無異常 符合電氣性能 ( 4.1& 4.2 項 ) No abnormal of appearance, construction, mechanical. Meet electrical request(Item 4.1&4.2)
3.2	同軸電纜的抗拉強度 Tensile of Coaxial Cable	在同軸電纜的拉出方，施加 1 kgf 的靜止負荷重量一分鐘。 To load 1Kgf weight within 1 minute.	同軸電纜不會脫落 No fall of Coaxial cable. Remarks: This test only for pigtail type.

**4. 電氣的性能 Electrical Properties**

	項目 ITEM	測試條件 TEST CONDITION	規格 SPECIFICATION
--	---------	---------------------	------------------

4.1	駐波比 VSWR	放在任何空間進行檢測。 (VSWR & Return Loss 的檢測方式參考次頁明細圖)	2.0 以下 2.0 Max. (2.4GHz ~ 2.5GHz / 4.9GHz ~ 5.875GHz)
4.2	反射損失 Return Loss	To detect on any space. (VSWR & Return Loss testing to read next figure for ref.)	-10 dB 以下 -10 dB Max. (2.4GHz ~ 2.5GHz / 4.9GHz ~ 5.875GHz)
4.3	特徵阻抗 Impedance		500
4.4	指向性 Certain direction		
4.5	最大增益 Max GAIN		-3~4 dBi 以上 (絕對增益) -3~4 dBi Min.

### 5. 耐氣候性 Environmental Performance

	項目 ITEM	測試條件 TEST CONDITION	規格 SPECIFICATION
5.1	耐熱性 Temperature Life	放在溫度 $60 \pm 2$ 中，96 小時後在正常溫濕度下放置 1 小時進行檢測。 To put antenna at $60 \pm 2$ within 96 hrs then take it out to put at normal environment within 1 hour later to detect.	外觀、構造無異常 機械性能無異常 符合電氣性能 (4.1 & 4.2 項) No abnormal of appearance, construction, mechanical.
5.2	耐寒性 Cold	放在 $-10 \pm 2$ 中，96 小時以後，再置於正常溫濕度 1 小時進行檢測。 To keep in $-10 \pm 2$ within 96hrs and take out to put at normal environment within 1 hour later to detect.	Meet electrical request( Item 4.1 & 4.2)
5.3	耐溫性 穩定狀態) Humidity ( Stable )	放在 $+40 \pm 2$ ，相對濕度 90 ~ 95% 的狀態，96 小時以後，再置於正常溫濕度 1 小時進行檢測。 To keep in $+40 \pm 2$ , damp=90~95% within 96 hrs and take it out to put at normal environment within 1 hour later to detect.	
5.4	熱沖擊測試 Thermal Shock	$-20$ ， $+60$ 的狀態各放置 1 小時視為 1 週期，測試 10 週期後，再放置於正常溫濕度 1 小時後進行檢測。 To put antenna at $-20$ & $+60$ and each degree for 1 hour as a cycle , totally need to repeat 10 cycles then put at normal environment within 1 hour later to detect.	

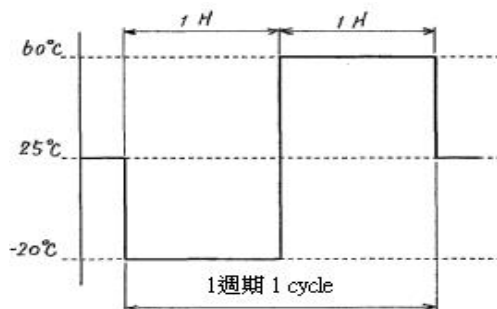

(註) 電氣性能項目的檢測機器

(Remarks) Testing equipments

檢測器(equipment) : Agilent Network Analyzer E8358A

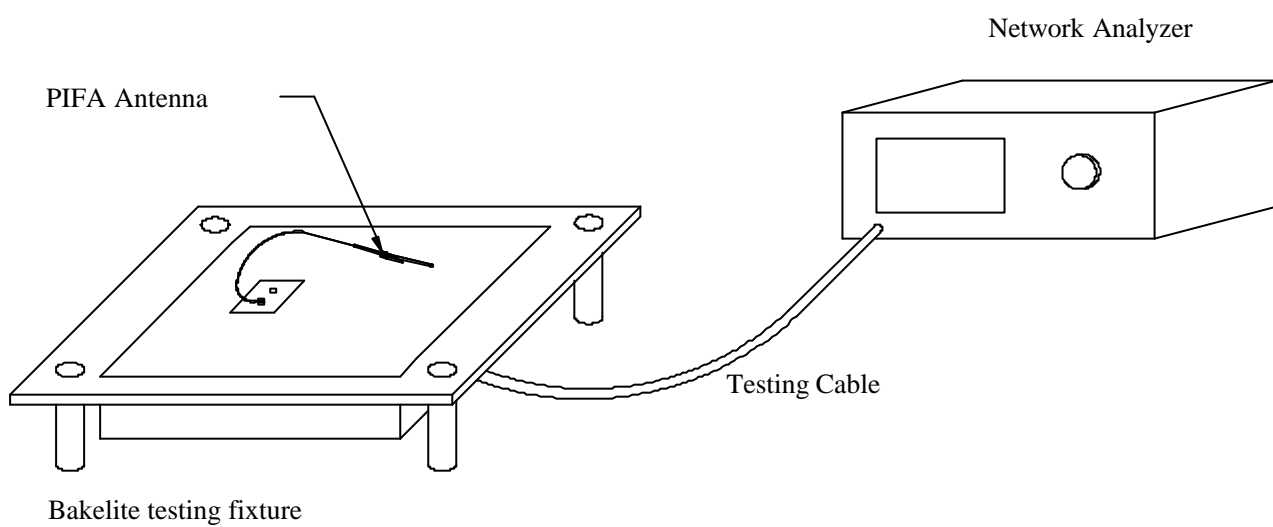



Mechanical dimensions

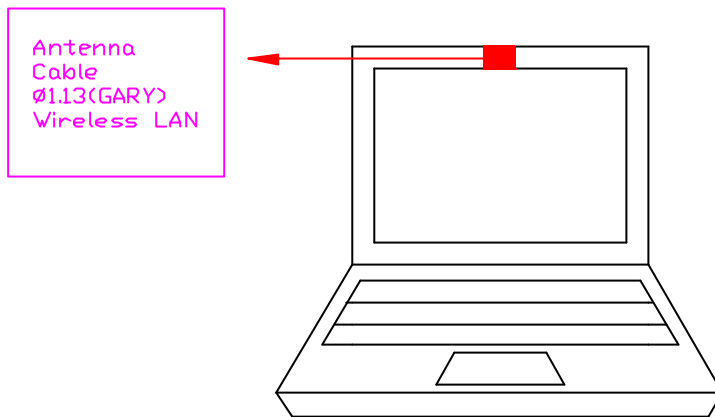

### 三、 Test results

Antenna	Application	Placement	Cable dia. F mm	Connector
<b>E-BOOK</b>	<b>Wireless</b>	<b>Left up</b>	<b>SUMITOMO 0.7DS-PBE 1.13</b>	<b>I-PEX (20278-111R-13)</b>

#### 1. Return Loss

Antenna	Center freg. @MHz	BW @MHz	Return Loss		
			2.4GHz	2.45GHz	2.5GHz
<b>E-BOOK</b>	2450	390	-14.314	-17.548	-15.685

Antenna	Center freg. @MHz	BW @MHz	Return Loss					
			4.9GHz	5.15GHz	5.35GHz	5.47GHz	5.725GHz	5.875GH
<b>E-BOOK</b>	5250	210	-15.374	-24.498	-16.209	-16.847	-20.083	-16.626

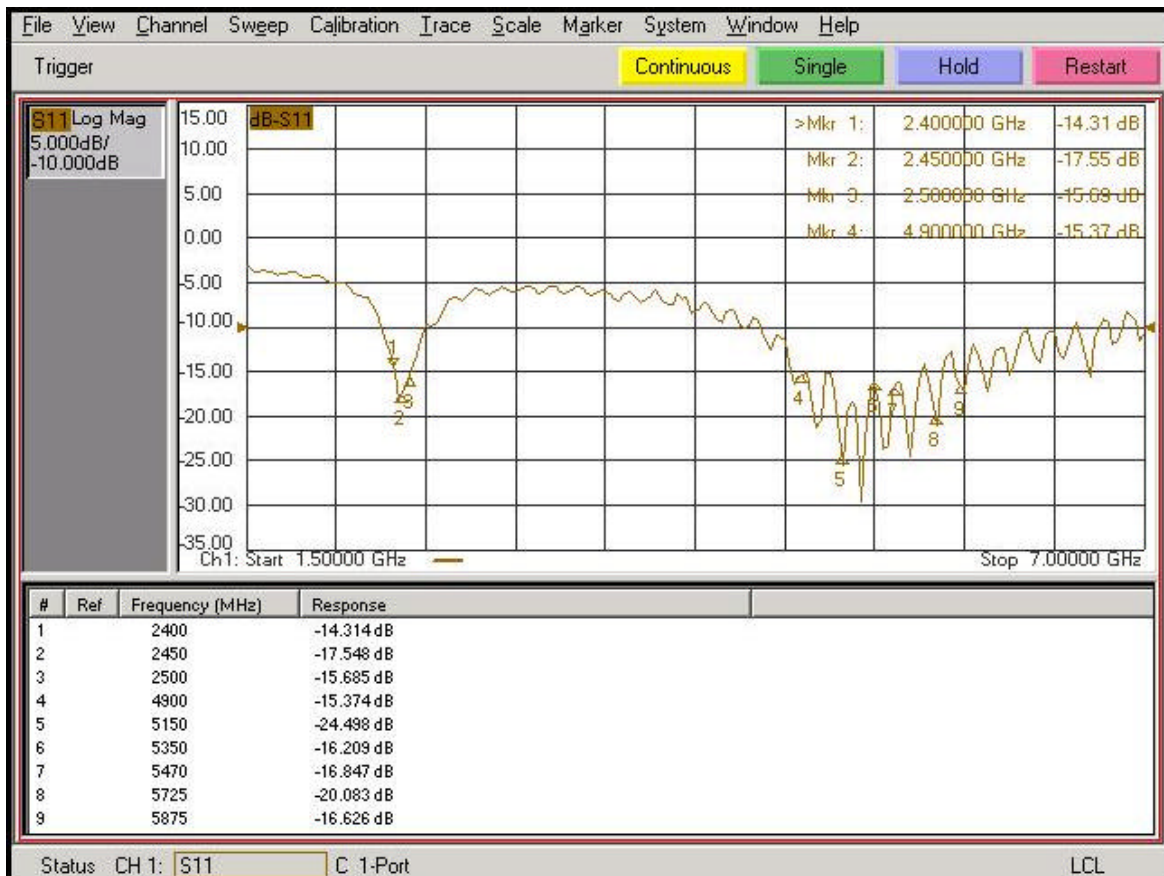





2. VSWR

Antenna	Center freg. @MHz	BW @MHz	VSWR		
			2.4GHz	2.45GHz	2.5GHz
<b>E-BOOK</b>	2450	396	1.482	1.306	1.396

Antenna	Center freg. @MHz	BW @MHz	VSWR					
			4.9GHz	5.15GHz	5.35GHz	5.47GHz	5.725GHz	5.875GH
<b>E-BOOK</b>	5250	215	1.410	1.129	1.336	1.337	1.222	1.346

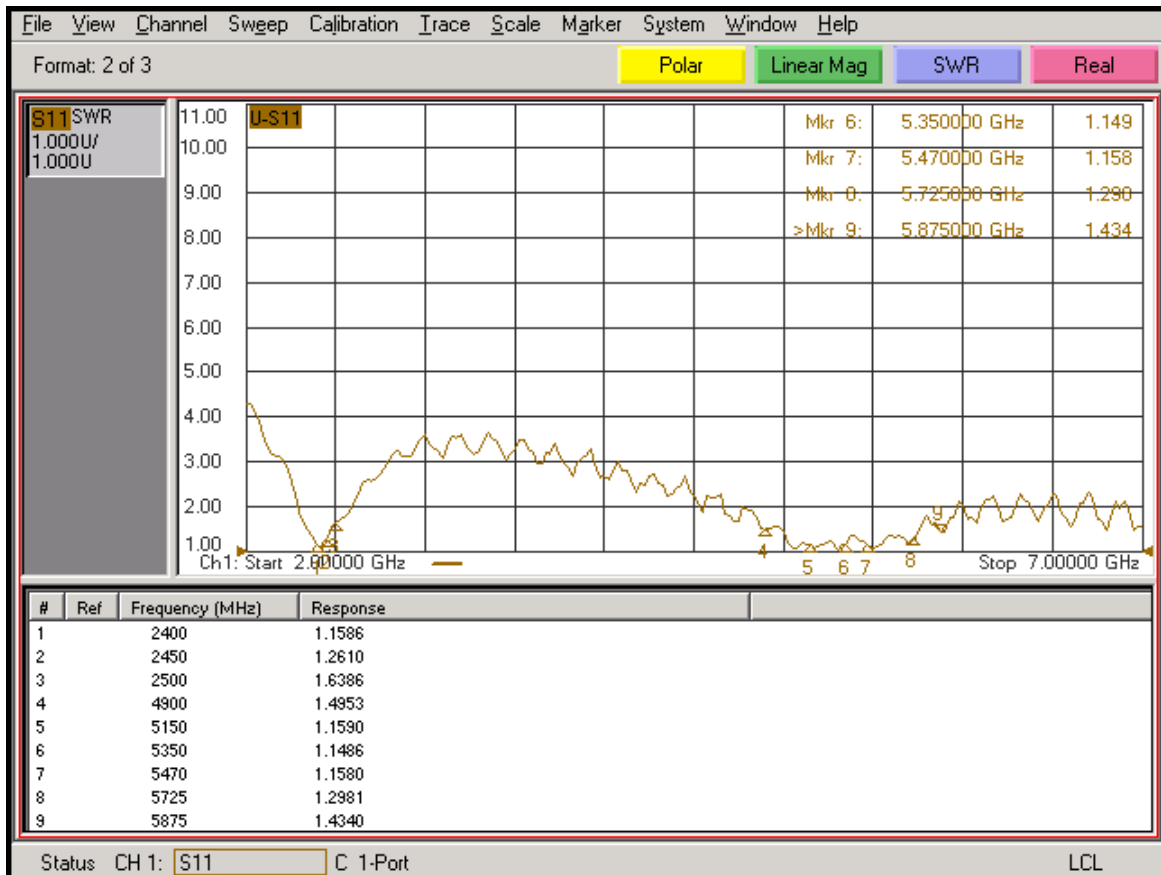

### 3.Smith Chart

### E-BOOK

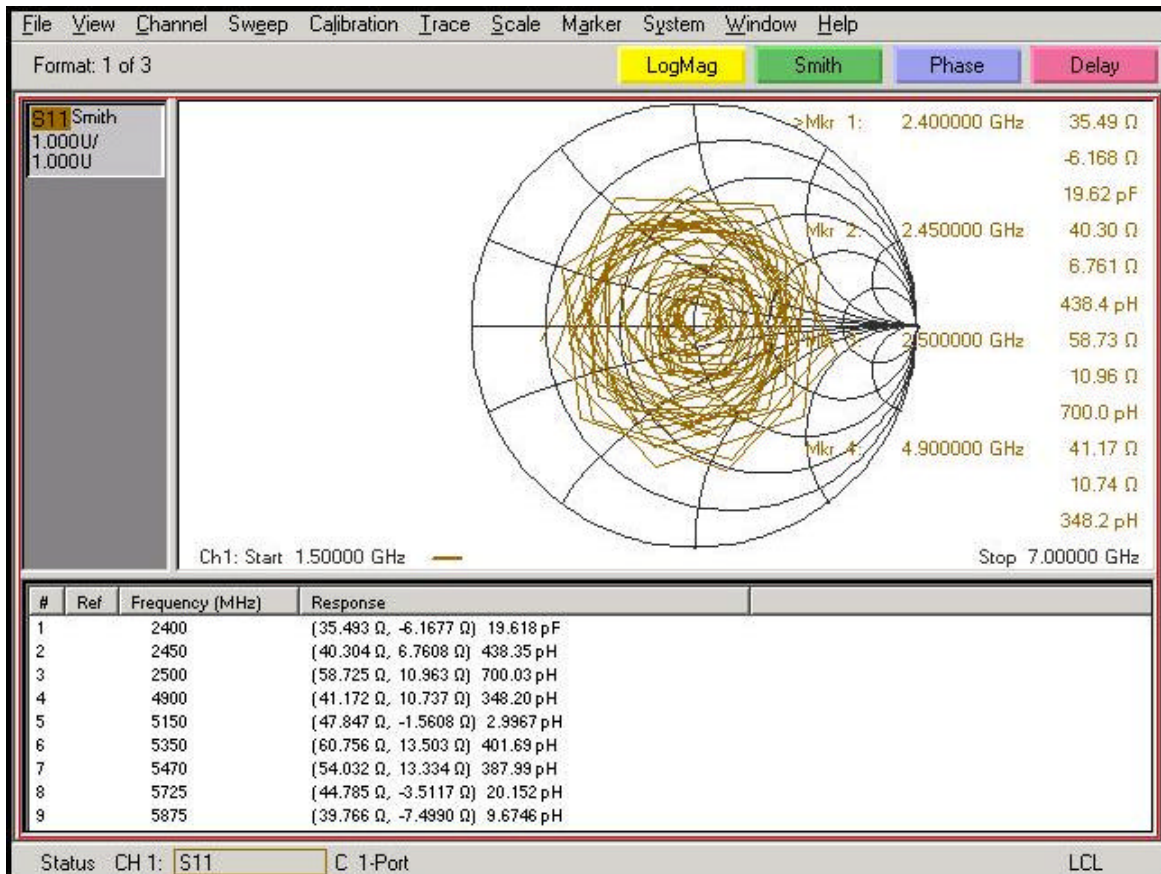



**四、 Antenna Testing Conditions:**

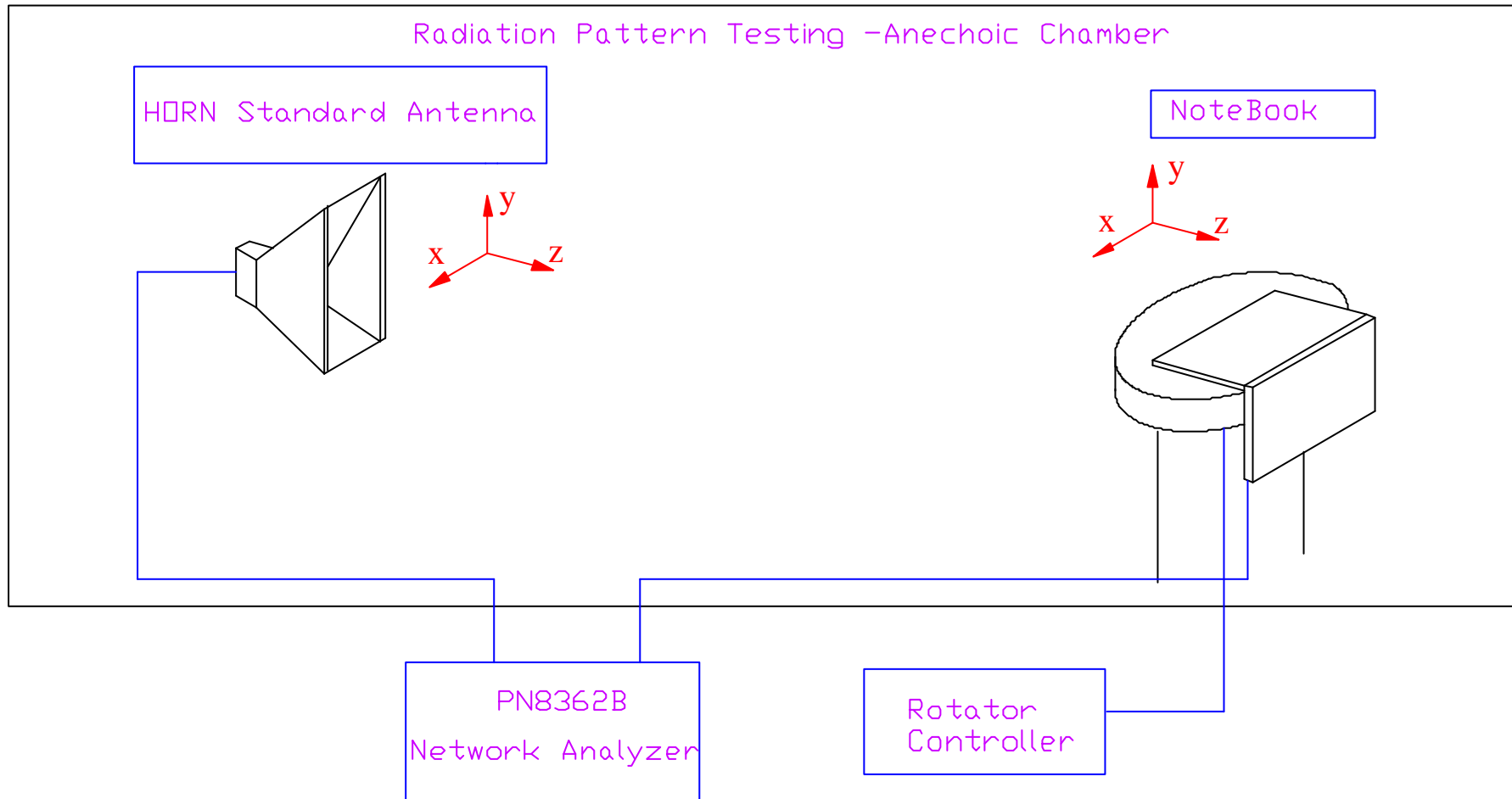



Free Space 天線輻射場形：

1. Radiation Pattern of **XZ Plane (Azimuth)**

<p>2.4G 2.45G 2.5G</p>	<p><b>L (E-PATTEN)</b></p>
--------------------------------	----------------------------

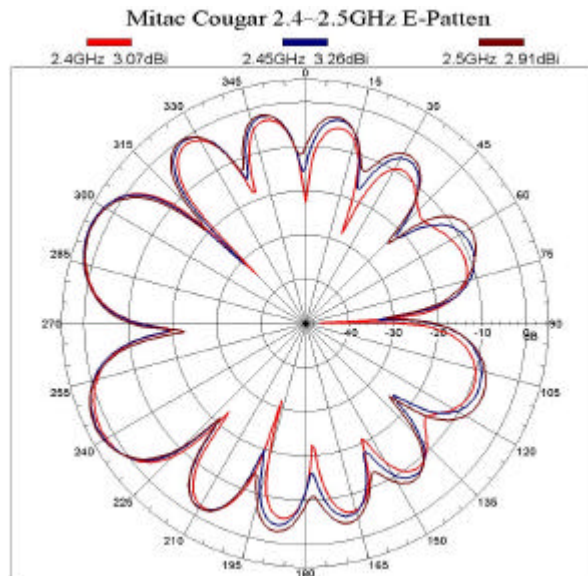

<p>4.9G 5.1G 5.35G</p>	<p><b>L(E-PATTEN)</b></p>
--------------------------------	---------------------------

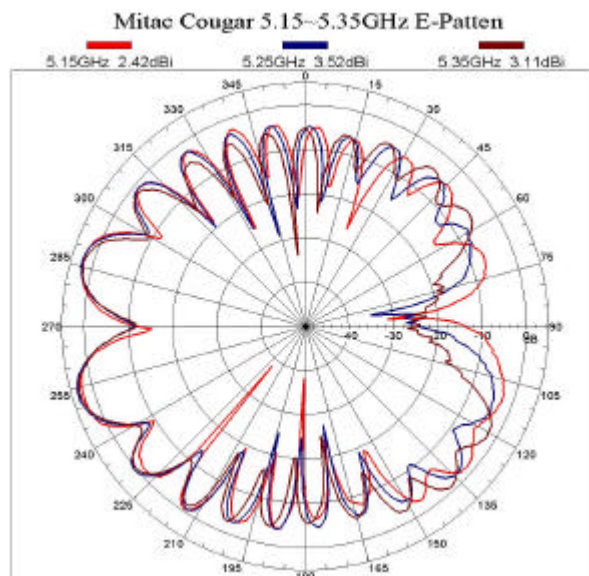



**5.47G**  
**5.725G**  
**5.875G**

**L(E-PATTEN)**

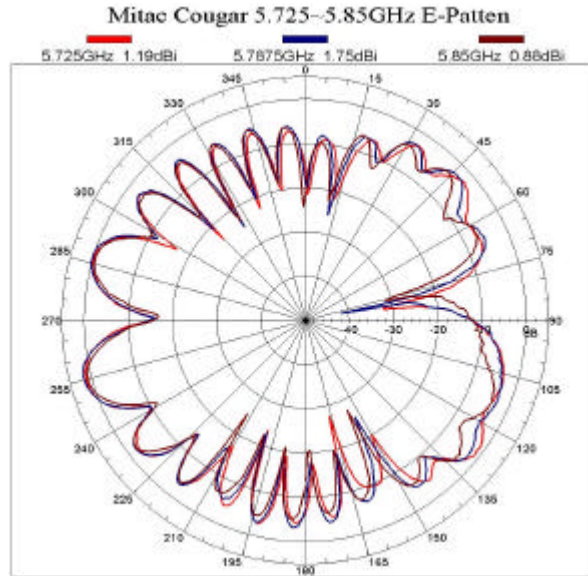



2. GAIN

**(E-BOOK: GAIN)**

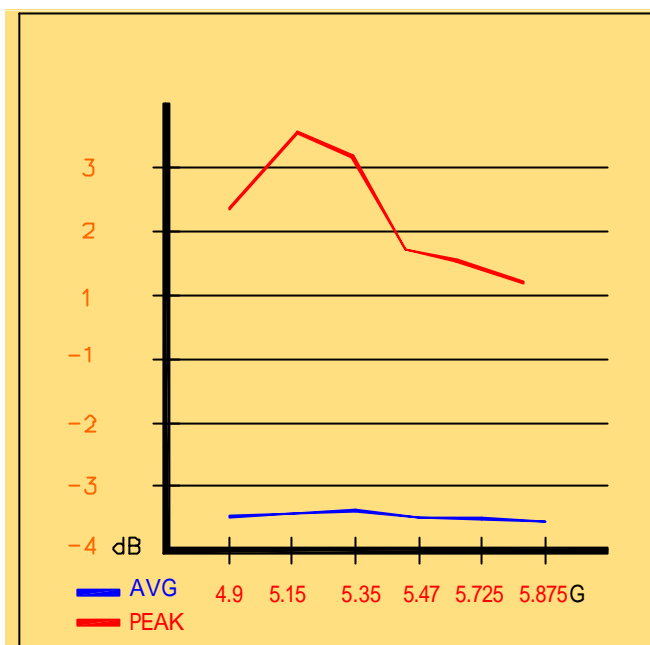
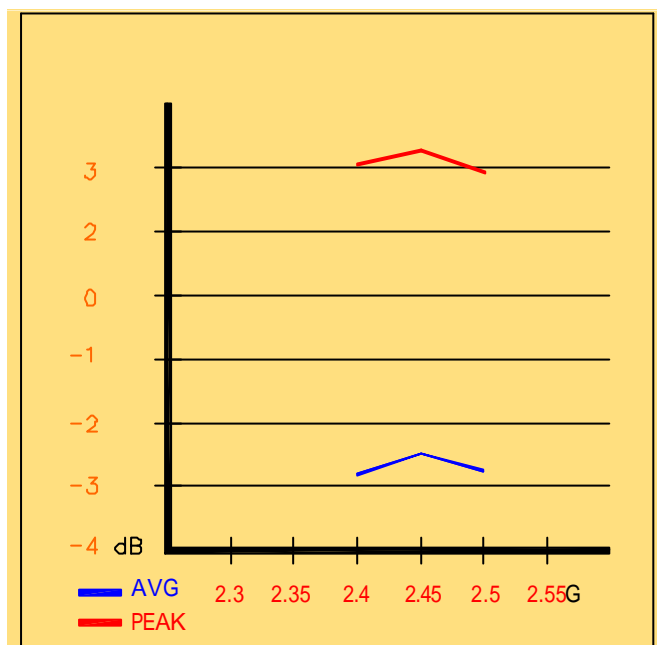

Antenna	AVG GAIN(E)		
	2.4GHz	2.45GHz	2.5GHz
E-BOOK	-2.51	-2.42	-2.49

Antenna	AVG GAIN(E)					
	5.15GHz	5.25GHz	5.35GHz	5.47GHz	5.725GHz	5.875GH
E-BOOK	-3.34	-3.28	-3.29	-3.25	-3.31	-3.23

Antenna	PEAK GAIN(E)		
	2.4GHz	2.45GHz	2.5GHz
E-BOOK	3.07	3.26	2.91

Antenna	PEAK GAIN(E)					
	5.15GHz	5.25GHz	5.35GHz	5.47GHz	5.725GHz	5.875GH
E-BOOK	2.42	3.52	3.11	1.19	1.75	0.88

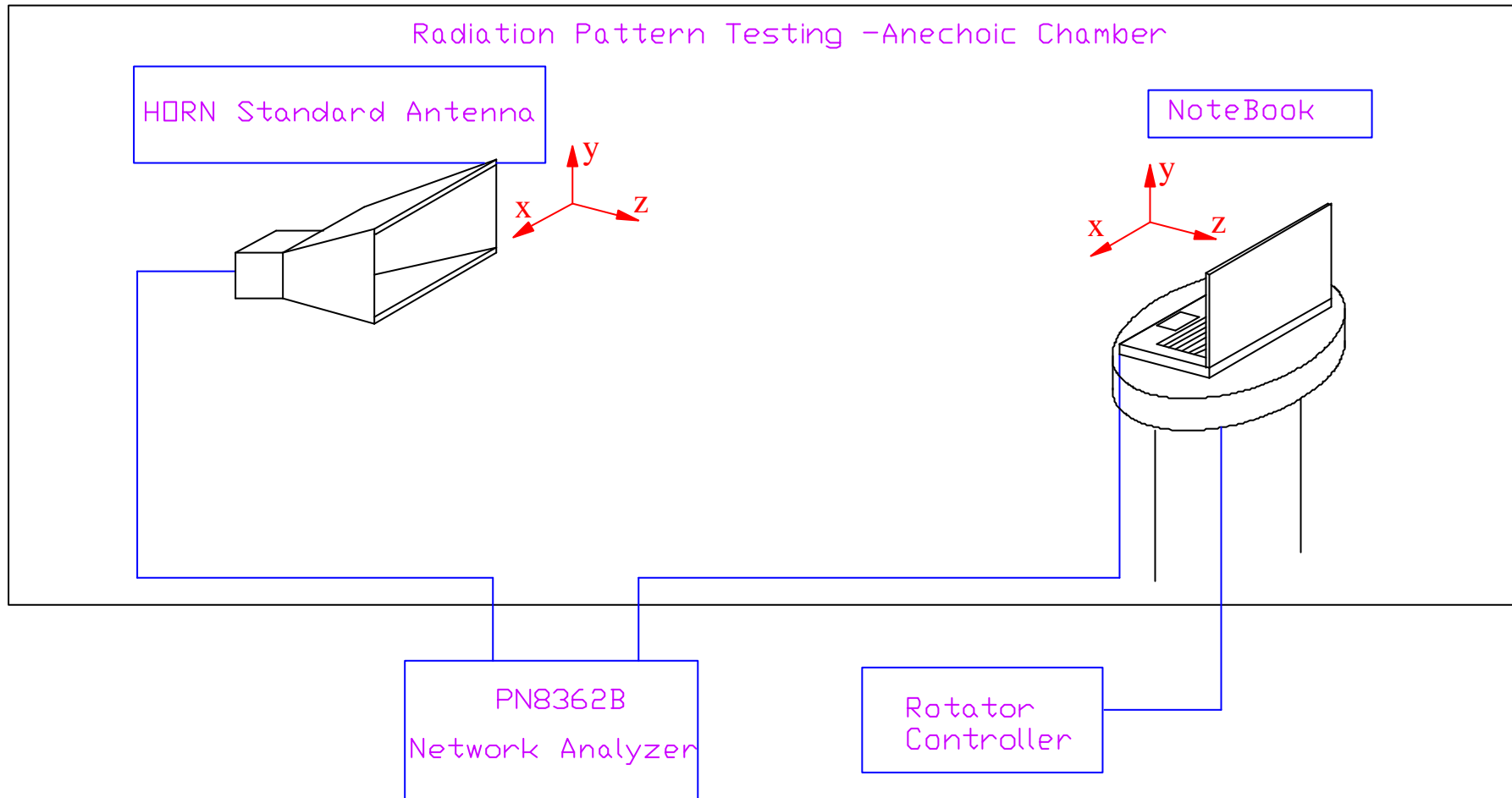



3. Radiation Pattern of XZ Plane (Azimuth)

<p>2.4G 2.45G 2.5G</p>	<p><b>L(H-PATTEN)</b></p>
--------------------------------	---------------------------

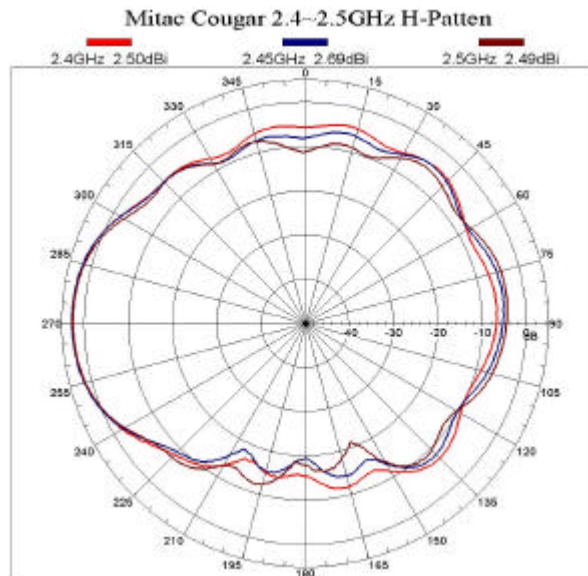

<p>4.9G 5.1G 5.35G</p>	<p><b>L(H-PATTEN)</b></p>
--------------------------------	---------------------------

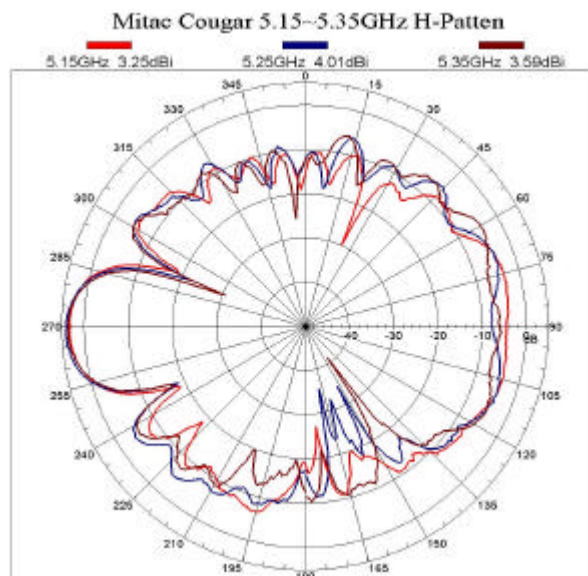





**5.47G**  
**5.725G**  
**5.875G**

**L(H-PATTEN)**

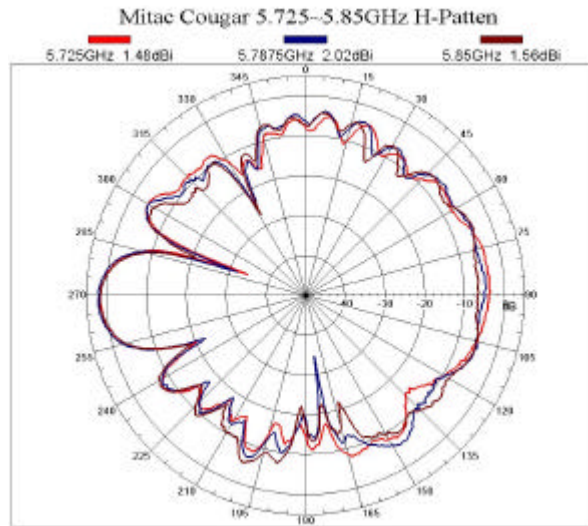



4. GAIN

**(E-BOOK: GAIN)**

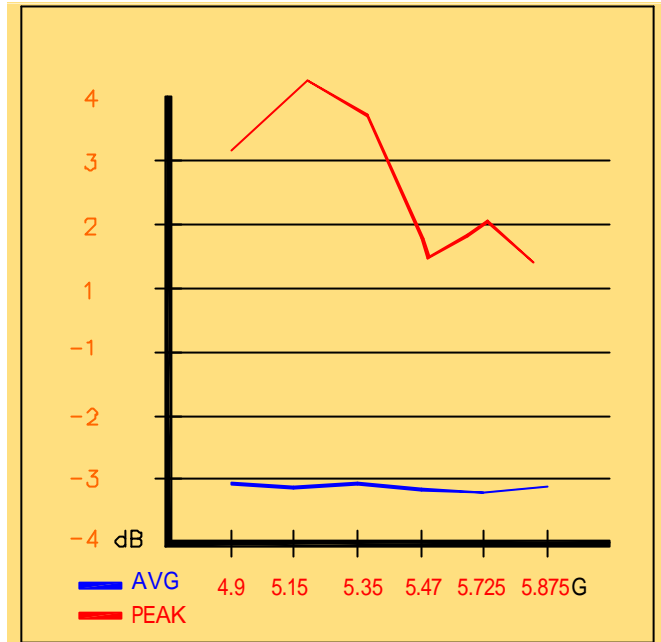
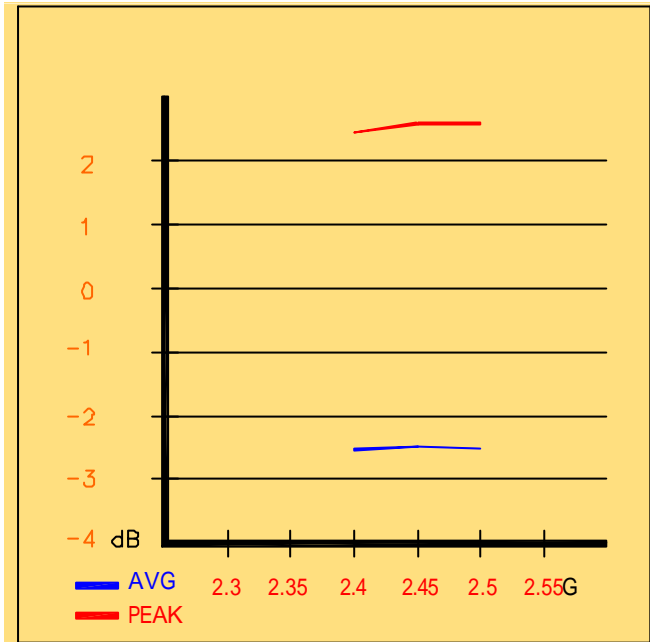

Antenna	AVG GAIN(H)		
	2.4GHz	2.45GHz	2.5GHz
E-BOOK	-2.48	-2.49	-2.52

Antenna	AVG GAIN(H)					
	5.15GHz	5.25GHz	5.35GHz	5.47GHz	5.725GHz	5.875GH
E-BOOK	-3.12	-3.14	-3.18	-3.17	-3.21	-3.14

Antenna	PEAK GAIN(H)		
	2.4GHz	2.45GHz	2.5GHz
E-BOOK	2.5	2.69	2.49

Antenna	PEAK GAIN(H)					
	5.15GHz	5.25GHz	5.35GHz	5.47GHz	5.725GHz	5.875GH
E-BOOK	3.25	4.01	3.59	1.48	2.02	1.56



5. TOTAL GAIN

**(E-BOOK:H+E GAIN)**

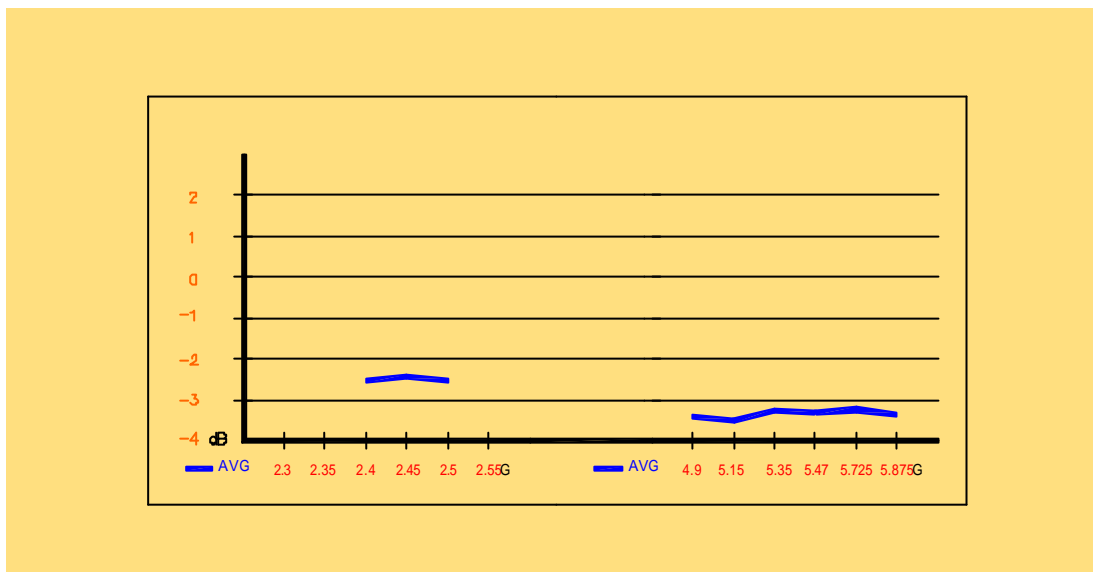

Antenna	AVG GAIN(H+E)		
	2.4GHz	2.45GHz	2.5GHz
E-BOOK	-2.56	-2.48	-2.54

Antenna	AVG GAIN(H+E)					
	4.9GHz	5.15GHz	5.35GHz	5.47GHz	5.725GHz	5.875GH
E-BOOK	-3.47	-3.45	-3.38	-3.39	-3.35	-3.33

**Antenna Packaging**

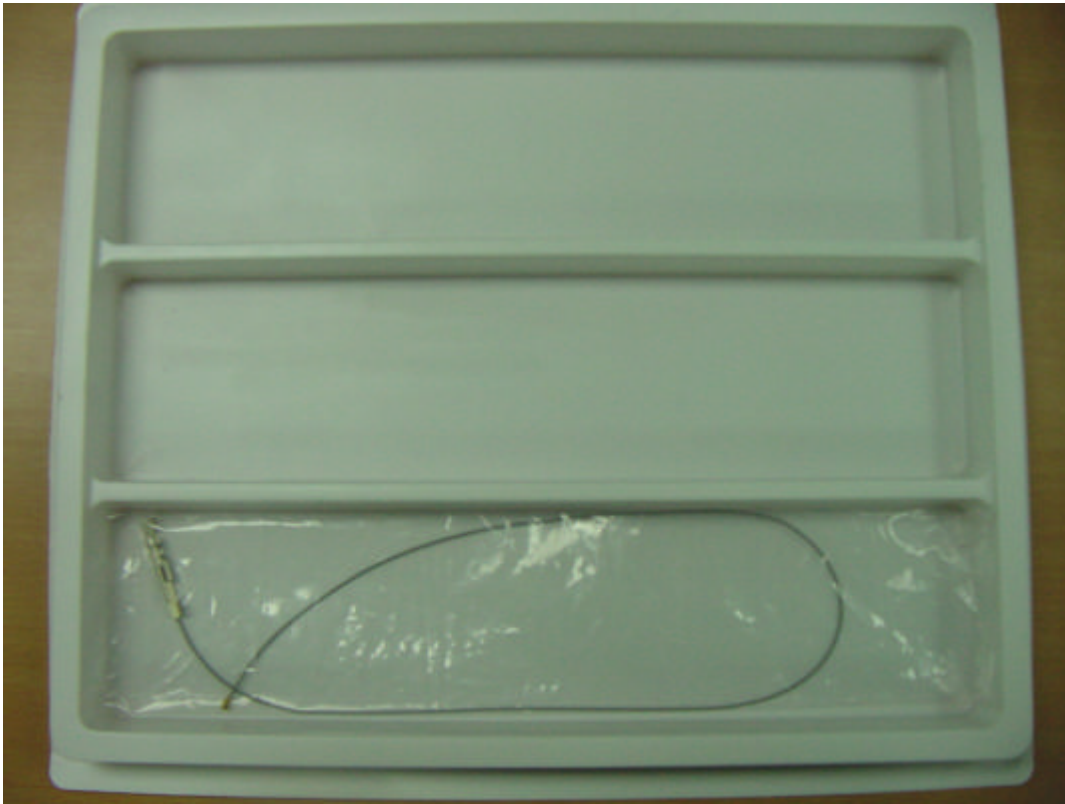

材料証明書  
MATERIAL CERTIFICATE

当社製品には下記の材料が使われている事を証明致します。

WE HEREBY CERTIFY THAT THE FOLLOWING MATERIALS ARE USED IN OUR PRODUCT.

PRODUCT NAME : MHF series micro coaxial connector PLUG      P/N 20278-\*\*1R-\*\*  
20308-\*\*1R-\*\*

	部品 COMPONENT	材料/MATERIAL			UL94難燃性 UL94 FLAME CLASS	ULファイルNo. UL FILE No.
		材質名 MATERIAL	型名 CAT No.	材料メーカ MANUFACTURER		
1	HOUSING	PBT	3116	WINTECH POLYMER LTD.	V-0	E 213445

PRODUCT NAME : MHF series micro coaxial connector RECEP.      P/N 20279-001E-01

	部品 COMPONENT	材料/MATERIAL			UL94難燃性 UL94 FLAME CLASS	ULファイルNo. UL FILE No.
		材質名 MATERIAL	型名 CAT No.	材料メーカ MANUFACTURER		
1	HOUSING	LCP	E130i	POLYPLASTICS CO.,LTD.	V-0	E 106764

PRODUCT NAME : MHF II connector      P/N 20311-\*\*1R-08

	部品 COMPONENT	材料/MATERIAL			UL94難燃性 UL94 FLAME CLASS	ULファイルNo. UL FILE No.
		材質名 MATERIAL	型名 CAT No.	材料メーカ MANUFACTURER		
1	HOUSING	LCP	A430	POLYPLASTICS CO.,LTD.	V-0	E 106764

株式会社アイペックス  
I-PEX Co.,Ltd.

APPROVAL	CHECK	ORIGINATOR
K.Katabuchi Oct/02/'02	E.Kawabe Oct/02/'02	A.Hino Oct/02/'02

FORM REV.0

**PRODUCT SPECIFICATION**

製品規格

No. PRS-1176

**MHF series micro coaxial connector**

( Product No. Plug 20278, Rec. 20279)

Qualification Test Report No. TR-1021

7	S3008	K.O	MAR/24/'03	K.K			
6	S2084	K.O	DEC/19/'02	K.K			
5	S2082	K.O	DEC/05/'02	K.K	Prepared by	Reviewed by	Approved by
4	S2076	K.O	Oct/17/'02	E.K	K.Ohbayashi	E,Kawabe	K.Katabuchi
3	S2064	A.H	Sep/10/'02	K.K			
REV.	ECN	BY	DATE	APP.			
REVISION RECORD							

Form Rev. 0

DOCUMENT CLASSIFICATION Product Specification 製品規格	TITLE MHF series micro coaxial connector	No. PRS-1176
<p>1. Scope / 序言 MHF series micro coaxial connector is a wire to board connector for AWG#36,32,30 coaxial cable . MHF series micro coaxial connector は、AWG # 36,32,30同軸ケーブルの基板対ワイヤーコネクタである。</p> <p>2. Objectives / 目的 This specification covers the requirements for product performance and test methods of MHF series microcoaxial connector 本規格は、MHF series micro coaxial connector の性能と試験条件について規定する。</p> <p>3. Part No. , construction , material and finish / 構成、材料及び仕上げ (1) Part No. Plug : 20278- * * * R-08,-13,-32,-18 , Receptacle : 20279-001E-01 (2) Construction, material and finish of the connector are covered as each drawings. 構成、材料及び仕上げは、各図面に指定されている通りとする。</p> <p>4. Applicable cable / 適合ケーブル 4-1 Part No. 20278-101R-08, 20278-111R-08 (1) Description Inner conductor : AWG#36(7/0.05) Silver plating annealed copper wire or silver plating tin-copper alloy Dielectric core : Fluoro-plastics ,diameter 0.4(+0.04,-0.02)mm , nominal thickness 0.125mm Outer conductor : 8/5/0.05 , nominal diameter 0.65mm , silver plating annealed copper wire Jacket : Fluoro-plastics , diameter 0.81(+0.04,-0.02)mm , nominal thickness 0.08mm (2) Requirements Characteristic impedance : 50(+2,-2)ohm by TDR method Nominal capacitance(Reference value): 96 pF/m Conductor resistance of inner conductor at 293K (20°C)(Reference value) : 1400 ohm/km Insulation resistance : 1000 mega-ohm.km MIN. Dielectric withstand voltage : no breakdown at AC1000V for 1 minutes. (1) 構成 中心導体 : AWG # 36 (7 / 0.05), 銀メッキ軟銅線または銀メッキすず入り銅線 誘電体 : フッ素樹脂, 外径0.4 (+0.04, -0.02), 標準厚さ0.125mm 外部導体 : 8 / 5 / 0.05, 標準外径0.65mm, 銀メッキ軟銅線 ジャケット : フッ素樹脂, 外径0.81 (+0.04, -0.02)mm, 標準厚さ0.08mm (2) 仕様 特性インピーダンス : 50 ± 2 Ω (TDR) 標準静電容量(参考値) : 96pF / m 293K (20°C)時の中心導体導体抵抗(参考値) : 1400 Ω / km 絶縁抵抗 : 1000M Ω · km以上 耐電圧 : AC1000V・1分間にて絶縁破壊の無い事</p> <p>4-2 Part No. 20278-101R-13, 20278-111R-13 (1) Description Inner conductor : AWG#32(7/0.08) Silver plating annealed copper wire or silver plating tin-copper alloy Dielectric core : Fluoro-plastics , diameter 0.68(+0.04,-0.02)mm , nominal thickness 0.22mm Outer conductor : 16/4/0.05 , nominal diameter 0.93mm , silver plating annealed copper wire Jacket : Fluoro-plastics , diameter 1.13(+0.08,-0.05)mm , nominal thickness 0.1mm</p>		





DOCUMENT CLASSIFICATION Product Specification 製品規格	TITLE MHF series micro coaxial connector	No. PRS-1176
<p>4-4 Part No. 20278-101R-18, 20278-111R-18 RG178 B/U</p> <p>(1) Description  Inner conductor : AWG#30(7/0.102) , silver plating copper clad steel wire  Dielectric core : Fluoro-plastics , diameter 0.84(+0.03,-0.03)mm , nominal thickness 0.268mm  Outer conductor : 16/3/0.1 , nominal diameter 1.35mm , silver plating copper wire  Jacket : Fluoro-plastics , diameter 1.8(+0.1,-0.1)mm , nominal thickness 0.23mm</p> <p>(2) Requirements  Characteristic impedance : 50(+2,-2)ohm by TDR method  Nominal capacitance(Reference value): 95 pF/m  Conductor resistance of inner conductor at 293K (20°C) (Reference value) : 805 ohm/km  Insulation resistance : 1500 mega-ohm.km MIN.  Dielectric withstand voltage : no breakdown at AC2000V for 1 minutes.</p> <p>(1) 構成  中心導体 : AWG # 30 (7 / 0.102), 銀メッキ銅被鋼線  誘電体 : フッ素樹脂, 外径0.84(±0.03), 標準厚さ0.268mm  外部導体 : 16 / 3 / 0.1, 標準外径1.35mm, 銀メッキ軟銅線  ジャケット : フッ素樹脂, 外径1.8(±0.1)mm, 標準厚さ0.23mm</p> <p>(2) 仕様  特性インピーダンス : 50 ± 2 Ω (TDR)  標準静電容量(参考値) : 95pF / m  293K(20°C)時の中心導体導体抵抗(参考値): 805 Ω / km  絶縁抵抗 : 1500M Ω · km以上  耐電圧 : AC2000V・1分間にて絶縁破壊の無い事</p> <p>5. Ratings / 定格  (1) Rated voltage / 電圧 : AC60Vrms  (2) Nominal characteristic impedance / 公称特性インピーダンス : 50 Ω  (3) Frequency / 周波数 : DC~6GHz  (4) VSWR : Plug 1.3 MAX at 0.1~3GHz 1.5 MAX at 3~6GHz  Receptacle 1.3 MAX at 0.1~3GHz 1.4 MAX at 3~6GHz  (5) Service Temperature / 使用温度範囲 : 233~363K (-40~+90°C)</p> <p>6. Test methods and performance / 試験及び性能</p> <p>6-1 Test condition / 試験条件  Unless otherwise specified, all tests and measurements shall be performed under the following conditions in accordance with MIL-STD-202  全ての測定と試験は、MIL-STD-202に基づき以下の条件で行う。  Temperature / 温度 : 288~308K (15~35°C)  Humidity / 湿度 : 45~75%RH</p>		

DOCUMENT CLASSIFICATION	TITLE	No.
Product Specification 製品規格	MHF series micro coaxial connector	PRS-1176

## 6-2-1 Electrical / 電気的性能

## (1) Contact Resistance / 接触抵抗

A. Testing: Solder the receptacle connector to the test board and mate the plug connector together, then measure the contact resistance as shown in Fig.1 by the four terminal method.

Apply the low level condition in accordance with MIL-STD-202, Method 307.

Open circuit voltage : 20mV MAX

Circuit current : 10mA MAX. (DC or AC1kHz)

Contact resistance of inner contact : <resistance of A-E> - <resistance of B-E>

Contact resistance of ground contact : <resistance of A-D> - <resistance of B-D>

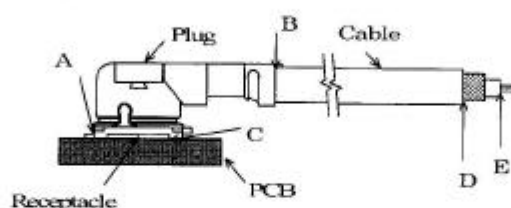

Fig. 1

## B. Requirements :

Contact resistance of inner contact initial 20 milli-ohm MAX. after testing 25milli-ohm MAX.

Contact resistance of ground contact initial 10 milli-ohm MAX. after testing 15milli-ohm MAX.

A. 試験法: テスト基板にリセプタクルコネクタを半田付けし、プラグコネクタと嵌合させ、Fig. 1のように4端子法にて下記の条件で測定する。MIL-STD-202 試験法 307 に準拠。

開回路電圧: 20mV以下

試験電流 : 10mA (DCもしくはAC1kHz)

中心導体 : <A-E間の電気抵抗> - <B-E間の電気抵抗>

外部導体 : <A-D間の電気抵抗> - <B-D間の電気抵抗>

B. 必要条件: 中心導体 初期 20mΩ 以下, 試験後 25mΩ 以下

外部導体 初期 10mΩ 以下, 試験後 15mΩ 以下

## (2) Insulation resistance / 絶縁抵抗

A. Testing : Mate the plug and receptacle connector together, then apply DC 100 V between the inner contact and the ground contact in accordance with MIL-STD-202, Method 302.

B. Requirements : Initial 500 Mohm MIN. after testing 100 Mohm MIN.

A. 試験法: リセプタクル及びプラグコネクタを互いに嵌合させ、中心導体と外部導体の間に DC 100Vを印加し、測定する。MIL-STD-202 試験法 302 に準拠。

B. 必要条件: 初期 500MΩ 以上 試験後 100MΩ 以上

## (3) Dielectric withstanding voltage / 耐電圧

A. Testing : Mate the receptacle and plug connector together, then apply AC 200 Vrms between the inner contact and the ground contact for a minute in accordance with MIL-STD-202, Method 301.

B. Requirements : No creeping discharge, flashover, nor insulator breakdown shall occur.

A. 試験法: リセプタクル及びプラグコネクタを互いに嵌合させ、中心導体と外部導体の間にAC200V(実効値)を一分間印加する。MIL-STD-202 試験法 301 に準拠。

B. 必要条件: 浴面放電、空中放電、絶縁破壊等の異常のないこと。

DOCUMENT CLASSIFICATION	TITLE	No.
Product Specification 製品規格	MHF series micro coaxial connector	PRS-1176

## (4) VSWR

A. Testing : Measure the VSWR as shown in Fig.3 by the network analyzer.  
Frequency : 100M~6GHz

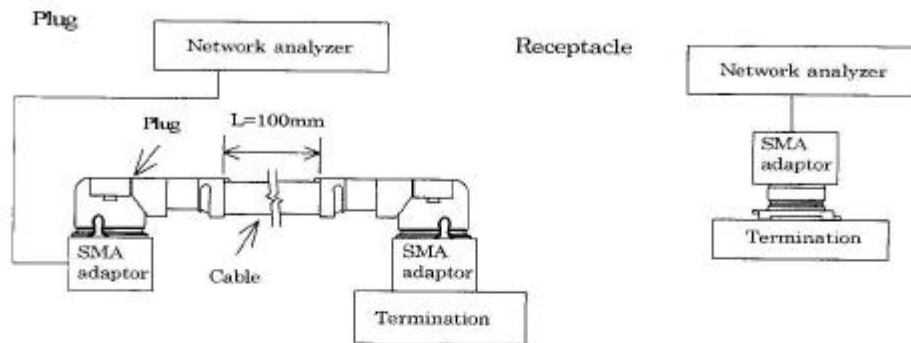

Fig.3

B.Requirements : Plug 1.3 MAX at 0.1~3GHz 1.5 MAX at 3~6GHz  
Receptacle 1.3 MAX at 0.1~3GHz. 1.4 MAX at 3~6GHz

A. 試験法: ネットワークアナライザーにて Fig.3 のようにVSWRを測定する。  
周波数 : 100M~6GHz

B.必要条件: Plug 1.3以下 0.1~3GHz 1.5以下 3~6GHz  
Receptacle 1.3以下 0.1~3GHz 1.4以下 3~6GHz

## 6-2-2 Mechanical / 機械的性能

## (1) Unmating force / 抜去力

A. Testing : Unmate the receptacle connector ( soldered to the test board) and plug at a speed  $25 \pm 3$ mm/minutes along the mating by the push-on/pull-off machine .

B.Requirements :

Total unmating force : Initial 5N MIN. after 30 cycles 3N MIN.

Unmating force of inner contact : Initial 0.15N MIN. after 30 cycles 0.1N MIN

A. 試験法: 挿抜試験機を用いて、基板に半田付けしたリセプタクルとプラグを嵌合軸と平行に毎分 $25 \pm 3$ mmの速度で挿抜する。

B.必要条件:

総合抜去力: 初回抜去力 5N以上 ,30回後抜去力 3N以上

中心導体 : 初回抜去力 0.15N以上 ,30回後抜去力 0.1N以上

## (2) Crimp strength / 引張強度

A. Testing : Pull the cable as shown in Fig.5 at a speed  $25 \pm 3$ mm/minutes by tensile strength machine.

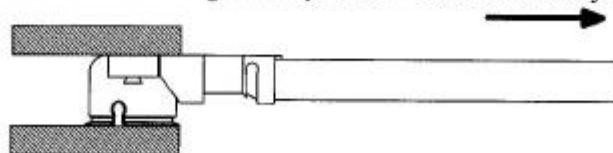

Fig.5

B.Requirements : 20278-1\*1R-08,13,32 : 10N MIN, 20278-1\*1R-18 : 15N MIN,

A. 試験法: 引張試験機を用いて、毎分 $25 \pm 3$ mmの速度でケーブルを引張り、強度を測定する。

B.必要条件: 20278-1\*1R-08,13,32 : 10N以上, 20278-1\*1R-18 : 15N以上

DOCUMENT CLASSIFICATION Product Specification 製品規格	TITLE MHF series micro coaxial connector	No. PRS-1176
<p>(3) Durability / 耐久性</p> <p>A. Testing : Mate and umate the receptacle connector ( soldered to the test board) and plug 30 cycles at a speed <math>25 \pm 3</math>mm/minutes along the mating by the push-on/pull-off machine .</p> <p>B.Requirements :</p> <p>Contact resistance of inner contact initial 20 milli-ohm MAX. after testing 25milli-ohm MAX. Contact resistance of ground contact initial 10 milli-ohm MAX. after testing 15milli-ohm MAX.</p> <p>A.試験法:挿抜試験機を用いて、基板に半田付けしたリセプタクルとプラグを嵌合軸と平行に毎分<math>25 \pm 3</math>mmの速度で30回挿抜する。</p> <p>B.必要条件 中心導体接触抵抗 : 初期 20mΩ 以下, 試験後 25mΩ 以下 外部導体接触抵抗 : 初期 10mΩ 以下, 試験後 15mΩ 以下</p> <p>(4) Cable retention force / ケーブル保持力</p> <p>A. Testing : Apply force on the cable as shown in Fig.2. During the testing, run 100mA DC to check electrical discontinuity.</p> <div data-bbox="491 824 1141 1086" data-label="Diagram"> </div> <p style="text-align: center;">Fig.2</p> <p>B.Requirements</p> <p>Appearance : Looseness between the parts, chipping, breakage or other abnormality shall not occur. Electrical discontinuity : No electrical discontinuity grater than 1 micro-sec. shall occur. Contact resistance of inner contact initial 20 milli-ohm MAX. after testing 25milli-ohm MAX. Contact resistance of ground contact initial 10 milli-ohm MAX. after testing 15milli-ohm MAX.</p> <p>A.試験法:Fig. 2のようにケーブルに力を加える。尚、試験中にDC100mAの電流を流して電氣的瞬断を確認する。</p> <p>B.必要条件 外観 : 部品のゆるみ、欠け、割れ、その他外観上の異常の無いこと。 電流瞬断 : 試験中、1 マイクロ秒を超える電氣的瞬断の無いこと。 中心導体接触抵抗 : 初期 20mΩ 以下, 試験後 25mΩ 以下 外部導体接触抵抗 : 初期 10mΩ 以下, 試験後 15mΩ 以下</p> <p>(5) Vibration / 振動</p> <p>A. Testing : Apply the following vibration to the mating connector . During the testing, run 100mA DC to check electrical discontinuity. Frequency : 10Hz → 100Hz → 10Hz / approx 15 minutes. Half amplitude ,Peak value of acceleration: 1.5mm or <math>59\text{m/s}^2</math> (6G) Directions , cycle : 3 mutually perpendicular direction , 5 cycles(approx 75min )about each direction</p> <p>B.Requirements</p> <p>Appearance : Looseness between the parts, chipping, breakage or other abnormality shall not occur. Electrical discontinuity : No electrical discontinuity grater than 1micro-sec. shall occur. Contact resistance of inner contact initial 20 milli-ohm MAX. after testing 25milli-ohm MAX. Contact resistance of ground contact initial 10 milli-ohm MAX. after testing 15milli-ohm MAX.</p>		

DOCUMENT CLASSIFICATION	TITLE	No.
Product Specification 製品規格	MHF series micro coaxial connector	PRS-1176
<p>A.試験法: 嵌合状態のコネクタを、下記の振動を加える。尚、試験中にDC100mAの電流を流して電氣的瞬断を確認する。  周波数 : 10Hz→100Hz→10Hz / 約15分間  片振幅,加速度: 1.5mm or 59m/s<sup>2</sup> (6G)  方向,サイクル: 3つの互いに直角な方向について各5サイクル(約75分)実施</p> <p>B.必要条件 外観 : 部品のゆるみ、欠け、割れ、その他外観上の異常の無いこと。  電流瞬断 : 試験中、1マイクロ秒を超える電氣的瞬断の無いこと。  中心導体接触抵抗 : 初期 20mΩ 以下、試験後 25mΩ 以下  外部導体接触抵抗 : 初期 10mΩ 以下、試験後 15mΩ 以下</p> <p>(6) Shock / 衝撃</p> <p>A. Testing : Apply the following vibration to the mating connector in accordance with MIL-STD-202, Method 213, Condition B. During the testing, run 100mA DC to check electrical discontinuity.  Peak value of acceleration: 735m/s<sup>2</sup> (75G)  Duration : 11msec  Wave Form : half sinusoidal  Directions , cycle : 6 mutually perpendicular direction , 3 cycles about each direction</p> <p>B.Requirements  Appearance : Looseness between the parts, chipping, breakage or other abnormality shall not occur.  Electrical discontinuity : No electrical discontinuity grater than 1 micro-sec. shall occur.  Contact resistance of inner contact initial 20 milli-ohm MAX. after testing 25milli-ohm MAX.  Contact resistance of ground contact initial 10 milli-ohm MAX. after testing 15milli-ohm MAX.</p> <p>A.試験法: 嵌合状態のコネクタを、衝撃試験機に取り付け、下記の衝撃を加える。尚、試験中にDC100mAの電流を流して電氣的瞬断を確認する。MIN-STD-202 試験法 213 試験条件 B に準拠。  最大加速度 : 735m/s<sup>2</sup> (75G)  標準持続時間 : 11msec.  波形 : 半波正弦波  方向 : 直交する6方向、各3回</p> <p>B.必要条件 外観 : 部品のゆるみ、欠け、割れ、その他外観上の異常の無いこと。  電流瞬断 : 試験中、1マイクロ秒を超える電氣的瞬断の無いこと。  中心導体接触抵抗 : 初期 20mΩ 以下、試験後 25mΩ 以下  外部導体接触抵抗 : 初期 10mΩ 以下、試験後 15mΩ 以下</p> <p>6-2-3 Environmental / 耐環境性</p> <p>(1) Thermal shock/ 温度サイクル</p> <p>A. Testing : Apply the following environment to the mating connector .  Temperature ,duration  :233K/30minutes→278~308K/5minutes MAX.→363K/30minutes→278~308K/5minutes MAX.  (-40℃) (5~35℃) (90℃) (5~35℃)  No. of cycles : 5 cycles</p> <p>B.Requirements  Appearance : Looseness between the parts, chipping, breakage or other abnormality shall not occur.  Contact resistance of inner contact initial 20 milli-ohm MAX. after testing 25milli-ohm MAX.  Contact resistance of ground contact initial 10 milli-ohm MAX. after testing 15milli-ohm MAX.  Insulation resistance : initial 500 mega-ohm MIN. after testing 100 mega-ohm MIN.</p>		

DOCUMENT CLASSIFICATION Product Specification 製品規格	TITLE MHF series micro coaxial connector	No. PRS-1176
<p>A.試験法: 嵌合状態のコネクタを、下記の雰囲気中に放置する。 1サイクルの条件 : 233K / 30分 → 278~308K / 5分以下 → 363K / 30分 → 278~308K / 5分以下 (-40℃) (5~35℃) (90℃) (5~35℃) 実施サイクル : 5サイクル</p> <p>B.必要条件 外観 : 部品のゆるみ、欠け、割れ、その他外観上の異常の無いこと。 中心導体接触抵抗 : 初期 20m Ω 以下, 試験後 25m Ω 以下 外部導体接触抵抗 : 初期 10m Ω 以下, 試験後 15m Ω 以下 絶縁抵抗 : 初期 500M Ω 以上 試験後 100M Ω 以上</p> <p>(2) Humidity / 湿度</p> <p>A. Testing : Apply the following environment to the mating connector in accordance with MIL-STD-202, Method 103, Condition B. Temperature : 313 ± 2 K (40 ± 2℃) Humidity : 90~95%RH Duration : 96 hours</p> <p>B. Requirements Appearance : Looseness between the parts, chipping, breakage or other abnormality shall not occur. Contact resistance of inner contact initial 20 milli-ohm MAX. after testing 25milli-ohm MAX. Contact resistance of ground contact initial 10 milli-ohm MAX. after testing 15milli-ohm MAX. Insulation resistance : initial 500 mega-ohm MIN. after testing 100 mega-ohm MIN.</p> <p>A.試験法: 嵌合状態のコネクタを、下記の雰囲気中に放置する。MIL-STD-202 試験法 103 条件 B に準拠。 温度: 313 ± 2K (40 ± 2℃) 湿度: 90~95%RH 時間: 96時間</p> <p>B.必要条件 外観 : 部品のゆるみ、欠け、割れ、その他外観上の異常の無いこと。 中心導体接触抵抗 : 初期 20m Ω 以下, 試験後 25m Ω 以下 外部導体接触抵抗 : 初期 10m Ω 以下, 試験後 15m Ω 以下 絶縁抵抗 : 初期 500M Ω 以上 試験後 100M Ω 以上</p> <p>(3) Salt water spray / 塩水噴霧</p> <p>A. Testing : Apply the following environment to the mating connector in accordance with MIL-STD-202, Method 101, Condition B. Temperature : 308 ± 2 K (35 ± 2℃) Salt water density by weight : 5 ± 1% Duration : 48 hours</p> <p>B. Requirements : Appearance no abnormality adversely affecting the performance shall occur.</p> <p>A.試験法: 嵌合状態のコネクタを、下記の雰囲気中に放置する。 温度 : 308 ± 2K (35 ± 2℃) 塩水濃度: 5 ± 1% (重量比) 時間 : 48時間</p> <p>B.必要条件 : 外観 著しい腐食の無い事。</p>		



DOCUMENT CLASSIFICATION	TITLE	No.
Product Specification 製品規格	MHF series micro coaxial connector	PRS-1176

## (4) High temperature life / 高温

A. Testing : Apply the following environment to the mating connector.

Temperature :  $363 \pm 2$  K ( $90 \pm 2^\circ\text{C}$ ) Duration : 96 hours

## B. Requirements

Appearance : Looseness between the parts, chipping, breakage or other abnormality shall not occur.

Contact resistance of inner contact initial 20 milli-ohm MAX. after testing 25milli-ohm MAX.

Contact resistance of ground contact initial 10 milli-ohm MAX. after testing 15milli-ohm MAX.

A.試験法:嵌合状態のコネクタを、下記の雰囲気放置する。

温度: $363 \pm 2$ K ( $90 \pm 2^\circ\text{C}$ ) 時間:96時間

B.必要条件 外観 : 部品のゆるみ、欠け、割れ、その他外観上の異常の無いこと。

中心導体接触抵抗 : 初期 20m  $\Omega$  以下, 試験後 25m  $\Omega$  以下

外部導体接触抵抗 : 初期 10m  $\Omega$  以下, 試験後 15m  $\Omega$  以下

## 6-2-4 Solder / 半田付け関連

## (1) Solderability / 半田付け性

A. Testing : Dip the solder tine of the contact in the solder bath at  $518 \pm 5$  ( $245 \pm 5^\circ\text{C}$ ) for  $5 \pm 0.5$  sec.

After immersing the tine in the flux of RMA or R type for 5 to 10 seconds in accordance with MIL-STD-202, Method 208.

B. Requirements : More than 95% of the dipped surface shall be evenly wet.

A.試験法:コンタクトの半田付け部を $518 \pm 5$ K ( $245 \pm 5^\circ\text{C}$ )の半田槽内に $5 \pm 0.5$ 秒浸す。フラックスは、RMA

又はR型を使用し5~10秒間浸すものとする。MIL-STD-202, 試験法 208 に準拠。

B.必要条件: 浸した面積の95%以上に半田がむらなく付着すること。

## (2) Reflow soldering heat resistance / 半田耐熱性

A. Testing : Put on the receptacle connector to PCB, apply the heat 2 cycles as shown in Fig. 4

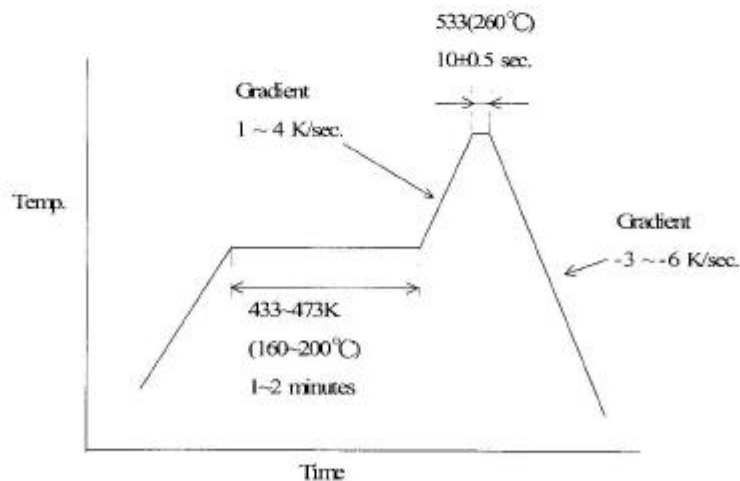

Fig.4

B. Requirements : Appearance no abnormality adversely affecting the performance shall occur.

A.試験法:基板にリセプタクルコネクタを置き、Fig. 4の条件で2回リフローを行う。

B.必要条件:機能を損なう変形及び欠陥の無い事。

DOCUMENT CLASSIFICATION Product Specification 製品規格	TITLE MHF series micro coaxial connector	No. PRS-1176
--	--	-----------------

## 6-2-5 試験順序と試料数 / Test Sequence and Sample Quantity

Test Item 試験項目	Group / グループ														
	A	B	C	D	E	F	G	H	I	L	M	N	O	P	
(1) Contact Resistance 接触抵抗					1 3	1 3	1 3	1 3	1 4	1 4		1 3			
(2) Insulation resistance 絶縁抵抗									2 5	2 5					
(3) Dielectric withstanding voltage 耐電圧	1														
(4) VSWR		1													
(5) Crimp strength 引張強度			1												
(6) Unmating force 抜去力				1											
(7) Durability 耐久性					2										
(8) Cable retention force ケーブル保持力						2									
(9) Vibration 振動							2								
(10) Shock 衝撃								2							
(11) Thermal shock 温度サイクル									3						
(12) Humidity 湿度										3					
(13) Salt water spray 塩水噴霧											1				
(14) High temperature life 高温												2			
(15) Solderability 半田付け性													1		
(16) Reflow soldering heat resistance 半田耐熱性														1	
Sample QTY pcs. 試料数	Plug プラグ	10	5	10	10	10	10	10	10	10	10	10	10	----	----
	Receptacle リセプタクル	10	5	----	10	10	10	10	10	10	10	10	10	10	10
Test Board 基板数	pcs.	10	5	----	10	10	10	10	10	10	10	10	10	----	10



FROM : WEL HARVEST METAL CO LTD

FAX NO. : 886229992628

Mar. 23 2004 10:10AM P1

**試験成績表**  
**TEST REPORT**

88

御客先名 CUSTOMER NAME WELL HARVEST 御中  
代理店名 AGENT NAME 御中

**三菱電機メテックス株式会社**  
〒229-1196 神奈川県横浜市長谷1丁目1番67号  
電話 042 (779) 5583  
MITSUBISHI ELECTRIC METECS Co., Ltd.  
1-1-67 MIYASHIMO, SAGAMIHARA,  
KANAGAWA 229-1196, JAPAN

品名 PRODUCT NAME	C7521R	H	製造番号 LOT No.	263363	発行年月日 ISSUE DATE	2004/02/02
寸法 SIZE	0.300* 438.000*		納入数量 QUANTITY		試験年月日 TEST DATE	2003/11/19

化学成分 CHEMICAL COMPOSITION

成分記号 ELEMENT	NI	Cu	Zn
規格 SPEC. (%)	MAX. 19.50	66.00	—
	MIN. 16.50	62.00	—
分析値 ANALYSIS VALUE	19.410	65.220	17.622

試験 TEST RESULT

項目 ITEM	引張強さ Tensile Strength N/mm <sup>2</sup>	伸び Elongation %	硬さ Hardness HV
規格 SPEC.	MAX.		208.0000
	MIN. 540.0000	3.0000	180.0000
測定値 MEASUREMENT VALUE	578.000	11.600	182.000

項目 ITEM	引張強さ Tensile Strength N/mm <sup>2</sup>	伸び Elongation %	硬さ Hardness HV
規格 SPEC.	MAX.		
	MIN.		
測定値 MEASUREMENT VALUE			

項目 ITEM	条件 CONDITION	測定値 MEASUREMENT VALUE

備考 REMARKS

検査合格/PASS

規格番号 SPEC. NO. 1246000006 A  
顧客仕様書番号 CUSTOMER'S SPEC. NO. JIS H 3110

*X. Kuboyama*

MANAGER of  
QUALITY ASSURANCE SECTION

責任者	担当者
	

# SUMIPAC CORPORATION

## APPLIED POLYMER PRODUCTS DIV.

13F-1, No. 34 CHUNG SAN NORTH ROAD, SECT. 3, TAIPEI, TAIWAN

TEL: 886-2-25997382 • Fax : 886-2-25997377

Aug. 13, 2003

**TO whom it may concern:**

### CERTIFICATE OF MATERIAL

We certify hereby that SUMITUBE A, manufactured by "SUMIPAC CORPORATION", conform fully with the requirement of all applicable specification, drawing, standards. Besides, the pertinent test data and/or inspection records on file are available for inspection upon request by appropriate authority.

Also, SUMITUBE A does not contain any ODC's (ozone-depleted materials), and never contain odc's during manufacturing process, and conforms to the requirement concerning toxicity as below.

Name of Products	SUMITUBE A																
Material Generic Name	Irradiated Heat-Shrinkable Polyolefin Tubing																
Manufacturer	SUMIPAC CORPORATION																
Toxicity	<p>SUMITUBE A meets the requirements of of Spec. EN1122 Method-B on Cadmium &amp; EPA3050B · EPA6010B or EPA6020 on Lead, and EN71-Part3 on the following heavy metals:</p> <table><tr><td>1. Sol. Barium (BA)</td><td>&lt;1000 PPM</td></tr><tr><td>2. Sol. Lead (PB)</td><td>&lt;90 PPM</td></tr><tr><td>3. sol. Antimony(SB)</td><td>&lt;60 PPM</td></tr><tr><td>4. Sol. Cadmium (CD)</td><td>&lt;5 PPM</td></tr><tr><td>5. Sol. Selenium (SE)</td><td>&lt;500 PPM</td></tr><tr><td>6. Sol. Chromium (CR)</td><td>&lt;60 PPM</td></tr><tr><td>7. Sol. Mercury (HG)</td><td>&lt;60 PPM</td></tr><tr><td>8. Sol. Arsenic (As)</td><td>&lt;25 PPM</td></tr></table> <p>B. SUMITUBE A is free of Halogenated flame retardant materials and other toxic materials as below.</p> <p>Chrorinated Paraffin, Polychlorinated biphenyl category(PCB), Polychlorinated Naphthlene Category, Organic Tin Compounds, Asbestors, Azo Compounds, etc.</p>	1. Sol. Barium (BA)	<1000 PPM	2. Sol. Lead (PB)	<90 PPM	3. sol. Antimony(SB)	<60 PPM	4. Sol. Cadmium (CD)	<5 PPM	5. Sol. Selenium (SE)	<500 PPM	6. Sol. Chromium (CR)	<60 PPM	7. Sol. Mercury (HG)	<60 PPM	8. Sol. Arsenic (As)	<25 PPM
1. Sol. Barium (BA)	<1000 PPM																
2. Sol. Lead (PB)	<90 PPM																
3. sol. Antimony(SB)	<60 PPM																
4. Sol. Cadmium (CD)	<5 PPM																
5. Sol. Selenium (SE)	<500 PPM																
6. Sol. Chromium (CR)	<60 PPM																
7. Sol. Mercury (HG)	<60 PPM																
8. Sol. Arsenic (As)	<25 PPM																

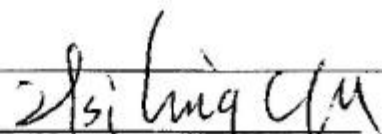
  
HSI LING YU, MANAGER  
SUMIPAC CORPORATION

住友電工（蘇州）電子線製品有限公司

SUMITOMO ELECTRIC INTERCONNECT PRODUCTS (SUZHOU) LTD.

中國 蘇州市新區金楓路 232 號 郵編：215129

No. 232 Jingfeng Road, SuZhou 215129, China

編 號

Spec. NO: IEE8-01026A (SZ)

客 戶：建舜電子製造股份有限公司

Customer :

# 規 格 書

## SPECIFICATION

LVCX 系列

LVCX SERIES

50 Ω (SUMIFLON®) 絕緣同軸電纜

50 Ω SUMIFLON® INSULATION COAXIAL CABLE

0.7DS-PBE (色)

0.7DS-PBE (COLOR)

編制日期/Date : 2003-03-22

編制/Signed by:

技術部 經理：顧京京

GU JINGJING

Manager of Engineering Section

## 1. 適用範圍

本規格書制定了 50Ω SUMIFLON®絕緣同軸電線的結構和電氣特性。

## 1. Scope

This specification covers the construction and the electrical properties of 50Ω SUMIFLON® Insulation Coaxial Cable.

[0.7DS-PBE (色)]

參考: 本公司日本工場規格書編號 IEE8-01026B

[0.7DS-PBE (COLOR)]

Ref: Our Japan Factory Spec. No IEE8-01026B

## 2. Construction/結構

Unit/單位: mm

Item/項目		Details/詳細資料
Conductor/導體	Material/材料	Silvered-Coated Copper Wire/鍍銀銅線
	Composition (No./mm) /構成 (根/mm)	7/0.079
	Nom. O. D (mm)/標稱外徑 (mm)	0.237(±0.03)
Insulation/絕緣層	Material/材料	SUMIFLON®P(Natural)/SUMIFLON®P(自然色)
	Nom. Thick (mm)/標稱絕緣厚度 (mm)	0.22
	Nom. O. D/標稱外徑	0.67(±0.03)
Shield/屏蔽層	Material/材料	Silvered-Coated Copper Wire/鍍銀銅線
	Composition/構成	Single Braid of 0.05/素線編織 0.05
Jacket/外被	Material/材料	SUMIFLON®E(Color)*/SUMIFLON®E(色)*
	Nom. Thick (mm)/標稱絕緣厚度 (mm)	0.11
	Nom. O. D (mm)/標稱外徑 (mm)	1.13(±0.05)

\*White, Black, Blue, Gray/白, 黑, 藍, 灰

## 3. Electrical Properties (at 20°C) /電氣特性(20°C時)

Item/項目	Unit/單位	Details/詳細資料
Conductor Resistance/導體阻抗	Ω/km	Max. 567
Insulation Resistance/絕緣阻抗	MΩ·km	Min. 305
Dielectric Strength/耐壓強度	V(AC)/min	500
Capacitance/靜電容址	pF/m	97±14.55(1KHz)
Characteristic Impedance/特性阻抗	Ω	50±2(TDR)
Attenuation**/衰減**	dB/m	Nom. 1.82(0.9GHZ)
		Nom. 2.37(1.5GHZ)
		Nom. 2.70(1.9GHZ)
		Nom. 3.05(2.4GHZ)
		Nom. 3.43(3.0GHZ)
		Nom. 3.94(4.0GHZ)
		Nom. 4.45(5.0GHZ)
		Nom. 5.16(6.0GHZ)

\*\* Maximum Value=Nom. Value×1.15/ 最大值=標稱值×1.15

4. 包裝

標準單位包裝長度為 500 米/盤，在搬運過程中不能損壞包裝。

4 - Packing

Standard unit length of finished cable shall be 500m on reel and shall be packed not to be damaged during transportation.

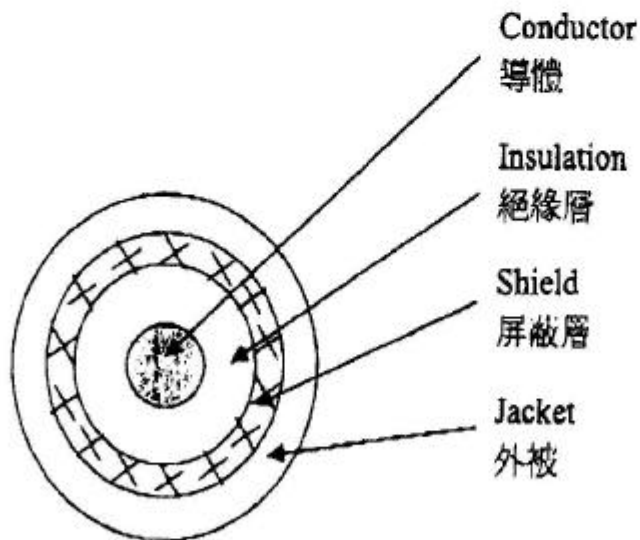

規格書完