

Exhibit E - User's Manual

A-SERIES NOTEBOOK OPERATOR'S MANUAL

3/2/98

P/N: 799001120000

R00

A-Series Notebook Operator's Manual

© Copyright by GETAC Corporation 1998. All rights reserved. No part of this publication may be reproduced by any means for any reason without express written approval from GETAC Corporation or its authorized representative.

GETAC Corporation makes no representations, either express or implied concerning the accuracy of this manual. All the information contained herein is believed to be complete and reliable as of the printing date. GETAC Corporation reserves the right to make changes to this manual or product specifications without obligation to notify any person of such changes.

IBM, IBM PC/AT and OS/2 are registered trademarks of International Business Machines Corporation.

Intel Pentium is a registered trademark of Intel Corporation.

MS-DOS, XENEX, Windows 95 and MS-Windows are registered trademarks of Microsoft Corporation.

UNIX is a registered trademark of AT&T Bell Laboratories.

Other brand and product names are trademarks and/or registered trademarks of their respective holders.

Class B Regulations

Federal Communications Commission Radio Frequency Interference Statement

NOTE:

This equipment has been tested and found to comply with the limits for a Class B digital device pursuant to Part 15 of the FCC Rules. These limits are design to provide reasonable protection against harmful interference in a residential installation. This equipment generates, uses, and can radiate radio frequency energy and, if not installed and used in accordance with the instructions, may cause harmful interference to radio communications. However, there is no guarantee that interference will not occur in a particular installation. If this equipment does cause harmful interference to radio or television reception, which can be determined by turning the equipment off and on, the user is encouraged to try to correct the interference by one or more of the following measures:

Reorient or relocate the receiving antenna.

Increase the separation between the equipment and receiver.

Connect the equipment into an outlet on a circuit different from that to which the receiver is connected.

Consult the dealer or an experienced radio/TV technician for help.

Any changes or modifications not expressly approved by the manufacturer could void the user's authority to operate the equipment.

Please note:

1. The use of a non-shielded interface cable with this equipment is prohibited.
2. A shielded AC power cord must be used with this equipment.

Products with the CE Marking comply with both the EMC Directive (89/336/EEC) and the Low Voltage Directive (73/23/EEC) issued by the Commission of the European Community.

Compliance with these directives implies conformity to the following European Norms:

- EN55022 (CISR 22)-Radio Frequency Interference
- EN50082-1 (IEC801-2, IEC801-3, IEC801-4)-Electromagnetic immunity
- EN60555-2 (IEC555-2)-Power Line Harmonics
- EN61000-3-3 (IEC1000-3-3)-Voltage Fluctuations and Flicker

CHANGE NO.	DATE	TITLE OR BRIEF DESCRIPTION	ENTERED BY
00	23, Feb, 1998	Initial Release	

Preface

This is the A-Series Notebook Operation Guide.

Contents

This manual contains information for personnel using the A-Series notebook computer. Readers should have a basic understanding of MS-DOS or any other operating system installed on the computer when reading this document. With the exception of the SETUP configuration program, which is part of the system firmware, this manual does not explain any of the software or devices used with the system. Supplemental manuals or text-based documents on the hard disk supply information about any software included with the system.

Audience

All operators using the notebook in or out of the field should read and become familiar with this manual.

Organization

This manual has five chapters.

Chapter 1 introduces the notebook pointing out its major features.

Chapter 2 explains daily operation.

Chapter 3 gives detailed information about configuring the notebook.

Chapter 4 presents maintenance procedures.

Chapter 5 describes system warning indications and gives troubleshooting guidance for simple problems.

Supplemental Reading

For further information about this computer and computing in general, use these references:

- Microsoft MS-DOS 6.0+ or upper version Manual for general information about the standard operating system for the notebook
- A-Series Service Manual for detailed troubleshooting and repair instructions for serious hardware problems associated with the A-Series notebook.
- Various software manuals offer detailed instructions about individual programs run on the notebook.

Specifications (reference only)

	Standard	Optional
CPU	Intel Pentium MMX 200 MHz	Intel Pentium MMX 233MHz or more
RAM	16MB	32,64, 128 MB
Display	18 bit color TFT 11.3" super VGA	9.4" morochrome 24 bit color TFT 13.3" XGA
Input Devices	<ul style="list-style-type: none"> 87-key shower proof and dust-proof rubber keyboard Embedded two-button Track Pad 	Backlight option
		Expansion Unit <ul style="list-style-type: none"> optional easy installed expansion unit (max. 20watts) for two 3/4 size ISA bus cards; or 3/4 size ISA bus card & one CD-ROM (same module as the one in Bay 1)
Communication ports	<ul style="list-style-type: none"> two RS-232C serial port One Centronics parallel port, support EPP/ECP One external monitor port One external PS/2 keyboard port One PS/2 mouse port One external power supply port One infrared port, IrDA compliance One 200-Pin docking port 	
Battery pack	<ul style="list-style-type: none"> removable & rechargeable main Ni-MH battery pack with the functions of on-line charge and hot swap (while 2nd or 3rd battery coexists), total 64 watts 	<ul style="list-style-type: none"> removable & rechargeable 2nd Ni-MH battery pack in Bay 1, total 41watts removable & rechargeable 3rd Ni-MH battery pack in Bay 2, total 41 watts
Power adapter	<ul style="list-style-type: none"> AC: 100-240 V, 50-60 Hz, 54 watts Vout 22.5V, -2%~+3%, 2.4A, CV mode Vout 2.1A~3.5A, 23.5V~10V, CPmode 	<ul style="list-style-type: none"> 12-26.4 VDC direct input without charging function 20-32 VDC external car adaptor/charger
Operating system		<ul style="list-style-type: none"> MS-DOS Windows 95 Windows NT
Temperature	<ul style="list-style-type: none"> Operating: 0°C to +50°C (tested) 	<ul style="list-style-type: none"> Option: -20°C to +50°C (tested)
Storage devices	<ul style="list-style-type: none"> removable shock proof & vibration-damaped 2.5" IDE HDD, capacity > 1.4GB 	<ul style="list-style-type: none"> removable shock proof & vibration-damaped 2.5" IDE HDD, capacity > 2.1GB optional removable 3.5" 1.44MB FDD, to install in Bay 1 internally (swap with either CD-ROM module or 2nd battery pack); or connected to parallel port with optional cable externally Optional CD-ROM module to be installed in Bay 1

A-Series Notebook Operator's Manual

Size	310mm (31 cm) W 66mm (6.6 cm) H 255mm (25.5 cm) D	
Weight	11.24 lbs (5.1kg)	

Safety Summary

1. Read these instructions before using or working on this computer.
2. Follow all warnings and instructions in this manual or marks on the computer and its components.
3. Avoid submerging the system unit in liquids.
4. avoid stacking papers or other flammable objects on top of, underneath, or next to the system unit.
5. Use only batteries supplied with the system.
6. Make sure any external power source connected to the adapter or system conforms with adaptor or system ratings.
7. The external power adapter has a three-pronged grounding plug. If an adapter is needed to plug the system into a power source, make sure the system is properly grounded.
8. Arrange all cables so that they are out of traffic and unobstructed by personnel or equipment.
9. Avoid using extension cords with this product. If an extension cord is needed, make sure it is rated for at least 10 amperes.
10. Make sure amperage drawn by all items plugged into an outlet with this system does not exceed 15 amperes.
11. Do not put any objects except those designed for use with this system inside the computer.
12. Observe proper electrical safety precautions when performing system maintenance.
13. Replace any cables with identically rated cables as those included with the original equipment.
14. Improper handling of the battery can cause personal injury or fires. Do not attempt to disassemble or replace individual cells in the battery pack. Do not expose the battery to open flames. Do not short the positive and negative ends together even if the battery is fully discharged. Keep the battery away from children.

Table of Contents

Preface

Contents	e
Audience.....	e
Organization	e
Supplemental Reading.....	e

Specifications

Specifications	f
----------------------	---

Safety Summary

Safety Summary	h
----------------------	---

Chapter 1 System Overview

1-1	Introduction	1-1
1-2	System Description.....	1-1
1-3	System Configuration	1-1
	1-3.1 Standard Configuration	1-1
	1-3.2 Options and Accessories	1-2
	1-3.3 System Identification	1-2
	1-3.4 CPU Jumper Setting	1-2
1-4	Unpacking	1-3
1-5	Notebook Features.....	1-3
	1-5.1 Cover	1-3
	1-5.2 Display.....	1-3
	1-5.3 Power Switch	1-4
	1-5.4 Keyboard.....	1-4
	1-5.5 Pointing Device.....	1-6
	1-5.6 Brightness Control	1-6
	1-5.7 CRT/LCD Switch	1-6

1-5.8	Status Row.....	1-6
1-5.9	Battery Pack.....	1-7
1-5.10	Low Battery Indication	1-7
1-5.11	Battery Charger.....	1-7
1-5.12	CHARGE LED Indicator Status.....	1-8
1-5.13	Diskette Drive and CD-ROM	1-8
1-5.14	PCMCIA Slot and Diskette Drive and CD-ROM Door	1-9
1-5.15	PCMCIA Slot	1-9
1-5.16	External Power Source Port	1-9
1-5.17	Serial Port.....	1-9
1-5.18	Printer Port	1-9
1-5.19	VGA Port.....	1-9
1-5.20	IrDA Port.....	1-10
1-5.21	Keyboard Port.....	1-10
1-5.22	Mouse Port	1-10
1-5.23	Hard Disk	1-10
1-5.24	External Power Adapter	1-10

Chapter 2 Operation

2-1	Introduction.....	2-1
2-2	Opening and Closing the Notebook	2-1
2-2.1	Opening the Cover.....	2-1
2-2.2	Closing the Cover.....	2-1
2-2.3	Opening the PCMCIA/FDD/CD-ROM Door.....	2-1
2-2.4	Shutting the PCMCIA/FDD/CD-ROM Door.....	2-2
2-3	Connecting and Installing Devices	2-2
2-3.1	Serial and Parallel Port.....	2-2
2-3.2	External Power Adapter	2-3
2-3.3	Diskettes.....	2-3
2-3.4	Remove the Floppy Diskette and CD-ROM.....	2-4
2-3.5	PCMCIA Cards	2-5
2-3.6	Hard Disk	2-6
2-4	First Time Use.....	2-7
2-4.1	Configuring the System.....	2-7
2-4.2	Installing Software Driver	2-7
2-5	Daily Operation.....	2-17
2-5.1	Starting the Computer	2-17
2-5.2	Turning Off The Notebook.....	2-18
2-5.3	Using the Notebook in the Car	2-18
2.6	Using External Power Sources	2-19
2-6.1	Using AC External Adaptor	2-19
2-6.2	Charging the Batteries	2-19
2-7	Running On Battery Power	2-19

Chapter 3 The SETUP Program

3-1	Introduction.....	3-1
3-2	Running SETUP and Moving Around.....	3-1
3-2.1	Main.....	3-2
3-2.2	Advanced.....	3-5
3-2.3	Security	3-8
3-2.4	Power.....	3-10
3-2.5	Exit.....	3-11

Chapter 4 Notebook Maintenance

4-1	Introduction	4-1
4-2	Daily Use	4-1
4-3	Battery Maintenance.....	4-1
4-3.1	Conserving Power	4-1
4-3.2	Changing the Battery Pack	4-1
4-4	Cleaning	4-2

Chapter 5 Troubleshooting

5-1	Introduction.....	5-1
5-2	Warnings and Indications	5-1
5-2.1	CHARGE Light On	5-1
5-2.2	CHARGE Light Blinking.....	5-1
5-3	Common Problems.....	5-2
5-3.1	Error Messages.....	5-3
5-3.2	Startup.....	5-4
5-3.3	Keyboard and Point Device.....	5-5
5-3.4	Display.....	5-6
5-3.5	PCMCIA	5-7
APPENDIX A	Keyboard Layouts.....	A-1

List of Figures

Figure 1-1 A-Series Notebook, Front View.....	1-3
Figure 1-2 Rubber Keyboard.....	1-4
Figure 1-3 Cursor Control Keys.....	1-5
Figure 1-4 Track Pad Pointing Device.....	1-6
Figure 1-5 A-Series Status Row.....	1-6
Figure 1-6 Diskette Drive and CD-ROM.....	1-8
Figure 1-7 Rear Side View.....	1-9
Figure 2-1 Opening the Notebook.....	2-1
Figure 2-2 Opening a Door.....	2-2
Figure 2-3 Connecting the External Power, Serial & Parallel Ports.....	2-3
Figure 2-4 Removing a Diskette.....	2-4
Figure 2-5 Removing a FDD/CD-ROM.....	2-5
Figure 2-6 Removing a PCMCIA Cards.....	2-5
Figure 2-7 Removing a Hard Disk.....	2-6
Figure 2-8 Plug Car Power Cable in Notebook.....	2-18

List of Tables

Table 1-1 Standard A-Series Notebook Computer.....	1-1
--	-----

Notice

Please read this manual notice before reading the manual and follow the instructions step by step to remove the FDD if necessary.

WARNING

When battery low status, the speaker appear beep sounds, then on the 3 minutes plug in AC adaptor or save data and power off computer, avoid system data lose.

● Remove the Floppy Diskette Drive and CD-ROM

1. Open the PCMCIA /FDD/CD-ROM door.
2. Push the ejector handle at the front bottom of the PCMCIA/FDD/CD-ROM compartment to let it spring back about 0.4 cm..
3. Pull out the handle outwards about 3 cm and stop pulling to prevent it from being damaged.
4. Hold two sides of the FDD or CD-ROM module and slide it out smoothly.

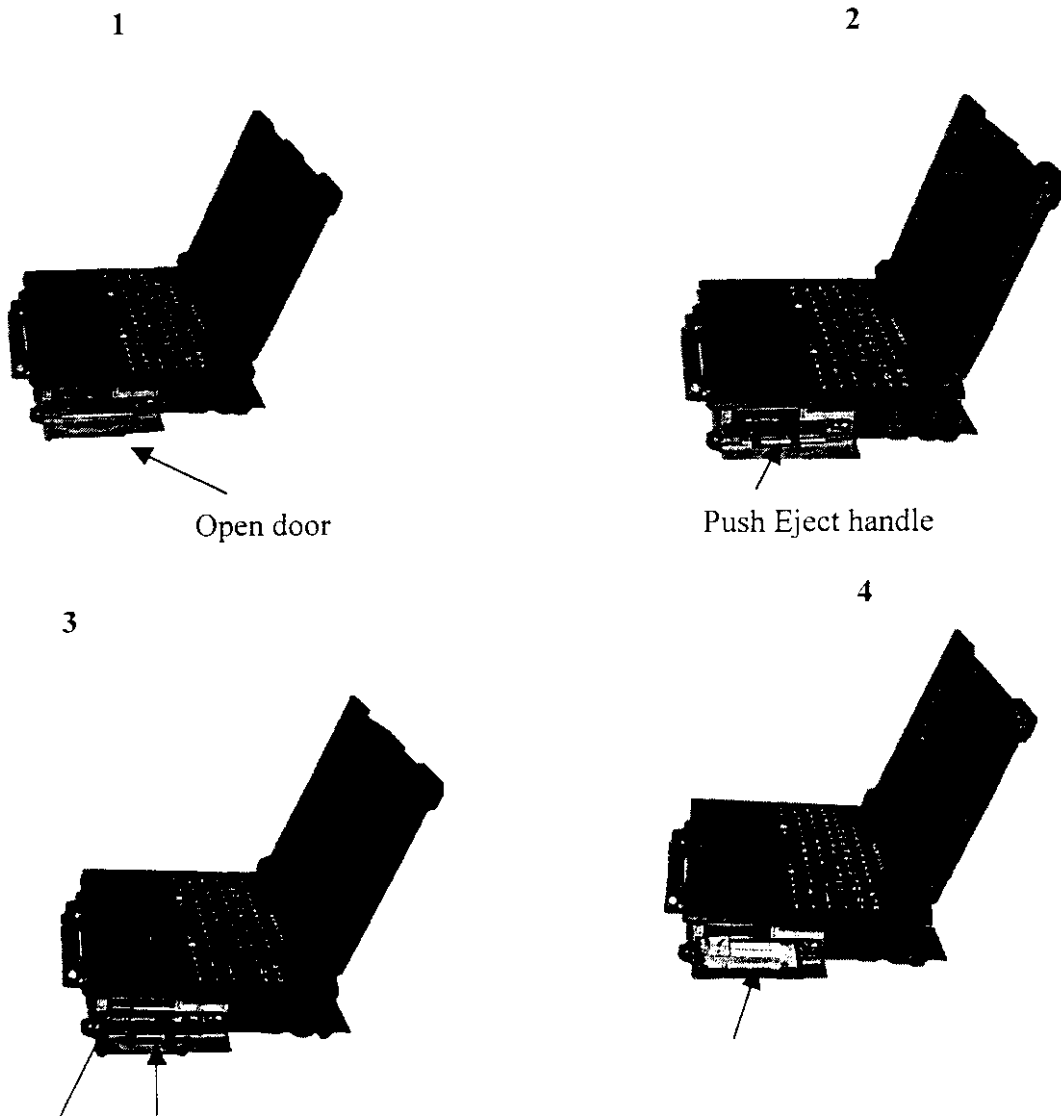

Chapter 1

System Overview

1-1 Introduction

A-Series notebook computer is a new generation notebook computer. It is a high-end rugged notebook computer which is an industrial notebook with some rugged features such as vibration, shock, drop and drip-proof. It is designed for using in vehicle or in the harsh environment.

The A-Series notebook computer implements the new technologies in the industrial market. Large display panel, high capacity hard disk drive, PCI bus and CD-ROM, etc. An Intel Pentium CPU with MMX is the heart of this notebook computer.

This chapter introduces and explains the A-Series notebook and its computer parts.

1-2 System Description

The A-Series computer is a compact fully portable notebook computer. It operates as a stand alone system for most applications.

It offers superior performance under harsh environmental and operating conditions. It is fully compatible with the IBM PC/AT standard.

1-3 System Configuration

This section presents and explains possible notebook hardware configurations. Refer to the nameplate on the notebook bottom for that system's configuration.

1-3.1 Standard Configuration

Table 1-1 lists the major common features of the standard A-Series systems.

The specifications in this table may be different from yours due to the optional items. Please refer to the detailed specifications including the standard and optional configurations on page d.

Table 1-1 Standard A-Series Notebook Computer

Feature	Description
CPU	Intel Pentium 200 MHz or more
Storage device	Removable 2.5-inch 1.4 GB hard disk drive (or more) Removable 3.5-inch 1.44 MB Floppy disk drive
Display	64K color TFT 11.3" super VGA
Power source	Rechargeable removable Ni-MH battery (or other type)
Keyboard	87key shower proof rubber keyboard, Embedded two button track pad
Expansion	Two PCMCIA sockets (type II or one type III compatible)
I/O Devices	One Parallel port, D-type 25-pin One VGA External port, D-type 15 pin Two Serial port , D-type 9 pin (COM1 & COM2) One PS/2 Keyboard and One PS/2 mouse One IrDA Port

1-3.2 Options and Accessories

● Expansion Unit

- ISA 3/4 card x 2
- ISA full size card
- CD ROM & ISA 3/4 card
- PCI 3/4 card x 2
- PCI full size card
- CD ROM & PCI 3/4 card

1-3.2.2 Carrying Bag

The carrying bag makes carrying the notebook and its peripherals easier. It has compartments for up to four diskettes, this manual, the power supply, and all notebook cables.

1-3.3 System Identification

The nameplate listing system information is at the bottom of the notebook. It contains:

- Factory configuration
- Model number
- Serial number

1-3.4 CPU Jumper Setting

The following are the selections of A-Series CPU DIP Switches (S1):

SW1, SW2: BUS CLOCK SELECTION

SW1	SW2	BUS CLOCK
OFF	OFF	66.6 MHz (Default)
ON	OFF	60 MHz
OFF	ON	50 MHz

SW3, SW4: Core/Bus Clock Rate Selection

SW3	SW4	Clock Rate and CPU Type	
		Pentium (P54C)	Pentium with MMX (P55C)
OFF	OFF	3/2, P54C 100 MHz	7/2, P55C 233 MHz
ON	OFF	2/1, P54C 133 MHz	2/1, P55C 133 MHz
OFF	ON	3/1, P54C 200 MHz	3/1, P55C 200 MHz
ON	ON	5/2 P54C 166 MHz	5/2. P55C 166 MHz

VCC3 VOLTAGE ADJUSTMENT BASE ON SW1 IN D/D BOARD

		SW1 (1,2,3,4)															
SW1		0000	0001	0010	0011	0100	0101	0110	0111	1000	1001	1010	1011	1100	1101	1110	1111
VCC3		2.1V	2.2V	2.3V	2.4V	2.5V	2.6V	2.7V	2.8V	2.9V	3.0V	3.1V	3.2V	3.3V	3.4V	3.5V	3.6V

VCC29 VOLTAGE ADJUSTMENT BASE ON SW1 IN D/D BOARD

		SW1 (5,6,7,8)															
SW1		0000	0001	0010	0011	0100	0101	0110	0111	1000	1001	1010	1011	1100	1101	1110	1111
VCC29		2.1V	2.2V	2.3V	2.4V	2.5V	2.6V	2.7V	2.8V	2.9V	3.0V	3.1V	3.2V	3.3V	3.4V	3.5V	3.6V

NOTE: "0" MEANS SWITCH OFF, "1" MEANS SWITCH ON

1-4 Unpacking

Use this checklist to make sure all items included with the notebook are present in good condition.

- Notebook computer
- Rechargeable battery pack
- AC adapter
- Power cord
- Operation Manual
- PCMCIA diskette
- TRACKPAD diskette
- VGA Driver diskette

If any items are missing or damaged, please contact the supplier.

1-5 Notebook Features

Figures from 1-1 through 1-11 identify the major notebook parts, indicators, and controls.

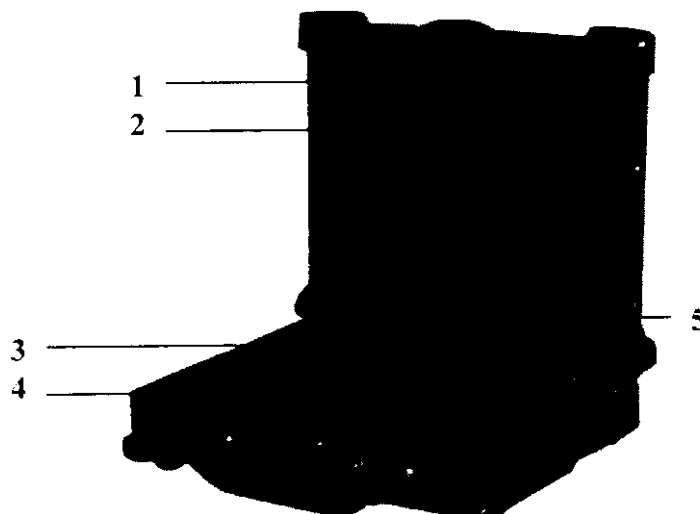

Figure 1-1 A-Series Notebook, Front View

1-5.1 Cover

The notebook cover (Item 1, Figure 1-1) houses the display unit and its control devices.

1-5.2 Display

The display have three types, one is 11.3" TFT 64K color LCD display (Item 2, Figure 1-1) is selected in A-Series notebook computer. The resolution of this LCD display is 800 X 600 pixels (SVGA standard). But the connection mechanism from LCD display to motherboard is designed flexibly for different venders of LCD displays and different types. The other is 9.4" DSTN 64 Gray scale sunlight readable monochrome LCD display, the resolution is 640 X 480 and 13.3" TFT 24 bit color LCD display , the resolution is 1024 X 768.

1-5.3 Power Switch

The power switch (Item 5, Figure 1-1) turns the notebook power on and off.

1-5.4 Keyboard

The keyboard (Item 3, Figure 1-1), is the primary tool for typing data and commands into the notebook.

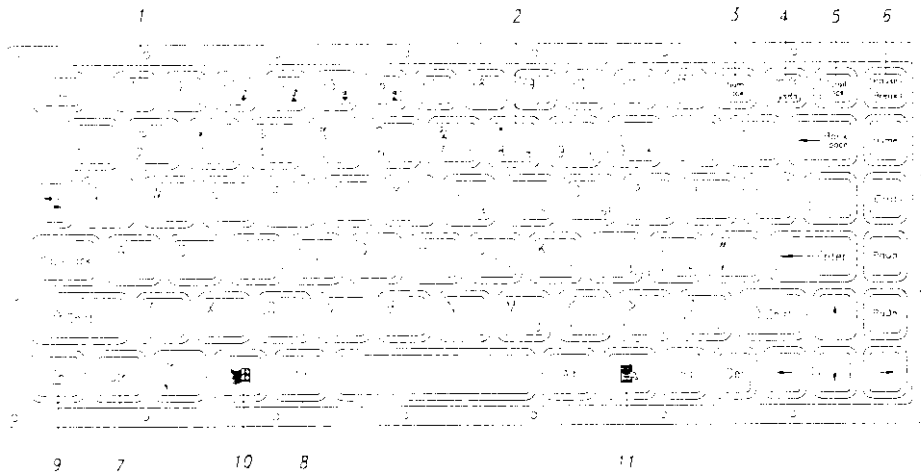

Figure 1-2 Rubber Keyboard

* About others language keyboard refer to the Appendix A.

1-5.4.1 Function Keys

The function keys give special commands defined by software. The notebook BIOS also uses function keys to set some configuration parameters.

The rubber keyboard has twelve function keys numbered from F1 through F12 (Item 1, Figure 1-2) and Fn (Item 9, Figure 1-2).

1-5.4.2 Embedded Numeric Keypad

(Item 2, Figure 1-2) These keys act like calculator keys when the NUM LOCK light is on. When the numeric keypad is active, the notebook disables the alphabet keys doubling as numeric keypad keys.

1-5.4.3 Num Lock

The Num Lock key (Item 3, Figure 1-2) activates and deactivates the embedded numeric keypad. When the numeric keypad is active, the NUM LOCK indicator comes on and the alphabetic abilities of the embedded numeric keyboard are disabled.

1-5.4.4 Prt Sc/Sys Rq

The Prt Sc/Sys Rq key (Item 4, Figure 1-2) sends a print message to an attached printer to create a hard copy of data shown on the screen or makes other system requests depending on the running software.

1-5.4.5 Scroll Lock

The scroll lock key (Item 5, Figure 1-2) works with some software to freeze the display.

1-5.4.6 Pause/Break

The Pause/Break key (Item 6, Figure 1-2) temporarily or permanently stops a program .

1-5.4.7 Ctrl and Alt Keys

(Item 7, Item 8, Figure 1-2) Some software programs use these keys in conjunction with other typewriter keys to perform special functions. See the associated software manual for details.

1-5.4.8 Cursor Control Keys

(Figure 1-3) Ten keys around the keyboard right edge work with many programs to enhance editing and cursor placement. See the software manuals for their proper operation. The cursor control keys are:

- Insert (Item 1, Figure 1-3)
- Delete (Item 2, Figure 1-3)
- Home (Item 3, Figure 1-3)
- PgUp (Item 4, Figure 1-3)
- PgDn (Item 5, Figure 1-3)
- End (Item 6, Figure 1-3)
- → (Item 7, Figure 1-3)
- ↓ (Item 8, Figure 1-3)
- ↑ (Item 9, Figure 1-3)
- ← (Item 10, Figure 1-3)

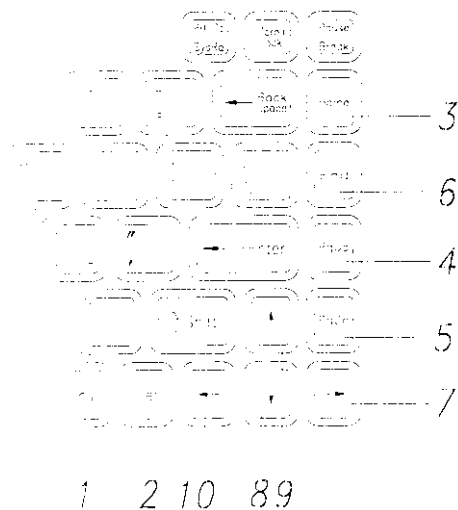



Figure 1-3 Cursor Control Keys

1-5.4.9 Windows 95 Keys

On the A-Series keyboard, you can find one Windows Logo key (, Item 10, Figure 1-2) and one Application key (Item 11, Figure 1-2). The two keys are used with other keys to perform software specific functions.

1-5.5 Pointing Device

Track pad is used as the pointing device of the A-Series notebook computer. Using finger to control the movement of cursor. The advantages of track pad are easily to clean and control the direction. The pointing device (Item 4, Figure 1-1) moves the cursor about the screen to help work with data.

The track pad consists of three major components:

- Track pad (Item 1, Figure 1-4)
- Right input button (Item 2, Figure 1-4)
- Left input button (Item 3, Figure 1-4)



Figure 1-4 Track Pad Pointing Device

1-5.6 Brightness Control

The brightness control is adjusted from the combination of function keys Fn+F5 (Dimmer) and Fn+F6 (Brighter).

1-5.7 CRT/LCD Switch

The CRT/LCD switch is changed from the combination of function keys Fn+F9.

1-5.8 Status Row

The status row (Figure 1-5) shows the current operating condition of several key notebook components. Figure 1-5 shows a close-up view.

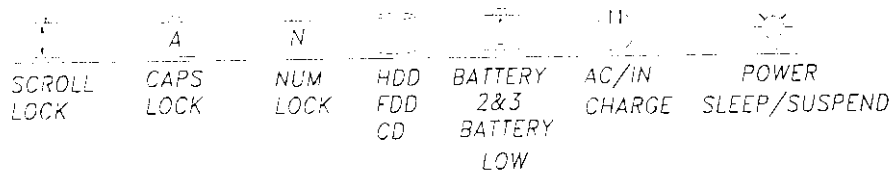

Figure 1-5 A-Series Status Row

1. A. When the power is on, then Power LED (Green) is on.
B. When the system enters Sleep or Suspend mode, then the Sleep/Suspend LED (Orange) is on.
2. A. When the AC power adaptor is connected, then the AC IN LED (Green) is on.
B. When charging is in progress, then the CHARGE LED (Orange) is on.
3. A. When any battery pack is present, then the BATTERY LED (Green) is on.
B. When any of the batteries (2nd or 3rd) enters battery low status, then the BATTERY LOW LED (Orange) is on. When if only the primary battery and battery low status then speaker will beep.

4. A. When the HDD, FDD or CD-ROM drive is active, then the HDD/FDD/CD LED (Orange) is on.
5. The "Num Lock" key activates and deactivates the embedded numeric keypad. When the numeric keypad is active, the "Num Lock" indicator come on and the alphabetic of the embedded numeric keypad are disabled.
6. Press "Caps Lock" key will Change the state of "Caps Lock" indicator between on and off, if the Caps Lock indicator goes on, represents the all English alphabet keys work in Upper Case state, otherwise the keys work in Lower Case state.
7. The "Scroll Lock" key works with some software to freeze the display. Then the cursor can move about the screen without the top bottom or any lines in between moving.

1-5.9 Battery Pack

Battery Pack is an assembly of the batteries, a battery pack connector board in an enclosed plastic case.

The battery is Ni-MH type. The capacity of each is 3800mAH or more. 1.2V, 14 cells are used in one pack. The output voltage of battery pack is 16.8VDC, so the battery pack provides 63.16 watts or more to notebook computer.

Battery pack connector board provides interface between battery cells and DC/DC board. When the inside temperature of battery pack exceeds 55°C, the DC/DC converter board detects it via thermal sensor and shut down the charging current.

1-5.10 Low Battery Indication

When all the batteries voltages are under the low battery status, the speaker will beep and the Battery LED is on (Orange).

1-5.11 Battery Charger

The A-Series battery can be charged during power on and power off. The A-Series has three types of battery packs: the first is primary 14 pcs/pack battery, the secondary is 9 pcs/pack battery and the third is 9 pcs/pack battery. The battery charge status is as follows:

1. When the 1st and 2nd(3rd) battery packs are installed simultaneously before charging, the 1st battery pack has priority over the 2nd (3rd) one in charging order.
2. If you turn off the computer while charging, the charger timer will be reset, so that the CHARGE LED will flash 3 seconds then light statically.
3. The charge time is set to six hours for power on and power off charge.
4. Battery charge time period is as follow:
 - 4.1 Primary batteries in power on, 30W consumption full charge time are about 4.5 hours. The primary batteries full charge voltages are about 21V (MIN).
 - 4.2 The primary batteries in D/D power off, the charge time period are about 2 hours.

- 4.3 The secondary batteries full charge time period in power on, 30W consumption are about 3 hours. The secondary batteries full charge voltage is about 13.4V (min).
- 4.4 The primary, secondary and third batteries charge time period are about 3 hours in power off.
- 4.5 The primary battery discharge time period is 1 hour and 36 minutes in power on 30W, but the secondary battery discharge time period is 1 hour in power on 30W consumption.

1-5.12 CHARGE LED Indicator Status

1. When you insert the battery pack into the system and the AC power adapter is already connected, the CHARGE LED (Orange) flashes three seconds or more and then stays on all the time.
2. When you connect the AC power adapter to the system, and the battery pack is already inserted, the CHARGE LED (Orange) flashes three seconds or more and then stays on all the time.
3. When you turn off the system during charging, the charge timer is reset, and the CHARGE LED (Orange) flashes three seconds or more and then stays on all the time.
4. When the battery is fully charged, the CHARGED LED (Orange) goes out.
5. When no battery pack is installed or the AC power adapter is not connected, the CHARGE LED (Orange) is off.

1-5.13 Diskette Drive and CD-ROM

(Item 2, Figure 1-6) The notebook has space for a 1.44 MB, 3.5-inch diskette drive and CD-ROM drive. The space can put removable FDD drive or CD-ROM drives.

The diskette drive allows permanent data storage in a compact, transferable media. Data stored on diskettes can be easily passed from one machine to another.

The A-Series diskette drive accepts 3.5-inch double-density (720 KB) and high density (1.44 MB) diskettes.

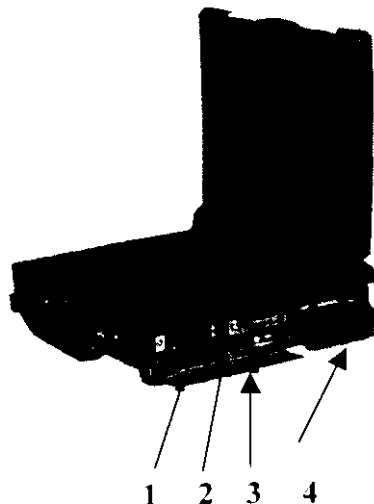

Figure 1-6 Diskette Drive and CD-ROM

1-5.14 PCMCIA Slot and Diskette Drive and CD-ROM Door

The PCMCIA slot and diskette drive and CD-ROM door (Item 3, Figure 1-6) protects the PCMCIA interfaces and diskette drive from damage in harsh environments.

1-5.15 PCMCIA Slots

The notebook has two PCMCIA slots, (Item 1, Figure 1-6). Each supports a Type-II PCMCIA card. Together, they support one Type-III PCMCIA card.

1-5.16 External Power Source Port

If the notebook will be in use for a long continuous period, connect an external power source to the notebook here (Item 8, Figure 1-7).

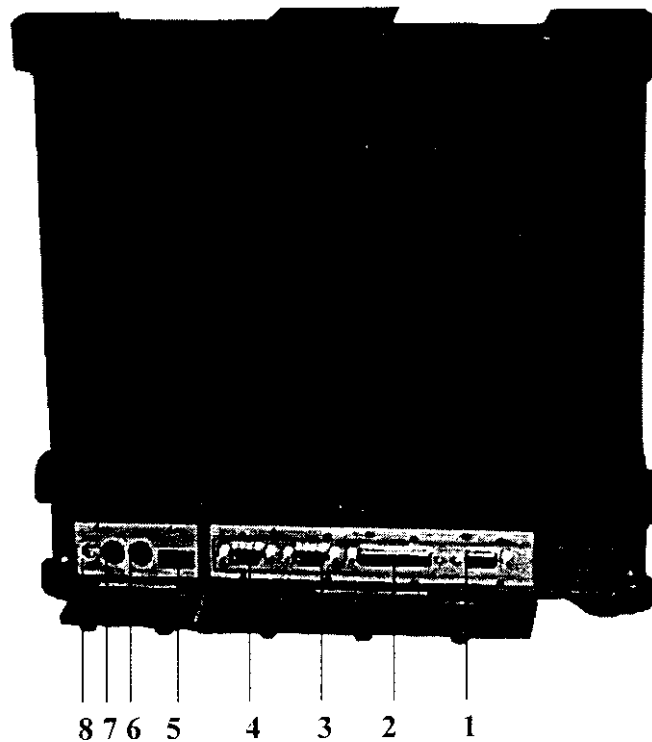

Figure 1-7 Rear Side View

1-5.17 Serial Port

Two serial ports (Item 3, Item 4, Figure 1-7) are 9-pin D-type connectors for the A-Series notebook. They are RS-232C interface set to the COM1 and COM2 addresses.

1-5.18 Printer Port

The printer port (Item 2, Figure 1-7) is a 25-pin D-type interface. Usually this interface supports a parallel printing device.

1-5.19 VGA Port

This 15-pin (Item 1, Figure 1-7) analog port is for connecting in external monitor.

1-5.20 IrDA Port

This infrared port (Item 5, Figure 1-7) complies IrDA, and ASK Standards, which allow you to connect your notebook to an IR device wirelessly.

1-5.21 Keyboard port

The Keyboard port (Item 6, Figure 1-7) for IBM PS/2 keyboard.

1-5.22 Mouse Port

The mouse port (Item 7, Figure 1-7) for IBM PS/2 mouse.

1-5.23 Hard Disk

The hard disk (Item 4 Figure 1-6) is the primary storage device for the notebook. It stores major programs, old and new data files for later use.

1-5.24 External Power Adapter

The A-Series external power adapter converts 100-240V, 50-60 Hz to 22.5VDC, 2.4A, 54 watts for the notebook & expansion unit.

Chapter 2

Operation

2-1 Introduction

This chapter tells how to use the notebook.

2-2 Opening and Closing the Notebook

This section tells how to open the notebook cover and access doors. See Figure 2-1.

2-2.1 Opening the Cover

To open the notebook, press hook outward and tilt the cover up to a comfortable viewing angle. (Usually about 110°) See Figure 2-1.

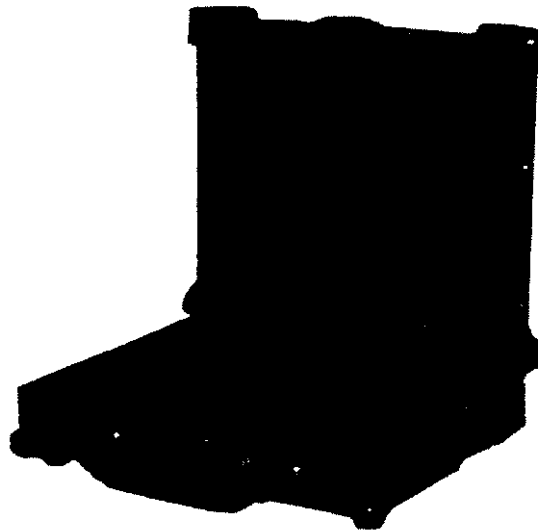

Figure 2-1 Opening the Notebook

2-2.2 Closing the Cover

To close the notebook, tilt the cover down until it clicks shut. The computer stays on if you close the cover while system power is applied.

2-2.3 Opening the PCMCIA/FDD/CD ROM Door

Open doors only when it is required to access components behind them.

To open a door:

1. Insert a small flat edged object (coin edge or screw-driver) in a door or cover securing captive screw.

2. Turn the screw counterclockwise until it comes loose from its socket.
3. Repeat steps 1 and 2 for each securing screw.
4. Grab a securing screw and open a door.

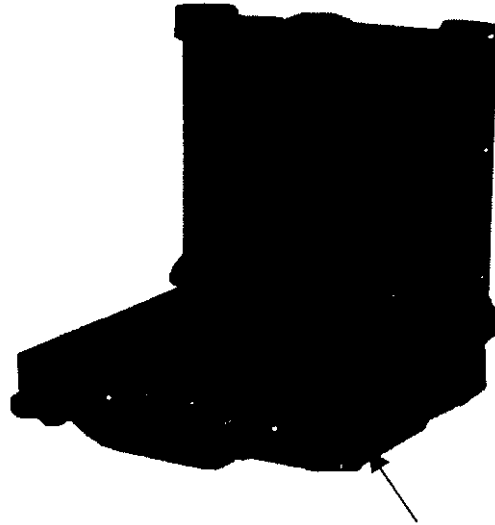

Figure 2-2 Opening a Door

2-2.4 Shutting the PCMCIA/FDD/CD-ROM Door

1. Shut the door or put the PCMCIA/FDD/CD-ROM back in place.
2. Align the door or cover securing screws with their sockets.
3. Use a flat edged tool (coin or screw driver) to turn the screws clockwise until tight.

NOTE

Keep all access doors and covers tightly shut when not in use.

2-3 Connecting and Installing Devices

This section gives instructions for installing, removing, changing, or connecting devices via the notebook external ports or sockets.

2-3.1 Serial and Parallel Port

Item 2, Item 1, Figure 2-3 shows how to connect serial and parallel cables. Make sure the mating connector is tightly secured by pushing it to the end and lock the screws.

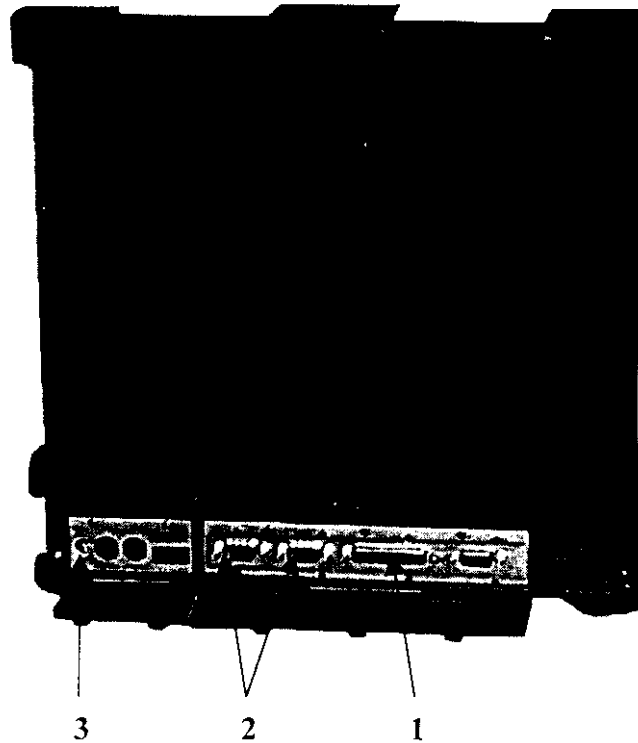

Figure 2-3 Connecting the External Power, Serial, and Parallel ports

2-3.2 External Power Adapter

Item 3, Figure 2-3 shows how to connect the power adapter. Make sure the mating connector is tightly secured by pushing it to the end.

NOTE

The notebook can be on or off when connecting or disconnecting the adapter.

2-3.3 Diskettes

To install a diskette,

1. Open the PCMCIA slot/ diskette drive access door.
2. Slide the diskette into the drive with the printed label facing up until it clicks in place.

To remove the diskette, press the ejector button on the right side of the drive. See Figure 2-4.

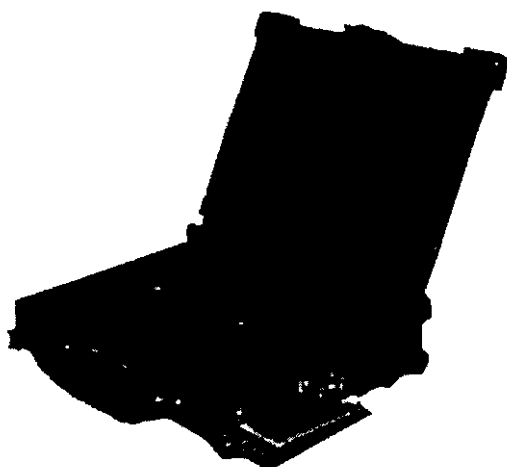

Figure 2-4 Removing a Diskette

2-3.4 Remove the Floppy Diskette Drive / CD-ROM / 2nd Battery

1. Open the PCMCIA /FDD/CD-ROM door.
2. Push the ejector handle at the front bottom of the FDD/CD-ROM/2nd battery compartment to let it spring back about 0.4 cm..
3. Pull out the handle outwards about 3 cm and stop pulling to prevent it from being damaged.
4. Hold two sides of the FDD / CD-ROM/2nd battery module and slide it out smoothly.

1

2

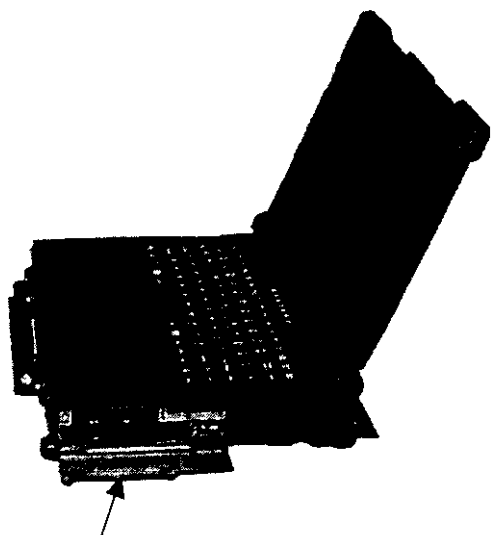

Open Door

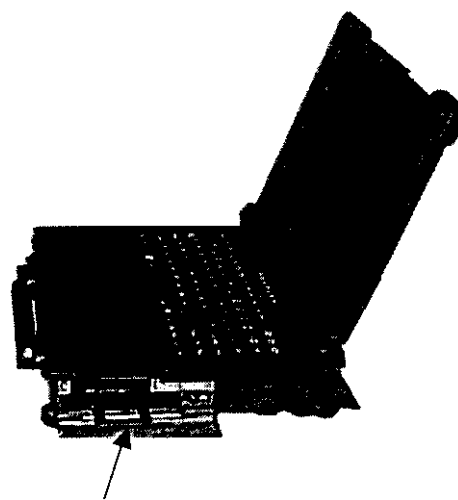

Push Eject Handle

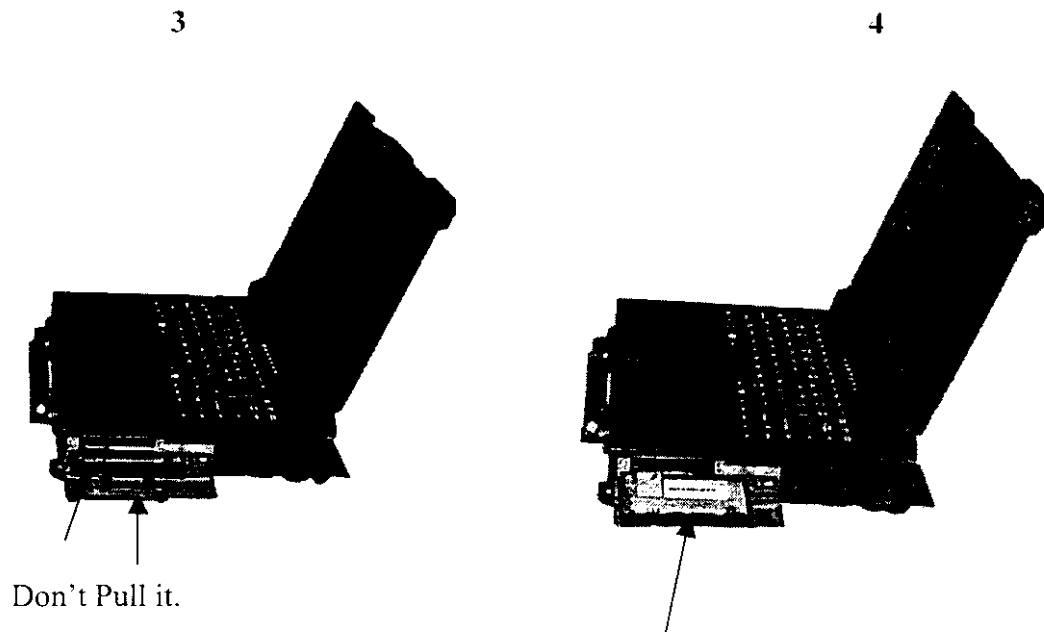

Figure 2-5 Removing a FDD/CD-ROM

2-3.5 PCMCIA Cards

The PCMCIA ports support up to two type-II PCMCIA cards or one type-III PCMCIA card. A type-III PCMCIA card occupies both slots.

1. Open the PCMCIA slot/diskette drive door.
2. Slide the card into the slot with the insert marking facing up until it seats.

To remove the upper card, press the eject button on the left. To remove the lower card, press the button on the right. (See Figure 2-6).

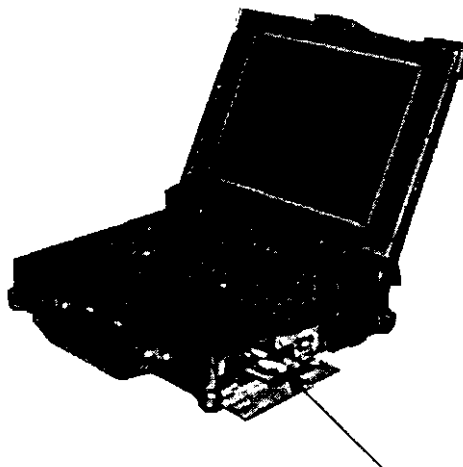

Figure 2-6 Removing a PCMCIA Cards

2-3.6 Hard Disk

CAUTION!

Installing or removing a hard disk when the computer is on can destroy the system board and hard disk.

To remove and change the hard disk:

1. Turn the computer off.
2. Loosen the screws from up, down of the Hdd disk.
3. Grab the handle of the hard disk module and pull it out. (See Figure 2-7).
4. Insert the new hard disk module in the slot until it seats firmly.
5. If necessary, run the system configuration program when the system boots next time. See chapter 3 for details.

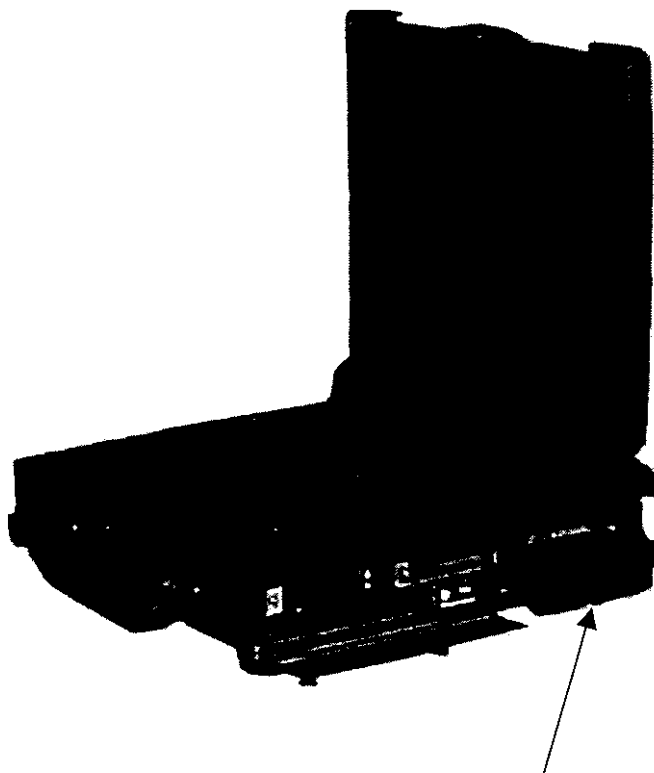

Figure 2-7 Removing a Hard Disk

2-4 First Time Use

This section describes activities to complete prior to using the notebook the first time.

1. Put the rechargeable battery pack into the battery compartment.
2. Connect the power adapter to the power port.
3. Connect the power adapter into a properly rated power source.
4. Turn on the computer.

2-4.1 Configuring the System

The notebook is configured in the factory. Run the SETUP program when the computer boots for the first time to record the system settings. For more details about configuring the system and when to do it, see Chapter 3.

2-4.2 Installing Software Driver

Before you install your new software, make a backup copy of the original program disk using the DOS Diskcopy command or the Windows disk copy utility in file manager.

2-4.2.1.1 Installation Cardworks in Windows 95

1. With Windows running, insert Cardworks Software disk into drive A.
2. In the Windows program manager, select Run.... from the File menu and type A:\Setup.exe. Press ENTER, or choose OK.

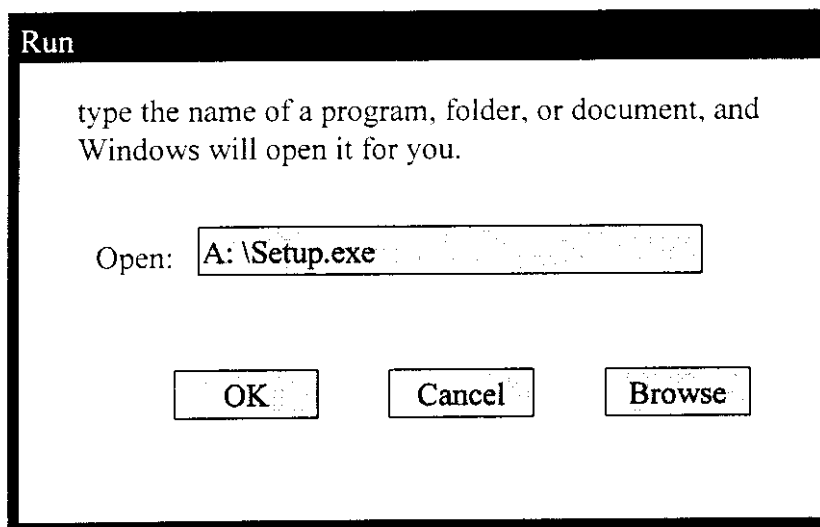

3. Click "OK" button then next screen will be displayed.

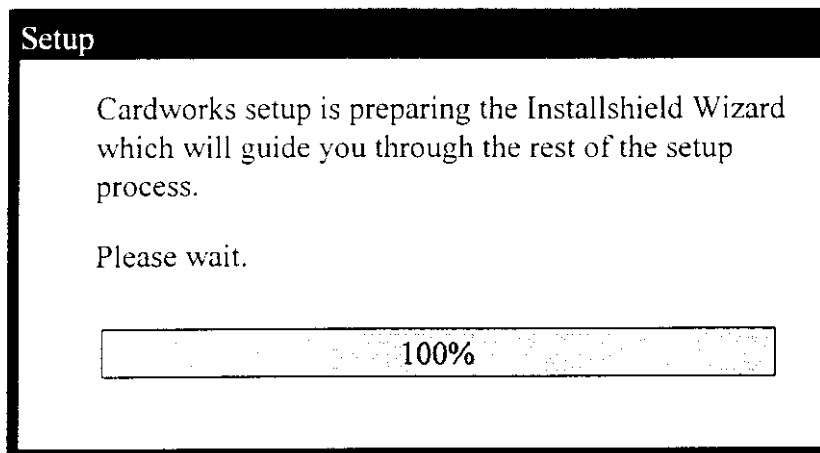

4. The installation program starts and quickly displays the initial setup indicating that Setup is preparing for the installation and that you will be guided through the installation process.

After a brief period the **CardWorks Setup** screen will appear.

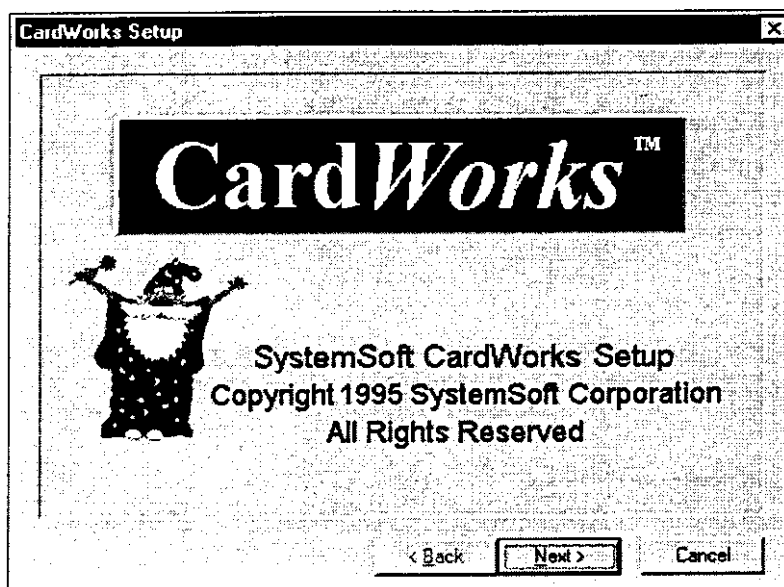

5. Selecting the **Next** button displays the *CardWorks Welcome* screen. Follow the recommendations to exit all Windows programs before continuing with the installation.



6. Selecting the **Next** button displays the following **Choose Destination Directory** screen. Select **Next** to install software in the default destination directory, C:\CARDWORK. If you want to install the software into another directory, select **Browse** and then select the desired directory.

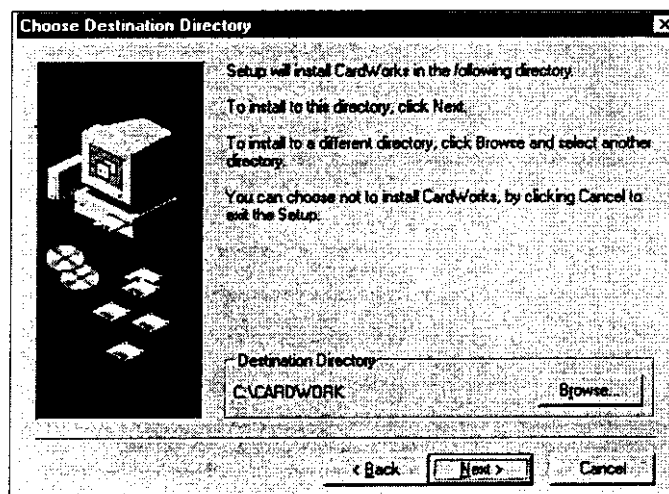

7. Once you have selected the destination directory, select **Next** to view the **Setup Type** screen.

Select from Typical, Compact, and Custom (see descriptions on screen) installations to define your Setup type.

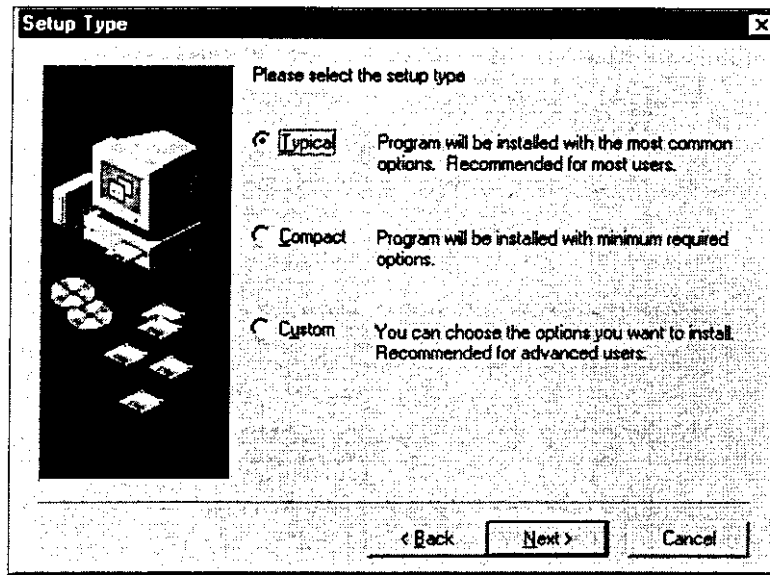

8. Select the number of PC Card slots present on your machine: 1 to 4.

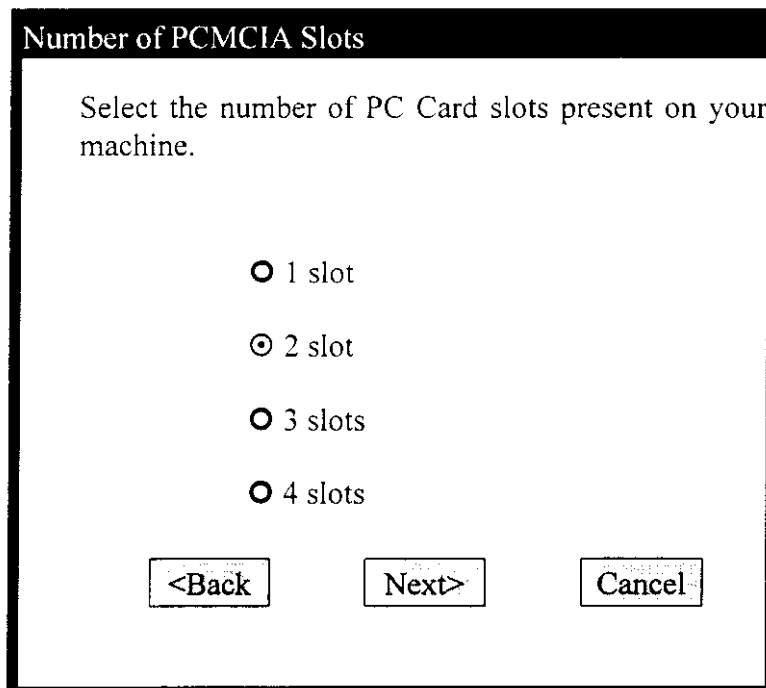

9. Your system will then begin to decompress and copy files.

The three information gauges (upper section of graphic) provide the user with important feedback during installation:

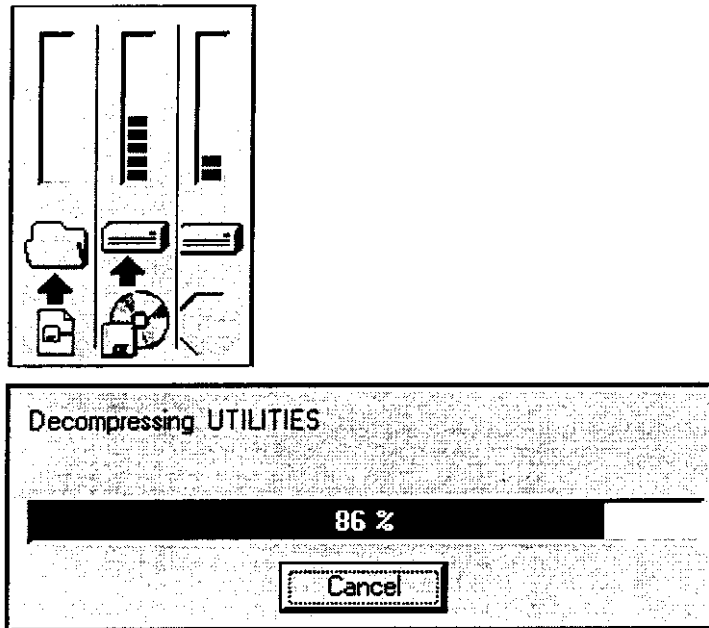

Location	Description
Left	The left gauge shows what percent of each individual file the installer has copied from the diskette to the hard disk.
Center	The center gauge shows how much of the diskette has been transferred to the hard disk.
Right	The right gauge shows how much space is available on your hard disk. The low sign lights when your hard disk has only 5% or less space available.

The lower section of the graphic is a progress indicator of how much of the currently compressed file has been decompressed and copied to the hard disk.

10. Once all files have been transferred, you will be asked if you want to read the README file now.

Select either **Yes** or **No** as desired.

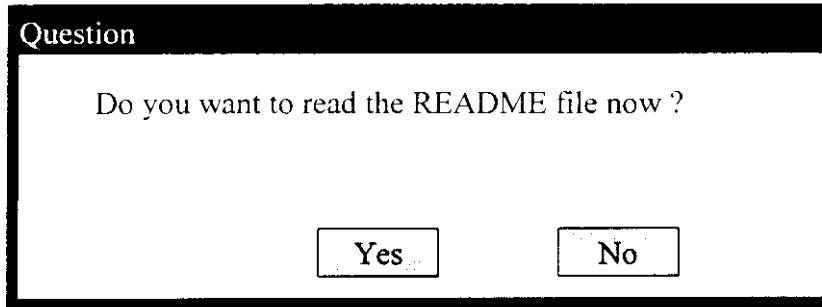

11. Before the application can be run, the computer must be rebooted.

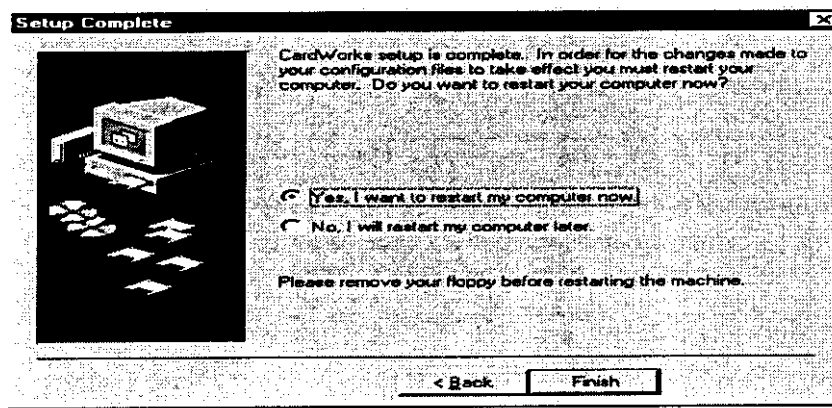

12. Select whether to reboot now or later.

Once the installation has been completed the *CardWorks* group will be created (unless you had previously opted to have *CardWorks* start from the Windows Startup Group).

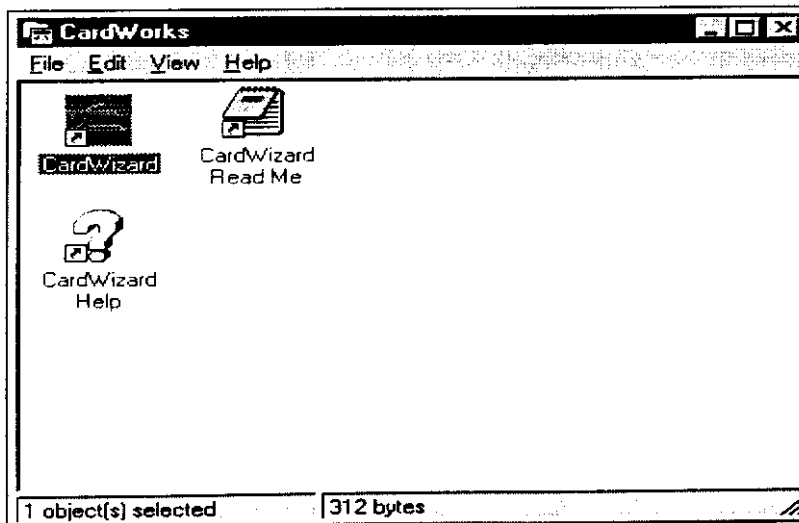

13. If your device is SCSI hard disk, so that system will find “Adaptec AHA-150X/1510/152X/AIC-6X60 SCSI Host Adaptec” after install Cardworks completed.

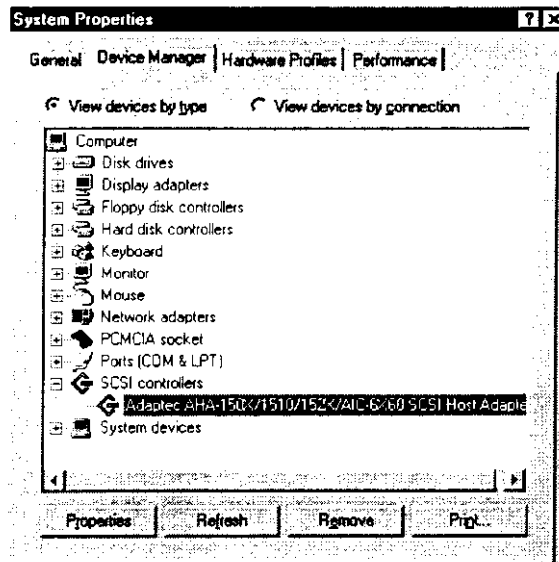

14. Select “Resources” then enter “ Adaptec AHA-150X/1510/152X/AIC-6X60 SCSI Host...” screen will be displayed.

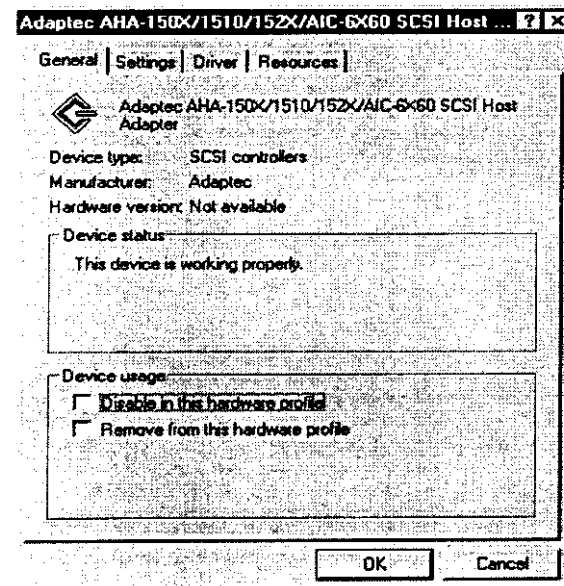

2-4.2.12 Installation Cardwizard Driver in Windows NT4.0

1. Run

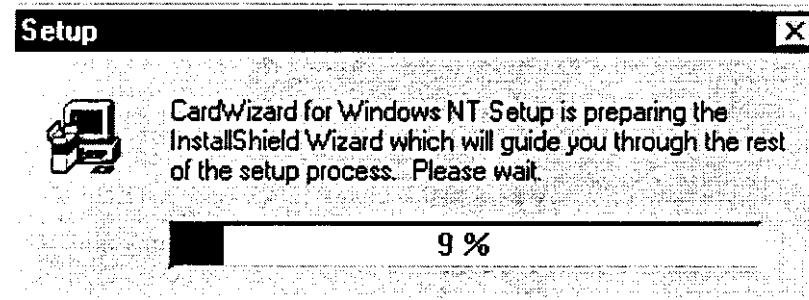

2. Select "Next" button then double click.



3. Select "Next" button then double click.

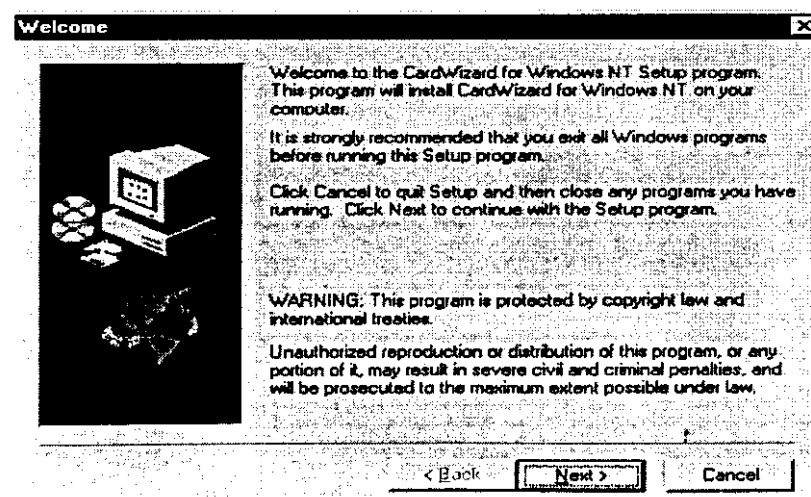

4. Select "Next" button then double click.

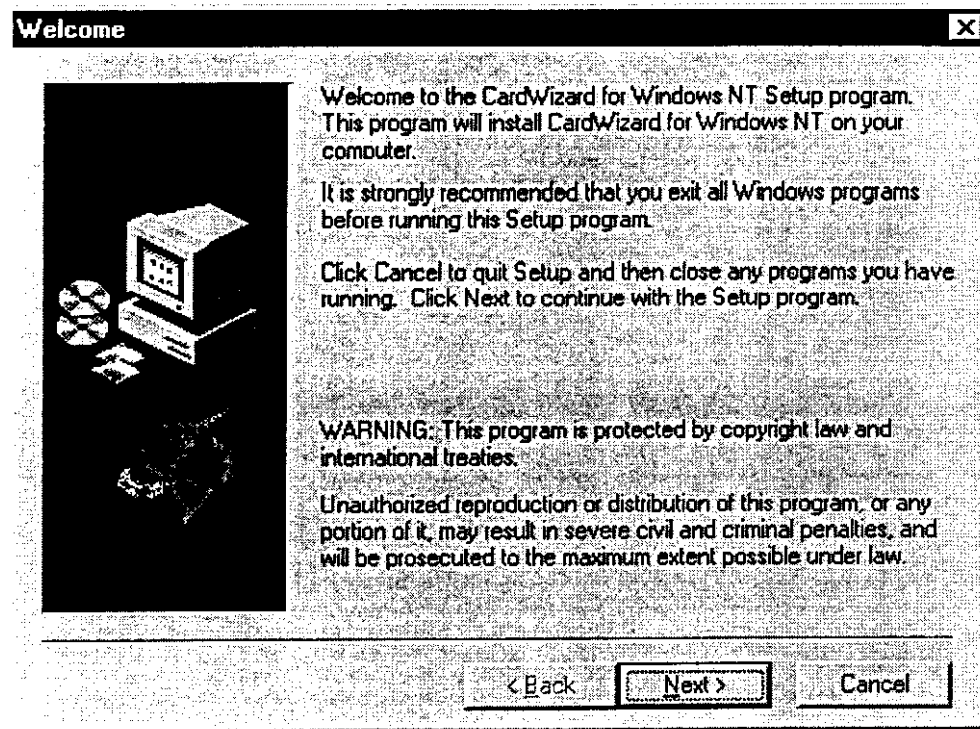

5. Select "Yes" button then double click.

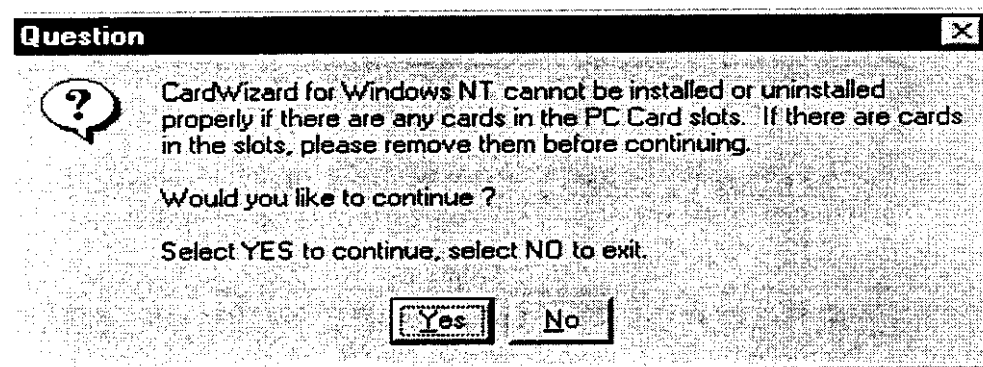

6. You can follow the default directory to install program then double click "Next" button or you can create new directory to install.

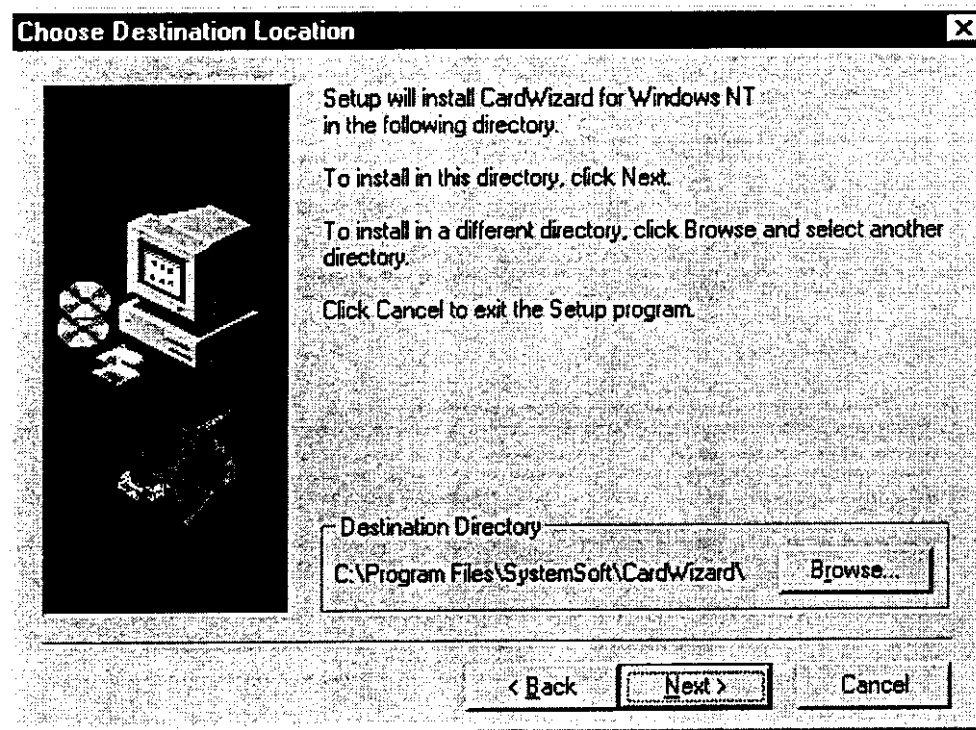

7

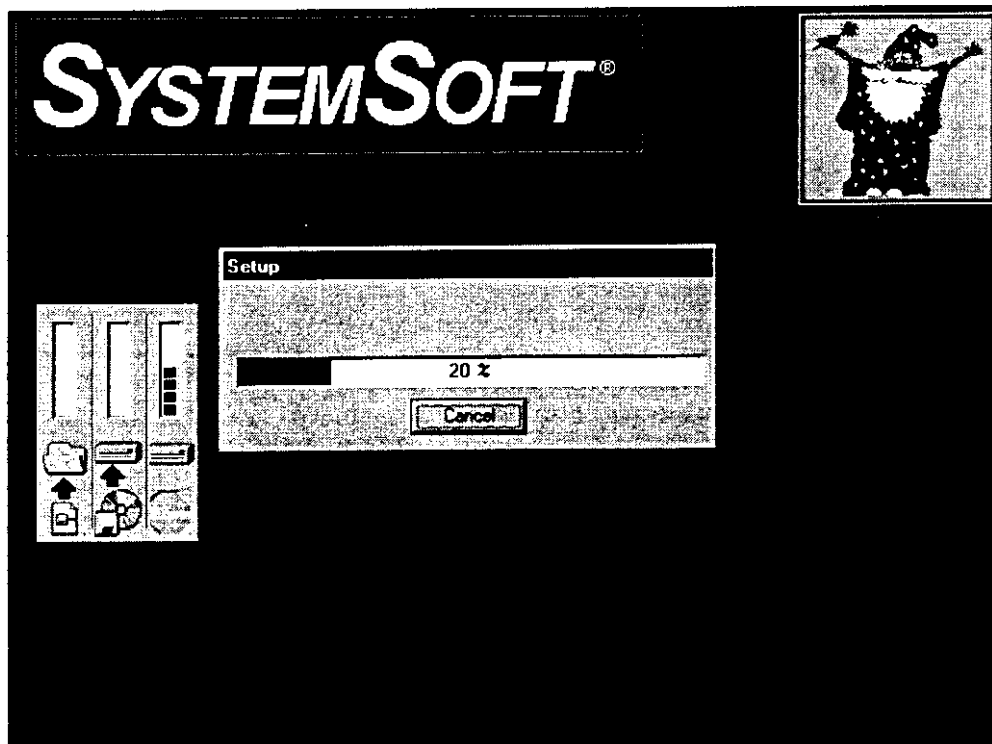

8. Select "Yes, I want to restart my computer now" then double click "Finish" button.

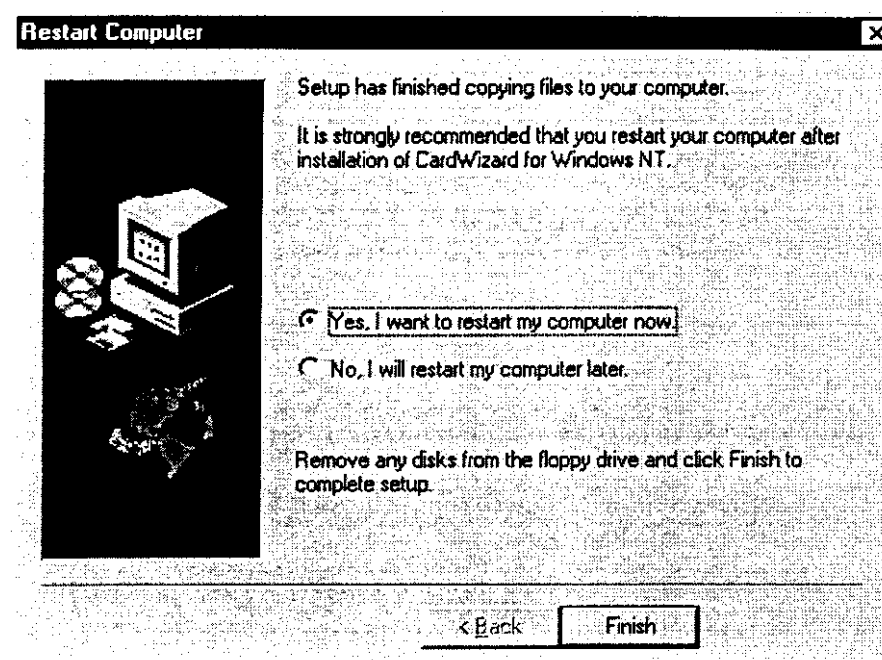

2-5 Daily Operation

This section discusses expected daily notebook activity.

2-5.1 Starting the Computer

To start the computer :

1. Make sure all peripherals are properly connected.
2. If using the AC adapter or external power, make sure it is connected.
3. Open the cover.
4. Press the Power button. The power on indicator lights up. The computer performs a Power On Self Test (POST) and checks configuration settings. Depending on the configuration, items tested include :
 - system board
 - system DRAM
 - video controller
 - keyboard controller
 - I/O controllers
 - hard disk
 - diskette drive
5. If the POST finds an inconsistency between expected and actual system configuration it will display an error message.

6. If the cause is known and will not cause other difficulties, press F1. To correct the discrepancy, press F2 and change configuration settings accordingly. See chapter 3 for details about SETUP.
7. After the POST, the system checks for a system password. If one is present, the computer prompts for its entry before continuing. Carefully type it in.

NOTE

The password characters do not appear on the screen.

8. After password confirmation, the system tries to boot from drive A first and then drive C.
9. Adjust brightness, and viewing angle for best appearance and comfort.

2-5.2 Turning Off The Notebook

To turn off the notebook

1. Save all data and close all open programs.
2. Press the Power button to turn off power.
3. Swing the cover closed until it clicks shut.
4. Turn off and disconnect all peripheral devices.
5. Close and tighten all access doors and covers.

2-5.3 Using the Notebook in the Car

When you using the notebook in the car, you must carefully follow as:

1. Start engine wait five to ten minutes and then plug car power cable into car cigarette. (See Figure 2-8).
2. Before have notebook connected with car power cable be sure the notebook is off.
3. Once you have the notebook connected car power cable.
4. Turn on of the notebook.

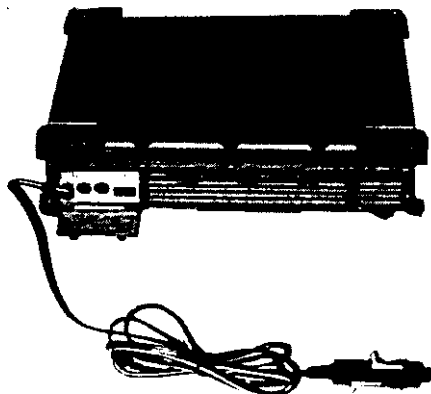

Plug in car cigarette lighter

Figure 2-8 Plug Car Power Cable in Notebook
2-18

2.6 Using External Power Sources

CAUTION

The external power adapter is rated for input sources within the following constraints:

A-Series:

AC: 100-240 V, 50-60 Hz

DC: 10-20VDC direct input without charging function (option)

20-32 VDC external car adapter/charger (option)

Connecting to sources outside this range may damage the external power adapter

To save battery power, use power adapter with an external power source whenever possible.

Tips for using the external power adapter.

1. Connect the external adapter to the computer as the main power source no matter when the computer is in use or not.
2. If the external adapter is not connected while the computer is in operation and the power indicator is blinking, which shows the batteries are running out of energy, please connect the adapter to the computer and plug in the power cord to the outlet immediately.

2-6.1 Using AC External Adapter

A-Series provides an AC external adapter for standard configuration. Use the nearby AC power source.

2-6.2 Charging the Batteries

Make sure the external adapter is connected to the computer. It has two charging rates depending on notebook operating or power off.

Section 2-4.1 gives detailed instructions on connecting an external power source and charging the batteries.

2-7 Running On Battery Power

The notebook has several power management features to prolong continuous operation on battery power.

This section describes the power saving modes and tells how to take best advantage of them. It includes default settings for each mode. For instructions about changing them, see chapter 3.

Chapter 3

The SETUP Program

3-1 Introduction

The SETUP program allows you to enter the system configuration information. This information is needed by the notebook to identify the type of devices installed and to initiate special features. Typical configuration information includes the date and time, the types of disk drives, and the amount of memory. Special features include Power Management and Security. The configuration information is stored in a special kind of memory called CMOS (Complementary Metal Oxide Semiconductor) RAM. CMOS RAM data is powered by a RTC backup battery.

You may need to run SETUP when:

- You see an error message on the screen requesting you to run SETUP.
- You change factory default settings for some special features.
- You want to modify the configuration information.

3-2 Running SETUP and Moving Around

NOTE

1. All the SETUP screens shown in this chapter are examples. Your actual settings may vary from those shown here.
2. The SETUP program may have been updated after this manual was published.

The SETUP program is built into the system board. To run SETUP, press <F2> during POST only.

The SETUP screens include five groups of many different functions:

- Main – Contains the system General SETUP parameter.
- Advanced – Contains Integrated peripherals and PCI Device setup parameter.
- Security – Contains the system security functions setup parameter.
- Power – Contains the system power management setup parameter.
- Exit – Contains various ways to exit the SETUP program.

Use the right & left Arrow keys to change display for each group.

PhoenixBIOS Setup-Copyright 1985-95 Phoenix Technologies Ltd.

Main		Advanced	Security	Power	Exit	Item Specific Help	
System Time:	[11:09:49]					<Tab>, <Shift-Tab>, or <Enter> selects field.	
System Date:	[10/17/1997]						
Diskette A:	[1.44MB, 3 1/2"]						
Diskette B:	[None]						
▶ IDE Adaptor 0 Master	(C: 1216 Mb)						
▶ IDE Adaptor 0 Slave	(None)						
Video System:	[EGA/VGA]						
▶ Memory Cache							
▶ Memory Shadow							
▶ Boot Sequence:	[A: then C:]						
System Memory:	640 KB						
Extended Memory:	7168 KB						
F1 Help	↑↓ Select Item	-/+ Change Values	F9 Setup Defaults				
ESC Exit	←→ Select Menu	Enter Select	▶ Sub-Menu	F10 Previous Values			

3-2.1 Main

This section describes the main items of the SETUP program.

3-2.1.1 System Time/System Date

The time and date might be incorrect when you start up your notebook for the first time. Press <Enter> key to select the field, and type the new value through Numeric keys to change the time or date.

3-2.1.2 FDD Type

This item sets the type of floppy disk drive.

The available options are: 360KB 5 1/4", 1.2MB 5 1/4", 720KB 3 1/2", 1.44MB 3 1/2", and Not installed. Press the spacebar to select the corresponding type. In A-Series system the 1.44MB 3 1/2" should be always selected, if floppy disk drive installed.

3-2.1.3 IDE Adaptor 0 Master

Move the cursor to "IDE Adapter 0 Master", then press <Enter>, the system will enter to "IDE Adapter 0 Master" setup screen, follow the help on the right side of the screen to setup HDD parameter properly.

This item sets the HDD type which installed in you system and connected to the PCI IDE controller channel 0. It can be down through the manual setting or BIOS automatic setting.

PhoenixBIOS Setup-Copyright 1985-95 Phoenix Technologies Ltd.

Main

IDE Adaptor 0 Master	Item Specific Help
<pre>Autotype Fixed Disk: [Press Enter] Type: [Auto]1443 MB Cylinders: 1179 Heads: 15 Sectors/Track: 60 Write Precomp: None Multi-Sector Transfers: 16 Sectors LBA Mode Control: Enabled 32 Bit I/O: [Enabled] Transfer Mode: Fast PIO 4</pre>	<p>Attempts to automatically detect the drive type for drives that comply with ANSI specifications.</p>
<pre>F1 Help ↑↓ Select Item -/+ Change Values F9 Setup Defaults ESC Exit ←→ Select Menu Enter select ▶ Sub-Menu F10 Previous Values</pre>	

3-2.1.3.1 Autotype Fixed Disk

The system BIOS will automatically detect the drive type for drives that comply with ANSI specifications during POST.

3-2.1.3.2 Type

Select the drive type corresponding to the fixed disk installed in your system. If User is selected, Cylinders, Heads, Sectors/Track, and Write Precomp can be edited directly. A write precomp. of None can be specified by pressing N.

3-2.1.3.3 Multi-Sector Transfers

Determines the number of sectors per block for multiple sector transfers. Refers to the size the disk returns for the Max value when queried.

3-2.1.3.4 LBA Mode Control

Enabling LBA causes Logical Block Addressing to be used in place of Cylinders, Heads and Sectors.

3-2.1.3.5 32 Bit I/O

Enables 32 Bit data transfers to get a faster speed of HDD access.

3-2.1.3.6 Transfer Mode

Selects the method for moving data to/from the drive. In Autotype, the drive selects the optimum transfer mode.

3-2.1.4 IDE Adaptor 0 Slave

The section is the same as 3-2.1.3.

3-2.1.5 Video System

"Video System" selects the type of video display card in your system.

The three options are:

EGA/VGA

CGA 80x25

Monochrome

Please select EGA/VGA mode, because the SUPER VGA chip has already been built into the system.

3-2.1.6 Memory Cache

Press <Enter> key when cursor is in Memory Cache field, the memory cache setup screen will be displayed, press the spacebar to select Enabled or Disabled.

3-2.1.7 Memory Shadow

Press <Enter> key when the cursor is in Memory Shadow field, the memory shadow setup screen will be displayed, use the cursor keys and space bar to setup the shadow parameter properly.

PhoenixBIOS Setup-Copyright 1985-95 Phoenix Technologies Ltd.

Main

Memory Shadow		Item Specific Help
System Shadow	Enabled	Shadow Video BIOS ROMS
Video Shadow	[Enabled]	
Shadow Memory Regions		
CC00 - CFFF	[Disabled]	
D000 - DFFF	[Disabled]	
F1 Help	↑↓ Select Item	-/+ Change Values
ESC Exit	←→ Select Menu	Enter Select Sub-Menu
		F9 Setup Defaults
		F10 Previous Values

3-2.1.7.1 Video Shadow

The default setting for Video Shadow is "Enabled", which copies the video BIOS ROM into system DRAM to improve performance.

Press the spacebar when the cursor is in Video Shadow to select "Enabled" or "Disabled".

3-2.1.7.2 Shadow Memory Regions

Press the spacebar when the cursor is in Shadow Memory Regions to select "Enabled" or "Disabled". The "Shadow Memory Regions" provides two Regions for the user

add-on card from the Docking system. One is CC00-CFFF(16KB), and the other is D000-DFFF (64KB).

3-2.1.8 Boot Sequence

Press the spacebar when the cursor is in Boot Sequence to select "A: thenC:", "C: then A:" or "C: only".

PhoenixBIOS Setup-Copyright 1985-95 Phoenix Technologies Ltd.

Main

Boot options		Item Specific Help
Boot sequence:	[A: then C:]	Order system searches drives for a boot disk.
Setup prompt :	[Enabled]	
POST Errors :	[Enabled]	
Floppy check :	[Enabled]	
Summary screen:	[Enabled]	
F1 Help ↑↓ Select Item -/+ Change Values F9 Setup Defaults ESC Exit ←→ Select Menu Enter Select Sub-Menu F10 Previous Values		

3-2.1.8.1 SETUP prompt

Press the spacebar when the cursor is in Setup Prompt to select "Enabled" or "Disabled".

3-2.1.8.2 POST Errors

Press the spacebar when the cursor is in POST Errors to select "Enabled" or "Disabled".

3-2.1.8.3 Floppy check

Press the spacebar when the cursor is in Floppy check to select "Enabled" or "Disabled".

3-2.1.8.4 Summary screen

Press the spacebar when the cursor is in Summary screen to select "Enabled" or "Disabled".

3-2.2 Advanced

The section describes the Integrated Peripherals, PCI devices, Plug & Play O/S and Large Disk Access Mode of the SETUP.

Advanced

Warning!		Item Specific Help	
Setting items on this menu to incorrect values may cause your system to malfunction.			
▶ Integrated Peripherals ▶ PCI devices Plug & Play O/s [NO] Operating System [Standard] Display Boot Device [LCD or SM] Large Disk Access Mode: [DOS]			
F1	Help ↑↓	Select Item -/+	Change Values
ESC	Exit ←→	Select Menu Enter	Select Sub-Menu
			F9 Setup Defaults
			F10 Previous Values

3-2.2.1 Integrated Peripherals

Press <Enter> key when cursor is in “Integrated Peripherals”, the “Integrated Peripherals” setup screen will be display, press the space bar to select parameters properly.

Advanced

Integrated Peripherals		Item Specific Help	
COM Port: [3F8, IRQ4] COM Port: [2F8, IRQ3] LPT Port: [378, IRQ7] LPT Port: [Output Only] DISKETTE controller: [Enabled] UART 2 MODE: [Standard]		Set COM port address.	
F1	Help ↑↓	Select Item -/+	Change Values
ESC	Exit ←→	Select Menu Enter	Select Sub-Menu
			F9 Setup Defaults
			F10 Previous Values

3-2.2.1.1. COM port

Press the spacebar to set the COM port address. (The default value is 3F8, IRQ 4)

3-2.2.1.2 COM port

Press the spacebar to set the COM port address. (The default value is 2F8, IRQ 3)

3-2.2.1.3 LPT port

Press the spacebar to set the LPT port address. (The default value is 378, IRQ 7)

3-2.2.1.4 LPT Mode

Press the spacebar to select “Output Only”, “Bi-Directional”, “EPP” and “ECP” LPT mode.

3-2.2.1.5 Diskette Controller

Press the spacebar to select “Enabled” or “Disabled”.

3-2.2.1.6 UART 2 MODE

Press the spacebar to select "Standard", " Legacy-SIR", " IrDA-MIR" and " IrDA-FIR" for the interface.

3-2.2.2 PCI device

Press <Enter> key when the cursor is in PCI devices to enter next picture to set the parameters.

PhoenixBIOS Setup-Copyright 1985-95 Phoenix Technologies Ltd.

Advanced

PCI devices	Item Specific Help
PCI Device, Slot #1 Enable Master: [Enabled] Default Latency Timer: [Yes] Latency Timer: [0040]	Enable selected device as a PCI bus master.
PCI Device, Slot #2 Enable Master: [Enabled] Default Latency Timer: [Yes] Latency Timer: [0040]	
PCI Device, Slot #4 Enable Master: [Enabled] Default Latency Timer: [Yes] Latency Timer: [0040]	
F1 Help ↑↓ Select Item -/+ Change Values F9 Setup Defaults ESC Exit ←→ Select Menu Enter Select Sub-Menu F10 Previous Values	

3-2.2.2.1 Enable Master

"Enabled" selects the device as a PCI bus master.

3-2.2.2.2 Default latency Timer

Use minimum latency required by the device. If enabled, do not set the latency timer.

3-2.2.2.3 Latency Timer

Use minimum latency required by the device. If enabled do not set latency timer. Default value is 40h, and adjusted by 08h.

Advanced

Warning	Item Specific Help
<p>Setting items on this menu to incorrect values May cause your system to malfunction.</p> <ul style="list-style-type: none"> ▶ Integrated Peripherals ▶ PCI Devices <ul style="list-style-type: none"> Plug & Play O/S [NO] Operating System [Standard] Display Boot Device [LCD or SM] Large Disk Access Mode: [DOS] 	<p>Enable selected device as a PCI bus master.</p>
<p>F1 Help ↑↓ Select Item -/+ Change Values F9 Setup Defaults ESC Exit ←→ Select Menu Enter Select Sub-Menu F10 Previous Values</p>	

3-2.2.3 Plug & Play O/S

Select "Yes", if you are using a Plug & Play capable operating system.

3-2.2.4 Operating System Mode

Select the "Standard" mode in general, for Windows 95, Windows NT, OS/2 or DOS. If you get into trouble with the "Standard" mode, please select the "Compatible" mode.

3-2.2.5 Display Boot Device

There are two modes for the user to choose. One is "LCD SM" and the other is "CRT only". Press the space bard to select display mode.

3-2.2.6 Large Disk Access Mode

If you have DOS, select "DOS". If you have UNIX, Novell Netware, or other operating systems, select "Other". If you are installing new software and the drive fails, change this selection and try again. Different operating systems require different representations of drive geometries.

3-2.3 Security

The section describes the "Set Supervisor Password", "Password on boot", "Diskette access", "Fixed disk boot sector", "System backup reminder" and "Virus check reminder" of the SETUP.

Security

		Item Specific Help
Supervisor Password is	Disabled	
User Password is	Disabled	
Set Supervisor Password	[Press Enter]	
Set User Password	Press Enter	
Password on boot:	[Disabled]	
Diskette access:	[User]	
Fixed disk boot sector:	[Normal]	
System backup reminder:	[Disabled]	
Virus check reminder:	[Disabled]	
F1 Help	↑↓ Select Item	-/+ Change Values
ESC Exit	←→ Select Menu	Enter Select Sub-Menu
		F9 Setup Defaults
		F10 Previous Values

3-2.3.1 Set Supervisor Password & Set User Password

The "Supervisor Password" is for system boot up and Setup Utility access. The User password is for the system boot only. The main board is shipped with no password, the default value is Disabled. If you want to set the Supervisor Password, press the <Enter> key, the Supervisor Password screen will be displayed. The password can be up to 8 alphanumeric characters. Press the <Enter> key after you have finished typing in the password. At the next prompt, confirm the new password by re-typing it and pressing <Enter> again.

NOTE

If you press the wrong password, then the system will be disabled.

3-2.3.2 Password on boot

Press the spacebar to select "Enabled" or "Disabled" on boot.

3-2.3.3 Diskette access

If you select "Supervisor" then you can use User password to enter into the system, but the FDD is not available. If you select the "User" Password to enter into the system, the FDD can be accessed.

3-2.3.4 Fixed disk boot sector

The "Fixed disk boot sector" has two choices. If "Normal" is selected, the boot sector of the fixed disk can be read and written. When "Write protect" is selected, the boot sector is protected from being written.

3-2.3.5 System backup reminder

Press the spacebar to select "Disabled", "Daily", "Weekly" or "Monthly".

3-2.3.6 Virus check reminder

Press the spacebar to select the "Disabled", "Daily", "Weekly" or "Monthly".

3-2.4 Power

The section describes the Power Mangement mode of the SETUP.

PhoenixBIOS Setup-Copyright 1985-95 Phoenix Technologies Ltd.

Power

		Item Specific Help	
Power Savings:	[Off]	Select Power Management Mode. Choosing modes changes system power management settings. Maximum Battery Life conserves the greatest amount of system power while Maximum performance conserves power but allows greatest system performance. To alter these settings, choose Customize. To turn off power management, choose OFF.	
Hard Disk Timeout:	Off		
Video Timeout:	Off		
Standby Timeout:	Off		
Auto Suspend Timeout:	Off		
F1 Help	↑↓ Select Item	-/+ Change Values	F9 Setup Defaults
ESC Exit	←→ Select Menu	Enter Select	▶ Sub-Menu F10 Previous Values

3-2.4.1 Power Savings

Press the spacebar to select "Off", "Customize", "Maximum Performance" or "Maximum Battery Life".

3-2.4.1.1 Hard Disk Timeout

Amount of time the hard disk needs to be inactive before it is turned off.

3-2.4.1.2 Video Timeout

Amount of time for the user inputted devices need to be inactive before the screen is turned off.

3-2.4.1.3 Standby Timeout

Amount of time the system needs to be in Idle Mode before entering the Standby Mode. Standby Mode turns off various devices in the system, including the screen, until you start using the computer again.

3-2.4.1.4 Suspend Mode

Select the type of Suspend Mode. If you choose SAVE TO DISK the system will save its state to disk and power off. If you choose SUSPEND the system will save its state but remain in a low power mode. If you choose SUSPEND then you also have the option of choosing Auto Save To Disk.

3-2.5 Exit

The section describes the "Save Changes & Exit", "Exit Without Saving Changes", "Get Default Values", "Load Previous values" and "Save Changes" of the SETUP.

PhoenixBIOS Setup-Copyright 1985-95 Phoenix Technologies Ltd.

Exit

							Item Specific Help	
Save Changes & Exit Exit Without Saving Changes Get Default Values Load previous Values Save Changes							Exit after writing all changed SETUP item values to CMOS.	
F1	Help	↑↓	Select Item	-/+	Change	Values	F9	Setup Defaults
ESC	Exit	←→	Select Menu	Enter	Select	Sub-Menu	F10	Previous Values

3-2.5.1 Save Changes & Exit

If you select this and press the <Enter> key, the values entered values will be recorded in the CMOS memory on the main board. The system will check it every time you turn your system on and compare it with what it finds.

3-2.5.2 Exit Without Saving Changes

Selecting this option and pressing the <Enter> key lets you exit the Setup Utility without recording any changed values. If you want to save a new configuration, do not use this option. If you do so, any new data you just entered will be lost.

3-2.5.3 Get Default Values

Pressing the <Enter> key, the system will be loaded default values for all SETUP items.

3-2.5.4 Load Previous Values

Pressing the <Enter> key, the system will read previous values from CMOS for all SETUP items.

3-2.5.5 Save Changes

Press the <Enter> key when the cursor is in the Save Changes field, all changes will be written to CMOS RAM.

Chapter 4

Notebook Maintenance

4-1 Introduction

This chapter tells how to maintain the notebook in good working order.

4-2 Daily Use

For maximum reliability in the field, keep all access doors shut whenever possible.

4-3 Battery Maintenance

Maintaining and preserving the battery is a key to keeping the notebook productive in the field.

4-3.1 Conserving Power

Even though the notebook has several automatic power saving features, there are ways to maximize the battery life.

- Use the lowest brightness and contrast display settings.
- Avoid using "reverse video". The white text on a black background uses significantly less power than black on white.
- Develop good, consistent work habits. Set the power management features according to your style. For example, if you do not read from or write to the hard disk very often, set the hard disk time-out setting to a very short time.
- Plan each computing session ahead of time. Don't waste valuable time and power thinking about what to do.
- Disable the cache if you do not need it.

4-3.2 Changing the Battery Pack

To change the battery pack:

1. Loosen two screws from battery pack on the two sides.
2. Pull handle from battery pack.
3. Take the battery pack out.
4. Put another battery pack back in the battery pack house and make sure that the removal strap is available for future changes.

4-4 Cleaning

Periodically clean the exposed notebook surfaces. Use a soft cloth and water or mild detergent to clean all surfaces. The glass cleaner is recommended for cleaning the display screen.

Chapter 5

Troubleshooting

5-1 Introduction

Chapter 5 explains warning signals and their corrective actions. It also gives guidance for problems that might occur in every day use.

5-2 Warnings and Indications

The notebook gives an audible alarm or visual indication of possible problems during certain abnormal conditions.

The following are descriptions of situations calling for caution or corrective action. For a complete list of indications.

5-2.1 CHARGE Light On

The CHARGE light comes on whenever the batteries are in charging.

5-2.2 CHARGE Light Blinking

The CHARGE light blinks whenever the batteries are initial charge detect.

5-3 Common Problems

When you encounter a problem, begin by performing a careful visual inspection. Check the exterior of the notebook first. If no indicators are on, check the battery charge or electrical outlet, the plug and power cord, and any power switches that may effect your notebook. If the notebook has been connected to an peripheral devices, look for loose or disconnected cables.

A few common problems and suggested soultions are presented in the samples which follow.

1. The power button does not funciton.

- The power button does not accept just a light touch. Press the button firmly.
- If you are using battery power, the battery may be discharged. Connect the AC adapter.

2. The screen is blank.

- Press the Spacebar to see if any power management feature has blanked the screen to save power.
- If Power on indicator is not on, check the electrical outlet, the plugs and power cords.
- If you are using a battery pack, make sure it has a charge remaining, and that it is installed correctly.
- Check the brightness controls for you display.
- Turn the notebook off, wait a few seconds, and then turn the notebook back on.

3. The floppy disk drive cannot read or write a diskette.

- The diskette may not be formatted, or could be corrupted.
- If you can't write to a diskette, the diskette may be write-protected. Check to ensure that the write-protect tab covers the detection hole.
- If you can't write to a diskette, the diskette may be full. Use another diskette.
- The floppy disk drive type may be incorrect in the SETUP program. Run SETUP to ensure that "Diskette A" is set the proper type (1.44MB).

4. The message "non-system disk" or "disk error" appears on the screen after you turn on the system.

- You may have inserted a non-bootable diskette in the floppy disk drive. Remove the diskette.

- Check the SETUP program to ensure that the drive types are correctly identified.
 - If this message is issued when you attempt to boot from your hard disk drive, insert a bootable diskette and check the integrity of your hard disk drive.
5. The date and /or time is incorrect.
- Correct the date and time using the SETUP program or your operating system.
 - If the date and time are still incorrect, it can be that the RTC battery is discharged after the notebook has not been used for a very long time. Then run the SETUP program to reconfigure the system.

5-3.1 Error Messages

Two types of error messages may appear when using the computer:

- Software
- Hardware

When an error message appears, stop using the computer and write the message down.

If the problem is software related, refer to the software documentation for corrective action. Hardware error messages usually give advice on how to correct the problem with the message. If no advice is included, refer the problem to an authorized repair facility.

5-3.2 Startup

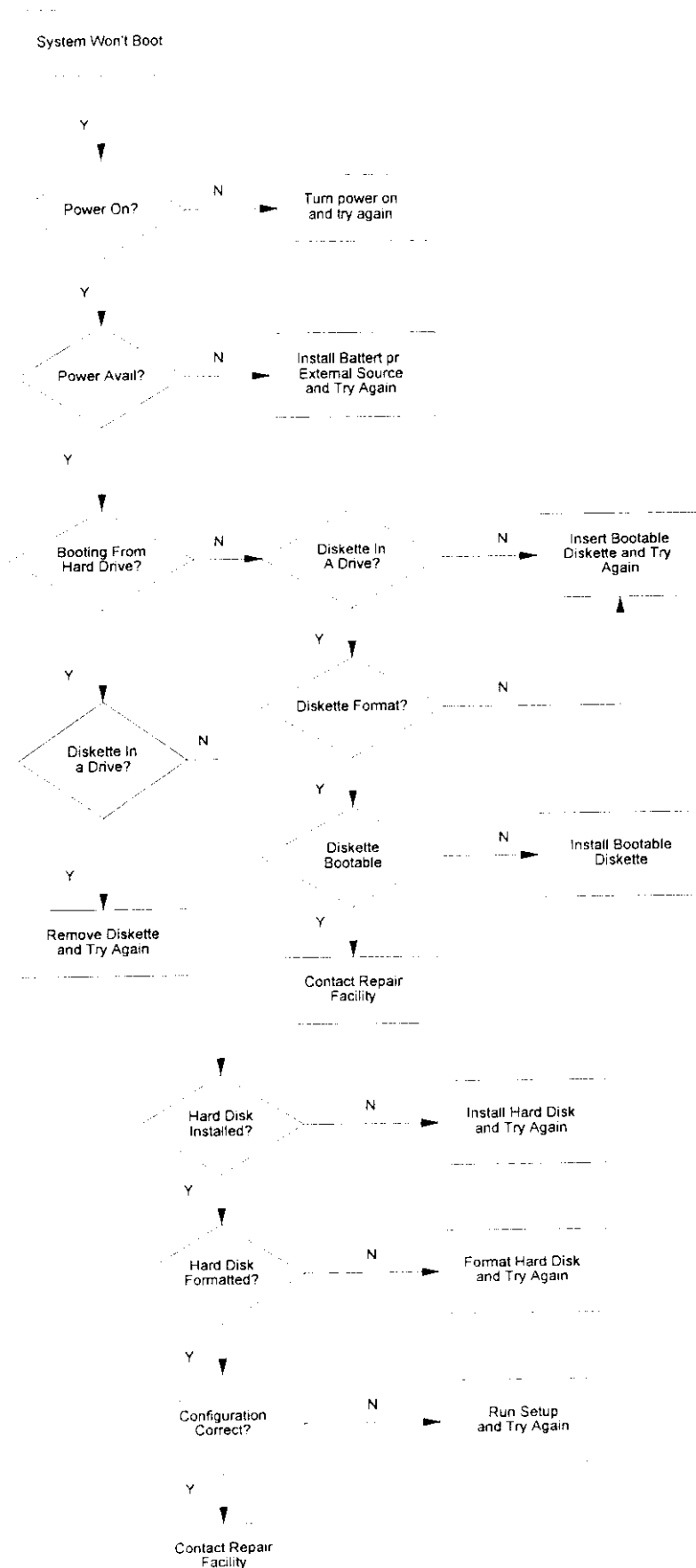

5-3.3 Keyboard and Point Device

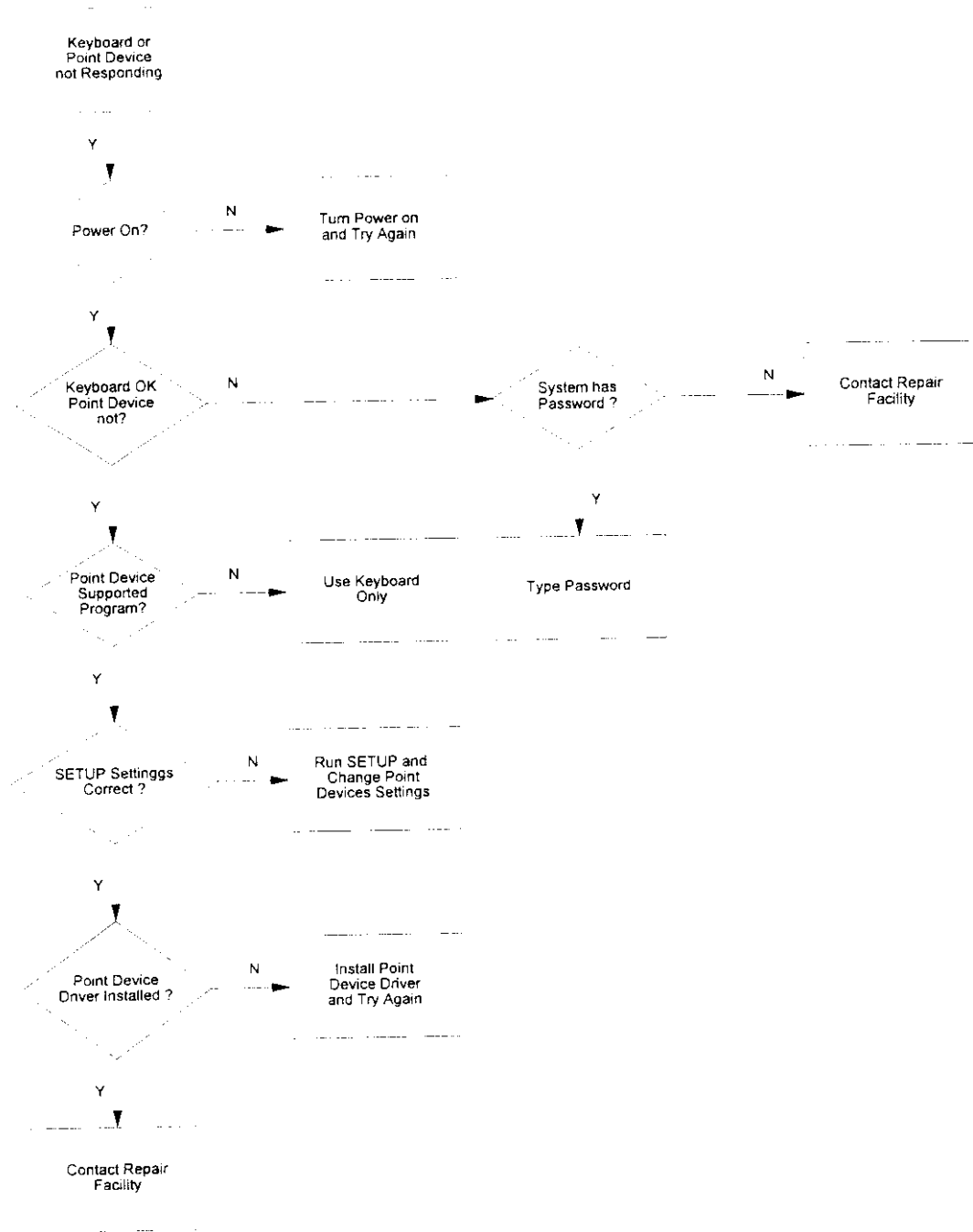

5-3.4 Display

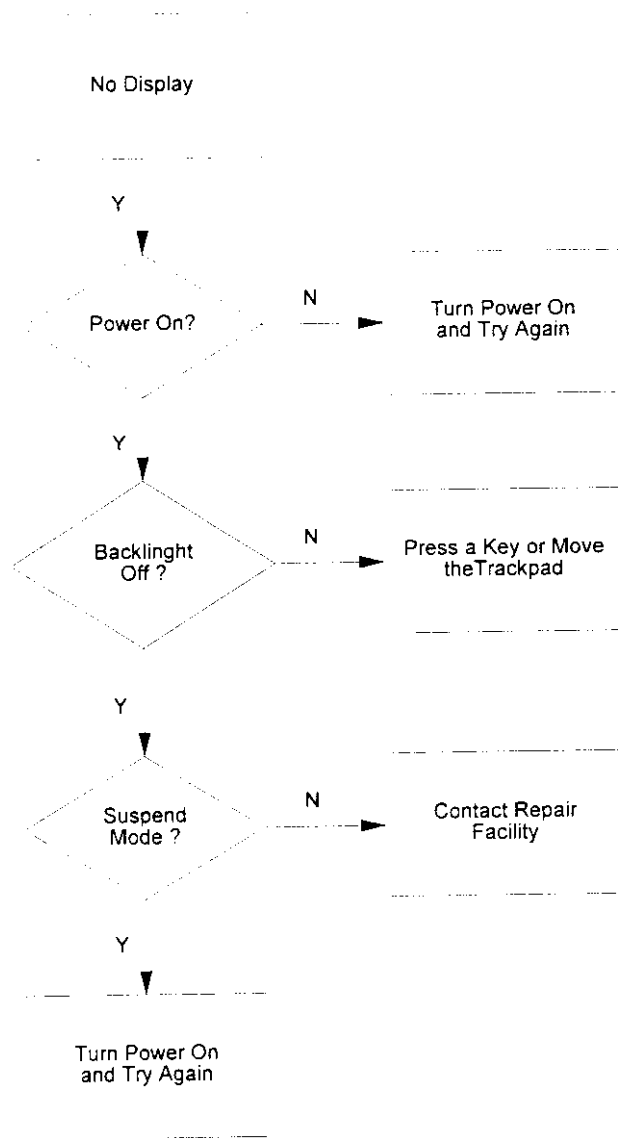

5-3.5 PCMCIA

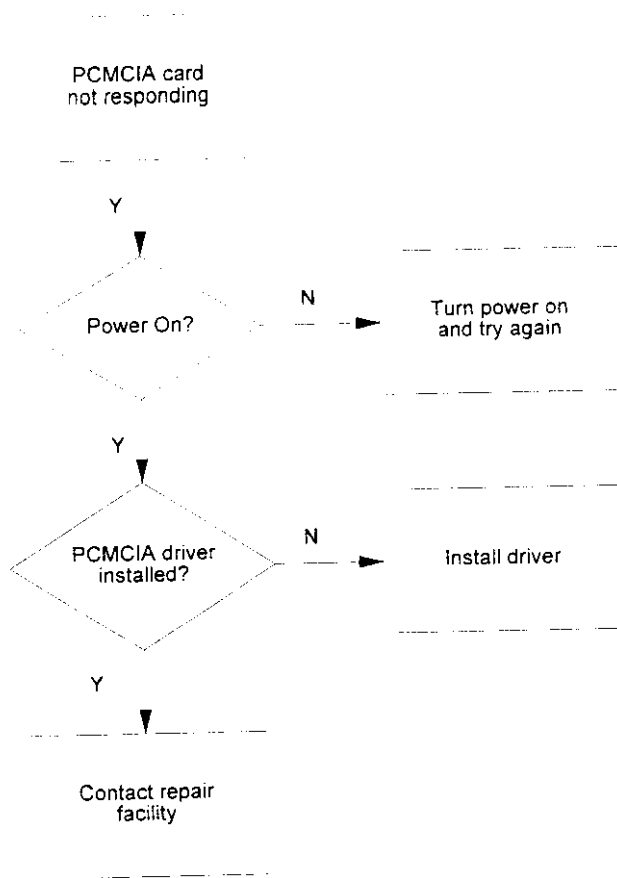

Appendix A Keyboard Layouts

1 Germany Keyboard

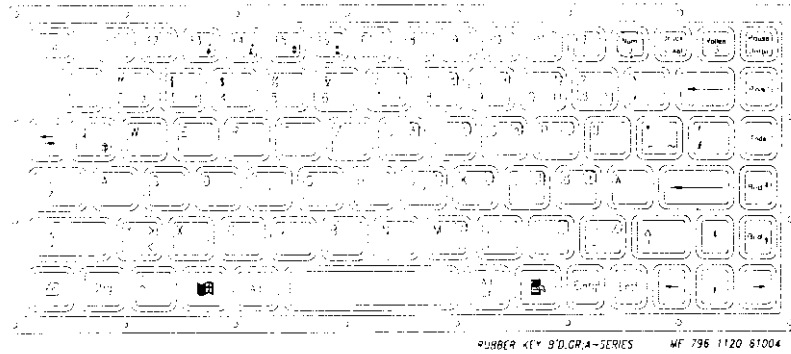

2. French Keyboard

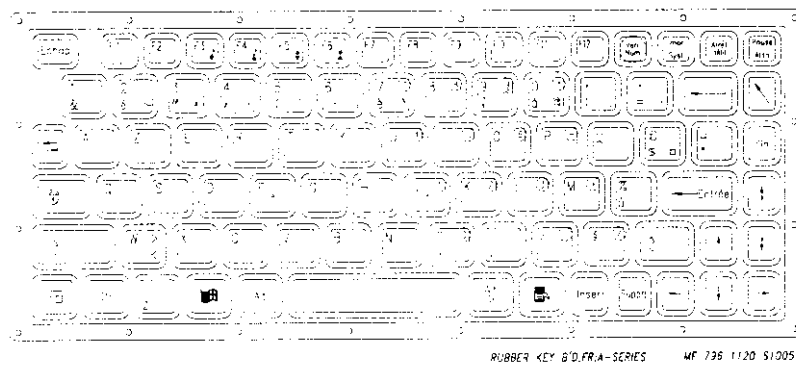

3. United Kingdom Keyboard

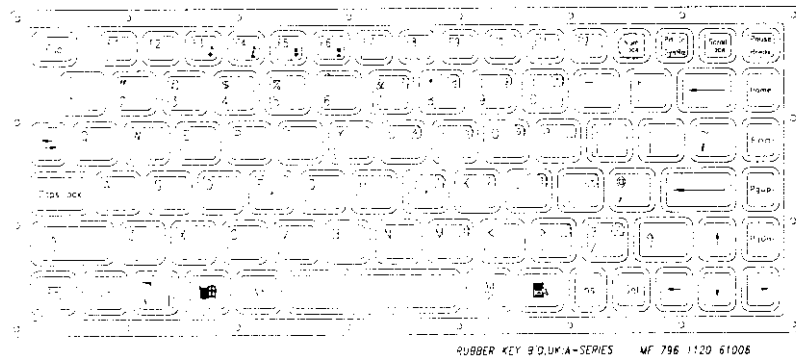

4.Swedish Keyboard

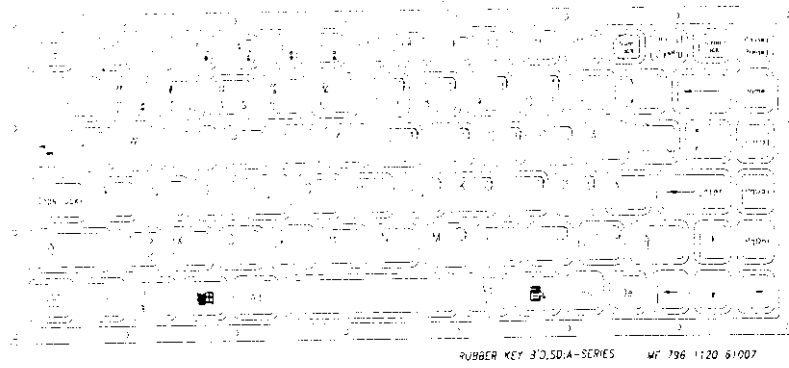

5.Danish Keyboard

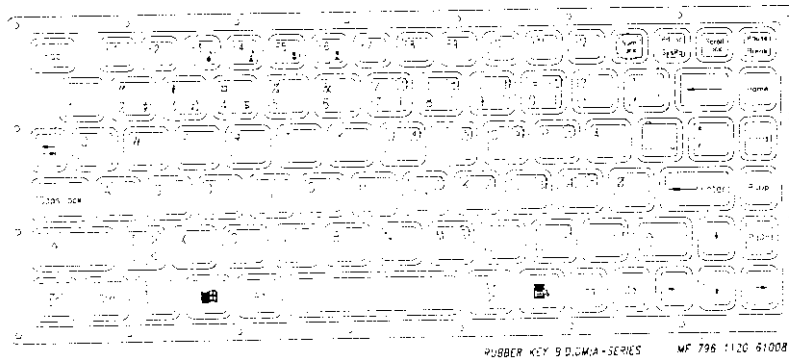

6.Itily Keyboard

