

DFS TEST REPORT

REPORT NO.: RF930507H07X

MODEL NO.: AP5822, AP5822E

RECEIVED: Nov. 15, 2006

TESTED: Nov. 20, 2006 to March 08, 2007

ISSUED: March 22, 2007

APPLICANT: Microelectronics Technology Inc.

ADDRESS: 1, Innovation Road II, Hsinchu Science-based
Industrial Park, Hsinchu, Taiwan, R.O.C.

ISSUED BY: Advance Data Technology Corporation

TEST LOCATION: No. 81-1, Lu Liao Keng, 9 Ling, Wu Lung Tsuen,
Chiung Lin Hsiang, Hsin Chu Hsien,
Taiwan, R.O.C.

This test report consists of 126 pages in total. It may be duplicated completely for legal use with the approval of the applicant. It should not be reproduced except in full, without the written approval of our laboratory. The client should not use it to claim product endorsement by CNLA, A2LA or any government agencies. The test results in the report only apply to the tested sample.



Table of Contents

1.	CERTIFICATION.....	4
2.	TEST REQUIREMENT	5
2.1	OPERATING FREQUENCY OF U-NII DEVICE	6
2.2	TEST LIMITS AND RADAR SIGNAL PARAMETERS	6
3.	GENERAL INFORMATION	9
3.1	TEST INSTRUMENTS	9
3.2	DESCRIPTION OF SUPPORT UNITS.....	9
3.3	SOFTWARE AND FIRMWARE	9
3.4	DESCRIPTION OF AVAILABLE ANTENNAS.....	10
3.5	MAXIMUM AND MINIMUM CONDUCTED POWER.....	10
3.6	MAXIMUM AND MINIMUM E.I.R.P. POWER.....	10
3.7	STATEMENT OF MAUNFACTURER	11
4.	TEST PROCEDURE	11
4.1	ADT DFS MEASUREMENT SYSTEM:	11
4.2	CALIBRATION OF DFS DETECTION THRESHOLD LEVEL:.....	12
4.3	DEVIATION FROM TEST STANDARD	13
4.4	CONDUCTED TEST SETUP CONFIGURATION	13
4.4.1	MASTER MODE	13
4.4.2	CLIENT WITH RADAR DETECTION MODE	14
5.	SUMMARY OF TEST RESULTS.....	16
5.1	LIST OF MEASUREMENTS	16
5.1.1	THE UUT IS CAPABLE OF OPERATING AS A MASTER.....	16
5.1.2	THE UUT IS CAPABLE OF OPERATING AS A CLIENT WITH RADAR DETECTION.....	16
5.2	DFS TEST RESULTS	17
5.2.1	THE UUT IS A U-NII DEVICE OPERATING IN MASTER MODE.....	17
5.2.1.1	DFS DETECTION THRESHOLD	17
5.2.1.2	CHANNEL AVAILABILITY CHECK TIME	21
5.2.1.3	CHANNEL CLOSING TRANSMISSION AND CHANNEL MOVE TIME	23
5.2.1.4	NON- OCCUPANCY PERIOD.....	37
5.2.1.5	UNIFORM SPREADING	38
5.2.1.6	U-NII DETECTION BANDWIDTH	39
5.2.2	THE UUT IS A U-NII DEVICE OPERATING IN CLIENT WITH RADAR DETECTION MODE.41	
5.2.2.1	DFS DETECTION THRESHOLD	41
5.2.2.2	CHANNEL CLOSING TRANSMISSION AND CHANNEL MOVE TIME	42
5.2.3	THE UUT IS A U-NII DEVICE OPERATING IN CLIENT WITH RADAR DETECTION MODE.44	



5.2.3.1 DFS DETECTION THRESHOLD	44
5.2.3.2 CHANNEL CLOSING TRANSMISSION AND CHANNEL MOVE TIME	48
5.2.3.3 NON- OCCUPANCY PERIOD.....	62
5.2.3.4 U-NII DETECTION BANDWIDTH	63
5.3 TRANSMIT POWER CONTROL (TPC)	65
6. ANTENNA REQUIREMENT.....	65
6.1 STANDARD APPLICABLE.....	65
6.2 ANTENNA CONNECTED CONSTRUCTION.....	65
7. INFORMATION ON THE TESTING LABORATORIES.....	66
APPENDIX-A.....	A-1
APPENDIX-B	A-2
APPENDIX-C	A-60



1. CERTIFICATION

PRODUCT: 802.11a+b/g Outdoor AP/Bridge With Internal Antenna,
802.11a+b/g Outdoor AP/Bridge With External Antenna

BRAND NAME: MTI

MODEL NO.: AP5822, AP5822E

TEST SAMPLE: MASS-PRODUCTION

TESTED: Nov. 20, 2006 to March 08, 2007

APPLICANT: Microelectronics Technology Inc.

STANDARDS: **FCC Part 15, Subpart E (Section 15.407)**
FCC 06-96

The above equipment (Model: AP5822, AP5822E) have been tested by **Advance Data Technology Corporation**, and found compliance with the requirement of the above standards. The test record, data evaluation & Equipment Under Test (EUT) configurations represented herein are true and accurate accounts of the measurements of the sample's EMC characteristics under the conditions specified in this report.

PREPARED BY : Carol Liao , **DATE:** March 22, 2007
(Carol Liao)

TECHNICAL ACCEPTANCE : Moris Lin , **DATE:** March 22, 2007
Responsible for RF (Moris Lin)

APPROVED BY : Hank Chung , **DATE:** March 22, 2007
(Hank Chung, Deputy Manager)

2. TEST REQUIREMENT

The manufacturer shall state whether the UUT is capable of operating as a Master and/or a Client. If the UUT is capable of operating in more than one operating mode then each operating mode shall be tested separately. See tables 1 and 2 for the applicability of DFS requirements for each of the operational modes.

Table 1: Applicability of DFS requirements prior to use a channel

Requirement	Operational Mode		
	Master	Client without radar detection	Client with radar detection
Non-Occupancy Period	ü	Not required	ü
DFS Detection Threshold	ü	Not required	ü
Channel Availability Check Time	ü	Not required	Not required
Uniform Spreading	ü	Not required	Not required
U-NII Detection Bandwidth	ü	Not required	ü

Table 2: Applicability of DFS requirements during normal operation.

Requirement	Operational Mode		
	Master	Client without radar detection	Client with radar detection
DFS Detection Threshold	ü	Not required	ü
Channel Closing Transmission Time	ü	ü	ü
Channel Move Time	ü	ü	ü
U-NII Detection Bandwidth	ü	Not required	ü

2.1 OPERATING FREQUENCY OF U-NII DEVICE

Table 3: Operating frequency range of UUT.

Operational Mode	Operating Frequency Range	
	5250~5350MHz	5470~5725MHz
Master	ü	ü
Client without radar detection	Not Apply	Not Apply
Client with radar detection	ü	ü

2.2 TEST LIMITS AND RADAR SIGNAL PARAMETERS

DETECTION THRESHOLD VALUES

Table 4: DFS Detection Thresholds for Master Devices and Client Devices With Radar Detection.

Maximum Transmit Power	Value (See Notes 1 and 2)
≥ 200 milliwatt	-64 dBm
< 200 milliwatt	-62 dBm

Note 1: This is the level at the input of the receiver assuming a 0 dBi receive antenna.

Note 2: Throughout these test procedures an additional 1 dB has been added to the amplitude of the test transmission waveforms to account for variations in measurement equipment. This will ensure that the test signal is at or above the detection threshold level to trigger a DFS response.

Table 5: DFS Response Requirement Values

Parameter	Value
Non-occupancy period	Minimum 30 minutes
Channel Availability Check Time	60 seconds
Channel Move Time	10 seconds See Note 1.
Channel Closing Transmission Time	200 milliseconds + an aggregate of 60 milliseconds over remaining 10 second period. See Notes 1 and 2.
U-NII Detection Bandwidth	Minimum 80% of the UNII 99% transmission power bandwidth. See Note 3.

Note 1: The instant that the Channel Move Time and the Channel Closing Transmission Time begins is as follows:

- For the Short Pulse Radar Test Signals this instant is the end of the Burst.
- For the Frequency Hopping radar Test Signal, this instant is the end of the last radar Burst generated.
- For the Long Pulse Radar Test Signal this instant is the end of the 12 second period defining the Radar Waveform.

Note 2: The Channel Closing Transmission Time is comprised of 200 milliseconds starting at the beginning of the Channel Move Time plus any additional intermittent control signals required to facilitate a Channel move (an aggregate of 60 milliseconds) during the remainder of the 10 second period. The aggregate duration of control signals will not count quiet periods in between transmissions.

Note 3: During the U-NII Detection Bandwidth detection test, radar type 1 is used and for each frequency step the minimum percentage of detection is 90 percent. Measurements are performed with no data traffic.

PARAMETERS OF DFS TEST SIGNALS

Step intervals of 0.1 microsecond for Pulse Width, 1 microsecond for PRI, 1 MHz for chirp width and 1 for the number of pulses will be utilized for the random determination of specific test waveforms.

Table 6: Short Pulse Radar Test Waveforms.

Radar Type	Pulse Width (μsec)	PRI (μsec)	Number of Pulses	Minimum Percentage of Successful Detection	Minimum Number of Trials
1	1	1428	18	60%	30
2	1-5	150-230	23-29	60%	30
3	6-10	200-500	16-18	60%	30
4	11-20	200-500	12-16	60%	30
Aggregate (Radar Types 1-4)				80%	120

Table 7: Long Pulse Radar Test Waveform

Radar Type	Pulse Width (μsec)	Chirp Width (MHz)	PRI (μsec)	Number of Pulses per Burst	Number of Bursts	Minimum Percentage of Successful Detection	Minimum Number of Trials
5	50-100	5-20	1000-2000	1-3	8-20	80%	30

Table 8: Frequency Hopping Radar Test Waveform

Radar Type	Pulse Width (μsec)	PRI (μsec)	Pulses per Hop	Hopping Rate (kHz)	Hopping Sequence Length (msec)	Minimum Percentage of Successful Detection	Minimum Number of Trials
6	1	333	9	0.333	300	70%	30

3. GENERAL INFORMATION

3.1 TEST INSTRUMENTS

Table 9: Test instruments list.

DESCRIPTION & MANUFACTURER	MODEL NO.	BRAND	CALIBRATED UNTIL
R&S Spectrum analyzer	FSP40	R&S	Aug. 15, 2007
Signal generator	8645A	Agilent	May. 26, 2008
Oscilloscope	TDS 5104	Tektronix	Apr. 05. 2007

3.2 DESCRIPTION OF SUPPORT UNITS

Table 10: Support Unit information.

No.	Product	Brand	Model No.	ID	Spec.
1	802.11a Outdoor Bridge With External Antenna	MTI.	BR5811bE		

3.3 SOFTWARE AND FIRMWARE

Table 11: The software/firmware version for U-NII device.

No.	Product	Model No.	Software/Firmware Version
1	802.11a+b/g Outdoor AP/Bridge With External Antenna	AP5822E	Ver 4.28C , Ver 4.28C (Test)
2	802.11a Outdoor Bridge With External Antenna	BR5811bE	Ver 4.28C , Ver 4.28C (Test)

Note: Firmware version

Ver 4.28C for normal use.

Ver 4.28C (Test) for DFS test only which can overrides the Channel Selection mechanism.

3.4 DESCRIPTION OF AVAILABLE ANTENNAS

Table 12: Antenna list.

Ant NO.	Antenna	Type	Operation Frequency Range	Max. Gain(dBi)
1	UMIT,ANT05535(Int.)	Directional, Patch Panel	5.47 – 5.850 GHz	17
2	Smartant,R0420-058(Ext.)	Dipole,Omni	5.25 – 5.35 GHz	8
3	Evertime,1GP-51809(Ext.)	Dipole,Omni	5.1 – 5.9 GHz	9

3.5 MAXIMUM AND MINIMUM CONDUCTED POWER

Table 13: The measured conducted output power.

Ant NO.	Frequency Band(MHZ)	MAX. Power		MIN. Power	
		Output Power(dBm)	Output Power(mW)	Output Power(dBm)	Output Power(mW)
1	5470~5725MHz	12.52	17.86487575	6.16	4.13047502
2	5250~5350MHz	18.72	74.47319739	11.23	13.27394458
3	5250~5350MHz	20.23	105.4386896	12.01	15.88546749
3	5470~5725MHz	20.09	102.0939484	11.43	13.89952631

3.6 MAXIMUM AND MINIMUM E.I.R.P. POWER

Table 14: The E.I.R.P output power list.

Ant NO.	Frequency Band(MHZ)	MAX. Power		MIN. Power	
		Output Power(dBm)	Output Power(mW)	Output Power(dBm)	Output Power(mW)
1	5470~5725MHz	29.52	895.3647655	23.16	207.0141349
2	5250~5350MHz	26.72	469.8941086	19.23	83.75292821
3	5250~5350MHz	29.23	837.5292821	21.01	126.1827535
3	5470~5725MHz	29.09	810.9610579	20.43	110.407862

3.7 STATEMENT OF MAUNFACTURER

Manufacturer statement confirming that information regarding the parameters of the detected Radar Waveforms is not available to the end user.

4. TEST PROCEDURE

4.1 ADT DFS MEASUREMENT SYSTEM:

A complete ADT DFS Measurement System consists of two subsystems: (1) the Radar Signal Generating Subsystem and (2) the Traffic Monitoring Subsystem. The control PC is necessary for generating the Radar waveforms in Table 6, 7 and 8. The traffic monitoring subsystem is specified to the type of unit under test (UUT).

Conducted setup configuration of ADT DFS Measurement System

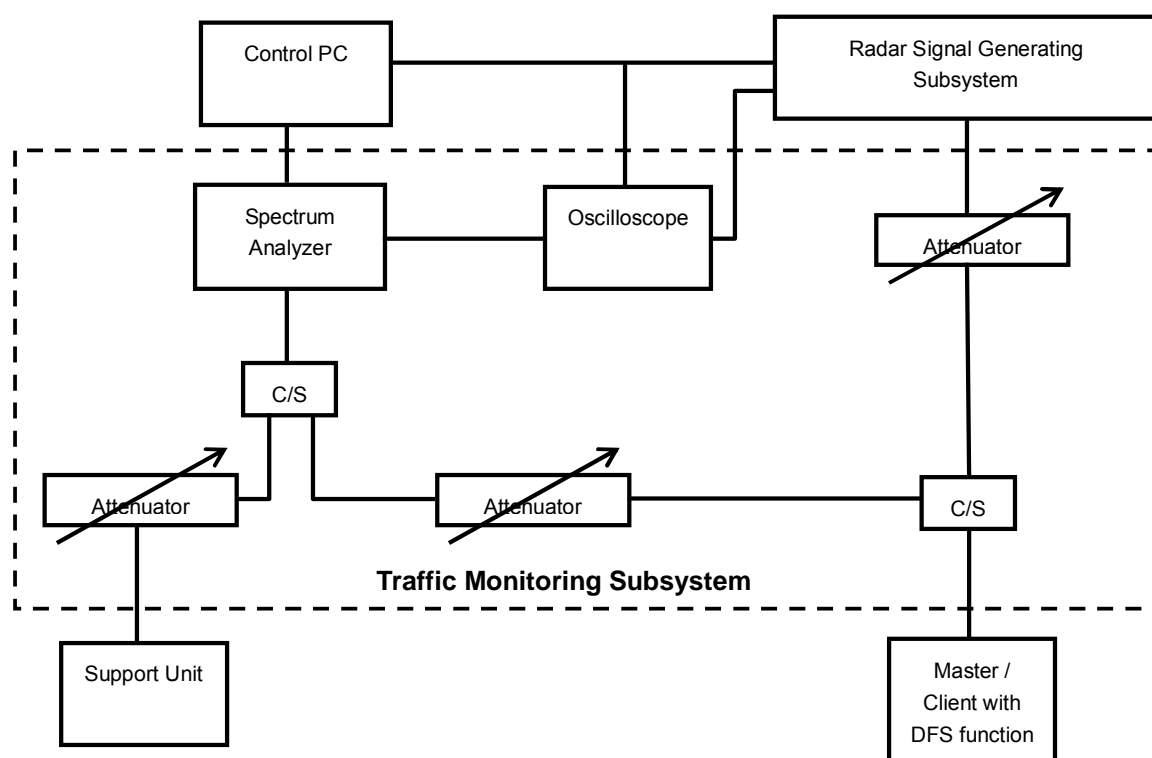

The test transmission will always be from the Master Device to the Client Device. While the Client device is set up to associate with the Master device and play the MPEG file (6 y Magic Hours) from Master device, the designated MPEG test file and instructions are located at:

<http://ntiacsd.ntia.doc.gov/dfs/>.

4.2 CALIBRATION OF DFS DETECTION THRESHOLD LEVEL:

The measured channel is 5320MHz. The radar signal was the same as transmitted channels, and injected into the antenna port of AP (master) or Client Device with Radar Detection, measured the channel closing transmission time and channel move time. The Master antenna gain is 8dBi and required detection threshold is -55dBm (= -64 +1+8)dBm. The calibrated conducted detection threshold level is set to -56dBm. The tested level is lower than required level hence it provides margin to the limit.

Conducted setup configuration of Calibration of DFS Detection Threshold Level

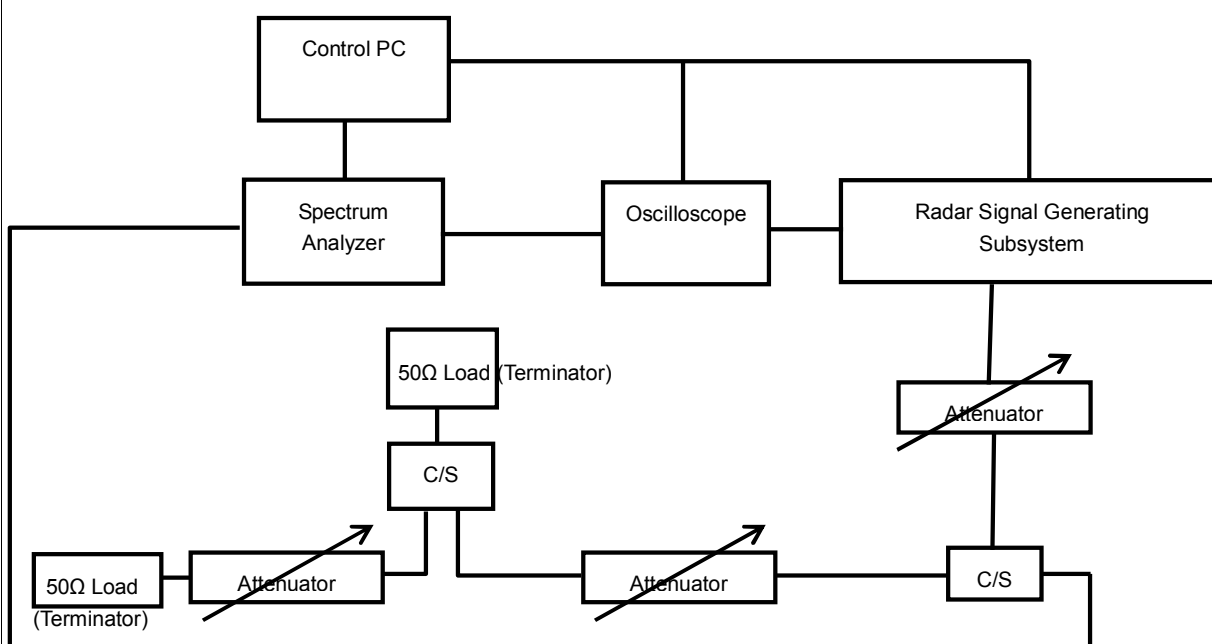

4.3 DEVIATION FROM TEST STANDARD

No deviation.

4.4 CONDUCTED TEST SETUP CONFIGURATION

4.4.1 MASTER MODE

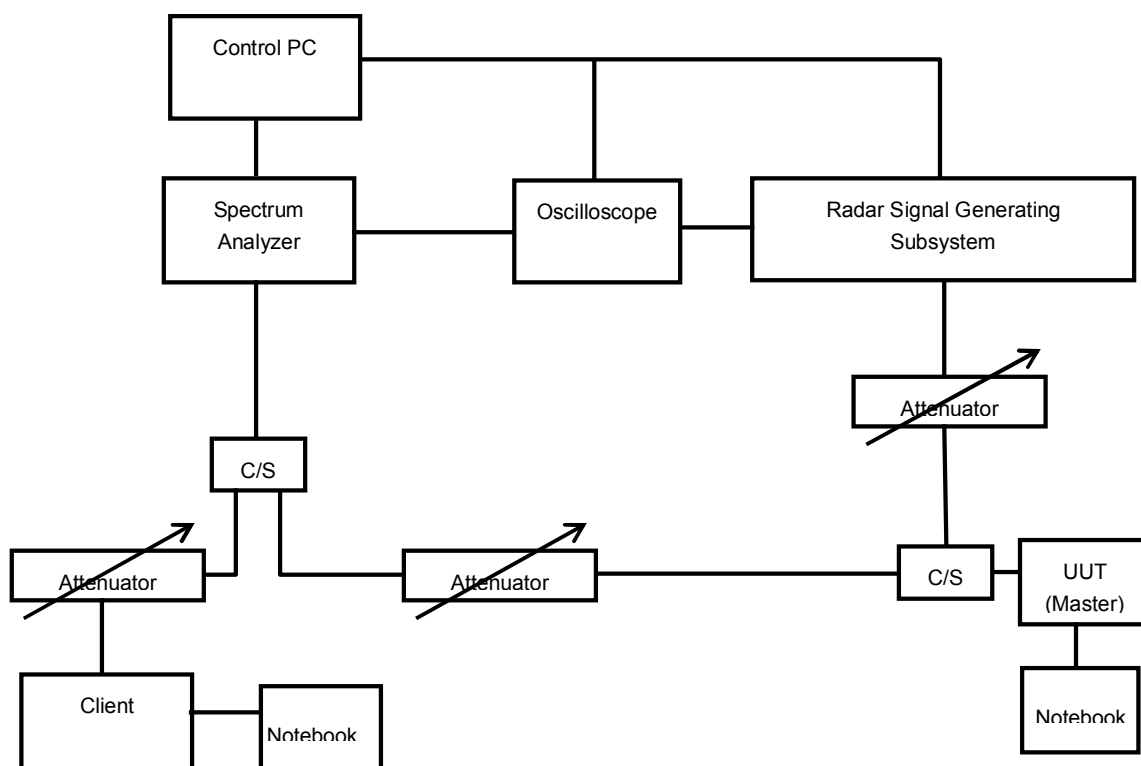

The UUT is a U-NII Device operating in Master mode. The radar test signals are injected into the Master Device.

4.4.2 CLIENT WITH RADAR DETECTION MODE

Radar injected into Master Device

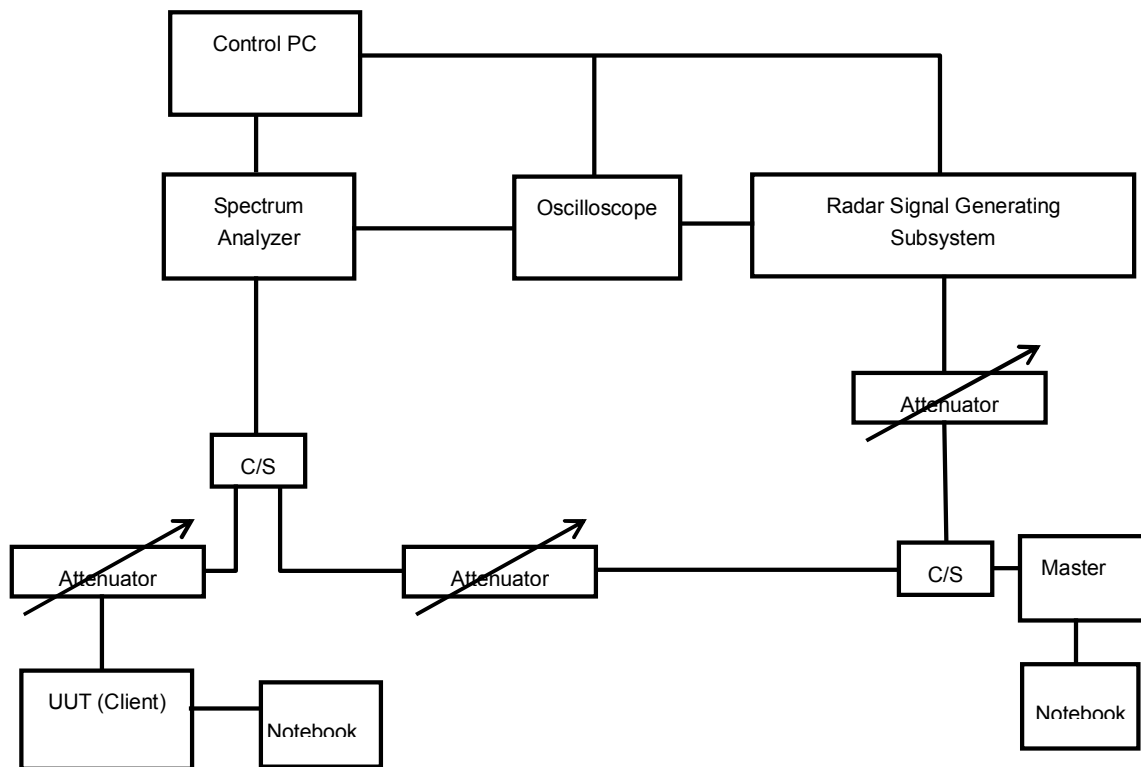

The UUT is a U-NII Device operating in Client mode with radar detection. The radar test signals are injected into the Master Device.

Radar injected into UUT(Client with Radar Detction)

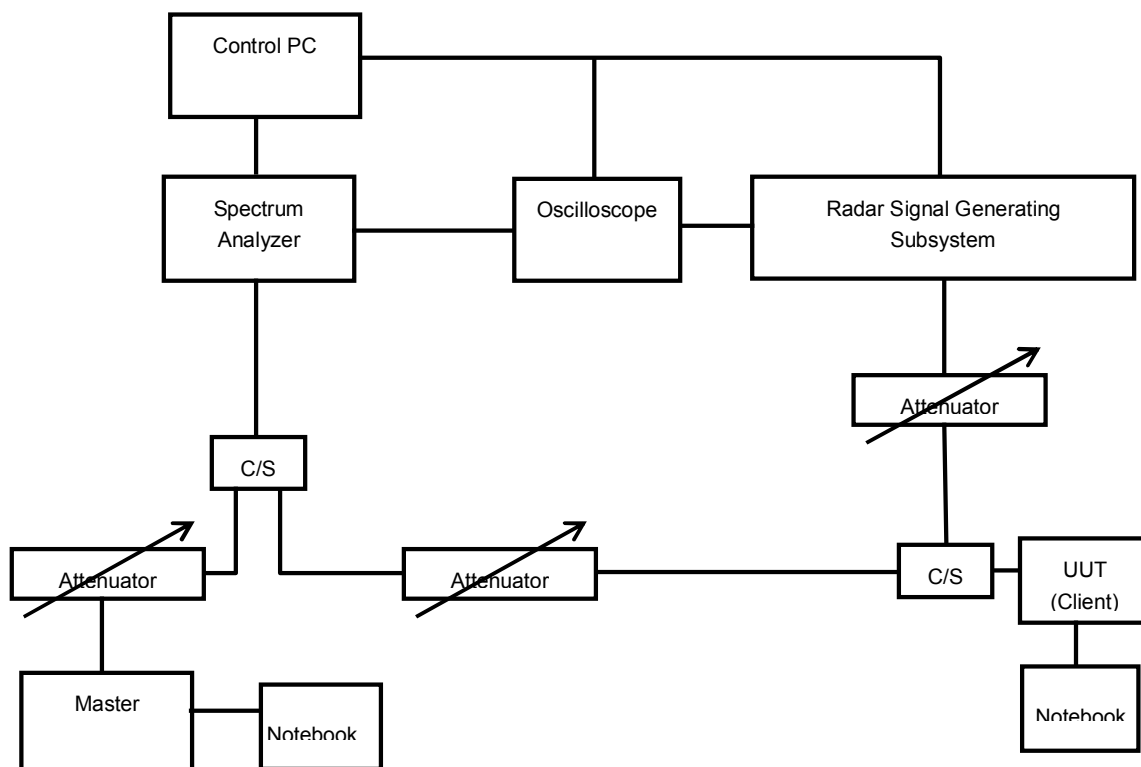

The UUT is a U-NII Device operating in Client with radar detection mode. The radar test signals are injected into the Client Device.

5. SUMMARY OF TEST RESULTS

5.1 LIST OF MEASUREMENTS

5.1.1 THE UUT IS CAPABLE OF OPERATING AS A MASTER.

Clause	Test Parameter	Remarks	Pass/Fail
15.407	DFS Detection Threshold	Applicable	Pass
15.407	Channel Availability Check Time	Applicable	Pass
15.407	Channel Move Time	Applicable	Pass
15.407	Channel Closing Transmission Time	Applicable	Pass
15.407	Non- Occupancy Period	Applicable	Pass
15.407	Uniform Spreading	Applicable	Pass
15.407	U-NII Detection Bandwidth	Applicable	Pass

5.1.2 THE UUT IS CAPABLE OF OPERATING AS A CLIENT WITH RADAR DETECTION.

Clause	Test Parameter	Remarks	Pass/Fail
15.407	DFS Detection Threshold	Applicable	Pass
15.407	Channel Availability Check Time	Not Applicable	NA
15.407	Channel Move Time	Applicable	Pass
15.407	Channel Closing Transmission Time	Applicable	Pass
15.407	Non- Occupancy Period	Applicable	Pass
15.407	Uniform Spreading	Not Applicable	NA
15.407	U-NII Detection Bandwidth	Applicable	Pass

5.2 DFS TEST RESULTS

5.2.1 THE UUT IS A U-NII DEVICE OPERATING IN MASTER MODE.

Master with injection at the Master. (Radar Test Waveforms are injected into the Master.

5.2.1.1 DFS DETECTION THRESHOLD

For a detection threshold level of -64dBm and the Master antenna gain is 8dBi . The Required detection threshold is -55dBm ($= -64 + 1 + 8$) dBm . The conducted radar burst level is set to -56dBm . The tested level is lower than required level hence it provides margin to the limit.

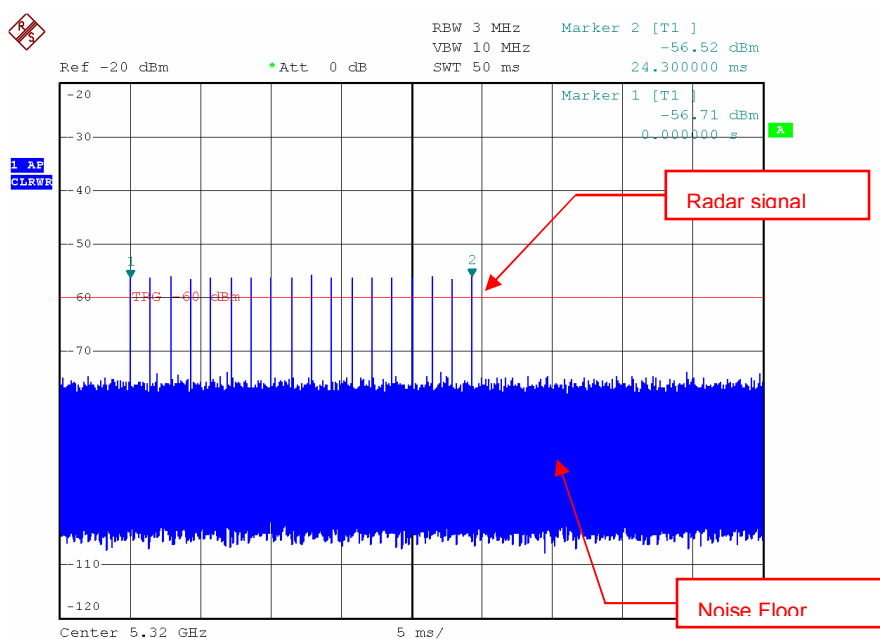

Date: 29.DEC.2006 12:29:41

Radar Signal 1

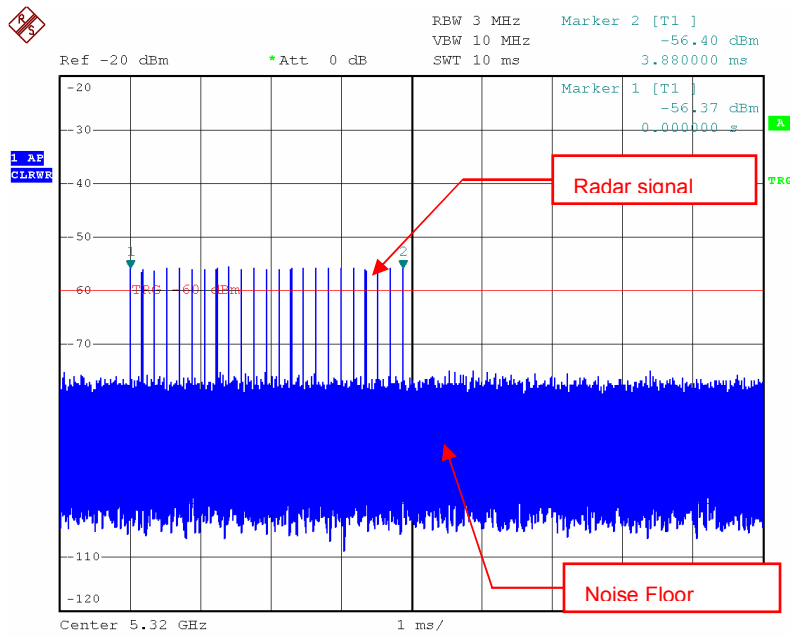

Date: 29.DEC.2006 12:30:34

Radar Signal 2

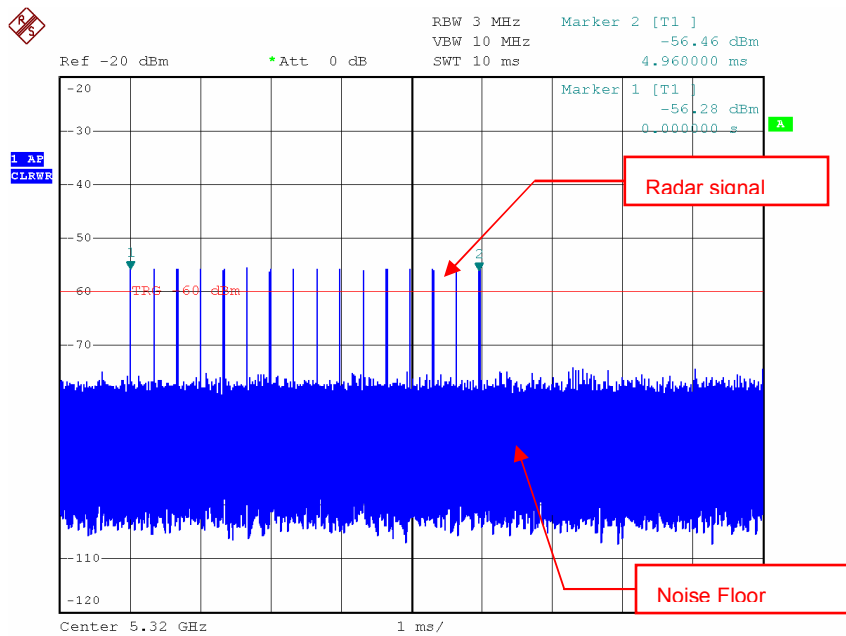

Date: 29.DEC.2006 12:31:27

Radar Signal 3

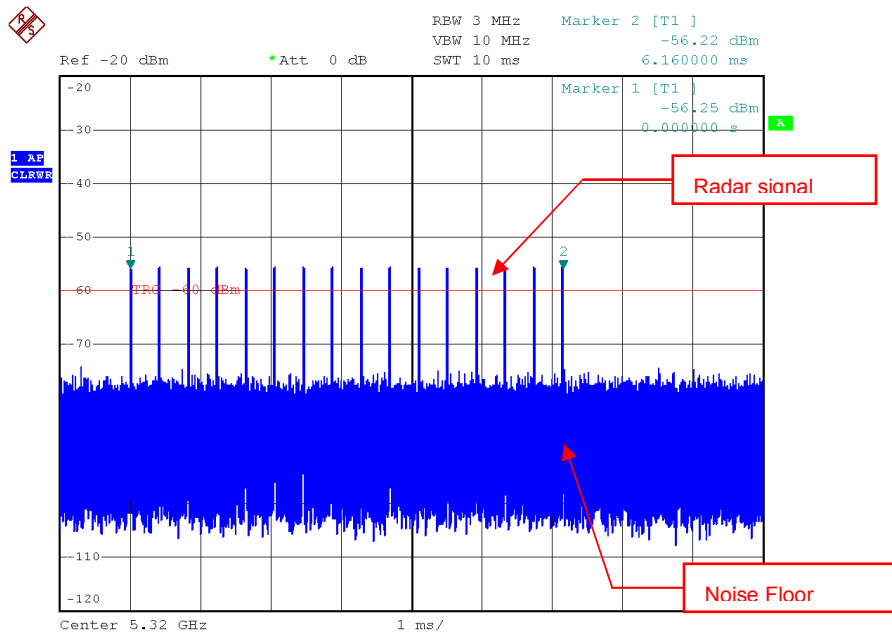

Date: 29.DEC.2006 12:32:03

Radar Signal 4

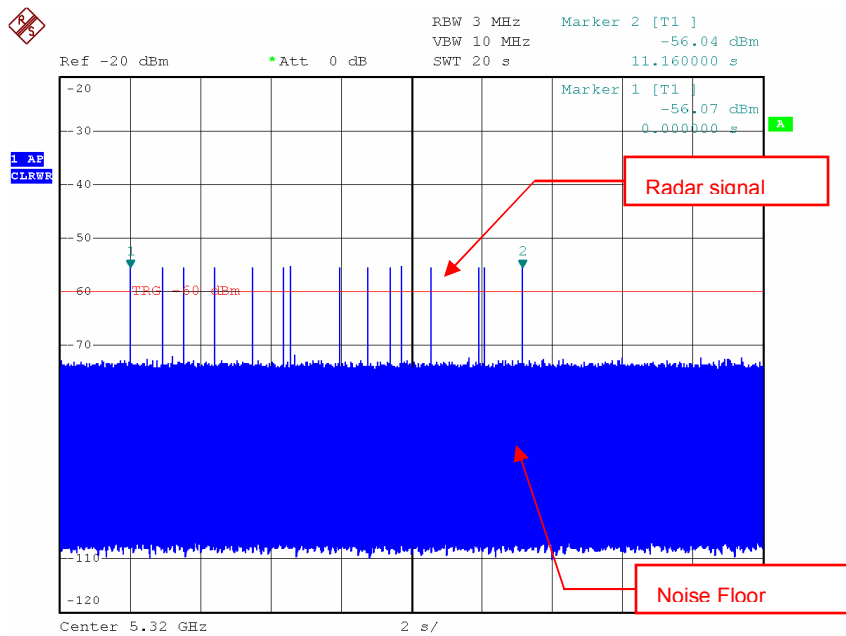

Date: 29.DEC.2006 12:35:47

Radar Signal 5

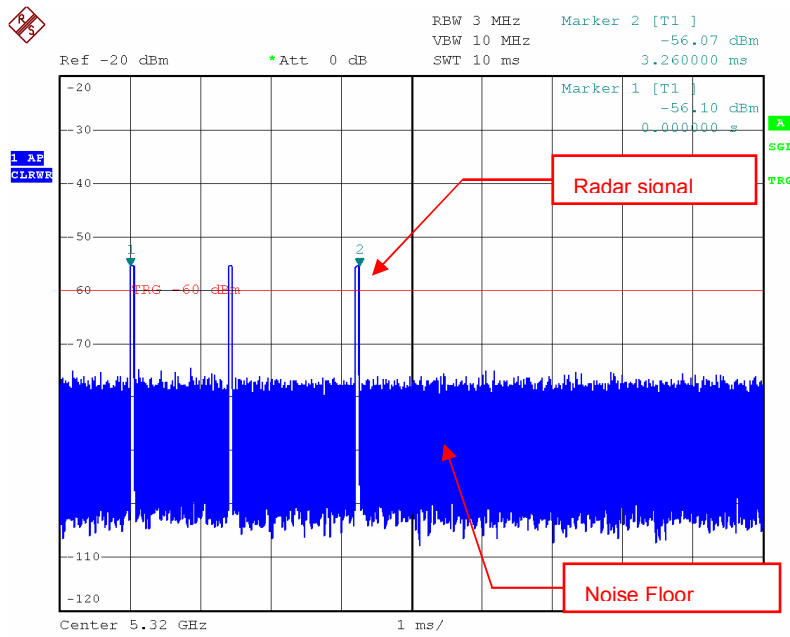

Date: 29.DEC.2006 13:06:43

Single Burst of Radar Signal 5

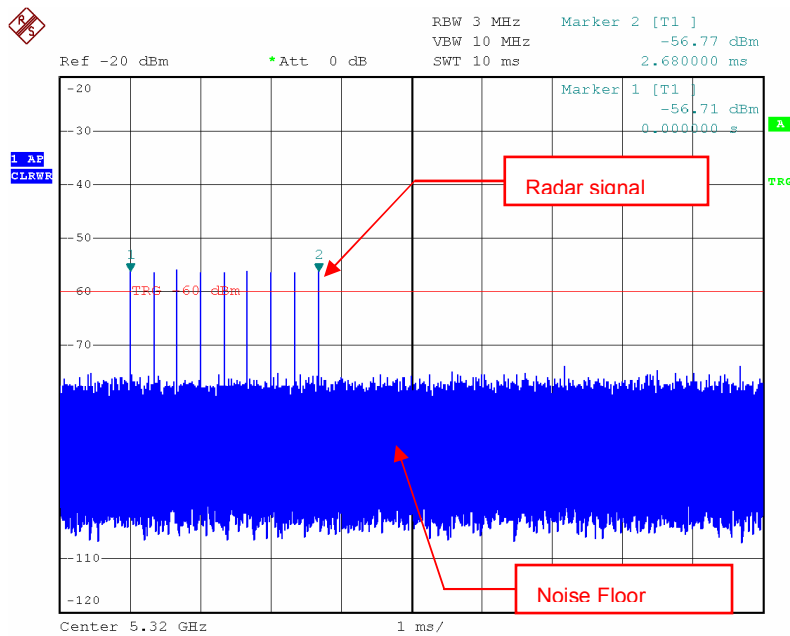

Date: 29.DEC.2006 12:48:41

Radar Signal 6

5.2.1.2 CHANNEL AVAILABILITY CHECK TIME

Initial Channel Availability Check Time

Channel Availability Check @ CH064 - 5320MHz

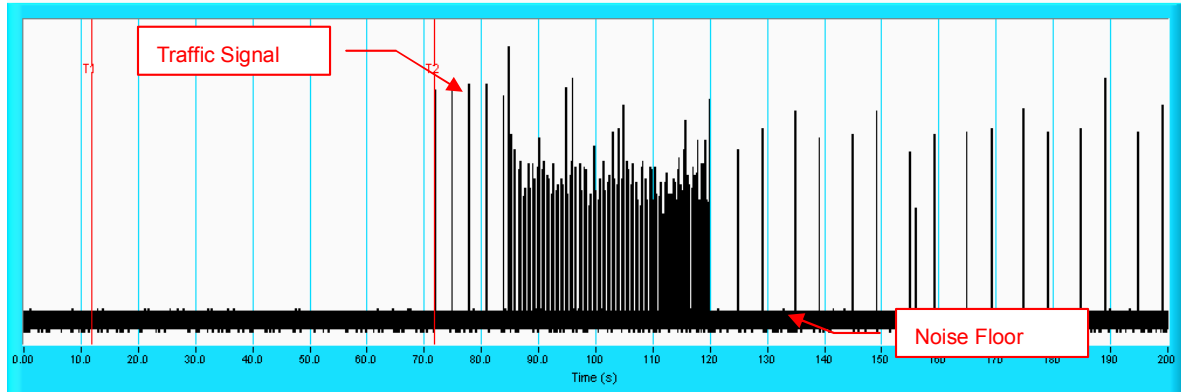

NOTE: T1 denotes the end of power-up time period is 12th second. T2 denotes the end of Channel Availability Check time is 72th second. Channel Availability Check time is equal to (T2 – T1) 60 seconds.

Radar Burst at the Beginning of the Channel Availability Check Time

Channel Availability Check @ CH064 - 5320MHz

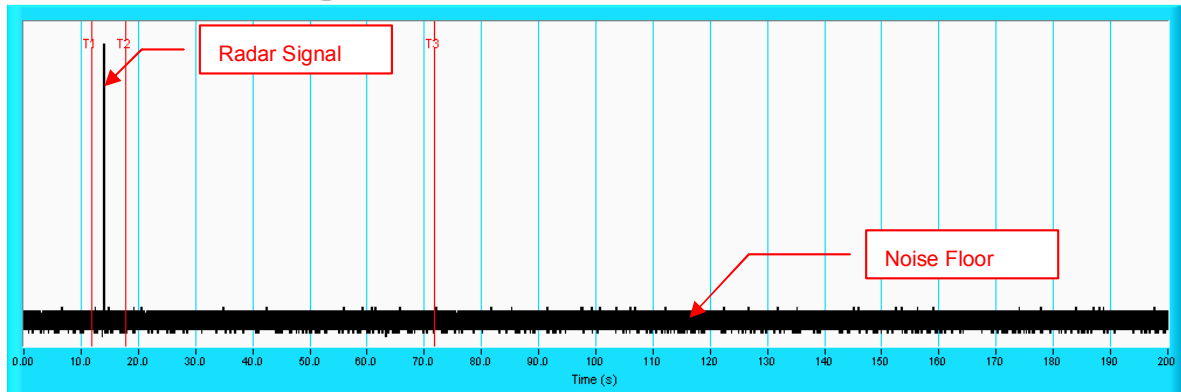

NOTE: T1 denotes the end of power up time period is 12th second. T2 denotes the radar burst was commenced within a 6 second window starting from the end of power-up sequence. T3 denotes the 72th second.

Radar Burst at the End of the Channel Availability Check Time Channel Availability Check @ CH064 - 5320MHz

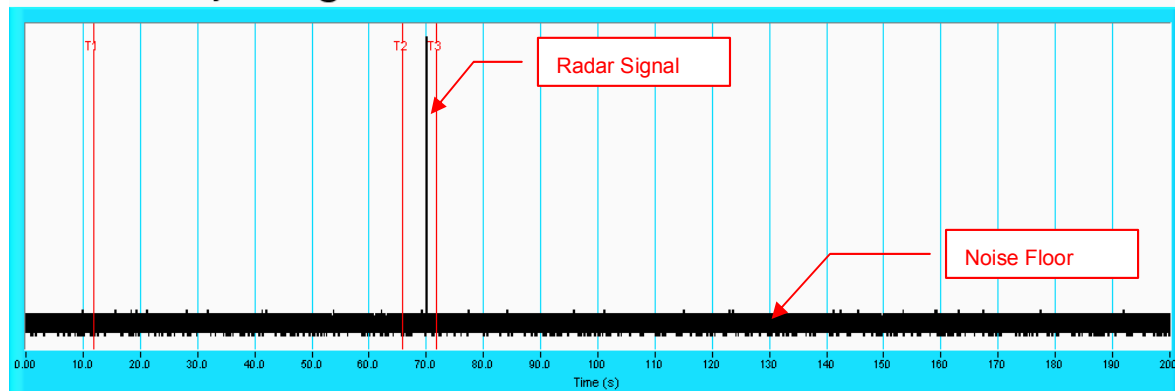

NOTE: T1 denotes the end of power up time period is 12th second. T2 denotes 66th second and T3 denotes the 72th second. The radar burst was commenced within 54th second to 60th second window starting from the end of power-up sequence.

5.2.1.3 CHANNEL CLOSING TRANSMISSION AND CHANNEL MOVE TIME

Table 1: Short Pulse Radar Test Waveforms.

Radar Type	Pulse Width (µsec)	PRI (µsec)	Number of Pulses	Number of Trials(Times)	Percentage of Successful Detection (%)
1	1	1428	18	30	93.3
2	1-5	150-230	23-29	30	90
3	6-10	200-500	16-18	30	96.7
4	11-20	200-500	12-16	30	90
Aggregate (Radar Types 1-4)				120	92.5

Table 2: Long Pulse Radar Test Waveform

Radar Type	Pulse Width (µsec)	Chirp Width (MHz)	PRI (µsec)	Number of Pulses per Burst	Number of Bursts	Number of Trials(Times)	Percentage of Successful Detection (%)
5	50-100	5-20	1000-2000	1-3	8-20	30	100

Table 3: Frequency Hopping Radar Test Waveform

Radar Type	Pulse Width (µsec)	PRI (µsec)	Pulses per Hop	Hopping Rate (kHz)	Hopping Sequence Length (msec)	Number of Trials(Times)	Percentage of Successful Detection (%)
6	1	333	9	0.333	300	30	90

Radar signal 1

Channel Closing Transmission Time & Channel Move Time @ CH052 - 5260MHz

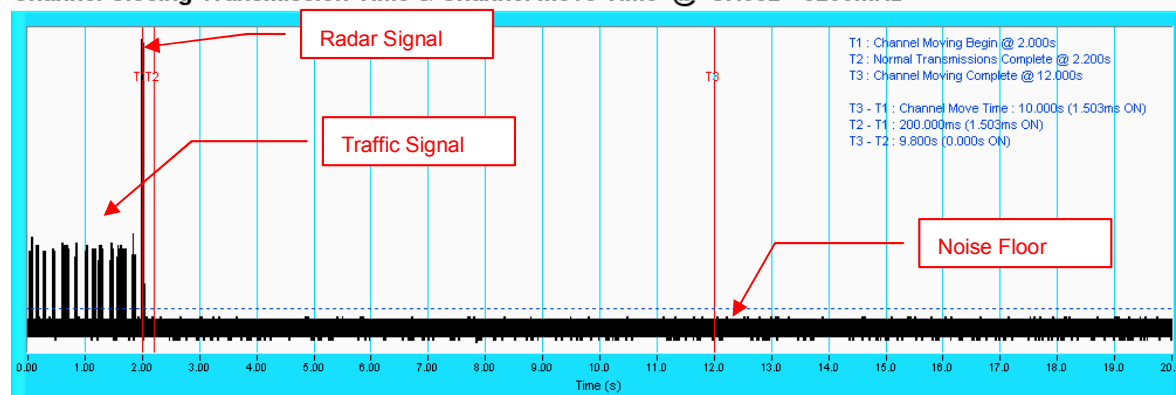

NOTE: T1 denotes the start of Channel Move Time upon the end of the last Radar burst. T2 denotes the data transmission time of 200ms from T1. T3 denotes the 10 second from T1 to observe the aggregate duration of transmissions.

Channel Closing Transmission Time & Channel Move Time @ CH052 - 5260MHz

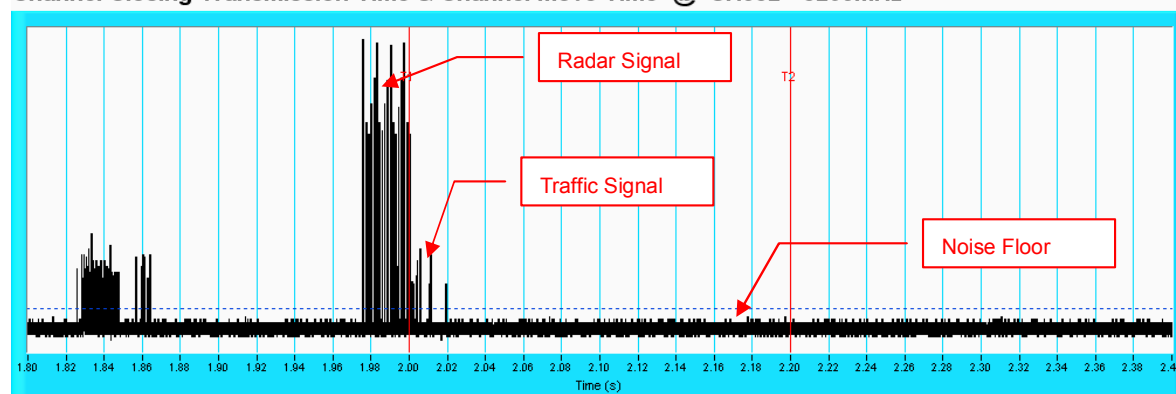

NOTE: An expanded plot for the device vacates the channel in the required 200ms.

Radar signal 2

Channel Closing Transmission Time & Channel Move Time @ CH112 - 5560MHz

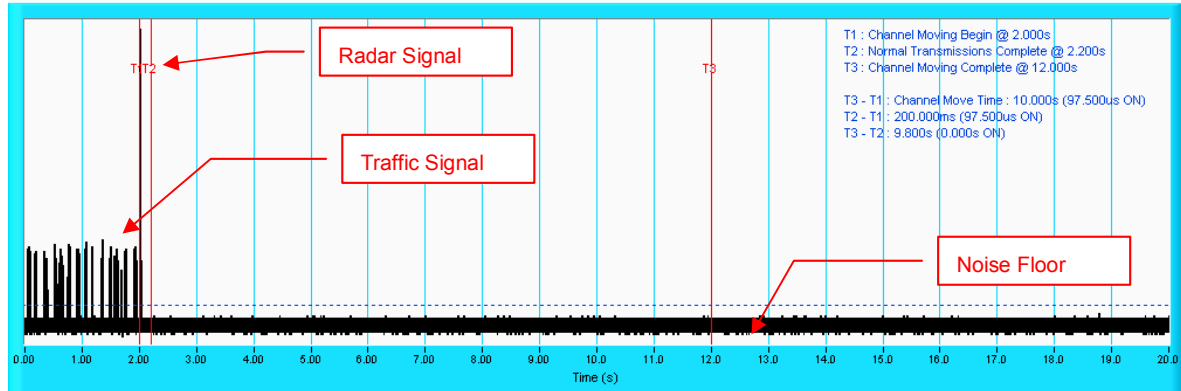

NOTE: T1 denotes the start of Channel Move Time upon the end of the last Radar burst. T2 denotes the data transmission time of 200ms from T1. T3 denotes the 10 second from T1 to observe the aggregate duration of transmissions.

Channel Closing Transmission Time & Channel Move Time @ CH112 - 5560MHz

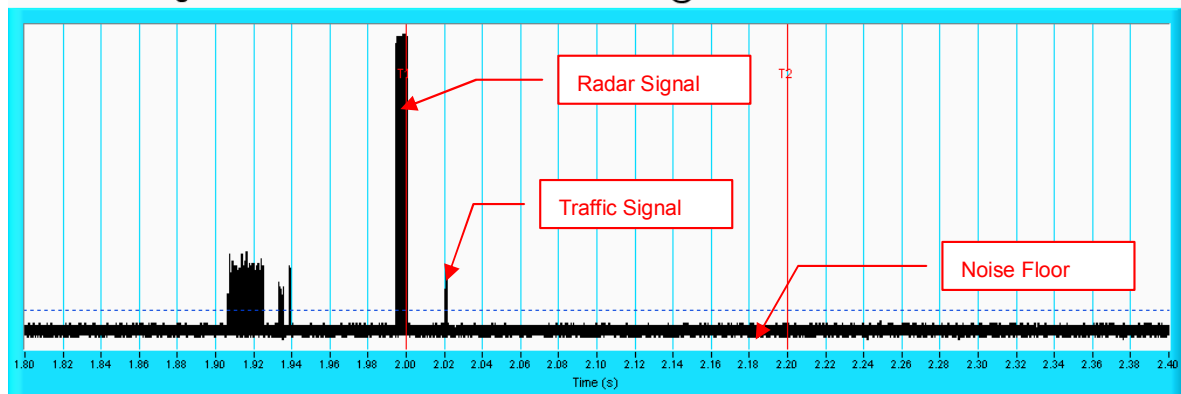

NOTE: An expanded plot for the device vacates the channel in the required 200ms.

Radar signal 3

Channel Closing Transmission Time & Channel Move Time @ CH128 - 5640MHz

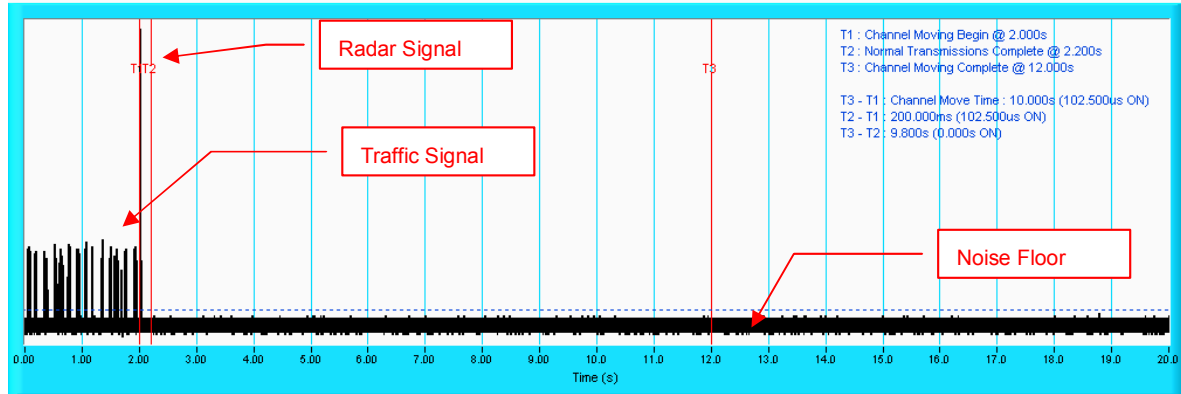

NOTE: T1 denotes the start of Channel Move Time upon the end of the last Radar burst. T2 denotes the data transmission time of 200ms from T1. T3 denotes the 10 second from T1 to observe the aggregate duration of transmissions.

Channel Closing Transmission Time & Channel Move Time @ CH128 - 5640MHz

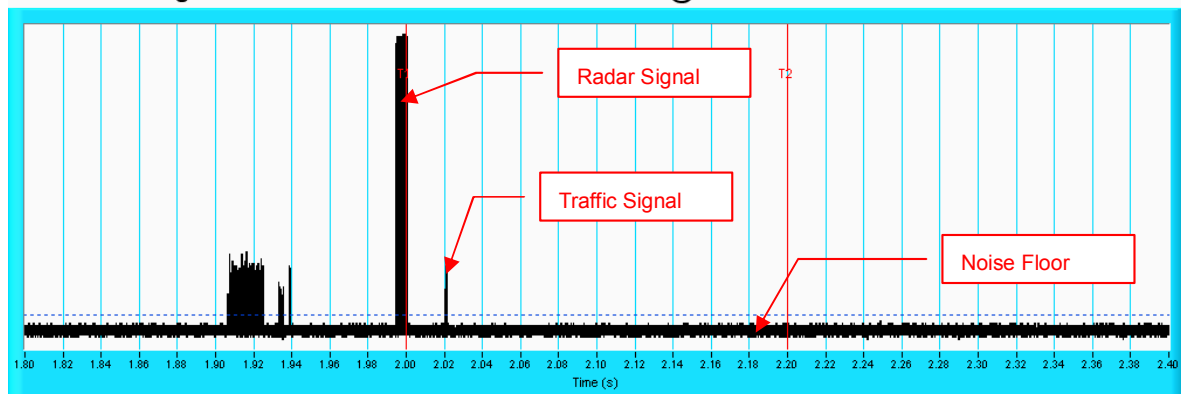

NOTE: An expanded plot for the device vacates the channel in the required 200ms.

Radar signal 4

Channel Closing Transmission Time & Channel Move Time @ CH116 - 5580MHz

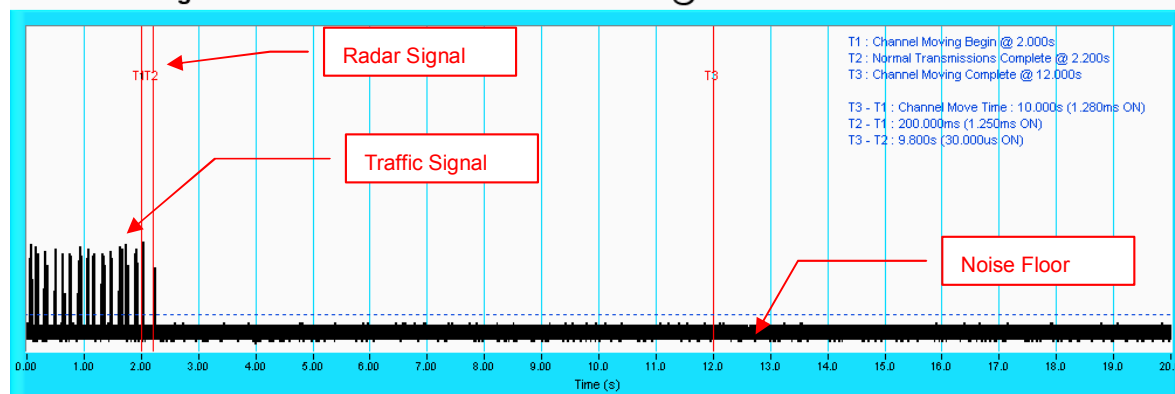

NOTE: T1 denotes the start of Channel Move Time upon the end of the last Radar burst. T2 denotes the data transmission time of 200ms from T1. T3 denotes the 10 second from T1 to observe the aggregate duration of transmissions.

Channel Closing Transmission Time & Channel Move Time @ CH116 - 5580MHz

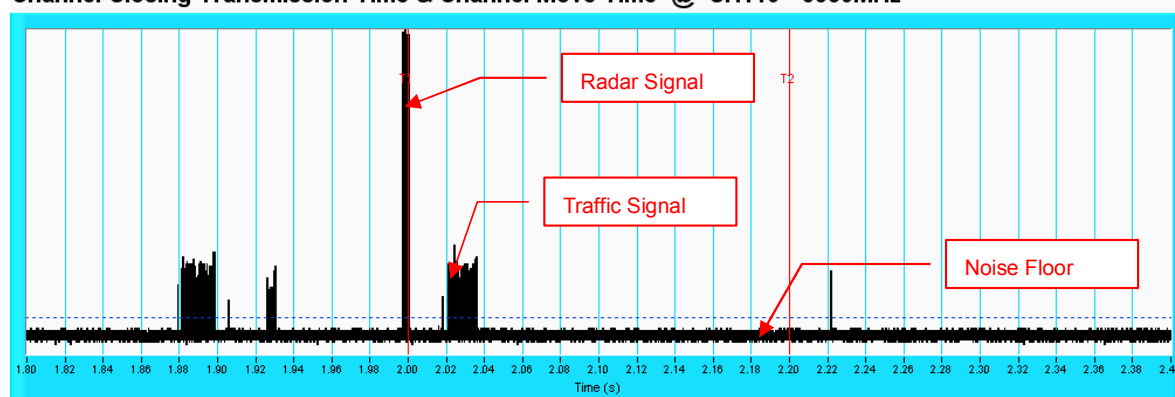

NOTE: An expanded plot for the device vacates the channel in the required 200ms.

Radar signal 5

Channel Closing Transmission Time & Channel Move Time @ CH132 - 5660MHz

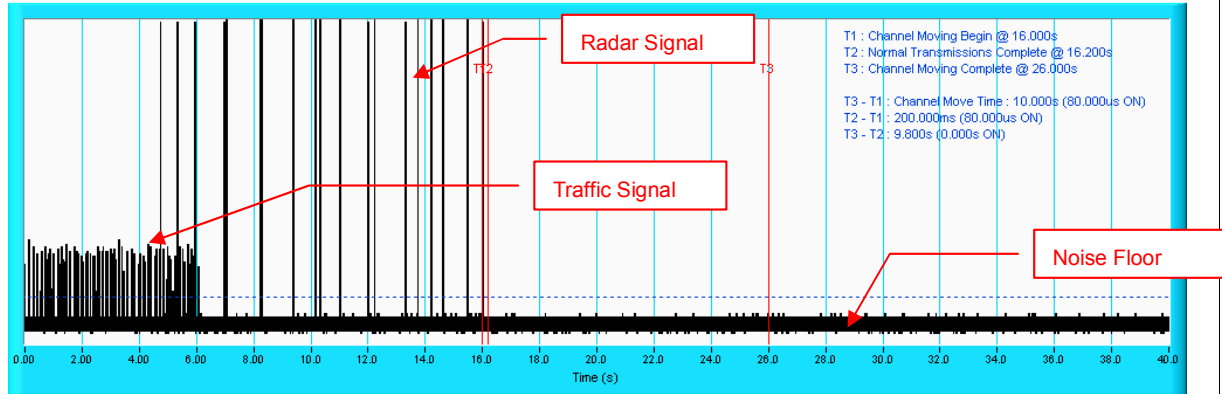

NOTE: T1 denotes the start of Channel Move Time upon the end of the last Radar burst. T2 denotes the data transmission time of 200ms from T1. T3 denotes the 10 second from T1 to observe the aggregate duration of transmissions.

Radar signal 6

Channel Closing Transmission Time & Channel Move Time @ CH120 - 5600MHz

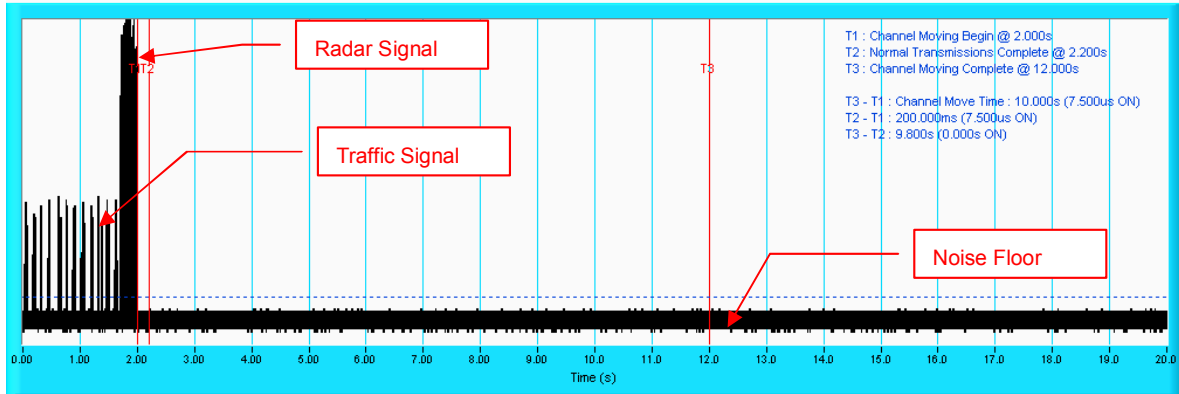

NOTE: T1 denotes the start of Channel Move Time upon the end of the last Radar burst. T2 denotes the data transmission time of 200ms from T1. T3 denotes the 10 second from T1 to observe the aggregate duration of transmissions.

Channel Closing Transmission Time & Channel Move Time @ CH120 - 5600MHz

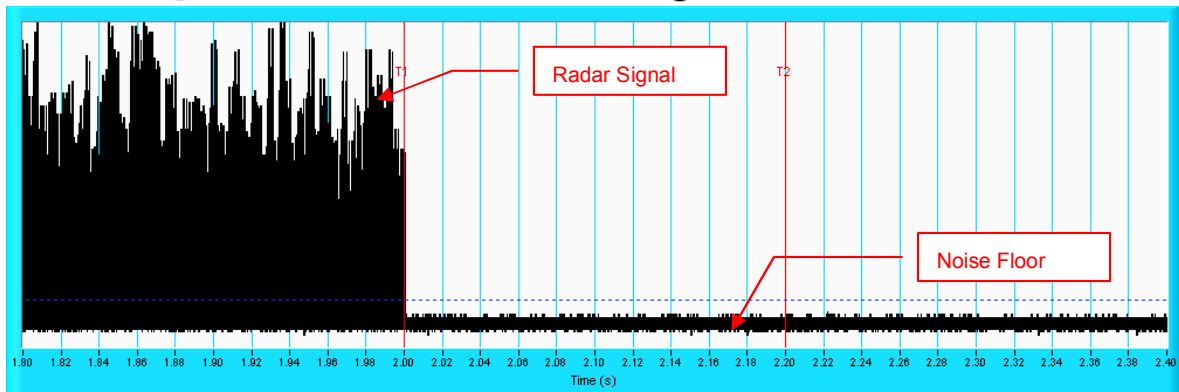

NOTE: An expanded plot for the device vacates the channel in the required 200ms.



Type 1 Radar Statistical Performances

Trial #	Pulses per Burst	Pulse Width (s)	PRI (s)	Detection
1	18	1.0u	1.428m	Yes
2	18	1.0u	1.428m	Yes
3	18	1.0u	1.428m	Yes
4	18	1.0u	1.428m	Yes
5	18	1.0u	1.428m	Yes
6	18	1.0u	1.428m	No
7	18	1.0u	1.428m	Yes
8	18	1.0u	1.428m	Yes
9	18	1.0u	1.428m	Yes
10	18	1.0u	1.428m	Yes
11	18	1.0u	1.428m	Yes
12	18	1.0u	1.428m	Yes
13	18	1.0u	1.428m	Yes
14	18	1.0u	1.428m	Yes
15	18	1.0u	1.428m	Yes
16	18	1.0u	1.428m	Yes
17	18	1.0u	1.428m	Yes
18	18	1.0u	1.428m	Yes
19	18	1.0u	1.428m	Yes
20	18	1.0u	1.428m	Yes
21	18	1.0u	1.428m	Yes
22	18	1.0u	1.428m	Yes
23	18	1.0u	1.428m	Yes
24	18	1.0u	1.428m	Yes
25	18	1.0u	1.428m	Yes
26	18	1.0u	1.428m	No
27	18	1.0u	1.428m	Yes
28	18	1.0u	1.428m	Yes
29	18	1.0u	1.428m	Yes
30	18	1.0u	1.428m	Yes

Detection Rate: 93.3 %



Type 2 Radar Statistical Performances				
Trial #	Pulses per Burst	Pulse Width (s)	PRI (s)	Detection
1	25	1.7u	207.0u	Yes
2	24	3.9u	168.0u	Yes
3	27	1.8u	173.0u	Yes
4	25	1.9u	224.0u	Yes
5	29	3.4u	194.0u	Yes
6	26	4.4u	183.0u	Yes
7	24	3.6u	212.0u	Yes
8	27	1.3u	222.0u	No
9	24	1.7u	170.0u	Yes
10	27	4.8u	212.0u	Yes
11	28	1.2u	185.0u	Yes
12	27	3.0u	190.0u	Yes
13	28	3.2u	225.0u	Yes
14	25	2.1u	197.0u	Yes
15	26	2.3u	160.0u	Yes
16	26	2.1u	158.0u	Yes
17	28	2.3u	214.0u	Yes
18	26	3.1u	165.0u	Yes
19	26	1.6u	195.0u	Yes
20	28	4.6u	187.0u	Yes
21	29	1.3u	223.0u	Yes
22	24	3.1u	171.0u	Yes
23	24	4.8u	169.0u	No
24	28	2.1u	197.0u	Yes
25	26	2.3u	174.0u	Yes
26	26	1.0u	157.0u	Yes
27	24	3.9u	184.0u	Yes
28	25	1.7u	209.0u	Yes
29	26	4.8u	185.0u	No
30	29	3.4u	204.0u	Yes
				Detection Rate: 90.0 %



Type 3 Radar Statistical Performances				
Trial #	Pulses per Burst	Pulse Width (s)	PRI (s)	Detection
1	18	6.9u	293.0u	Yes
2	17	8.9u	221.0u	Yes
3	17	7.2u	413.0u	Yes
4	17	6.3u	221.0u	Yes
5	17	9.9u	341.0u	Yes
6	18	7.6u	378.0u	Yes
7	16	7.6u	339.0u	Yes
8	18	9.4u	396.0u	Yes
9	17	9.0u	378.0u	No
10	17	7.2u	310.0u	Yes
11	16	7.9u	397.0u	Yes
12	17	6.0u	224.0u	Yes
13	18	7.9u	406.0u	Yes
14	17	6.2u	325.0u	Yes
15	17	7.5u	443.0u	Yes
16	17	9.5u	221.0u	Yes
17	17	6.0u	253.0u	Yes
18	18	8.1u	285.0u	Yes
19	17	7.1u	438.0u	Yes
20	16	7.0u	285.0u	Yes
21	17	6.5u	225.0u	Yes
22	17	8.0u	418.0u	Yes
23	16	7.2u	399.0u	Yes
24	18	6.8u	243.0u	Yes
25	16	7.0u	461.0u	Yes
26	16	7.0u	466.0u	Yes
27	17	8.1u	267.0u	Yes
28	17	8.3u	226.0u	Yes
29	17	10.0u	410.0u	Yes
30	17	8.0u	442.0u	Yes
				Detection Rate: 96.7 %



Type 4 Radar Statistical Performances				
Trial #	Pulses per Burst	Pulse Width (s)	PRI (s)	Detection
1	15	18.9u	290.0u	Yes
2	14	16.7u	394.0u	Yes
3	15	12.5u	390.0u	Yes
4	13	11.2u	436.0u	Yes
5	15	13.3u	431.0u	Yes
6	14	12.1u	210.0u	Yes
7	15	18.2u	217.0u	Yes
8	15	11.7u	426.0u	Yes
9	12	15.7u	379.0u	Yes
10	15	15.8u	480.0u	No
11	14	19.4u	450.0u	Yes
12	14	17.1u	227.0u	Yes
13	14	16.2u	476.0u	Yes
14	13	14.8u	277.0u	Yes
15	15	12.6u	455.0u	Yes
16	12	19.2u	328.0u	Yes
17	15	14.4u	487.0u	Yes
18	15	17.8u	388.0u	Yes
19	13	18.9u	377.0u	No
20	12	16.1u	270.0u	Yes
21	13	15.1u	417.0u	Yes
22	15	12.7u	411.0u	Yes
23	16	11.3u	421.0u	Yes
24	13	15.0u	459.0u	Yes
25	13	19.3u	411.0u	Yes
26	12	17.6u	312.0u	Yes
27	15	11.5u	265.0u	Yes
28	13	12.5u	221.0u	No
29	13	13.9u	306.0u	Yes
30	15	15.6u	333.0u	Yes
				Detection Rate: 90.0 %

Type 5 Radar Statistical Performances		
Trial #	Test Signal Name	Detection
1	LP_Signal_01	Yes
2	LP_Signal_02	Yes
3	LP_Signal_03	Yes
4	LP_Signal_04	Yes
5	LP_Signal_05	Yes
6	LP_Signal_06	Yes
7	LP_Signal_07	Yes
8	LP_Signal_08	Yes
9	LP_Signal_09	Yes
10	LP_Signal_10	Yes
11	LP_Signal_11	Yes
12	LP_Signal_12	Yes
13	LP_Signal_13	Yes
14	LP_Signal_14	Yes
15	LP_Signal_15	Yes
16	LP_Signal_16	Yes
17	LP_Signal_17	Yes
18	LP_Signal_18	Yes
19	LP_Signal_19	Yes
20	LP_Signal_20	Yes
21	LP_Signal_21	Yes
22	LP_Signal_22	Yes
23	LP_Signal_23	Yes
24	LP_Signal_24	Yes
25	LP_Signal_25	Yes
26	LP_Signal_26	Yes
27	LP_Signal_27	Yes
28	LP_Signal_28	Yes
29	LP_Signal_29	Yes
30	LP_Signal_30	Yes
		Detection Rate: 100.0 %

The Long Pulse Radar pattern shown in Annex B.1



Type 6 Radar Statistical Performances				
Trial #	Pulses per Burst	Pulse Width (s)	PRI (s)	Detection
1	9	1.0u	333.0u	Yes
2	9	1.0u	333.0u	Yes
3	9	1.0u	333.0u	Yes
4	9	1.0u	333.0u	Yes
5	9	1.0u	333.0u	Yes
6	9	1.0u	333.0u	No
7	9	1.0u	333.0u	Yes
8	9	1.0u	333.0u	Yes
9	9	1.0u	333.0u	Yes
10	9	1.0u	333.0u	Yes
11	9	1.0u	333.0u	Yes
12	9	1.0u	333.0u	Yes
13	9	1.0u	333.0u	No
14	9	1.0u	333.0u	Yes
15	9	1.0u	333.0u	Yes
16	9	1.0u	333.0u	Yes
17	9	1.0u	333.0u	Yes
18	9	1.0u	333.0u	Yes
19	9	1.0u	333.0u	Yes
20	9	1.0u	333.0u	No
21	9	1.0u	333.0u	Yes
22	9	1.0u	333.0u	Yes
23	9	1.0u	333.0u	Yes
24	9	1.0u	333.0u	Yes
25	9	1.0u	333.0u	Yes
26	9	1.0u	333.0u	Yes
27	9	1.0u	333.0u	Yes
28	9	1.0u	333.0u	Yes
29	9	1.0u	333.0u	Yes
30	9	1.0u	333.0u	Yes
				Detection Rate: 90.0 %

Type 6 Radar Statistical Performances		
Trial #	Hopping Frequency Sequence Name	Detection
1	HOP_FREQ_SEQ_01	Yes
2	HOP_FREQ_SEQ_02	Yes
3	HOP_FREQ_SEQ_03	Yes
4	HOP_FREQ_SEQ_04	Yes
5	HOP_FREQ_SEQ_05	Yes
6	HOP_FREQ_SEQ_06	No
7	HOP_FREQ_SEQ_07	Yes
8	HOP_FREQ_SEQ_08	Yes
9	HOP_FREQ_SEQ_09	Yes
10	HOP_FREQ_SEQ_10	Yes
11	HOP_FREQ_SEQ_11	Yes
12	HOP_FREQ_SEQ_12	Yes
13	HOP_FREQ_SEQ_13	No
14	HOP_FREQ_SEQ_14	Yes
15	HOP_FREQ_SEQ_15	Yes
16	HOP_FREQ_SEQ_16	Yes
17	HOP_FREQ_SEQ_17	Yes
18	HOP_FREQ_SEQ_18	Yes
19	HOP_FREQ_SEQ_19	Yes
20	HOP_FREQ_SEQ_20	No
21	HOP_FREQ_SEQ_21	Yes
22	HOP_FREQ_SEQ_22	Yes
23	HOP_FREQ_SEQ_23	Yes
24	HOP_FREQ_SEQ_24	Yes
25	HOP_FREQ_SEQ_25	Yes
26	HOP_FREQ_SEQ_26	Yes
27	HOP_FREQ_SEQ_27	Yes
28	HOP_FREQ_SEQ_28	Yes
29	HOP_FREQ_SEQ_29	Yes
30	HOP_FREQ_SEQ_30	Yes
		Detection Rate: 90.0 %

The Frequency Hopping Radar pattern shown in Annex B.2

5.2.1.4 NON- OCCUPANCY PERIOD

During the 30 minutes observation time, UUT did not make any transmissions on a channel after a radar signal was detected on that channel by either the Channel Availability Check or the In-Service Monitoring.

Non - Occupancy Period @ CH064 - 5320MHz

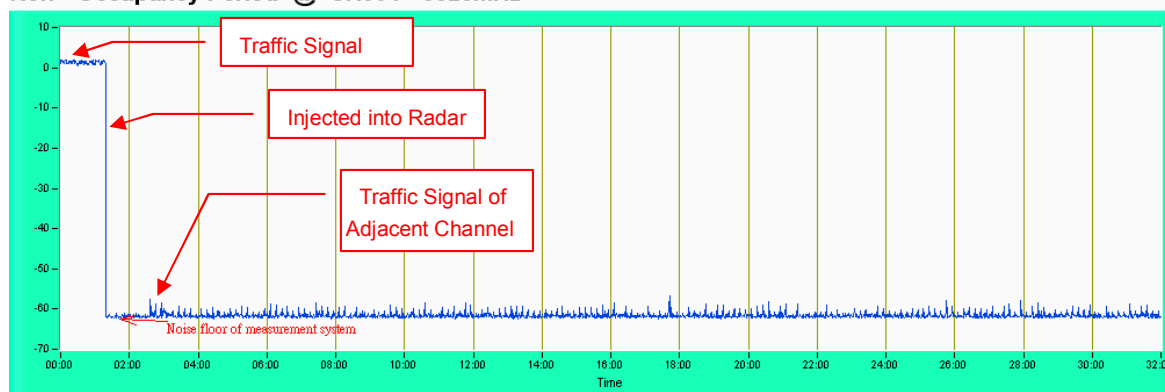

5.2.1.5 UNIFORM SPREADING

The intention of the uniform spreading is to provide, on aggregate, a uniform loading of the spectrum. The UUT using the bands 5150 to 5350MHz and 5470 to 5725 MHz shall select an operating channel out of the 19 channels, so that the probability of selecting a given channel shall be the same for all channels.

The UUT will select channel by random mode and remember this channel when detect radar signal, so that will select unused channel by random mode.

5.2.1.6 U-NII DETECTION BANDWIDTH

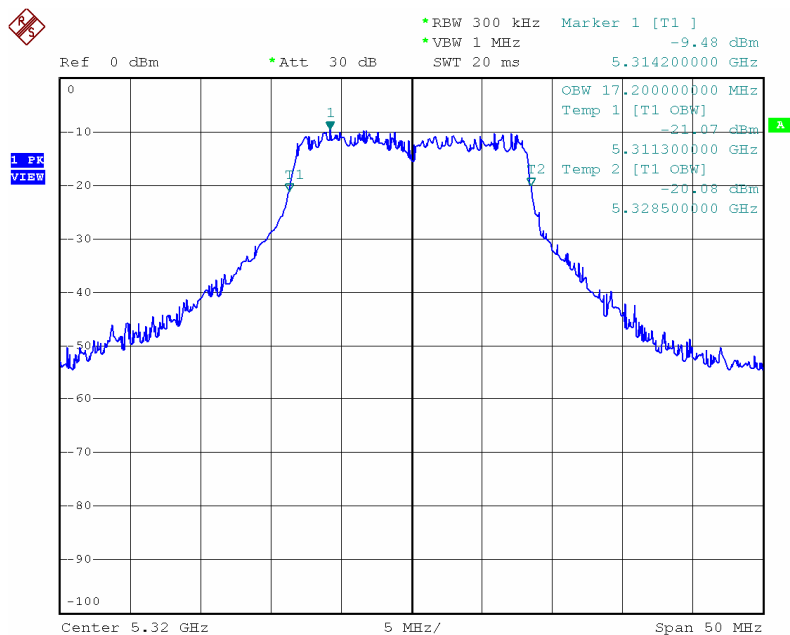

Date: 1.FEB.2007 15:48:03

U-NII 99% Channel bandwidth

Detection Bandwidth Test											
EUT Frequency: 5.320GHz											
EUT 99% Power bandwidth: 17.20MHz											
Detection bandwidth limit (80% of EUT 99% Power bandwidth): 13.76MHz											
Detection Bandwidth (FH - FL): 14.00MHz											
Test Result : PASS											
Radar	Trial Number / Detection										Detection Rate (%)
Frequency (Hz)	1	2	3	4	5	6	7	8	9	10	
5.310G	No	No	No	Yes	No	No	Yes	No	No	No	20
5.311G	Yes	Yes	Yes	Yes	Yes	Yes	No	Yes	Yes	Yes	90
5.312G	Yes	Yes	Yes	Yes	Yes	Yes	Yes	Yes	Yes	Yes	100
5.313G (FL)	Yes	Yes	Yes	Yes	Yes	Yes	Yes	Yes	Yes	Yes	100
5.314G	Yes	Yes	Yes	Yes	Yes	Yes	Yes	Yes	Yes	Yes	100
5.315G	Yes	Yes	Yes	Yes	Yes	Yes	Yes	Yes	Yes	Yes	100
5.316G	Yes	Yes	Yes	Yes	Yes	Yes	Yes	Yes	Yes	Yes	100
5.317G	Yes	Yes	Yes	Yes	Yes	Yes	Yes	Yes	Yes	Yes	100
5.318G	Yes	Yes	Yes	Yes	Yes	Yes	Yes	Yes	Yes	Yes	100
5.319G	Yes	Yes	Yes	Yes	Yes	Yes	Yes	Yes	Yes	Yes	100
5.320G	Yes	Yes	Yes	Yes	Yes	Yes	Yes	Yes	Yes	Yes	100
5.321G	Yes	Yes	Yes	Yes	Yes	Yes	Yes	Yes	Yes	Yes	100
5.322G	Yes	Yes	Yes	Yes	Yes	Yes	Yes	Yes	Yes	Yes	100
5.323G	Yes	Yes	Yes	Yes	Yes	Yes	Yes	Yes	Yes	Yes	100
5.324G	Yes	Yes	Yes	Yes	Yes	Yes	Yes	Yes	Yes	Yes	100
5.325G	Yes	Yes	Yes	Yes	Yes	Yes	Yes	Yes	Yes	Yes	100
5.326G	Yes	Yes	Yes	Yes	Yes	Yes	Yes	Yes	Yes	Yes	100
5.327G (FH)	Yes	Yes	Yes	Yes	Yes	Yes	Yes	Yes	Yes	Yes	100
5.328G	Yes	Yes	Yes	Yes	Yes	Yes	Yes	Yes	Yes	Yes	100
5.329G	Yes	Yes	Yes	Yes	Yes	Yes	Yes	Yes	Yes	Yes	100
5.330G	No	Yes	No	No	No	No	No	No	No	No	10

5.2.2 THE UUT IS A U-NII DEVICE OPERATING IN CLIENT WITH RADAR DETECTION MODE.

Client with injection at the Master (Radar Test Waveforms are injected into the Master.)

5.2.2.1 DFS DETECTION THRESHOLD

For a detection threshold level of -64dBm and the Master antenna gain is 8dBi . The Required detection threshold is -55dBm ($= -64 + 1 + 8\text{dBm}$). The conducted radar burst level is set to -56dBm . The tested level is lower than required level hence it provides margin to the limit.

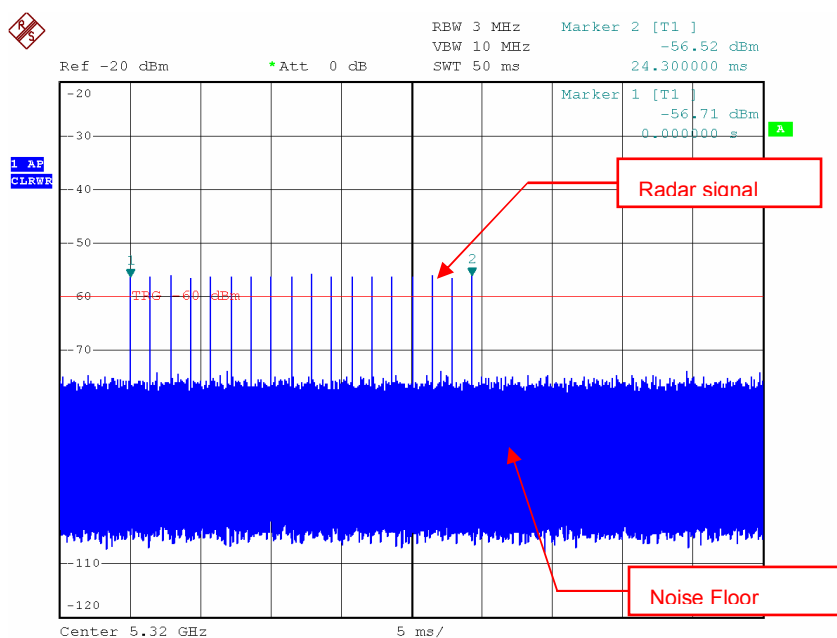

Date: 29.DEC.2006 12:29:41

Radar Signal 1

5.2.2.2 CHANNEL CLOSING TRANSMISSION AND CHANNEL MOVE TIME

Table 1: Short Pulse Radar Test Waveforms.

Radar Type	Pulse Width (μsec)	PRI (μsec)	Number of Pulses	Number of Trials(Times)	Percentage of Successful Detection (%)
1	1	1428	18	30	100

Radar signal 1

Channel Closing Transmission Time & Channel Move Time @ CH064 - 5320MHz

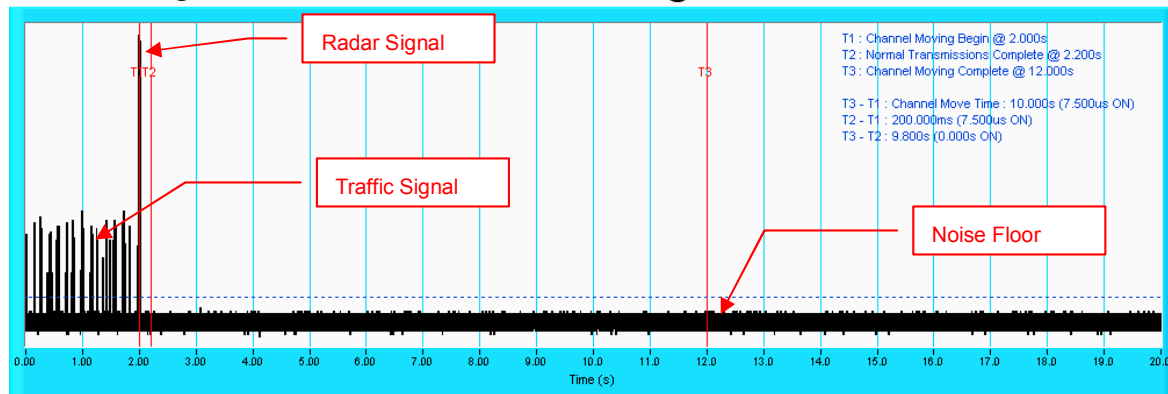

NOTE: T1 denotes the start of Channel Move Time upon the end of the last Radar burst. T2 denotes the data transmission time of 200ms from T1. T3 denotes the 10 second from T1 to observe the aggregate duration of transmissions.

Channel Closing Transmission Time & Channel Move Time @ CH064 - 5320MHz

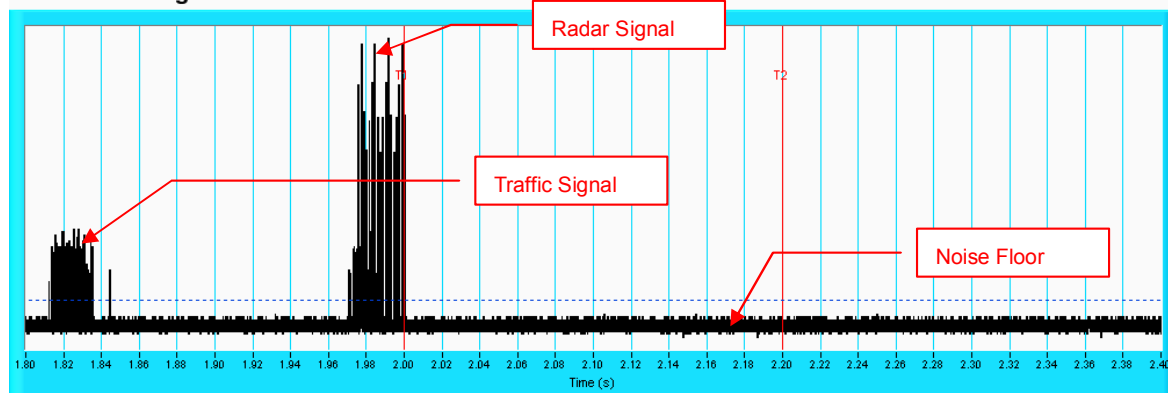

NOTE: An expanded plot for the device vacates the channel in the required 200ms.



Type 1 Radar Statistical Performances				
Trial #	Pulses per Burst	Pulse Width (s)	PRI (s)	Detection
1	18	1.0u	1.428m	Yes
2	18	1.0u	1.428m	Yes
3	18	1.0u	1.428m	Yes
4	18	1.0u	1.428m	Yes
5	18	1.0u	1.428m	Yes
6	18	1.0u	1.428m	Yes
7	18	1.0u	1.428m	Yes
8	18	1.0u	1.428m	Yes
9	18	1.0u	1.428m	Yes
10	18	1.0u	1.428m	Yes
11	18	1.0u	1.428m	Yes
12	18	1.0u	1.428m	Yes
13	18	1.0u	1.428m	Yes
14	18	1.0u	1.428m	Yes
15	18	1.0u	1.428m	Yes
16	18	1.0u	1.428m	Yes
17	18	1.0u	1.428m	Yes
18	18	1.0u	1.428m	Yes
19	18	1.0u	1.428m	Yes
20	18	1.0u	1.428m	Yes
21	18	1.0u	1.428m	Yes
22	18	1.0u	1.428m	Yes
23	18	1.0u	1.428m	Yes
24	18	1.0u	1.428m	Yes
25	18	1.0u	1.428m	Yes
26	18	1.0u	1.428m	Yes
27	18	1.0u	1.428m	Yes
28	18	1.0u	1.428m	Yes
29	18	1.0u	1.428m	Yes
30	18	1.0u	1.428m	Yes
				Detection Rate: 100 %

5.2.3 THE UUT IS A U-NII DEVICE OPERATING IN CLIENT WITH RADAR DETECTION MODE.

Client with injection at the Client. (Radar Test Waveforms are injected into the Client.)

5.2.3.1 DFS DETECTION THRESHOLD

For a detection threshold level of -64dBm and the Master antenna gain is 8dBi . The Required detection threshold is -55dBm ($= -64 + 1 + 8$) dBm . The conducted radar burst level is set to -56dBm . The tested level is lower than required level hence it provides margin to the limit.

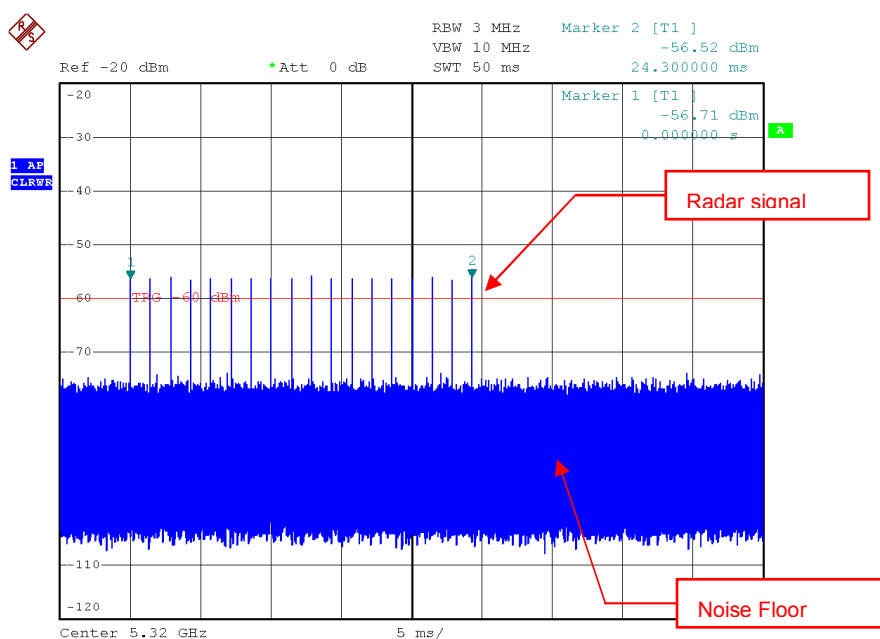

Date: 29.DEC.2006 12:29:41

Radar Signal 1

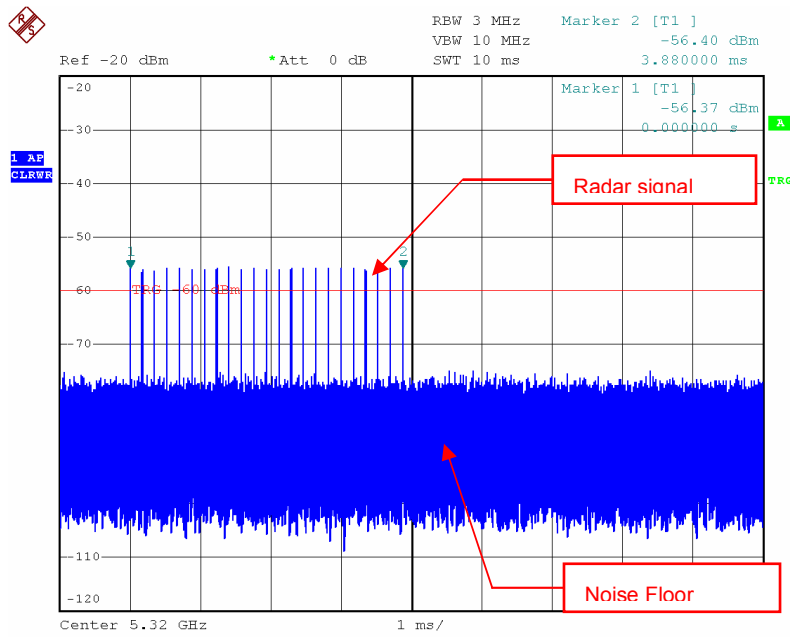

Date: 29.DEC.2006 12:30:34

Radar Signal 2

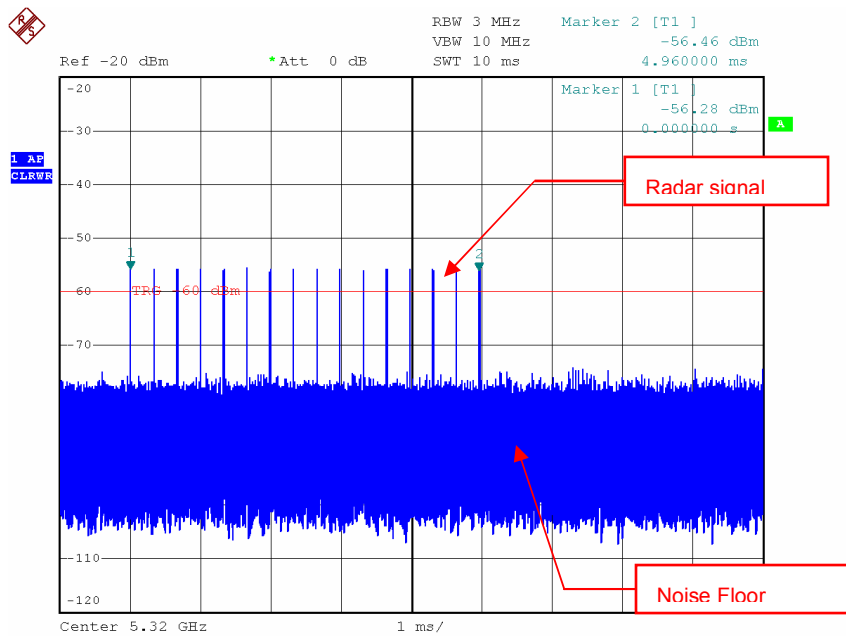

Date: 29.DEC.2006 12:31:27

Radar Signal 3

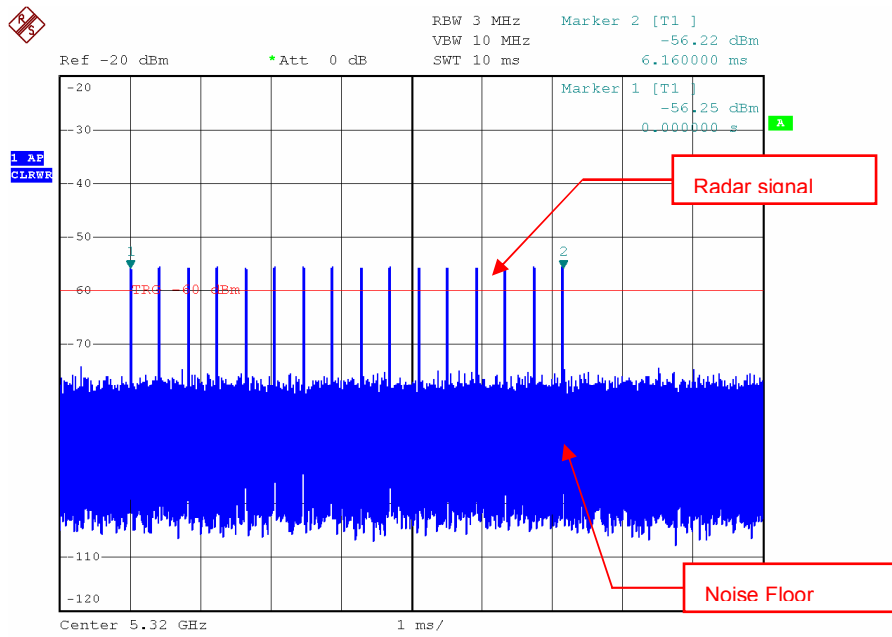

Date: 29.DEC.2006 12:32:03

Radar Signal 4

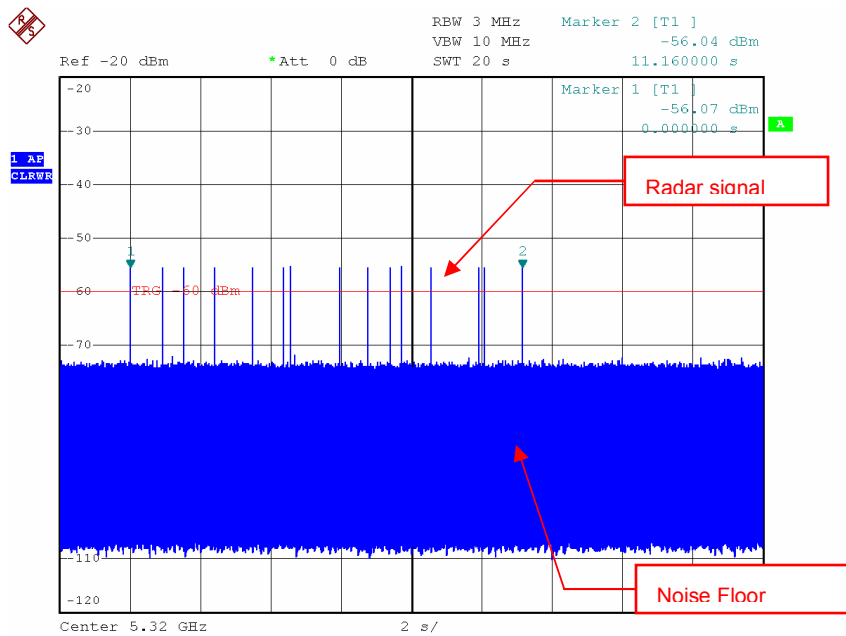

Date: 29.DEC.2006 12:35:47

Radar Signal 5

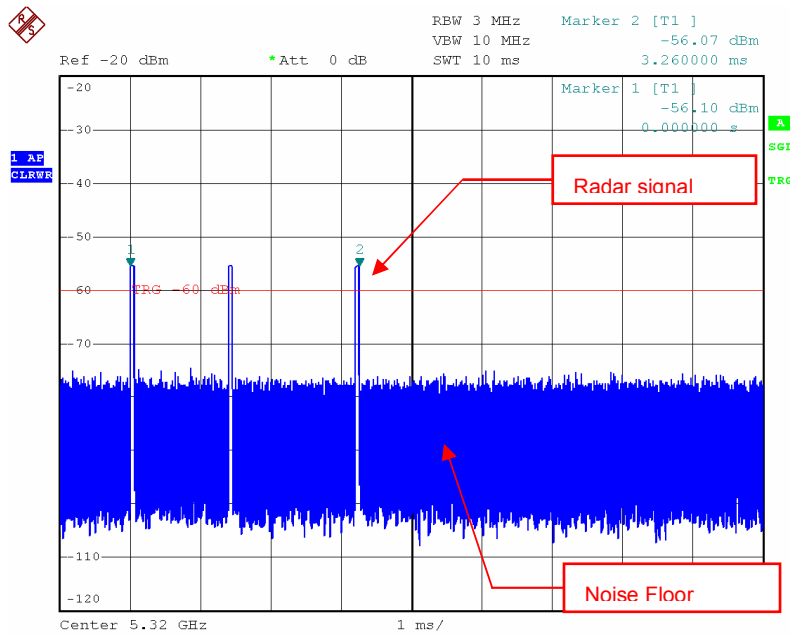

Date: 29.DEC.2006 13:06:43

Single Burst of Radar Signal 5

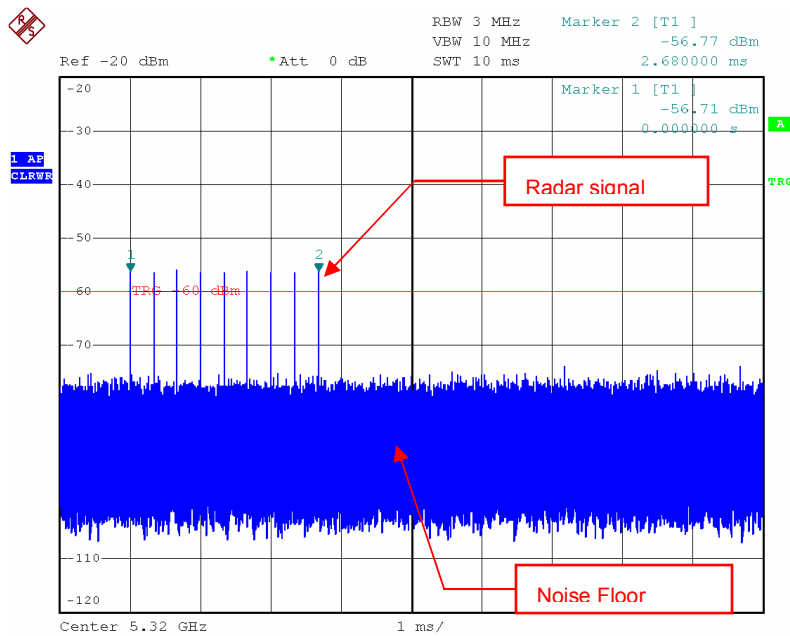

Date: 29.DEC.2006 12:48:41

Radar Signal 6

5.2.3.2 CHANNEL CLOSING TRANSMISSION AND CHANNEL MOVE TIME

Table 1: Short Pulse Radar Test Waveforms.

Radar Type	Pulse Width (μsec)	PRI (μsec)	Number of Pulses	Number of Trials(Times)	Percentage of Successful Detection (%)
1	1	1428	18	30	100
2	1-5	150-230	23-29	30	93.3
3	6-10	200-500	16-18	30	90
4	11-20	200-500	12-16	30	80
Aggregate (Radar Types 1-4)				120	90.8

Table 2: Long Pulse Radar Test Waveform

Radar Type	Pulse Width (μsec)	Chirp Width (MHz)	PRI (μsec)	Number of Pulses per Burst	Number of Bursts	Number of Trials(Times)	Percentage of Successful Detection (%)
5	50-100	5-20	1000-2000	1-3	8-20	30	96.7

Table 3: Frequency Hopping Radar Test Waveform

Radar Type	Pulse Width (μsec)	PRI (μsec)	Pulses per Hop	Hopping Rate (kHz)	Hopping Sequence Length (msec)	Number of Trials(Times)	Percentage of Successful Detection (%)
6	1	333	9	0.333	300	30	86.7

Radar signal 1

Channel Closing Transmission Time & Channel Move Time @ CH064 - 5320MHz

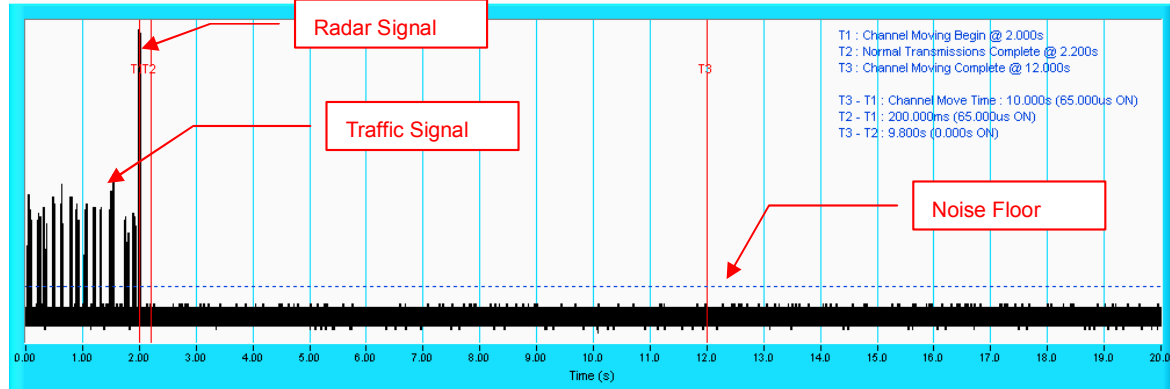

NOTE: T1 denotes the start of Channel Move Time upon the end of the last Radar burst. T2 denotes the data transmission time of 200ms from T1. T3 denotes the 10 second from T1 to observe the aggregate duration of transmissions.

Channel Closing Transmission Time & Channel Move Time @ CH064 - 5320MHz

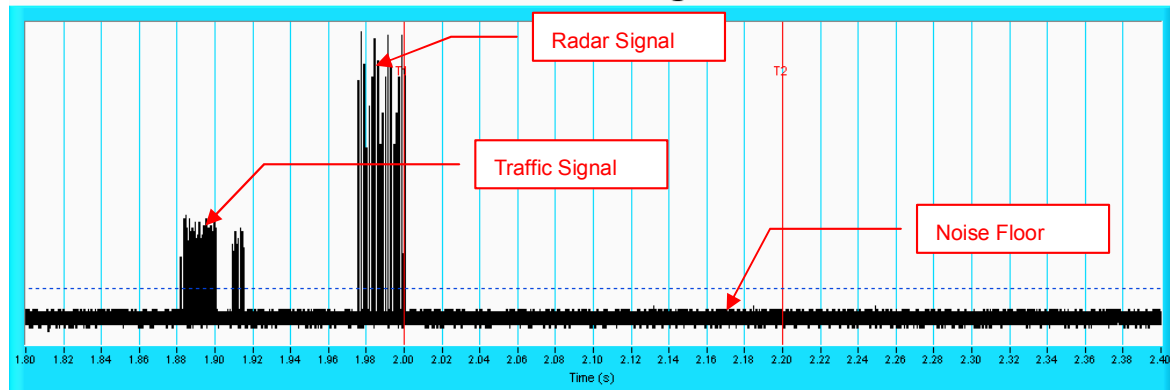

NOTE: An expanded plot for the device vacates the channel in the required 200ms.

Radar signal 2

Channel Closing Transmission Time & Channel Move Time @ CH064 - 5320MHz

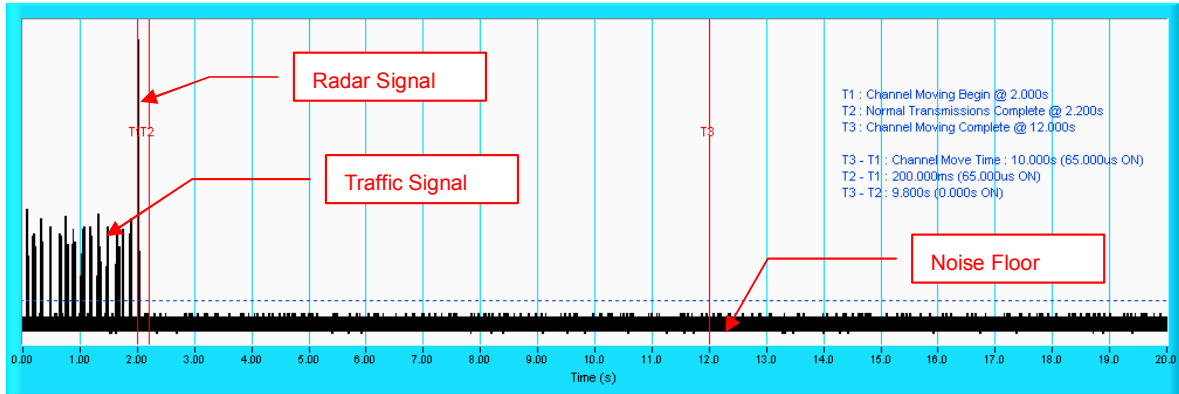

NOTE: T1 denotes the start of Channel Move Time upon the end of the last Radar burst. T2 denotes the data transmission time of 200ms from T1. T3 denotes the 10 second from T1 to observe the aggregate duration of transmissions.

Channel Closing Transmission Time & Channel Move Time @ CH064 - 5320MHz

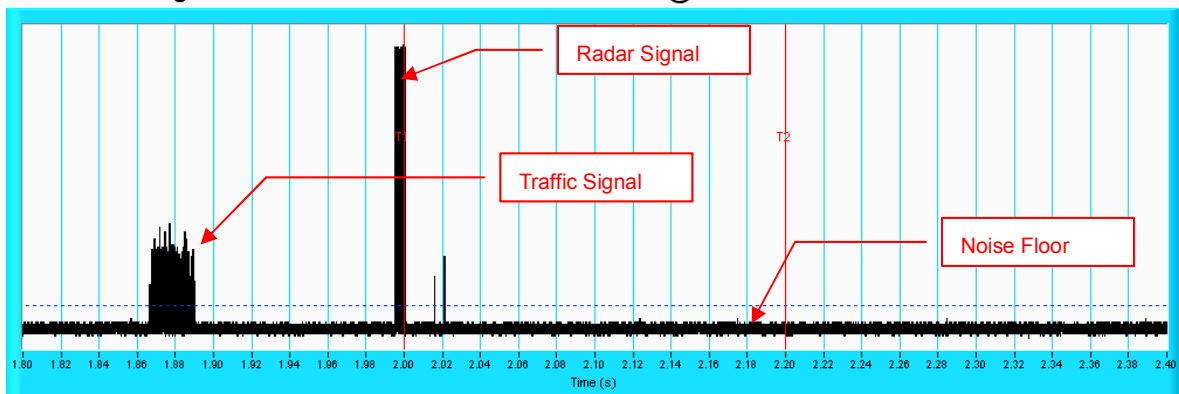

NOTE: An expanded plot for the device vacates the channel in the required 200ms.

Radar signal 3

Channel Closing Transmission Time & Channel Move Time @ CH064 - 5320MHz

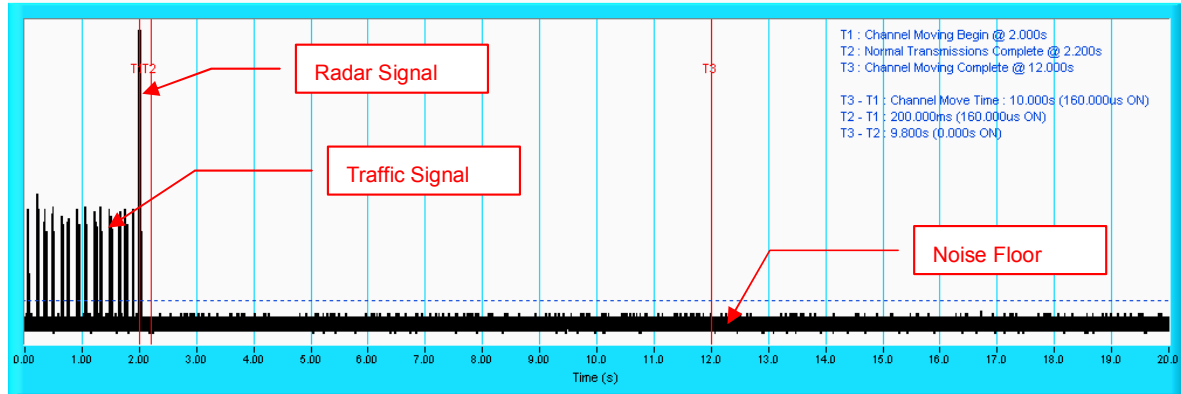

NOTE: T1 denotes the start of Channel Move Time upon the end of the last Radar burst. T2 denotes the data transmission time of 200ms from T1. T3 denotes the 10 second from T1 to observe the aggregate duration of transmissions.

Channel Closing Transmission Time & Channel Move Time @ CH064 - 5320MHz

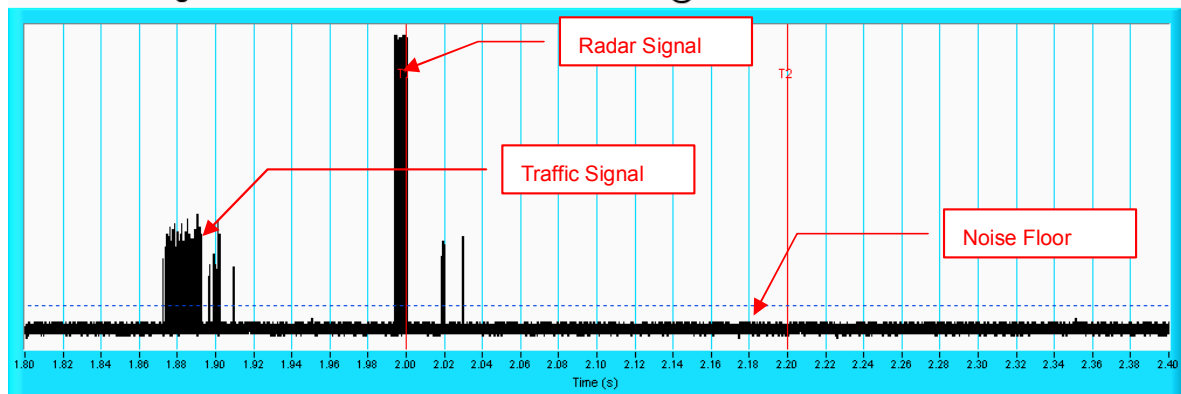

NOTE: An expanded plot for the device vacates the channel in the required 200ms.

Radar signal 4

Channel Closing Transmission Time & Channel Move Time @ CH064 - 5320MHz

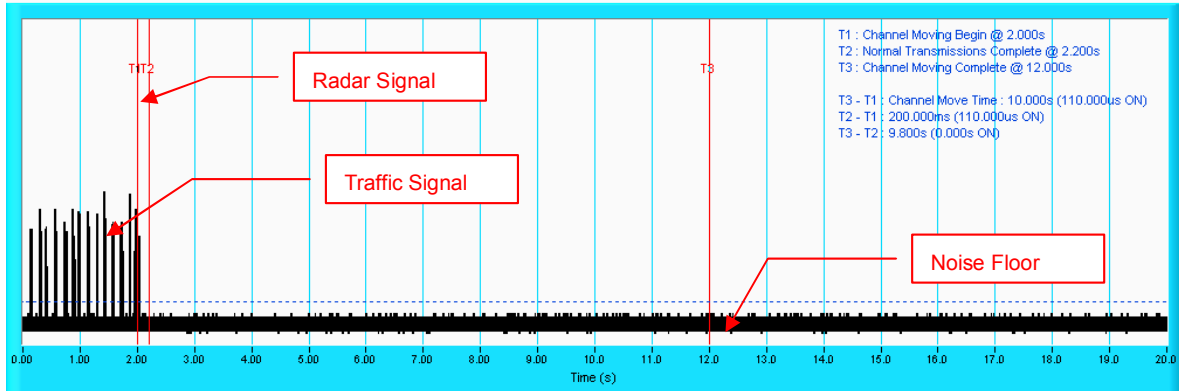

NOTE: T1 denotes the start of Channel Move Time upon the end of the last Radar burst. T2 denotes the data transmission time of 200ms from T1. T3 denotes the 10 second from T1 to observe the aggregate duration of transmissions.

Channel Closing Transmission Time & Channel Move Time @ CH064 - 5320MHz

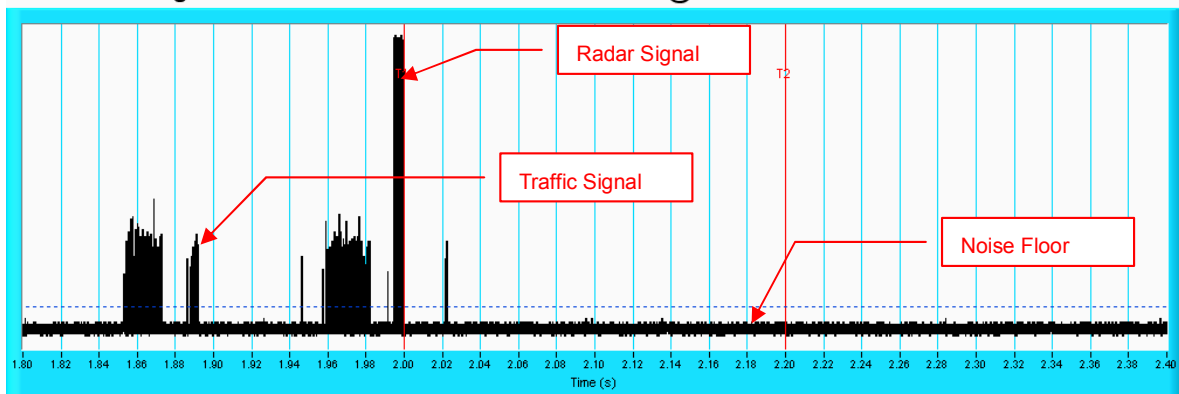

NOTE: An expanded plot for the device vacates the channel in the required 200ms.

Radar signal 5

Channel Closing Transmission Time & Channel Move Time @ CH064 - 5320MHz

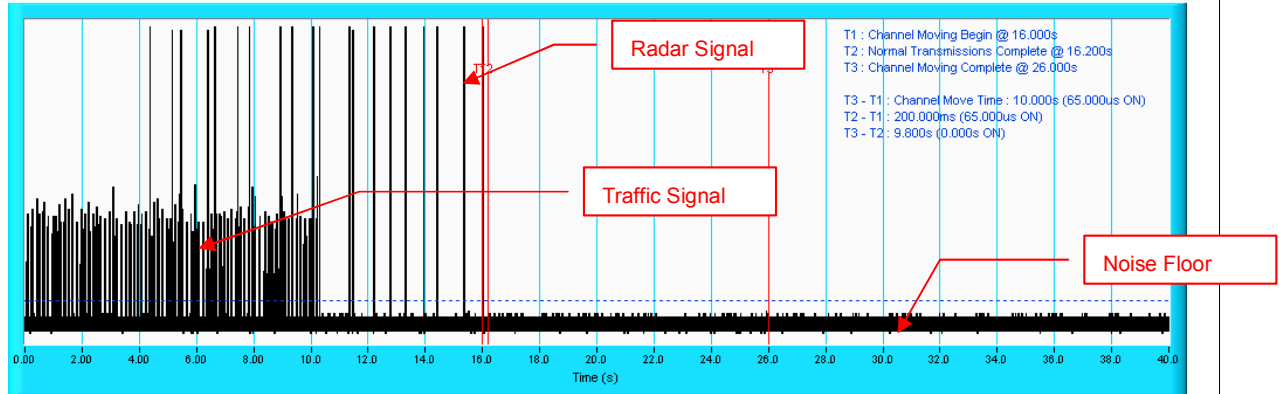

NOTE: T1 denotes the start of Channel Move Time upon the end of the last Radar burst. T2 denotes the data transmission time of 200ms from T1. T3 denotes the 10 second from T1 to observe the aggregate duration of transmissions.

Radar signal 6

Channel Closing Transmission Time & Channel Move Time @ CH064 - 5320MHz

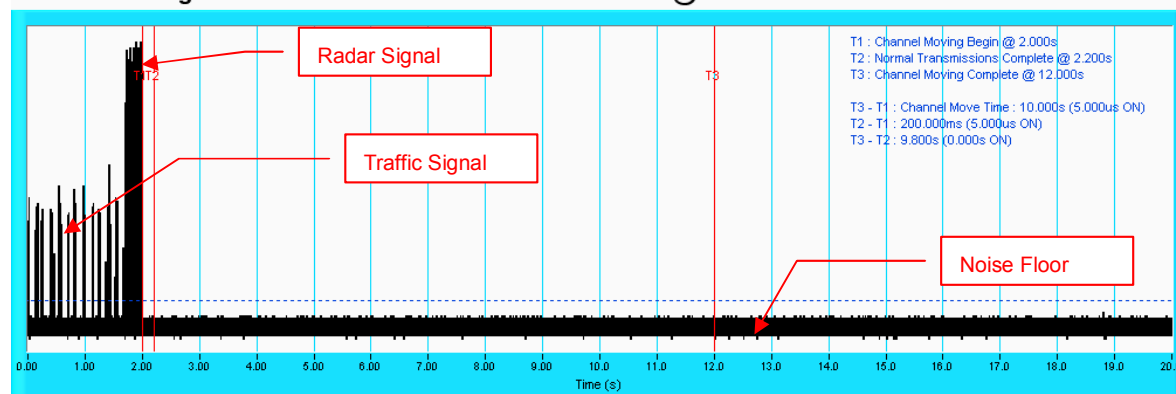

NOTE: T1 denotes the start of Channel Move Time upon the end of the last Radar burst. T2 denotes the data transmission time of 200ms from T1. T3 denotes the 10 second from T1 to observe the aggregate duration of transmissions.

Channel Closing Transmission Time & Channel Move Time @ CH064 - 5320MHz

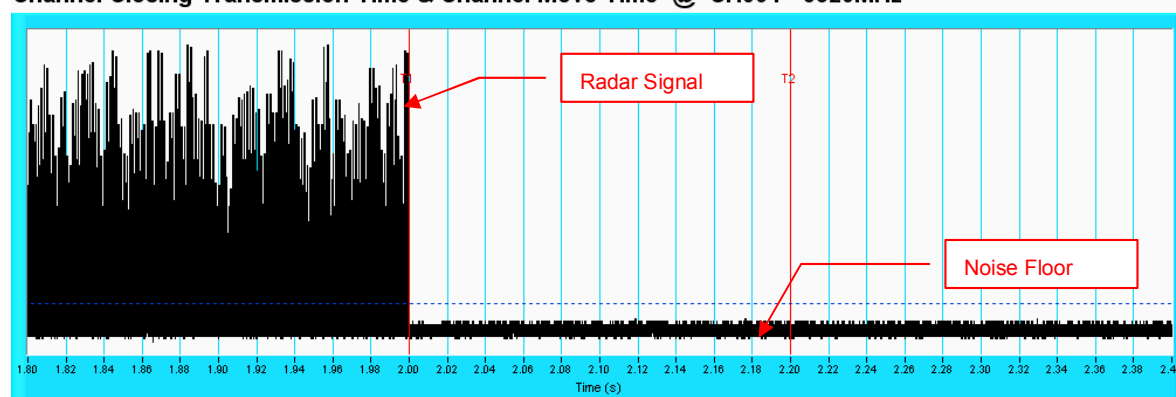

NOTE: An expanded plot for the device vacates the channel in the required 200ms.



Type 1 Radar Statistical Performances				
Trial #	Pulses per Burst	Pulse Width (s)	PRI (s)	Detection
1	18	1.0u	1.428m	Yes
2	18	1.0u	1.428m	Yes
3	18	1.0u	1.428m	Yes
4	18	1.0u	1.428m	Yes
5	18	1.0u	1.428m	Yes
6	18	1.0u	1.428m	Yes
7	18	1.0u	1.428m	Yes
8	18	1.0u	1.428m	Yes
9	18	1.0u	1.428m	Yes
10	18	1.0u	1.428m	Yes
11	18	1.0u	1.428m	Yes
12	18	1.0u	1.428m	Yes
13	18	1.0u	1.428m	Yes
14	18	1.0u	1.428m	Yes
15	18	1.0u	1.428m	Yes
16	18	1.0u	1.428m	Yes
17	18	1.0u	1.428m	Yes
18	18	1.0u	1.428m	Yes
19	18	1.0u	1.428m	Yes
20	18	1.0u	1.428m	Yes
21	18	1.0u	1.428m	Yes
22	18	1.0u	1.428m	Yes
23	18	1.0u	1.428m	Yes
24	18	1.0u	1.428m	Yes
25	18	1.0u	1.428m	Yes
26	18	1.0u	1.428m	Yes
27	18	1.0u	1.428m	Yes
28	18	1.0u	1.428m	Yes
29	18	1.0u	1.428m	Yes
30	18	1.0u	1.428m	Yes
				Detection Rate: 100.0 %



Type 2 Radar Statistical Performances				
Trial #	Pulses per Burst	Pulse Width (s)	PRI (s)	Detection
1	27	1.1u	171.0u	Yes
2	26	3.0u	198.0u	Yes
3	27	3.3u	160.0u	Yes
4	24	4.9u	206.0u	Yes
5	24	2.4u	189.0u	Yes
6	28	1.7u	194.0u	Yes
7	25	2.4u	162.0u	Yes
8	25	2.9u	175.0u	Yes
9	24	1.9u	203.0u	No
10	28	4.1u	157.0u	Yes
11	25	2.3u	213.0u	Yes
12	24	3.0u	173.0u	Yes
13	28	2.5u	199.0u	Yes
14	29	2.4u	211.0u	Yes
15	27	1.4u	164.0u	Yes
16	27	1.1u	164.0u	Yes
17	24	1.5u	208.0u	No
18	24	2.9u	208.0u	Yes
19	26	3.6u	206.0u	Yes
20	27	2.2u	224.0u	Yes
21	28	2.3u	166.0u	Yes
22	26	2.1u	217.0u	Yes
23	26	2.3u	183.0u	Yes
24	25	2.7u	191.0u	Yes
25	26	4.5u	164.0u	Yes
26	27	1.5u	195.0u	Yes
27	24	2.1u	230.0u	Yes
28	25	2.9u	192.0u	Yes
29	25	1.3u	214.0u	Yes
30	26	2.7u	210.0u	Yes
				Detection Rate: 93.3 %



Type 3 Radar Statistical Performances				
Trial #	Pulses per Burst	Pulse Width (s)	PRI (s)	Detection
1	16	9.0u	367.0u	Yes
2	18	8.9u	279.0u	Yes
3	17	9.0u	387.0u	Yes
4	16	6.4u	401.0u	Yes
5	16	8.7u	457.0u	Yes
6	16	9.4u	437.0u	Yes
7	18	9.5u	436.0u	No
8	17	9.1u	320.0u	Yes
9	17	10.0u	275.0u	Yes
10	17	7.9u	483.0u	Yes
11	18	7.8u	319.0u	Yes
12	16	8.6u	492.0u	Yes
13	16	8.4u	419.0u	Yes
14	18	7.9u	436.0u	Yes
15	17	6.9u	371.0u	Yes
16	17	6.8u	232.0u	Yes
17	18	7.3u	425.0u	Yes
18	17	7.7u	373.0u	Yes
19	18	6.9u	328.0u	Yes
20	17	6.1u	498.0u	Yes
21	17	8.2u	468.0u	No
22	17	6.7u	362.0u	Yes
23	18	9.3u	360.0u	Yes
24	17	9.2u	473.0u	Yes
25	17	6.8u	286.0u	Yes
26	17	8.5u	446.0u	No
27	17	8.7u	381.0u	Yes
28	17	9.2u	477.0u	Yes
29	18	6.7u	277.0u	Yes
30	18	7.8u	296.0u	Yes
				Detection Rate: 90.0 %



Type 4 Radar Statistical Performances				
Trial #	Pulses per Burst	Pulse Width (s)	PRI (s)	Detection
1	13	15.4u	361.0u	Yes
2	16	12.1u	442.0u	Yes
3	15	17.6u	467.0u	No
4	15	18.7u	398.0u	Yes
5	13	14.8u	332.0u	Yes
6	14	13.7u	482.0u	Yes
7	15	12.8u	346.0u	Yes
8	13	16.5u	428.0u	Yes
9	15	16.6u	380.0u	Yes
10	13	15.7u	411.0u	Yes
11	14	13.1u	241.0u	No
12	14	15.4u	376.0u	Yes
13	12	17.5u	465.0u	Yes
14	14	16.3u	454.0u	No
15	12	11.4u	300.0u	Yes
16	15	17.0u	358.0u	No
17	16	12.4u	464.0u	Yes
18	16	12.2u	470.0u	Yes
19	12	14.0u	246.0u	Yes
20	14	17.9u	384.0u	Yes
21	12	18.3u	349.0u	Yes
22	14	13.9u	201.0u	Yes
23	15	17.2u	422.0u	Yes
24	15	14.5u	323.0u	No
25	12	12.9u	290.0u	Yes
26	16	16.8u	479.0u	Yes
27	13	17.5u	499.0u	No
28	15	18.5u	365.0u	Yes
29	12	17.6u	389.0u	Yes
30	15	17.9u	431.0u	Yes
				Detection Rate: 80.0 %

Type 5 Radar Statistical Performances		
Trial #	Test Signal Name	Detection
1	LP_Signal_01	Yes
2	LP_Signal_02	Yes
3	LP_Signal_03	Yes
4	LP_Signal_04	No
5	LP_Signal_05	Yes
6	LP_Signal_06	Yes
7	LP_Signal_07	Yes
8	LP_Signal_08	Yes
9	LP_Signal_09	Yes
10	LP_Signal_10	Yes
11	LP_Signal_11	Yes
12	LP_Signal_12	Yes
13	LP_Signal_13	Yes
14	LP_Signal_14	Yes
15	LP_Signal_15	Yes
16	LP_Signal_16	Yes
17	LP_Signal_17	Yes
18	LP_Signal_18	Yes
19	LP_Signal_19	Yes
20	LP_Signal_20	Yes
21	LP_Signal_21	Yes
22	LP_Signal_22	Yes
23	LP_Signal_23	Yes
24	LP_Signal_24	Yes
25	LP_Signal_25	Yes
26	LP_Signal_26	Yes
27	LP_Signal_27	Yes
28	LP_Signal_28	Yes
29	LP_Signal_29	Yes
30	LP_Signal_30	Yes
		Detection Rate: 96.7 %

The Long Pulse Radar pattern shown in Annex B.3



Type 6 Radar Statistical Performances				
Trial #	Pulses per Burst	Pulse Width (s)	PRI (s)	Detection
1	9	1.0u	333.0u	Yes
2	9	1.0u	333.0u	Yes
3	9	1.0u	333.0u	Yes
4	9	1.0u	333.0u	Yes
5	9	1.0u	333.0u	Yes
6	9	1.0u	333.0u	Yes
7	9	1.0u	333.0u	Yes
8	9	1.0u	333.0u	Yes
9	9	1.0u	333.0u	Yes
10	9	1.0u	333.0u	Yes
11	9	1.0u	333.0u	Yes
12	9	1.0u	333.0u	Yes
13	9	1.0u	333.0u	Yes
14	9	1.0u	333.0u	Yes
15	9	1.0u	333.0u	No
16	9	1.0u	333.0u	Yes
17	9	1.0u	333.0u	Yes
18	9	1.0u	333.0u	Yes
19	9	1.0u	333.0u	Yes
20	9	1.0u	333.0u	No
21	9	1.0u	333.0u	Yes
22	9	1.0u	333.0u	Yes
23	9	1.0u	333.0u	Yes
24	9	1.0u	333.0u	No
25	9	1.0u	333.0u	Yes
26	9	1.0u	333.0u	Yes
27	9	1.0u	333.0u	No
28	9	1.0u	333.0u	Yes
29	9	1.0u	333.0u	Yes
30	9	1.0u	333.0u	Yes
				Detection Rate: 86.7 %

Type 6 Radar Statistical Performances		
Trial #	Hopping Frequency Sequence Name	Detection
1	HOP_FREQ_SEQ_01	Yes
2	HOP_FREQ_SEQ_02	Yes
3	HOP_FREQ_SEQ_03	Yes
4	HOP_FREQ_SEQ_04	Yes
5	HOP_FREQ_SEQ_05	Yes
6	HOP_FREQ_SEQ_06	Yes
7	HOP_FREQ_SEQ_07	Yes
8	HOP_FREQ_SEQ_08	Yes
9	HOP_FREQ_SEQ_09	Yes
10	HOP_FREQ_SEQ_10	Yes
11	HOP_FREQ_SEQ_11	Yes
12	HOP_FREQ_SEQ_12	Yes
13	HOP_FREQ_SEQ_13	Yes
14	HOP_FREQ_SEQ_14	Yes
15	HOP_FREQ_SEQ_15	No
16	HOP_FREQ_SEQ_16	Yes
17	HOP_FREQ_SEQ_17	Yes
18	HOP_FREQ_SEQ_18	Yes
19	HOP_FREQ_SEQ_19	Yes
20	HOP_FREQ_SEQ_20	No
21	HOP_FREQ_SEQ_21	Yes
22	HOP_FREQ_SEQ_22	Yes
23	HOP_FREQ_SEQ_23	Yes
24	HOP_FREQ_SEQ_24	No
25	HOP_FREQ_SEQ_25	Yes
26	HOP_FREQ_SEQ_26	Yes
27	HOP_FREQ_SEQ_27	No
28	HOP_FREQ_SEQ_28	Yes
29	HOP_FREQ_SEQ_29	Yes
30	HOP_FREQ_SEQ_30	Yes
		Detection Rate: 86.7 %

The Frequency Hopping Radar pattern shown in Annex B.4

5.2.3.3 NON- OCCUPANCY PERIOD

During the 30 minutes observation time, UUT did not make any transmissions on a channel after a radar signal was detected on that channel by either the Channel Availability Check or the In-Service Monitoring.

Non - Occupancy Period @ CH064 - 5320MHz

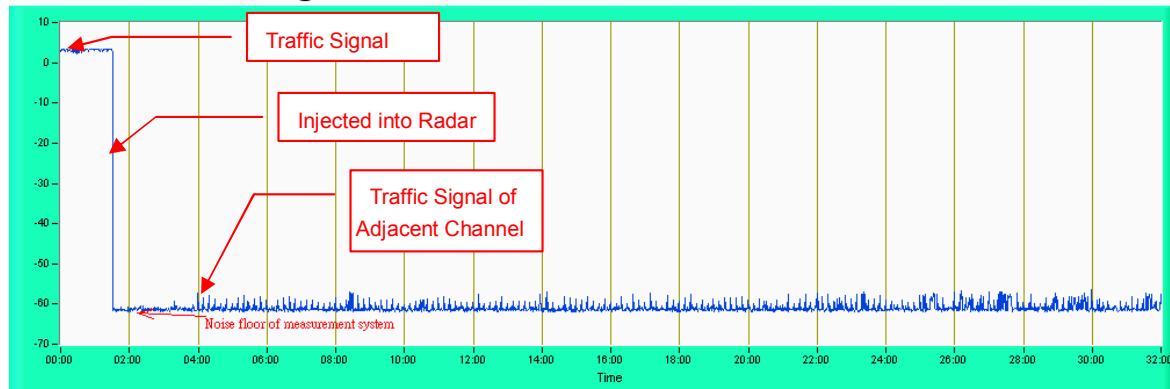

5.2.3.4 U-NII DETECTION BANDWIDTH

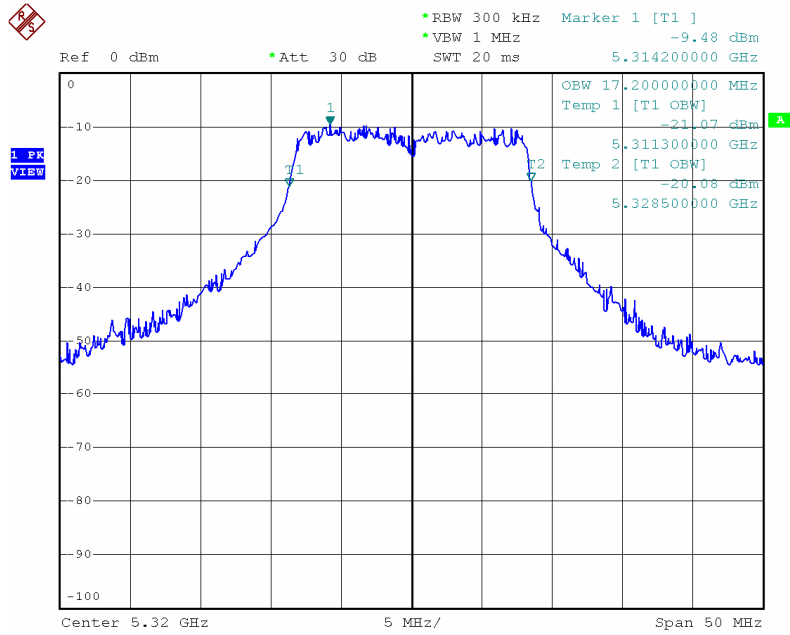

Date: 1.FEB.2007 15:48:03

U-NII 99% Channel bandwidth

Detection Bandwidth Test											
EUT Frequency: 5.320GHz											
EUT 99% Power bandwidth: 17.20MHz											
Detection bandwidth limit (80% of EUT 99% Power bandwidth): 13.76MHz											
Detection Bandwidth (FH - FL): 14.00MHz											
Test Result : PASS											
Radar	Trial Number / Detection										Detection Rate (%)
Frequency (Hz)	1	2	3	4	5	6	7	8	9	10	
5.310G	No	No	Yes	No	No	Yes	Yes	No	No	No	30
5.311G	Yes	Yes	Yes	Yes	Yes	Yes	Yes	Yes	Yes	Yes	100
5.312G	Yes	Yes	Yes	Yes	Yes	Yes	Yes	Yes	Yes	Yes	100
5.313G (FL)	Yes	Yes	Yes	Yes	Yes	Yes	Yes	Yes	Yes	Yes	100
5.314G	Yes	Yes	Yes	Yes	Yes	Yes	Yes	Yes	Yes	Yes	100
5.315G	Yes	Yes	Yes	Yes	Yes	Yes	Yes	Yes	Yes	Yes	100
5.316G	Yes	Yes	Yes	Yes	Yes	Yes	Yes	Yes	Yes	Yes	100
5.317G	Yes	Yes	Yes	Yes	Yes	Yes	Yes	Yes	Yes	Yes	100
5.318G	Yes	Yes	Yes	Yes	Yes	Yes	Yes	Yes	Yes	Yes	100
5.319G	Yes	Yes	Yes	Yes	Yes	Yes	Yes	Yes	Yes	Yes	100
5.320G	Yes	Yes	Yes	Yes	Yes	Yes	Yes	Yes	Yes	Yes	100
5.321G	Yes	Yes	Yes	Yes	Yes	Yes	Yes	Yes	Yes	Yes	100
5.322G	Yes	Yes	Yes	Yes	Yes	Yes	Yes	Yes	Yes	Yes	100
5.323G	Yes	Yes	Yes	Yes	Yes	Yes	Yes	Yes	Yes	Yes	100
5.324G	Yes	Yes	Yes	Yes	Yes	Yes	Yes	Yes	Yes	Yes	100
5.325G	Yes	Yes	Yes	Yes	Yes	Yes	Yes	Yes	Yes	Yes	100
5.326G	Yes	Yes	Yes	Yes	Yes	Yes	Yes	Yes	Yes	Yes	100
5.327G (FH)	Yes	Yes	Yes	Yes	Yes	Yes	Yes	Yes	Yes	Yes	100
5.328G	Yes	Yes	Yes	Yes	Yes	Yes	Yes	Yes	Yes	Yes	100
5.329G	Yes	Yes	Yes	Yes	Yes	Yes	Yes	Yes	Yes	Yes	100
5.330G	Yes	No	Yes	No	No	Yes	No	Yes	Yes	No	50

5.3 TRANSMIT POWER CONTROL (TPC)

The UUT can adjust a transmitter's output power based on the signal level present at the receiver.

TPC is controlled by software and the user may adjust the Transmit Power level from web interface that may adjust the transmit power among -3dB, -6dB, -9dB & -12dB from web manually when the power needs to be increased or decreased.

The interface is for WLAN bridge purpose that is installed fixedly, so we implement manual TPC instead of automatic TPC on the product.

6. ANTENNA REQUIREMENT

6.1 STANDARD APPLICABLE

For intentional device, according to FCC 47 CFR Section 15.203, an intentional radiator shall be designed to ensure that no antenna other than that furnished by the responsible party shall be used with the device.

And according to FCC 47 CFR Section 15.407(a), if transmitting antennas of directional gain greater than 6dBi are used, the power shall be reduced by the amount in dB that the directional gain of the antenna exceeds 6dBi.

6.2 ANTENNA CONNECTED CONSTRUCTION

The antennas used in this product are as following:

5GHz				
No.	Model No.	Gain (dBi)	Antenna Type	Antenna Connector
1	ANT05535	17.0dBi	Directional, Patch Panel (Internal Antenna)	Probe Pin
A	1GP-51809	9.0dBi	Dipole, Omni (External Antenna)	N female(Plug)



7. INFORMATION ON THE TESTING LABORATORIES

We, ADT Corp., were founded in 1988 to provide our best service in EMC, Radio, Telecom and Safety consultation. Our laboratories are accredited and approved by the following approval agencies according to ISO/IEC 17025.

USA	FCC, UL, A2LA
Germany	TUV Rheinland
Japan	VCCI
Norway	NEMKO
Canada	INDUSTRY CANADA , CSA
R.O.C.	CNLA, BSMI, NCC
Netherlands	Telefication
Singapore	PSB , GOST-ASIA(MOU)
Russia	CERTIS(MOU)

Copies of accreditation certificates of our laboratories obtained from approval agencies can be downloaded from our web site:

www.adt.com.tw/index.5/phtml. If you have any comments, please feel free to contact us at the following:

Linko EMC/RF Lab:
Tel: 886-2-26052180
Fax: 886-2-26051924

Hsin Chu EMC/RF Lab:
Tel: 886-3-5935343
Fax: 886-3-5935342

Hwa Ya EMC/RF/Safety Telecom Lab:
Tel: 886-3-3183232
Fax: 886-3-3185050

Web Site: www.adt.com.tw

The address and road map of all our labs can be found in our web site also.



APPENDIX-A

MODIFICATIONS RECORDERS FOR ENGINEERING CHANGES TO THE EUT BY THE LAB

No any modifications are made to the EUT by the lab during the test.



APPENDIX-B

RADAR TEST SIGNAL

B.1 The Long Pulse Radar Pattern

Long Pulse Radar Test Signal						
Test Signal Name: LP_Signal_01						
Number of Bursts in Trial: 20						
Burst	Pulses per Burst	Chrip (Hz)	Pulse Width (s)	Pulse 1 to 2 Spacing (s)	Pulse 2 to 3 Spacing (s)	Start Location (s)
1	2	9M	85.8u	1.694m	-	189.6m
2	2	10M	78.8u	1.419m	-	652.0u
3	2	14M	55.8u	1.718m	-	392.6m
4	2	10M	57.4u	1.171m	-	446.4m
5	3	9M	85.8u	1.727m	1.214m	396.2m
6	2	9M	73.4u	1.247m	-	199.4m
7	1	6M	70.7u	-	-	158.0m
8	2	17M	91.6u	1.369m	-	198.3m
9	3	7M	58.1u	1.815m	1.431m	583.1m
10	2	7M	91.2u	1.355m	-	397.4m
11	2	10M	67.4u	1.215m	-	390.5m
12	3	8M	84.1u	1.696m	1.559m	536.8m
13	3	12M	89.4u	1.489m	1.627m	84.40m
14	2	11M	98.7u	1.692m	-	381.6m
15	2	10M	95.6u	1.068m	-	27.45m
16	2	18M	75.9u	1.312m	-	595.9m
17	3	9M	92.1u	1.606m	1.755m	168.6m
18	1	18M	65.1u	-	-	574.6m
19	3	13M	78.7u	1.084m	1.677m	184.4m
20	2	7M	54.2u	1.824m	-	340.3m

Long Pulse Radar Test Signal						
Test Signal Name: LP_Signal_02						
Number of Bursts in Trial: 11						
Burst	Pulses per Burst	Chrip (Hz)	Pulse Width (s)	Pulse 1 to 2 Spacing (s)	Pulse 2 to 3 Spacing (s)	Start Location (s)
1	2	16M	81.5u	1.406m	-	288.8m
2	2	17M	55.0u	1.701m	-	131.7m
3	2	12M	70.3u	1.370m	-	576.0m
4	3	9M	51.5u	978.5u	1.911m	244.0m
5	2	20M	55.4u	1.210m	-	1.062
6	1	11M	94.1u	-	-	452.1m
7	3	10M	98.5u	1.502m	1.501m	367.6m
8	3	6M	78.8u	1.582m	1.624m	788.1m
9	1	20M	82.7u	-	-	600.1m
10	2	8M	76.0u	1.488m	-	431.9m
11	1	18M	55.1u	-	-	668.4m

Long Pulse Radar Test Signal



Test Signal Name: LP_Signal_03
Number of Bursts in Trial: 11

Burst	Pulses per Burst	Chrip (Hz)	Pulse Width (s)	Pulse 1 to 2 Spacing (s)	Pulse 2 to 3 Spacing (s)	Start Location (s)
1	2	6M	83.0u	1.906m	-	112.4m
2	3	13M	85.2u	1.475m	1.344m	1.079
3	3	6M	87.8u	1.299m	1.777m	55.62m
4	2	9M	60.6u	1.548m	-	417.9m
5	1	8M	97.0u	-	-	654.3m
6	2	16M	90.7u	977.3u	-	122.0u
7	2	18M	65.7u	1.457m	-	384.7m
8	2	13M	83.9u	1.148m	-	465.8m
9	3	17M	72.9u	1.825m	1.596m	76.12m
10	2	19M	66.2u	1.588m	-	52.73m
11	3	16M	96.4u	1.798m	1.494m	802.8m

Long Pulse Radar Test Signal
Test Signal Name: LP_Signal_04
Number of Bursts in Trial: 18

Burst	Pulses per Burst	Chrip (Hz)	Pulse Width (s)	Pulse 1 to 2 Spacing (s)	Pulse 2 to 3 Spacing (s)	Start Location (s)
1	2	7M	50.5u	1.468m	-	185.5m
2	1	7M	64.0u	-	-	287.8m
3	3	13M	97.7u	1.380m	1.566m	16.66m
4	1	20M	96.1u	-	-	92.66m
5	1	18M	74.6u	-	-	303.2m
6	1	18M	98.0u	-	-	213.9m
7	1	6M	57.6u	-	-	396.8m
8	1	15M	88.8u	-	-	272.4m
9	3	12M	66.7u	1.140m	1.096m	374.6m
10	1	20M	56.2u	-	-	580.8m
11	1	19M	83.1u	-	-	659.8m
12	3	8M	95.6u	1.801m	1.173m	479.1m
13	2	19M	80.9u	1.047m	-	40.76m
14	1	8M	94.4u	-	-	329.6m
15	2	20M	77.7u	1.716m	-	47.36m
16	2	16M	51.8u	1.114m	-	545.4m
17	2	19M	95.0u	1.348m	-	102.3m
18	2	12M	53.3u	1.092m	-	85.99m

Long Pulse Radar Test Signal
Test Signal Name: LP_Signal_05
Number of Bursts in Trial: 15

Burst	Pulses per Burst	Chrip (Hz)	Pulse Width (s)	Pulse 1 to 2 Spacing (s)	Pulse 2 to 3 Spacing (s)	Start Location (s)
1	2	17M	64.6u	1.427m	-	389.1m
2	2	11M	80.8u	1.734m	-	486.3m
3	2	16M	55.8u	1.660m	-	729.1m
4	2	10M	66.0u	1.414m	-	672.4m
5	2	14M	56.6u	1.010m	-	618.7m
6	1	11M	65.3u	-	-	395.0m
7	3	5M	79.9u	1.683m	1.866m	360.5m



8	2	20M	70.9u	1.132m	-	602.1m
9	1	7M	94.1u	-	-	185.4m
10	2	14M	66.9u	1.603m	-	239.6m
11	1	15M	83.3u	-	-	177.3m
12	2	6M	70.9u	985.1u	-	561.6m
13	1	8M	87.8u	-	-	576.9m
14	2	17M	51.2u	1.343m	-	327.2m
15	3	16M	91.8u	1.351m	1.558m	122.3m

Long Pulse Radar Test Signal
 Test Signal Name: LP_Signal_06
 Number of Bursts in Trial: 14

Burst	Pulses per Burst	Chrip (Hz)	Pulse Width (s)	Pulse 1 to 2 Spacing (s)	Pulse 2 to 3 Spacing (s)	Start Location (s)
1	2	19M	81.6u	1.448m	-	604.8m
2	2	6M	68.5u	1.316m	-	184.4m
3	3	19M	94.9u	1.853m	934.1u	84.98m
4	3	10M	86.0u	1.474m	1.850m	174.5m
5	2	15M	65.5u	1.809m	-	801.6m
6	2	15M	77.9u	1.314m	-	511.9m
7	3	8M	83.8u	1.668m	1.484m	272.6m
8	2	12M	57.1u	1.726m	-	616.6m
9	3	9M	88.8u	1.349m	1.466m	456.8m
10	3	11M	79.5u	1.744m	1.395m	344.3m
11	3	7M	87.2u	1.043m	1.482m	555.8m
12	3	16M	60.4u	1.454m	1.591m	744.7m
13	3	9M	63.5u	1.016m	948.5u	501.4m
14	1	6M	50.9u	-	-	149.9m

Long Pulse Radar Test Signal
 Test Signal Name: LP_Signal_07
 Number of Bursts in Trial: 9

Burst	Pulses per Burst	Chrip (Hz)	Pulse Width (s)	Pulse 1 to 2 Spacing (s)	Pulse 2 to 3 Spacing (s)	Start Location (s)
1	2	7M	83.6u	1.144m	-	127.4m
2	2	16M	82.4u	1.146m	-	1.170
3	1	19M	82.1u	-	-	293.0m
4	1	8M	56.1u	-	-	449.8m
5	2	12M	67.6u	1.578m	-	60.01m
6	2	9M	97.5u	1.302m	-	1.146
7	2	15M	78.0u	1.825m	-	666.7m
8	3	12M	91.9u	1.310m	1.148m	1.564m
9	1	14M	54.8u	-	-	201.5m

Long Pulse Radar Test Signal
 Test Signal Name: LP_Signal_08
 Number of Bursts in Trial: 12

Burst	Pulses per Burst	Chrip (Hz)	Pulse Width (s)	Pulse 1 to 2 Spacing (s)	Pulse 2 to 3 Spacing (s)	Start Location (s)
1	2	7M	99.0u	1.061m	-	631.5m
2	3	12M	80.5u	1.804m	1.479m	375.4m
3	2	8M	61.3u	1.398m	-	702.9m
4	3	12M	73.3u	1.685m	1.446m	588.5m



5	2	11M	50.4u	1.295m	-	143.6m
6	3	15M	72.6u	1.337m	1.175m	389.2m
7	2	15M	65.4u	1.705m	-	701.9m
8	2	18M	73.8u	1.000m	-	738.8m
9	3	16M	83.4u	1.181m	1.054m	89.33m
10	2	9M	95.6u	1.583m	-	434.3m
11	2	18M	50.2u	1.361m	-	166.1m
12	2	10M	64.8u	1.750m	-	949.1m

Long Pulse Radar Test Signal
 Test Signal Name: LP_Signal_09
 Number of Bursts in Trial: 20

Burst	Pulses per Burst	Chrip (Hz)	Pulse Width (s)	Pulse 1 to 2 Spacing (s)	Pulse 2 to 3 Spacing (s)	Start Location (s)
1	1	18M	85.4u	-	-	28.64m
2	3	17M	66.2u	1.720m	1.241m	449.7m
3	2	14M	64.6u	1.521m	-	440.0m
4	3	8M	66.2u	1.263m	940.8u	446.4m
5	3	17M	53.0u	1.318m	1.266m	418.2m
6	3	19M	94.1u	1.700m	1.014m	346.5m
7	3	12M	61.1u	958.9u	1.567m	56.26m
8	2	16M	77.8u	1.555m	-	152.6m
9	3	7M	69.9u	1.902m	1.428m	170.7m
10	3	9M	70.7u	950.3u	1.162m	561.4m
11	1	18M	75.5u	-	-	494.8m
12	1	6M	69.9u	-	-	356.4m
13	2	12M	60.9u	1.443m	-	562.0m
14	2	9M	86.0u	1.029m	-	442.3m
15	1	12M	62.4u	-	-	526.4m
16	2	18M	94.3u	1.530m	-	265.9m
17	3	8M	72.0u	1.508m	1.374m	195.2m
18	2	11M	97.2u	1.871m	-	96.12m
19	1	12M	63.9u	-	-	300.9m
20	2	7M	81.3u	1.434m	-	263.6m

Long Pulse Radar Test Signal
 Test Signal Name: LP_Signal_10
 Number of Bursts in Trial: 19

Burst	Pulses per Burst	Chrip (Hz)	Pulse Width (s)	Pulse 1 to 2 Spacing (s)	Pulse 2 to 3 Spacing (s)	Start Location (s)
1	2	7M	54.0u	1.040m	-	237.2m
2	2	14M	98.7u	1.650m	-	192.7m
3	1	17M	92.6u	-	-	171.0m
4	2	7M	51.4u	1.298m	-	560.1m
5	2	16M	80.9u	1.696m	-	215.5m
6	2	11M	73.9u	1.155m	-	6.258m
7	2	15M	82.5u	986.5u	-	273.1m
8	3	16M	74.4u	1.796m	1.667m	310.7m
9	2	6M	59.2u	1.879m	-	338.0m
10	1	15M	81.6u	-	-	79.07m
11	2	19M	90.6u	1.440m	-	28.15m
12	3	12M	91.9u	1.408m	1.859m	38.77m



13	3	17M	84.3u	1.320m	1.475m	616.2m
14	2	9M	92.1u	1.698m	-	200.8m
15	2	11M	50.4u	1.767m	-	247.7m
16	1	8M	68.8u	-	-	629.8m
17	2	16M	92.5u	1.605m	-	368.9m
18	3	17M	94.9u	1.731m	1.679m	207.3m
19	3	20M	53.3u	1.046m	1.253m	502.0m

Long Pulse Radar Test Signal
 Test Signal Name: LP_Signal_11
 Number of Bursts in Trial: 9

Burst	Pulses per Burst	Chrip (Hz)	Pulse Width (s)	Pulse 1 to 2 Spacing (s)	Pulse 2 to 3 Spacing (s)	Start Location (s)
1	2	11M	90.1u	948.9u	-	202.3m
2	2	16M	94.6u	1.349m	-	1.216
3	3	5M	90.1u	1.204m	1.704m	274.8m
4	2	14M	99.7u	1.645m	-	1.016
5	2	13M	97.9u	1.665m	-	673.2m
6	2	7M	63.7u	1.841m	-	488.0m
7	2	16M	77.6u	1.138m	-	51.60m
8	2	18M	84.2u	1.697m	-	718.2m
9	3	14M	98.2u	1.901m	921.8u	281.7m

Long Pulse Radar Test Signal
 Test Signal Name: LP_Signal_12
 Number of Bursts in Trial: 18

Burst	Pulses per Burst	Chrip (Hz)	Pulse Width (s)	Pulse 1 to 2 Spacing (s)	Pulse 2 to 3 Spacing (s)	Start Location (s)
1	1	19M	68.7u	-	-	547.3m
2	3	19M	69.8u	1.192m	1.794m	204.7m
3	1	15M	99.8u	-	-	72.14m
4	3	14M	55.9u	1.691m	1.650m	578.7m
5	2	10M	51.8u	993.2u	-	37.58m
6	1	19M	96.6u	-	-	291.8m
7	2	11M	92.7u	1.796m	-	246.4m
8	2	19M	97.7u	1.276m	-	255.5m
9	3	13M	90.5u	1.902m	1.902m	330.2m
10	2	13M	77.2u	995.8u	-	533.1m
11	1	6M	51.7u	-	-	636.4m
12	1	15M	59.0u	-	-	639.1m
13	2	11M	65.2u	1.163m	-	485.6m
14	1	8M	94.7u	-	-	425.1m
15	1	19M	57.1u	-	-	113.4m
16	3	12M	92.2u	1.603m	1.238m	298.6m
17	1	9M	97.4u	-	-	609.2m
18	3	14M	73.7u	1.299m	1.527m	455.3m

Long Pulse Radar Test Signal
 Test Signal Name: LP_Signal_13
 Number of Bursts in Trial: 19

Burst	Pulses per Burst	Chrip (Hz)	Pulse Width (s)	Pulse 1 to 2 Spacing (s)	Pulse 2 to 3 Spacing (s)	Start Location (s)
1	1	7M	85.3u	-	-	203.6m



2	3	16M	84.7u	1.307m	1.097m	193.3m
3	2	15M	60.4u	1.876m	-	303.6m
4	3	13M	53.1u	1.104m	1.854m	436.2m
5	1	20M	96.5u	-	-	326.7m
6	3	17M	78.4u	1.851m	943.6u	304.5m
7	3	15M	54.6u	1.124m	1.048m	345.9m
8	2	15M	68.4u	1.700m	-	332.7m
9	2	10M	77.0u	1.588m	-	377.7m
10	2	6M	76.3u	1.077m	-	271.4m
11	3	6M	80.4u	1.905m	1.223m	90.11m
12	1	12M	76.6u	-	-	315.6m
13	2	17M	51.9u	1.084m	-	277.7m
14	2	12M	83.5u	1.148m	-	322.3m
15	3	6M	80.4u	1.543m	1.480m	207.8m
16	3	19M	92.6u	1.656m	1.890m	41.48m
17	2	11M	66.4u	1.677m	-	240.5m
18	2	9M	95.7u	1.515m	-	212.6m
19	2	19M	79.4u	1.528m	-	381.7m

Long Pulse Radar Test Signal
 Test Signal Name: LP_Signal_14
 Number of Bursts in Trial: 13

Burst	Pulses per Burst	Chrip (Hz)	Pulse Width (s)	Pulse 1 to 2 Spacing (s)	Pulse 2 to 3 Spacing (s)	Start Location (s)
1	2	7M	75.9u	1.201m	-	455.8m
2	1	7M	89.6u	-	-	278.5m
3	1	11M	55.9u	-	-	745.1m
4	2	8M	63.2u	949.8u	-	617.7m
5	2	10M	77.5u	1.023m	-	261.4m
6	1	13M	63.9u	-	-	610.9m
7	2	19M	81.2u	1.456m	-	255.0m
8	2	18M	97.1u	1.029m	-	453.6m
9	2	8M	86.3u	1.901m	-	117.2m
10	3	18M	82.6u	1.911m	1.639m	305.0m
11	2	15M	87.2u	1.064m	-	168.5m
12	3	12M	93.7u	1.225m	950.3u	806.9m
13	1	16M	95.1u	-	-	500.1m

Long Pulse Radar Test Signal
 Test Signal Name: LP_Signal_15
 Number of Bursts in Trial: 15

Burst	Pulses per Burst	Chrip (Hz)	Pulse Width (s)	Pulse 1 to 2 Spacing (s)	Pulse 2 to 3 Spacing (s)	Start Location (s)
1	2	12M	78.7u	1.149m	-	613.7m
2	2	10M	91.3u	1.102m	-	617.2m
3	1	6M	53.2u	-	-	99.12m
4	2	6M	60.4u	1.287m	-	12.01m
5	2	9M	84.4u	1.379m	-	464.8m
6	2	7M	73.7u	1.389m	-	105.5m
7	3	12M	97.1u	1.444m	1.854m	781.6m
8	2	16M	99.9u	1.739m	-	246.0m
9	3	6M	59.2u	1.505m	1.337m	491.1m



10	3	15M	85.8u	1.805m	1.866m	414.0m
11	2	10M	61.1u	1.500m	-	594.6m
12	2	14M	93.3u	1.540m	-	472.9m
13	3	12M	61.8u	1.211m	1.037m	378.9m
14	2	7M	74.0u	1.642m	-	746.7m
15	1	15M	61.4u	-	-	742.9m

Long Pulse Radar Test Signal

Test Signal Name: LP_Signal_16

Number of Bursts in Trial: 20

Burst	Pulses per Burst	Chrip (Hz)	Pulse Width (s)	Pulse 1 to 2 Spacing (s)	Pulse 2 to 3 Spacing (s)	Start Location (s)
1	3	6M	69.5u	1.043m	1.331m	391.5m
2	2	15M	62.2u	1.597m	-	474.8m
3	3	19M	51.8u	1.531m	1.031m	493.1m
4	2	16M	55.7u	1.522m	-	136.3m
5	2	18M	73.6u	1.189m	-	530.7m
6	2	14M	64.6u	1.130m	-	588.5m
7	1	13M	82.5u	-	-	309.4m
8	1	9M	56.3u	-	-	321.7m
9	2	19M	53.6u	1.661m	-	12.40m
10	2	12M	69.5u	1.561m	-	426.2m
11	1	7M	58.5u	-	-	229.6m
12	2	11M	88.2u	1.541m	-	67.47m
13	2	19M	81.5u	1.785m	-	159.5m
14	1	5M	91.0u	-	-	472.8m
15	1	6M	57.0u	-	-	474.8m
16	2	18M	97.2u	963.8u	-	157.6m
17	1	12M	56.7u	-	-	598.0m
18	2	16M	67.8u	1.761m	-	165.1m
19	2	10M	84.0u	951.0u	-	249.4m
20	2	14M	74.6u	1.577m	-	269.0m

Long Pulse Radar Test Signal

Test Signal Name: LP_Signal_17

Number of Bursts in Trial: 9

Burst	Pulses per Burst	Chrip (Hz)	Pulse Width (s)	Pulse 1 to 2 Spacing (s)	Pulse 2 to 3 Spacing (s)	Start Location (s)
1	2	11M	83.4u	1.893m	-	138.0m
2	2	12M	74.7u	1.358m	-	1.092
3	1	11M	67.2u	-	-	1.177
4	2	19M	81.6u	1.765m	-	240.0m
5	2	18M	92.3u	1.656m	-	1.156
6	2	14M	92.2u	950.8u	-	228.0m
7	2	15M	54.7u	1.591m	-	1.157
8	2	14M	88.9u	1.237m	-	1.041
9	3	6M	55.4u	1.701m	1.460m	612.8m

Long Pulse Radar Test Signal

Test Signal Name: LP_Signal_18

Number of Bursts in Trial: 15

Burst	Pulses per Burst	Chrip (Hz)	Pulse Width (s)	Pulse 1 to 2 Spacing (s)	Pulse 2 to 3 Spacing (s)	Start Location (s)
-------	------------------	------------	-----------------	--------------------------	--------------------------	--------------------



1	2	15M	75.7u	981.3u	-	428.2m
2	1	5M	61.2u	-	-	312.5m
3	1	17M	95.1u	-	-	673.1m
4	2	10M	99.0u	1.223m	-	235.6m
5	1	11M	83.4u	-	-	384.1m
6	1	11M	84.7u	-	-	110.9m
7	1	7M	71.5u	-	-	549.3m
8	2	15M	64.0u	1.173m	-	84.60m
9	2	10M	87.9u	1.366m	-	215.9m
10	1	8M	78.4u	-	-	734.0m
11	3	16M	86.2u	1.480m	1.269m	488.7m
12	3	12M	92.8u	1.250m	1.075m	483.1m
13	1	11M	81.8u	-	-	630.1m
14	2	11M	79.9u	1.833m	-	147.9m
15	2	13M	64.5u	1.414m	-	583.8m

Long Pulse Radar Test Signal

Test Signal Name: LP_Signal_19

Number of Bursts in Trial: 8

Burst	Pulses per Burst	Chrip (Hz)	Pulse Width (s)	Pulse 1 to 2 Spacing (s)	Pulse 2 to 3 Spacing (s)	Start Location (s)
1	1	9M	65.8u	-	-	626.3m
2	2	10M	94.8u	1.536m	-	764.9m
3	3	17M	92.6u	1.242m	1.887m	514.3m
4	2	7M	63.6u	1.783m	-	175.3m
5	3	18M	67.6u	1.788m	1.057m	859.9m
6	2	10M	96.3u	1.409m	-	1.000
7	2	10M	60.4u	1.150m	-	477.3m
8	1	8M	64.4u	-	-	1.043

Long Pulse Radar Test Signal

Test Signal Name: LP_Signal_20

Number of Bursts in Trial: 18

Burst	Pulses per Burst	Chrip (Hz)	Pulse Width (s)	Pulse 1 to 2 Spacing (s)	Pulse 2 to 3 Spacing (s)	Start Location (s)
1	3	17M	85.9u	1.839m	1.614m	100.0m
2	1	16M	93.8u	-	-	57.13m
3	1	13M	91.5u	-	-	63.03m
4	2	10M	89.9u	1.836m	-	428.6m
5	2	15M	60.4u	1.703m	-	597.4m
6	2	10M	59.1u	1.502m	-	357.5m
7	1	7M	96.9u	-	-	406.5m
8	2	10M	63.8u	1.487m	-	135.4m
9	2	19M	85.8u	968.2u	-	537.9m
10	2	9M	95.6u	1.494m	-	319.5m
11	2	7M	87.5u	1.658m	-	257.9m
12	3	20M	86.2u	1.503m	1.549m	217.8m
13	2	18M	62.2u	986.8u	-	129.3m
14	2	9M	94.4u	1.747m	-	471.2m
15	1	9M	86.7u	-	-	592.5m
16	1	16M	62.1u	-	-	533.3m
17	2	12M	86.4u	1.294m	-	502.9m



18	2	19M	76.6u	1.334m	-	417.8m
----	---	-----	-------	--------	---	--------

Long Pulse Radar Test Signal
 Test Signal Name: LP_Signal_21
 Number of Bursts in Trial: 12

Burst	Pulses per Burst	Chrip (Hz)	Pulse Width (s)	Pulse 1 to 2 Spacing (s)	Pulse 2 to 3 Spacing (s)	Start Location (s)
1	3	16M	76.5u	1.406m	1.602m	1.857m
2	3	18M	96.0u	1.069m	1.186m	962.2m
3	1	12M	94.3u	-	-	491.0m
4	2	20M	52.0u	1.770m	-	333.2m
5	3	14M	78.0u	1.867m	1.278m	256.8m
6	2	7M	59.0u	1.685m	-	538.3m
7	1	19M	84.3u	-	-	273.9m
8	2	13M	56.9u	1.814m	-	911.2m
9	3	7M	77.0u	1.196m	1.329m	389.7m
10	1	17M	68.9u	-	-	280.6m
11	2	10M	93.6u	1.521m	-	634.4m
12	1	11M	79.9u	-	-	451.7m

Long Pulse Radar Test Signal
 Test Signal Name: LP_Signal_22
 Number of Bursts in Trial: 12

Burst	Pulses per Burst	Chrip (Hz)	Pulse Width (s)	Pulse 1 to 2 Spacing (s)	Pulse 2 to 3 Spacing (s)	Start Location (s)
1	2	13M	93.4u	1.127m	-	224.3m
2	3	19M	56.5u	1.051m	1.114m	238.7m
3	1	9M	53.6u	-	-	752.5m
4	3	9M	51.6u	1.384m	1.448m	815.5m
5	2	10M	85.0u	1.509m	-	633.5m
6	3	7M	94.3u	1.785m	1.130m	199.7m
7	2	18M	67.5u	1.072m	-	370.9m
8	2	14M	74.8u	1.131m	-	378.1m
9	2	17M	98.5u	936.5u	-	111.1m
10	3	10M	88.4u	1.387m	953.6u	771.9m
11	2	15M	96.9u	1.245m	-	118.7m
12	3	9M	52.8u	1.377m	1.076m	222.3m

Long Pulse Radar Test Signal
 Test Signal Name: LP_Signal_23
 Number of Bursts in Trial: 19

Burst	Pulses per Burst	Chrip (Hz)	Pulse Width (s)	Pulse 1 to 2 Spacing (s)	Pulse 2 to 3 Spacing (s)	Start Location (s)
1	1	5M	90.4u	-	-	224.2m
2	1	19M	73.6u	-	-	563.4m
3	2	14M	79.9u	1.192m	-	621.6m
4	2	7M	86.6u	1.020m	-	6.848m
5	2	16M	98.4u	1.651m	-	237.4m
6	2	19M	85.0u	1.793m	-	164.3m
7	2	11M	59.7u	1.274m	-	190.2m
8	1	14M	80.3u	-	-	605.9m
9	1	15M	51.4u	-	-	513.2m
10	2	14M	69.9u	1.338m	-	214.6m



11	2	12M	97.4u	1.253m	-	172.9m
12	2	17M	79.1u	1.137m	-	254.2m
13	1	15M	81.4u	-	-	343.7m
14	2	9M	62.0u	1.628m	-	619.7m
15	1	17M	82.9u	-	-	115.6m
16	3	6M	70.6u	1.779m	1.255m	500.1m
17	3	19M	91.7u	1.381m	1.171m	107.6m
18	1	20M	52.9u	-	-	377.5m
19	1	17M	71.3u	-	-	7.755m

Long Pulse Radar Test Signal
 Test Signal Name: LP_Signal_24
 Number of Bursts in Trial: 10

Burst	Pulses per Burst	Chrip (Hz)	Pulse Width (s)	Pulse 1 to 2 Spacing (s)	Pulse 2 to 3 Spacing (s)	Start Location (s)
1	2	11M	82.8u	947.2u	-	25.65m
2	2	13M	54.7u	1.042m	-	317.3m
3	3	19M	76.7u	1.097m	1.176m	447.4m
4	2	18M	67.3u	1.846m	-	570.2m
5	3	5M	78.6u	1.730m	1.890m	577.7m
6	1	11M	76.7u	-	-	884.7m
7	2	18M	93.1u	1.685m	-	273.2m
8	1	9M	62.0u	-	-	495.3m
9	3	7M	96.3u	1.375m	1.753m	658.0m
10	2	11M	54.5u	1.895m	-	346.1m

Long Pulse Radar Test Signal
 Test Signal Name: LP_Signal_25
 Number of Bursts in Trial: 20

Burst	Pulses per Burst	Chrip (Hz)	Pulse Width (s)	Pulse 1 to 2 Spacing (s)	Pulse 2 to 3 Spacing (s)	Start Location (s)
1	2	9M	70.7u	973.3u	-	551.8m
2	2	8M	88.4u	915.6u	-	502.5m
3	2	17M	96.4u	1.682m	-	71.72m
4	1	17M	89.9u	-	-	82.07m
5	2	18M	86.2u	1.185m	-	538.5m
6	2	9M	77.5u	1.869m	-	439.6m
7	1	11M	90.1u	-	-	565.5m
8	2	13M	95.2u	1.520m	-	210.9m
9	2	12M	55.1u	1.207m	-	170.0m
10	1	16M	92.9u	-	-	484.7m
11	1	10M	57.8u	-	-	188.4m
12	2	17M	53.6u	1.652m	-	278.1m
13	1	8M	74.8u	-	-	302.3m
14	3	8M	96.1u	1.765m	1.159m	511.0m
15	1	18M	62.0u	-	-	403.4m
16	2	6M	90.2u	1.348m	-	108.8m
17	3	9M	74.5u	1.233m	1.483m	13.15m
18	3	12M	79.0u	1.237m	1.479m	465.0m
19	2	18M	87.3u	1.031m	-	154.1m
20	2	11M	95.7u	1.723m	-	289.1m



Long Pulse Radar Test Signal
 Test Signal Name: LP_Signal_26
 Number of Bursts in Trial: 11

Burst	Pulses per Burst	Chrip (Hz)	Pulse Width (s)	Pulse 1 to 2 Spacing (s)	Pulse 2 to 3 Spacing (s)	Start Location (s)
1	2	6M	57.3u	1.005m	-	929.5m
2	2	15M	55.6u	1.783m	-	843.4m
3	2	18M	51.0u	1.360m	-	734.8m
4	1	18M	83.8u	-	-	821.1m
5	2	17M	61.4u	1.804m	-	392.2m
6	1	16M	74.4u	-	-	691.8m
7	2	13M	53.8u	1.191m	-	775.4m
8	1	16M	85.9u	-	-	845.5m
9	2	19M	88.1u	1.467m	-	613.5m
10	1	10M	84.7u	-	-	171.7m
11	3	18M	55.4u	1.832m	1.673m	507.9m

Long Pulse Radar Test Signal
 Test Signal Name: LP_Signal_27
 Number of Bursts in Trial: 8

Burst	Pulses per Burst	Chrip (Hz)	Pulse Width (s)	Pulse 1 to 2 Spacing (s)	Pulse 2 to 3 Spacing (s)	Start Location (s)
1	1	6M	74.2u	-	-	1.173
2	2	8M	80.5u	1.866m	-	107.8m
3	1	9M	50.1u	-	-	97.06m
4	2	17M	85.0u	1.416m	-	1.276
5	1	19M	69.3u	-	-	997.3m
6	3	16M	68.9u	1.508m	1.589m	957.8m
7	3	14M	96.6u	1.471m	1.480m	14.31m
8	2	16M	98.3u	1.699m	-	849.1m

Long Pulse Radar Test Signal
 Test Signal Name: LP_Signal_28
 Number of Bursts in Trial: 17

Burst	Pulses per Burst	Chrip (Hz)	Pulse Width (s)	Pulse 1 to 2 Spacing (s)	Pulse 2 to 3 Spacing (s)	Start Location (s)
1	3	19M	86.5u	1.254m	1.340m	490.6m
2	3	14M	72.5u	1.246m	1.818m	419.8m
3	3	7M	87.4u	1.149m	1.167m	387.4m
4	2	7M	92.1u	1.618m	-	212.4m
5	2	19M	67.2u	1.392m	-	49.21m
6	3	15M	89.4u	1.751m	1.804m	443.4m
7	2	11M	79.9u	944.1u	-	153.4m
8	3	12M	71.6u	1.765m	1.815m	326.6m
9	3	9M	81.8u	1.652m	1.030m	261.7m
10	1	16M	57.2u	-	-	472.0m
11	2	19M	73.7u	1.219m	-	139.6m
12	2	14M	83.1u	1.553m	-	68.27m
13	1	11M	64.5u	-	-	308.4m
14	2	6M	55.8u	1.707m	-	150.2m
15	3	11M	51.2u	1.241m	1.407m	409.9m
16	3	8M	51.9u	1.868m	1.167m	679.4m
17	1	16M	70.4u	-	-	8.495m



Long Pulse Radar Test Signal
 Test Signal Name: LP_Signal_29
 Number of Bursts in Trial: 16

Burst	Pulses per Burst	Chrip (Hz)	Pulse Width (s)	Pulse 1 to 2 Spacing (s)	Pulse 2 to 3 Spacing (s)	Start Location (s)
1	3	13M	57.1u	1.884m	1.544m	245.1m
2	1	6M	83.2u	-	-	2.557m
3	2	8M	61.8u	1.670m	-	635.9m
4	2	19M	63.1u	968.9u	-	243.3m
5	2	11M	63.2u	1.357m	-	83.86m
6	2	18M	55.6u	1.194m	-	454.2m
7	3	17M	90.0u	1.145m	952.0u	554.9m
8	1	12M	66.7u	-	-	620.0m
9	1	14M	56.2u	-	-	493.2m
10	2	10M	93.2u	932.8u	-	337.0m
11	1	13M	78.2u	-	-	195.3m
12	1	19M	68.0u	-	-	723.0m
13	2	11M	89.5u	1.118m	-	191.0m
14	1	20M	73.3u	-	-	203.8m
15	2	5M	71.7u	1.138m	-	569.2m
16	2	13M	68.0u	1.129m	-	114.1m

Long Pulse Radar Test Signal
 Test Signal Name: LP_Signal_30
 Number of Bursts in Trial: 19

Burst	Pulses per Burst	Chrip (Hz)	Pulse Width (s)	Pulse 1 to 2 Spacing (s)	Pulse 2 to 3 Spacing (s)	Start Location (s)
1	2	15M	92.9u	1.566m	-	78.87m
2	1	8M	61.3u	-	-	398.1m
3	1	9M	72.9u	-	-	470.3m
4	1	7M	68.6u	-	-	296.5m
5	2	15M	52.1u	1.884m	-	370.2m
6	2	10M	62.2u	1.351m	-	415.6m
7	1	12M	79.6u	-	-	110.8m
8	3	15M	60.8u	1.908m	1.573m	385.3m
9	2	11M	51.5u	1.365m	-	5.978m
10	2	18M	93.8u	1.311m	-	392.9m
11	1	19M	67.1u	-	-	610.6m
12	1	8M	92.0u	-	-	302.4m
13	2	14M	77.9u	1.401m	-	178.5m
14	2	8M	77.1u	1.343m	-	438.9m
15	3	16M	68.9u	1.881m	1.707m	246.6m
16	2	12M	58.8u	1.746m	-	315.0m
17	2	15M	86.5u	1.071m	-	468.2m
18	1	8M	77.4u	-	-	589.9m
19	2	13M	74.7u	1.645m	-	338.7m



B.2 The Frequency Hopping Radar Pattern

Hopping Frequency Sequence Name: HOP_FREQ_SEQ_01							
SEQ#	Frequency (Hz)	SEQ#	Frequency (Hz)	SEQ#	Frequency (Hz)	SEQ#	Frequency (Hz)
1	5.333G	2	5.602G	3	5.572G	4	5.641G
5	5.689G	6	5.452G	7	5.523G	8	5.686G
9	5.565G	10	5.255G	11	5.427G	12	5.569G
13	5.428G	14	5.596G	15	5.257G	16	5.423G
17	5.575G	18	5.359G	19	5.316G	20	5.549G
21	5.410G	22	5.520G	23	5.351G	24	5.412G
25	5.292G	26	5.649G	27	5.545G	28	5.283G
29	5.251G	30	5.647G	31	5.391G	32	5.645G
33	5.356G	34	5.635G	35	5.373G	36	5.673G
37	5.594G	38	5.444G	39	5.643G	40	5.570G
41	5.595G	42	5.722G	43	5.548G	44	5.694G
45	5.424G	46	5.294G	47	5.370G	48	5.560G
49	5.345G	50	5.297G	51	5.573G	52	5.672G
53	5.571G	54	5.559G	55	5.389G	56	5.547G
57	5.477G	58	5.495G	59	5.609G	60	5.511G
61	5.460G	62	5.498G	63	5.480G	64	5.615G
65	5.327G	66	5.344G	67	5.414G	68	5.431G
69	5.435G	70	5.397G	71	5.491G	72	5.577G
73	5.723G	74	5.631G	75	5.721G	76	5.458G
77	5.537G	78	5.482G	79	5.403G	80	5.347G
81	5.276G	82	5.266G	83	5.463G	84	5.443G
85	5.278G	86	5.254G	87	5.670G	88	5.582G
89	5.394G	90	5.677G	91	5.402G	92	5.614G
93	5.399G	94	5.599G	95	5.471G	96	5.712G
97	5.586G	98	5.420G	99	5.568G	100	5.646G

Hopping Frequency Sequence Name: HOP_FREQ_SEQ_02							
SEQ#	Frequency (Hz)	SEQ#	Frequency (Hz)	SEQ#	Frequency (Hz)	SEQ#	Frequency (Hz)
1	5.351G	2	5.574G	3	5.396G	4	5.708G
5	5.628G	6	5.290G	7	5.634G	8	5.700G
9	5.466G	10	5.467G	11	5.717G	12	5.592G
13	5.685G	14	5.579G	15	5.416G	16	5.456G
17	5.413G	18	5.272G	19	5.513G	20	5.326G
21	5.526G	22	5.558G	23	5.366G	24	5.253G
25	5.704G	26	5.304G	27	5.657G	28	5.451G
29	5.461G	30	5.472G	31	5.257G	32	5.440G
33	5.615G	34	5.718G	35	5.557G	36	5.294G
37	5.528G	38	5.391G	39	5.384G	40	5.713G
41	5.250G	42	5.282G	43	5.721G	44	5.436G
45	5.476G	46	5.489G	47	5.505G	48	5.382G
49	5.495G	50	5.339G	51	5.538G	52	5.565G
53	5.709G	54	5.677G	55	5.310G	56	5.445G
57	5.321G	58	5.407G	59	5.707G	60	5.372G
61	5.267G	62	5.395G	63	5.691G	64	5.252G
65	5.651G	66	5.568G	67	5.663G	68	5.554G



69	5.258G	70	5.629G	71	5.624G	72	5.510G
73	5.276G	74	5.363G	75	5.593G	76	5.491G
77	5.287G	78	5.537G	79	5.645G	80	5.421G
81	5.437G	82	5.470G	83	5.433G	84	5.452G
85	5.318G	86	5.401G	87	5.333G	88	5.458G
89	5.502G	90	5.346G	91	5.577G	92	5.312G
93	5.379G	94	5.585G	95	5.596G	96	5.265G
97	5.697G	98	5.583G	99	5.710G	100	5.616G

Hopping Frequency Sequence Name: HOP_FREQ_SEQ_03							
SEQ#	Frequency (Hz)	SEQ#	Frequency (Hz)	SEQ#	Frequency (Hz)	SEQ#	Frequency (Hz)
1	5.259G	2	5.341G	3	5.520G	4	5.378G
5	5.253G	6	5.412G	7	5.502G	8	5.646G
9	5.637G	10	5.358G	11	5.481G	12	5.681G
13	5.384G	14	5.687G	15	5.469G	16	5.255G
17	5.720G	18	5.552G	19	5.500G	20	5.310G
21	5.648G	22	5.340G	23	5.616G	24	5.320G
25	5.257G	26	5.655G	27	5.409G	28	5.723G
29	5.629G	30	5.659G	31	5.388G	32	5.333G
33	5.330G	34	5.290G	35	5.601G	36	5.489G
37	5.315G	38	5.506G	39	5.654G	40	5.544G
41	5.605G	42	5.519G	43	5.702G	44	5.682G
45	5.539G	46	5.554G	47	5.433G	48	5.416G
49	5.368G	50	5.713G	51	5.307G	52	5.475G
53	5.438G	54	5.621G	55	5.396G	56	5.643G
57	5.533G	58	5.432G	59	5.427G	60	5.547G
61	5.479G	62	5.298G	63	5.599G	64	5.359G
65	5.609G	66	5.575G	67	5.587G	68	5.640G
69	5.724G	70	5.516G	71	5.498G	72	5.623G
73	5.371G	74	5.254G	75	5.518G	76	5.528G
77	5.250G	78	5.497G	79	5.487G	80	5.578G
81	5.465G	82	5.653G	83	5.436G	84	5.586G
85	5.370G	86	5.285G	87	5.443G	88	5.636G
89	5.521G	90	5.451G	91	5.486G	92	5.626G
93	5.582G	94	5.670G	95	5.631G	96	5.686G
97	5.523G	98	5.391G	99	5.633G	100	5.571G

Hopping Frequency Sequence Name: HOP_FREQ_SEQ_04							
SEQ#	Frequency (Hz)	SEQ#	Frequency (Hz)	SEQ#	Frequency (Hz)	SEQ#	Frequency (Hz)
1	5.697G	2	5.646G	3	5.519G	4	5.250G
5	5.624G	6	5.434G	7	5.538G	8	5.345G
9	5.294G	10	5.639G	11	5.643G	12	5.578G
13	5.314G	14	5.435G	15	5.388G	16	5.312G
17	5.554G	18	5.297G	19	5.649G	20	5.556G
21	5.480G	22	5.713G	23	5.723G	24	5.281G
25	5.551G	26	5.594G	27	5.524G	28	5.261G
29	5.302G	30	5.308G	31	5.564G	32	5.317G
33	5.479G	34	5.663G	35	5.506G	36	5.668G
37	5.581G	38	5.402G	39	5.498G	40	5.265G
41	5.543G	42	5.387G	43	5.406G	44	5.253G



45	5.587G	46	5.424G	47	5.501G	48	5.540G
49	5.339G	50	5.376G	51	5.644G	52	5.706G
53	5.536G	54	5.571G	55	5.378G	56	5.666G
57	5.614G	58	5.623G	59	5.346G	60	5.648G
61	5.477G	62	5.459G	63	5.415G	64	5.389G
65	5.534G	66	5.588G	67	5.321G	68	5.675G
69	5.573G	70	5.528G	71	5.315G	72	5.342G
73	5.722G	74	5.613G	75	5.575G	76	5.350G
77	5.617G	78	5.347G	79	5.511G	80	5.386G
81	5.618G	82	5.590G	83	5.412G	84	5.531G
85	5.526G	86	5.444G	87	5.337G	88	5.311G
89	5.711G	90	5.553G	91	5.655G	92	5.392G
93	5.356G	94	5.398G	95	5.658G	96	5.565G
97	5.547G	98	5.560G	99	5.532G	100	5.427G

Hopping Frequency Sequence Name: HOP_FREQ_SEQ_05

SEQ#	Frequency (Hz)	SEQ#	Frequency (Hz)	SEQ#	Frequency (Hz)	SEQ#	Frequency (Hz)
1	5.583G	2	5.464G	3	5.398G	4	5.674G
5	5.267G	6	5.619G	7	5.455G	8	5.336G
9	5.289G	10	5.360G	11	5.628G	12	5.478G
13	5.697G	14	5.309G	15	5.391G	16	5.511G
17	5.579G	18	5.407G	19	5.469G	20	5.264G
21	5.460G	22	5.315G	23	5.265G	24	5.532G
25	5.269G	26	5.707G	27	5.662G	28	5.543G
29	5.323G	30	5.308G	31	5.440G	32	5.537G
33	5.588G	34	5.629G	35	5.276G	36	5.585G
37	5.590G	38	5.375G	39	5.525G	40	5.625G
41	5.638G	42	5.694G	43	5.415G	44	5.293G
45	5.409G	46	5.688G	47	5.290G	48	5.371G
49	5.545G	50	5.365G	51	5.667G	52	5.681G
53	5.661G	54	5.646G	55	5.304G	56	5.430G
57	5.428G	58	5.272G	59	5.595G	60	5.356G
61	5.456G	62	5.294G	63	5.477G	64	5.672G
65	5.488G	66	5.690G	67	5.504G	68	5.372G
69	5.618G	70	5.600G	71	5.435G	72	5.709G
73	5.465G	74	5.682G	75	5.519G	76	5.651G
77	5.458G	78	5.508G	79	5.413G	80	5.277G
81	5.542G	82	5.550G	83	5.405G	84	5.296G
85	5.397G	86	5.724G	87	5.554G	88	5.620G
89	5.591G	90	5.689G	91	5.313G	92	5.563G
93	5.510G	94	5.673G	95	5.374G	96	5.347G
97	5.446G	98	5.719G	99	5.412G	100	5.339G

Hopping Frequency Sequence Name: HOP_FREQ_SEQ_06

SEQ#	Frequency (Hz)	SEQ#	Frequency (Hz)	SEQ#	Frequency (Hz)	SEQ#	Frequency (Hz)
1	5.264G	2	5.330G	3	5.359G	4	5.323G
5	5.458G	6	5.481G	7	5.270G	8	5.718G
9	5.630G	10	5.300G	11	5.635G	12	5.639G
13	5.508G	14	5.573G	15	5.480G	16	5.443G
17	5.608G	18	5.702G	19	5.550G	20	5.607G



21	5.533G	22	5.484G	23	5.697G	24	5.282G
25	5.706G	26	5.577G	27	5.482G	28	5.280G
29	5.664G	30	5.460G	31	5.675G	32	5.293G
33	5.551G	34	5.496G	35	5.578G	36	5.614G
37	5.671G	38	5.407G	39	5.567G	40	5.651G
41	5.687G	42	5.574G	43	5.366G	44	5.700G
45	5.289G	46	5.587G	47	5.568G	48	5.693G
49	5.454G	50	5.467G	51	5.517G	52	5.713G
53	5.427G	54	5.531G	55	5.709G	56	5.254G
57	5.399G	58	5.544G	59	5.613G	60	5.423G
61	5.631G	62	5.647G	63	5.283G	64	5.592G
65	5.561G	66	5.257G	67	5.267G	68	5.356G
69	5.298G	70	5.272G	71	5.381G	72	5.340G
73	5.430G	74	5.701G	75	5.450G	76	5.715G
77	5.518G	78	5.491G	79	5.485G	80	5.625G
81	5.370G	82	5.344G	83	5.317G	84	5.572G
85	5.347G	86	5.579G	87	5.468G	88	5.582G
89	5.307G	90	5.322G	91	5.547G	92	5.360G
93	5.346G	94	5.654G	95	5.353G	96	5.673G
97	5.678G	98	5.365G	99	5.589G	100	5.566G

Hopping Frequency Sequence Name: HOP_FREQ_SEQ_07

SEQ#	Frequency (Hz)	SEQ#	Frequency (Hz)	SEQ#	Frequency (Hz)	SEQ#	Frequency (Hz)
1	5.568G	2	5.375G	3	5.287G	4	5.410G
5	5.615G	6	5.413G	7	5.707G	8	5.504G
9	5.575G	10	5.689G	11	5.339G	12	5.692G
13	5.321G	14	5.483G	15	5.528G	16	5.265G
17	5.354G	18	5.250G	19	5.608G	20	5.502G
21	5.540G	22	5.382G	23	5.432G	24	5.419G
25	5.436G	26	5.532G	27	5.475G	28	5.652G
29	5.581G	30	5.476G	31	5.251G	32	5.597G
33	5.315G	34	5.498G	35	5.595G	36	5.365G
37	5.473G	38	5.719G	39	5.356G	40	5.561G
41	5.588G	42	5.619G	43	5.644G	44	5.585G
45	5.629G	46	5.596G	47	5.349G	48	5.548G
49	5.538G	50	5.281G	51	5.298G	52	5.658G
53	5.381G	54	5.506G	55	5.708G	56	5.626G
57	5.691G	58	5.566G	59	5.523G	60	5.636G
61	5.351G	62	5.627G	63	5.459G	64	5.314G
65	5.330G	66	5.284G	67	5.406G	68	5.555G
69	5.362G	70	5.665G	71	5.461G	72	5.487G
73	5.350G	74	5.326G	75	5.545G	76	5.332G
77	5.418G	78	5.686G	79	5.609G	80	5.616G
81	5.456G	82	5.290G	83	5.547G	84	5.280G
85	5.698G	86	5.646G	87	5.464G	88	5.486G
89	5.449G	90	5.577G	91	5.699G	92	5.268G
93	5.252G	94	5.299G	95	5.573G	96	5.520G
97	5.720G	98	5.515G	99	5.481G	100	5.584G

Hopping Frequency Sequence Name: HOP_FREQ_SEQ_08

SEQ#	Frequency	SEQ#	Frequency	SEQ#	Frequency	SEQ#	Frequency
------	-----------	------	-----------	------	-----------	------	-----------



	(Hz)		(Hz)		(Hz)		(Hz)
1	5.419G	2	5.651G	3	5.587G	4	5.475G
5	5.531G	6	5.406G	7	5.529G	8	5.685G
9	5.415G	10	5.615G	11	5.435G	12	5.448G
13	5.449G	14	5.642G	15	5.673G	16	5.321G
17	5.323G	18	5.450G	19	5.311G	20	5.291G
21	5.585G	22	5.720G	23	5.381G	24	5.315G
25	5.355G	26	5.255G	27	5.368G	28	5.470G
29	5.658G	30	5.341G	31	5.628G	32	5.547G
33	5.483G	34	5.574G	35	5.439G	36	5.640G
37	5.346G	38	5.400G	39	5.604G	40	5.338G
41	5.394G	42	5.491G	43	5.617G	44	5.314G
45	5.686G	46	5.538G	47	5.496G	48	5.570G
49	5.601G	50	5.528G	51	5.489G	52	5.395G
53	5.288G	54	5.567G	55	5.646G	56	5.517G
57	5.667G	58	5.326G	59	5.688G	60	5.532G
61	5.680G	62	5.520G	63	5.251G	64	5.281G
65	5.596G	66	5.633G	67	5.391G	68	5.506G
69	5.440G	70	5.703G	71	5.473G	72	5.369G
73	5.499G	74	5.699G	75	5.566G	76	5.417G
77	5.443G	78	5.385G	79	5.308G	80	5.630G
81	5.322G	82	5.598G	83	5.694G	84	5.600G
85	5.444G	86	5.568G	87	5.330G	88	5.631G
89	5.647G	90	5.627G	91	5.486G	92	5.429G
93	5.676G	94	5.265G	95	5.537G	96	5.515G
97	5.643G	98	5.534G	99	5.285G	100	5.487G

Hopping Frequency Sequence Name: HOP_FREQ_SEQ_09

SEQ#	Frequency (Hz)	SEQ#	Frequency (Hz)	SEQ#	Frequency (Hz)	SEQ#	Frequency (Hz)
1	5.613G	2	5.549G	3	5.388G	4	5.462G
5	5.417G	6	5.250G	7	5.595G	8	5.476G
9	5.341G	10	5.448G	11	5.680G	12	5.457G
13	5.411G	14	5.712G	15	5.340G	16	5.389G
17	5.533G	18	5.390G	19	5.342G	20	5.418G
21	5.375G	22	5.637G	23	5.604G	24	5.703G
25	5.455G	26	5.466G	27	5.553G	28	5.486G
29	5.428G	30	5.438G	31	5.308G	32	5.401G
33	5.351G	34	5.257G	35	5.569G	36	5.368G
37	5.706G	38	5.722G	39	5.652G	40	5.625G
41	5.554G	42	5.561G	43	5.682G	44	5.547G
45	5.286G	46	5.676G	47	5.344G	48	5.721G
49	5.406G	50	5.511G	51	5.657G	52	5.404G
53	5.439G	54	5.551G	55	5.501G	56	5.594G
57	5.562G	58	5.277G	59	5.330G	60	5.645G
61	5.405G	62	5.596G	63	5.556G	64	5.587G
65	5.621G	66	5.437G	67	5.695G	68	5.386G
69	5.445G	70	5.299G	71	5.497G	72	5.332G
73	5.495G	74	5.510G	75	5.436G	76	5.363G
77	5.427G	78	5.370G	79	5.611G	80	5.538G
81	5.444G	82	5.647G	83	5.288G	84	5.294G
85	5.394G	86	5.297G	87	5.624G	88	5.608G



89	5.502G	90	5.334G	91	5.458G	92	5.271G
93	5.609G	94	5.654G	95	5.268G	96	5.315G
97	5.364G	98	5.393G	99	5.564G	100	5.301G

Hopping Frequency Sequence Name: HOP_FREQ_SEQ_10

SEQ#	Frequency (Hz)	SEQ#	Frequency (Hz)	SEQ#	Frequency (Hz)	SEQ#	Frequency (Hz)
1	5.597G	2	5.632G	3	5.272G	4	5.484G
5	5.385G	6	5.630G	7	5.497G	8	5.695G
9	5.329G	10	5.378G	11	5.609G	12	5.437G
13	5.425G	14	5.372G	15	5.504G	16	5.498G
17	5.420G	18	5.338G	19	5.719G	20	5.457G
21	5.312G	22	5.573G	23	5.392G	24	5.618G
25	5.709G	26	5.358G	27	5.460G	28	5.323G
29	5.641G	30	5.300G	31	5.611G	32	5.393G
33	5.688G	34	5.714G	35	5.515G	36	5.551G
37	5.675G	38	5.691G	39	5.465G	40	5.614G
41	5.314G	42	5.315G	43	5.377G	44	5.631G
45	5.439G	46	5.529G	47	5.637G	48	5.493G
49	5.364G	50	5.360G	51	5.623G	52	5.445G
53	5.346G	54	5.390G	55	5.343G	56	5.523G
57	5.407G	58	5.701G	59	5.379G	60	5.251G
61	5.446G	62	5.381G	63	5.670G	64	5.416G
65	5.271G	66	5.265G	67	5.444G	68	5.395G
69	5.408G	70	5.621G	71	5.405G	72	5.499G
73	5.673G	74	5.612G	75	5.697G	76	5.290G
77	5.643G	78	5.710G	79	5.574G	80	5.542G
81	5.649G	82	5.720G	83	5.716G	84	5.353G
85	5.339G	86	5.293G	87	5.543G	88	5.317G
89	5.266G	90	5.495G	91	5.605G	92	5.433G
93	5.316G	94	5.477G	95	5.550G	96	5.514G
97	5.706G	98	5.419G	99	5.656G	100	5.534G

Hopping Frequency Sequence Name: HOP_FREQ_SEQ_11

SEQ#	Frequency (Hz)	SEQ#	Frequency (Hz)	SEQ#	Frequency (Hz)	SEQ#	Frequency (Hz)
1	5.313G	2	5.634G	3	5.624G	4	5.315G
5	5.381G	6	5.252G	7	5.326G	8	5.394G
9	5.511G	10	5.609G	11	5.449G	12	5.446G
13	5.368G	14	5.459G	15	5.581G	16	5.542G
17	5.612G	18	5.708G	19	5.351G	20	5.314G
21	5.504G	22	5.517G	23	5.320G	24	5.691G
25	5.279G	26	5.512G	27	5.579G	28	5.532G
29	5.523G	30	5.276G	31	5.270G	32	5.454G
33	5.567G	34	5.468G	35	5.485G	36	5.415G
37	5.588G	38	5.477G	39	5.365G	40	5.350G
41	5.549G	42	5.349G	43	5.667G	44	5.438G
45	5.258G	46	5.272G	47	5.431G	48	5.464G
49	5.578G	50	5.594G	51	5.656G	52	5.379G
53	5.503G	54	5.539G	55	5.286G	56	5.687G
57	5.679G	58	5.475G	59	5.342G	60	5.301G
61	5.481G	62	5.447G	63	5.668G	64	5.527G



65	5.617G	66	5.585G	67	5.608G	68	5.702G
69	5.310G	70	5.303G	71	5.642G	72	5.640G
73	5.709G	74	5.487G	75	5.404G	76	5.410G
77	5.267G	78	5.614G	79	5.495G	80	5.545G
81	5.416G	82	5.600G	83	5.722G	84	5.664G
85	5.488G	86	5.619G	87	5.699G	88	5.363G
89	5.526G	90	5.639G	91	5.308G	92	5.669G
93	5.396G	94	5.573G	95	5.484G	96	5.713G
97	5.650G	98	5.724G	99	5.572G	100	5.452G

Hopping Frequency Sequence Name: HOP_FREQ_SEQ_12							
SEQ#	Frequency (Hz)	SEQ#	Frequency (Hz)	SEQ#	Frequency (Hz)	SEQ#	Frequency (Hz)
1	5.405G	2	5.688G	3	5.394G	4	5.378G
5	5.476G	6	5.634G	7	5.510G	8	5.474G
9	5.689G	10	5.650G	11	5.552G	12	5.304G
13	5.435G	14	5.359G	15	5.679G	16	5.570G
17	5.597G	18	5.637G	19	5.537G	20	5.534G
21	5.670G	22	5.432G	23	5.449G	24	5.525G
25	5.547G	26	5.499G	27	5.482G	28	5.578G
29	5.546G	30	5.651G	31	5.345G	32	5.555G
33	5.467G	34	5.497G	35	5.508G	36	5.692G
37	5.586G	38	5.667G	39	5.538G	40	5.554G
41	5.644G	42	5.483G	43	5.655G	44	5.270G
45	5.704G	46	5.568G	47	5.316G	48	5.622G
49	5.613G	50	5.444G	51	5.313G	52	5.608G
53	5.687G	54	5.283G	55	5.325G	56	5.329G
57	5.519G	58	5.413G	59	5.709G	60	5.395G
61	5.343G	62	5.363G	63	5.321G	64	5.302G
65	5.423G	66	5.673G	67	5.250G	68	5.603G
69	5.303G	70	5.486G	71	5.408G	72	5.323G
73	5.553G	74	5.296G	75	5.639G	76	5.612G
77	5.626G	78	5.556G	79	5.409G	80	5.494G
81	5.295G	82	5.654G	83	5.706G	84	5.289G
85	5.631G	86	5.376G	87	5.668G	88	5.319G
89	5.657G	90	5.504G	91	5.701G	92	5.579G
93	5.371G	94	5.472G	95	5.260G	96	5.473G
97	5.368G	98	5.454G	99	5.335G	100	5.532G

Hopping Frequency Sequence Name: HOP_FREQ_SEQ_13							
SEQ#	Frequency (Hz)	SEQ#	Frequency (Hz)	SEQ#	Frequency (Hz)	SEQ#	Frequency (Hz)
1	5.533G	2	5.608G	3	5.423G	4	5.405G
5	5.464G	6	5.674G	7	5.403G	8	5.270G
9	5.276G	10	5.437G	11	5.595G	12	5.559G
13	5.625G	14	5.449G	15	5.336G	16	5.281G
17	5.558G	18	5.377G	19	5.615G	20	5.434G
21	5.548G	22	5.310G	23	5.273G	24	5.494G
25	5.716G	26	5.268G	27	5.442G	28	5.536G
29	5.515G	30	5.303G	31	5.598G	32	5.587G
33	5.389G	34	5.670G	35	5.456G	36	5.443G
37	5.258G	38	5.323G	39	5.300G	40	5.410G



41	5.284G	42	5.450G	43	5.510G	44	5.463G
45	5.312G	46	5.697G	47	5.430G	48	5.348G
49	5.375G	50	5.418G	51	5.580G	52	5.655G
53	5.584G	54	5.527G	55	5.455G	56	5.597G
57	5.332G	58	5.591G	59	5.355G	60	5.468G
61	5.500G	62	5.701G	63	5.534G	64	5.390G
65	5.545G	66	5.723G	67	5.353G	68	5.293G
69	5.363G	70	5.280G	71	5.330G	72	5.344G
73	5.384G	74	5.262G	75	5.367G	76	5.404G
77	5.376G	78	5.478G	79	5.588G	80	5.338G
81	5.278G	82	5.622G	83	5.633G	84	5.345G
85	5.516G	86	5.308G	87	5.283G	88	5.552G
89	5.497G	90	5.398G	91	5.365G	92	5.638G
93	5.429G	94	5.474G	95	5.718G	96	5.419G
97	5.717G	98	5.492G	99	5.490G	100	5.413G

Hopping Frequency Sequence Name: HOP_FREQ_SEQ_14							
SEQ#	Frequency (Hz)	SEQ#	Frequency (Hz)	SEQ#	Frequency (Hz)	SEQ#	Frequency (Hz)
1	5.604G	2	5.547G	3	5.448G	4	5.287G
5	5.462G	6	5.636G	7	5.626G	8	5.702G
9	5.440G	10	5.317G	11	5.635G	12	5.491G
13	5.341G	14	5.278G	15	5.378G	16	5.480G
17	5.388G	18	5.335G	19	5.644G	20	5.406G
21	5.266G	22	5.494G	23	5.359G	24	5.684G
25	5.464G	26	5.518G	27	5.548G	28	5.441G
29	5.391G	30	5.348G	31	5.671G	32	5.505G
33	5.419G	34	5.669G	35	5.355G	36	5.582G
37	5.302G	38	5.572G	39	5.639G	40	5.680G
41	5.500G	42	5.399G	43	5.427G	44	5.260G
45	5.517G	46	5.592G	47	5.504G	48	5.433G
49	5.350G	50	5.573G	51	5.652G	52	5.660G
53	5.439G	54	5.537G	55	5.382G	56	5.361G
57	5.513G	58	5.564G	59	5.434G	60	5.653G
61	5.336G	62	5.675G	63	5.485G	64	5.488G
65	5.377G	66	5.601G	67	5.368G	68	5.629G
69	5.630G	70	5.442G	71	5.638G	72	5.651G
73	5.650G	74	5.279G	75	5.386G	76	5.649G
77	5.354G	78	5.724G	79	5.596G	80	5.703G
81	5.369G	82	5.556G	83	5.393G	84	5.529G
85	5.664G	86	5.458G	87	5.476G	88	5.295G
89	5.455G	90	5.436G	91	5.589G	92	5.570G
93	5.255G	94	5.687G	95	5.522G	96	5.257G
97	5.627G	98	5.685G	99	5.337G	100	5.535G

Hopping Frequency Sequence Name: HOP_FREQ_SEQ_15							
SEQ#	Frequency (Hz)	SEQ#	Frequency (Hz)	SEQ#	Frequency (Hz)	SEQ#	Frequency (Hz)
1	5.550G	2	5.281G	3	5.408G	4	5.639G
5	5.711G	6	5.283G	7	5.658G	8	5.534G
9	5.332G	10	5.635G	11	5.350G	12	5.440G
13	5.252G	14	5.660G	15	5.609G	16	5.716G



17	5.379G	18	5.531G	19	5.567G	20	5.480G
21	5.587G	22	5.300G	23	5.378G	24	5.393G
25	5.598G	26	5.514G	27	5.611G	28	5.685G
29	5.453G	30	5.654G	31	5.518G	32	5.466G
33	5.304G	34	5.462G	35	5.262G	36	5.457G
37	5.276G	38	5.543G	39	5.652G	40	5.405G
41	5.718G	42	5.533G	43	5.356G	44	5.388G
45	5.540G	46	5.625G	47	5.461G	48	5.301G
49	5.343G	50	5.313G	51	5.353G	52	5.426G
53	5.499G	54	5.724G	55	5.359G	56	5.719G
57	5.380G	58	5.680G	59	5.308G	60	5.449G
61	5.661G	62	5.295G	63	5.279G	64	5.697G
65	5.362G	66	5.568G	67	5.663G	68	5.369G
69	5.485G	70	5.682G	71	5.659G	72	5.336G
73	5.268G	74	5.287G	75	5.565G	76	5.375G
77	5.520G	78	5.477G	79	5.554G	80	5.486G
81	5.255G	82	5.333G	83	5.479G	84	5.513G
85	5.427G	86	5.387G	87	5.478G	88	5.360G
89	5.608G	90	5.363G	91	5.406G	92	5.674G
93	5.504G	94	5.655G	95	5.664G	96	5.648G
97	5.575G	98	5.481G	99	5.482G	100	5.645G

Hopping Frequency Sequence Name: HOP_FREQ_SEQ_16

SEQ#	Frequency (Hz)	SEQ#	Frequency (Hz)	SEQ#	Frequency (Hz)	SEQ#	Frequency (Hz)
1	5.397G	2	5.414G	3	5.520G	4	5.352G
5	5.628G	6	5.611G	7	5.388G	8	5.359G
9	5.609G	10	5.482G	11	5.654G	12	5.605G
13	5.376G	14	5.561G	15	5.408G	16	5.599G
17	5.581G	18	5.688G	19	5.322G	20	5.343G
21	5.489G	22	5.577G	23	5.554G	24	5.562G
25	5.631G	26	5.680G	27	5.369G	28	5.518G
29	5.380G	30	5.663G	31	5.358G	32	5.685G
33	5.434G	34	5.563G	35	5.513G	36	5.510G
37	5.341G	38	5.350G	39	5.366G	40	5.625G
41	5.717G	42	5.645G	43	5.586G	44	5.607G
45	5.573G	46	5.614G	47	5.303G	48	5.636G
49	5.453G	50	5.535G	51	5.337G	52	5.559G
53	5.403G	54	5.399G	55	5.432G	56	5.629G
57	5.715G	58	5.703G	59	5.576G	60	5.539G
61	5.708G	62	5.689G	63	5.439G	64	5.601G
65	5.537G	66	5.709G	67	5.267G	68	5.405G
69	5.477G	70	5.481G	71	5.579G	72	5.610G
73	5.556G	74	5.638G	75	5.413G	76	5.595G
77	5.558G	78	5.416G	79	5.316G	80	5.368G
81	5.395G	82	5.666G	83	5.304G	84	5.679G
85	5.448G	86	5.411G	87	5.612G	88	5.484G
89	5.409G	90	5.647G	91	5.583G	92	5.490G
93	5.531G	94	5.302G	95	5.355G	96	5.320G
97	5.347G	98	5.268G	99	5.674G	100	5.420G

Hopping Frequency Sequence Name: HOP_FREQ_SEQ_17



SEQ#	Frequency (Hz)	SEQ#	Frequency (Hz)	SEQ#	Frequency (Hz)	SEQ#	Frequency (Hz)
1	5.546G	2	5.453G	3	5.422G	4	5.452G
5	5.279G	6	5.344G	7	5.521G	8	5.677G
9	5.448G	10	5.659G	11	5.424G	12	5.556G
13	5.399G	14	5.401G	15	5.496G	16	5.367G
17	5.558G	18	5.400G	19	5.384G	20	5.266G
21	5.706G	22	5.710G	23	5.366G	24	5.432G
25	5.333G	26	5.451G	27	5.393G	28	5.569G
29	5.268G	30	5.567G	31	5.350G	32	5.663G
33	5.379G	34	5.526G	35	5.711G	36	5.505G
37	5.543G	38	5.256G	39	5.643G	40	5.471G
41	5.694G	42	5.353G	43	5.405G	44	5.388G
45	5.398G	46	5.294G	47	5.351G	48	5.609G
49	5.614G	50	5.349G	51	5.565G	52	5.295G
53	5.597G	54	5.557G	55	5.537G	56	5.547G
57	5.702G	58	5.516G	59	5.446G	60	5.498G
61	5.590G	62	5.560G	63	5.435G	64	5.715G
65	5.718G	66	5.641G	67	5.605G	68	5.678G
69	5.477G	70	5.317G	71	5.575G	72	5.277G
73	5.406G	74	5.672G	75	5.519G	76	5.270G
77	5.427G	78	5.660G	79	5.573G	80	5.331G
81	5.509G	82	5.360G	83	5.684G	84	5.409G
85	5.681G	86	5.371G	87	5.262G	88	5.462G
89	5.473G	90	5.397G	91	5.709G	92	5.383G
93	5.312G	94	5.579G	95	5.434G	96	5.290G
97	5.680G	98	5.673G	99	5.470G	100	5.465G

Hopping Frequency Sequence Name: HOP_FREQ_SEQ_18

SEQ#	Frequency (Hz)	SEQ#	Frequency (Hz)	SEQ#	Frequency (Hz)	SEQ#	Frequency (Hz)
1	5.375G	2	5.631G	3	5.427G	4	5.297G
5	5.411G	6	5.661G	7	5.492G	8	5.530G
9	5.290G	10	5.523G	11	5.644G	12	5.540G
13	5.583G	14	5.624G	15	5.550G	16	5.518G
17	5.667G	18	5.507G	19	5.325G	20	5.314G
21	5.284G	22	5.407G	23	5.653G	24	5.459G
25	5.660G	26	5.312G	27	5.266G	28	5.542G
29	5.609G	30	5.588G	31	5.719G	32	5.471G
33	5.581G	34	5.557G	35	5.502G	36	5.431G
37	5.330G	38	5.677G	39	5.593G	40	5.467G
41	5.291G	42	5.674G	43	5.648G	44	5.689G
45	5.520G	46	5.294G	47	5.313G	48	5.587G
49	5.295G	50	5.443G	51	5.710G	52	5.276G
53	5.532G	54	5.347G	55	5.415G	56	5.519G
57	5.533G	58	5.488G	59	5.633G	60	5.384G
61	5.651G	62	5.268G	63	5.610G	64	5.256G
65	5.394G	66	5.262G	67	5.535G	68	5.537G
69	5.444G	70	5.664G	71	5.331G	72	5.618G
73	5.343G	74	5.595G	75	5.374G	76	5.548G
77	5.675G	78	5.486G	79	5.367G	80	5.487G
81	5.665G	82	5.702G	83	5.470G	84	5.334G



85	5.400G	86	5.450G	87	5.672G	88	5.604G
89	5.642G	90	5.254G	91	5.690G	92	5.489G
93	5.668G	94	5.466G	95	5.279G	96	5.654G
97	5.398G	98	5.531G	99	5.413G	100	5.569G

Hopping Frequency Sequence Name: HOP_FREQ_SEQ_19

SEQ#	Frequency (Hz)	SEQ#	Frequency (Hz)	SEQ#	Frequency (Hz)	SEQ#	Frequency (Hz)
1	5.658G	2	5.344G	3	5.288G	4	5.256G
5	5.499G	6	5.622G	7	5.308G	8	5.568G
9	5.266G	10	5.581G	11	5.700G	12	5.566G
13	5.535G	14	5.303G	15	5.617G	16	5.348G
17	5.486G	18	5.628G	19	5.574G	20	5.496G
21	5.325G	22	5.517G	23	5.416G	24	5.290G
25	5.509G	26	5.386G	27	5.284G	28	5.435G
29	5.264G	30	5.666G	31	5.442G	32	5.385G
33	5.539G	34	5.610G	35	5.699G	36	5.534G
37	5.369G	38	5.493G	39	5.319G	40	5.346G
41	5.408G	42	5.401G	43	5.721G	44	5.433G
45	5.329G	46	5.259G	47	5.607G	48	5.475G
49	5.694G	50	5.466G	51	5.364G	52	5.536G
53	5.323G	54	5.293G	55	5.481G	56	5.620G
57	5.668G	58	5.436G	59	5.562G	60	5.317G
61	5.519G	62	5.652G	63	5.538G	64	5.631G
65	5.276G	66	5.543G	67	5.318G	68	5.313G
69	5.564G	70	5.549G	71	5.612G	72	5.280G
73	5.387G	74	5.648G	75	5.605G	76	5.722G
77	5.683G	78	5.550G	79	5.526G	80	5.465G
81	5.636G	82	5.609G	83	5.596G	84	5.680G
85	5.618G	86	5.627G	87	5.377G	88	5.552G
89	5.714G	90	5.696G	91	5.309G	92	5.667G
93	5.527G	94	5.708G	95	5.614G	96	5.444G
97	5.664G	98	5.370G	99	5.621G	100	5.692G

Hopping Frequency Sequence Name: HOP_FREQ_SEQ_20

SEQ#	Frequency (Hz)	SEQ#	Frequency (Hz)	SEQ#	Frequency (Hz)	SEQ#	Frequency (Hz)
1	5.549G	2	5.341G	3	5.363G	4	5.723G
5	5.383G	6	5.269G	7	5.387G	8	5.651G
9	5.498G	10	5.593G	11	5.439G	12	5.650G
13	5.446G	14	5.584G	15	5.692G	16	5.307G
17	5.596G	18	5.344G	19	5.698G	20	5.635G
21	5.579G	22	5.613G	23	5.394G	24	5.624G
25	5.589G	26	5.568G	27	5.547G	28	5.633G
29	5.420G	30	5.502G	31	5.499G	32	5.475G
33	5.552G	34	5.585G	35	5.661G	36	5.315G
37	5.697G	38	5.417G	39	5.324G	40	5.266G
41	5.591G	42	5.346G	43	5.565G	44	5.575G
45	5.434G	46	5.414G	47	5.505G	48	5.526G
49	5.615G	50	5.693G	51	5.367G	52	5.531G
53	5.586G	54	5.716G	55	5.713G	56	5.366G
57	5.395G	58	5.595G	59	5.458G	60	5.365G



61	5.628G	62	5.519G	63	5.361G	64	5.695G
65	5.469G	66	5.658G	67	5.641G	68	5.322G
69	5.282G	70	5.659G	71	5.309G	72	5.353G
73	5.342G	74	5.554G	75	5.478G	76	5.685G
77	5.401G	78	5.431G	79	5.667G	80	5.580G
81	5.678G	82	5.463G	83	5.273G	84	5.671G
85	5.337G	86	5.564G	87	5.495G	88	5.480G
89	5.368G	90	5.251G	91	5.400G	92	5.662G
93	5.529G	94	5.700G	95	5.509G	96	5.654G
97	5.608G	98	5.296G	99	5.550G	100	5.620G

Hopping Frequency Sequence Name: HOP_FREQ_SEQ_21							
SEQ#	Frequency (Hz)	SEQ#	Frequency (Hz)	SEQ#	Frequency (Hz)	SEQ#	Frequency (Hz)
1	5.447G	2	5.319G	3	5.345G	4	5.308G
5	5.453G	6	5.706G	7	5.364G	8	5.355G
9	5.484G	10	5.404G	11	5.261G	12	5.555G
13	5.588G	14	5.483G	15	5.381G	16	5.252G
17	5.444G	18	5.317G	19	5.594G	20	5.536G
21	5.454G	22	5.556G	23	5.382G	24	5.400G
25	5.318G	26	5.337G	27	5.650G	28	5.295G
29	5.341G	30	5.475G	31	5.704G	32	5.561G
33	5.724G	34	5.395G	35	5.527G	36	5.597G
37	5.332G	38	5.571G	39	5.476G	40	5.312G
41	5.257G	42	5.667G	43	5.608G	44	5.656G
45	5.456G	46	5.524G	47	5.633G	48	5.518G
49	5.428G	50	5.397G	51	5.713G	52	5.451G
53	5.630G	54	5.507G	55	5.702G	56	5.693G
57	5.668G	58	5.438G	59	5.387G	60	5.522G
61	5.492G	62	5.282G	63	5.504G	64	5.351G
65	5.566G	66	5.574G	67	5.443G	68	5.612G
69	5.595G	70	5.532G	71	5.670G	72	5.251G
73	5.586G	74	5.313G	75	5.718G	76	5.433G
77	5.564G	78	5.469G	79	5.560G	80	5.583G
81	5.585G	82	5.550G	83	5.552G	84	5.503G
85	5.493G	86	5.271G	87	5.554G	88	5.462G
89	5.333G	90	5.466G	91	5.348G	92	5.402G
93	5.293G	94	5.413G	95	5.720G	96	5.663G
97	5.372G	98	5.609G	99	5.584G	100	5.708G

Hopping Frequency Sequence Name: HOP_FREQ_SEQ_22							
SEQ#	Frequency (Hz)	SEQ#	Frequency (Hz)	SEQ#	Frequency (Hz)	SEQ#	Frequency (Hz)
1	5.323G	2	5.643G	3	5.703G	4	5.485G
5	5.408G	6	5.683G	7	5.613G	8	5.470G
9	5.418G	10	5.297G	11	5.491G	12	5.640G
13	5.489G	14	5.471G	15	5.293G	16	5.255G
17	5.521G	18	5.664G	19	5.286G	20	5.386G
21	5.658G	22	5.422G	23	5.693G	24	5.263G
25	5.594G	26	5.601G	27	5.544G	28	5.623G
29	5.342G	30	5.605G	31	5.324G	32	5.285G
33	5.438G	34	5.376G	35	5.410G	36	5.629G



37	5.344G	38	5.427G	39	5.278G	40	5.578G
41	5.404G	42	5.395G	43	5.428G	44	5.441G
45	5.425G	46	5.653G	47	5.497G	48	5.358G
49	5.366G	50	5.258G	51	5.405G	52	5.678G
53	5.625G	54	5.326G	55	5.454G	56	5.641G
57	5.572G	58	5.638G	59	5.373G	60	5.389G
61	5.453G	62	5.312G	63	5.301G	64	5.283G
65	5.354G	66	5.515G	67	5.652G	68	5.340G
69	5.295G	70	5.609G	71	5.565G	72	5.464G
73	5.551G	74	5.259G	75	5.519G	76	5.536G
77	5.406G	78	5.488G	79	5.449G	80	5.313G
81	5.685G	82	5.254G	83	5.718G	84	5.371G
85	5.339G	86	5.314G	87	5.457G	88	5.644G
89	5.681G	90	5.436G	91	5.596G	92	5.502G
93	5.284G	94	5.391G	95	5.571G	96	5.481G
97	5.523G	98	5.507G	99	5.635G	100	5.435G

Hopping Frequency Sequence Name: HOP_FREQ_SEQ_23							
SEQ#	Frequency (Hz)	SEQ#	Frequency (Hz)	SEQ#	Frequency (Hz)	SEQ#	Frequency (Hz)
1	5.638G	2	5.382G	3	5.290G	4	5.270G
5	5.518G	6	5.654G	7	5.709G	8	5.399G
9	5.579G	10	5.720G	11	5.551G	12	5.258G
13	5.505G	14	5.719G	15	5.647G	16	5.706G
17	5.280G	18	5.465G	19	5.420G	20	5.386G
21	5.288G	22	5.521G	23	5.282G	24	5.601G
25	5.355G	26	5.255G	27	5.322G	28	5.568G
29	5.499G	30	5.459G	31	5.628G	32	5.488G
33	5.503G	34	5.649G	35	5.326G	36	5.563G
37	5.319G	38	5.624G	39	5.407G	40	5.472G
41	5.653G	42	5.425G	43	5.271G	44	5.519G
45	5.573G	46	5.434G	47	5.495G	48	5.291G
49	5.307G	50	5.526G	51	5.643G	52	5.523G
53	5.335G	54	5.485G	55	5.672G	56	5.422G
57	5.631G	58	5.325G	59	5.435G	60	5.388G
61	5.473G	62	5.626G	63	5.583G	64	5.713G
65	5.332G	66	5.492G	67	5.410G	68	5.663G
69	5.404G	70	5.400G	71	5.622G	72	5.350G
73	5.268G	74	5.639G	75	5.416G	76	5.359G
77	5.655G	78	5.692G	79	5.301G	80	5.536G
81	5.651G	82	5.496G	83	5.584G	84	5.507G
85	5.697G	86	5.373G	87	5.668G	88	5.595G
89	5.531G	90	5.594G	91	5.367G	92	5.337G
93	5.442G	94	5.600G	95	5.380G	96	5.602G
97	5.664G	98	5.582G	99	5.660G	100	5.636G

Hopping Frequency Sequence Name: HOP_FREQ_SEQ_24							
SEQ#	Frequency (Hz)	SEQ#	Frequency (Hz)	SEQ#	Frequency (Hz)	SEQ#	Frequency (Hz)
1	5.427G	2	5.389G	3	5.332G	4	5.304G
5	5.559G	6	5.656G	7	5.359G	8	5.639G
9	5.343G	10	5.286G	11	5.693G	12	5.409G



13	5.277G	14	5.314G	15	5.479G	16	5.641G
17	5.560G	18	5.330G	19	5.602G	20	5.407G
21	5.406G	22	5.271G	23	5.496G	24	5.596G
25	5.488G	26	5.266G	27	5.386G	28	5.606G
29	5.712G	30	5.459G	31	5.695G	32	5.551G
33	5.521G	34	5.524G	35	5.651G	36	5.441G
37	5.689G	38	5.575G	39	5.476G	40	5.682G
41	5.339G	42	5.280G	43	5.612G	44	5.679G
45	5.470G	46	5.400G	47	5.364G	48	5.434G
49	5.687G	50	5.584G	51	5.519G	52	5.707G
53	5.416G	54	5.565G	55	5.509G	56	5.283G
57	5.474G	58	5.573G	59	5.350G	60	5.543G
61	5.507G	62	5.527G	63	5.298G	64	5.506G
65	5.502G	66	5.261G	67	5.278G	68	5.404G
69	5.432G	70	5.449G	71	5.379G	72	5.484G
73	5.419G	74	5.461G	75	5.272G	76	5.621G
77	5.401G	78	5.351G	79	5.366G	80	5.576G
81	5.437G	82	5.380G	83	5.326G	84	5.529G
85	5.340G	86	5.331G	87	5.327G	88	5.704G
89	5.535G	90	5.629G	91	5.315G	92	5.269G
93	5.444G	94	5.647G	95	5.253G	96	5.540G
97	5.514G	98	5.393G	99	5.482G	100	5.640G

Hopping Frequency Sequence Name: HOP_FREQ_SEQ_25

SEQ#	Frequency (Hz)	SEQ#	Frequency (Hz)	SEQ#	Frequency (Hz)	SEQ#	Frequency (Hz)
1	5.530G	2	5.436G	3	5.270G	4	5.724G
5	5.334G	6	5.554G	7	5.273G	8	5.330G
9	5.589G	10	5.454G	11	5.661G	12	5.283G
13	5.309G	14	5.423G	15	5.258G	16	5.617G
17	5.594G	18	5.575G	19	5.418G	20	5.528G
21	5.387G	22	5.261G	23	5.394G	24	5.349G
25	5.491G	26	5.465G	27	5.614G	28	5.340G
29	5.541G	30	5.711G	31	5.475G	32	5.398G
33	5.353G	34	5.677G	35	5.517G	36	5.277G
37	5.621G	38	5.598G	39	5.574G	40	5.298G
41	5.308G	42	5.419G	43	5.566G	44	5.252G
45	5.415G	46	5.265G	47	5.420G	48	5.579G
49	5.681G	50	5.409G	51	5.607G	52	5.684G
53	5.613G	54	5.569G	55	5.297G	56	5.545G
57	5.649G	58	5.628G	59	5.331G	60	5.557G
61	5.670G	62	5.290G	63	5.383G	64	5.633G
65	5.668G	66	5.507G	67	5.710G	68	5.345G
69	5.404G	70	5.323G	71	5.355G	72	5.336G
73	5.533G	74	5.300G	75	5.666G	76	5.286G
77	5.293G	78	5.388G	79	5.650G	80	5.699G
81	5.672G	82	5.494G	83	5.489G	84	5.455G
85	5.448G	86	5.368G	87	5.359G	88	5.701G
89	5.417G	90	5.657G	91	5.577G	92	5.674G
93	5.720G	94	5.715G	95	5.462G	96	5.487G
97	5.482G	98	5.332G	99	5.291G	100	5.529G



Hopping Frequency Sequence Name: HOP_FREQ_SEQ_26							
SEQ#	Frequency (Hz)	SEQ#	Frequency (Hz)	SEQ#	Frequency (Hz)	SEQ#	Frequency (Hz)
1	5.660G	2	5.309G	3	5.397G	4	5.504G
5	5.595G	6	5.362G	7	5.280G	8	5.620G
9	5.640G	10	5.506G	11	5.257G	12	5.312G
13	5.592G	14	5.695G	15	5.256G	16	5.313G
17	5.338G	18	5.503G	19	5.258G	20	5.717G
21	5.279G	22	5.337G	23	5.261G	24	5.597G
25	5.461G	26	5.515G	27	5.471G	28	5.468G
29	5.490G	30	5.440G	31	5.645G	32	5.548G
33	5.419G	34	5.713G	35	5.614G	36	5.431G
37	5.534G	38	5.355G	39	5.343G	40	5.514G
41	5.600G	42	5.602G	43	5.494G	44	5.516G
45	5.606G	46	5.692G	47	5.321G	48	5.360G
49	5.691G	50	5.659G	51	5.579G	52	5.675G
53	5.406G	54	5.703G	55	5.711G	56	5.327G
57	5.422G	58	5.574G	59	5.333G	60	5.332G
61	5.603G	62	5.512G	63	5.393G	64	5.642G
65	5.283G	66	5.438G	67	5.263G	68	5.487G
69	5.479G	70	5.331G	71	5.721G	72	5.382G
73	5.290G	74	5.544G	75	5.410G	76	5.559G
77	5.653G	78	5.334G	79	5.292G	80	5.421G
81	5.622G	82	5.469G	83	5.303G	84	5.400G
85	5.665G	86	5.463G	87	5.464G	88	5.377G
89	5.253G	90	5.598G	91	5.367G	92	5.616G
93	5.537G	94	5.568G	95	5.501G	96	5.295G
97	5.719G	98	5.708G	99	5.552G	100	5.529G

Hopping Frequency Sequence Name: HOP_FREQ_SEQ_27							
SEQ#	Frequency (Hz)	SEQ#	Frequency (Hz)	SEQ#	Frequency (Hz)	SEQ#	Frequency (Hz)
1	5.432G	2	5.512G	3	5.581G	4	5.526G
5	5.252G	6	5.662G	7	5.546G	8	5.345G
9	5.297G	10	5.569G	11	5.516G	12	5.385G
13	5.335G	14	5.507G	15	5.537G	16	5.277G
17	5.489G	18	5.251G	19	5.557G	20	5.344G
21	5.465G	22	5.606G	23	5.417G	24	5.601G
25	5.518G	26	5.264G	27	5.442G	28	5.487G
29	5.536G	30	5.682G	31	5.591G	32	5.284G
33	5.564G	34	5.336G	35	5.629G	36	5.602G
37	5.595G	38	5.685G	39	5.611G	40	5.654G
41	5.604G	42	5.312G	43	5.325G	44	5.414G
45	5.703G	46	5.676G	47	5.576G	48	5.467G
49	5.437G	50	5.563G	51	5.459G	52	5.261G
53	5.582G	54	5.354G	55	5.597G	56	5.508G
57	5.367G	58	5.441G	59	5.370G	60	5.450G
61	5.386G	62	5.452G	63	5.362G	64	5.286G
65	5.391G	66	5.371G	67	5.424G	68	5.400G
69	5.719G	70	5.471G	71	5.625G	72	5.493G
73	5.381G	74	5.623G	75	5.283G	76	5.448G
77	5.485G	78	5.435G	79	5.580G	80	5.627G



81	5.532G	82	5.360G	83	5.350G	84	5.566G
85	5.579G	86	5.531G	87	5.460G	88	5.357G
89	5.279G	90	5.673G	91	5.705G	92	5.292G
93	5.401G	94	5.647G	95	5.691G	96	5.276G
97	5.499G	98	5.340G	99	5.697G	100	5.358G

Hopping Frequency Sequence Name: HOP_FREQ_SEQ_28							
SEQ#	Frequency (Hz)	SEQ#	Frequency (Hz)	SEQ#	Frequency (Hz)	SEQ#	Frequency (Hz)
1	5.606G	2	5.575G	3	5.645G	4	5.360G
5	5.510G	6	5.684G	7	5.607G	8	5.411G
9	5.272G	10	5.382G	11	5.651G	12	5.446G
13	5.405G	14	5.354G	15	5.380G	16	5.508G
17	5.445G	18	5.542G	19	5.369G	20	5.398G
21	5.494G	22	5.418G	23	5.449G	24	5.407G
25	5.273G	26	5.316G	27	5.644G	28	5.527G
29	5.663G	30	5.443G	31	5.372G	32	5.503G
33	5.476G	34	5.264G	35	5.576G	36	5.561G
37	5.375G	38	5.328G	39	5.634G	40	5.438G
41	5.406G	42	5.605G	43	5.422G	44	5.298G
45	5.352G	46	5.338G	47	5.408G	48	5.341G
49	5.685G	50	5.252G	51	5.334G	52	5.462G
53	5.465G	54	5.285G	55	5.588G	56	5.619G
57	5.365G	58	5.466G	59	5.357G	60	5.613G
61	5.461G	62	5.626G	63	5.676G	64	5.262G
65	5.441G	66	5.424G	67	5.578G	68	5.253G
69	5.479G	70	5.521G	71	5.499G	72	5.519G
73	5.679G	74	5.482G	75	5.571G	76	5.322G
77	5.617G	78	5.278G	79	5.430G	80	5.563G
81	5.695G	82	5.419G	83	5.533G	84	5.379G
85	5.546G	86	5.371G	87	5.459G	88	5.713G
89	5.267G	90	5.609G	91	5.290G	92	5.329G
93	5.534G	94	5.310G	95	5.447G	96	5.432G
97	5.475G	98	5.370G	99	5.565G	100	5.353G

Hopping Frequency Sequence Name: HOP_FREQ_SEQ_29							
SEQ#	Frequency (Hz)	SEQ#	Frequency (Hz)	SEQ#	Frequency (Hz)	SEQ#	Frequency (Hz)
1	5.342G	2	5.667G	3	5.612G	4	5.697G
5	5.623G	6	5.353G	7	5.369G	8	5.501G
9	5.603G	10	5.591G	11	5.536G	12	5.691G
13	5.541G	14	5.415G	15	5.435G	16	5.423G
17	5.457G	18	5.255G	19	5.542G	20	5.462G
21	5.488G	22	5.346G	23	5.297G	24	5.642G
25	5.447G	26	5.355G	27	5.276G	28	5.292G
29	5.329G	30	5.382G	31	5.351G	32	5.469G
33	5.651G	34	5.652G	35	5.314G	36	5.374G
37	5.421G	38	5.261G	39	5.516G	40	5.681G
41	5.354G	42	5.323G	43	5.303G	44	5.386G
45	5.481G	46	5.585G	47	5.626G	48	5.578G
49	5.436G	50	5.538G	51	5.473G	52	5.324G
53	5.260G	54	5.616G	55	5.452G	56	5.474G



57	5.708G	58	5.270G	59	5.345G	60	5.486G
61	5.325G	62	5.530G	63	5.493G	64	5.390G
65	5.312G	66	5.615G	67	5.460G	68	5.699G
69	5.640G	70	5.311G	71	5.327G	72	5.401G
73	5.571G	74	5.717G	75	5.552G	76	5.337G
77	5.253G	78	5.269G	79	5.604G	80	5.639G
81	5.634G	82	5.367G	83	5.633G	84	5.455G
85	5.587G	86	5.678G	87	5.577G	88	5.683G
89	5.413G	90	5.706G	91	5.308G	92	5.561G
93	5.362G	94	5.500G	95	5.631G	96	5.282G
97	5.335G	98	5.554G	99	5.620G	100	5.326G

Hopping Frequency Sequence Name: HOP_FREQ_SEQ_30							
SEQ#	Frequency (Hz)	SEQ#	Frequency (Hz)	SEQ#	Frequency (Hz)	SEQ#	Frequency (Hz)
1	5.719G	2	5.266G	3	5.648G	4	5.488G
5	5.586G	6	5.485G	7	5.405G	8	5.324G
9	5.569G	10	5.308G	11	5.372G	12	5.354G
13	5.658G	14	5.353G	15	5.355G	16	5.699G
17	5.694G	18	5.502G	19	5.403G	20	5.611G
21	5.653G	22	5.704G	23	5.370G	24	5.298G
25	5.676G	26	5.724G	27	5.395G	28	5.686G
29	5.465G	30	5.555G	31	5.397G	32	5.278G
33	5.542G	34	5.637G	35	5.406G	36	5.610G
37	5.582G	38	5.701G	39	5.484G	40	5.490G
41	5.579G	42	5.536G	43	5.273G	44	5.359G
45	5.520G	46	5.289G	47	5.430G	48	5.544G
49	5.723G	50	5.373G	51	5.413G	52	5.604G
53	5.425G	54	5.570G	55	5.321G	56	5.618G
57	5.705G	58	5.527G	59	5.626G	60	5.691G
61	5.432G	62	5.717G	63	5.415G	64	5.661G
65	5.629G	66	5.385G	67	5.600G	68	5.602G
69	5.486G	70	5.288G	71	5.692G	72	5.254G
73	5.512G	74	5.601G	75	5.526G	76	5.718G
77	5.709G	78	5.475G	79	5.639G	80	5.443G
81	5.287G	82	5.649G	83	5.330G	84	5.263G
85	5.603G	86	5.292G	87	5.561G	88	5.460G
89	5.378G	90	5.553G	91	5.257G	92	5.379G
93	5.327G	94	5.571G	95	5.643G	96	5.340G
97	5.365G	98	5.262G	99	5.503G	100	5.255G



B.3 The Long Pulse Radar Pattern

Long Pulse Radar Test Signal						
Test Signal Name: LP_Signal_01						
Number of Bursts in Trial: 16						
Burst	Pulses per Burst	Chrip (Hz)	Pulse Width (s)	Pulse 1 to 2 Spacing (s)	Pulse 2 to 3 Spacing (s)	Start Location (s)
1	2	13M	57.2u	1.781m	-	309.5m
2	2	15M	54.9u	1.113m	-	92.68m
3	2	20M	83.0u	1.470m	-	618.6m
4	1	7M	97.8u	-	-	196.9m
5	1	16M	67.8u	-	-	254.3m
6	3	11M	81.1u	1.179m	1.587m	712.8m
7	1	16M	72.8u	-	-	125.8m
8	2	12M	81.0u	1.121m	-	150.3m
9	3	15M	68.7u	1.487m	1.026m	218.5m
10	3	12M	83.4u	1.714m	1.583m	288.6m
11	1	6M	62.7u	-	-	331.0m
12	2	7M	50.9u	1.773m	-	735.0m
13	1	14M	91.4u	-	-	435.3m
14	1	14M	98.3u	-	-	593.9m
15	1	17M	61.5u	-	-	398.8m
16	1	14M	72.3u	-	-	645.1m

Long Pulse Radar Test Signal						
Test Signal Name: LP_Signal_02						
Number of Bursts in Trial: 11						
Burst	Pulses per Burst	Chrip (Hz)	Pulse Width (s)	Pulse 1 to 2 Spacing (s)	Pulse 2 to 3 Spacing (s)	Start Location (s)
1	1	15M	63.9u	-	-	593.7m
2	2	12M	70.5u	1.379m	-	431.6m
3	2	9M	82.5u	1.579m	-	1.066
4	3	14M	94.9u	1.834m	1.127m	582.0m
5	3	19M	85.7u	1.385m	1.514m	278.8m
6	2	14M	93.5u	1.592m	-	148.4m
7	1	17M	83.0u	-	-	688.9m
8	2	8M	57.6u	1.249m	-	1.051
9	2	19M	86.9u	1.598m	-	359.3m
10	1	17M	77.0u	-	-	248.8m
11	2	10M	62.4u	1.752m	-	634.4m

Long Pulse Radar Test Signal						
Test Signal Name: LP_Signal_03						
Number of Bursts in Trial: 12						
Burst	Pulses per Burst	Chrip (Hz)	Pulse Width (s)	Pulse 1 to 2 Spacing (s)	Pulse 2 to 3 Spacing (s)	Start Location (s)
1	2	13M	90.9u	1.043m	-	523.4m
2	2	13M	54.8u	996.2u	-	372.0m
3	2	19M	60.0u	1.615m	-	875.6m
4	2	9M	78.3u	1.241m	-	576.7m
5	2	7M	59.3u	1.001m	-	748.8m



6	2	11M	93.8u	1.684m	-	813.1m
7	2	15M	93.2u	1.170m	-	136.0m
8	2	15M	50.4u	1.882m	-	383.9m
9	2	11M	68.5u	965.5u	-	73.82m
10	1	6M	55.5u	-	-	935.0m
11	2	14M	93.0u	1.519m	-	22.72m
12	1	16M	93.3u	-	-	502.1m

Long Pulse Radar Test Signal
 Test Signal Name: LP_Signal_04
 Number of Bursts in Trial: 13

Burst	Pulses per Burst	Chrip (Hz)	Pulse Width (s)	Pulse 1 to 2 Spacing (s)	Pulse 2 to 3 Spacing (s)	Start Location (s)
1	2	16M	62.9u	1.730m	-	692.3m
2	1	13M	56.5u	-	-	101.4m
3	1	12M	94.0u	-	-	871.6m
4	3	17M	95.9u	1.884m	1.476m	94.98m
5	2	15M	99.2u	1.858m	-	82.72m
6	3	12M	82.1u	1.008m	1.548m	804.5m
7	1	7M	71.1u	-	-	376.1m
8	3	14M	72.8u	1.151m	1.836m	593.7m
9	2	8M	82.9u	1.534m	-	728.6m
10	2	12M	55.4u	1.053m	-	813.2m
11	2	17M	90.0u	1.465m	-	366.2m
12	2	16M	56.4u	1.048m	-	547.1m
13	1	20M	56.8u	-	-	253.3m

Long Pulse Radar Test Signal
 Test Signal Name: LP_Signal_05
 Number of Bursts in Trial: 9

Burst	Pulses per Burst	Chrip (Hz)	Pulse Width (s)	Pulse 1 to 2 Spacing (s)	Pulse 2 to 3 Spacing (s)	Start Location (s)
1	2	13M	66.6u	1.117m	-	602.5m
2	2	17M	78.6u	1.442m	-	1.208
3	3	18M	60.2u	1.678m	1.894m	1.153
4	2	12M	69.4u	1.387m	-	70.11m
5	2	7M	62.0u	1.335m	-	705.0m
6	1	14M	90.1u	-	-	247.5m
7	3	17M	65.9u	1.194m	1.878m	1.122
8	2	14M	53.2u	1.507m	-	54.80m
9	3	19M	97.1u	1.406m	1.647m	309.8m

Long Pulse Radar Test Signal
 Test Signal Name: LP_Signal_06
 Number of Bursts in Trial: 15

Burst	Pulses per Burst	Chrip (Hz)	Pulse Width (s)	Pulse 1 to 2 Spacing (s)	Pulse 2 to 3 Spacing (s)	Start Location (s)
1	2	16M	94.6u	1.669m	-	189.4m
2	1	16M	68.3u	-	-	590.1m
3	2	13M	97.0u	1.078m	-	473.0m
4	2	11M	61.2u	1.673m	-	786.6m
5	2	10M	61.3u	1.243m	-	258.6m
6	3	10M	53.0u	1.081m	1.230m	145.5m

7	2	13M	58.1u	1.039m	-	679.4m
8	1	7M	51.1u	-	-	229.9m
9	2	19M	62.6u	1.060m	-	699.5m
10	2	13M	64.2u	1.106m	-	731.5m
11	1	11M	91.7u	-	-	195.6m
12	3	11M	67.5u	1.372m	1.146m	445.1m
13	2	10M	78.3u	1.502m	-	54.18m
14	1	6M	83.1u	-	-	69.17m
15	3	7M	81.0u	1.349m	1.662m	132.9m

Long Pulse Radar Test Signal
 Test Signal Name: LP_Signal_07
 Number of Bursts in Trial: 8

Burst	Pulses per Burst	Chrip (Hz)	Pulse Width (s)	Pulse 1 to 2 Spacing (s)	Pulse 2 to 3 Spacing (s)	Start Location (s)
1	1	7M	84.9u	-	-	864.8m
2	2	8M	98.4u	930.6u	-	1.110
3	1	6M	97.4u	-	-	1.085
4	1	9M	84.9u	-	-	343.2m
5	1	12M	96.7u	-	-	326.1m
6	2	8M	60.6u	1.921m	-	1.027
7	2	11M	58.0u	1.414m	-	236.3m
8	3	8M	87.9u	1.198m	933.1u	230.5m

Long Pulse Radar Test Signal
 Test Signal Name: LP_Signal_08
 Number of Bursts in Trial: 15

Burst	Pulses per Burst	Chrip (Hz)	Pulse Width (s)	Pulse 1 to 2 Spacing (s)	Pulse 2 to 3 Spacing (s)	Start Location (s)
1	3	7M	59.9u	1.607m	1.860m	334.0m
2	2	12M	82.0u	1.275m	-	612.8m
3	3	18M	59.9u	1.079m	1.069m	313.3m
4	2	17M	98.3u	1.136m	-	76.22m
5	1	13M	75.4u	-	-	474.6m
6	1	15M	72.8u	-	-	436.8m
7	3	9M	67.1u	1.668m	1.867m	60.65m
8	3	14M	52.1u	1.305m	1.576m	569.8m
9	2	18M	51.6u	1.350m	-	657.6m
10	2	18M	93.1u	1.576m	-	768.2m
11	3	15M	98.0u	1.628m	1.325m	356.6m
12	3	15M	65.9u	1.158m	1.280m	464.9m
13	1	18M	67.1u	-	-	627.2m
14	3	15M	88.3u	1.115m	1.577m	661.0m
15	1	18M	69.0u	-	-	526.3m

Long Pulse Radar Test Signal
 Test Signal Name: LP_Signal_09
 Number of Bursts in Trial: 9

Burst	Pulses per Burst	Chrip (Hz)	Pulse Width (s)	Pulse 1 to 2 Spacing (s)	Pulse 2 to 3 Spacing (s)	Start Location (s)
1	2	13M	82.0u	1.428m	-	57.09m
2	2	6M	52.5u	983.5u	-	12.28m
3	3	10M	70.0u	1.285m	1.389m	458.1m



4	2	16M	62.7u	1.199m	-	909.1m
5	2	20M	92.1u	1.456m	-	281.4m
6	1	19M	86.6u	-	-	951.9m
7	2	6M	50.4u	1.451m	-	1.219
8	1	13M	78.6u	-	-	1.266
9	2	19M	66.5u	1.878m	-	564.5m

Long Pulse Radar Test Signal

Test Signal Name: LP_Signal_10

Number of Bursts in Trial: 17

Burst	Pulses per Burst	Chrip (Hz)	Pulse Width (s)	Pulse 1 to 2 Spacing (s)	Pulse 2 to 3 Spacing (s)	Start Location (s)
1	2	13M	98.2u	1.580m	-	371.1m
2	2	15M	69.5u	1.455m	-	168.1m
3	1	16M	96.3u	-	-	24.60m
4	3	10M	90.7u	1.049m	1.174m	446.8m
5	1	18M	53.9u	-	-	450.6m
6	2	16M	65.5u	1.030m	-	120.1m
7	3	8M	59.1u	1.453m	1.694m	159.9m
8	1	18M	54.2u	-	-	553.8m
9	2	6M	86.9u	1.832m	-	686.8m
10	3	7M	71.1u	1.545m	1.720m	194.9m
11	3	19M	52.6u	1.900m	1.182m	539.3m
12	1	10M	65.3u	-	-	661.2m
13	2	8M	61.5u	1.233m	-	145.2m
14	2	9M	98.3u	927.7u	-	424.3m
15	2	12M	89.5u	1.483m	-	84.21m
16	1	13M	63.6u	-	-	115.9m
17	2	14M	50.2u	1.248m	-	182.2m

Long Pulse Radar Test Signal

Test Signal Name: LP_Signal_11

Number of Bursts in Trial: 13

Burst	Pulses per Burst	Chrip (Hz)	Pulse Width (s)	Pulse 1 to 2 Spacing (s)	Pulse 2 to 3 Spacing (s)	Start Location (s)
1	1	15M	87.6u	-	-	180.8m
2	3	11M	67.2u	1.212m	972.8u	516.5m
3	2	8M	86.8u	1.396m	-	192.1m
4	2	15M	65.9u	1.817m	-	157.8m
5	2	8M	68.5u	1.264m	-	40.72m
6	1	20M	55.1u	-	-	356.3m
7	2	8M	68.2u	1.509m	-	247.9m
8	1	14M	75.0u	-	-	184.5m
9	1	18M	96.8u	-	-	606.6m
10	3	7M	58.5u	1.447m	1.695m	419.2m
11	3	14M	77.4u	1.749m	983.6u	839.6m
12	3	12M	54.7u	1.708m	1.613m	501.6m
13	2	13M	93.8u	974.2u	-	756.7m

Long Pulse Radar Test Signal

Test Signal Name: LP_Signal_12

Number of Bursts in Trial: 16



Burst	Pulses per Burst	Chrip (Hz)	Pulse Width (s)	Pulse 1 to 2 Spacing (s)	Pulse 2 to 3 Spacing (s)	Start Location (s)
1	2	7M	53.2u	1.417m	-	132.2m
2	3	9M	96.3u	1.020m	1.285m	656.2m
3	1	7M	74.8u	-	-	89.36m
4	2	5M	95.9u	1.209m	-	307.8m
5	2	16M	95.2u	1.443m	-	618.9m
6	3	15M	75.9u	1.798m	1.585m	500.3m
7	2	5M	74.9u	1.702m	-	524.2m
8	1	15M	91.2u	-	-	738.9m
9	2	10M	55.0u	1.920m	-	289.8m
10	2	12M	70.7u	1.731m	-	504.1m
11	1	9M	76.5u	-	-	243.5m
12	1	6M	65.4u	-	-	503.4m
13	1	7M	94.4u	-	-	217.4m
14	1	11M	77.5u	-	-	479.8m
15	2	13M	66.0u	1.500m	-	638.9m
16	2	6M	78.4u	1.187m	-	35.07m

Long Pulse Radar Test Signal

Test Signal Name: LP_Signal_13

Number of Bursts in Trial: 11

Burst	Pulses per Burst	Chrip (Hz)	Pulse Width (s)	Pulse 1 to 2 Spacing (s)	Pulse 2 to 3 Spacing (s)	Start Location (s)
1	2	12M	94.6u	1.816m	-	32.63m
2	3	9M	51.0u	1.278m	1.541m	930.4m
3	1	17M	75.5u	-	-	487.8m
4	1	7M	84.1u	-	-	678.7m
5	2	10M	65.3u	1.276m	-	410.2m
6	2	7M	87.3u	995.7u	-	428.0m
7	1	15M	96.6u	-	-	865.9m
8	2	19M	73.2u	1.328m	-	570.9m
9	1	12M	82.7u	-	-	103.2m
10	1	16M	99.0u	-	-	997.9m
11	1	19M	94.1u	-	-	874.3m

Long Pulse Radar Test Signal

Test Signal Name: LP_Signal_14

Number of Bursts in Trial: 19

Burst	Pulses per Burst	Chrip (Hz)	Pulse Width (s)	Pulse 1 to 2 Spacing (s)	Pulse 2 to 3 Spacing (s)	Start Location (s)
1	2	6M	83.2u	1.640m	-	140.5m
2	2	13M	97.8u	1.429m	-	385.6m
3	1	16M	50.5u	-	-	344.0m
4	2	20M	86.0u	1.205m	-	606.2m
5	1	6M	99.9u	-	-	406.2m
6	1	7M	68.2u	-	-	626.0m
7	3	7M	66.5u	1.284m	1.742m	255.3m
8	2	15M	97.3u	1.402m	-	19.27m
9	1	17M	69.9u	-	-	505.9m
10	2	7M	90.6u	1.646m	-	596.4m
11	2	11M	86.3u	980.7u	-	557.3m



12	3	8M	80.3u	1.665m	1.064m	186.2m
13	3	9M	82.8u	1.826m	1.506m	366.4m
14	3	18M	64.7u	1.595m	1.459m	490.4m
15	2	12M	79.1u	1.744m	-	560.3m
16	2	15M	94.0u	1.353m	-	556.2m
17	1	7M	86.9u	-	-	31.95m
18	2	15M	86.2u	972.8u	-	295.0m
19	2	14M	74.7u	1.367m	-	118.5m

Long Pulse Radar Test Signal
 Test Signal Name: LP_Signal_15
 Number of Bursts in Trial: 10

Burst	Pulses per Burst	Chrip (Hz)	Pulse Width (s)	Pulse 1 to 2 Spacing (s)	Pulse 2 to 3 Spacing (s)	Start Location (s)
1	2	16M	82.1u	1.888m	-	523.0m
2	1	12M	68.4u	-	-	52.27m
3	2	19M	88.5u	1.874m	-	506.3m
4	2	11M	66.0u	1.662m	-	628.3m
5	2	15M	82.3u	1.401m	-	1.180
6	2	8M	97.0u	908.0u	-	476.1m
7	2	7M	65.4u	1.934m	-	62.16m
8	2	10M	83.2u	1.505m	-	311.9m
9	3	17M	87.5u	995.5u	1.125m	1.180
10	3	11M	80.6u	1.602m	1.455m	525.1m

Long Pulse Radar Test Signal
 Test Signal Name: LP_Signal_16
 Number of Bursts in Trial: 13

Burst	Pulses per Burst	Chrip (Hz)	Pulse Width (s)	Pulse 1 to 2 Spacing (s)	Pulse 2 to 3 Spacing (s)	Start Location (s)
1	3	11M	55.6u	1.262m	1.458m	876.0m
2	3	15M	92.0u	1.778m	1.279m	758.8m
3	1	15M	71.0u	-	-	599.4m
4	3	15M	95.7u	1.616m	1.231m	658.5m
5	1	12M	50.4u	-	-	88.52m
6	2	18M	69.6u	1.654m	-	317.2m
7	3	14M	92.0u	1.195m	1.880m	710.7m
8	1	13M	77.9u	-	-	802.3m
9	2	6M	50.4u	1.743m	-	7.491m
10	3	18M	66.2u	1.037m	1.029m	726.5m
11	2	13M	56.2u	1.255m	-	459.5m
12	1	16M	54.7u	-	-	844.1m
13	2	14M	94.8u	1.436m	-	630.8m

Long Pulse Radar Test Signal
 Test Signal Name: LP_Signal_17
 Number of Bursts in Trial: 15

Burst	Pulses per Burst	Chrip (Hz)	Pulse Width (s)	Pulse 1 to 2 Spacing (s)	Pulse 2 to 3 Spacing (s)	Start Location (s)
1	2	7M	73.3u	1.524m	-	26.18m
2	2	13M	60.7u	1.365m	-	20.30m
3	2	9M	81.6u	1.355m	-	165.6m
4	1	14M	84.6u	-	-	128.2m



5	3	15M	50.7u	1.941m	965.3u	208.2m
6	2	19M	78.0u	1.124m	-	771.3m
7	1	9M	80.5u	-	-	13.88m
8	3	14M	56.3u	1.884m	1.020m	637.4m
9	2	13M	78.2u	1.316m	-	612.0m
10	2	6M	58.7u	1.240m	-	253.0m
11	2	8M	84.8u	945.2u	-	323.6m
12	1	17M	56.1u	-	-	10.65m
13	1	10M	97.7u	-	-	602.8m
14	3	17M	64.3u	1.650m	1.170m	178.8m
15	2	11M	95.4u	1.740m	-	66.27m

Long Pulse Radar Test Signal
 Test Signal Name: LP_Signal_18
 Number of Bursts in Trial: 20

Burst	Pulses per Burst	Chrip (Hz)	Pulse Width (s)	Pulse 1 to 2 Spacing (s)	Pulse 2 to 3 Spacing (s)	Start Location (s)
1	3	14M	95.1u	1.036m	1.851m	360.5m
2	1	8M	56.9u	-	-	113.8m
3	3	13M	57.9u	1.030m	1.818m	97.64m
4	3	13M	88.6u	1.368m	1.864m	354.0m
5	1	15M	58.8u	-	-	444.8m
6	2	17M	82.0u	1.889m	-	150.7m
7	2	12M	63.4u	1.021m	-	237.1m
8	2	12M	75.6u	1.447m	-	23.94m
9	2	6M	59.6u	1.833m	-	6.386m
10	1	10M	83.6u	-	-	435.8m
11	3	19M	67.5u	1.156m	1.291m	406.6m
12	2	16M	73.4u	1.461m	-	167.4m
13	2	9M	99.0u	1.308m	-	297.3m
14	1	13M	91.4u	-	-	525.3m
15	2	20M	99.5u	964.5u	-	260.3m
16	1	9M	93.9u	-	-	139.1m
17	2	17M	88.2u	1.496m	-	388.9m
18	1	10M	50.8u	-	-	465.0m
19	2	10M	55.5u	1.051m	-	93.33m
20	3	9M	70.9u	1.747m	1.526m	289.9m

Long Pulse Radar Test Signal
 Test Signal Name: LP_Signal_19
 Number of Bursts in Trial: 19

Burst	Pulses per Burst	Chrip (Hz)	Pulse Width (s)	Pulse 1 to 2 Spacing (s)	Pulse 2 to 3 Spacing (s)	Start Location (s)
1	1	17M	99.0u	-	-	580.4m
2	2	18M	59.6u	1.155m	-	372.1m
3	1	5M	69.6u	-	-	591.5m
4	1	15M	62.8u	-	-	459.4m
5	1	15M	58.3u	-	-	495.9m
6	2	19M	90.5u	1.072m	-	1.813m
7	1	18M	80.4u	-	-	506.7m
8	2	14M	72.0u	1.715m	-	222.7m
9	2	14M	54.2u	1.603m	-	397.6m



10	3	10M	53.5u	1.080m	1.435m	596.8m
11	3	17M	87.0u	1.549m	939.0u	72.78m
12	3	17M	59.5u	1.860m	1.432m	400.0m
13	3	10M	88.1u	1.836m	1.902m	313.6m
14	3	9M	83.8u	1.571m	1.062m	225.5m
15	1	10M	70.8u	-	-	567.4m
16	1	18M	63.1u	-	-	24.86m
17	3	16M	97.7u	1.261m	1.231m	150.5m
18	2	16M	91.6u	1.367m	-	426.2m
19	1	14M	84.3u	-	-	598.7m

Long Pulse Radar Test Signal
 Test Signal Name: LP_Signal_20
 Number of Bursts in Trial: 17

Burst	Pulses per Burst	Chrip (Hz)	Pulse Width (s)	Pulse 1 to 2 Spacing (s)	Pulse 2 to 3 Spacing (s)	Start Location (s)
1	2	19M	73.0u	975.0u	-	156.2m
2	3	12M	56.8u	990.2u	1.032m	398.5m
3	2	6M	57.3u	1.358m	-	434.8m
4	2	17M	94.0u	1.571m	-	646.2m
5	2	11M	61.0u	1.225m	-	545.4m
6	1	15M	98.6u	-	-	668.5m
7	3	10M	90.0u	1.002m	1.414m	649.7m
8	2	10M	51.8u	1.766m	-	699.4m
9	2	15M	96.7u	1.392m	-	384.3m
10	1	16M	71.8u	-	-	251.9m
11	1	6M	72.5u	-	-	694.2m
12	3	15M	79.3u	1.513m	1.913m	498.8m
13	2	19M	86.7u	1.357m	-	1.502m
14	2	16M	57.3u	1.457m	-	197.7m
15	2	19M	89.8u	1.883m	-	62.02m
16	3	10M	76.9u	1.362m	1.001m	574.7m
17	1	7M	61.6u	-	-	13.84m

Long Pulse Radar Test Signal
 Test Signal Name: LP_Signal_21
 Number of Bursts in Trial: 10

Burst	Pulses per Burst	Chrip (Hz)	Pulse Width (s)	Pulse 1 to 2 Spacing (s)	Pulse 2 to 3 Spacing (s)	Start Location (s)
1	2	10M	51.2u	1.670m	-	469.2m
2	2	6M	92.3u	1.111m	-	751.3m
3	2	6M	79.2u	1.274m	-	668.3m
4	2	13M	98.2u	1.805m	-	719.5m
5	2	10M	72.8u	1.104m	-	731.5m
6	2	8M	90.4u	1.840m	-	377.0m
7	1	8M	84.5u	-	-	879.4m
8	1	7M	54.5u	-	-	1.182
9	3	17M	99.3u	1.035m	1.322m	49.29m
10	2	15M	93.4u	1.890m	-	930.5m

Long Pulse Radar Test Signal
 Test Signal Name: LP_Signal_22



Number of Bursts in Trial: 17

Burst	Pulses per Burst	Chrip (Hz)	Pulse Width (s)	Pulse 1 to 2 Spacing (s)	Pulse 2 to 3 Spacing (s)	Start Location (s)
1	3	15M	68.0u	1.493m	1.204m	277.2m
2	2	5M	68.6u	1.877m	-	379.7m
3	2	16M	59.8u	1.381m	-	401.7m
4	2	7M	78.6u	1.880m	-	408.6m
5	2	6M	94.3u	1.073m	-	448.6m
6	2	14M	62.1u	1.233m	-	315.6m
7	2	10M	65.1u	1.109m	-	247.6m
8	2	6M	78.0u	1.177m	-	77.36m
9	2	19M	70.3u	1.877m	-	140.0m
10	2	18M	71.2u	1.121m	-	107.3m
11	1	5M	99.9u	-	-	444.0m
12	3	13M	71.7u	1.501m	1.026m	131.5m
13	1	13M	92.9u	-	-	655.3m
14	2	8M	92.2u	1.202m	-	60.62m
15	2	12M	55.0u	1.441m	-	60.17m
16	2	19M	85.3u	1.133m	-	327.6m
17	3	8M	53.7u	1.164m	1.602m	38.32m

Long Pulse Radar Test Signal
 Test Signal Name: LP_Signal_23
 Number of Bursts in Trial: 9

Burst	Pulses per Burst	Chrip (Hz)	Pulse Width (s)	Pulse 1 to 2 Spacing (s)	Pulse 2 to 3 Spacing (s)	Start Location (s)
1	2	7M	53.7u	1.025m	-	761.4m
2	2	19M	76.2u	1.411m	-	610.6m
3	1	13M	93.9u	-	-	63.21m
4	1	6M	73.2u	-	-	151.1m
5	3	16M	57.3u	1.515m	1.550m	604.9m
6	3	18M	60.4u	1.890m	1.171m	987.9m
7	2	17M	88.2u	1.105m	-	17.27m
8	3	16M	69.3u	1.411m	1.041m	751.0m
9	2	10M	73.0u	1.510m	-	477.0m

Long Pulse Radar Test Signal
 Test Signal Name: LP_Signal_24
 Number of Bursts in Trial: 18

Burst	Pulses per Burst	Chrip (Hz)	Pulse Width (s)	Pulse 1 to 2 Spacing (s)	Pulse 2 to 3 Spacing (s)	Start Location (s)
1	2	17M	78.6u	1.628m	-	556.1m
2	2	17M	98.9u	1.161m	-	203.3m
3	3	13M	91.5u	1.435m	1.486m	646.5m
4	2	5M	96.5u	1.280m	-	383.4m
5	3	19M	93.6u	1.867m	1.697m	475.3m
6	1	7M	59.3u	-	-	461.6m
7	3	20M	75.1u	1.393m	1.812m	114.4m
8	2	16M	95.6u	1.469m	-	95.01m
9	2	15M	74.2u	1.082m	-	179.9m
10	3	19M	81.3u	1.798m	1.815m	179.0m
11	1	20M	80.3u	-	-	439.1m



12	1	10M	95.9u	-	-	456.0m
13	2	5M	53.5u	1.859m	-	14.55m
14	2	7M	63.0u	1.730m	-	265.0m
15	3	18M	66.8u	1.141m	1.028m	524.6m
16	1	12M	71.5u	-	-	632.5m
17	1	8M	93.9u	-	-	178.2m
18	1	7M	80.8u	-	-	588.9m

Long Pulse Radar Test Signal
 Test Signal Name: LP_Signal_25
 Number of Bursts in Trial: 9

Burst	Pulses per Burst	Chrip (Hz)	Pulse Width (s)	Pulse 1 to 2 Spacing (s)	Pulse 2 to 3 Spacing (s)	Start Location (s)
1	3	13M	51.5u	1.393m	1.600m	912.9m
2	3	11M	90.5u	1.612m	1.554m	667.8m
3	2	15M	51.4u	970.6u	-	402.4m
4	2	16M	54.1u	1.477m	-	334.7m
5	2	14M	63.0u	1.925m	-	131.3m
6	3	9M	66.1u	1.725m	1.483m	534.6m
7	3	14M	58.8u	1.781m	1.845m	537.7m
8	3	17M	73.7u	1.860m	946.3u	320.1m
9	2	10M	58.0u	1.182m	-	322.9m

Long Pulse Radar Test Signal
 Test Signal Name: LP_Signal_26
 Number of Bursts in Trial: 11

Burst	Pulses per Burst	Chrip (Hz)	Pulse Width (s)	Pulse 1 to 2 Spacing (s)	Pulse 2 to 3 Spacing (s)	Start Location (s)
1	2	15M	66.9u	1.187m	-	944.6m
2	2	16M	94.1u	1.420m	-	479.0m
3	3	13M	67.7u	1.216m	1.059m	1.007
4	2	19M	79.8u	1.770m	-	234.6m
5	3	7M	59.1u	1.439m	1.401m	762.7m
6	1	13M	70.3u	-	-	916.2m
7	1	7M	84.6u	-	-	102.3m
8	3	16M	86.0u	1.906m	1.165m	979.3m
9	3	6M	72.3u	1.846m	943.7u	436.9m
10	3	8M	63.8u	1.837m	1.740m	980.9m
11	2	15M	57.1u	1.475m	-	471.5m

Long Pulse Radar Test Signal
 Test Signal Name: LP_Signal_27
 Number of Bursts in Trial: 19

Burst	Pulses per Burst	Chrip (Hz)	Pulse Width (s)	Pulse 1 to 2 Spacing (s)	Pulse 2 to 3 Spacing (s)	Start Location (s)
1	1	10M	90.2u	-	-	85.26m
2	2	6M	86.1u	1.732m	-	464.5m
3	2	15M	90.4u	1.328m	-	62.63m
4	1	11M	90.4u	-	-	435.5m
5	2	13M	82.3u	1.207m	-	159.1m
6	1	11M	97.8u	-	-	324.8m
7	3	17M	87.3u	996.7u	1.747m	548.2m
8	3	9M	66.0u	1.634m	1.394m	248.7m



9	2	16M	88.2u	1.524m	-	221.5m
10	3	5M	97.0u	1.220m	1.787m	163.5m
11	3	13M	58.1u	1.209m	1.337m	562.6m
12	1	13M	63.0u	-	-	137.4m
13	3	8M	72.0u	1.746m	1.281m	239.1m
14	3	20M	77.0u	1.555m	1.392m	181.8m
15	1	9M	61.4u	-	-	570.9m
16	2	6M	92.4u	998.6u	-	231.9m
17	2	8M	54.9u	1.744m	-	411.5m
18	2	13M	80.5u	1.063m	-	281.6m
19	1	6M	85.4u	-	-	600.7m

Long Pulse Radar Test Signal
 Test Signal Name: LP_Signal_28
 Number of Bursts in Trial: 19

Burst	Pulses per Burst	Chrip (Hz)	Pulse Width (s)	Pulse 1 to 2 Spacing (s)	Pulse 2 to 3 Spacing (s)	Start Location (s)
1	2	7M	71.2u	1.534m	-	250.1m
2	2	16M	94.8u	1.676m	-	496.5m
3	2	18M	52.3u	1.319m	-	299.3m
4	2	8M	60.7u	1.409m	-	161.5m
5	2	11M	86.6u	1.439m	-	79.87m
6	2	6M	89.2u	1.005m	-	498.3m
7	3	6M	80.9u	1.415m	1.285m	492.6m
8	1	6M	51.1u	-	-	120.4m
9	3	11M	79.9u	1.717m	946.1u	237.2m
10	2	13M	62.6u	990.4u	-	37.58m
11	3	12M	89.7u	1.700m	1.901m	205.1m
12	2	19M	86.5u	1.902m	-	541.4m
13	2	17M	87.3u	959.7u	-	382.6m
14	1	7M	60.0u	-	-	251.4m
15	2	13M	55.9u	1.160m	-	12.57m
16	3	18M	87.1u	1.452m	1.659m	449.1m
17	2	12M	58.2u	1.210m	-	259.9m
18	2	16M	80.5u	1.732m	-	217.6m
19	2	10M	86.1u	1.721m	-	515.7m

Long Pulse Radar Test Signal
 Test Signal Name: LP_Signal_29
 Number of Bursts in Trial: 14

Burst	Pulses per Burst	Chrip (Hz)	Pulse Width (s)	Pulse 1 to 2 Spacing (s)	Pulse 2 to 3 Spacing (s)	Start Location (s)
1	2	7M	79.7u	1.816m	-	147.1m
2	2	17M	87.2u	1.202m	-	325.1m
3	3	10M	69.5u	1.331m	1.276m	118.6m
4	2	18M	84.9u	923.1u	-	161.4m
5	1	19M	73.9u	-	-	116.2m
6	1	12M	66.4u	-	-	149.7m
7	2	8M	72.6u	1.622m	-	210.3m
8	3	18M	59.5u	1.801m	1.063m	646.7m
9	1	6M	73.8u	-	-	680.5m
10	2	10M	79.4u	1.067m	-	127.3m



11	2	8M	89.7u	1.741m	-	810.4m
12	2	18M	76.3u	1.564m	-	152.5m
13	3	10M	81.4u	980.6u	1.174m	470.4m
14	2	12M	99.7u	1.864m	-	688.0m

Long Pulse Radar Test Signal
 Test Signal Name: LP_Signal_30
 Number of Bursts in Trial: 16

Burst	Pulses per Burst	Chrip (Hz)	Pulse Width (s)	Pulse 1 to 2 Spacing (s)	Pulse 2 to 3 Spacing (s)	Start Location (s)
1	1	14M	82.1u	-	-	252.6m
2	2	16M	70.2u	1.068m	-	574.7m
3	3	9M	82.7u	1.327m	1.386m	129.8m
4	1	17M	61.9u	-	-	262.2m
5	1	9M	74.6u	-	-	501.4m
6	2	6M	91.1u	1.649m	-	343.3m
7	3	15M	68.2u	1.182m	1.922m	489.2m
8	2	19M	65.5u	1.384m	-	137.2m
9	3	10M	97.9u	1.608m	1.779m	188.4m
10	2	12M	89.7u	1.096m	-	562.2m
11	3	5M	61.7u	1.874m	994.3u	579.2m
12	2	11M	79.2u	1.006m	-	693.0m
13	2	13M	56.2u	968.8u	-	461.2m
14	1	10M	73.7u	-	-	47.03m
15	2	6M	53.7u	1.087m	-	235.6m
16	3	8M	96.8u	1.867m	1.361m	614.3m



B.4 The Frequency Hopping Radar Pattern

Hopping Frequency Sequence Name: HOP_FREQ_SEQ_01							
SEQ#	Frequency (Hz)	SEQ#	Frequency (Hz)	SEQ#	Frequency (Hz)	SEQ#	Frequency (Hz)
1	5.466G	2	5.324G	3	5.319G	4	5.511G
5	5.450G	6	5.381G	7	5.280G	8	5.342G
9	5.656G	10	5.313G	11	5.436G	12	5.554G
13	5.264G	14	5.299G	15	5.361G	16	5.566G
17	5.521G	18	5.575G	19	5.558G	20	5.645G
21	5.709G	22	5.260G	23	5.276G	24	5.548G
25	5.503G	26	5.685G	27	5.540G	28	5.527G
29	5.513G	30	5.634G	31	5.322G	32	5.266G
33	5.287G	34	5.482G	35	5.642G	36	5.393G
37	5.565G	38	5.437G	39	5.352G	40	5.483G
41	5.616G	42	5.428G	43	5.408G	44	5.479G
45	5.668G	46	5.292G	47	5.318G	48	5.444G
49	5.261G	50	5.357G	51	5.386G	52	5.719G
53	5.661G	54	5.320G	55	5.432G	56	5.480G
57	5.321G	58	5.445G	59	5.331G	60	5.285G
61	5.596G	62	5.516G	63	5.536G	64	5.683G
65	5.323G	66	5.628G	67	5.435G	68	5.696G
69	5.582G	70	5.603G	71	5.345G	72	5.557G
73	5.281G	74	5.464G	75	5.715G	76	5.309G
77	5.518G	78	5.658G	79	5.571G	80	5.278G
81	5.463G	82	5.507G	83	5.475G	84	5.403G
85	5.589G	86	5.353G	87	5.665G	88	5.412G
89	5.625G	90	5.370G	91	5.268G	92	5.666G
93	5.374G	94	5.362G	95	5.710G	96	5.443G
97	5.314G	98	5.499G	99	5.327G	100	5.390G

Hopping Frequency Sequence Name: HOP_FREQ_SEQ_02							
SEQ#	Frequency (Hz)	SEQ#	Frequency (Hz)	SEQ#	Frequency (Hz)	SEQ#	Frequency (Hz)
1	5.434G	2	5.717G	3	5.720G	4	5.273G
5	5.366G	6	5.396G	7	5.480G	8	5.346G
9	5.721G	10	5.356G	11	5.569G	12	5.598G
13	5.716G	14	5.629G	15	5.357G	16	5.645G
17	5.344G	18	5.416G	19	5.592G	20	5.516G
21	5.611G	22	5.538G	23	5.589G	24	5.676G
25	5.485G	26	5.693G	27	5.696G	28	5.481G
29	5.488G	30	5.578G	31	5.533G	32	5.417G
33	5.473G	34	5.540G	35	5.517G	36	5.663G
37	5.587G	38	5.331G	39	5.628G	40	5.499G
41	5.469G	42	5.714G	43	5.339G	44	5.351G
45	5.601G	46	5.579G	47	5.536G	48	5.688G
49	5.271G	50	5.515G	51	5.447G	52	5.311G
53	5.702G	54	5.503G	55	5.722G	56	5.441G
57	5.519G	58	5.320G	59	5.456G	60	5.703G
61	5.394G	62	5.337G	63	5.636G	64	5.319G
65	5.291G	66	5.370G	67	5.707G	68	5.487G



69	5.619G	70	5.476G	71	5.349G	72	5.450G
73	5.288G	74	5.326G	75	5.614G	76	5.582G
77	5.509G	78	5.621G	79	5.680G	80	5.710G
81	5.399G	82	5.269G	83	5.363G	84	5.409G
85	5.683G	86	5.336G	87	5.558G	88	5.588G
89	5.535G	90	5.282G	91	5.700G	92	5.461G
93	5.420G	94	5.650G	95	5.642G	96	5.596G
97	5.605G	98	5.512G	99	5.254G	100	5.272G

Hopping Frequency Sequence Name: HOP_FREQ_SEQ_03

SEQ#	Frequency (Hz)	SEQ#	Frequency (Hz)	SEQ#	Frequency (Hz)	SEQ#	Frequency (Hz)
1	5.311G	2	5.603G	3	5.381G	4	5.621G
5	5.671G	6	5.365G	7	5.567G	8	5.617G
9	5.284G	10	5.462G	11	5.271G	12	5.483G
13	5.571G	14	5.558G	15	5.674G	16	5.355G
17	5.666G	18	5.511G	19	5.691G	20	5.723G
21	5.709G	22	5.493G	23	5.705G	24	5.330G
25	5.645G	26	5.572G	27	5.544G	28	5.335G
29	5.282G	30	5.605G	31	5.422G	32	5.542G
33	5.487G	34	5.358G	35	5.302G	36	5.501G
37	5.518G	38	5.489G	39	5.323G	40	5.660G
41	5.257G	42	5.342G	43	5.478G	44	5.443G
45	5.382G	46	5.280G	47	5.689G	48	5.523G
49	5.598G	50	5.349G	51	5.629G	52	5.379G
53	5.266G	54	5.673G	55	5.413G	56	5.278G
57	5.407G	58	5.453G	59	5.434G	60	5.618G
61	5.255G	62	5.416G	63	5.576G	64	5.259G
65	5.339G	66	5.262G	67	5.268G	68	5.372G
69	5.522G	70	5.456G	71	5.399G	72	5.384G
73	5.430G	74	5.497G	75	5.553G	76	5.309G
77	5.480G	78	5.394G	79	5.515G	80	5.521G
81	5.502G	82	5.437G	83	5.463G	84	5.333G
85	5.664G	86	5.585G	87	5.715G	88	5.647G
89	5.488G	90	5.685G	91	5.654G	92	5.514G
93	5.584G	94	5.579G	95	5.668G	96	5.359G
97	5.406G	98	5.669G	99	5.391G	100	5.469G

Hopping Frequency Sequence Name: HOP_FREQ_SEQ_04

SEQ#	Frequency (Hz)	SEQ#	Frequency (Hz)	SEQ#	Frequency (Hz)	SEQ#	Frequency (Hz)
1	5.383G	2	5.614G	3	5.457G	4	5.408G
5	5.445G	6	5.579G	7	5.488G	8	5.360G
9	5.441G	10	5.329G	11	5.675G	12	5.342G
13	5.478G	14	5.332G	15	5.362G	16	5.508G
17	5.413G	18	5.626G	19	5.576G	20	5.463G
21	5.507G	22	5.557G	23	5.637G	24	5.616G
25	5.497G	26	5.357G	27	5.505G	28	5.584G
29	5.591G	30	5.404G	31	5.602G	32	5.696G
33	5.287G	34	5.631G	35	5.554G	36	5.391G
37	5.645G	38	5.435G	39	5.376G	40	5.503G
41	5.504G	42	5.344G	43	5.574G	44	5.598G



45	5.674G	46	5.570G	47	5.707G	48	5.715G
49	5.380G	50	5.434G	51	5.617G	52	5.697G
53	5.390G	54	5.378G	55	5.353G	56	5.392G
57	5.491G	58	5.339G	59	5.524G	60	5.673G
61	5.701G	62	5.411G	63	5.292G	64	5.422G
65	5.475G	66	5.255G	67	5.586G	68	5.566G
69	5.307G	70	5.426G	71	5.372G	72	5.291G
73	5.459G	74	5.687G	75	5.639G	76	5.264G
77	5.506G	78	5.577G	79	5.270G	80	5.451G
81	5.515G	82	5.257G	83	5.593G	84	5.684G
85	5.708G	86	5.650G	87	5.714G	88	5.569G
89	5.619G	90	5.394G	91	5.449G	92	5.282G
93	5.309G	94	5.250G	95	5.615G	96	5.722G
97	5.280G	98	5.671G	99	5.430G	100	5.288G

Hopping Frequency Sequence Name: HOP_FREQ_SEQ_05

SEQ#	Frequency (Hz)	SEQ#	Frequency (Hz)	SEQ#	Frequency (Hz)	SEQ#	Frequency (Hz)
1	5.540G	2	5.678G	3	5.632G	4	5.282G
5	5.346G	6	5.477G	7	5.681G	8	5.317G
9	5.401G	10	5.459G	11	5.570G	12	5.697G
13	5.493G	14	5.512G	15	5.350G	16	5.468G
17	5.612G	18	5.511G	19	5.710G	20	5.589G
21	5.712G	22	5.413G	23	5.628G	24	5.611G
25	5.692G	26	5.520G	27	5.586G	28	5.361G
29	5.504G	30	5.715G	31	5.463G	32	5.443G
33	5.343G	34	5.461G	35	5.457G	36	5.674G
37	5.475G	38	5.462G	39	5.680G	40	5.331G
41	5.577G	42	5.623G	43	5.676G	44	5.530G
45	5.315G	46	5.304G	47	5.635G	48	5.372G
49	5.709G	50	5.666G	51	5.608G	52	5.711G
53	5.378G	54	5.566G	55	5.657G	56	5.410G
57	5.349G	58	5.536G	59	5.544G	60	5.708G
61	5.348G	62	5.525G	63	5.297G	64	5.495G
65	5.355G	66	5.675G	67	5.326G	68	5.557G
69	5.300G	70	5.419G	71	5.567G	72	5.460G
73	5.394G	74	5.655G	75	5.423G	76	5.649G
77	5.516G	78	5.578G	79	5.448G	80	5.287G
81	5.660G	82	5.531G	83	5.524G	84	5.367G
85	5.634G	86	5.267G	87	5.280G	88	5.626G
89	5.560G	90	5.552G	91	5.319G	92	5.627G
93	5.293G	94	5.596G	95	5.695G	96	5.381G
97	5.483G	98	5.436G	99	5.467G	100	5.703G

Hopping Frequency Sequence Name: HOP_FREQ_SEQ_06

SEQ#	Frequency (Hz)	SEQ#	Frequency (Hz)	SEQ#	Frequency (Hz)	SEQ#	Frequency (Hz)
1	5.486G	2	5.640G	3	5.481G	4	5.626G
5	5.375G	6	5.570G	7	5.562G	8	5.645G
9	5.271G	10	5.412G	11	5.267G	12	5.459G
13	5.557G	14	5.644G	15	5.538G	16	5.623G
17	5.609G	18	5.698G	19	5.556G	20	5.455G



21	5.286G	22	5.277G	23	5.460G	24	5.520G
25	5.683G	26	5.613G	27	5.303G	28	5.371G
29	5.332G	30	5.573G	31	5.280G	32	5.413G
33	5.677G	34	5.553G	35	5.563G	36	5.605G
37	5.334G	38	5.643G	39	5.678G	40	5.504G
41	5.253G	42	5.611G	43	5.684G	44	5.308G
45	5.319G	46	5.317G	47	5.340G	48	5.342G
49	5.453G	50	5.365G	51	5.580G	52	5.606G
53	5.675G	54	5.551G	55	5.312G	56	5.702G
57	5.432G	58	5.262G	59	5.258G	60	5.374G
61	5.416G	62	5.345G	63	5.532G	64	5.409G
65	5.621G	66	5.299G	67	5.361G	68	5.442G
69	5.336G	70	5.435G	71	5.703G	72	5.485G
73	5.705G	74	5.278G	75	5.616G	76	5.395G
77	5.636G	78	5.458G	79	5.327G	80	5.471G
81	5.687G	82	5.574G	83	5.297G	84	5.376G
85	5.540G	86	5.530G	87	5.546G	88	5.291G
89	5.469G	90	5.454G	91	5.669G	92	5.290G
93	5.630G	94	5.260G	95	5.338G	96	5.496G
97	5.569G	98	5.400G	99	5.356G	100	5.391G

Hopping Frequency Sequence Name: HOP_FREQ_SEQ_07							
SEQ#	Frequency (Hz)	SEQ#	Frequency (Hz)	SEQ#	Frequency (Hz)	SEQ#	Frequency (Hz)
1	5.484G	2	5.270G	3	5.266G	4	5.693G
5	5.485G	6	5.515G	7	5.438G	8	5.325G
9	5.292G	10	5.460G	11	5.397G	12	5.689G
13	5.445G	14	5.686G	15	5.703G	16	5.377G
17	5.723G	18	5.718G	19	5.608G	20	5.411G
21	5.494G	22	5.251G	23	5.300G	24	5.431G
25	5.636G	26	5.522G	27	5.554G	28	5.672G
29	5.436G	30	5.708G	31	5.276G	32	5.374G
33	5.577G	34	5.324G	35	5.406G	36	5.656G
37	5.676G	38	5.507G	39	5.383G	40	5.631G
41	5.623G	42	5.322G	43	5.697G	44	5.311G
45	5.548G	46	5.336G	47	5.343G	48	5.696G
49	5.429G	50	5.562G	51	5.642G	52	5.440G
53	5.265G	54	5.452G	55	5.396G	56	5.449G
57	5.535G	58	5.442G	59	5.624G	60	5.402G
61	5.614G	62	5.540G	63	5.622G	64	5.537G
65	5.401G	66	5.408G	67	5.710G	68	5.701G
69	5.472G	70	5.552G	71	5.486G	72	5.335G
73	5.600G	74	5.349G	75	5.570G	76	5.621G
77	5.386G	78	5.412G	79	5.261G	80	5.473G
81	5.629G	82	5.707G	83	5.497G	84	5.582G
85	5.471G	86	5.583G	87	5.376G	88	5.373G
89	5.457G	90	5.655G	91	5.258G	92	5.590G
93	5.688G	94	5.667G	95	5.692G	96	5.332G
97	5.451G	98	5.700G	99	5.593G	100	5.521G

Hopping Frequency Sequence Name: HOP_FREQ_SEQ_08							
SEQ#	Frequency	SEQ#	Frequency	SEQ#	Frequency	SEQ#	Frequency



	(Hz)		(Hz)		(Hz)		(Hz)
1	5.519G	2	5.465G	3	5.260G	4	5.568G
5	5.608G	6	5.637G	7	5.627G	8	5.376G
9	5.601G	10	5.369G	11	5.633G	12	5.621G
13	5.418G	14	5.467G	15	5.520G	16	5.576G
17	5.551G	18	5.665G	19	5.388G	20	5.352G
21	5.297G	22	5.476G	23	5.510G	24	5.255G
25	5.653G	26	5.417G	27	5.424G	28	5.371G
29	5.588G	30	5.493G	31	5.719G	32	5.579G
33	5.362G	34	5.298G	35	5.546G	36	5.642G
37	5.455G	38	5.430G	39	5.533G	40	5.365G
41	5.615G	42	5.342G	43	5.724G	44	5.475G
45	5.366G	46	5.263G	47	5.605G	48	5.699G
49	5.572G	50	5.674G	51	5.438G	52	5.589G
53	5.687G	54	5.434G	55	5.586G	56	5.374G
57	5.511G	58	5.396G	59	5.402G	60	5.392G
61	5.682G	62	5.449G	63	5.420G	64	5.380G
65	5.575G	66	5.347G	67	5.661G	68	5.602G
69	5.303G	70	5.626G	71	5.323G	72	5.312G
73	5.466G	74	5.433G	75	5.673G	76	5.515G
77	5.425G	78	5.379G	79	5.351G	80	5.483G
81	5.302G	82	5.507G	83	5.671G	84	5.585G
85	5.334G	86	5.522G	87	5.527G	88	5.315G
89	5.384G	90	5.316G	91	5.353G	92	5.538G
93	5.332G	94	5.253G	95	5.689G	96	5.289G
97	5.599G	98	5.716G	99	5.328G	100	5.548G

Hopping Frequency Sequence Name: HOP_FREQ_SEQ_09

SEQ#	Frequency (Hz)	SEQ#	Frequency (Hz)	SEQ#	Frequency (Hz)	SEQ#	Frequency (Hz)
1	5.508G	2	5.529G	3	5.713G	4	5.519G
5	5.542G	6	5.312G	7	5.352G	8	5.503G
9	5.401G	10	5.699G	11	5.682G	12	5.711G
13	5.290G	14	5.276G	15	5.612G	16	5.315G
17	5.361G	18	5.541G	19	5.590G	20	5.395G
21	5.478G	22	5.386G	23	5.688G	24	5.678G
25	5.625G	26	5.443G	27	5.445G	28	5.335G
29	5.385G	30	5.639G	31	5.485G	32	5.720G
33	5.722G	34	5.719G	35	5.480G	36	5.628G
37	5.659G	38	5.424G	39	5.554G	40	5.295G
41	5.553G	42	5.334G	43	5.271G	44	5.603G
45	5.715G	46	5.416G	47	5.544G	48	5.341G
49	5.559G	50	5.328G	51	5.454G	52	5.607G
53	5.505G	54	5.540G	55	5.320G	56	5.259G
57	5.436G	58	5.390G	59	5.677G	60	5.464G
61	5.577G	62	5.531G	63	5.498G	64	5.712G
65	5.511G	66	5.675G	67	5.382G	68	5.660G
69	5.549G	70	5.623G	71	5.299G	72	5.333G
73	5.419G	74	5.321G	75	5.522G	76	5.661G
77	5.264G	78	5.504G	79	5.506G	80	5.567G
81	5.350G	82	5.423G	83	5.363G	84	5.348G
85	5.285G	86	5.604G	87	5.291G	88	5.310G



89	5.253G	90	5.406G	91	5.326G	92	5.592G
93	5.370G	94	5.704G	95	5.558G	96	5.379G
97	5.413G	98	5.428G	99	5.338G	100	5.644G

Hopping Frequency Sequence Name: HOP_FREQ_SEQ_10

SEQ#	Frequency (Hz)	SEQ#	Frequency (Hz)	SEQ#	Frequency (Hz)	SEQ#	Frequency (Hz)
1	5.388G	2	5.656G	3	5.462G	4	5.570G
5	5.373G	6	5.590G	7	5.317G	8	5.509G
9	5.597G	10	5.547G	11	5.270G	12	5.262G
13	5.420G	14	5.694G	15	5.531G	16	5.613G
17	5.398G	18	5.280G	19	5.273G	20	5.287G
21	5.522G	22	5.620G	23	5.384G	24	5.493G
25	5.395G	26	5.475G	27	5.456G	28	5.621G
29	5.657G	30	5.539G	31	5.324G	32	5.413G
33	5.572G	34	5.375G	35	5.258G	36	5.409G
37	5.452G	38	5.682G	39	5.601G	40	5.703G
41	5.325G	42	5.699G	43	5.335G	44	5.374G
45	5.606G	46	5.576G	47	5.314G	48	5.406G
49	5.441G	50	5.669G	51	5.643G	52	5.320G
53	5.556G	54	5.382G	55	5.516G	56	5.614G
57	5.434G	58	5.569G	59	5.281G	60	5.560G
61	5.548G	62	5.654G	63	5.311G	64	5.651G
65	5.297G	66	5.511G	67	5.534G	68	5.702G
69	5.312G	70	5.678G	71	5.685G	72	5.466G
73	5.253G	74	5.419G	75	5.684G	76	5.701G
77	5.296G	78	5.625G	79	5.293G	80	5.316G
81	5.520G	82	5.638G	83	5.723G	84	5.497G
85	5.430G	86	5.300G	87	5.648G	88	5.267G
89	5.627G	90	5.323G	91	5.352G	92	5.331G
93	5.544G	94	5.695G	95	5.444G	96	5.302G
97	5.283G	98	5.343G	99	5.616G	100	5.710G

Hopping Frequency Sequence Name: HOP_FREQ_SEQ_11

SEQ#	Frequency (Hz)	SEQ#	Frequency (Hz)	SEQ#	Frequency (Hz)	SEQ#	Frequency (Hz)
1	5.342G	2	5.439G	3	5.435G	4	5.325G
5	5.540G	6	5.609G	7	5.266G	8	5.569G
9	5.304G	10	5.383G	11	5.371G	12	5.539G
13	5.688G	14	5.600G	15	5.355G	16	5.332G
17	5.634G	18	5.716G	19	5.515G	20	5.538G
21	5.622G	22	5.710G	23	5.416G	24	5.525G
25	5.357G	26	5.474G	27	5.388G	28	5.546G
29	5.562G	30	5.477G	31	5.706G	32	5.645G
33	5.282G	34	5.698G	35	5.590G	36	5.687G
37	5.553G	38	5.431G	39	5.452G	40	5.699G
41	5.261G	42	5.612G	43	5.533G	44	5.347G
45	5.336G	46	5.502G	47	5.378G	48	5.476G
49	5.298G	50	5.500G	51	5.564G	52	5.283G
53	5.626G	54	5.689G	55	5.497G	56	5.531G
57	5.315G	58	5.254G	59	5.647G	60	5.334G
61	5.521G	62	5.665G	63	5.470G	64	5.453G



65	5.494G	66	5.349G	67	5.566G	68	5.557G
69	5.352G	70	5.415G	71	5.701G	72	5.471G
73	5.337G	74	5.511G	75	5.465G	76	5.313G
77	5.707G	78	5.285G	79	5.351G	80	5.570G
81	5.297G	82	5.434G	83	5.643G	84	5.432G
85	5.437G	86	5.703G	87	5.270G	88	5.436G
89	5.607G	90	5.493G	91	5.536G	92	5.393G
93	5.413G	94	5.364G	95	5.555G	96	5.648G
97	5.291G	98	5.399G	99	5.594G	100	5.310G

Hopping Frequency Sequence Name: HOP_FREQ_SEQ_12							
SEQ#	Frequency (Hz)	SEQ#	Frequency (Hz)	SEQ#	Frequency (Hz)	SEQ#	Frequency (Hz)
1	5.403G	2	5.326G	3	5.540G	4	5.276G
5	5.601G	6	5.262G	7	5.289G	8	5.414G
9	5.639G	10	5.407G	11	5.328G	12	5.707G
13	5.521G	14	5.660G	15	5.424G	16	5.415G
17	5.325G	18	5.718G	19	5.591G	20	5.386G
21	5.370G	22	5.583G	23	5.552G	24	5.446G
25	5.703G	26	5.631G	27	5.277G	28	5.486G
29	5.430G	30	5.702G	31	5.470G	32	5.595G
33	5.405G	34	5.530G	35	5.336G	36	5.279G
37	5.381G	38	5.261G	39	5.636G	40	5.420G
41	5.577G	42	5.644G	43	5.534G	44	5.520G
45	5.398G	46	5.720G	47	5.426G	48	5.270G
49	5.474G	50	5.361G	51	5.384G	52	5.691G
53	5.513G	54	5.318G	55	5.517G	56	5.476G
57	5.695G	58	5.378G	59	5.498G	60	5.455G
61	5.698G	62	5.471G	63	5.708G	64	5.345G
65	5.561G	66	5.443G	67	5.658G	68	5.461G
69	5.319G	70	5.627G	71	5.589G	72	5.549G
73	5.596G	74	5.437G	75	5.392G	76	5.576G
77	5.469G	78	5.413G	79	5.661G	80	5.612G
81	5.491G	82	5.315G	83	5.431G	84	5.495G
85	5.672G	86	5.523G	87	5.331G	88	5.353G
89	5.387G	90	5.590G	91	5.368G	92	5.294G
93	5.487G	94	5.324G	95	5.608G	96	5.282G
97	5.499G	98	5.605G	99	5.329G	100	5.273G

Hopping Frequency Sequence Name: HOP_FREQ_SEQ_13							
SEQ#	Frequency (Hz)	SEQ#	Frequency (Hz)	SEQ#	Frequency (Hz)	SEQ#	Frequency (Hz)
1	5.717G	2	5.594G	3	5.572G	4	5.489G
5	5.524G	6	5.301G	7	5.368G	8	5.529G
9	5.267G	10	5.653G	11	5.437G	12	5.664G
13	5.615G	14	5.329G	15	5.359G	16	5.471G
17	5.409G	18	5.435G	19	5.423G	20	5.422G
21	5.410G	22	5.467G	23	5.712G	24	5.440G
25	5.492G	26	5.585G	27	5.546G	28	5.561G
29	5.686G	30	5.376G	31	5.263G	32	5.387G
33	5.575G	34	5.439G	35	5.373G	36	5.667G
37	5.449G	38	5.262G	39	5.551G	40	5.637G



41	5.361G	42	5.312G	43	5.697G	44	5.635G
45	5.553G	46	5.289G	47	5.302G	48	5.678G
49	5.480G	50	5.318G	51	5.724G	52	5.683G
53	5.346G	54	5.643G	55	5.396G	56	5.434G
57	5.587G	58	5.402G	59	5.303G	60	5.466G
61	5.679G	62	5.342G	63	5.693G	64	5.273G
65	5.308G	66	5.576G	67	5.479G	68	5.532G
69	5.383G	70	5.415G	71	5.390G	72	5.250G
73	5.666G	74	5.689G	75	5.554G	76	5.586G
77	5.325G	78	5.391G	79	5.505G	80	5.593G
81	5.682G	82	5.681G	83	5.569G	84	5.251G
85	5.377G	86	5.520G	87	5.661G	88	5.355G
89	5.280G	90	5.357G	91	5.719G	92	5.602G
93	5.695G	94	5.327G	95	5.259G	96	5.508G
97	5.564G	98	5.671G	99	5.704G	100	5.313G

Hopping Frequency Sequence Name: HOP_FREQ_SEQ_14							
SEQ#	Frequency (Hz)	SEQ#	Frequency (Hz)	SEQ#	Frequency (Hz)	SEQ#	Frequency (Hz)
1	5.519G	2	5.626G	3	5.597G	4	5.647G
5	5.294G	6	5.378G	7	5.329G	8	5.679G
9	5.310G	10	5.271G	11	5.676G	12	5.703G
13	5.285G	14	5.705G	15	5.338G	16	5.660G
17	5.495G	18	5.592G	19	5.683G	20	5.309G
21	5.475G	22	5.267G	23	5.489G	24	5.255G
25	5.380G	26	5.389G	27	5.557G	28	5.575G
29	5.532G	30	5.552G	31	5.318G	32	5.365G
33	5.690G	34	5.346G	35	5.507G	36	5.356G
37	5.355G	38	5.288G	39	5.702G	40	5.641G
41	5.497G	42	5.400G	43	5.694G	44	5.587G
45	5.373G	46	5.496G	47	5.656G	48	5.527G
49	5.643G	50	5.567G	51	5.311G	52	5.680G
53	5.637G	54	5.578G	55	5.476G	56	5.250G
57	5.698G	58	5.396G	59	5.560G	60	5.659G
61	5.628G	62	5.712G	63	5.371G	64	5.286G
65	5.517G	66	5.594G	67	5.580G	68	5.606G
69	5.402G	70	5.655G	71	5.617G	72	5.328G
73	5.651G	74	5.719G	75	5.508G	76	5.608G
77	5.372G	78	5.387G	79	5.351G	80	5.648G
81	5.298G	82	5.485G	83	5.333G	84	5.363G
85	5.336G	86	5.682G	87	5.423G	88	5.413G
89	5.436G	90	5.538G	91	5.284G	92	5.462G
93	5.391G	94	5.410G	95	5.566G	96	5.559G
97	5.327G	98	5.714G	99	5.325G	100	5.535G

Hopping Frequency Sequence Name: HOP_FREQ_SEQ_15							
SEQ#	Frequency (Hz)	SEQ#	Frequency (Hz)	SEQ#	Frequency (Hz)	SEQ#	Frequency (Hz)
1	5.595G	2	5.433G	3	5.511G	4	5.352G
5	5.629G	6	5.641G	7	5.632G	8	5.261G
9	5.281G	10	5.556G	11	5.262G	12	5.356G
13	5.350G	14	5.354G	15	5.518G	16	5.282G



17	5.542G	18	5.478G	19	5.410G	20	5.574G
21	5.411G	22	5.413G	23	5.284G	24	5.454G
25	5.415G	26	5.342G	27	5.619G	28	5.557G
29	5.397G	30	5.674G	31	5.709G	32	5.599G
33	5.486G	34	5.600G	35	5.648G	36	5.531G
37	5.506G	38	5.379G	39	5.522G	40	5.587G
41	5.426G	42	5.364G	43	5.422G	44	5.677G
45	5.283G	46	5.623G	47	5.463G	48	5.455G
49	5.548G	50	5.260G	51	5.582G	52	5.516G
53	5.698G	54	5.538G	55	5.543G	56	5.462G
57	5.251G	58	5.666G	59	5.685G	60	5.423G
61	5.601G	62	5.399G	63	5.541G	64	5.294G
65	5.612G	66	5.491G	67	5.444G	68	5.646G
69	5.375G	70	5.503G	71	5.507G	72	5.307G
73	5.708G	74	5.318G	75	5.707G	76	5.663G
77	5.270G	78	5.559G	79	5.335G	80	5.620G
81	5.490G	82	5.429G	83	5.571G	84	5.340G
85	5.706G	86	5.528G	87	5.598G	88	5.289G
89	5.449G	90	5.472G	91	5.388G	92	5.475G
93	5.403G	94	5.659G	95	5.337G	96	5.533G
97	5.391G	98	5.447G	99	5.496G	100	5.721G

Hopping Frequency Sequence Name: HOP_FREQ_SEQ_16

SEQ#	Frequency (Hz)	SEQ#	Frequency (Hz)	SEQ#	Frequency (Hz)	SEQ#	Frequency (Hz)
1	5.465G	2	5.665G	3	5.538G	4	5.706G
5	5.673G	6	5.681G	7	5.599G	8	5.682G
9	5.666G	10	5.531G	11	5.394G	12	5.630G
13	5.358G	14	5.299G	15	5.505G	16	5.636G
17	5.719G	18	5.281G	19	5.688G	20	5.516G
21	5.703G	22	5.591G	23	5.698G	24	5.674G
25	5.438G	26	5.604G	27	5.690G	28	5.628G
29	5.522G	30	5.524G	31	5.341G	32	5.425G
33	5.499G	34	5.353G	35	5.464G	36	5.355G
37	5.269G	38	5.588G	39	5.541G	40	5.692G
41	5.417G	42	5.642G	43	5.364G	44	5.468G
45	5.650G	46	5.314G	47	5.251G	48	5.717G
49	5.407G	50	5.618G	51	5.414G	52	5.589G
53	5.622G	54	5.488G	55	5.617G	56	5.313G
57	5.693G	58	5.585G	59	5.459G	60	5.492G
61	5.285G	62	5.662G	63	5.361G	64	5.677G
65	5.255G	66	5.518G	67	5.445G	68	5.256G
69	5.437G	70	5.252G	71	5.496G	72	5.471G
73	5.368G	74	5.339G	75	5.564G	76	5.448G
77	5.637G	78	5.322G	79	5.610G	80	5.264G
81	5.382G	82	5.544G	83	5.475G	84	5.257G
85	5.474G	86	5.270G	87	5.402G	88	5.723G
89	5.463G	90	5.523G	91	5.328G	92	5.578G
93	5.612G	94	5.381G	95	5.279G	96	5.556G
97	5.669G	98	5.609G	99	5.410G	100	5.395G

Hopping Frequency Sequence Name: HOP_FREQ_SEQ_17



SEQ#	Frequency (Hz)	SEQ#	Frequency (Hz)	SEQ#	Frequency (Hz)	SEQ#	Frequency (Hz)
1	5.539G	2	5.466G	3	5.272G	4	5.386G
5	5.294G	6	5.538G	7	5.303G	8	5.264G
9	5.552G	10	5.492G	11	5.444G	12	5.597G
13	5.702G	14	5.442G	15	5.479G	16	5.627G
17	5.718G	18	5.654G	19	5.686G	20	5.413G
21	5.348G	22	5.564G	23	5.339G	24	5.389G
25	5.518G	26	5.551G	27	5.709G	28	5.377G
29	5.516G	30	5.679G	31	5.655G	32	5.352G
33	5.596G	34	5.674G	35	5.344G	36	5.610G
37	5.700G	38	5.345G	39	5.576G	40	5.632G
41	5.332G	42	5.570G	43	5.308G	44	5.314G
45	5.620G	46	5.520G	47	5.517G	48	5.351G
49	5.671G	50	5.601G	51	5.283G	52	5.690G
53	5.256G	54	5.488G	55	5.323G	56	5.696G
57	5.421G	58	5.452G	59	5.622G	60	5.407G
61	5.626G	62	5.553G	63	5.301G	64	5.722G
65	5.402G	66	5.468G	67	5.343G	68	5.668G
69	5.487G	70	5.363G	71	5.380G	72	5.603G
73	5.277G	74	5.392G	75	5.330G	76	5.281G
77	5.257G	78	5.513G	79	5.270G	80	5.519G
81	5.525G	82	5.250G	83	5.719G	84	5.318G
85	5.512G	86	5.443G	87	5.638G	88	5.724G
89	5.647G	90	5.691G	91	5.388G	92	5.397G
93	5.321G	94	5.636G	95	5.340G	96	5.338G
97	5.591G	98	5.637G	99	5.315G	100	5.461G

Hopping Frequency Sequence Name: HOP_FREQ_SEQ_18

SEQ#	Frequency (Hz)	SEQ#	Frequency (Hz)	SEQ#	Frequency (Hz)	SEQ#	Frequency (Hz)
1	5.409G	2	5.719G	3	5.296G	4	5.310G
5	5.253G	6	5.292G	7	5.707G	8	5.396G
9	5.330G	10	5.662G	11	5.428G	12	5.544G
13	5.509G	14	5.647G	15	5.659G	16	5.382G
17	5.675G	18	5.385G	19	5.606G	20	5.254G
21	5.283G	22	5.654G	23	5.446G	24	5.716G
25	5.696G	26	5.580G	27	5.504G	28	5.278G
29	5.551G	30	5.472G	31	5.326G	32	5.527G
33	5.597G	34	5.279G	35	5.666G	36	5.272G
37	5.273G	38	5.439G	39	5.674G	40	5.683G
41	5.342G	42	5.632G	43	5.354G	44	5.601G
45	5.639G	46	5.631G	47	5.309G	48	5.607G
49	5.685G	50	5.308G	51	5.664G	52	5.558G
53	5.301G	54	5.533G	55	5.592G	56	5.649G
57	5.452G	58	5.449G	59	5.372G	60	5.328G
61	5.714G	62	5.555G	63	5.379G	64	5.453G
65	5.336G	66	5.270G	67	5.543G	68	5.293G
69	5.485G	70	5.616G	71	5.255G	72	5.542G
73	5.375G	74	5.713G	75	5.403G	76	5.532G
77	5.549G	78	5.356G	79	5.599G	80	5.390G
81	5.510G	82	5.271G	83	5.331G	84	5.598G



85	5.499G	86	5.612G	87	5.518G	88	5.266G
89	5.315G	90	5.397G	91	5.416G	92	5.284G
93	5.622G	94	5.256G	95	5.321G	96	5.352G
97	5.548G	98	5.554G	99	5.373G	100	5.411G

Hopping Frequency Sequence Name: HOP_FREQ_SEQ_19

SEQ#	Frequency (Hz)	SEQ#	Frequency (Hz)	SEQ#	Frequency (Hz)	SEQ#	Frequency (Hz)
1	5.291G	2	5.502G	3	5.640G	4	5.591G
5	5.586G	6	5.345G	7	5.400G	8	5.316G
9	5.639G	10	5.529G	11	5.628G	12	5.270G
13	5.438G	14	5.452G	15	5.301G	16	5.548G
17	5.331G	18	5.612G	19	5.613G	20	5.294G
21	5.592G	22	5.320G	23	5.570G	24	5.397G
25	5.277G	26	5.466G	27	5.488G	28	5.696G
29	5.556G	30	5.574G	31	5.512G	32	5.313G
33	5.597G	34	5.485G	35	5.635G	36	5.530G
37	5.656G	38	5.550G	39	5.492G	40	5.557G
41	5.456G	42	5.561G	43	5.632G	44	5.426G
45	5.465G	46	5.333G	47	5.685G	48	5.579G
49	5.352G	50	5.534G	51	5.362G	52	5.504G
53	5.325G	54	5.542G	55	5.483G	56	5.300G
57	5.637G	58	5.605G	59	5.525G	60	5.620G
61	5.527G	62	5.560G	63	5.427G	64	5.398G
65	5.486G	66	5.254G	67	5.395G	68	5.547G
69	5.601G	70	5.699G	71	5.538G	72	5.664G
73	5.381G	74	5.516G	75	5.627G	76	5.508G
77	5.391G	78	5.563G	79	5.642G	80	5.314G
81	5.571G	82	5.671G	83	5.463G	84	5.618G
85	5.552G	86	5.484G	87	5.589G	88	5.551G
89	5.367G	90	5.593G	91	5.576G	92	5.478G
93	5.558G	94	5.681G	95	5.443G	96	5.401G
97	5.403G	98	5.413G	99	5.428G	100	5.679G

Hopping Frequency Sequence Name: HOP_FREQ_SEQ_20

SEQ#	Frequency (Hz)	SEQ#	Frequency (Hz)	SEQ#	Frequency (Hz)	SEQ#	Frequency (Hz)
1	5.371G	2	5.324G	3	5.531G	4	5.298G
5	5.448G	6	5.399G	7	5.660G	8	5.410G
9	5.599G	10	5.392G	11	5.595G	12	5.408G
13	5.488G	14	5.537G	15	5.257G	16	5.435G
17	5.378G	18	5.687G	19	5.263G	20	5.407G
21	5.513G	22	5.395G	23	5.636G	24	5.658G
25	5.710G	26	5.367G	27	5.499G	28	5.264G
29	5.490G	30	5.551G	31	5.589G	32	5.596G
33	5.629G	34	5.429G	35	5.653G	36	5.325G
37	5.456G	38	5.685G	39	5.343G	40	5.485G
41	5.611G	42	5.462G	43	5.251G	44	5.492G
45	5.608G	46	5.698G	47	5.334G	48	5.720G
49	5.391G	50	5.600G	51	5.310G	52	5.625G
53	5.709G	54	5.688G	55	5.358G	56	5.701G
57	5.451G	58	5.398G	59	5.380G	60	5.640G



61	5.612G	62	5.487G	63	5.491G	64	5.579G
65	5.341G	66	5.405G	67	5.634G	68	5.346G
69	5.570G	70	5.497G	71	5.622G	72	5.690G
73	5.262G	74	5.644G	75	5.427G	76	5.613G
77	5.421G	78	5.510G	79	5.373G	80	5.287G
81	5.523G	82	5.605G	83	5.327G	84	5.473G
85	5.304G	86	5.580G	87	5.293G	88	5.331G
89	5.664G	90	5.419G	91	5.397G	92	5.338G
93	5.553G	94	5.261G	95	5.620G	96	5.652G
97	5.558G	98	5.645G	99	5.364G	100	5.357G

Hopping Frequency Sequence Name: HOP_FREQ_SEQ_21							
SEQ#	Frequency (Hz)	SEQ#	Frequency (Hz)	SEQ#	Frequency (Hz)	SEQ#	Frequency (Hz)
1	5.493G	2	5.561G	3	5.547G	4	5.556G
5	5.371G	6	5.313G	7	5.501G	8	5.295G
9	5.271G	10	5.558G	11	5.649G	12	5.444G
13	5.310G	14	5.689G	15	5.397G	16	5.504G
17	5.451G	18	5.318G	19	5.609G	20	5.465G
21	5.627G	22	5.331G	23	5.279G	24	5.356G
25	5.588G	26	5.277G	27	5.420G	28	5.332G
29	5.710G	30	5.458G	31	5.346G	32	5.428G
33	5.701G	34	5.303G	35	5.351G	36	5.684G
37	5.536G	38	5.533G	39	5.427G	40	5.653G
41	5.362G	42	5.539G	43	5.543G	44	5.485G
45	5.528G	46	5.530G	47	5.355G	48	5.636G
49	5.665G	50	5.261G	51	5.407G	52	5.359G
53	5.616G	54	5.335G	55	5.664G	56	5.531G
57	5.520G	58	5.348G	59	5.500G	60	5.601G
61	5.281G	62	5.276G	63	5.626G	64	5.694G
65	5.516G	66	5.449G	67	5.654G	68	5.687G
69	5.650G	70	5.263G	71	5.621G	72	5.345G
73	5.647G	74	5.605G	75	5.436G	76	5.400G
77	5.286G	78	5.489G	79	5.696G	80	5.686G
81	5.518G	82	5.478G	83	5.577G	84	5.722G
85	5.488G	86	5.594G	87	5.342G	88	5.497G
89	5.254G	90	5.557G	91	5.630G	92	5.700G
93	5.433G	94	5.690G	95	5.604G	96	5.471G
97	5.644G	98	5.610G	99	5.606G	100	5.366G

Hopping Frequency Sequence Name: HOP_FREQ_SEQ_22							
SEQ#	Frequency (Hz)	SEQ#	Frequency (Hz)	SEQ#	Frequency (Hz)	SEQ#	Frequency (Hz)
1	5.322G	2	5.319G	3	5.500G	4	5.544G
5	5.258G	6	5.719G	7	5.523G	8	5.505G
9	5.265G	10	5.283G	11	5.269G	12	5.512G
13	5.351G	14	5.561G	15	5.651G	16	5.681G
17	5.570G	18	5.263G	19	5.408G	20	5.622G
21	5.609G	22	5.705G	23	5.433G	24	5.628G
25	5.547G	26	5.601G	27	5.653G	28	5.667G
29	5.706G	30	5.294G	31	5.267G	32	5.596G
33	5.479G	34	5.389G	35	5.402G	36	5.576G



37	5.277G	38	5.629G	39	5.418G	40	5.348G
41	5.520G	42	5.469G	43	5.446G	44	5.362G
45	5.545G	46	5.634G	47	5.694G	48	5.318G
49	5.442G	50	5.495G	51	5.369G	52	5.280G
53	5.475G	54	5.480G	55	5.332G	56	5.487G
57	5.614G	58	5.342G	59	5.590G	60	5.250G
61	5.532G	62	5.396G	63	5.713G	64	5.447G
65	5.388G	66	5.278G	67	5.683G	68	5.262G
69	5.549G	70	5.466G	71	5.323G	72	5.432G
73	5.626G	74	5.658G	75	5.542G	76	5.431G
77	5.518G	78	5.329G	79	5.541G	80	5.482G
81	5.575G	82	5.467G	83	5.600G	84	5.585G
85	5.578G	86	5.509G	87	5.460G	88	5.665G
89	5.358G	90	5.411G	91	5.386G	92	5.397G
93	5.381G	94	5.633G	95	5.521G	96	5.488G
97	5.648G	98	5.398G	99	5.491G	100	5.592G

Hopping Frequency Sequence Name: HOP_FREQ_SEQ_23							
SEQ#	Frequency (Hz)	SEQ#	Frequency (Hz)	SEQ#	Frequency (Hz)	SEQ#	Frequency (Hz)
1	5.547G	2	5.461G	3	5.446G	4	5.432G
5	5.538G	6	5.556G	7	5.508G	8	5.625G
9	5.416G	10	5.273G	11	5.682G	12	5.628G
13	5.367G	14	5.613G	15	5.573G	16	5.523G
17	5.607G	18	5.619G	19	5.415G	20	5.402G
21	5.442G	22	5.652G	23	5.380G	24	5.355G
25	5.525G	26	5.488G	27	5.269G	28	5.622G
29	5.278G	30	5.596G	31	5.480G	32	5.379G
33	5.325G	34	5.425G	35	5.467G	36	5.437G
37	5.621G	38	5.374G	39	5.481G	40	5.404G
41	5.405G	42	5.719G	43	5.294G	44	5.696G
45	5.497G	46	5.509G	47	5.512G	48	5.677G
49	5.261G	50	5.527G	51	5.718G	52	5.350G
53	5.322G	54	5.650G	55	5.472G	56	5.643G
57	5.561G	58	5.705G	59	5.409G	60	5.687G
61	5.627G	62	5.662G	63	5.457G	64	5.272G
65	5.401G	66	5.534G	67	5.392G	68	5.518G
69	5.495G	70	5.605G	71	5.256G	72	5.577G
73	5.462G	74	5.591G	75	5.602G	76	5.447G
77	5.316G	78	5.504G	79	5.489G	80	5.334G
81	5.406G	82	5.657G	83	5.460G	84	5.254G
85	5.279G	86	5.551G	87	5.647G	88	5.557G
89	5.521G	90	5.268G	91	5.661G	92	5.270G
93	5.700G	94	5.310G	95	5.684G	96	5.318G
97	5.517G	98	5.336G	99	5.309G	100	5.713G

Hopping Frequency Sequence Name: HOP_FREQ_SEQ_24							
SEQ#	Frequency (Hz)	SEQ#	Frequency (Hz)	SEQ#	Frequency (Hz)	SEQ#	Frequency (Hz)
1	5.694G	2	5.689G	3	5.638G	4	5.670G
5	5.565G	6	5.322G	7	5.561G	8	5.402G
9	5.313G	10	5.652G	11	5.519G	12	5.637G



13	5.696G	14	5.286G	15	5.554G	16	5.560G
17	5.351G	18	5.495G	19	5.620G	20	5.462G
21	5.691G	22	5.678G	23	5.603G	24	5.559G
25	5.604G	26	5.596G	27	5.548G	28	5.692G
29	5.484G	30	5.622G	31	5.277G	32	5.609G
33	5.533G	34	5.457G	35	5.713G	36	5.465G
37	5.511G	38	5.382G	39	5.522G	40	5.478G
41	5.610G	42	5.534G	43	5.448G	44	5.327G
45	5.580G	46	5.297G	47	5.679G	48	5.396G
49	5.707G	50	5.515G	51	5.451G	52	5.502G
53	5.549G	54	5.597G	55	5.627G	56	5.450G
57	5.360G	58	5.316G	59	5.574G	60	5.642G
61	5.532G	62	5.660G	63	5.421G	64	5.252G
65	5.577G	66	5.582G	67	5.599G	68	5.440G
69	5.608G	70	5.320G	71	5.398G	72	5.401G
73	5.666G	74	5.336G	75	5.492G	76	5.702G
77	5.486G	78	5.285G	79	5.344G	80	5.619G
81	5.612G	82	5.394G	83	5.594G	84	5.279G
85	5.697G	86	5.494G	87	5.701G	88	5.723G
89	5.555G	90	5.436G	91	5.432G	92	5.284G
93	5.576G	94	5.523G	95	5.397G	96	5.414G
97	5.506G	98	5.501G	99	5.474G	100	5.542G

Hopping Frequency Sequence Name: HOP_FREQ_SEQ_25

SEQ#	Frequency (Hz)	SEQ#	Frequency (Hz)	SEQ#	Frequency (Hz)	SEQ#	Frequency (Hz)
1	5.636G	2	5.556G	3	5.383G	4	5.386G
5	5.482G	6	5.432G	7	5.318G	8	5.722G
9	5.593G	10	5.455G	11	5.444G	12	5.408G
13	5.619G	14	5.710G	15	5.481G	16	5.686G
17	5.379G	18	5.711G	19	5.635G	20	5.648G
21	5.494G	22	5.252G	23	5.583G	24	5.532G
25	5.526G	26	5.628G	27	5.430G	28	5.370G
29	5.462G	30	5.293G	31	5.389G	32	5.715G
33	5.319G	34	5.347G	35	5.520G	36	5.324G
37	5.570G	38	5.373G	39	5.674G	40	5.601G
41	5.371G	42	5.550G	43	5.388G	44	5.687G
45	5.519G	46	5.405G	47	5.268G	48	5.321G
49	5.475G	50	5.365G	51	5.442G	52	5.658G
53	5.721G	54	5.328G	55	5.317G	56	5.276G
57	5.557G	58	5.463G	59	5.676G	60	5.643G
61	5.472G	62	5.603G	63	5.496G	64	5.495G
65	5.312G	66	5.651G	67	5.420G	68	5.367G
69	5.703G	70	5.396G	71	5.440G	72	5.401G
73	5.377G	74	5.337G	75	5.399G	76	5.529G
77	5.376G	78	5.343G	79	5.250G	80	5.650G
81	5.612G	82	5.683G	83	5.486G	84	5.696G
85	5.649G	86	5.427G	87	5.259G	88	5.719G
89	5.407G	90	5.300G	91	5.429G	92	5.322G
93	5.673G	94	5.291G	95	5.514G	96	5.450G
97	5.411G	98	5.525G	99	5.675G	100	5.708G



Hopping Frequency Sequence Name: HOP_FREQ_SEQ_26							
SEQ#	Frequency (Hz)	SEQ#	Frequency (Hz)	SEQ#	Frequency (Hz)	SEQ#	Frequency (Hz)
1	5.683G	2	5.675G	3	5.476G	4	5.250G
5	5.404G	6	5.336G	7	5.579G	8	5.320G
9	5.528G	10	5.652G	11	5.444G	12	5.590G
13	5.373G	14	5.616G	15	5.641G	16	5.388G
17	5.432G	18	5.435G	19	5.709G	20	5.491G
21	5.635G	22	5.365G	23	5.695G	24	5.546G
25	5.633G	26	5.642G	27	5.414G	28	5.593G
29	5.553G	30	5.477G	31	5.700G	32	5.353G
33	5.453G	34	5.337G	35	5.258G	36	5.419G
37	5.323G	38	5.378G	39	5.431G	40	5.333G
41	5.346G	42	5.520G	43	5.625G	44	5.619G
45	5.369G	46	5.576G	47	5.626G	48	5.282G
49	5.568G	50	5.602G	51	5.261G	52	5.401G
53	5.264G	54	5.526G	55	5.678G	56	5.603G
57	5.525G	58	5.332G	59	5.565G	60	5.345G
61	5.721G	62	5.385G	63	5.263G	64	5.299G
65	5.614G	66	5.524G	67	5.504G	68	5.607G
69	5.442G	70	5.662G	71	5.359G	72	5.664G
73	5.654G	74	5.558G	75	5.480G	76	5.430G
77	5.586G	78	5.262G	79	5.427G	80	5.295G
81	5.660G	82	5.638G	83	5.557G	84	5.289G
85	5.294G	86	5.620G	87	5.686G	88	5.636G
89	5.711G	90	5.308G	91	5.689G	92	5.612G
93	5.574G	94	5.536G	95	5.356G	96	5.685G
97	5.587G	98	5.692G	99	5.564G	100	5.303G

Hopping Frequency Sequence Name: HOP_FREQ_SEQ_27							
SEQ#	Frequency (Hz)	SEQ#	Frequency (Hz)	SEQ#	Frequency (Hz)	SEQ#	Frequency (Hz)
1	5.715G	2	5.643G	3	5.263G	4	5.632G
5	5.627G	6	5.317G	7	5.437G	8	5.649G
9	5.319G	10	5.325G	11	5.590G	12	5.405G
13	5.445G	14	5.452G	15	5.529G	16	5.320G
17	5.664G	18	5.572G	19	5.262G	20	5.307G
21	5.481G	22	5.375G	23	5.369G	24	5.345G
25	5.279G	26	5.260G	27	5.617G	28	5.257G
29	5.376G	30	5.514G	31	5.322G	32	5.321G
33	5.576G	34	5.395G	35	5.703G	36	5.598G
37	5.702G	38	5.521G	39	5.646G	40	5.535G
41	5.438G	42	5.413G	43	5.495G	44	5.566G
45	5.453G	46	5.661G	47	5.688G	48	5.324G
49	5.571G	50	5.410G	51	5.342G	52	5.719G
53	5.513G	54	5.323G	55	5.629G	56	5.682G
57	5.286G	58	5.658G	59	5.525G	60	5.640G
61	5.560G	62	5.344G	63	5.512G	64	5.699G
65	5.622G	66	5.698G	67	5.552G	68	5.340G
69	5.420G	70	5.677G	71	5.431G	72	5.714G
73	5.295G	74	5.483G	75	5.653G	76	5.628G
77	5.373G	78	5.288G	79	5.255G	80	5.331G



81	5.480G	82	5.467G	83	5.454G	84	5.433G
85	5.409G	86	5.298G	87	5.268G	88	5.580G
89	5.595G	90	5.313G	91	5.339G	92	5.515G
93	5.644G	94	5.311G	95	5.597G	96	5.568G
97	5.407G	98	5.713G	99	5.612G	100	5.618G

Hopping Frequency Sequence Name: HOP_FREQ_SEQ_28							
SEQ#	Frequency (Hz)	SEQ#	Frequency (Hz)	SEQ#	Frequency (Hz)	SEQ#	Frequency (Hz)
1	5.642G	2	5.559G	3	5.251G	4	5.451G
5	5.354G	6	5.351G	7	5.380G	8	5.379G
9	5.345G	10	5.424G	11	5.480G	12	5.272G
13	5.468G	14	5.415G	15	5.412G	16	5.360G
17	5.522G	18	5.639G	19	5.423G	20	5.291G
21	5.456G	22	5.311G	23	5.472G	24	5.497G
25	5.464G	26	5.692G	27	5.514G	28	5.325G
29	5.454G	30	5.668G	31	5.383G	32	5.264G
33	5.413G	34	5.599G	35	5.689G	36	5.382G
37	5.592G	38	5.606G	39	5.280G	40	5.433G
41	5.505G	42	5.289G	43	5.467G	44	5.650G
45	5.273G	46	5.589G	47	5.682G	48	5.391G
49	5.569G	50	5.612G	51	5.337G	52	5.370G
53	5.267G	54	5.638G	55	5.475G	56	5.281G
57	5.315G	58	5.373G	59	5.396G	60	5.709G
61	5.304G	62	5.695G	63	5.686G	64	5.381G
65	5.491G	66	5.292G	67	5.388G	68	5.283G
69	5.542G	70	5.322G	71	5.336G	72	5.343G
73	5.498G	74	5.495G	75	5.399G	76	5.571G
77	5.416G	78	5.255G	79	5.595G	80	5.588G
81	5.323G	82	5.338G	83	5.282G	84	5.404G
85	5.555G	86	5.508G	87	5.634G	88	5.530G
89	5.620G	90	5.528G	91	5.627G	92	5.321G
93	5.262G	94	5.636G	95	5.549G	96	5.265G
97	5.432G	98	5.366G	99	5.420G	100	5.583G

Hopping Frequency Sequence Name: HOP_FREQ_SEQ_29							
SEQ#	Frequency (Hz)	SEQ#	Frequency (Hz)	SEQ#	Frequency (Hz)	SEQ#	Frequency (Hz)
1	5.650G	2	5.563G	3	5.501G	4	5.499G
5	5.410G	6	5.366G	7	5.636G	8	5.539G
9	5.568G	10	5.543G	11	5.343G	12	5.302G
13	5.346G	14	5.562G	15	5.483G	16	5.345G
17	5.386G	18	5.436G	19	5.545G	20	5.702G
21	5.509G	22	5.485G	23	5.496G	24	5.357G
25	5.294G	26	5.654G	27	5.477G	28	5.608G
29	5.503G	30	5.393G	31	5.550G	32	5.648G
33	5.287G	34	5.530G	35	5.349G	36	5.263G
37	5.347G	38	5.694G	39	5.700G	40	5.446G
41	5.423G	42	5.659G	43	5.587G	44	5.688G
45	5.526G	46	5.546G	47	5.433G	48	5.540G
49	5.508G	50	5.479G	51	5.559G	52	5.312G
53	5.463G	54	5.340G	55	5.619G	56	5.572G



57	5.406G	58	5.658G	59	5.307G	60	5.264G
61	5.693G	62	5.722G	63	5.616G	64	5.257G
65	5.487G	66	5.692G	67	5.286G	68	5.623G
69	5.391G	70	5.580G	71	5.341G	72	5.458G
73	5.399G	74	5.524G	75	5.593G	76	5.591G
77	5.625G	78	5.448G	79	5.378G	80	5.395G
81	5.617G	82	5.404G	83	5.599G	84	5.434G
85	5.670G	86	5.584G	87	5.651G	88	5.685G
89	5.557G	90	5.716G	91	5.382G	92	5.679G
93	5.611G	94	5.662G	95	5.325G	96	5.407G
97	5.351G	98	5.331G	99	5.299G	100	5.437G

Hopping Frequency Sequence Name: HOP_FREQ_SEQ_30							
SEQ#	Frequency (Hz)	SEQ#	Frequency (Hz)	SEQ#	Frequency (Hz)	SEQ#	Frequency (Hz)
1	5.631G	2	5.707G	3	5.356G	4	5.592G
5	5.720G	6	5.508G	7	5.253G	8	5.568G
9	5.440G	10	5.577G	11	5.541G	12	5.501G
13	5.704G	14	5.281G	15	5.511G	16	5.357G
17	5.675G	18	5.366G	19	5.263G	20	5.618G
21	5.337G	22	5.685G	23	5.352G	24	5.607G
25	5.301G	26	5.344G	27	5.398G	28	5.547G
29	5.470G	30	5.351G	31	5.510G	32	5.400G
33	5.436G	34	5.686G	35	5.644G	36	5.673G
37	5.388G	38	5.471G	39	5.636G	40	5.552G
41	5.376G	42	5.257G	43	5.327G	44	5.456G
45	5.672G	46	5.260G	47	5.410G	48	5.418G
49	5.341G	50	5.450G	51	5.515G	52	5.473G
53	5.404G	54	5.486G	55	5.570G	56	5.697G
57	5.435G	58	5.295G	59	5.447G	60	5.319G
61	5.292G	62	5.482G	63	5.529G	64	5.612G
65	5.252G	66	5.639G	67	5.358G	68	5.298G
69	5.558G	70	5.405G	71	5.402G	72	5.716G
73	5.617G	74	5.365G	75	5.491G	76	5.299G
77	5.359G	78	5.717G	79	5.498G	80	5.719G
81	5.490G	82	5.596G	83	5.681G	84	5.638G
85	5.516G	86	5.587G	87	5.554G	88	5.661G
89	5.336G	90	5.280G	91	5.495G	92	5.718G
93	5.287G	94	5.517G	95	5.434G	96	5.425G
97	5.466G	98	5.272G	99	5.576G	100	5.666G

APPENDIX-C

TPC

Transmit Power Control (TPC)

In WLAN product of Microelectronics Technology Inc. (MTI), TPC is controlled by software and the user may adjust the Transmit Power level from web interface according to following procedure.

- I In the left menu page, click "Advanced Setting" of 5GHz Radio. The page of 5GHz -> Advanced will be displayed on the right side.
- I Click the pull down menu of "Transmit Power", there are 5 power levels for selection. Refer to the screenshot as below.
 - Full = Decided by the regulation of the channel
 - Half = Full - 3dB
 - Quarter = Full - 6dB
 - Eighth = Full - 9dB
 - Minimum = Full - 12dB

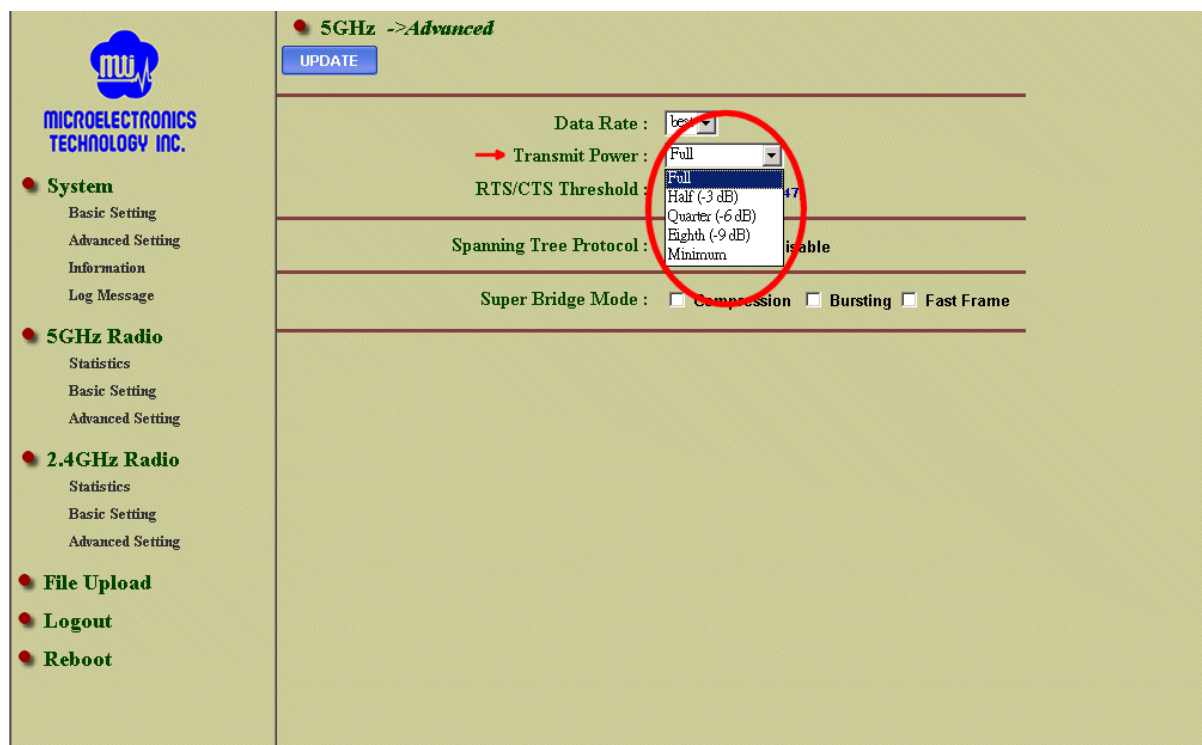

Our 5GHz interface is for WLAN bridge purpose that is installed fixedly, so we implement manual TPC instead of automatic TPC on the product.