

FCC TEST REPORT (15.247)

REPORT NO.: RF930507H07X

MODEL NO.: AP5822, AP5822E

RECEIVED: Nov. 15, 2006

TESTED: Nov. 20, 2006 to March 08, 2007

ISSUED: March 22, 2007

APPLICANT: Microelectronics Technology Inc.

ADDRESS: 1, Innovation Road II, Hsinchu Science-based
Industrial Park, Hsinchu, Taiwan, R.O.C.

ISSUED BY: Advance Data Technology Corporation

TEST LOCATION: No. 81-1, Lu Liao Keng, 9 Ling, Wu Lung
Tsuen, Chiung Lin Hsiang, Hsin Chu Hsien,
Taiwan, R.O.C.

This test report consists of 56 pages in total. It may be duplicated completely for legal use with the approval of the applicant. It should not be reproduced except in full, without the written approval of our laboratory. The client should not use it to claim product endorsement by CNLA, A2LA or any government agencies. The test results in the report only apply to the tested sample.



No. 2177-01

Table of Contents

1.	CERTIFICATION.....	4
2.	SUMMARY OF TEST RESULTS.....	5
2.1	MEASUREMENT UNCERTAINTY.....	6
3.	GENERAL INFORMATION	7
3.1	GENERAL DESCRIPTION OF EUT.....	7
3.2	DESCRIPTION OF TEST MODES.....	9
3.2.1	TEST MODE APPLICABILITY AND TESTED CHANNEL DETAIL:.....	10
3.3	GENERAL DESCRIPTION OF APPLIED STANDARDS	12
3.4	DESCRIPTION OF SUPPORT UNITS.....	13
3.5	CONFIGURATION OF SYSTEM UNDER TEST	14
4.	TEST TYPES AND RESULTS (802.11a, 5725~5850MHz Band).....	16
4.1	CONDUCTED EMISSION MEASUREMENT	16
4.1.1	LIMITS OF CONDUCTED EMISSION MEASUREMENT	16
4.1.2	TEST INSTRUMENTS	16
4.1.3	TEST PROCEDURES.....	17
4.1.4	DEVIATION FROM TEST STANDARD	17
4.1.5	TEST SETUP.....	18
4.1.6	EUT OPERATING CONDITIONS.....	18
4.1.7	TEST RESULTS	19
4.2	RADIATED EMISSION MEASUREMENT	21
4.2.1	LIMITS OF RADIATED EMISSION MEASUREMENT	21
4.2.2	TEST INSTRUMENTS	22
4.2.3	TEST PROCEDURES.....	23
4.2.4	DEVIATION FROM TEST STANDARD	23
4.2.5	TEST SETUP.....	24
4.2.6	EUT OPERATING CONDITIONS.....	24
4.2.7	TEST RESULTS	25
4.2.8	TEST RESULTS – ANTENNA A.....	26
4.3	6dB BANDWIDTH MEASUREMENT	31
4.3.1	LIMITS OF 6dB BANDWIDTH MEASUREMENT	31
4.3.2	TEST INSTRUMENTS	31
4.3.3	TEST PROCEDURE	32
4.3.4	DEVIATION FROM TEST STANDARD	32
4.3.5	TEST SETUP.....	32
4.3.6	EUT OPERATING CONDITIONS.....	32
4.3.7	TEST RESULTS - ANTENNA A.....	33
4.4	MAXIMUM PEAK OUTPUT POWER.....	37



4.4.1	LIMITS OF MAXIMUM PEAK OUTPUT POWER MEASUREMENT.....	37
4.4.2	INSTRUMENTS.....	37
4.4.3	TEST PROCEDURES.....	38
4.4.4	DEVIATION FROM TEST STANDARD	38
4.4.5	TEST SETUP.....	38
4.4.6	EUT OPERATING CONDITIONS.....	38
4.4.7	TEST RESULTS - ANTENNA A.....	39
4.5	POWER SPECTRAL DENSITY MEASUREMENT	41
4.5.1	LIMITS OF POWER SPECTRAL DENSITY MEASUREMENT	41
4.5.2	TEST INSTRUMENTS.....	41
4.5.3	TEST PROCEDURE	42
4.5.4	DEVIATION FROM TEST STANDARD	42
4.5.5	TEST SETUP.....	42
4.5.6	EUT OPERATING CONDITION	42
4.5.7	TEST RESULTS - ANTENNA A.....	43
4.6	BAND EDGES MEASUREMENT	47
4.6.1	LIMITS OF BAND EDGES MEASUREMENT.....	47
4.6.2	TEST INSTRUMENTS.....	47
4.6.3	TEST PROCEDURE	48
4.6.4	DEVIATION FROM TEST STANDARD	48
4.6.5	EUT OPERATING CONDITION	48
4.6.6	TEST RESULTS -ANTENNA A	49
4.7	ANTENNA REQUIREMENT.....	54
4.7.1	STANDARD APPLICABLE.....	54
4.7.2	ANTENNA CONNECTED CONSTRUCTION.....	54
5.	INFORMATION ON THE TESTING LABORATORIES	55
	APPENDIX-A.....	A-1



1. CERTIFICATION

PRODUCT: 802.11a+b/g Outdoor AP/Bridge With Internal Antenna,
802.11a+b/g Outdoor AP/Bridge With External Antenna

BRAND NAME: MTI

MODEL NO.: AP5822, AP5822E

TEST SAMPLE: MASS-PRODUCTION

TESTED: Nov. 20, 2006 to March 08, 2007

APPLICANT: Microelectronics Technology Inc.

STANDARDS: FCC Part 15, Subpart C (Section 15.247),
ANSI C63.4-2003

The above equipment (Model: AP5822, AP5822E) have been tested by **Advance Data Technology Corporation**, and found compliance with the requirement of the above standards. The test record, data evaluation & Equipment Under Test (EUT) configurations represented herein are true and accurate accounts of the measurements of the sample's EMC characteristics under the conditions specified in this report.

PREPARED BY : Carol Liao , **DATE:** March 22, 2007
(Carol Liao)

TECHNICAL ACCEPTANCE : Moris Lin , **DATE:** March 22, 2007
Responsible for RF (Moris Lin)

APPROVED BY : Hank Chung , **DATE:** March 22, 2007
(Hank Chung, Deputy Manager)

2. SUMMARY OF TEST RESULTS

The EUT has been tested according to the following specifications:

For 802.11a, 5725~5850MHz Band

APPLIED STANDARD: FCC Part 15, Subpart C (Section 15.247)			
Standard Section	Test Type and Limit	Result	Remark
15.207	AC Power Conducted Emission	PASS	Meet the requirement of limit. Minimum passing margin is -16.60dB at 0.209MHz
15.247(a)(2)	Spectrum Bandwidth of a Direct Sequence Spread Spectrum System Limit: min. 500kHz	PASS	Meet the requirement of limit.
15.247(b)	Maximum Peak Output Power Limit: max. 30dBm	PASS	Meet the requirement of limit.
15.247(d)	Radiated Emissions Limit: Table 15.209	PASS	Meet the requirement of limit. Minimum passing margin is -1.30dB at 550.00MHz
15.247(e)	Power Spectral Density Limit: max. 8dBm	PASS	Meet the requirement of limit.
15.247(d)	Band Edge Measurement Limit: 20dB less than the peak value of fundamental frequency	PASS	Meet the requirement of limit.

NOTE:

1. The EUT was operating in 2.412 ~ 2.462GHz, 5.25~5.35GHz, 5.47~5.725GHz and 5.725~5.850GHz frequencies band. This report was recorded the RF parameters 5.725 ~ 5.850GHz. For the 5.25~5.35GHz, 5.47~5.725GHz RF parameters was recorded in another test report.

2.1 MEASUREMENT UNCERTAINTY

Where relevant, the following measurement uncertainty levels have been estimated for tests performed on the EUT as specified in CISPR 16-4:

This uncertainty represents an expanded uncertainty expressed at approximately the 95% confidence level using a coverage factor of $k=2$.

Measurement	Value
Conducted emissions	2.41 dB
Radiated emissions (30MHz-1GHz)	3.89 dB
Radiated emissions (1GHz ~18GHz)	2.21 dB
Radiated emissions (18GHz ~40GHz)	1.88 dB

3. GENERAL INFORMATION

3.1 GENERAL DESCRIPTION OF EUT

EUT	802.11a+b/g Outdoor AP/Bridge With Internal Antenna, 802.11a+b/g Outdoor AP/Bridge With External Antenna
MODEL NO.	AP5822, AP5822E
FCC ID	MAD-AP5822
POWER SUPPLY	48VDC from POE
MODULATION TYPE	CCK, DQPSK, DBPSK for DSSS 64QAM, 16QAM, QPSK, BPSK for OFDM
MODULATION TECHNOLOGY	DSSS, OFDM
TRANSFER RATE	802.11b: 11/5.5/2/1Mbps 802.11g: 54/48/36/24/18/12/9/6Mbps 802.11a: 54/48/36/24/18/12/9/6Mbps (Turbo mode: up to 108Mbps *see Note 1)
FREQUENCY RANGE	802.11b & 802.11g: 2412 ~ 2462MHz 802.11a: 5.25~5.35GHz, 5.47~5.725GHz and 5.725~5.850GHz
NUMBER OF CHANNEL	802.11b & 802.11g: 11 802.11a: 20 (FCC15.247: 2 for Turbo mode)
CHANNEL SPACING	802.11b & 802.11g: 5MHz 802.11a: 20MHz for Normal mode / 40MHz for Turbo mode
OUTPUT POWER	For FCC15.247: 385.478mW For FCC15.407: 42.855mW
ANTENNA TYPE	Please see note 3 (on next page)

NOTE:

1. This EUT is capable of providing data rates of up to 108Mbps in Turbo Mode depending upon reception quality.
2. The EUT has two model names which are identical to each other in all aspects except for the followings:

Brand Name	Model Name	Product Name	Description
MTI	AP5822	802.11a+b/g Outdoor AP/Bridge With Internal Antenna	2.4G external antenna and 5G Internal Antenna
	AP5822E	802.11a+b/g Outdoor AP/Bridge With External Antenna	2.4G external antenna and 5G External Antenna

3. This report is prepared for FCC class II permissive change. The difference compared with the Report No.:RF930507H07 design is as the following

u Add one external antenna for AP5822E as below:

Original Report (Report No.:RF930507H07)				
For 2.4GHz				
No.	Model No.	Gain (dBi)	Antenna Type	Antenna Connector
1	R0305-164	8.0dBi	Dipole, Omni (External Antenna)	N (Plug)
For 5GHz				
No.	Model No.	Gain (dBi)	Antenna Type	Antenna Connector
1	ANT05535	17.0dBi	Directional, Patch Panel (Internal Antenna)	Probe Pin
2	R0420-058	8.0dBi	Dipole, Omni (External Antenna)	N (Plug)
3	MTI09009 (4C10021)	23.0dBi	Directional, Patch Panel (External Antenna)	N (Jack)
u Add one new antenna				
For 5GHz(5250~5850MHz):				
'No.	Model No.	Gain (dBi)	Antenna Type	Antenna Connector
A	1GP-51809	9.0dBi	Dipole, Omni (External Antenna)	N female(Plug)
u Add 5470~5725MHz (new band)				
'No.	Model No.	Gain (dBi)	Antenna Type	Antenna Connector
1	ANT05535	17.0dBi	Directional, Patch Panel (Internal Antenna)	Probe Pin

4. The EUT was tested with following modes:

Model No.	Description
AP5822	With 5GHz, antenna 1 (test band:5470~5725MHz)
AP5822E	With new external antenna (test band: 5250~5850MHz)

5. The above EUT information was declared by the manufacturer and for more detailed features description, please refer to the manufacturer's specifications or User's Manual.

3.2 DESCRIPTION OF TEST MODES

Operated in 5725 ~ 5850MHz band:

Five channels are provided to this EUT.

Channel	Frequency
1	5745 MHz
2	5765 MHz
3	5785 MHz
4	5805 MHz
5	5825 MHz

Two channels are provided to this EUT for turbo mode.

Channel	Frequency
1	5760 MHz
2	5800 MHz

3.2.1 TEST MODE APPLICABILITY AND TESTED CHANNEL DETAIL:

EUT configure mode	Applicable to				Description
	PLC	RE<1G	RE≥1G	APCM	
-	√	√	√	√	NA

Where PLC: Power Line Conducted Emission

RE<1G RE: Radiated Emission below 1GHz

RE≥1G: Radiated Emission above 1GHz

APCM: Antenna Port Conducted Measurement

Power Line Conducted Emission Test:

- Pre-Scan has been conducted to determine the worst-case mode from all possible combinations between available modulations, data rates and antenna ports (if EUT with antenna diversity architecture).
- Following channel(s) was (were) selected for the final test as listed below.

Mode	Available Channel	Tested Channel	Modulation Technology	Modulation Type	Data Rate (Mbps)
802.11a	1 to 5	5	OFDM	BPSK	6

Radiated Emission Test (Below 1 GHz):

- Pre-Scan has been conducted to determine the worst-case mode from all possible combinations between available modulations, data rates and antenna ports (if EUT with antenna diversity architecture).
- Following channel(s) was (were) selected for the final test as listed below.

Mode	Available Channel	Tested Channel	Modulation Technology	Modulation Type	Data Rate (Mbps)
802.11a	1 to 5	5	OFDM	BPSK	6

Radiated Emission Test (Above 1 GHz):

- Pre-Scan has been conducted to determine the worst-case mode from all possible combinations between available modulations, data rates and antenna ports (if EUT with antenna diversity architecture).
- Following channel(s) was (were) selected for the final test as listed below.

Mode	Available Channel	Tested Channel	Modulation Technology	Modulation Type	Data Rate (Mbps)
802.11a	1 to 5	1, 3, 5	OFDM	BPSK	6
802.11a turbo	1, 2	1, 2	OFDM	BPSK	12

Bandedge Measurement:

- Pre-Scan has been conducted to determine the worst-case mode from all possible combinations between available modulations, data rates and antenna ports (if EUT with antenna diversity architecture).
- Following channel(s) was (were) selected for the final test as listed below.

Mode	Available Channel	Tested Channel	Modulation Technology	Modulation Type	Data Rate (Mbps)
802.11a	1 to 5	1, 5	OFDM	BPSK	6
802.11a turbo	1, 2	1, 2	OFDM	BPSK	12

Antenna Port Conducted Measurement:

- Pre-Scan has been conducted to determine the worst-case mode from all possible combinations between available modulations, data rates and antenna ports (if EUT with antenna diversity architecture).
- Following channel(s) was (were) selected for the final test as listed below.

Mode	Available Channel	Tested Channel	Modulation Technology	Modulation Type	Data Rate (Mbps)
802.11a	1 to 5	1, 3, 5	OFDM	BPSK	6
802.11a turbo	1, 2	1, 2	OFDM	BPSK	12

3.3 GENERAL DESCRIPTION OF APPLIED STANDARDS

The EUT is an 802.11a+b/g Outdoor AP/Bridge With Internal Antenna and 802.11a+b/g Outdoor AP/Bridge With External Antenna. According to the specifications of the manufacturer, it must comply with the requirements of the following standards:

FCC Part 15, Subpart C. (15.247)

ANSI C63.4-2003

All test items have been performed and recorded as per the above standards.

NOTE: The EUT is also considered as a kind of computer peripheral, because the connection to computer is necessary for typical use. It has been verified to comply with the requirements of FCC Part 15, Subpart B, Class B (DoC). The test report has been issued separately.



3.4 DESCRIPTION OF SUPPORT UNITS

The EUT has been tested as an independent unit together with other necessary accessories or support units. The following support units or accessories were used to form a representative test configuration during the tests.

No.	Product	Brand	Model No.	Serial No.	FCC ID
1	NOTEBOOK COMPUTER	DELL	PP19L	CN-OHC416-70166- 5CA-0448	PIW632500516610

No.	Signal cable description
1	NA

Note: 1. All power cords of the above support units are unshielded (1.8m).

3.5 CONFIGURATION OF SYSTEM UNDER TEST

For Conducted Test:

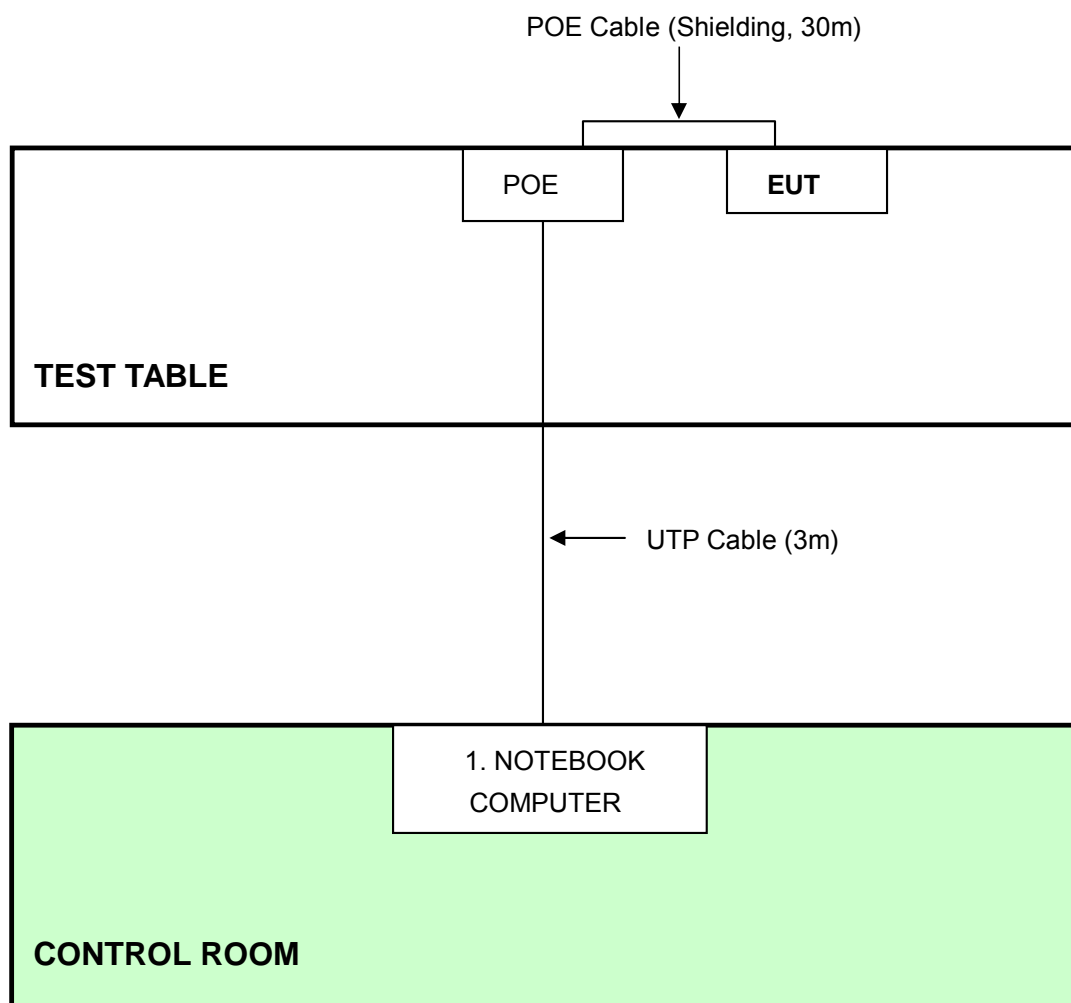

- NOTE:**
1. Support unit 1 was kept in the control room during the test.
 2. Please refer to the photos of test configuration.

For Radiated Test:

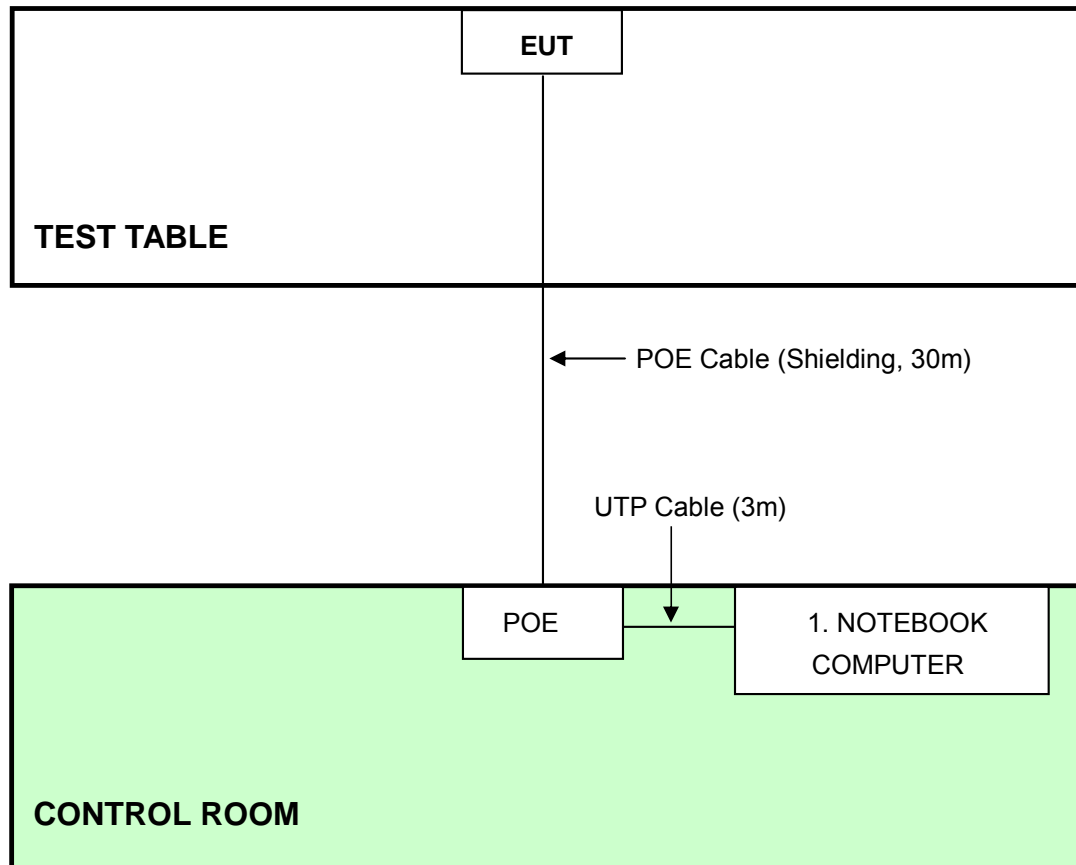

- NOTE:** 1. Support unit 1 was kept in the control room during the test.
2. Please refer to the photos of test configuration.



4. TEST TYPES AND RESULTS (802.11a, 5725~5850MHz Band)

4.1 CONDUCTED EMISSION MEASUREMENT

4.1.1 LIMITS OF CONDUCTED EMISSION MEASUREMENT

FREQUENCY OF EMISSION (MHz)	CONDUCTED LIMIT (dB μ V)	
	Quasi-peak	Average
0.15-0.5	66 to 56	56 to 46
0.5-5	56	46
5-30	60	50

- NOTE:**
1. The lower limit shall apply at the transition frequencies.
 2. The limit decreases in line with the logarithm of the frequency in the range of 0.15 to 0.50 MHz.
 3. All emanations from a class A/B digital device or system, including any network of conductors and apparatus connected thereto, shall not exceed the level of field strengths specified above.

4.1.2 TEST INSTRUMENTS

DESCRIPTION & MANUFACTURER	MODEL NO.	SERIAL NO.	CALIBRATED UNTIL
ROHDE & SCHWARZ Test Receiver	ESCS 30	100287	Mar. 06, 2008
Line-Impedance Stabilization Network(for EUT)	ENV-216	100072	Oct. 20, 2007
Line-Impedance Stabilization Network(for Peripheral)	KNW-407	8-1395-12	Aug. 15, 2007
RF Cable (JETBAO)	RG233/U	Cable_CA_01	Jul. 19, 2007
Terminator	50	1	Oct. 30, 2007
Software	ADT_Cond_V7.3.2	NA	NA

- NOTE:**
1. The calibration interval of the above test instruments is 12 months and the calibrations are traceable to NML/ROC and NIST/USA.
 2. The test was performed in ADT Shielded Room No. A.
 3. The VCCI Con A Registration No. is C-817.

4.1.3 TEST PROCEDURES

- a. The EUT was placed 0.4 meters from the conducting wall of the shielded room with EUT being connected to the power mains through a line impedance stabilization network (LISN). Other support units were connected to the power mains through another LISN. The two LISNs
- b. provide 50 ohm/ 50uH of coupling impedance for the measuring instrument.
- c. Both lines of the power mains connected to the EUT were checked for maximum conducted interference.
- d. The frequency range from 150kHz to 30MHz was searched. Emission level under (Limit – 20dB) was not recorded.

4.1.4 DEVIATION FROM TEST STANDARD

No deviation

4.1.5 TEST SETUP

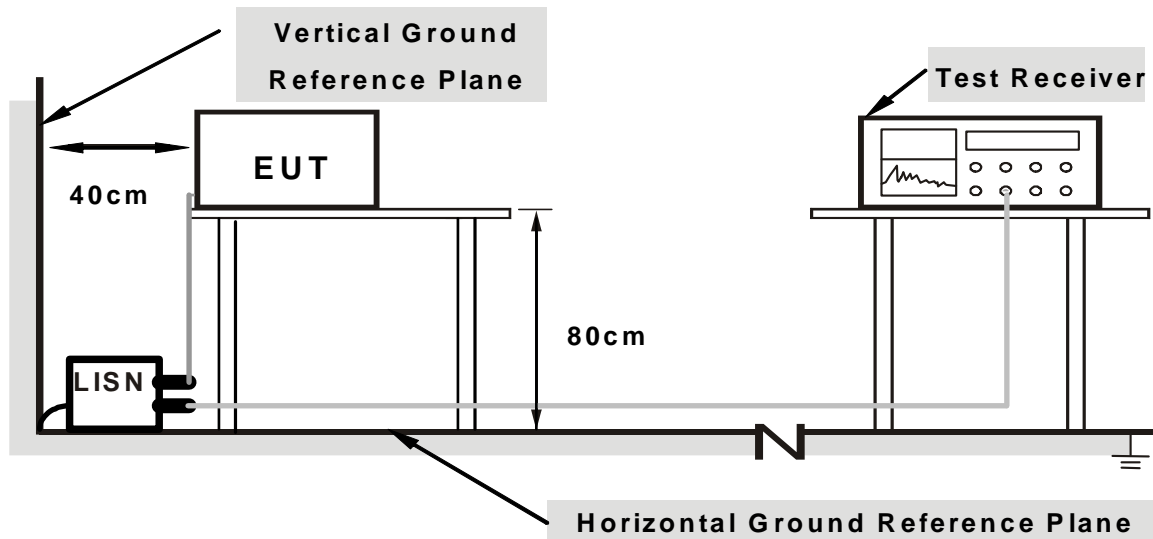

Note: 1. Support units were connected to second LISN.

2. Both of LISNs (AMN) are 80 cm from EUT and at least 80 from other units and other metal planes

For the actual test configuration, please refer to the related item – Photographs of the Test Configuration.

4.1.6 EUT OPERATING CONDITIONS

- a. Placed the EUT on the testing table.
- b. Prepared another computer system to act as a communication partner and placed it outside of testing area.
- c. The communication partners run a test program “Art 48 b 5” to enable EUT under transmission/receiving condition continuously at specific channel frequency via RJ 45 cable and wireless.

4.1.7 TEST RESULTS

Conducted Worst-Case Data

MODULATION TYPE	BPSK	6dB BANDWIDTH	9 kHz
INPUT POWER (SYSTEM)	120Vac, 60 Hz	TRANSFER RATE	6Mbps
ENVIRONMENTAL CONDITIONS	15deg. C, 60%RH, 972hPa	PHASE	Line (L)
TESTED BY	Wen Yu		

No	Freq. [MHz]	Corr. Factor (dB)	Reading Value [dB (uV)]		Emission Level [dB (uV)]		Limit [dB (uV)]		Margin (dB)	
			Q.P.	AV.	Q.P.	AV.	Q.P.	AV.	Q.P.	AV.
	1	0.150	9.75	27.39	-	37.14	-	66.00	56.00	-28.86
2	0.209	9.80	36.86	-	46.66	-	63.26	53.26	-16.60	-
3	0.279	9.80	32.31	-	42.11	-	60.85	50.85	-18.74	-
4	0.349	9.80	26.33	-	36.13	-	58.98	48.98	-22.85	-
5	0.486	9.81	19.91	-	29.72	-	56.24	46.24	-26.51	-
6	21.629	10.13	23.55	-	33.68	-	60.00	50.00	-26.32	-

- REMARKS:**
1. Q.P. and AV. are abbreviations of quasi-peak and average individually.
 2. "-": The Quasi-peak reading value also meets average limit and measurement with the average detector is unnecessary.
 3. The emission levels of other frequencies were very low against the limit.
 4. Margin value = Emission level - Limit value
 5. Correction factor = Insertion loss + Cable loss
 6. Emission Level = Correction Factor + Reading Value.

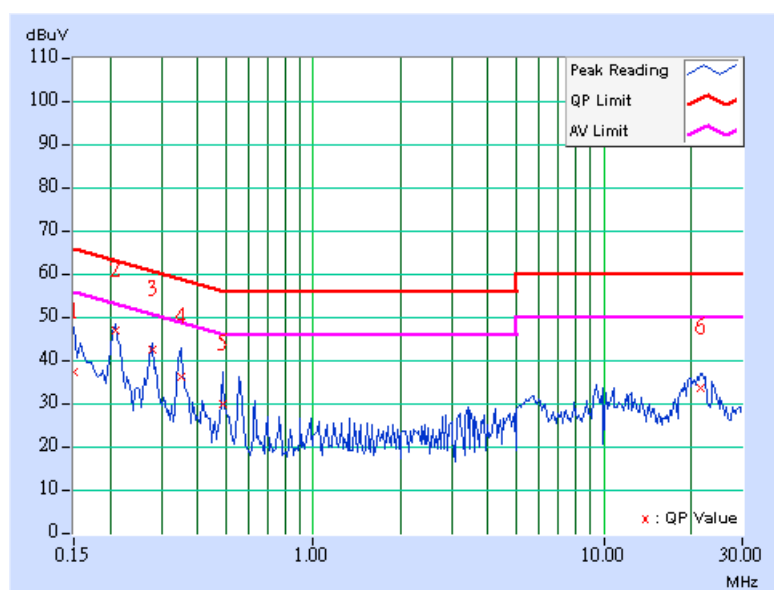

MODULATION TYPE	BPSK	6dB BANDWIDTH	9 kHz
INPUT POWER (SYSTEM)	120Vac, 60 Hz	TRANSFER RATE	6Mbps
ENVIRONMENTAL CONDITIONS	15deg. C, 60%RH, 972hPa	PHASE	Neutral (N)
TESTED BY	Wen Yu		

No	Freq. [MHz]	Corr. Factor (dB)	Reading Value [dB (uV)]		Emission Level [dB (uV)]		Limit [dB (uV)]		Margin (dB)	
			Q.P.	AV.	Q.P.	AV.	Q.P.	AV.	Q.P.	AV.
			1	0.150	9.80	24.94	-	34.74	-	66.00
2	0.209	9.80	32.45	-	42.25	-	63.26	53.26	-21.01	-
3	0.279	9.80	29.87	-	39.67	-	60.85	50.85	-21.18	-
4	0.345	9.80	27.84	-	37.64	-	59.07	49.07	-21.43	-
5	0.486	9.81	17.96	-	27.77	-	56.24	46.24	-28.46	-
6	19.941	10.40	23.75	-	34.15	-	60.00	50.00	-25.85	-

- REMARKS:**
1. Q.P. and AV. are abbreviations of quasi-peak and average individually.
 2. "-": The Quasi-peak reading value also meets average limit and measurement with the average detector is unnecessary.
 3. The emission levels of other frequencies were very low against the limit.
 4. Margin value = Emission level - Limit value
 5. Correction factor = Insertion loss + Cable loss
 6. Emission Level = Correction Factor + Reading Value.

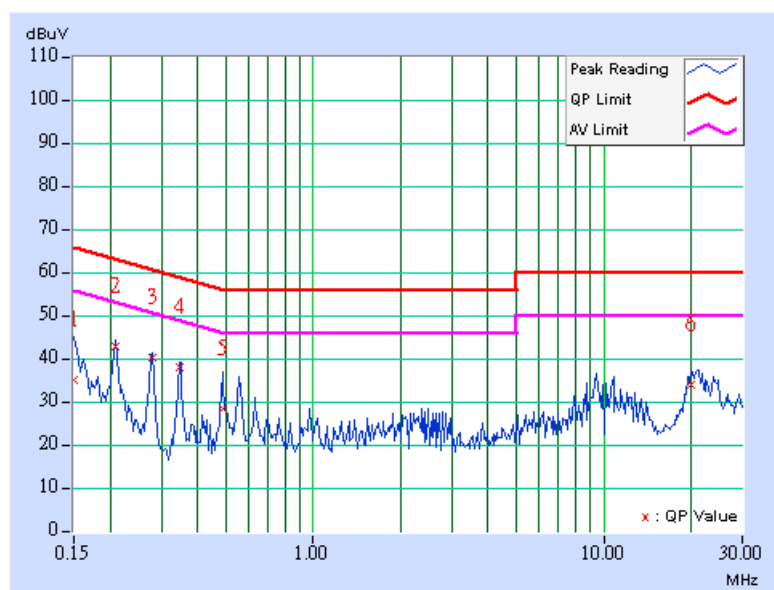

4.2 RADIATED EMISSION MEASUREMENT

4.2.1 LIMITS OF RADIATED EMISSION MEASUREMENT

Emissions radiated outside of the specified bands, shall be according to the general radiated limits in 15.209 as following:

Frequencies (MHz)	Field strength (microvolts/meter)	Measurement distance (meters)
0.009-0.490	2400/F(kHz)	300
0.490-1.705	24000/F(kHz)	30
1.705-30.0	30	30
30-88	100	3
88-216	150	3
216-960	200	3
Above 960	500	3

NOTE:

1. The lower limit shall apply at the transition frequencies.
2. Emission level (dBuV/m) = 20 log Emission level (uV/m).
3. As shown in 15.35(b), for frequencies above 1000MHz, the field strength limits are based on average detector, however, the peak field strength of any emission shall not exceed the maximum permitted average limits, specified above by more than 20dB under any condition of modulation.



4.2.2 TEST INSTRUMENTS

DESCRIPTION & MANUFACTURER	MODEL NO.	SERIAL NO.	CALIBRATED UNTIL
ADVANTEST Spectrum Analyzer	R3271A	85060311	July 03, 2007
HP Pre_Amplifier	8449B	3008A01922	Sep. 18, 2007
ROHDE & SCHWARZ Test Receiver	ESCS30	100375	Sep. 20, 2007
CHASE Broadband Antenna	VULB9168	138	Dec. 10, 2007
Schwarzbeck Horn_Antenna	BBHA9120	D124	Jan. 01, 2008
Schwarzbeck Horn_Antenna	BBHA 9170	BBHA9170153	Jan. 04, 2008
SCHWARZBECK Biconical Antenna	VHBA9123	459	Jun. 08, 2009
SCHWARZBECK Periodic Antenna	UPA6108	1148	Jun. 08, 2009
R&S Loop Antenna	HFH2-Z2	881058/15	Nov. 29, 2007
RF Switches (ARNITSU)	CS-201	1565157	NA
RF CABLE (Chaintek)	SF102	22054-2	Nov. 14. 2007
RF Cable(RICHTEC)	9913-30M N-N Cable	STCCAB-30M-1 GHz	Jul. 15, 2007
Software	ADT_Radiated_V 5.14	NA	NA
CHANCE MOST Antenna Tower	AT-100	0203	NA
CHANCE MOST Turn Table	TT-100	0203	NA

- Note: 1. The calibration interval of the above test instruments is 12 months (36 months for Biconical and Periodic Antenna) and the calibrations are traceable to NML/ROC and NIST/USA.
2. The horn antenna, HP preamplifier (model: 8449B) and Spectrum Analyzer (model: R3271A) are used only for the measurement of emission frequency above 1GHz if tested.
3. The test was performed in ADT Open Site No. C.
4. The FCC Site Registration No. is 656396.
5. The VCCI Site Registration No. is R-1626.
6. The CANADA Site Registration No. is IC 4824A-3.
7. Loop antenna was used for all emissions below 30 MHz.

4.2.3 TEST PROCEDURES

- a. The EUT was placed on the top of a rotating table 0.8 meters above the ground at a 3 meter semi-anechoic chamber. The table was rotated 360 degrees to determine the position of the highest radiation.
- b. The EUT was set 3 meters away from the interference-receiving antenna, which was mounted on the top of a variable-height antenna tower.
- c. The antenna is a broadband antenna, and its height is varied from one meter to four meters above the ground to determine the maximum value of the field strength. Both horizontal and vertical polarizations of the antenna are set to make the measurement.
- d. For each suspected emission, the EUT was arranged to its worst case and then the antenna was tuned to heights from 1 meter to 4 meters and the rotatable table was turned from 0 degrees to 360 degrees to find the maximum reading.
- e. The test-receiver system was set to Peak Detect Function and Specified Bandwidth with Maximum Hold Mode.
- f. If the emission level of the EUT in peak mode was 10dB lower than the limit specified, then testing could be stopped and the peak values of the EUT would be reported. Otherwise the emissions that did not have 10dB margin would be re-tested one by one using peak, quasi-peak or average method as specified and then reported in a data sheet.

NOTE:

1. The resolution bandwidth and video bandwidth of test receiver/spectrum analyzer is 120kHz for Peak detection (PK) and Quasi-peak detection (QP) at frequency below 1GHz.
2. The resolution bandwidth is 1MHz and video bandwidth of test receiver/spectrum analyzer is 3MHz for Peak detection at frequency above 1GHz. The resolution bandwidth of test receiver/spectrum analyzer is 1 MHz for Average detection (AV) at frequency above 1GHz.
3. The resolution bandwidth of test receiver/spectrum analyzer is 1 MHz and the video bandwidth is 10 Hz for Average detection (AV) at frequency above 1GHz.

4.2.4 DEVIATION FROM TEST STANDARD

No deviation

4.2.5 TEST SETUP

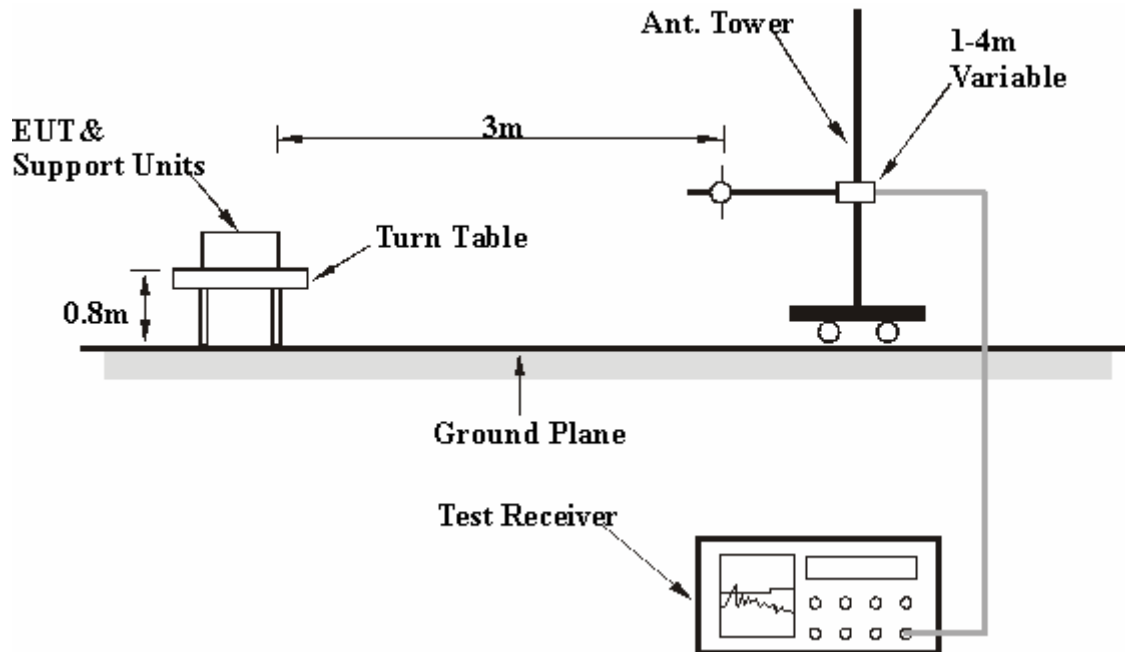

For the actual test configuration, please refer to the related item – Photographs of the Test Configuration.

4.2.6 EUT OPERATING CONDITIONS

- a. Placed the EUT on the testing table.
- b. Prepared another computer system to act as a communication partner and placed it outside of testing area.
- c. The communication partner run a test program “Art 48 b 5” to enable EUT under transmission/receiving condition continuously at specific channel frequency via RJ 45 cable and wireless.

4.2.7 TEST RESULTS

Below 1GHz Worst-Case Data

MODULATION TYPE	BPSK	FREQUENCY RANGE	Below 1000MHz
INPUT POWER (SYSTEM)	120Vac, 60 Hz	TRANSFER RATE	6Mbps
ENVIRONMENTAL CONDITIONS	20deg. C, 65%RH, 972hPa	DETECTOR FUNCTION	Quasi-Peak
TESTED BY	Phoenix Huang		

ANTENNA POLARITY & TEST DISTANCE: HORIZONTAL AT 3 M

No.	Freq. (MHz)	Emission Level (dBuV/m)	Limit (dBuV/m)	Margin (dB)	Antenna Height (m)	Table Angle (Degree)	Raw Value (dBuV)	Correction Factor (dB/m)
1	125.00	25.40 QP	43.50	-18.10	1.00 H	21	13.10	12.20
2	187.50	26.60 QP	43.50	-16.90	1.00 H	21	14.20	12.50
3	250.06	33.90 QP	46.00	-12.10	1.30 H	286	20.10	13.80
4	440.20	33.00 QP	46.00	-13.00	1.35 H	31	12.80	20.20
5	550.00	44.70 QP	46.00	-1.30	1.68 H	345	21.50	23.20
6	660.00	35.10 QP	46.00	-10.90	1.15 H	335	9.90	25.20
7	770.00	34.60 QP	46.00	-11.40	1.00 H	342	7.20	27.40
8	880.00	32.20 QP	46.00	-13.80	1.00 H	60	3.50	28.70

ANTENNA POLARITY & TEST DISTANCE: VERTICAL AT 3 M

No.	Freq. (MHz)	Emission Level (dBuV/m)	Limit (dBuV/m)	Margin (dB)	Antenna Height (m)	Table Angle (Degree)	Raw Value (dBuV)	Correction Factor (dB/m)
1	62.10	27.50 QP	40.00	-12.50	1.00 V	220	14.00	13.50
2	125.00	29.00 QP	43.50	-14.50	1.00 V	274	16.80	12.20
3	187.50	27.90 QP	43.50	-15.60	1.00 V	330	15.40	12.50
4	440.00	33.00 QP	46.00	-13.00	1.00 V	2	12.80	20.20
5	550.00	43.10 QP	46.00	-2.90	1.00 V	259	19.90	23.20
6	660.00	34.60 QP	46.00	-11.40	1.03 V	14	9.40	25.20
7	770.00	37.60 QP	46.00	-8.40	1.21 V	274	10.20	27.40
8	899.40	38.60 QP	46.00	-7.40	1.16 V	60	9.80	28.80

- REMARKS:**
1. Emission level(dBuV/m)=Raw Value(dBuV) + Correction Factor(dB/m)
 2. Correction Factor(dB/m) = Antenna Factor (dB/m) + Cable Factor (dB)
 3. The other emission levels were very low against the limit.
 4. Margin value = Emission level – Limit value



4.2.8 TEST RESULTS – ANTENNA A 802.11a OFDM modulation

CHANNEL	Channel 1	FREQUENCY RANGE	1 ~ 40 GHz
MODULATION TYPE	BPSK	TRANSFER RATE	6Mbps
INPUT POWER (SYSTEM)	120Vac, 60 Hz	DETECTOR FUNCTION	Peak(PK) Average (AV)
ENVIRONMENTAL CONDITIONS	23deg. C, 56%RH, 972hPa	TESTED BY	Phoenix Huang

ANTENNA POLARITY & TEST DISTANCE: HORIZONTAL AT 3 M								
No.	Freq. (MHz)	Emission Level (dBuV/m)	Limit (dBuV/m)	Margin (dB)	Antenna Height (m)	Table Angle (Degree)	Raw Value (dBuV)	Correction Factor (dB/m)
1	*5745.00	107.20 PK			1.00 H	54	69.60	37.60
1	*5745.00	95.20 AV			1.00 H	54	57.60	37.60
2	#11490.00	60.80 PK	74.00	-13.20	1.43 H	324	13.80	47.00
2	#11490.00	46.80 AV	54.00	-7.20	1.43 H	324	-0.20	47.00

ANTENNA POLARITY & TEST DISTANCE: VERTICAL AT 3 M								
No.	Freq. (MHz)	Emission Level (dBuV/m)	Limit (dBuV/m)	Margin (dB)	Antenna Height (m)	Table Angle (Degree)	Raw Value (dBuV)	Correction Factor (dB/m)
1	*5745.00	119.50 PK			1.40 V	42	81.90	37.60
1	*5745.00	108.30 AV			1.40 V	42	70.70	37.60
2	#11490.00	60.30 PK	74.00	-13.70	1.46 V	319	13.30	47.00
2	#11490.00	46.70 AV	54.00	-7.30	1.46 V	319	-0.30	47.00

- NOTE:**
1. Emission level(dBuV/m)=Raw Value(dBuV) + Correction Factor(dB/m)
 2. Correction Factor(dB/m) = Antenna Factor (dB/m) + Cable Factor (dB)
 3. The other emission levels were very low against the limit.
 4. Margin value = Emission level – Limit value
 5. "*" : Fundamental frequency
 6. "#"The radiated frequency falling in the restricted band.
 7. The limit value is defined as per 15.247



CHANNEL	Channel 3	FREQUENCY RANGE	1 ~ 40 GHz
MODULATION TYPE	BPSK	TRANSFER RATE	6Mbps
INPUT POWER (SYSTEM)	120Vac, 60 Hz	DETECTOR FUNCTION	Peak(PK) Average (AV)
ENVIRONMENTAL CONDITIONS	23deg. C, 56%RH, 972hPa	TESTED BY	Phoenix Huang

ANTENNA POLARITY & TEST DISTANCE: HORIZONTAL AT 3 M								
No.	Freq. (MHz)	Emission Level (dBuV/m)	Limit (dBuV/m)	Margin (dB)	Antenna Height (m)	Table Angle (Degree)	Raw Value (dBuV)	Correction Factor (dB/m)
1	*5785.00	105.30 PK			1.13 H	204	67.60	37.70
1	*5785.00	93.60 AV			1.13 H	204	55.90	37.70
2	#11570.00	59.70 PK	74.00	-14.30	1.30 H	280	12.80	47.00
2	#11570.00	46.00 AV	54.00	-8.00	1.30 H	280	-0.90	47.00

ANTENNA POLARITY & TEST DISTANCE: VERTICAL AT 3 M								
No.	Freq. (MHz)	Emission Level (dBuV/m)	Limit (dBuV/m)	Margin (dB)	Antenna Height (m)	Table Angle (Degree)	Raw Value (dBuV)	Correction Factor (dB/m)
1	*5785.00	119.80 PK			1.38 V	215	82.10	37.70
1	*5785.00	108.40 AV			1.38 V	215	70.70	37.70
2	#11570.00	59.80 PK	74.00	-14.20	1.21 V	321	12.90	47.00
2	#11570.00	46.20 AV	54.00	-7.80	1.21 V	321	-0.70	47.00

- NOTE:**
1. Emission level(dBuV/m)=Raw Value(dBuV) + Correction Factor(dB/m)
 2. Correction Factor(dB/m) = Antenna Factor (dB/m) + Cable Factor (dB)
 3. The other emission levels were very low against the limit.
 4. Margin value = Emission level – Limit value
 5. "*" : Fundamental frequency
 6. "#"The radiated frequency falling in the restricted band.
 7. The limit value is defined as per 15.247



CHANNEL	Channel 5	FREQUENCY RANGE	1 ~ 40 GHz
MODULATION TYPE	BPSK	TRANSFER RATE	6Mbps
INPUT POWER (SYSTEM)	120Vac, 60 Hz	DETECTOR FUNCTION	Peak(PK) Average (AV)
ENVIRONMENTAL CONDITIONS	23deg. C, 56%RH, 972hPa	TESTED BY	Phoenix Huang

ANTENNA POLARITY & TEST DISTANCE: HORIZONTAL AT 3 M								
No.	Freq. (MHz)	Emission Level (dBuV/m)	Limit (dBuV/m)	Margin (dB)	Antenna Height (m)	Table Angle (Degree)	Raw Value (dBuV)	Correction Factor (dB/m)
1	*5825.00	106.90 PK			1.15 H	244	69.10	37.80
1	*5825.00	94.80 AV			1.15 H	244	57.00	37.80
2	#11650.00	60.00 PK	74.00	-14.00	1.34 H	328	13.20	46.90
2	#11650.00	45.80 AV	54.00	-8.20	1.34 H	328	-1.00	46.90

ANTENNA POLARITY & TEST DISTANCE: VERTICAL AT 3 M								
No.	Freq. (MHz)	Emission Level (dBuV/m)	Limit (dBuV/m)	Margin (dB)	Antenna Height (m)	Table Angle (Degree)	Raw Value (dBuV)	Correction Factor (dB/m)
1	*5825.00	120.10 PK			1.38 V	308	82.30	37.80
1	*5825.00	109.00 AV			1.38 V	308	71.20	37.80
2	#11650.00	59.10 PK	74.00	-14.90	1.45 V	320	12.30	46.90
2	#11650.00	45.30 AV	54.00	-8.70	1.45 V	320	-1.50	46.90

- NOTE:**
1. Emission level(dBuV/m)=Raw Value(dBuV) + Correction Factor(dB/m)
 2. Correction Factor(dB/m) = Antenna Factor (dB/m) + Cable Factor (dB)
 3. The other emission levels were very low against the limit.
 4. Margin value = Emission level – Limit value
 5. "*" : Fundamental frequency
 6. "#"The radiated frequency falling in the restricted band.
 7. The limit value is defined as per 15.247

802.11a Turbo OFDM modulation

CHANNEL	Channel 1	FREQUENCY RANGE	1 ~ 40 GHz
MODULATION TYPE	BPSK	TRANSFER RATE	12Mbps
INPUT POWER (SYSTEM)	120Vac, 60 Hz	DETECTOR FUNCTION	Peak(PK) Average (AV)
ENVIRONMENTAL CONDITIONS	23deg. C, 56%RH, 972hPa	TESTED BY	Phoenix Huang

ANTENNA POLARITY & TEST DISTANCE: HORIZONTAL AT 3 M								
No.	Freq. (MHz)	Emission Level (dBuV/m)	Limit (dBuV/m)	Margin (dB)	Antenna Height (m)	Table Angle (Degree)	Raw Value (dBuV)	Correction Factor (dB/m)
1	*5760.00	103.30 PK			1.00 H	15	65.60	37.70
1	*5760.00	92.10 AV			1.00 H	15	54.40	37.70
2	#11520.00	58.90 PK	74.00	-15.10	1.39 H	321	11.90	47.00
2	#11520.00	45.10 AV	54.00	-8.90	1.39 H	321	-1.90	47.00

ANTENNA POLARITY & TEST DISTANCE: VERTICAL AT 3 M								
No.	Freq. (MHz)	Emission Level (dBuV/m)	Limit (dBuV/m)	Margin (dB)	Antenna Height (m)	Table Angle (Degree)	Raw Value (dBuV)	Correction Factor (dB/m)
1	*5760.00	117.30 PK			1.52 V	108	79.60	37.70
1	*5760.00	106.10 AV			1.52 V	108	68.40	37.70
2	#11520.00	59.20 PK	74.00	-14.80	1.33 V	320	12.20	47.00
2	#11520.00	45.30 AV	54.00	-8.70	1.33 V	320	-1.70	47.00

- NOTE:**
1. Emission level(dBuV/m)=Raw Value(dBuV) + Correction Factor(dB/m)
 2. Correction Factor(dB/m) = Antenna Factor (dB/m) + Cable Factor (dB)
 3. The other emission levels were very low against the limit.
 4. Margin value = Emission level – Limit value
 5. "*" : Fundamental frequency
 6. "#"The radiated frequency falling in the restricted band.
 7. The limit value is defined as per 15.247



CHANNEL	Channel 2	FREQUENCY RANGE	1 ~ 40 GHz
MODULATION TYPE	BPSK	TRANSFER RATE	12Mbps
INPUT POWER (SYSTEM)	120Vac, 60 Hz	DETECTOR FUNCTION	Peak(PK) Average (AV)
ENVIRONMENTAL CONDITIONS	23deg. C, 56%RH, 972hPa	TESTED BY	Phoenix Huang

ANTENNA POLARITY & TEST DISTANCE: HORIZONTAL AT 3 M								
No.	Freq. (MHz)	Emission Level (dBuV/m)	Limit (dBuV/m)	Margin (dB)	Antenna Height (m)	Table Angle (Degree)	Raw Value (dBuV)	Correction Factor (dB/m)
1	*5800.00	104.20 PK			1.19 H	222	66.40	37.80
1	*5800.00	92.50 AV			1.19 H	222	54.70	37.80
2	#11600.00	58.40 PK	74.00	-15.60	1.62 H	280	11.50	46.90
2	#11600.00	44.70 AV	54.00	-9.30	1.62 H	280	-2.20	46.90

ANTENNA POLARITY & TEST DISTANCE: VERTICAL AT 3 M								
No.	Freq. (MHz)	Emission Level (dBuV/m)	Limit (dBuV/m)	Margin (dB)	Antenna Height (m)	Table Angle (Degree)	Raw Value (dBuV)	Correction Factor (dB/m)
1	*5800.00	118.20 PK			1.21 V	233	80.40	37.80
1	*5800.00	107.10 AV			1.21 V	233	69.30	37.80
2	#11600.00	58.20 PK	74.00	-15.80	1.62 V	316	11.30	46.90
2	#11600.00	44.90 AV	54.00	-9.10	1.62 V	316	-2.00	46.90

- NOTE:**
1. Emission level(dBuV/m)=Raw Value(dBuV) + Correction Factor(dB/m)
 2. Correction Factor(dB/m) = Antenna Factor (dB/m) + Cable Factor (dB)
 3. The other emission levels were very low against the limit.
 4. Margin value = Emission level – Limit value
 5. "*" : Fundamental frequency
 6. "#"The radiated frequency falling in the restricted band.
 7. The limit value is defined as per 15.247



4.3 6dB BANDWIDTH MEASUREMENT

4.3.1 LIMITS OF 6dB BANDWIDTH MEASUREMENT

The minimum of 6dB Bandwidth Measurement is 0.5 MHz.

4.3.2 TEST INSTRUMENTS

Description & Manufacturer	Model No.	Serial No.	Calibrated Until
R&S SPECTRUM ANALYZER	FSP40	100037	Aug. 15, 2007

NOTE:

- 1.The measurement uncertainty is less than +/- 2.6dB, which is calculated as per the NAMAS document NIS81. This uncertainty represents an expanded uncertainty expressed at approximately the 95% confidence level using a coverage factor of k=2.
- 2.The calibration interval of the above test instruments is 12 months and the calibrations are traceable to NML/ROC and NIST/USA.

4.3.3 TEST PROCEDURE

The transmitter output was connected to the spectrum analyzer through an attenuator. The bandwidth of the fundamental frequency was measured by spectrum analyzer with 100kHz RBW and 100kHz VBW. The 6dB bandwidth is defined as the total spectrum the power of which is higher than peak power minus 6dB.

4.3.4 DEVIATION FROM TEST STANDARD

No deviation

4.3.5 TEST SETUP

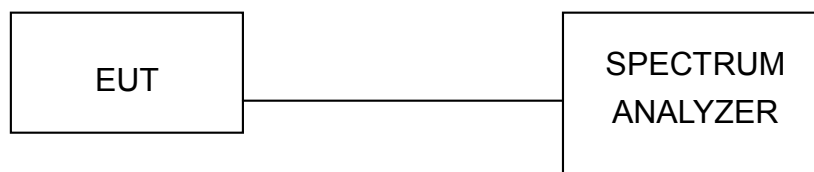

4.3.6 EUT OPERATING CONDITIONS

The software provided by client to enable the EUT under transmission condition continuously at lowest, middle and highest channel frequencies individually.

4.3.7 TEST RESULTS - ANTENNA A

802.11a OFDM modulation

MODULATION TYPE	BPSK	TRANSFER RATE	6Mbps
INPUT POWER (SYSTEM)	120Vac, 60 Hz	ENVIRONMENTAL CONDITIONS	23deg. C, 56%RH, 972hPa
TESTED BY	Wen Yu		

CHANNEL	CHANNEL FREQUENCY (MHz)	6dB BANDWIDTH (MHz)	MINIMUM LIMIT (MHz)	PASS/FAIL
1	5745	16.38	0.5	PASS
3	5785	16.45	0.5	PASS
5	5825	16.45	0.5	PASS

CH1

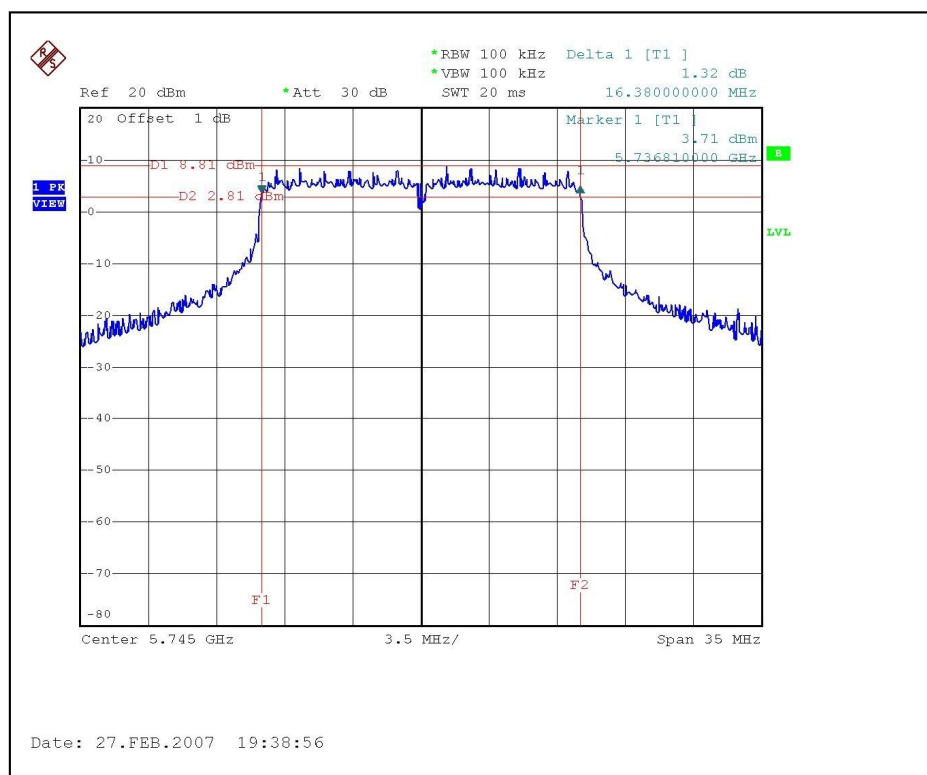

CH3

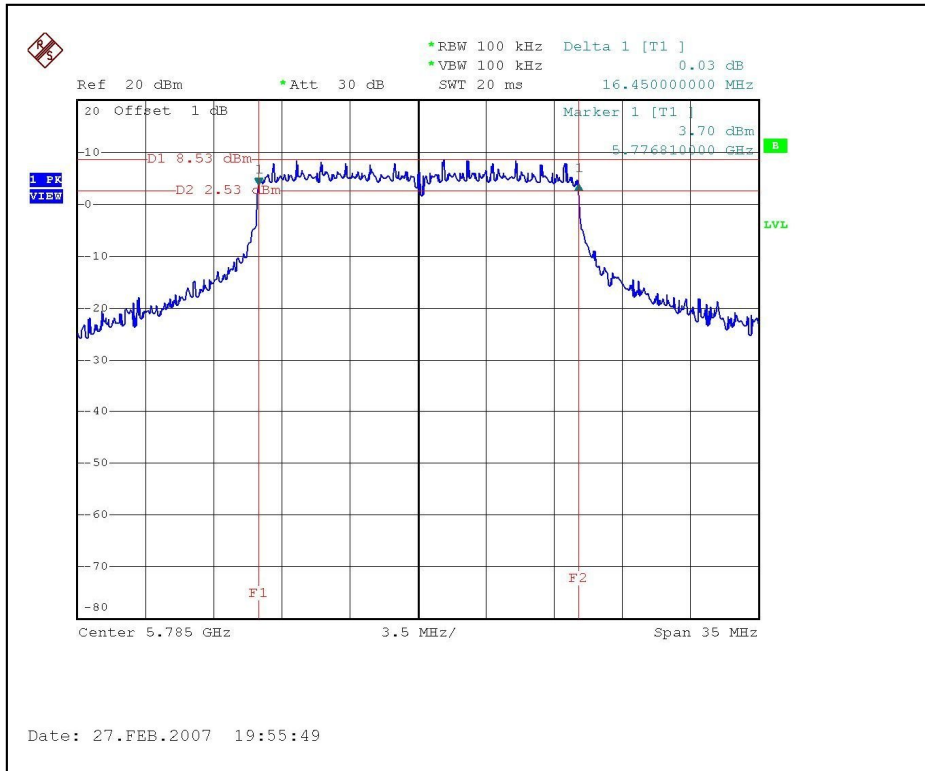

CH5

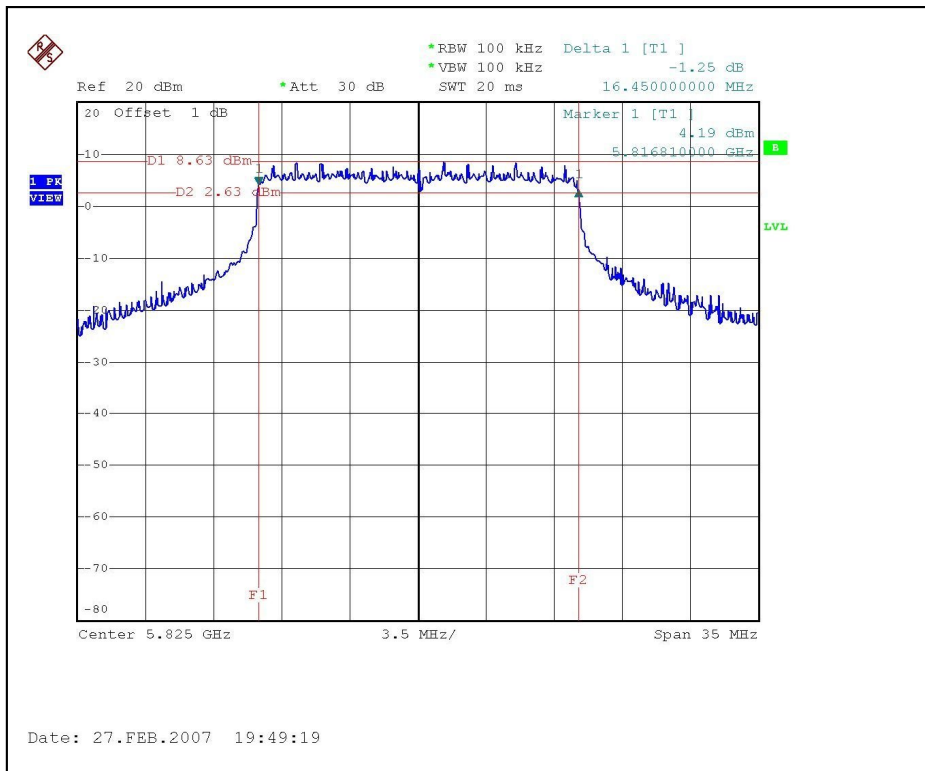



802.11a Turbo OFDM modulation

MODULATION TYPE	BPSK	TRANSFER RATE	12Mbps
INPUT POWER (SYSTEM)	120Vac, 60 Hz	ENVIRONMENTAL CONDITIONS	23deg. C, 56%RH, 972hPa
TESTED BY	Wen Yu		

CHANNEL	CHANNEL FREQUENCY (MHz)	6dB BANDWIDTH (MHz)	MINIMUM LIMIT (MHz)	PASS/FAIL
1	5760	32.67	0.5	PASS
2	5800	32.56	0.5	PASS

CH1

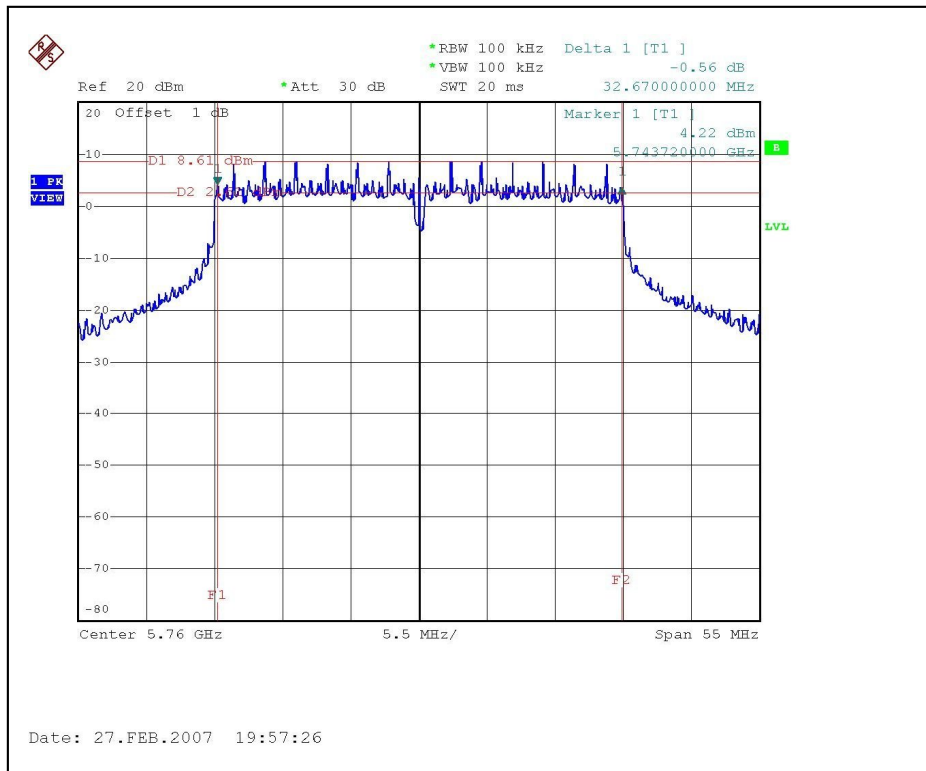

CH2

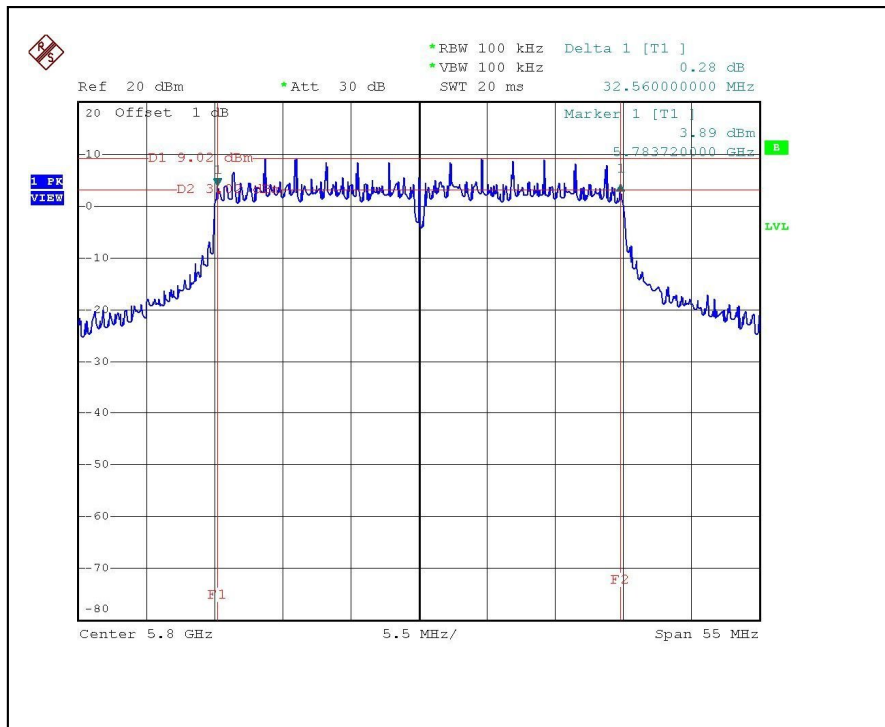



4.4 MAXIMUM PEAK OUTPUT POWER

4.4.1 LIMITS OF MAXIMUM PEAK OUTPUT POWER MEASUREMENT

The Maximum Peak Output Power Measurement is 30dBm.

4.4.2 INSTRUMENTS

Description & Manufacturer	Model No.	Serial No.	Calibrated Until
R&S SPECTRUM ANALYZER	FSP40	100037	Aug. 15, 2007
Agilent SIGNAL GENERATOR	E8257C	MY43321031	July 26, 2007
TEKTRONIX OSCILLOSCOPE	TDS380	B016335	Jun. 21, 2007
NARDA DETECTOR	4503A	FSCM99899	NA

NOTE:

The calibration interval of the above test instruments is 12 months and the calibrations are traceable to NML/ROC and NIST/USA.

4.4.3 TEST PROCEDURES

1. A detector was used on the output port of the EUT. An oscilloscope was used to read the response of the detector.
2. Replaced the EUT by the signal generator. The center frequency of the S.G was adjusted to the center frequency of the measured channel.
3. Adjusted the power to have the same reading on oscilloscope. Record the power level.

4.4.4 DEVIATION FROM TEST STANDARD

No deviation

4.4.5 TEST SETUP



4.4.6 EUT OPERATING CONDITIONS

Same as Item 4.3.6



4.4.7 TEST RESULTS - ANTENNA A

802.11a OFDM modulation

MODULATION TYPE	BPSK	TRANSFER RATE	6Mbps
INPUT POWER (SYSTEM)	120Vac, 60 Hz	ENVIRONMENTAL CONDITIONS	23deg. C, 56%RH, 972hPa
TESTED BY	Wen Yu		

CHANNEL	CHANNEL FREQUENCY (MHz)	PEAK POWER OUTPUT (mW)	PEAK POWER OUTPUT (dBm)	PEAK POWER LIMIT (dBm)	PASS/FAIL
1	5745	378.443	25.78	27	PASS
3	5785	385.478	25.86	27	PASS
5	5825	380.189	25.80	27	PASS



802.11a Turbo OFDM modulation

MODULATION TYPE	BPSK	TRANSFER RATE	12Mbps
INPUT POWER (SYSTEM)	120Vac, 60 Hz	ENVIRONMENTAL CONDITIONS	23deg. C, 56%RH, 972hPa
TESTED BY	Wen Yu		

CHANNEL	CHANNEL FREQUENCY (MHz)	PEAK POWER OUTPUT (mW)	PEAK POWER OUTPUT (dBm)	PEAK POWER LIMIT (dBm)	PASS/FAIL
1	5760	372.392	25.71	27	PASS
2	5800	369.828	25.68	27	PASS



4.5 POWER SPECTRAL DENSITY MEASUREMENT

4.5.1 LIMITS OF POWER SPECTRAL DENSITY MEASUREMENT

The Maximum of Power Spectral Density Measurement is 8dBm.

4.5.2 TEST INSTRUMENTS

Description & Manufacturer	Model No.	Serial No.	Calibrated Until
R&S SPECTRUM ANALYZER	FSP40	100037	Aug. 15, 2007

NOTE:

- 1.The measurement uncertainty is less than +/- 2.6dB, which is calculated as per the NAMAS document NIS81.
- 2.The calibration interval of the above test instruments is 12 months and the calibrations are traceable to NML/ROC and NIST/USA.

4.5.3 TEST PROCEDURE

The transmitter output was connected to the spectrum analyzer through an attenuator, the bandwidth of the fundamental frequency was measured with the spectrum analyzer using 3 kHz RBW and 30 kHz VBW, set sweep time = span/3 kHz. The power spectral density was measured and recorded.

The sweep time is allowed to be longer than span/3 kHz for a full response of the mixer in the spectrum analyzer.

4.5.4 DEVIATION FROM TEST STANDARD

No deviation

4.5.5 TEST SETUP

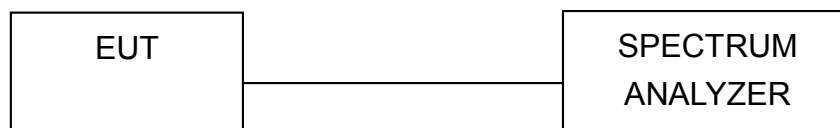

4.5.6 EUT OPERATING CONDITION

Same as Item 4.3.6

4.5.7 TEST RESULTS - ANTENNA A

802.11a OFDM modulation

MODULATION TYPE	BPSK	TRANSFER RATE	6Mbps
INPUT POWER (SYSTEM)	120Vac, 60 Hz	ENVIRONMENTAL CONDITIONS	23deg. C, 56%RH, 972hPa
TESTED BY	Wen Yu		

CHANNEL	CHANNEL FREQUENCY (MHz)	RF POWER LEVEL IN 3 kHz BW (dBm)	MAXIMUM LIMIT (dBm)	PASS/FAIL
1	5745	1.52	5	PASS
3	5785	2.76	5	PASS
5	5825	3.78	5	PASS

CH1

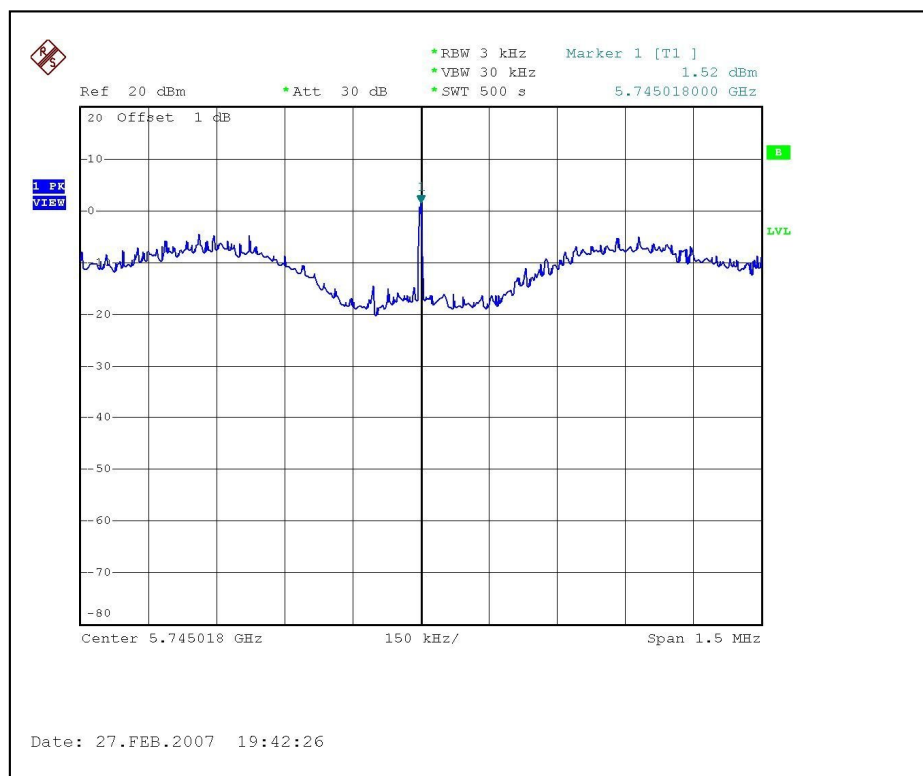

CH3

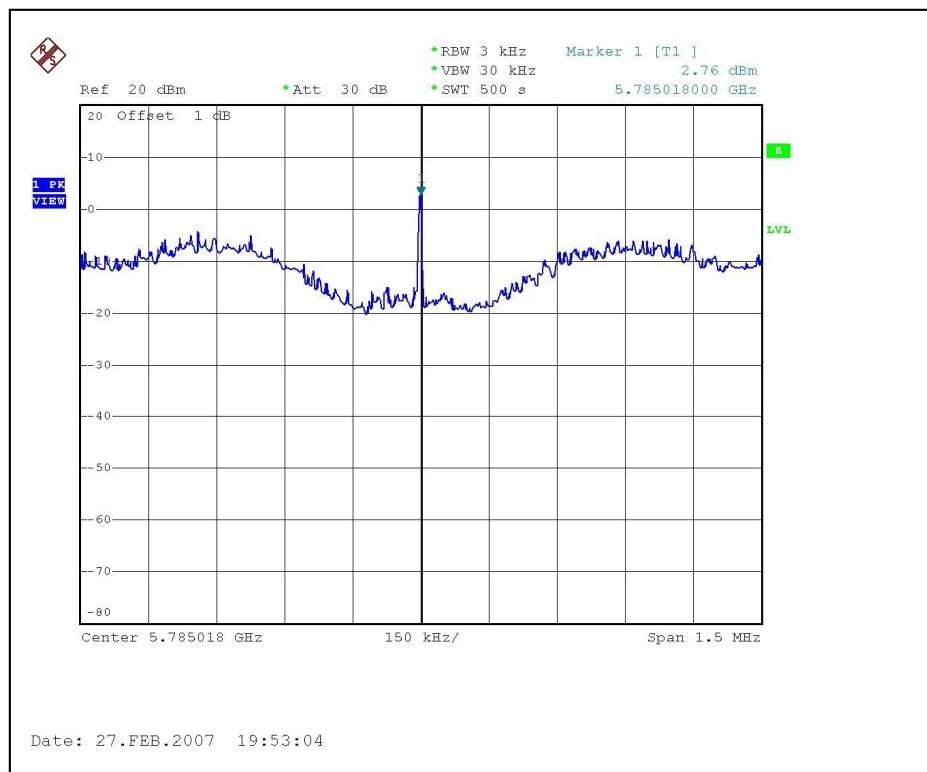

CH5

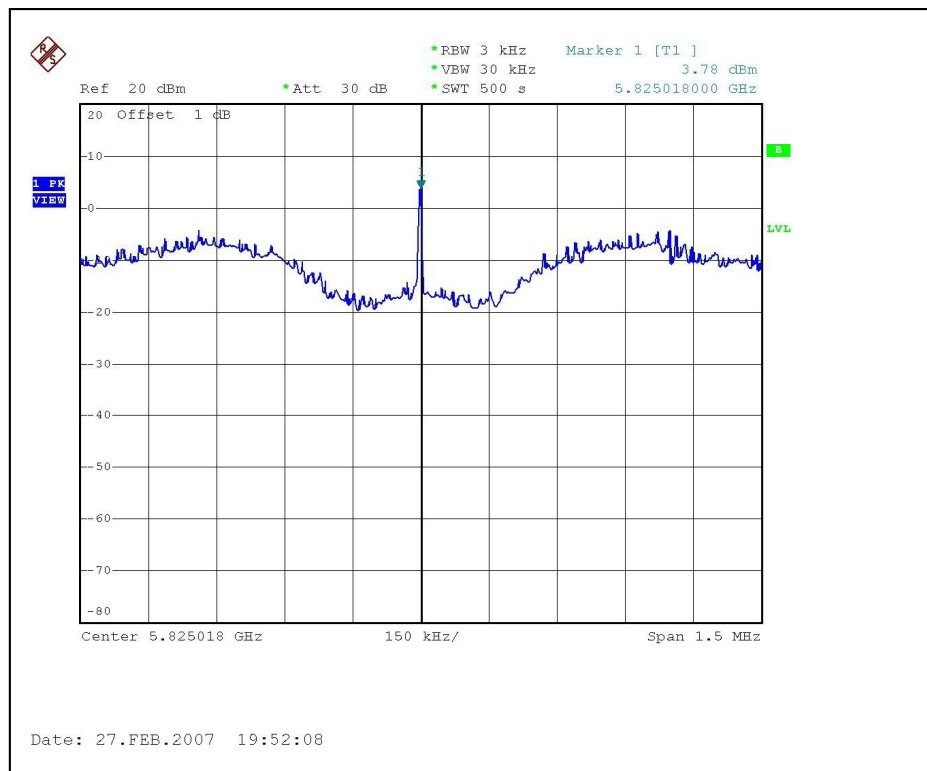



802.11a Turbo OFDM modulation

MODULATION TYPE	BPSK	TRANSFER RATE	12Mbps
INPUT POWER (SYSTEM)	120Vac, 60 Hz	ENVIRONMENTAL CONDITIONS	23deg. C, 56%RH, 972hPa
TESTED BY	Wen Yu		

CHANNEL	CHANNEL FREQUENCY (MHz)	RF POWER LEVEL IN 3 kHz BW (dBm)	MAXIMUM LIMIT (dBm)	PASS/FAIL
1	5760	2.94	5	PASS
2	5800	3.84	5	PASS

CH1

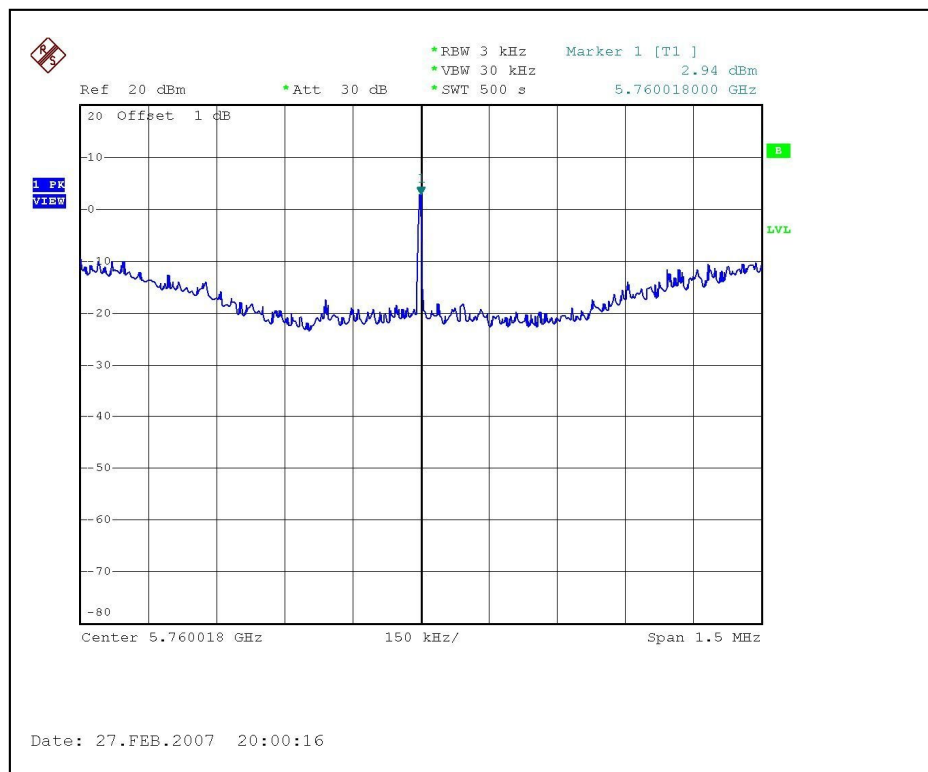

CH2

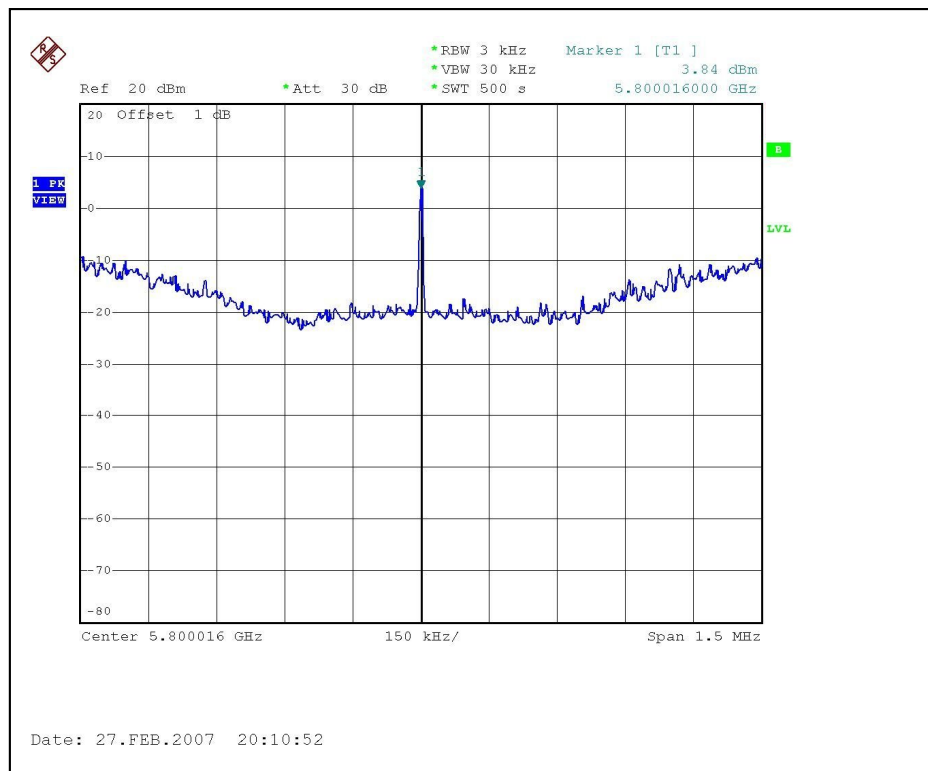



4.6 BAND EDGES MEASUREMENT

4.6.1 LIMITS OF BAND EDGES MEASUREMENT

Below -20dB of the highest emission level of operating band (in 100kHz Resolution Bandwidth).

4.6.2 TEST INSTRUMENTS

Description & Manufacturer	Model No.	Serial No.	Calibrated Until
R&S SPECTRUM ANALYZER	FSP40	100037	Aug. 15, 2007

NOTE:

- 1.The measurement uncertainty is less than $\pm 2.6\text{dB}$, which is calculated as per the NAMAS document NIS81. This uncertainty represents an expanded uncertainty expressed at approximately the 95% confidence level using a coverage factor of $k=2$.
- 2.The calibration interval of the above test instruments is 12 months and the calibrations are traceable to NML/ROC and NIST/USA.

4.6.3 TEST PROCEDURE

The transmitter output was connected to the spectrum analyzer via a low loss cable. Set both RBW and VBW of spectrum analyzer to 100 kHz with suitable frequency span including 100 MHz bandwidth from band edge. The band edges was measured and recorded.

4.6.4 DEVIATION FROM TEST STANDARD

No deviation

4.6.5 EUT OPERATING CONDITION

Same as Item 4.3.6

4.6.6 TEST RESULTS -ANTENNA A

The spectrum plots are attached on the following pages. D2 line indicates the highest level, D1 line indicates the 20dB offset below D2. It shows compliance with the requirement in part 15.247(d).

802.11a OFDM modulation

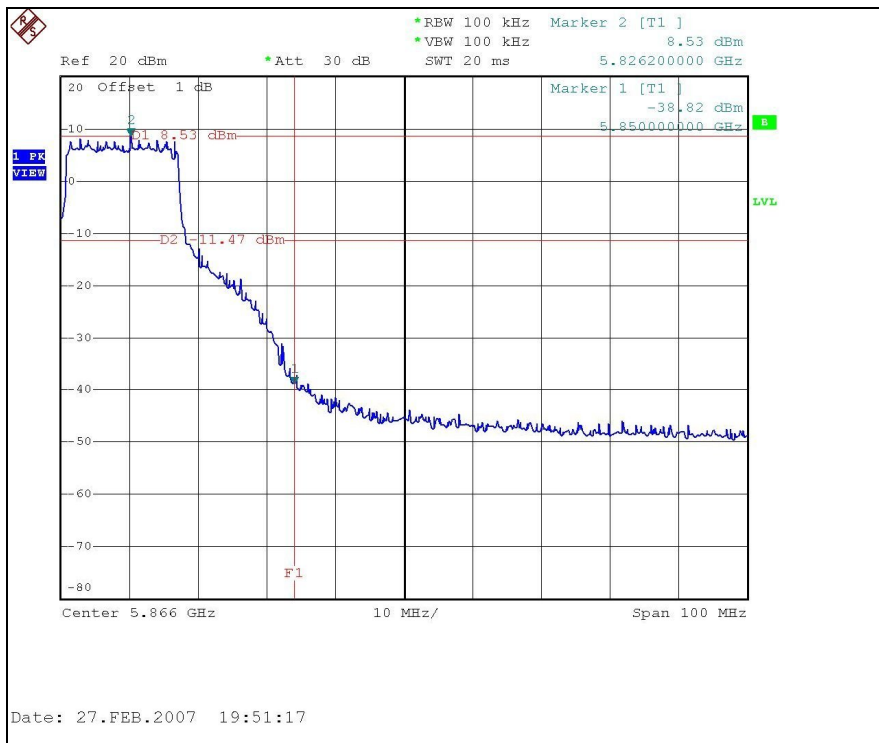
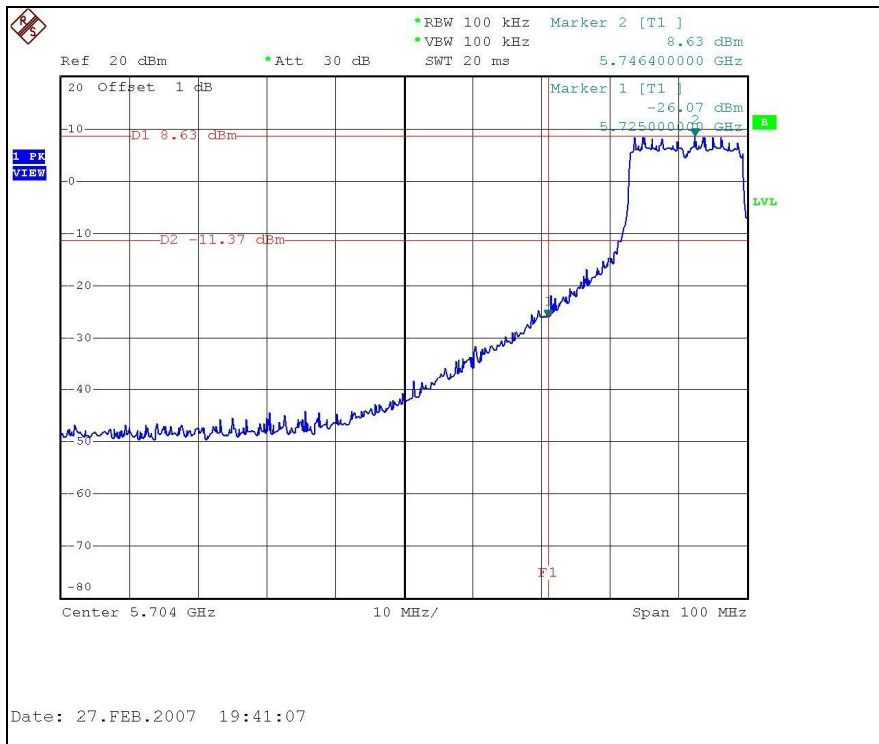

CH 1

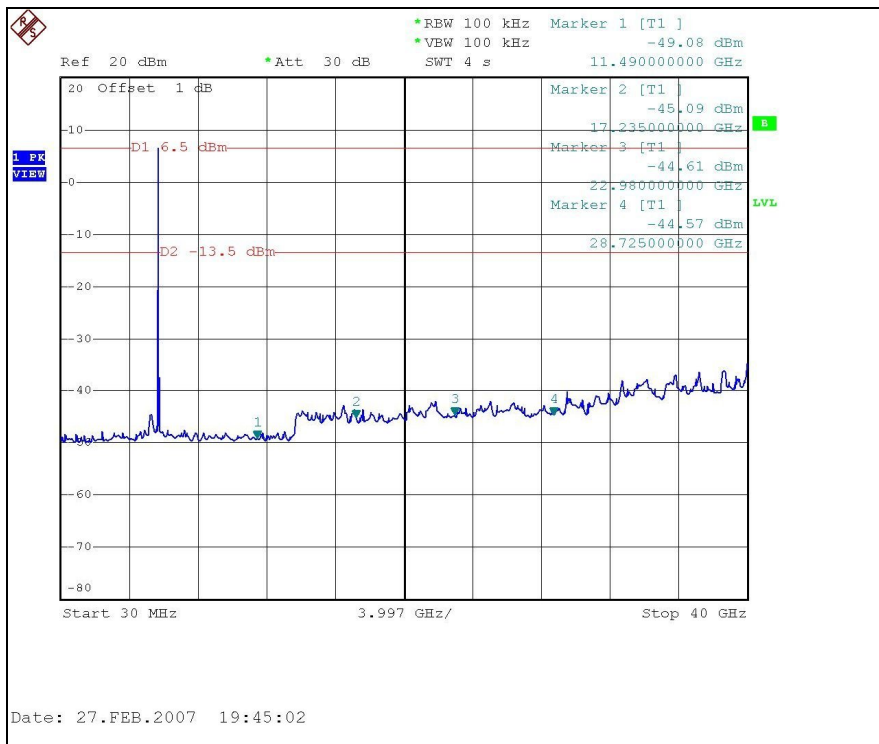

CH 5

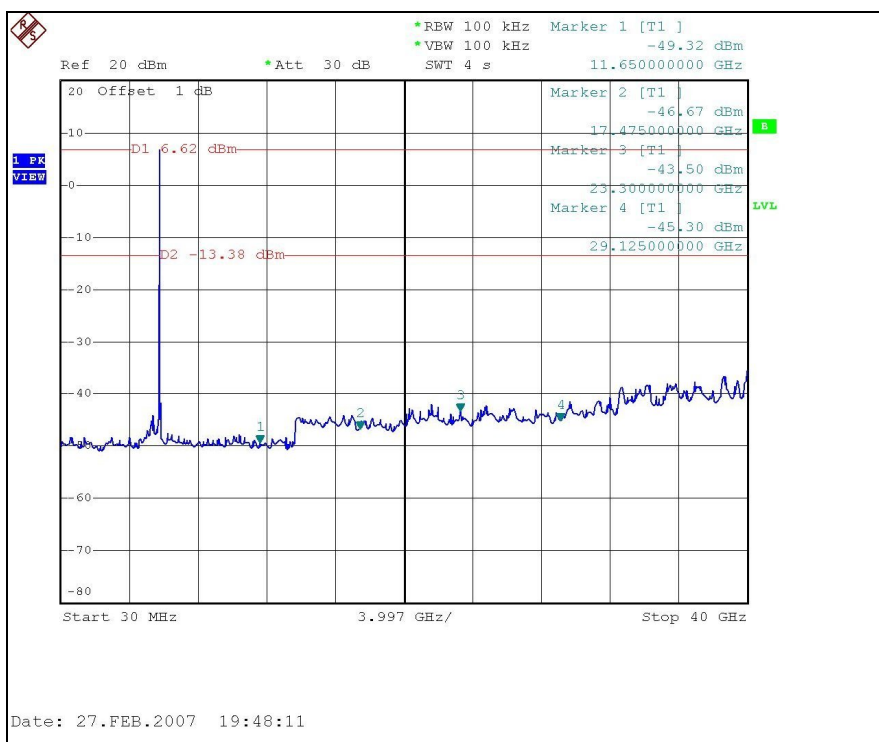

Turbo CH 1

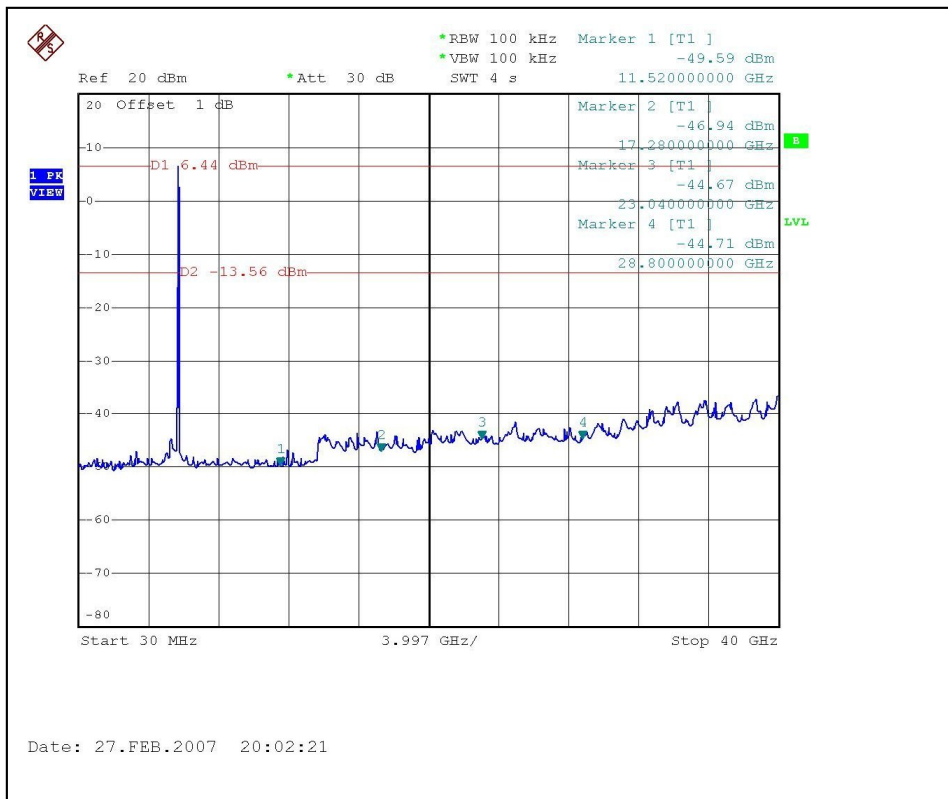

Turbo CH 2

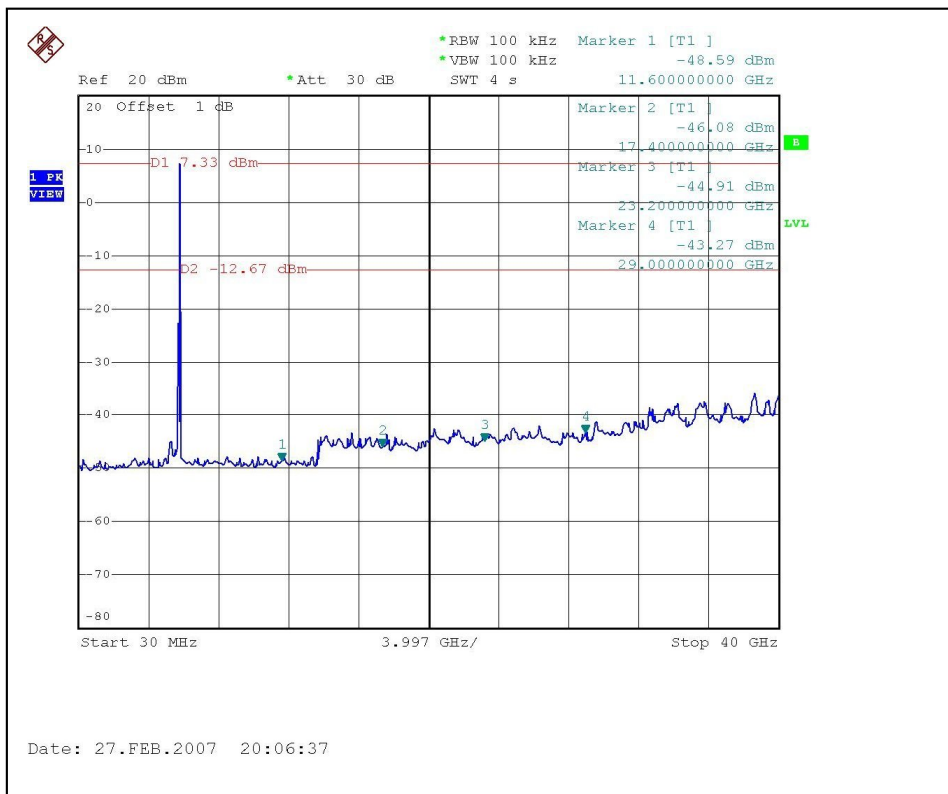

4.7 ANTENNA REQUIREMENT

4.7.1 STANDARD APPLICABLE

For intentional device, according to FCC 47 CFR Section 15.203, an intentional radiator shall be designed to ensure that no antenna other than that furnished by the responsible party shall be used with the device.

And according to FCC 47 CFR Section 15.247(a), if transmitting antennas of directional gain greater than 6dBi are used, the power shall be reduced by the amount in dB that the directional gain of the antenna exceeds 6dBi.

4.7.2 ANTENNA CONNECTED CONSTRUCTION

The antennas used in this product are as following:

5GHz				
No.	Model No.	Gain (dBi)	Antenna Type	Antenna Connector
1	ANT05535	17.0dBi	Directional, Patch Panel (Internal Antenna)	Probe Pin
A	1GP-51809	9.0dBi	Dipole, Omni (External Antenna)	N female(Plug)



5. INFORMATION ON THE TESTING LABORATORIES

We, ADT Corp., were founded in 1988 to provide our best service in EMC, Radio, Telecom and Safety consultation. Our laboratories are accredited and approved by the following approval agencies according to ISO/IEC 17025.

USA	FCC, UL, A2LA
Germany	TUV Rheinland
Japan	VCCI
Norway	NEMKO
Canada	INDUSTRY CANADA , CSA
R.O.C.	CNLA, BSMI, NCC
Netherlands	Telefication
Singapore	PSB , GOST-ASIA(MOU)
Russia	CERTIS(MOU)

Copies of accreditation certificates of our laboratories obtained from approval agencies can be downloaded from our web site:

www.adt.com.tw/index.5/phtml. If you have any comments, please feel free to contact us at the following:

Linko EMC/RF Lab:

Tel: 886-2-26052180

Fax: 886-2-26052943

Hsin Chu EMC/RF Lab:

Tel: 886-3-5935343

Fax: 886-3-5935342

Hwa Ya EMC/RF/Safety Telecom Lab:

Tel: 886-3-3183232

Fax: 886-3-3185050

Web Site: www.adt.com.tw

The address and road map of all our labs can be found in our web site also



APPENDIX-A

MODIFICATIONS RECORDERS FOR ENGINEERING CHANGES TO THE EUT BY THE LAB

No any modifications are made to the EUT by the lab during the test.