



Electromagnetic Compatibility Test Report

Tests Performed on an RF Ideas, Inc.

13.56 MHz Card Reader, Models RDR-7082AKU and 7082AK2

Radiometrics Document RP-7673



Product Detail:

FCC ID: M9MSB708X

IC ID: 6571A-SB708X

Equipment type: 13.56 MHz Card Reader

Test Standards:

US CFR Title 47, Chapter I, FCC Part 15 Subpart C

FCC Part 15 CFR Title 47: 2012

Industry Canada RSS-210, Issue 8: 2010 as required for Category I Equipment

This report concerns: Original Equipment

FCC Part 15.209

Tests Performed For:

RF Ideas, Inc.

4020 Winnetka Av.

Rolling Meadows, IL 60008

Test Facility:

Radiometrics Midwest Corporation

12 East Devonwood

Romeoville, IL 60446

Test Date(s): (Month-Day-Year)

September 3 thru 20, 2013

Document RP-7673 Revisions:

Rev.	Issue Date	Affected Sections	Revised By
0	September 23, 2013		

Table of Contents

- 1 ADMINISTRATIVE DATA 3
- 2 TEST SUMMARY AND RESULTS 3
 - 2.1 RF Exposure Compliance Requirements 3
- 3 EQUIPMENT UNDER TEST (EUT) DETAILS 4
 - 3.1 EUT Description 4
 - 3.1.1 FCC Section 15.203 & RSS-GEN Antenna Requirements 4
 - 3.2 Related Submittals 4
- 4 TESTED SYSTEM DETAILS 4
 - 4.1 Tested System Configuration 4
 - 4.2 Special Accessories 5
 - 4.3 Equipment Modifications 5
- 5 TEST SPECIFICATIONS AND RELATED DOCUMENTS 5
- 6 RADIOMETRICS' TEST FACILITIES 5
- 7 DEVIATIONS AND EXCLUSIONS FROM THE TEST SPECIFICATIONS 6
- 8 CERTIFICATION 6
- 9 TEST EQUIPMENT TABLE 6
- 10 TEST SECTIONS 6
 - 10.1 AC Conducted Emissions 6
 - 10.2 Radiated RF Emissions 15
 - 10.2.1 Field Strength Calculation 16
 - 10.2.2 Radiated Emissions Test Results 16
 - 10.3 Magnetic Field Measurements and Decay Factor Calculations 20
 - 10.3.1 Magnetic Field Radiated Emissions Results (0.009 to 30 MHz) 20
 - 10.4 Occupied Bandwidth Data 21

Notice: This report must not be reproduced (except in full) without the written approval of Radiometrics Midwest Corporation.

RADIOMETRICS MIDWEST CORPORATION - EMC Test Report

Testing of RF IDEas, Models RDR-7082AKU & 7082AK2, 13.56 MHz Card Readers

1 ADMINISTRATIVE DATA

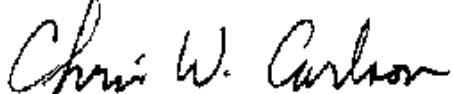
<i>Equipment Under Test:</i> A RF IDEas, Inc., 13.56 MHz Card Reader Models: RDR-7082AKU and 7082AK2 Serial Numbers: I020012, I000012 This will be referred to as the EUT in this Report	
<i>Date EUT Received at Radiometrics: (Month-Day-Year)</i> September 03, 2013	<i>Test Date(s): (Month-Day-Year)</i> September 3 thru 20, 2013
<i>Test Report Written By:</i> Joseph Strzelecki Senior EMC Engineer	<i>Test Witnessed By:</i> The tests were not witnessed by RF IDEas, Inc.
<i>Radiometrics' Personnel Responsible for Test:</i>  Joseph Strzelecki Senior EMC Engineer NARTE EMC-000877-NE	<i>Test Report Approved By</i>  Chris W. Carlson Director of Engineering NARTE EMC-000921-NE

2 TEST SUMMARY AND RESULTS

The EUT (Equipment Under Test) is a 13.56 MHz Card Reader, Models RDR-7082AKU and 7082AK2, manufactured by RF IDEas, Inc. The detailed test results are presented in a separate section. The following is a summary of the test results.

Emissions Tests Results

Environmental Phenomena	Frequency Range	Basic Standard	Test Result
RF Radiated Emissions	30-1000 MHz	RSS-210 & FCC Part 15	Pass
Conducted Emissions, AC Mains	0.15 - 30 MHz	RSS-210 & FCC Part 15	Pass
RF Radiated Emissions H-Field	0.009 – 30 MHz	RSS-210 & FCC Part 15	Pass

Note: The RSS-210 specification is not currently covered in Radiometrics' Scope of Accreditation. This is technically very similar to FCC, CFR 47 Part 15 which is on Radiometrics scope.

2.1 RF Exposure Compliance Requirements

Since the effective power output is less than 1 mW, the EUT meets the FCC requirement for RF exposure and is exempt from RSS-102. There are no power level adjustments and the antenna is permanently attached. The detailed calculations for RF Exposure are presented in a separate document.

3 EQUIPMENT UNDER TEST (EUT) DETAILS

3.1 EUT Description

The EUT is a 13.56 MHz card reader, Models RDR-7082AKU and 7082AK2, manufactured by RF IDEas, Inc. The difference between the two model numbers being that the 7082AK2 has an RS-232 interface and the model RDR-7082AKU has a USB interface. Both products have the same PCB, with either the USB or the serial port populated. The EUT was in good working condition during the tests, with no known defects.

3.2 Product Family

The following is the product family list of the readers that use the same electronics and PCB as the ones tested in this report:

Model Number	Model Number
RDR-7081AK2	RDR-7081AKU

3.2.1 FCC Section 15.203 & RSS-GEN Antenna Requirements

The antenna is permanently attached to the PCB. The antenna is internal to the EUT and it is not readily available to be modified by the end user.

3.3 Related Submittals

RF IDEas, Inc. is not submitting any other products simultaneously for equipment authorization related to the EUT.

4 TESTED SYSTEM DETAILS

4.1 Tested System Configuration

The system was configured for testing in a typical fashion. The EUT was placed on an 80-cm high, nonconductive test stand. The testing was performed in conditions as close as possible to installed conditions. Wiring was consistent with manufacturer's recommendations. Power was supplied at 115 VAC, 60 Hz single-phase to the host computer. The EUT was powered from either the USB or PS/2 port.

The identification for all equipment, plus descriptions of all cables used in the tested system, are:

Tested System Configuration List

Item	Description	Type*	Manufacturer	Model Number	Serial Number
1	Card Reader: serial version	E	RF IDEas	RDR-7081AK2	I020012
2	Card Reader: USB version	E	RF IDEas	RDR-7081AKU	I000012
3	IBM Desktop (COMP2)	H	IBM	31U	KCHR8AA
4	LCD Monitor (LCD-02)	P	HP	P9621D	CNC5272RNC

RADIOMETRICS MIDWEST CORPORATION - EMC Test Report
Testing of RF IDEas, Models RDR-7082AKU & 7082AK2, 13.56 MHz Card Readers

Item	Description	Type*	Manufacturer	Model Number	Serial Number
5	Keyboard (KB-02)	P	Microsoft	X800468-208	6968200020336
6	Modem (MDM-01)	P	US Robotics	0701	22SBBAC9FPMN
7	Mouse (MS-02)	P	Logitech	093230	MS-02

* Type: E = EUT, P = Peripheral, S = Support Equipment; H = Host Computer

List of Cables Connected to the EUT

QTY	Length (m)	Cable Description	Connected to (Item #)	Shielded?
1	1.85	USB Cable to Card Reader	#2 and #3	Yes
	1.8	Serial Cable to Card Reader	#1 and #3	Yes

See previous table for Item #'s.

4.2 Special Accessories

No special accessories were used during the tests in order to achieve compliance.

4.3 Equipment Modifications

No modifications were made at Radiometrics in order to meet the requirements listed in this report.

5 TEST SPECIFICATIONS AND RELATED DOCUMENTS

Document	Date	Title
FCC CFR Title 47	2012	Code of Federal Regulations Title 47, Chapter 1, Federal Communications Commission, Part 15 - Radio Frequency Devices
ANSI C63.4-2009	2009	Methods of Measurement of Radio Noise Emissions from Low-Voltage Electrical and Electronic Equipment in the Range of 9 kHz to 40 GHz
IC RSS-210 Issue 8	2010	Low Power Licence-Exempt Radiocommunication Devices (All Frequency Bands) Category I Equipment
IC RSS-Gen Issue 3	2010	General Requirements and Information for the Certification of Radiocommunication Equipment (RSS-Gen)

The test procedures used are in accordance with the Industry Canada RSS-Gen and ANSI document C63.4-2009, "Methods of Measurement of Radio Noise Emissions from Low-Voltage Electrical and Electronic Equipment in the Range of 9 kHz to 40 GHz". The specific procedures are described herein. Radiated testing was performed at an antenna to EUT distance of 3 meters. The antenna was raised and lowered from 1 to 4 meters.

6 RADIOMETRICS' TEST FACILITIES

The results of these tests were obtained at Radiometrics Midwest Corp. in Romeoville, Illinois, USA. Radiometrics is accredited by A2LA (American Association for Laboratory Accreditation) to conform to ISO/IEC 17025: 2005 "General Requirements for the Competence of Calibration and Testing Laboratories". Radiometrics' Lab Code is 121191 and Certification Number is 1495.01. Radiometrics' scope of accreditation includes all of the test methods listed herein. A copy of the accreditation can be accessed on our web site (www.radiomet.com). Radiometrics accreditation status can be verified at A2LA's web site (www.a2la2.org).

The following is a list of shielded enclosures located in Romeoville, Illinois used during the tests:

RADIOMETRICS MIDWEST CORPORATION - EMC Test Report

Testing of RF IDEAS, Models RDR-7082AKU & 7082AK2, 13.56 MHz Card Readers

Chamber E: Is a custom made anechoic chamber that measures 52' L X 30' W X 18' H. The walls and ceiling are fully lined with RF absorber. Pro-shield of Collinsville, Oklahoma manufactured the chamber.

Test Station F: Is an area that measures 10' D X 12' W X 10' H. The floor and back wall are metal shielded. This area is used for conducted emissions measurements.

A separate ten-foot long, brass plated, steel ground rod attached via a 6 inch copper braid grounds each of the above chambers. Each enclosure is also equipped with low-pass power line filters.

The FCC has accepted these sites as test site number US1065. The FCC test site Registration Number is 732175. Details of the site characteristics are on file with the Industry Canada as site number IC3124A-1.

A complete list of the test equipment is provided herein. The calibration due dates are indicated on the equipment list. The equipment is calibrated in accordance to ANSI/NCSL Z540-1 with traceability to the National Institute of Standards and Technology (NIST).

7 DEVIATIONS AND EXCLUSIONS FROM THE TEST SPECIFICATIONS

There were no deviations or exclusions from the test specifications.

8 CERTIFICATION

Radiometrics Midwest Corporation certifies that the data contained herein was taken under conditions that meet or exceed the requirements of the test specification. The results relate only to the EUT listed herein. Any modifications made to the EUT subsequent to the indicated test date will invalidate the data and void this certification.

9 TEST EQUIPMENT TABLE

RMC ID	Manufacturer	Description	Model No.	Serial No.	Frequency Range	Cal Period	Cal Date
AMP-22	Anritsu	Pre-amplifier	MH648A	M23969	0.1-1200MHz	12 Mo.	01/10/13
ANT-44	Impossible Machine	Super Log Antenna	SL-20M2G	1002	20-2000MHz	24 Mo.	12/14/11
ANT-53	EMCO	Loop Antenna	6507	1453	1 kHz-30 MHz	24 Mo.	10/26/11
HPF-01	Solar	High Pass Filter	7930-100	HPF-1	0.15-30MHz	24 Mo.	01/24/12
LSN-01	Electrometrics	50 uH LISN	FCC/VDE 50/2	1001	0.01-30MHz	24 Mo.	06/21/13
LSN-03	Farnell	50 uH LISN	1EXLSN30B	000314	0.01-30MHz	24 Mo.	06/21/13
REC-03	Anritsu	Spectrum Analyzer	MS2601B	MT94589	0.01-2200MHz	12 Mo.	04/08/13
REC-07	Anritsu	Spectrum Analyzer	MS2601A	MT53067	0.01-2200MHz	12 Mo.	05/21/13
THM-03	Fluke	Temp/Humidity Meter	971	95850465	N/A	12 Mo.	04/25/13
REC-11	HP / Agilent	Spectrum Analyzer	E7405A	US39110103	9Hz-26.5GHz	12 Mo.	6/13/13

Note: All calibrated equipment is subject to periodic checks.

10 TEST SECTIONS

10.1 AC Conducted Emissions

The tests and limits are in accordance with FCC section 15.207 and RSS Gen section 7.2.2.

A computer-controlled analyzer was used to perform the conducted emissions measurements. The frequency range was divided into 500 subranges equally spaced on a logarithmic scale. The computer recorded the peak of each subrange. This data was then plotted on semi-log graph paper generated by the computer and plotter. Adjusting the positions of the cables and orientation of the test system then maximizes the highest emissions.

Mains Conducted emission measurements were performed using a 50 Ohm/50 uH Line Impedance Stabilization Network (LISN) as the pick-up device. Measurements were repeated on both leads within the power cord. If the EUT power cord exceeded 80 cm in length, the excess length of the power cord was made into a 30 to 40 cm bundle near the center of the cord. The LISN was placed on the floor at the base of the test platform and electrically bonded to the ground plane.

FCC/IC Limits of Conducted Emissions at the AC Mains Ports

Frequency Range (MHz)	Class B Limits (dBuV)	
	Quasi-Peak	Average
0.150 - 0.50*	66 - 56	56 - 46
0.5 - 5.0	56	46
5.0 - 30	60	50

* The limit decreases linearly with the logarithm of the frequency in this range.

The initial step in collecting conducted data is a peak detector scan and the plotting of the measurement range. Significant peaks are then marked as shown on the following table, and these signals are then measured with the quasi-peak detector. The following represents the worst case emissions from the host computer (with the EUT connected) power cord, after testing all modes of operation.

In accordance with the FCC rules regarding transmitters below 30 MHz.

The transmitter was tested with a dummy load under the following conditions:

- 1) First, the AC line conducted tests with the antenna attached were performed to determine if the EUT complies with the 15.207 limits outside of the transmitter's fundamental emission band.
- 2) The AC line conducted emissions were retested with a dummy load to make sure the device complies with the 15.207 limits inside the transmitter's fundamental emission band. Only the fundamental TX emission band needs to be retested. The load was 100 Ohm. This is the characteristic impedance of the antenna.

Test Date: September 11, 2013

QP readings are quasi-peak with a 9 kHz bandwidth and no video filter.

Judgment: Passed by at least 5 dB.

RADIOMETRICS MIDWEST CORPORATION - EMC Test Report
Testing of RF IDEas, Models RDR-7082AKU & 7082AK2, 13.56 MHz Card Readers

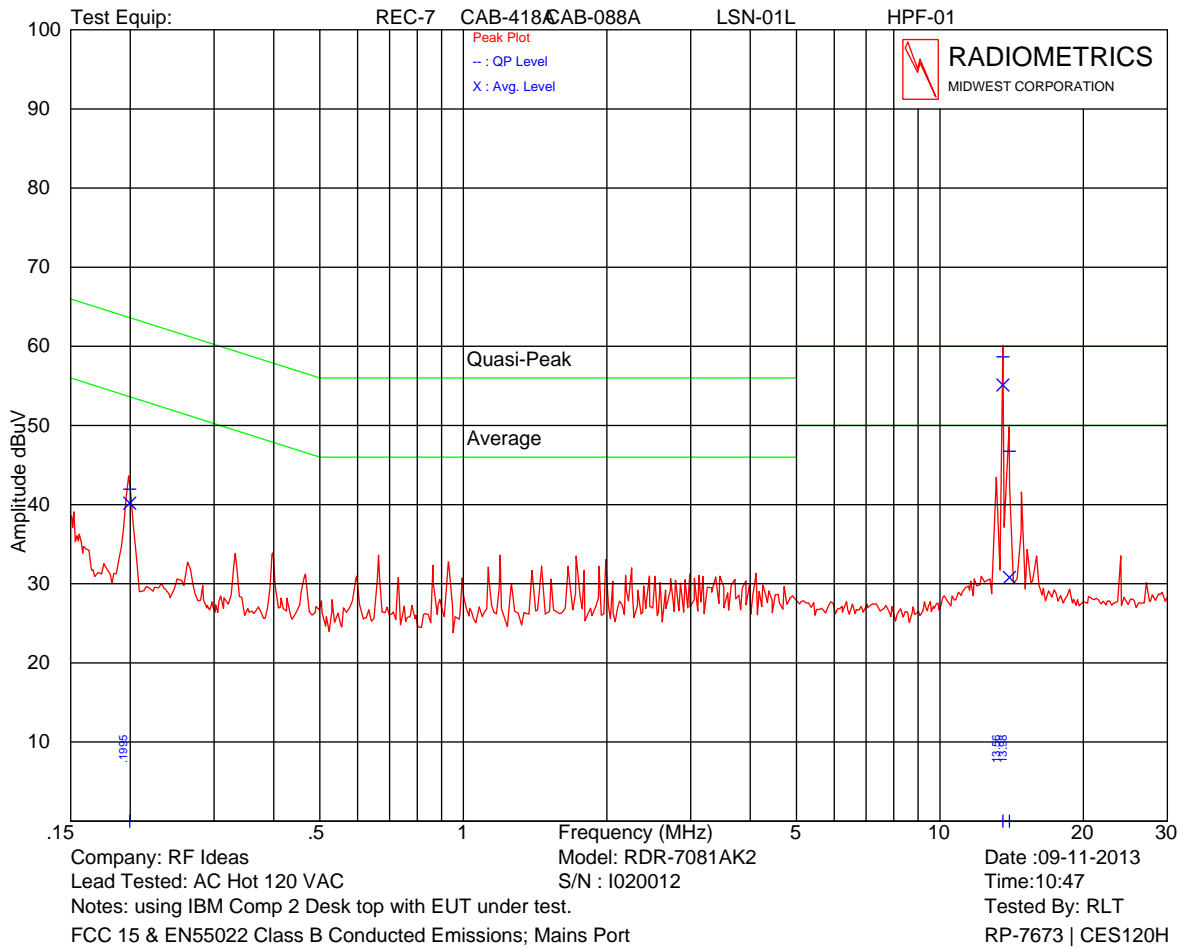

Model: RDR-7082AK2 with Antenna Installed

Frequency MHz	QP Amplitude	QP Limit	Average Amplitude	Average Limit
0.200	42.0Q	63.6	40.2	53.6
13.561	58.7Q	60.0	55.1	50.0
13.985	46.8Q	60.0	30.8	50.0

The emission at 13.56 MHz was retested and passed with a 100 Ohm Resistor in place of antenna.

Judgment: Passed by at least 8 dB at all frequencies, except 13.56 MHz, with standard Loop antenna installed.

RADIOMETRICS MIDWEST CORPORATION - EMC Test Report
Testing of RF IDEas, Models RDR-7082AKU & 7082AK2, 13.56 MHz Card Readers

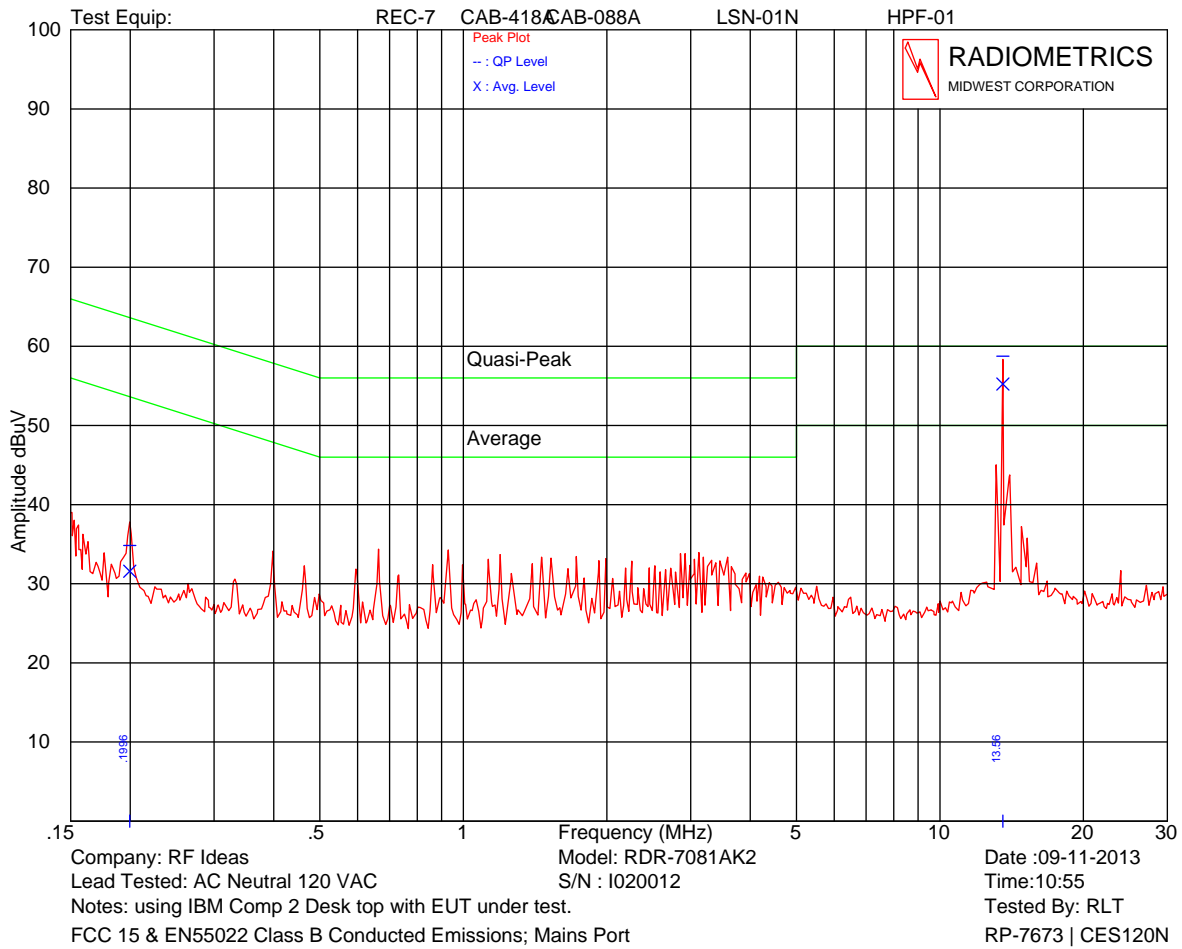

Model: RDR-7082AK2 with Antenna Installed

Frequency MHz	QP Amplitude	QP Limit	Average Amplitude	Average Limit
0.200	34.8Q	63.6	31.6	53.6
13.561	58.8Q	60.0	55.3	50.0

The emission at 13.56 MHz was retested and passed with a 100 Ohm Resistor in place of antenna.

Judgment: Passed by at least 8 dB at all frequencies, except 13.56 MHz, with standard Loop antenna installed.

RADIOMETRICS MIDWEST CORPORATION - EMC Test Report
Testing of RF Ideas, Models RDR-7082AKU & 7082AK2, 13.56 MHz Card Readers

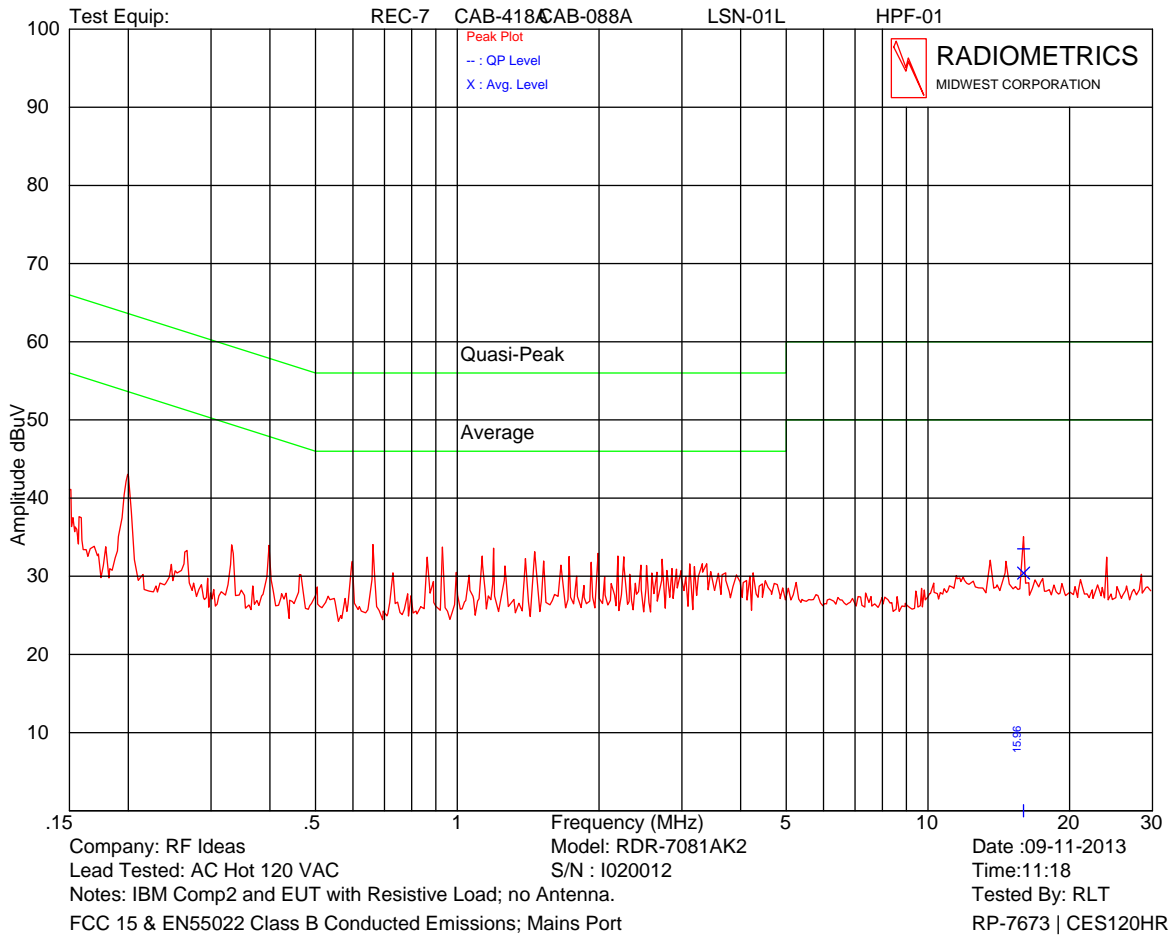

Model: RDR-7082AK2 with 100 Ohm Resistor in place of antenna

Frequency MHz	QP Amplitude	QP Limit	Average Amplitude	Average Limit
15.963	33.5Q	60.0	30.4	50.0

Judgment: Passed by at least 8 dB with Resistive Load in place of standard Loop antenna.

RADIOMETRICS MIDWEST CORPORATION - EMC Test Report
Testing of RF IDEAS, Models RDR-7082AKU & 7082AK2, 13.56 MHz Card Readers

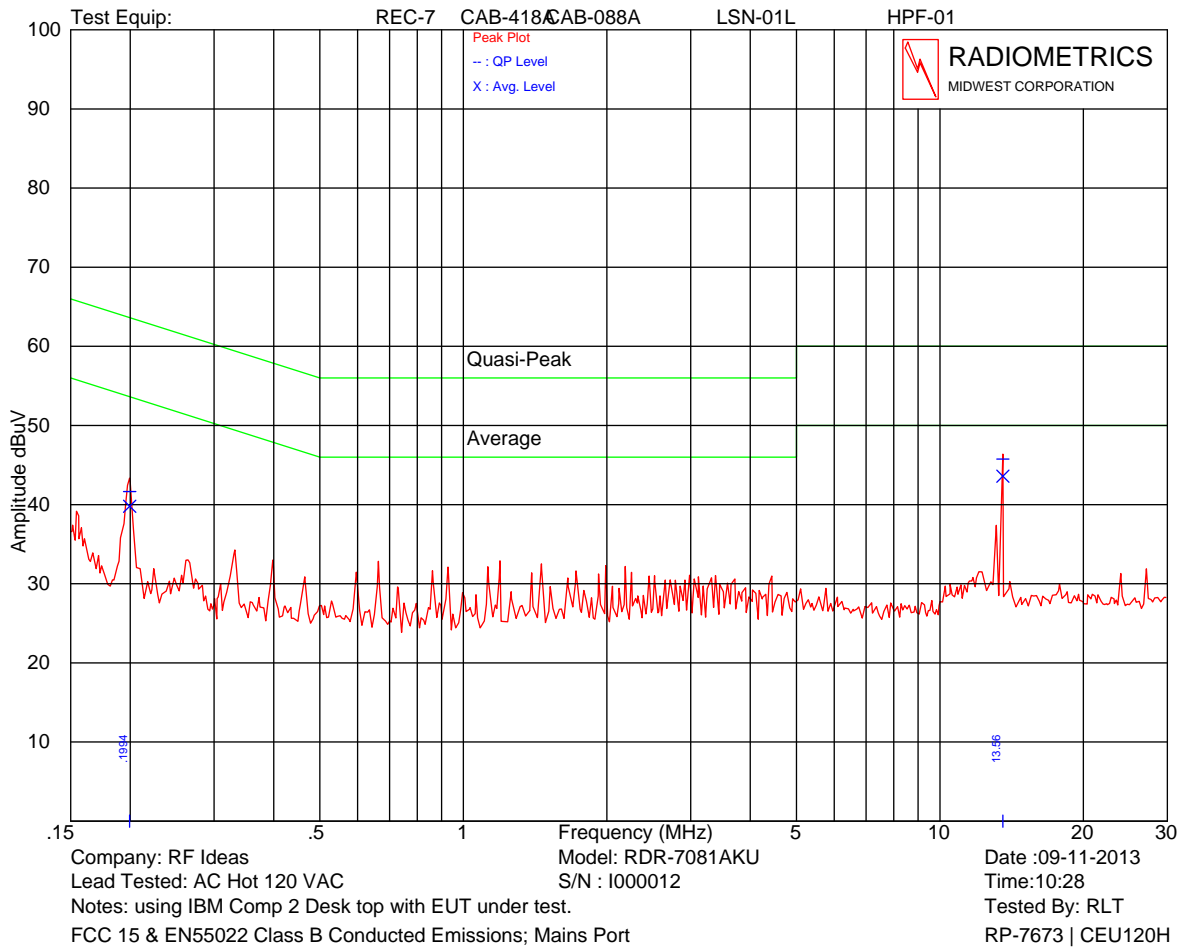

Model: RDR-7082AKU with Antenna Installed

Frequency MHz	QP Amplitude	QP Limit	Average Amplitude	Average Limit
0.199	41.6Q	63.6	39.8	53.6
13.561	45.8Q	60.0	43.6	50.0

Judgment: Passed by at least 6 dB

RADIOMETRICS MIDWEST CORPORATION - EMC Test Report
Testing of RF IDEas, Models RDR-7082AKU & 7082AK2, 13.56 MHz Card Readers

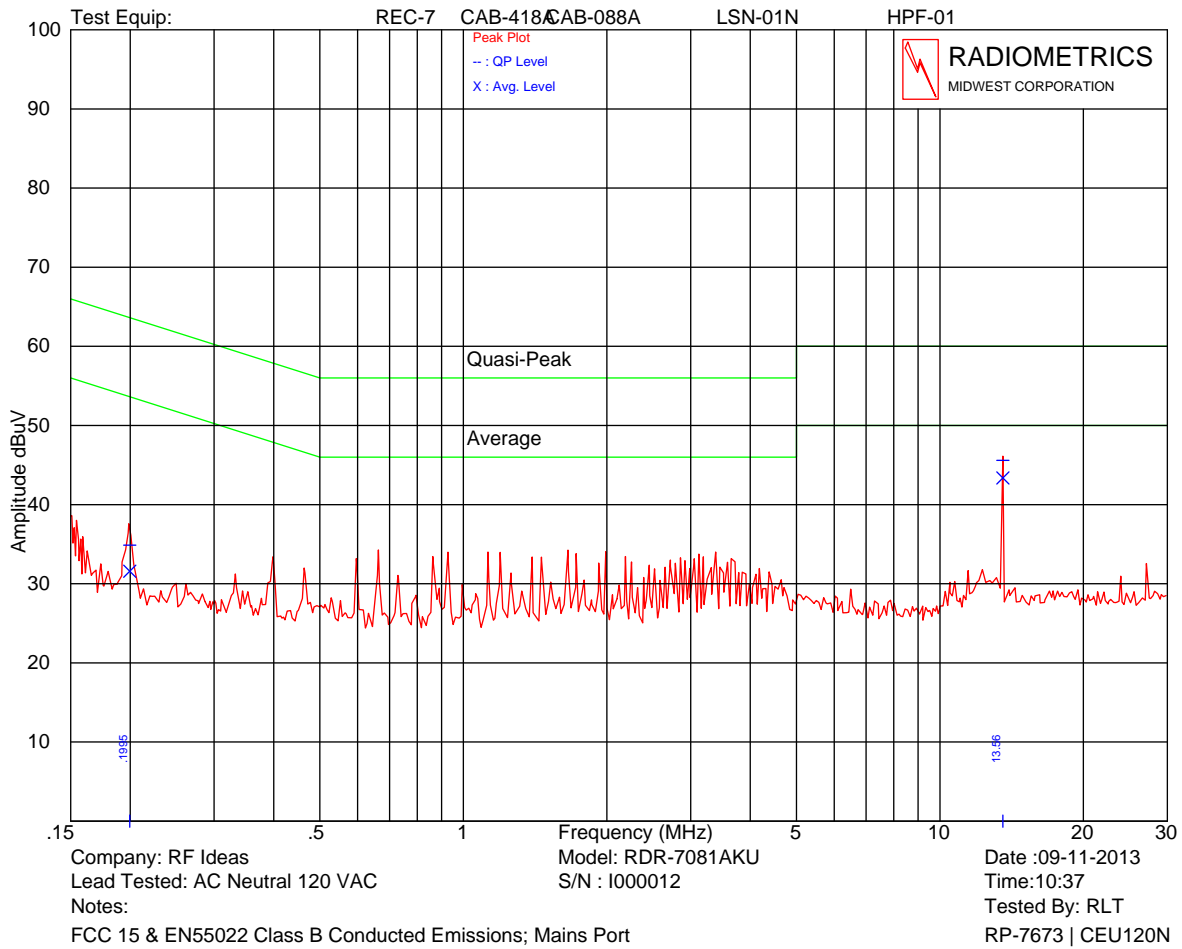

Model: RDR-7082AKU with Antenna Installed

Frequency MHz	QP Amplitude	QP Limit	Average Amplitude	Average Limit
0.200	34.9Q	63.6	31.6	53.6
13.560	45.6Q	60.0	43.4	50.0

Judgment: Passed by at least 5 dB

Figure 1. Conducted Emissions Test Setup (USB Reader)

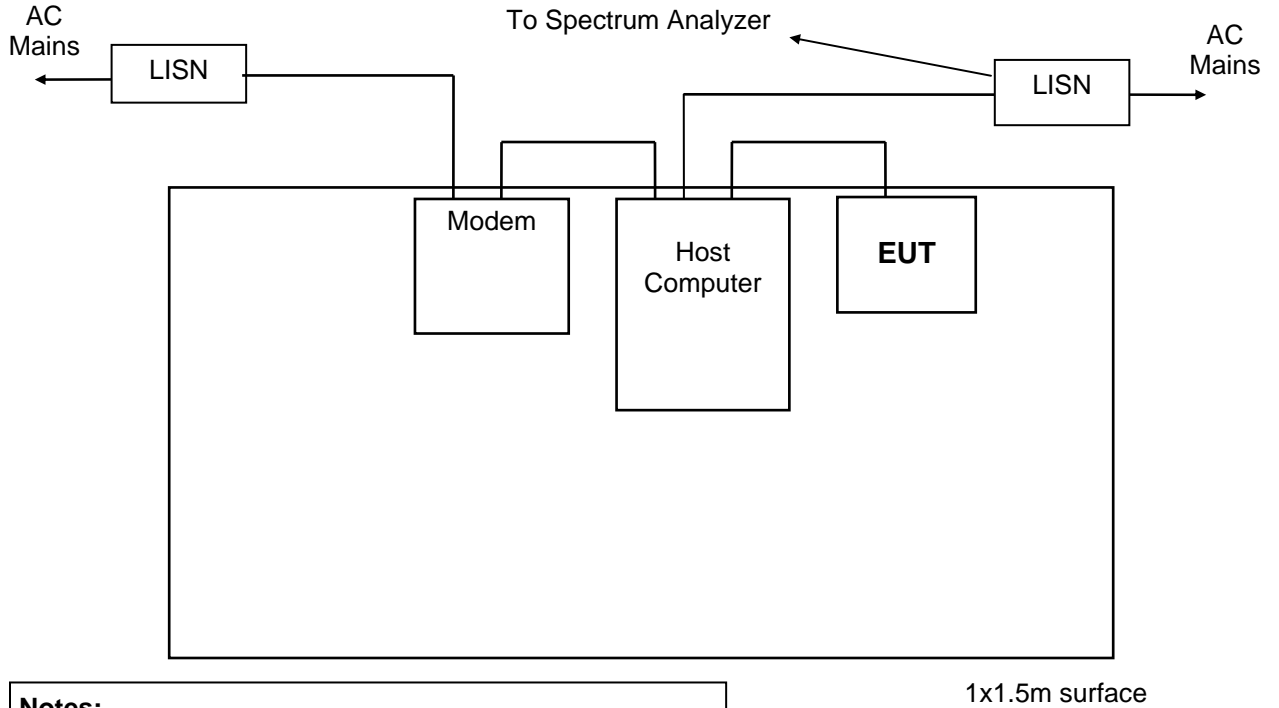

- Notes:**
- LISN's at least 80 cm from EUT chassis
 - Vertical conductive plane 40 cm from rear of table top
 - EUT power cord bundled

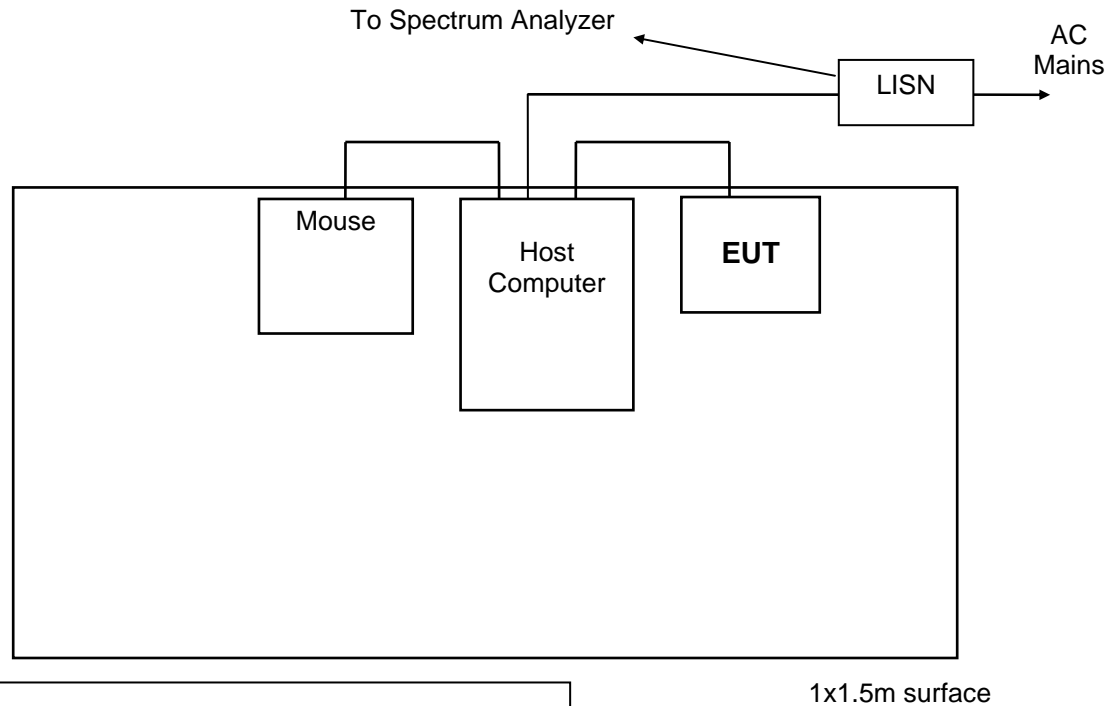
Figure 2. Conducted Emissions Test Setup (Serial Reader)**Notes:**

- LISN's at least 80 cm from EUT chassis
- Vertical conductive plane 40 cm from rear of table top
- EUT power cord bundled

10.2 Radiated RF Emissions

Radiated emission measurements were performed with linearly polarized broadband antennas. The results obtained with these antennas can be correlated with results obtained with a tuned dipole antenna. The radiated emission measurements were performed with a spectrum analyzer. The bandwidth used from 150 kHz to 30 MHz is 9 or 10 kHz and the bandwidth from 30 MHz to 1000 MHz is 100 or 120 kHz. Above 1 GHz, a 1 MHz bandwidth is used. A 10 dB linearity check is performed prior to start of testing in order to determine if an overload condition exists.

From 30 to 1000 MHz, an Anritsu spectrum analyzer was used. For tests from 1 to 25 GHz, an HP 8566 spectrum analyzer was used. Figure 4 herein lists the details of the test equipment used during radiated emissions tests.

Final radiated emissions measurements were performed inside of an anechoic chamber at a test distance of 3 meters. The anechoic chamber is designated as Chamber E. This Chamber meets the Site Attenuation requirements of ANSI C63.4 and CISPR 16-1. Chamber E is located at 12 East Devonwood Ave. Romeoville, Illinois EMI test lab.

RADIOMETRICS MIDWEST CORPORATION - EMC Test Report

Testing of RF IDEas, Models RDR-7082AKU & 7082AK2, 13.56 MHz Card Readers

The entire frequency range from 30 to 1000 MHz was slowly scanned with particular attention paid to those frequency ranges which appeared high. Measurements were performed using two antenna polarizations, (vertical and horizontal). The worst case emissions were recorded. All measurements may be performed using either the peak, average or quasi-peak detector functions. If the peak detector data exceeds or is marginally close to the limits, the measurements are repeated using a quasi-peak detector or average function as required by the specification for final determination of compliance.

The detected emission levels were maximized by rotating the EUT, adjusting the positions of all cables, and by scanning the measurement antenna from 1 to 4 meters above the ground.

10.2.1 Field Strength Calculation

The field strength is calculated by adding the Antenna Factor and Cable Loss, and by subtracting the Amplifier Gain from the measured reading. The basic equation is as follows:

$$FS = RA + AF + CF - AG$$

Where: FS = Field Strength

RA = Receiver Amplitude

AF = Antenna Factor

CF = Cable Attenuation Factor

AG = Amplifier Gain

10.2.2 Radiated Emissions Test Results

Test Date	09/11/2011
Test Distance	3 Meters
Specification	FCC Part 15 Subpart C & RSS-210
Notes	Corr. Factors = cable loss – preamp gain - distance factor.
Abbreviations	P = peak; Q = QP Pol = Antenna Polarization; V = Vertical; H = Horizontal

EUT		RDR-7081AK2 Serial Number I020012						
Freq. MHz	Meter Reading dBuV	Decr. Type	Antenna		Corr. Factors dB	Field Strength dBuV/m		Margin Under Limit dB
			Factor dB	Pol/ ID#		EUT	Limit	
32.8	33.1	P	16.3	H/44	-28.4	21.0	40.0	19.0
73.2	47.3	P	7.2	H/44	-27.8	26.7	40.0	13.3
102.4	47.5	P	10.1	H/44	-27.5	30.1	43.5	13.4
155.2	41.5	P	9.9	H/44	-26.9	24.5	43.5	19.0
207.2	44.4	P	10.1	H/44	-26.3	28.2	43.5	15.3
216.0	45.5	P	11.2	H/44	-26.2	30.5	46.0	15.5
226.4	37.1	P	11.7	H/44	-26.2	22.6	46.0	23.4
227.8	38.3	P	11.6	H/44	-26.2	23.7	46.0	22.3
307.9	45.1	P	13.4	H/44	-27.4	31.1	46.0	14.9
359.4	39.5	P	14.6	H/44	-27.3	26.8	46.0	19.2
429.4	35.3	P	16.4	H/44	-27.3	24.4	46.0	21.6
498.3	32.7	P	17.4	H/44	-26.8	23.3	46.0	22.7
513.0	40.5	P	17.7	H/44	-26.8	31.4	46.0	14.6
565.0	38.3	P	19.0	H/44	-26.6	30.7	46.0	15.3
666.0	39.2	P	20.2	H/44	-26.4	33.0	46.0	13.0
728.0	45.0	P	20.4	H/44	-26.1	39.3	46.0	6.7

RADIOMETRICS MIDWEST CORPORATION - EMC Test Report

Testing of RF IDEas, Models RDR-7082AKU & 7082AK2, 13.56 MHz Card Readers

EUT : RDR-7081AK2 Serial Number I020012								
Freq. MHz	Meter Reading dBuV	Dect. Type	Antenna		Corr. Factors dB	Field Strength dBuV/m		Margin Under Limit dB
			Factor dB	Pol/ ID#		EUT	Limit	
833.0	35.9	P	21.2	H/44	-25.6	31.5	46.0	14.5
938.0	31.3	P	22.4	H/44	-24.9	28.8	46.0	17.2
988.0	30.4	P	23.1	H/44	-24.3	29.2	54.0	24.8
32.4	43.3	P	16.3	V/44	-28.4	31.2	40.0	8.8
48.4	44.5	P	14.4	V/44	-28.2	30.7	40.0	9.3
81.6	43.3	P	7.2	V/44	-27.7	22.8	40.0	17.2
102.8	46.4	P	10.3	V/44	-27.5	29.2	43.5	14.3
155.2	44.5	P	9.9	V/44	-26.9	27.5	43.5	16.0
162.4	44.6	P	10.4	V/44	-26.8	28.2	43.5	15.3
181.6	40.2	P	9.1	V/44	-26.6	22.7	43.5	20.8
207.2	41.5	P	10.1	V/44	-26.3	25.3	43.5	18.2
216.0	43.3	P	11.2	V/44	-26.2	28.3	46.0	17.7
226.4	35.9	P	11.7	V/44	-26.2	21.4	46.0	24.6
251.9	39.5	P	12.8	V/44	-27.5	24.8	46.0	21.2
312.4	44.0	P	13.4	V/44	-27.4	30.0	46.0	16.0
359.4	45.9	P	14.6	V/44	-27.3	33.2	46.0	12.8
410.4	41.3	P	15.6	V/44	-27.3	29.6	46.0	16.4
466.4	36.9	P	17.1	V/44	-26.9	27.1	46.0	18.9
497.7	31.8	P	17.3	V/44	-26.8	22.3	46.0	23.7
513.0	45.5	P	17.7	V/44	-26.8	36.4	46.0	9.6
564.0	42.1	P	18.9	V/44	-26.6	34.4	46.0	11.6
729.0	43.1	P	20.4	V/44	-26.1	37.4	46.0	8.6
882.0	32.2	P	21.1	V/44	-25.4	27.9	46.0	18.1
988.0	31.9	P	23.1	V/44	-24.3	30.7	54.0	23.3

Model Number : RDR-7082AKU; Serial Number I000012								
Freq. MHz	Meter Reading dBuV	Dect. Type	Antenna		Corr. Factors dB	Field Strength dBuV/m		Margin Under Limit dB
			Factor dB	Pol/ ID#		EUT	Limit	
32.8	32.9	P	16.3	H/44	-28.4	20.8	40.0	19.2
68.0	50.3	P	8.1	H/44	-27.9	30.5	40.0	9.5
102.4	45.6	P	10.1	H/44	-27.5	28.2	43.5	15.3
155.2	47.4	P	9.9	H/44	-26.9	30.4	43.5	13.1
167.2	46.1	P	9.7	H/44	-26.7	29.1	43.5	14.4
204.4	44.1	P	9.8	H/44	-26.4	27.5	43.5	16.0
216.0	44.7	P	11.2	H/44	-26.2	29.7	46.0	16.3
229.2	40.6	P	11.6	H/44	-26.2	26.0	46.0	20.0
231.2	40.5	P	11.6	H/44	-26.2	25.9	46.0	20.1
277.1	51.8	P	13.1	H/44	-27.4	37.5	46.0	8.5
368.9	49.0	P	14.6	H/44	-27.3	36.3	46.0	9.7
459.6	52.4	P	16.4	H/44	-26.9	41.9	46.0	4.1
503.9	35.9	P	17.6	H/44	-26.8	26.7	46.0	19.3
507.0	42.6	P	17.7	H/44	-26.8	33.5	46.0	12.5
553.0	41.9	P	18.9	H/44	-26.5	34.3	46.0	11.7
645.0	43.1	P	20.0	H/44	-26.4	36.7	46.0	9.3

RADIOMETRICS MIDWEST CORPORATION - EMC Test Report

Testing of RF IDEas, Models RDR-7082AKU & 7082AK2, 13.56 MHz Card Readers

Model Number : RDR-7082AKU; Serial Number I000012								
Freq. MHz	Meter Reading dBuV	Decet. Type	Antenna		Corr. Factors dB	Field Strength dBuV/m		Margin Under Limit dB
			Factor dB	Pol/ ID#		EUT	Limit	
691.0	46.6	P	20.6	H/44	-26.5	40.7	46.0	5.3
783.0	45.8	P	20.7	H/44	-26.0	40.5	46.0	5.5
876.0	46.1	P	21.3	H/44	-25.4	42.0	46.0	4.0
968.0	39.5	P	21.9	H/44	-24.7	36.7	54.0	17.3
32.4	44.7	P	16.3	V/44	-28.4	32.6	40.0	7.4
54.4	51.4	P	12.7	V/44	-28.1	36.0	40.0	4.0
102.4	48.4	P	10.1	V/44	-27.5	31.0	43.5	12.5
155.5	46.1	Q	10.0	V/44	-26.9	29.2	43.5	14.3
166.8	50.8	P	9.7	V/44	-26.7	33.8	43.5	9.7
189.2	40.6	P	9.7	V/44	-26.5	23.8	43.5	19.7
216.0	43.9	P	11.2	V/44	-26.2	28.9	46.0	17.1
231.2	42.2	P	11.6	V/44	-26.2	27.6	46.0	18.4
277.1	46.7	P	13.1	V/44	-27.4	32.4	46.0	13.6
358.8	46.4	P	14.6	V/44	-27.3	33.7	46.0	12.3
460.2	52.3	P	16.4	V/44	-26.9	41.8	46.0	4.2
463.6	37.4	P	16.8	V/44	-26.9	27.3	46.0	18.7
497.7	35.1	P	17.3	V/44	-26.8	25.6	46.0	20.4
513.0	46.3	P	17.7	V/44	-26.8	37.2	46.0	8.8
691.0	44.5	P	20.6	V/44	-26.5	38.6	46.0	7.4
784.0	40.3	P	20.8	V/44	-26.0	35.1	46.0	10.9
875.0	40.4	P	21.3	V/44	-25.4	36.3	46.0	9.7
967.0	38.4	P	21.8	V/44	-24.7	35.5	54.0	18.5

Judgment: Passed by 4.0 dB

Figure 3. Drawing of Radiated Emissions Test Setup

Chamber E, anechoic

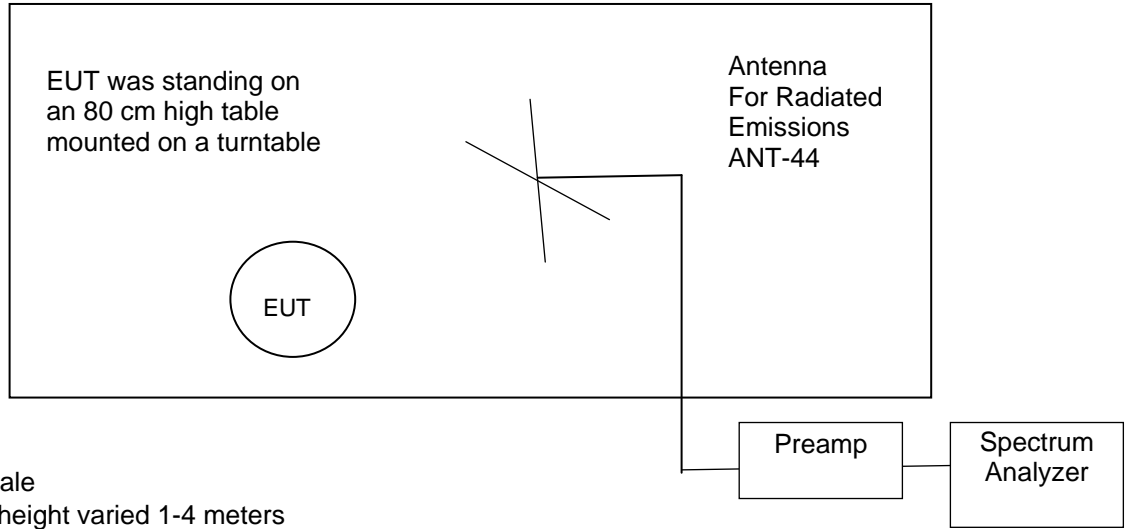

Notes:

- Not to Scale
- Antenna height varied 1-4 meters
- Distance from antenna to tested system is 3 meters
- AC cords not shown. They are connected to AC outlet with low-pass filter on turntable

Frequency Range	Receive Antenna	Pre-Amplifier	Spectrum Analyzer
0.01 to 30 MHz	ANT-53	None	REC-07
30 to 1000 MHz	ANT-44	AMP-22	REC-07

10.3 Magnetic Field Measurements and Decay Factor Calculations

Radiated emission measurements are performed with a shielded loop antenna. An EMCO Loop antenna was used. The antenna was rotated in order to find the maximize readings.

The distance factor in (dB) = $DE \cdot 20 \cdot \log(TD/SD)$

Where: DE = Decay Exponent (2.0 is used for this)

TD = Test distance in meters. This is usually 3 meters

SD = Specification Distance in meters

For frequencies above 490 kHz, the specification distance is 30. The Distance correction factor at 3 meters is -40 dB.

10.3.1 Magnetic Field Radiated Emissions Results (0.009 to 30 MHz)

Test Date	September 11, 2013
Test Distance	3 Meters
Specification	FCC 15 & RSS-GEN
Notes	A shielded Loop Antenna was used for this test.
EUT's tested	RDR-7081AKU (USB) and RDR-7081AK2 (Serial)

RDR-7082AKU; Serial Number I000012 (USB)

RDR-7081AK2 Serial Number I020012 (Serial)

Freq (kHz)	meter reading dBuV	Loop Ant Factor	Dist (m)	Decay exp	Cable Loss dB	FCC Distance factor dB	Field Strength dBuV/m	RSS-GEN Limit dBuV/m	Margin under limit	Model
13560	49.5	16.8	3.0	2.0	0.4	-40.0	26.7	29.5	2.8	USB
27120	18.1	16.0	3.0	2.0	0.5	-40.0	-5.4	29.5	34.9	USB
13560	49.1	16.8	3.0	2.0	0.4	-40.0	26.3	29.5	3.2	Serial
27120	17.3	16.0	3.0	2.0	0.5	-40.0	-6.2	29.5	35.7	Serial

Judgement: Passed by 2.8 dB.

No other emissions were detected from 10 kHz to 30 MHz.

10.4 Occupied Bandwidth Data

The occupied bandwidth of the RF output was measured using a spectrum analyzer. The bandwidth was measured using the peak detector function and a narrow resolution bandwidth.

A broadband antenna was used to receive the modulated signal. The spectrum analyzer was set to the MAX HOLD mode to record the worst case of the modulation. The spectrum analyzer display was digitized and plotted. A limit was drawn on the plots based on the level of the modulated carrier. The plots of the occupied bandwidth for the EUT are supplied on the following page.

	20 dB EBW
Product	13.56 MHz Signal
USB	5.125 kHz
Serial	5.225 kHz

Judgement: Pass

Figure 4. Occupied Bandwidth Plots 13.56 MHz

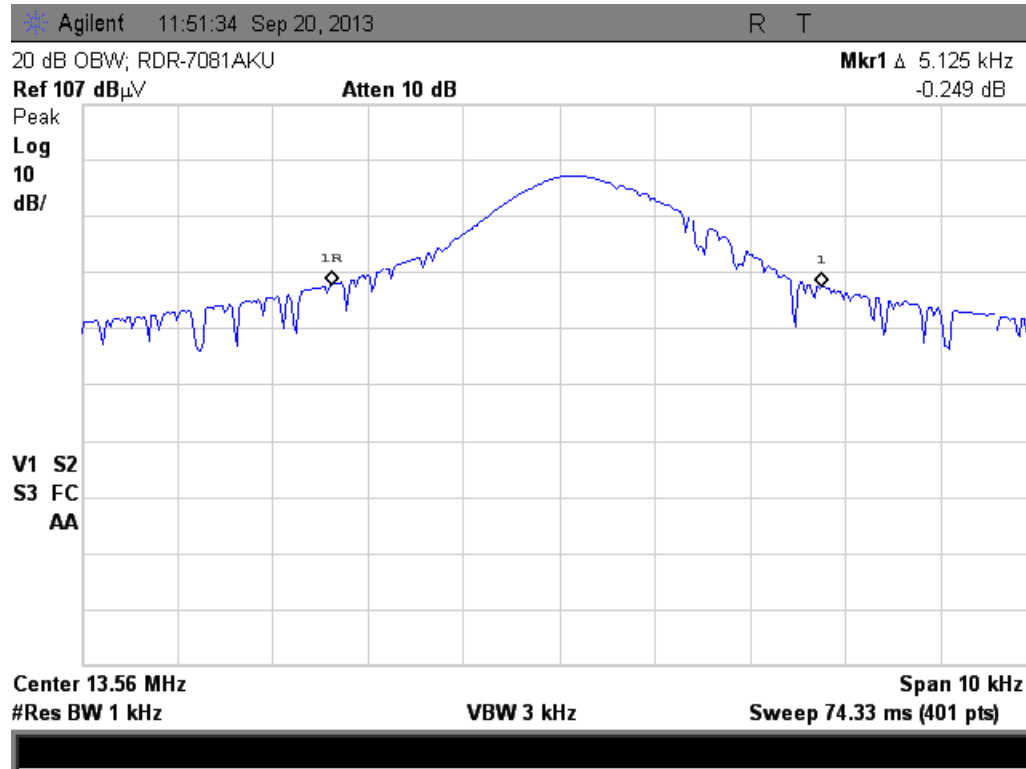

RADIOMETRICS MIDWEST CORPORATION - EMC Test Report

Testing of RF IDEas, Models RDR-7082AKU & 7082AK2, 13.56 MHz Card Readers

