



Electromagnetic Compatibility Test Report

Tests Performed on an RF IDEas, Inc.

13.56 MHz Card Reader,

Models RDR-7582AKU and RDR-7582AK2

Radiometrics Document RP-6784



Product Detail:

FCC ID: M9MRDR758X

IC ID: 6571A-RDR758X

Equipment type: Low Power Intentional Radiator

Test Standards:

US CFR Title 47, Chapter I, FCC Part 15 Subpart C

FCC Part 15 CFR Title 47: 2008

Industry Canada RSS-210, Issue 7 as required for Category I Equipment

This report concerns: Class II Permissive Change

FCC Part 15.209

RSS-210 A2.6

Tests Performed For:

RF IDEas, Inc.

4238 Arlington Heights Rd. #244

Arlington Heights, IL 60004

Test Facility:

Radiometrics Midwest Corporation

12 East Devonwood

Romeoville, IL 60446

Test Date(s): (Month-Day-Year)

April 29 thru May 21, 2010

Document RP-6784 Revisions:

Rev.	Issue Date	Affected Pages	Revised By
0	July 30, 2010		
1	August 9, 2010	All	Joseph Strzelecki
2	August 10, 2010	13	Joseph Strzelecki

Table of Contents

1 ADMINISTRATIVE DATA	3
2 TEST SUMMARY AND RESULTS	3
2.1 RF Exposure Compliance Requirements	3
3 EQUIPMENT UNDER TEST (EUT) DETAILS	4
3.1 EUT Description	4
3.1.1 FCC Section 15.203 Antenna Requirements	4
3.2 Related Submittals	4
4 TESTED SYSTEM DETAILS	4
4.1 Tested System Configuration	4
4.2 Special Accessories	5
4.3 Equipment Modifications	5
5 TEST SPECIFICATIONS AND RELATED DOCUMENTS.....	5
6 RADIOMETRICS' TEST FACILITIES	6
7 DEVIATIONS AND EXCLUSIONS FROM THE TEST SPECIFICATIONS.....	6
8 CERTIFICATION	6
9 TEST EQUIPMENT TABLE	7
10 TEST SECTIONS	7
10.1 Radiated RF Emissions	7
10.1.1 Field Strength Calculation.....	8
10.1.2 E-field Radiated Emissions Test Results (30 to 1000 MHz)	8
10.2 Magnetic Field Measurements and Decay Factor Calculations	12
10.2.1 Magnetic Field Radiated Emissions Results (0.009 to 30 MHz)	13
10.3 Occupied Bandwidth (20 dB).....	13
10.4 AC Conducted Emissions.....	15

Notice: This report must not be reproduced (except in full) without the written approval of Radiometrics Midwest Corporation.

RADIOMETRICS MIDWEST CORPORATION - EMC Test Report

Testing of the RF IDEas, Inc., Models RDR-7582AKU and RDR-7582AK2, 13.56 MHz Card Readers

1 ADMINISTRATIVE DATA

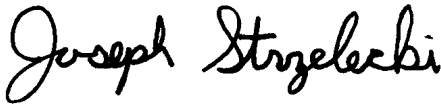
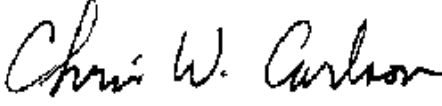
<i>Equipment Under Test:</i> An RF IDEas, Inc., 13.56 MHz Card Reader Models: RDR-7582AKU and RDR-7582AK2 This will be referred to as the EUT in this Report	
<i>Date EUT Received at Radiometrics: (Month-Day-Year)</i> April 29, 2010	<i>Test Date(s): (Month-Day-Year)</i> April 29 thru May 21, 2010
<i>Test Report Written By:</i> Joseph Strzelecki Senior EMC Engineer	<i>Test Witnessed By:</i> The tests were not witnessed by RF IDEas, Inc.
<i>Radiometrics' Personnel Responsible for Test:</i>  06/30/2010	<i>Test Report Approved By</i>  06/30/2010
Joseph Strzelecki Senior EMC Engineer NARTE EMC-000877-NE	Chris W. Carlson Director of Engineering NARTE EMC-000921-NE

2 TEST SUMMARY AND RESULTS

The EUT (Equipment Under Test) is a 13.56 MHz Card Reader, Models RDR-7582AKU and RDR-7582AK2, manufactured by RF IDEas, Inc. The detailed test results are presented in a separate section. The following is a summary of the test results.

Emissions Tests Results

Environmental Phenomena	Frequency Range	Basic Standard	Test Result
RF Radiated Emissions	30-1000 MHz	RSS-210 & FCC Part 15	Pass
RF Radiated Emissions H-Field	0.009 – 30 MHz	RSS-210 & FCC Part 15	Pass
Conducted Emissions, AC Mains	0.15 - 30 MHz	RSS-210 & FCC Part 15	Pass

2.1 RF Exposure Compliance Requirements

The equivalent radiated power output is less than 1 mW, The EUT meets the FCC and Canada requirements for RF exposure. There are no power level adjustments and the antenna is permanently attached.

3 EQUIPMENT UNDER TEST (EUT) DETAILS

3.1 EUT Description

The EUT is a 13.56 MHz Thumb Drive Card Reader, manufactured by RF IDEas, Inc. The EUT was in good working condition during the tests, with no known defects. Both versions use the same RF section.

3.1.1 Description of Change

The antenna is to be installed on the plastic frame carrier so that will be more rigid and better secured. In order to accommodate the antenna, the following changes were made to the resistors and capacitors:

R68 and R69 were changed from 15 ohm to 10 ohm
C69 and C70 were changed from 100pF to 220pF
C71 was changed from 68pF to 27pF
L53 and L54 were replaced with 0 ohm resistors
U52 was replaced with LMH6658MA

3.1.2 FCC Section 15.203 Antenna Requirements

The antenna is permanently attached to the PCB. The antenna is internal to the EUT and it is not readily available to be modified by the end user. Therefore, it meets the 15.203 Requirement.

3.2 Related Submittals

RF IDEas, Inc. is not submitting any other products simultaneously for equipment authorization related to the EUT.

4 TESTED SYSTEM DETAILS

4.1 Tested System Configuration

The system was configured for testing in a typical fashion. The EUT was placed on an 80-cm high, nonconductive test stand. The testing was performed in conditions as close as possible to installed conditions. Wiring was consistent with manufacturer's recommendations.

The EUT was connected to the host computer's USB port. Power was supplied via a USB or Serial connection to the host computer. The identification for all equipment, plus descriptions of all cables used in the tested system, are:

RADIOMETRICS MIDWEST CORPORATION - EMC Test Report

Testing of the RF IDEas, Inc., Models RDR-7582AKU and RDR-7582AK2, 13.56 MHz Card Readers

Tested System Configuration List

Item	Description	Type*	Manufacturer	Model Number	Serial Number
1	USB Card Reader	E	RF Ideas, Inc.	RDR-7582AKU	M510011
2	USB Card Reader	E	RF Ideas, Inc.	RDR-7582AK2	M510012
3	Desktop PC	H	Dell	2400	CN-OTS5438-70821-54N-3AHA
4	Mouse	P	Dell	M071KC	514086791
5	Keyboard	P	Dell	RT7D20	CN-4N454-37172-547-0145
6	Monitor	P	Hyundai	L72S	L72SSBS358K-02086

Type: E = EUT, P = Peripheral, S = Support Equipment; H = Host Computer

List of EUT Cables

QTY	Length (m)	Cable Description	Connected to (Item #)	Shielded?
1	1.8	USB Cable	#1 and #3	Yes
1	2.0	Mouse Cable	#3 and #4	Yes

4.2 Special Accessories

No special accessories were used during the tests in order to achieve compliance.

4.3 Equipment Modifications

There were no modifications made to the EUT at Radiometrics in order to comply with the specifications.

5 TEST SPECIFICATIONS AND RELATED DOCUMENTS

Document	Date	Title
FCC CFR Title 47	2008	Code of Federal Regulations Title 47, Chapter 1, Federal Communications Commission, Part 15 - Radio Frequency Devices
ANSI C63.4-2003	2003	Methods of Measurement of Radio Noise Emissions from Low-Voltage Electrical and Electronic Equipment in the Range of 9 kHz to 40 GHz
IC RSS-210 Issue 7	2007	Low Power Licence-Exempt Radiocommunication Devices (All Frequency Bands) Category I Equipment
IC RSS-Gen Issue 2	2007	General Requirements and Information for the Certification of Radiocommunication Equipment (RSS-Gen)

The test procedures used are in accordance with the ANSI document C63.4-2003, "Methods of Measurement of Radio Noise Emissions from Low-Voltage Electrical and Electronic Equipment in the Range of 9 kHz to 40 GHz". The specific procedures are described herein. Radiated testing was performed at an antenna to EUT distance of 3 meters. The antenna was raised and lowered from 1 to 4 meters.

6 RADIOMETRICS' TEST FACILITIES

The results of these tests were obtained at Radiometrics Midwest Corp. in Romeoville, Illinois, USA. Radiometrics is accredited by A2LA (American Association for Laboratory Accreditation) to conform to ISO/IEC 17025: 2005 "General Requirements for the Competence of Calibration and Testing Laboratories". Radiometrics' Lab Code is 121191 and Certification Number is 1495.01. Radiometrics' scope of accreditation includes all of the test methods listed herein. A copy of the accreditation can be accessed on our web site (www.radiomet.com). Radiometrics accreditation status can be verified at A2LA's web site (www.a2la2.org).

The following is a list of shielded enclosures located in Romeoville, Illinois that were for the tests herein:

Chamber A: Is an anechoic chamber that measures 24' L X 12' W X 12' H. The walls and ceiling are fully lined with ferrite absorber tiles. The floor has a 10' x 10' section of ferrite absorber tiles located in the center. Panashield of Rowayton, Connecticut manufactured the chamber. The enclosure is NAMAS certified.

Chamber E: Is a custom made anechoic chamber that measures 52' L X 30' W X 18' H. The walls and ceiling are fully lined with RF absorber. Pro-shield of Collinsville, Oklahoma manufactured the chamber.

Test Station F: Is an area that measures 10' D X 12' W X 10' H. The floor and back wall are metal shielded. This area is used for conducted emissions measurements.

A separate ten-foot long, brass plated, steel ground rod attached via a 6 inch copper braid grounds each of the above chambers. Each enclosure is also equipped with low-pass power line filters.

The FCC has accepted these sites as test site number US1065. The FCC test site Registration Number is 732175. Details of the site characteristics are on file with the Industry Canada as site number IC3124A-1.

A complete list of the test equipment is provided herein. The calibration due dates are indicated on the equipment list. The equipment is calibrated in accordance to ANSI/NCSL Z540-1 with traceability to the National Institute of Standards and Technology (NIST).

7 DEVIATIONS AND EXCLUSIONS FROM THE TEST SPECIFICATIONS

There were no deviations or exclusions from the test specifications.

8 CERTIFICATION

Radiometrics Midwest Corporation certifies that the data contained herein was taken under conditions that meet or exceed the requirements of the test specification. The results relate only to the EUT listed herein. Any modifications made to the EUT subsequent to the indicated test date will invalidate the data and void this certification.

RADIOMETRICS MIDWEST CORPORATION - EMC Test Report

Testing of the RF IDEas, Inc., Models RDR-7582AKU and RDR-7582AK2, 13.56 MHz Card Readers

9 TEST EQUIPMENT TABLE

RMC ID	Manufacturer	Description	Model No.	Serial No.	Frequency Range	Cal Period	Cal Date
AMP-22	Anritsu	Pre-amplifier	MH648A	M23969	0.1-1200MHz	12 Mo.	02/11/10
ANT-44	Impossible Machine	Super Log Antenna	SL-20M2G	1002	20-2000MHz	24 Mo.	11/25/09
ANT-53	EMCO	Loop Antenna	6507	1453	1 kHz-30 MHz	12 Mo	11/04/09
HPF-01	Solar	High Pass Filter	7930-100	HPF-1	0.15-30MHz	24 Mo.	10/27/09
LSN-01	Electrometrics	50 uH LISN	FCC/VDE 50/2	1001	0.01-30MHz	24 Mo.	06/01/09
REC-07	Anritsu	Spectrum Analyzer	MS2601A	MT53067	0.01-2200MHz	12 Mo.	04/06/10
THM-01	Extech Inst.	Temp/Humid Meter	4465CF	001106557	N/A	24 Mo.	02/23/09

Note: All calibrated equipment is subject to periodic checks.

10 TEST SECTIONS

10.1 Radiated RF Emissions

Radiated emission measurements were performed with linearly polarized broadband antennas. The results obtained with these antennas can be correlated with results obtained with a tuned dipole antenna.

The radiated emission measurements were performed with a spectrum analyzer. The bandwidth used from 450 kHz to 30 MHz is 9 or 10 kHz and the bandwidth from 30 MHz to 1000 MHz is 100 or 120 kHz. Above 1 GHz, a 1 MHz bandwidth is used. A 10 dB linearity check is performed prior to start of testing in order to determine if an overload condition exists.

From 30 to 1000 MHz, an Anritsu Spectrum analyzer and an amplifier with a 10 dB attenuator connected to the input was used for the measurement. The out of band emissions and the ambient emissions were below the level of input overload (80 dBuV).

Final radiated emissions measurements were performed inside of an anechoic chamber at a test distance of 3 meters. The anechoic chamber is designated as Chamber E. This Chamber meets the Site Attenuation requirements CISPR 16-1 and ANSI C63.4. Chamber E is located at 12 East Devonwood Ave. Romeoville, Illinois EMI test lab.

The entire frequency range from 0.1 to 1000 MHz was slowly scanned with particular attention paid to those frequency ranges which appeared high. Measurements were performed using two antenna polarizations, (vertical and horizontal). The worst case emissions were recorded. All measurements may be performed using either the peak or the quasi-peak detector functions. If the peak detector data exceeds or is marginally close to the limits, the measurements are repeated using a quasi-peak detector function as required by the specification for final determination of compliance.

The detected emission levels were maximized by rotating the EUT, and by scanning the measurement antenna from 1 to 4 meters above the ground.

The field strength is calculated by adding the antenna factor, distance correction factor, cable loss, and subtracting the amplifier gain from the measured reading. Each antenna, cable and amplifier has individual factors across its usable frequency range. The antenna factor converts the voltage reading in dBuV to field strength in dBuV/meter.

RADIOMETRICS MIDWEST CORPORATION - EMC Test Report

Testing of the RF IDEas, Inc., Models RDR-7582AKU and RDR-7582AK2, 13.56 MHz Card Readers

10.1.1 Field Strength Calculation

The field strength is calculated by adding the Antenna Factor and Cable Loss, and by subtracting the Amplifier Gain from the measured reading. The basic equation is as follows:

$$FS = RA + AF + CF - AG + PKA$$

Where: FS = Field Strength

RA = Receiver Amplitude

AF = Antenna Factor

CF = Cable Attenuation Factor

AG = Amplifier Gain

10.1.2 E-field Radiated Emissions Test Results (30 to 1000 MHz)

Test Date	04-29-2010
Test Distance	3 Meters
Serial Number	RDR-7582AKU; Serial M510011
Specification	FCC Part 15.209 Subpart C & RSS-210
Abbreviations	Pol = Antenna Polarization; V = Vertical; H = Horizontal; ANT-44 = BiLog Antenna ANT-12 = Dipole; P = peak; Q = QP
Configuration	Ant. Carrier

Freq. MHz	Meter Reading dBuV	Dect. Type	Antenna		Corr. Factors dB	Field Strength dBuV/m		Margin Under Limit dB
			Factor dB	Pol/ ID#		EUT	Limit	
81.2	51.9	P	6.9	H/44	-27.0	31.8	40.0	8.2
96.8	56.7	P	8.9	H/44	-26.8	38.8	43.5	4.7
215.6	46.0	P	11.1	H/44	-25.8	31.2	43.5	12.3
54.0	40.1	Q	12.9	H/44	-27.5	25.6	40.0	14.4
179.1	47.6	Q	9.2	H/44	-26.1	30.7	43.5	12.8
176.8	43.0	Q	9.3	H/44	-26.1	26.1	43.5	17.4
54.0	41.3	Q	12.9	H/44	-27.5	26.8	40.0	13.2
258.1	50.0	P	12.8	H/44	-25.6	37.2	46.0	8.8
301.8	46.6	P	13.2	H/44	-25.2	34.6	46.0	11.4
329.2	45.3	P	13.7	H/44	-25.3	33.7	46.0	12.3
361.7	43.6	P	14.8	H/44	-24.9	33.5	46.0	12.5
442.3	47.2	P	16.1	H/44	-24.5	38.8	46.0	7.2
462.5	42.1	P	17.0	H/44	-24.3	34.8	46.0	11.2
474.8	39.7	P	17.3	H/44	-24.1	32.9	46.0	13.1
601.0	37.3	P	18.7	H/44	-23.3	32.6	46.0	13.4
662.0	39.5	P	19.9	H/44	-22.9	36.5	46.0	9.5
696.0	36.2	P	19.7	H/44	-22.8	33.2	46.0	12.8
726.0	36.0	P	19.8	H/44	-22.5	33.3	46.0	12.7
760.0	37.0	P	20.3	H/44	-22.2	35.1	46.0	10.9
830.0	34.6	P	21.5	H/44	-21.5	34.6	46.0	11.4
887.0	38.9	P	21.5	H/44	-21.2	39.2	46.0	6.8
923.0	36.6	P	22.1	H/44	-20.7	38.0	46.0	8.0
951.0	31.6	P	22.5	H/44	-20.0	34.0	46.0	12.0
111.2	53.3	P	12.4	V/44	-26.7	39.1	43.5	4.4

RADIOMETRICS MIDWEST CORPORATION - EMC Test Report

Testing of the RF IDEas, Inc., Models RDR-7582AKU and RDR-7582AK2, 13.56 MHz Card Readers

Freq. MHz	Meter Reading dBuV	Dect. Type	Antenna		Corr. Factors dB	Field Strength dBuV/m		Margin Under Limit dB
			Factor dB	Pol/ ID#		EUT	Limit	
148.8	45.0	P	10.0	V/44	-26.3	28.6	43.5	14.9
182.4	50.1	P	9.2	V/44	-26.1	33.2	43.5	10.3
208.8	46.2	P	10.3	V/44	-25.9	30.6	43.5	12.9
44.4	35.5	Q	14.9	V/44	-27.6	22.8	40.0	17.2
54.0	50.5	Q	12.9	V/44	-27.5	36.0	40.0	4.0
248.0	42.2	P	12.6	V/44	-25.5	29.3	46.0	16.7
271.5	40.7	P	13.0	V/44	-25.5	28.1	46.0	17.9
300.1	44.1	P	13.1	V/44	-25.2	31.9	46.0	14.1
315.2	42.2	P	13.6	V/44	-25.3	30.5	46.0	15.5
360.0	41.7	P	14.8	V/44	-24.9	31.6	46.0	14.4
395.8	45.6	P	15.4	V/44	-24.9	36.1	46.0	9.9
412.1	45.2	P	16.5	V/44	-24.6	37.1	46.0	8.9
479.3	38.4	P	17.0	V/44	-24.0	31.4	46.0	14.6
496.1	41.8	P	17.1	V/44	-24.0	34.8	46.0	11.2
508.0	48.6	P	17.2	V/44	-24.1	41.7	46.0	4.3
583.0	39.0	P	18.1	V/44	-23.3	33.8	46.0	12.2
635.0	37.6	P	18.9	V/44	-23.0	33.4	46.0	12.6
700.0	41.4	P	19.6	V/44	-22.7	38.3	46.0	7.7
732.0	41.9	P	19.7	V/44	-22.5	39.1	46.0	6.9
787.0	41.1	P	20.3	V/44	-22.1	39.3	46.0	6.7
868.0	38.9	P	21.0	V/44	-21.3	38.6	46.0	7.4
889.0	38.0	P	21.5	V/44	-21.1	38.3	46.0	7.7
918.0	37.2	P	22.5	V/44	-20.8	38.9	46.0	7.1
959.0	34.8	P	22.4	V/44	-19.9	37.3	46.0	8.7
979.0	34.8	P	22.0	V/44	-19.7	37.1	54.0	16.9
508.1	30.7	Q	17.2	V/44	-24.1	23.9	46.0	22.1
835.9	24.4	Q	21.6	V/44	-21.5	24.6	46.0	21.4

EUT : RDR-7582AK2; Serial S/N M510012

Freq. MHz	Meter Reading dBuV	Dect. Type	Antenna		Corr. Factors dB	Field Strength dBuV/m		Margin Under Limit dB
			Factor dB	Pol/ ID#		EUT	Limit	
68.8	48.5	P	7.9	V/44	-27.2	29.3	40.0	10.7
96.0	52.1	P	8.7	V/44	-26.8	34.0	43.5	9.5
135.2	39.1	P	12.4	V/44	-26.5	25.0	43.5	18.5
165.2	44.7	P	9.9	V/44	-26.2	28.4	43.5	15.1
180.8	50.8	P	9.2	V/44	-26.1	34.0	43.5	9.5
204.8	44.3	P	9.8	V/44	-25.9	28.1	43.5	15.4
40.7	50.2	Q	15.3	V/44	-27.6	37.8	40.0	2.2
233.4	39.2	P	11.8	V/44	-25.6	25.4	46.0	20.6
249.1	42.2	P	12.6	V/44	-25.5	29.2	46.0	16.8
268.2	42.2	P	12.9	V/44	-25.6	29.5	46.0	16.5
288.9	46.1	P	12.6	V/44	-25.3	33.4	46.0	12.6
362.8	41.4	P	14.8	V/44	-24.9	31.3	46.0	14.7

RADIOMETRICS MIDWEST CORPORATION - EMC Test Report

Testing of the RF IDEas, Inc., Models RDR-7582AKU and RDR-7582AK2, 13.56 MHz Card Readers

Freq. MHz	Meter Reading dBuV	Dect. Type	Antenna		Corr. Factors dB	Field Strength dBuV/m		Margin Under Limit dB
			Factor dB	Pol/ ID#		EUT	Limit	
442.9	44.1	P	16.0	V/44	-24.5	35.5	46.0	10.5
479.3	37.1	P	17.0	V/44	-24.0	30.1	46.0	15.9
507.0	36.0	P	17.2	V/44	-24.1	29.1	46.0	16.9
596.0	37.1	P	18.6	V/44	-23.3	32.4	46.0	13.6
633.0	37.6	P	18.9	V/44	-23.1	33.4	46.0	12.6
696.0	40.7	P	19.7	V/44	-22.8	37.6	46.0	8.4
728.0	37.8	P	19.7	V/44	-22.5	35.0	46.0	11.0
760.0	37.0	P	20.3	V/44	-22.2	35.0	46.0	11.0
787.0	38.0	P	20.3	V/44	-22.1	36.2	46.0	9.8
886.0	39.3	P	21.5	V/44	-21.2	39.7	46.0	6.3
962.0	31.2	P	22.3	V/44	-19.9	33.6	54.0	20.4
40.7	43.5	Q	15.3	V/44	-27.6	31.1	40.0	8.9
41.2	44.3	P	15.3	V/44	-27.6	32.0	40.0	8.0
72.0	48.4	P	7.2	V/44	-27.1	28.5	40.0	11.5
82.8	48.5	P	7.1	V/44	-27.0	28.6	40.0	11.4
96.0	53.7	P	8.7	V/44	-26.8	35.5	43.5	8.0
179.2	56.0	P	9.2	V/44	-26.1	39.1	54.0	14.9
96.0	51.6	Q	8.7	V/44	-26.8	33.5	43.5	10.0
179.1	43.3	Q	9.2	V/44	-26.1	26.4	43.5	17.1
240.7	40.6	P	12.2	V/44	-25.5	27.3	46.0	18.7
258.6	39.2	P	12.8	V/44	-25.6	26.5	46.0	19.5
282.7	43.5	P	12.9	V/44	-25.4	30.9	46.0	15.1
303.4	41.8	P	13.3	V/44	-25.2	29.9	46.0	16.1
316.3	39.3	P	13.6	V/44	-25.3	27.7	46.0	18.3
416.0	44.0	P	16.7	V/44	-24.5	36.2	46.0	9.8
446.8	47.2	P	16.0	V/44	-24.5	38.7	46.0	7.3
460.2	50.4	P	16.8	V/44	-24.3	42.9	46.0	3.1
473.7	43.3	P	17.3	V/44	-24.1	36.5	46.0	9.5
486.6	40.5	P	17.3	V/44	-24.0	33.8	46.0	12.2
498.9	46.3	P	17.0	V/44	-24.1	39.2	46.0	6.8
461.1	50.5	Q	16.9	V/44	-24.3	43.1	46.0	2.9
516.0	35.6	P	17.5	V/44	-23.9	29.2	46.0	16.8
596.0	36.6	P	18.6	V/44	-23.3	31.9	46.0	14.1
633.0	38.8	P	18.9	V/44	-23.1	34.6	46.0	11.4
678.0	37.6	P	19.3	V/44	-23.0	33.9	46.0	12.1
705.0	38.8	P	19.5	V/44	-22.6	35.6	46.0	10.4
723.0	39.1	P	19.7	V/44	-22.5	36.3	46.0	9.7
760.0	39.7	P	20.3	V/44	-22.2	37.7	46.0	8.3
786.0	39.2	P	20.4	V/44	-22.1	37.5	46.0	8.5
794.0	41.1	P	20.1	V/44	-22.0	39.2	46.0	6.8
814.0	38.3	P	21.2	V/44	-21.7	37.8	46.0	8.2
886.0	36.7	P	21.5	V/44	-21.2	37.1	46.0	8.9
927.0	37.4	P	21.8	V/44	-20.6	38.6	46.0	7.4
41.2	39.3	P	15.3	H/44	-27.6	27.0	40.0	13.0
68.0	42.9	P	8.1	H/44	-27.2	23.8	40.0	16.2

RADIOMETRICS MIDWEST CORPORATION - EMC Test Report

Testing of the RF IDEas, Inc., Models RDR-7582AKU and RDR-7582AK2, 13.56 MHz Card Readers

Freq. MHz	Meter Reading dBuV	Dect. Type	Antenna		Corr. Factors dB	Field Strength dBuV/m		Margin Under Limit dB
			Factor dB	Pol/ ID#		EUT	Limit	
99.6	47.1	P	9.4	H/44	-26.8	29.7	43.5	13.8
124.8	38.2	P	14.5	H/44	-26.5	26.2	43.5	17.3
162.0	53.4	P	10.2	H/44	-26.2	37.4	43.5	6.1
162.7	53.6	Q	10.1	H/44	-26.2	37.5	43.5	6.0
177.6	51.8	P	9.2	H/44	-26.1	34.9	43.5	8.6
178.5	45.8	Q	9.2	H/44	-26.1	28.9	43.5	14.6
197.6	45.9	P	9.6	H/44	-26.0	29.5	43.5	14.0
214.8	42.1	P	11.1	H/44	-25.8	27.4	43.5	16.1
240.2	48.1	P	12.2	H/44	-25.5	34.8	46.0	11.2
259.2	48.1	P	12.7	H/44	-25.6	35.2	46.0	10.8
303.4	45.9	P	13.3	H/44	-25.2	34.0	46.0	12.0
329.2	44.9	P	13.7	H/44	-25.3	33.3	46.0	12.7
360.0	42.7	P	14.8	H/44	-24.9	32.6	46.0	13.4
419.9	42.6	P	16.9	H/44	-24.5	35.0	46.0	11.0
446.8	47.0	P	16.0	H/44	-24.5	38.5	46.0	7.5
460.2	50.1	P	16.8	H/44	-24.3	42.6	46.0	3.4
461.1	48.3	Q	16.9	H/44	-24.3	40.9	46.0	5.1
473.7	45.4	P	17.3	H/44	-24.1	38.6	46.0	7.4
493.3	41.3	P	17.2	H/44	-24.0	34.5	46.0	11.5
505.0	43.7	P	17.1	H/44	-24.1	36.7	46.0	9.3
624.0	44.2	P	18.6	H/44	-23.2	39.6	46.0	6.4
678.0	42.7	P	19.3	H/44	-23.0	39.0	46.0	7.0
732.0	43.3	P	19.7	H/44	-22.5	40.5	46.0	5.5
746.0	41.8	P	20.7	H/44	-22.4	40.1	46.0	5.9
800.0	42.3	P	20.3	H/44	-21.9	40.7	46.0	5.3
814.0	41.6	P	21.2	H/44	-21.7	41.1	46.0	4.9
854.0	41.1	P	21.1	H/44	-21.4	40.8	46.0	5.2
886.0	41.0	P	21.5	H/44	-21.2	41.3	46.0	4.7
927.0	36.5	P	21.8	H/44	-20.6	37.7	46.0	8.3

Judgement	Pass By 2.2 dB
------------------	-----------------------

Figure 1. Drawing of Radiated Emissions Setup

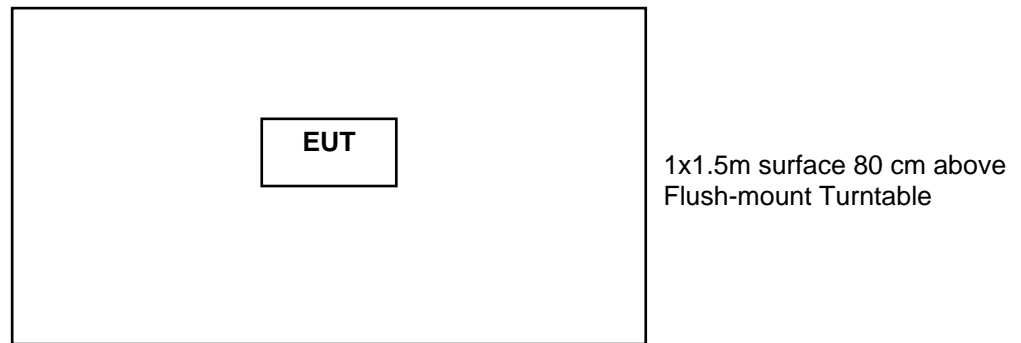

Notes:

- AC outlet with low-pass filter at the base of the turntable
- Antenna height varied from 1 to 4 meters
- Distance from antenna to tested system is 3 meters
- Not to Scale

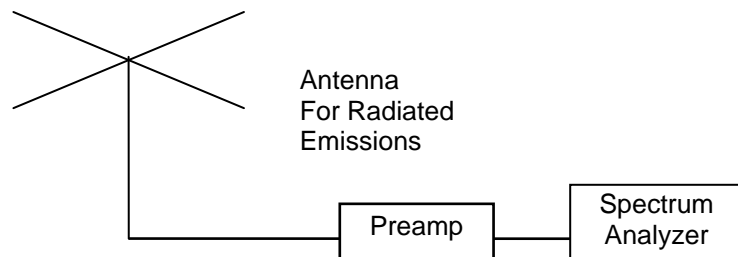

10.2 Magnetic Field Measurements and Decay Factor Calculations

Radiated emission measurements are performed with shielded loop antennas. An EMCO Active Loop antenna were used. The antennas were rotated in order to find the maximize readings. The measurements were performed at two distances.

The decay exponent used is 2. The distance correction factor is calculated as follows:

$$\text{Distance factor (dB)} = 40 * \text{Log}(\text{TD}/\text{SD})$$

TD is the actual test distance in meters. SD meters is the specification distance.

RADIOMETRICS MIDWEST CORPORATION - EMC Test Report

Testing of the RF IDEas, Inc., Models RDR-7582AKU and RDR-7582AK2, 13.56 MHz Card Readers

10.2.1 Magnetic Field Radiated Emissions Results (0.009 to 30 MHz)

Test Date	May 24, 2010
Test Distance	3 Meters
Specification	FCC 15.209 & RSS-210 section A2.6
Notes	Corr. Factors = cable loss - preamp gain - distance factor. Decay Exponent = 2 Shielded Loop Antennas were used for this test. The distance factor = $2 \times 20 \times \log(6/30) = -27.96$ dB The specification distance is 30 meters

EUT RDR-7582AKU S/N M510011

Freq MHz	Peak meter reading dBuV	Loop Ant Factor	Dist (m)	Decay exp	Cable Loss dB	Distance factor dB	Field Strength dBuV/m	RSS-210 & FCC 15.209 Limit dBuV/m	Margin under limit
13.560	47.5	17.5	3.0	2.0	0.4	-40.0	25.4	29.5	4.1
27.120	18.1	16.9	3.0	2.0	0.5	-40.0	-4.5	29.5	34.0

EUT RDR-7582AK2; S/N M510012

Freq MHz	Peak meter reading dBuV	Loop Ant Factor	Dist (m)	Decay exp	Cable Loss dB	Distance factor dB	Field Strength dBuV/m	RSS-210 & FCC 15.209 Limit dBuV/m	Margin under limit
13.560	45.1	17.5	3.0	2.0	0.4	-40.0	23.0	29.5	6.5
27.120	18.7	16.9	3.0	2.0	0.5	-40.0	-3.9	29.5	33.4

Judgement: Passed by 4.1 dB.

10.3 Occupied Bandwidth (20 dB)

The spectrum analyzer was set to the MAX HOLD mode to record the worst case of the modulation. The EUT was transmitting at its maximum data rate. The trace was allowed to stabilize.

A broadband antenna was used to receive the modulated signal. The spectrum analyzer was set to the MAX HOLD mode to record the worst case of the modulation. The spectrum analyzer display was digitized and plotted. A limit was drawn on the plots based on the level of the modulated carrier. The plots of the occupied bandwidth for the EUT are supplied on the following page.

The 20 dB bandwidth was measured with respect to the peak of the emission. It was found to be 5.1 kHz.

Figure 2. Occupied Bandwidth Plot

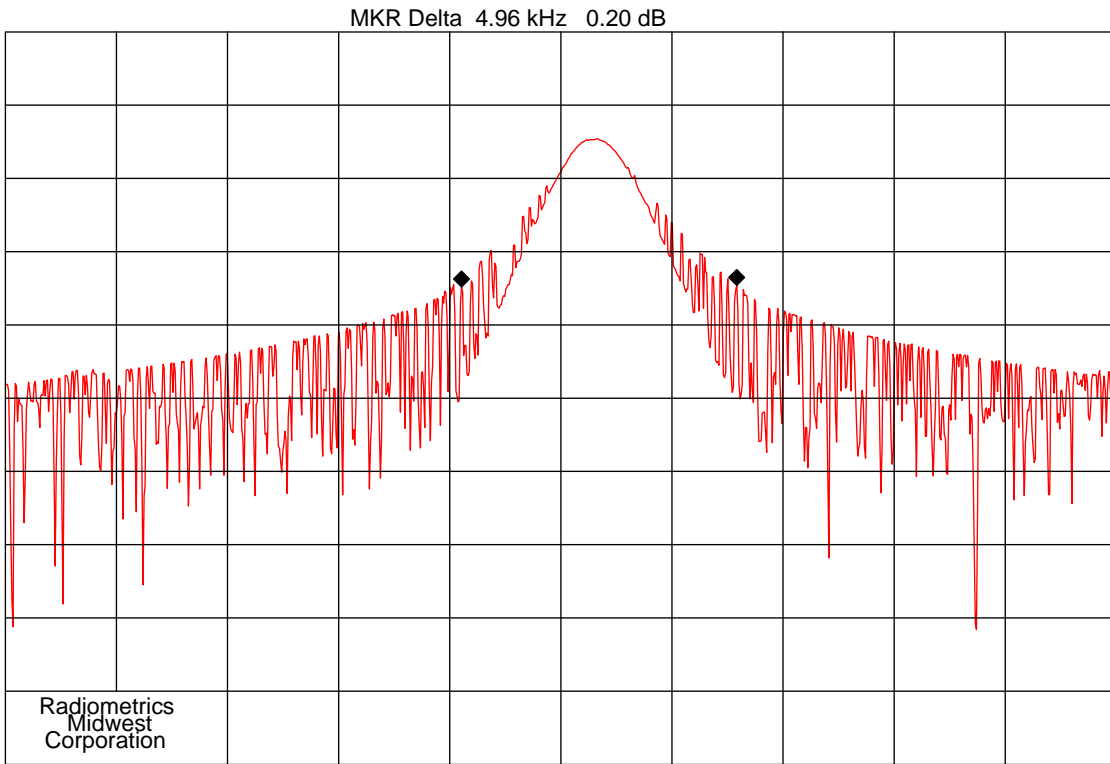

Company: RF Ideas
CENTER 13.560 0 MHz
RES BW 1 kHz
10 dB/
Notes: 20DB Occupied Bandwidth, S/N M510011

ITEM : RDR-7582AK2
REF 10.0 dBm
VBW 3 kHz
Time: 09:33

Date : 05-24-2010
SPAN 20.0 kHz
ATTEN 20 dB
SWP 300 msec

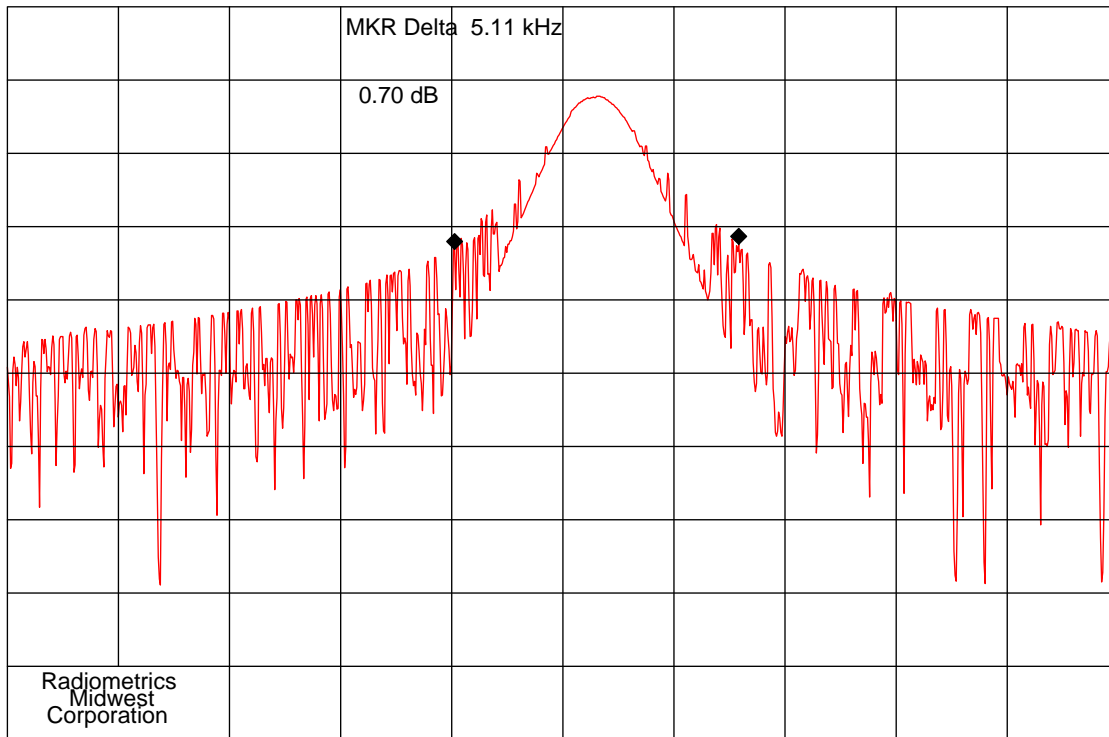

Company: RF Ideas

ITEM : RDR-7582AKU

Date : 05-24-2010

CENTER 13.560 0 MHz

REF. 10.0 dBm

SPAN 20.0 kHz

RES. BW 1.0 kHz

Time: 08:55

ATTEN 20 dB

Notes: 20 dB Occupied Bandwidth, S/N M510011

Video 3 kHz

SWP 300 msec

The 20 dB bandwidth is 5.1 kHz

10.4 AC Conducted Emissions

The tests and limits are in accordance with FCC section 15.207 and RSS Gen section 7.2.2. A computer-controlled analyzer was used to perform the conducted emissions measurements. The frequency range was divided into 500 subranges equally spaced on a logarithmic scale. The computer recorded the peak of each subrange. This data was then plotted on semi-log graph paper generated by the computer and plotter. Adjusting the positions of the cables and orientation of the test system then maximizes the highest emissions.

Mains Conducted emission measurements were performed using a 50 Ohm/50 uH Line Impedance Stabilization Network (LISN) as the pick-up device. Measurements were repeated on both leads within the power cord. If the EUT power cord exceeded 80 cm in length, the excess length of the power cord was made into a 30 to 40 cm bundle near the center of the cord. The LISN was placed on the floor at the base of the test platform and electrically bonded to the ground plane. Broadband conducted emissions may exceed the following limits by no more than 13 dB. An emission is defined as broadband if the average detector amplitude is 6 dB or more under the quasi-peak detector amplitude.

RADIOMETRICS MIDWEST CORPORATION - EMC Test Report

Testing of the RF IDEas, Inc., Models RDR-7582AKU and RDR-7582AK2, 13.56 MHz Card Readers

FCC Limits of Conducted Emissions at the AC Mains Ports

Frequency Range (MHz)	Class B Limits (dBuV)	
	Quasi-Peak	Average
0.150 - 0.50*	66 - 56	56 - 46
0.5 – 5.0	56	46
5.0 - 30	60	50

* The limit decreases linearly with the logarithm of the frequency in this range.

The initial step in collecting conducted data is a peak detector scan and the plotting of the measurement range. Significant peaks are then marked as shown on the following table, and these signals are then measured with the quasi-peak detector. The following represents the worst case emissions from the host computer (with the EUT connected) power cord, after testing all modes of operation.

Model Number: RDR-75D1AKU

Test Date : 03/22/2010

Specification : FCC Part 15

The Amplitude is the final corrected value with cable and LISN Loss.

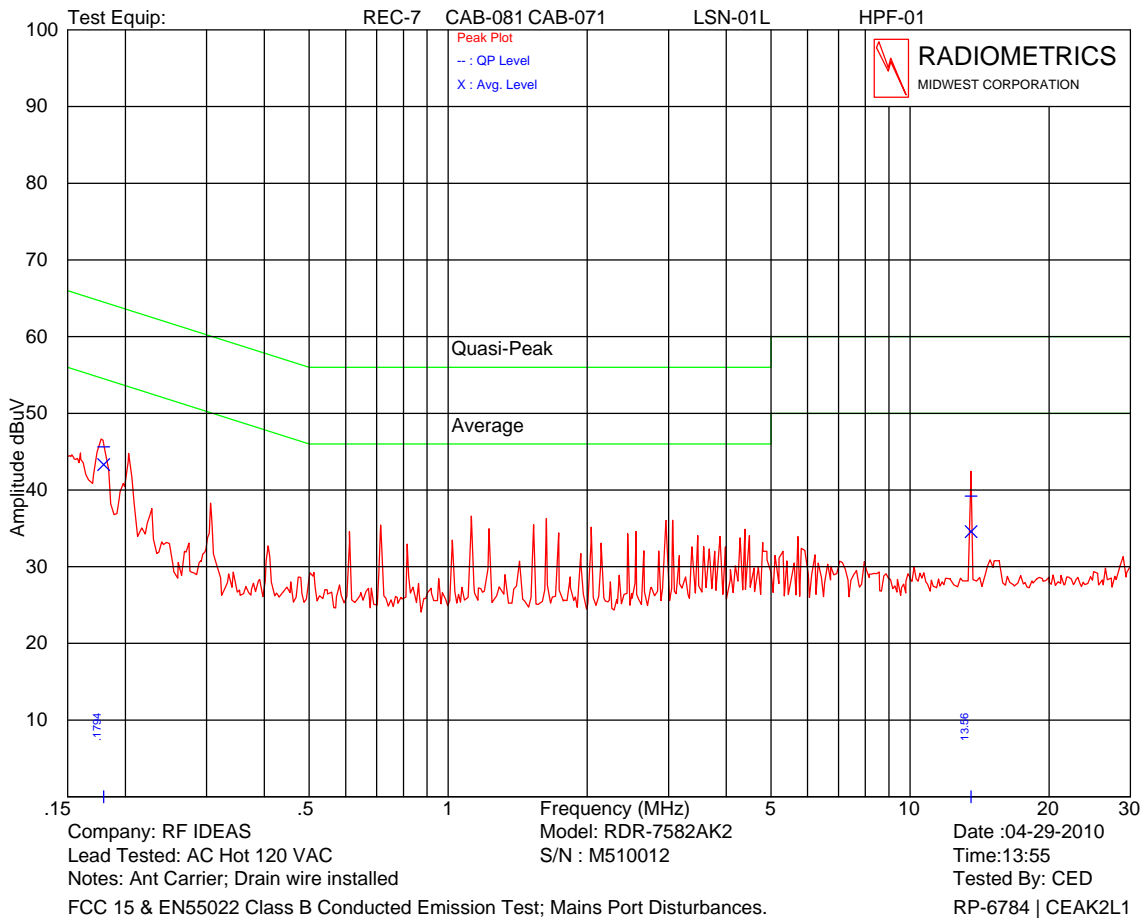

RADIOMETRICS MIDWEST CORPORATION - EMC Test Report
 Testing of the RF IDEas, Inc., Models RDR-7582AKU and RDR-7582AK2, 13.56 MHz Card Readers

Frequency MHz	QP Amplitude	QP Limit	Average Amplitude	Average Limit
0.179	45.6	64.5	43.3	54.5
13.561	39.2	60.0	34.6	50.0

Judgment: Passed by at least 8 dB.

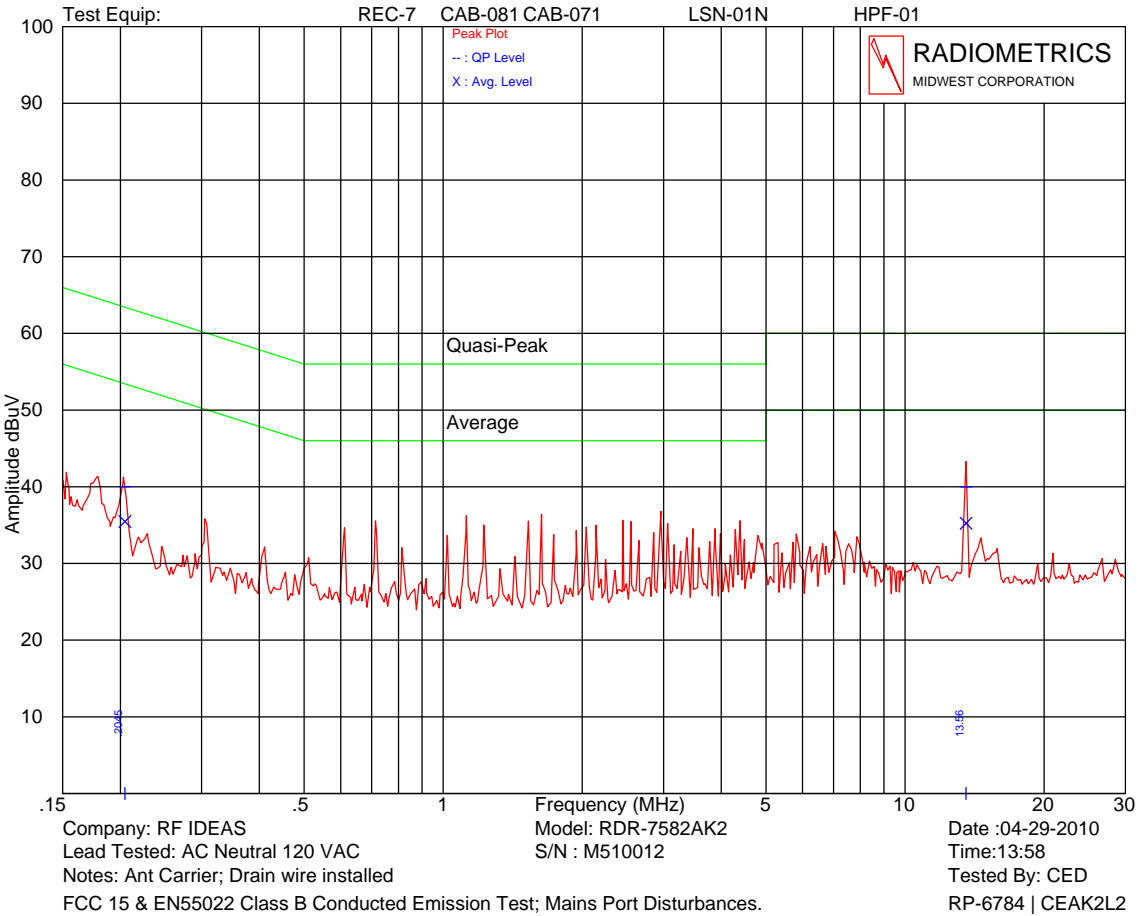

Frequency MHz	QP Amplitude	QP Limit	Average Amplitude	Average Limit
0.205	40.0	63.4	35.5	53.4
13.561	40.0	60.0	35.2	50.0

Judgment: Passed by at least 10 dB.

RADIOMETRICS MIDWEST CORPORATION - EMC Test Report

Testing of the RF IDEas, Inc., Models RDR-7582AKU and RDR-7582AK2, 13.56 MHz Card Readers

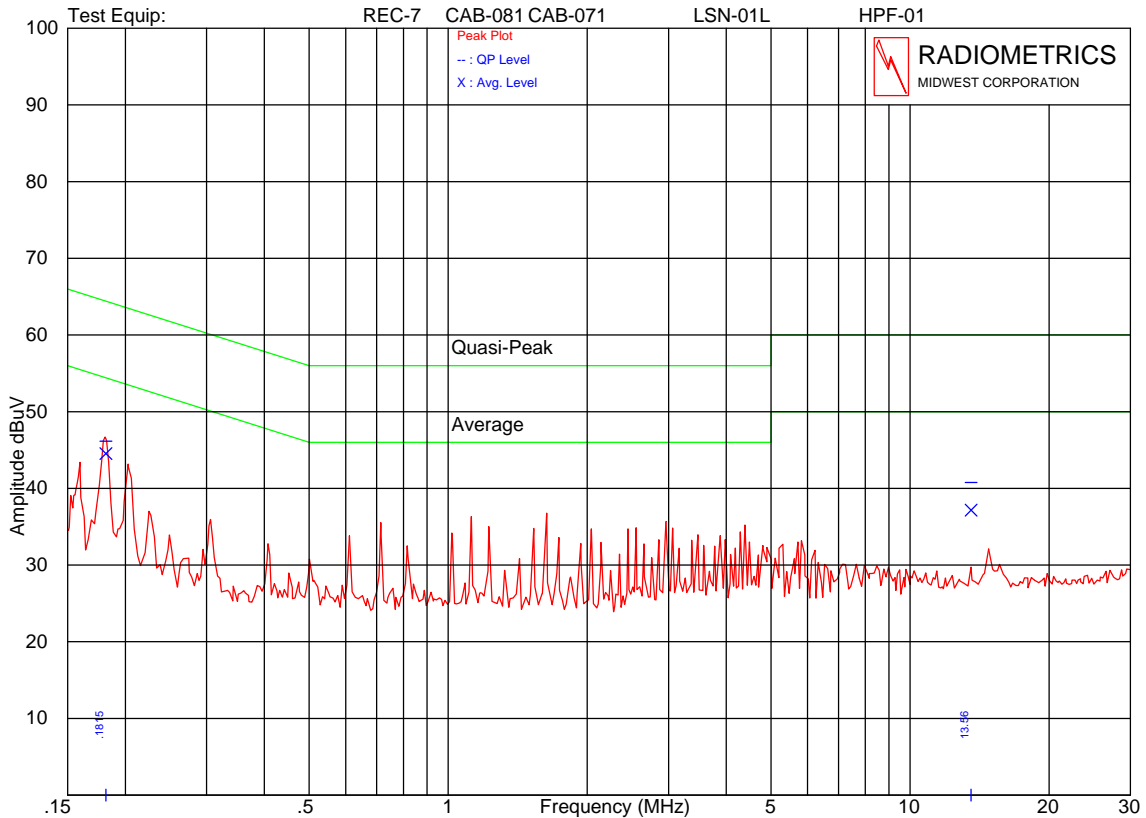

Company: RF IDEAS
 Lead Tested: AC Hot 120 VAC
 Notes: Ant Carrier
 FCC 15 & EN55022 Class B Conducted Emission Test; Mains Port Disturbances.

Frequency MHz	QP Amplitude	QP Limit	Average Amplitude	Average Limit
0.182	46.2	64.4	44.5	54.4
13.561	40.8	60.0	37.2	50.0

Judgment: Passed by at least 8 dB.

Figure 3. Conducted Emissions Test Setup

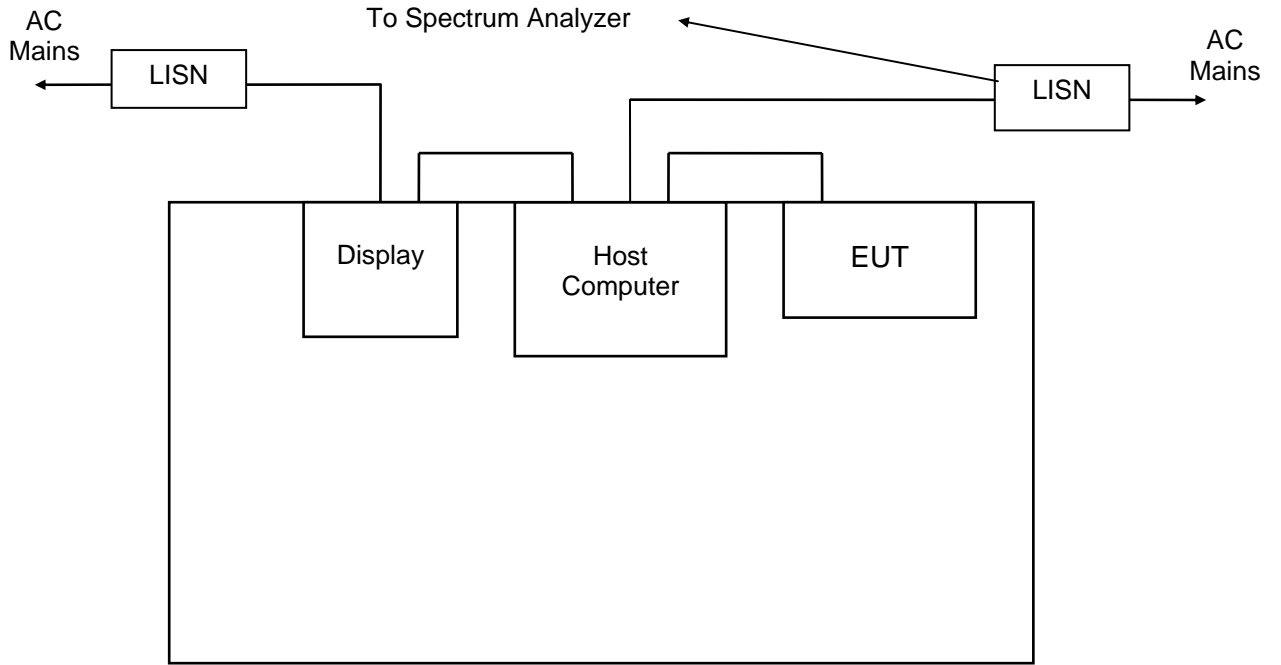

1x1.5m surface

Notes:

- LISN's at least 80 cm from EUT chassis
- Vertical conductive plane 40 cm from rear of table top
- EUT power cord bundled