



# Electromagnetic Compatibility Test Report

Tests Performed on an RF IDEas, Inc.

Wave ID RFID Reader, Model RDF-30041AKU

Radiometrics Document RP-9316



<b>Product Detail:</b>			
FCC ID: M9MF90100			
IC: 6571A-F90100			
Equipment type: Dual Frequency Card Reader			
<b>Test Standards:</b>			
US CFR Title 47, Chapter I, FCC Part 15 Subpart C			
FCC Part 15 CFR Title 47: 2020			
Canada ISED; RSS-210, Issue 10: 2019 as required for Category I Equipment			
FCC Part 15.209			
<b>Tests Performed For:</b>		<b>Test Facility:</b>	
RF IDEas, Inc. 4020 Winnetka Av. Rolling Meadows, IL 60008		Radiometrics Midwest Corporation 12 Devonwood Avenue Romeoville, IL 60446	
<b>Test completion Date(s):</b>			
July 21, 2020			
<b>Document RP-9316 Revisions:</b>			
Rev.	Issue Date	Affected Sections	Revised By
0	August 10, 2020		



## Table of Contents

1.0 ADMINISTRATIVE DATA .....	3
2.0 TEST SUMMARY AND RESULTS .....	3
2.1 RF Exposure Compliance Requirements.....	3
3.0 EQUIPMENT UNDER TEST (EUT) DETAILS.....	3
3.1 EUT Description .....	3
3.1.1 FCC Section 15.203 & RSS-GEN Antenna Requirements .....	4
3.1.2 Product Family .....	4
3.2 Related Submittals .....	4
4.0 TESTED SYSTEM DETAILS .....	4
4.1 Tested System Configuration .....	4
4.2 Special Accessories .....	5
4.3 Equipment Modifications .....	5
5.0 TEST SPECIFICATIONS.....	5
6.0 TEST PROCEDURE DOCUMENTS.....	5
7.0 RADIOMETRICS' TEST FACILITIES.....	5
8.0 DEVIATIONS AND EXCLUSIONS FROM THE TEST SPECIFICATIONS .....	6
9.0 CERTIFICATION .....	6
10.0 TEST EQUIPMENT TABLE .....	6
11.0 TEST SECTIONS .....	7
11.1 AC Conducted Emissions.....	7
11.2 Radiated RF Emissions .....	10
11.2.1 Field Strength Calculation .....	11
11.2.2 Radiated Emissions Test Results.....	11
11.3 Magnetic Field Measurements and Decay Factor Calculations.....	14
11.3.1 Magnetic Field Radiated Emissions Results (0.009 to 30 MHz) .....	15
11.4 Occupied Bandwidth Data .....	16
12.0 MEASUREMENT INSTRUMENTATION UNCERTAINTY .....	17

Notice: This report must not be reproduced (except in full) without the written approval of Radiometrics Midwest Corporation.

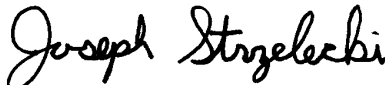

### 1.0 ADMINISTRATIVE DATA

<i>Equipment Under Test:</i>	
An RF IDEas, Inc., Wave ID, RFID Reader Models: RDF-30041AKU This will be referred to as the EUT in this Report	
<i>Date EUT Received at Radiometrics:</i>	<i>Test Date(s):</i>
July 13, 2020	July 13 to 21, 2020
<i>Test Report Written and Authorized by:</i>	<i>Radiometrics' Personnel Responsible for Test:</i>
 08/07/2020	Joseph Strzelecki Senior EMC Engineer
Joseph Strzelecki Senior EMC Engineer NARTE EMC-000877-NE	Richard L. Tichgelaar EMC Technician
	Chris E. D'Alessio EMC Technician
<i>Test Witnessed By:</i>	
The tests were partially witnessed by Shiung Lo of RF IDEas, Inc.	

### 2.0 TEST SUMMARY AND RESULTS

The EUT (Equipment Under Test) is a Wave ID RFID Reader, manufactured by RF IDEas, Inc. The detailed test results are presented in a separate section. The following is a summary of the test results.

Emissions Tests Results per RSS-210 & FCC Part 15

Environmental Phenomena	Frequency Range	Test Result
RF Radiated Emissions	30-1000 MHz	Pass
Conducted Emissions, AC Mains	0.15 - 30 MHz	Pass
RF Radiated Emissions H-Field	0.009 – 30 MHz	Pass
Occupied Bandwidth	125 kHz & 13.56 MHz	Pass

#### 2.1 RF Exposure Compliance Requirements

Since the effective power output is less than 1 mW, the EUT meets the FCC requirement for RF exposure and is exempt from RSS-102. There are no power level adjustments and the antenna is permanently attached. The detailed calculations for RF Exposure are presented in a separate document.

### 3.0 EQUIPMENT UNDER TEST (EUT) DETAILS

#### 3.1 EUT Description

The EUT is a Wave ID Dual Frequency RFID Reader, Model RDF-30041AKU, manufactured by RF IDEas, Inc. The EUT was in good working condition during the tests, with no known defects.



### 3.1.1 FCC Section 15.203 & RSS-GEN Antenna Requirements

The products will not be sold to the general public. RF IDEas or the OEM will be responsible to ensure the proper installation in accordance with RF IDEas requirements.

These two antennas have a unique interface connector to ensure no other OEM antennas can be used. The antenna is internal to the EUT and it is not readily available to be modified by the end user.

### 3.1.2 Product Family

The following table is the product family list of the readers that use the same electronics and PCB as the ones tested in this report. The only changes are in firmware that would not affect the EMC characteristics of the readers.

The Main PCBA listed on the table below was fully tested and the results of which are featured in herein. The other untested model numbers listed below are electrically identical with the same electromagnetic emissions and electromagnetic compatibility characteristics as those tested, therefore the tests on the model numbers below are representative for the tested models.

Model Number	Description
RDF-30042AKU	WAVE ID Keystroke w/iCLASS SE & SEOS and Fingerprint Black USB Reader
RDF-30042AKU-IMP	WAVE ID SDK w/iCLASS SE & SEOS and Fingerprint Black USB Reader
RDF-30541AKU	WAVE ID SDK w/iCLASS SE & SEOS and Fingerprint Imprivata Black USB Reader
RDF-30542AKU	WAVE ID Keystroke Badge & Biometrics Combo Black USB Reader
RDF-30542AKU-IMP	WAVE ID SDK Badge & Biometrics Combo Black USB Reader

All these mentioned model numbers use the same frequency determining circuitry and use a USB interface. The 125 kHz and 13.56 MHz transmitter circuits are identical on all models.

### 3.2 Related Submittals

RF IDEas, Inc. is not submitting any other products simultaneously for equipment authorization related to the EUT.

## 4.0 TESTED SYSTEM DETAILS

### 4.1 Tested System Configuration

The system was configured for testing in a typical fashion. The EUT was placed on an 80-cm high, nonconductive test stand. The testing was performed in conditions as close as possible to installed conditions. Wiring was consistent with manufacturer's recommendations. Power was supplied at 115 VAC, 60 Hz single-phase to the host computer. The EUT was powered from the USB. The identification for all equipment, plus descriptions of all cables used in the tested system, are:

**Tested System Configuration List**

Item	Description	Type*	Manufacturer	Model Number	Serial Number
1	RFID Reader	E	RF IDEas	RDF-30041AKU	FP0I000012
2	Latitude Laptop PC	H	HP	Elite x2	5CG545482P
3	Laptop AC-DC power supply	P	HP	854055-002	None

\* Type: E = EUT, P = Peripheral, S = Support Equipment; H = Host Computer



List of Cables

QTY	Length (m)	Cable Description	Shielded?
1	1.8	USB Cable from Reader to Host computer	Yes
1	1.2	AC Cord to AC-DC power supply to host computer	No
1	1.5	DC Cord to Computer	No

4.2 Special Accessories

No special accessories were used during the tests in order to achieve compliance.

4.3 Equipment Modifications

No modifications were made at Radiometrics in order to meet the requirements listed in this report.

5.0 TEST SPECIFICATIONS

Document	Date	Title
FCC CFR Title 47	2020	Code of Federal Regulations Title 47, Chapter 1, Federal Communications Commission, Part 15 - Radio Frequency Devices
IC RSS-210 Issue 10	2019	Low Power Licence-Exempt Radiocommunication Devices (All Frequency Bands) Category I Equipment
IC RSS-Gen Issue 5	2019	General Requirements and Information for the Certification of Radiocommunication Equipment (RSS-Gen)

6.0 TEST PROCEDURE DOCUMENTS

The tests were performed using the procedures from the following specifications:

Document	Date	Title
ANSI C63.4-2014	2014	Methods of Measurement of Radio Noise Emissions from Low-Voltage Electrical and Electronic Equipment in the Range of 9 kHz to 40 GHz
ANSI C63.10-2013	2013	American National Standard for Testing Unlicensed Wireless Devices

7.0 RADIOMETRICS' TEST FACILITIES

The results of these tests were obtained at Radiometrics Midwest Corp. in Romeoville, Illinois, USA. Radiometrics is accredited by A2LA (American Association for Laboratory Accreditation) to conform to ISO/IEC 17025: 2017 "General Requirements for the Competence of Calibration and Testing Laboratories". Radiometrics' Lab Code is 121191 and Certification Number is 1495.01. Radiometrics' scope of accreditation includes all of the test methods listed herein. A copy of the accreditation can be accessed on our web site (www.radiomet.com). Radiometrics accreditation status can be verified at A2LA's web site (www.a2la2.org).

The following is a list of shielded enclosures located in Romeoville, Illinois used during the tests:

Chamber E: Is a custom-made anechoic chamber that measures 52' L X 30' W X 18' H. The walls and ceiling are fully lined with RF absorber. Pro-shield of Collinsville, Oklahoma manufactured the chamber.



Test Station F: Is an area that measures 10' D X 12' W X 10' H. The floor and back wall are metal shielded. This area is used for conducted emissions measurements.

A separate ten-foot long, brass plated, steel ground rod attached via a 6-inch copper braid grounds each of the above chambers. Each enclosure is also equipped with low-pass power line filters.

The FCC has accepted these sites as test site number US1065. The FCC test site Registration Number is 732175. Details of the site characteristics are on file with the Industry Canada as site number 3124A with a CAB ID US0224..

A complete list of the test equipment is provided herein. The calibration due dates are indicated on the equipment list. The equipment is calibrated in accordance to ANSI/NC SL Z540-1 with traceability to the National Institute of Standards and Technology (NIST).

### 8.0 DEVIATIONS AND EXCLUSIONS FROM THE TEST SPECIFICATIONS

There were no deviations or exclusions from the test specifications.

### 9.0 CERTIFICATION

Radiometrics Midwest Corporation certifies that the data contained herein was taken under conditions that meet or exceed the requirements of the test specification. The results relate only to the EUT listed herein. Any modifications made to the EUT subsequent to the indicated test date will invalidate the data and void this certification.

### 10.0 TEST EQUIPMENT TABLE

RMC ID	Manufacturer	Description	Model No.	Serial No.	Frequency Range	Cal Period	Cal Date
ANT-06	EMCO	Log-Periodic Ant.	3146	1248	200-1000MHz	24 Mo.	12/13/19
ANT-07	RMC	Log-Periodic Ant.	LP1000	1001	200-1000MHz	24 Mo.	11/19/18
ANT-53	EMCO	Loop Antenna	6507	1453	1 kHz-30 MHz	24 Mo	02/04/20
ANT-66	ETS-Lindgren	Horn Antenna	3115	62580	1.0-18GHz	24 Mo.	03/05/19
ANT-80	AH Systems	Bicon Antenna	SAS-540	294	20-330MHz	24 Mo.	12/19/18
CAB-106A	Teledyne	Coaxial Cable	N/A	1090	DC-2 GHz	24 Mo.	01/29/20
CAB-1090	Teledyne	Coaxial Cable	N/A	1090	DC-18 GHz	24 Mo.	02/06/20
CAB-160B	Teledyne	Coaxial Cable	N/A	1090	DC-18 GHz	24 Mo.	02/05/20
HPF-01	Solar	High Pass Filter	7930-100	HPF-1	0.15-30MHz	24 Mo.	03/02/20
LSN-01	Electrometrics	50 uH LISN	FCC/VDE 50/2	1001	0.01-30MHz	24 Mo.	08/12/19
REC-11	Agilent	Spectrum Analyzer	E7405A	US39110103	9kHz-3GHz	24 Mo.	04/16/20
REC-20	HP / Agilent	Spectrum Analyzer	85460A/84562A	33330A00135 3410A00178	30Hz-6GHz	24 Mo.	08/14/19
REC-43	Adventest	Spectrum Analyzer	U3772	150800305	9kHz-43GHz	24 Mo.	06/24/19

Note: All calibrated equipment is subject to periodic checks.

Software Company	Test Software Name	Version	Applicable Tests
Radiometrics	EN550XX0	07.16.19	RF Conducted Emissions (FCC Part 15 & EN 55032)
Radiometrics	REREC11D	07.16.19	RF Radiated Emissions (FCC Part 15 & EN 55032)
Agilent	PSA/ESA-E/L/EMC	2.4.0.42	Bandwidth and screen shots



## 11.0 TEST SECTIONS

### 11.1 AC Conducted Emissions

The tests and limits are in accordance with FCC section 15.207 and RSS Gen section 8.8.

A computer-controlled analyzer was used to perform the conducted emissions measurements. The frequency range was divided into 500 subranges equally spaced on a logarithmic scale. The computer recorded the peak of each subrange. This data was then plotted on a semi-log graph generated by the computer. Adjusting the positions of the cables and orientation of the test system then maximizes the highest emissions.

Mains Conducted emission measurements were performed using a 50 Ohm/50 uH Line Impedance Stabilization Network (LISN) as the pick-up device. Measurements were repeated on both leads within the power cord. If the EUT power cord exceeded 80 cm in length, the excess length of the power cord was made into a 30 to 40 cm bundle near the center of the cord. The LISN was placed on the floor at the base of the test platform and electrically bonded to the ground plane.

**FCC/IC Limits of Conducted Emissions at the AC Mains Ports**

Frequency Range (MHz)	Class B Limits (dBuV)	
	Quasi-Peak	Average
0.150 - 0.50*	66 - 56	56 - 46
0.5 – 5.0	56	46
5.0 - 30	60	50

\* The limit decreases linearly with the logarithm of the frequency in this range.

The initial step in collecting conducted data is a peak detector scan and the plotting of the measurement range. Significant peaks are then marked as shown on the following table, and these signals are then measured with the quasi-peak detector. The following represents the worst case emissions from the host computer (with the EUT connected) power cord, after testing all modes of operation. QP readings are quasi-peak with a 9 kHz bandwidth and no video filter.

Tested by	Richard Tichgelaar
Test Dates	07/13/2020

The 125 kHz and 13.56 MHz transmitter was on during the following tests.  
The Limit shown in the graphs are the FCC 15.107 and RSS-GEN Table 3.

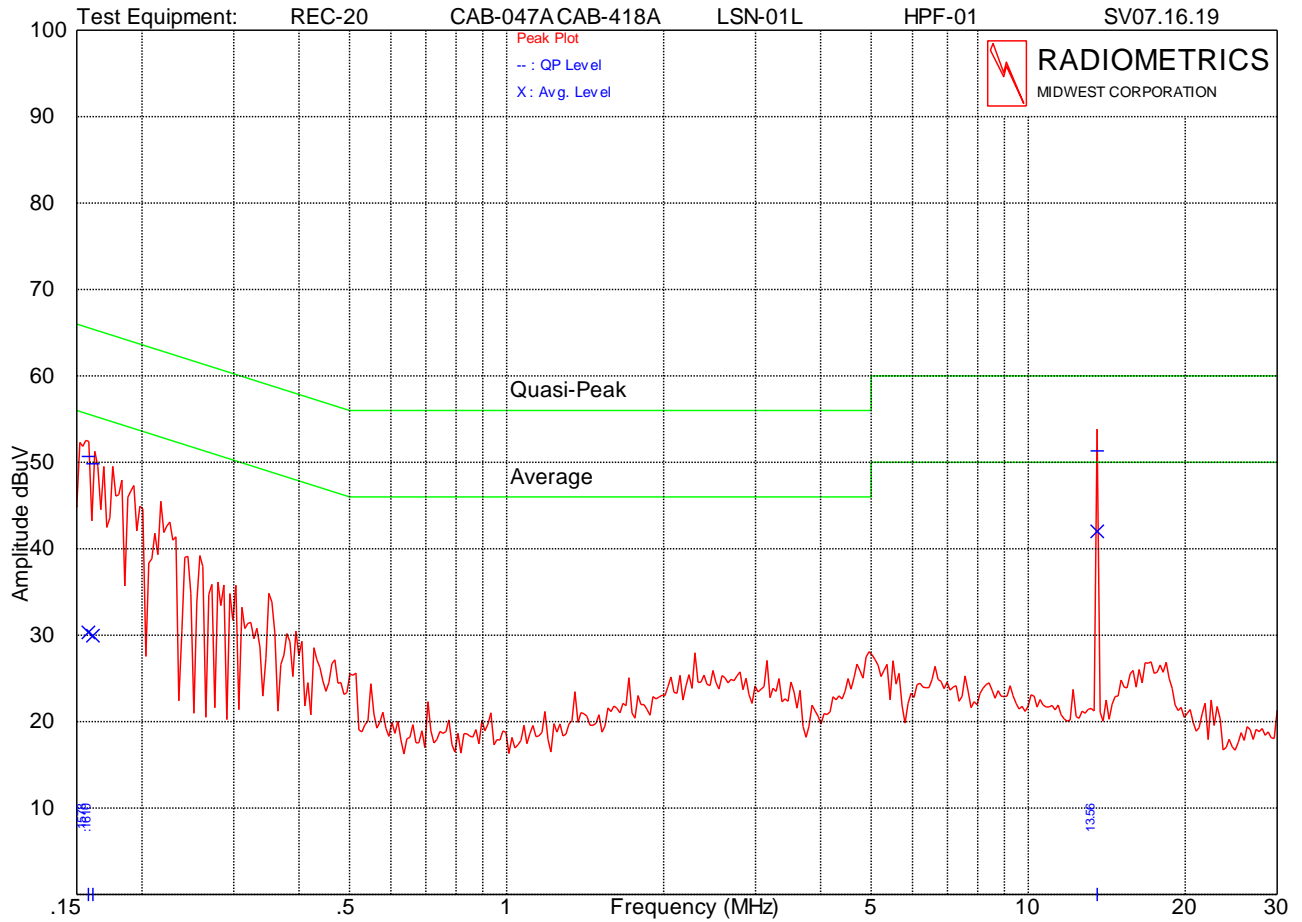

Company: RF IDEAS  
 Lead Tested: AC Hot 120 VAC  
 Notes: with HP X2 Laptop  
 FCC/ICES/EN; Class B Conducted Emissions; Mains Port

Model: RDF-30041AKU  
 S/N: FP0I000012

Date :07-13-2020  
 Time:11:36  
 Tested By: RLT  
 RP-9316 | CE120HA

Frequency (MHz)	QP Amp. (dBuV)	QP Limit (dBuV)	Average Amp. (dBuV)	Average Limit (dBuV)	Margin Under Limit (dB)
0.158	50.7	65.6	30.3	55.6	14.9
0.161	49.8	65.4	29.9	55.4	15.6
13.561	51.3	60.0	42.0	50.0	8.0



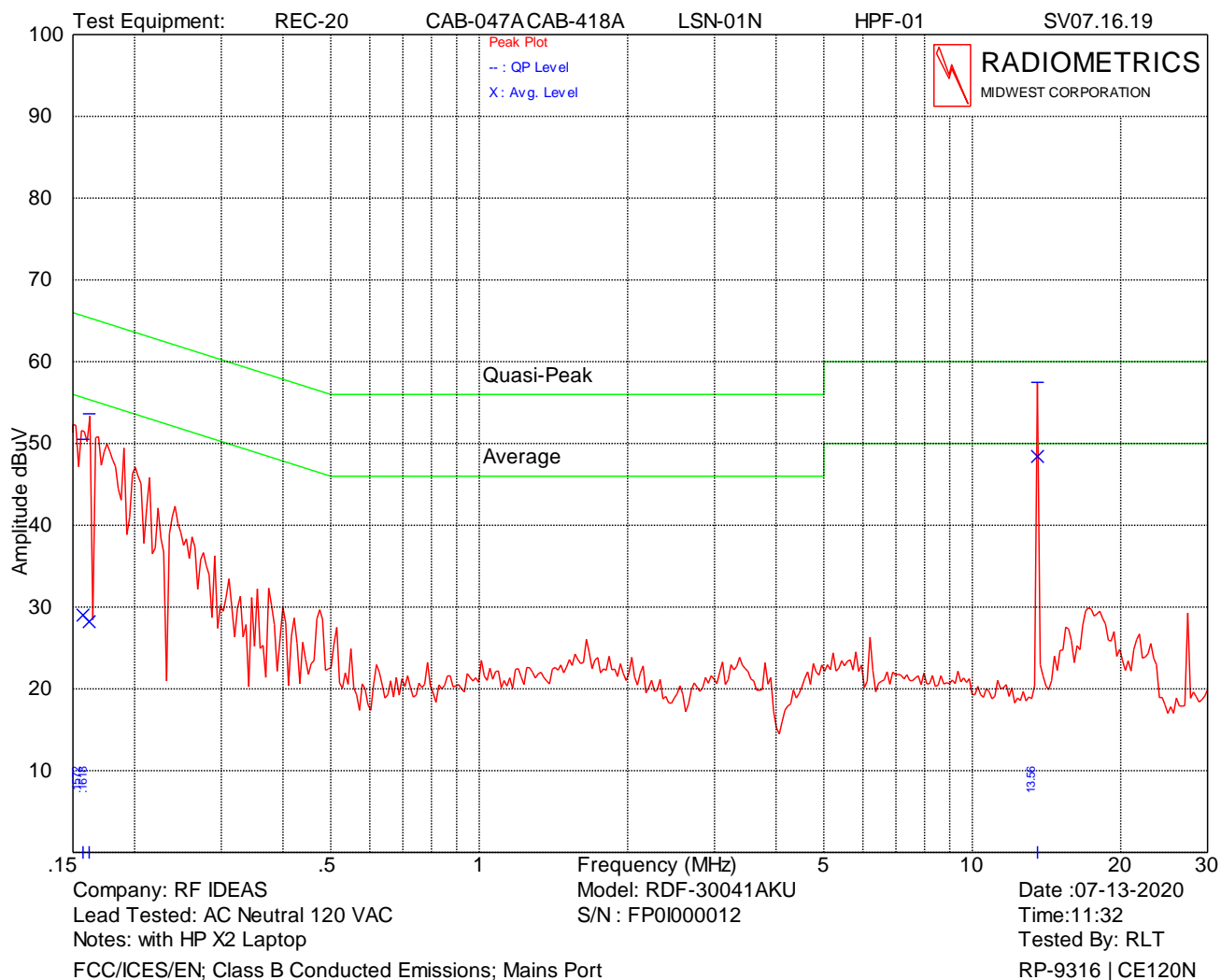

Frequency (MHz)	QP Amp. (dBuV)	QP Limit (dBuV)	Average Amp. (dBuV)	Average Limit (dBuV)	Margin Under Limit (dB)
0.157	50.5	65.6	29.0	55.6	15.1
0.162	53.6	65.4	28.2	55.4	11.7
13.560	57.5	60.0	48.4	50.0	1.6

Overall Conducted emissions Judgment: Passed by 1.6 dB



Figure 1. Conducted Emissions Test Setup

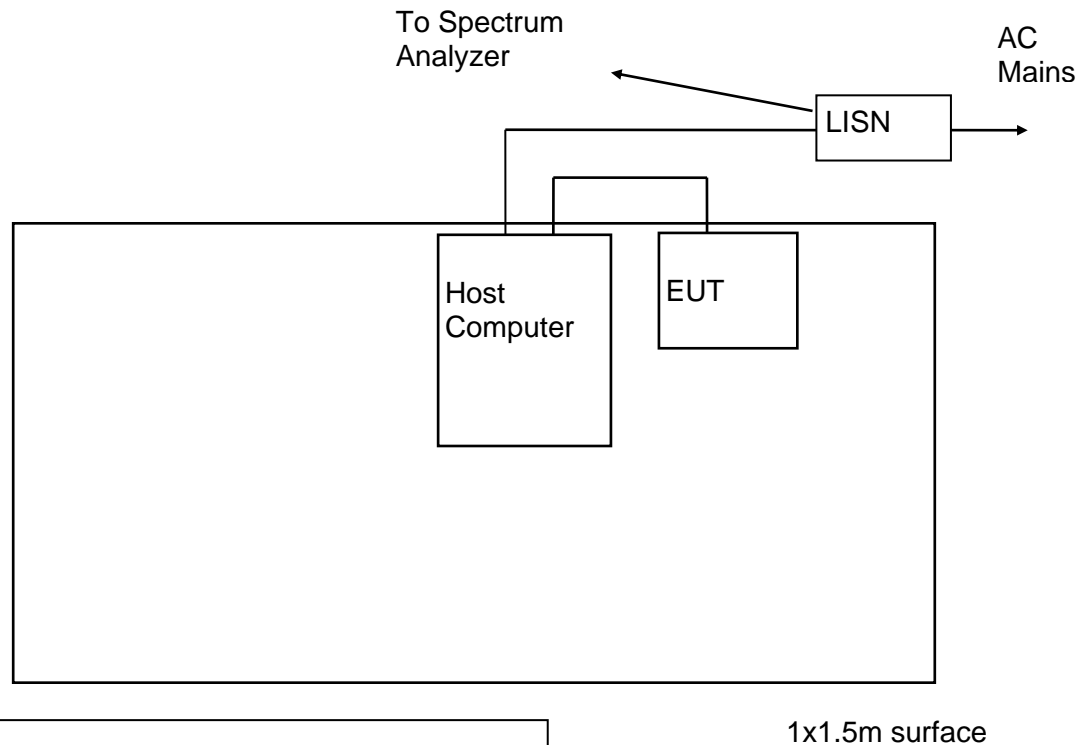

- Notes:
- LISN's at least 80 cm from EUT chassis
  - Vertical conductive plane 40 cm from rear of tabletop
  - EUT power cord bundled

## 11.2 Radiated RF Emissions

Radiated emission measurements were performed with linearly polarized broadband antennas. The results obtained with these antennas can be correlated with results obtained with a tuned dipole antenna. The radiated emission measurements were performed with a spectrum analyzer. The bandwidth used from 150 kHz to 30 MHz is 9 or 10 kHz and the bandwidth from 30 MHz to 1000 MHz is 100 or 120 kHz. Above 1 GHz, a 1 MHz bandwidth is used. A 10 dB linearity check is performed prior to start of testing in order to determine if an overload condition exists. Figure 4 herein lists the details of the test equipment used during radiated emissions tests.

Final radiated emissions measurements were performed inside of an anechoic chamber at a test distance of 3 meters. The anechoic chamber is designated as Chamber E. This Chamber meets the Site Attenuation requirements of ANSI C63.4 and CISPR 16-1. Chamber E is located at 12 Devonwood Ave. Romeoville, Illinois EMI test lab.

The entire frequency range from 30 to 1000 MHz was slowly scanned with particular attention paid to those frequency ranges which appeared high. Measurements were performed using two antenna polarizations, (vertical and horizontal). The worst case emissions were recorded. All measurements may be performed using either the peak, average or quasi-peak detector functions. If the peak detector data exceeds or is marginally close to the limits, the measurements are repeated using a quasi-peak detector or average function as required by the specification for final determination of compliance.



The detected emission levels were maximized by rotating the EUT, adjusting the positions of all cables, and by scanning the measurement antenna from 1 to 4 meters above the ground. The EUT was rotated through three orthogonal axes as per 5.10.1 of ANSI C63.10 during the radiated tests.

**Radiated Emissions Field Strength Limits**

Frequency Range (MHz)	Test Distance (meters)	Class B Limits	
		uV/m	dB(uV/m)
0.009-0.490	300	2400/F(kHz)	20*LOG(2400/kHz)
0.490-1.705	30	24000/F(kHz)	20*LOG(24000/kHz)
1.705-30.0	30	30	29.5
30 - 88	3	100	40.0
88 - 216	3	150	43.5
216 - 960	3	200	46.0
Above 960	3	500	54.0

The emission limits shown in the above table are based on measurements using a CISPR quasi-peak detector except for the frequency bands 9-90 kHz, 110-490 kHz and above 1000 MHz. Radiated emission limits in these three bands are based on measurements employing an average detector.

**11.2.1 Field Strength Calculation**

The field strength is calculated by adding the Antenna Factor and Cable Loss, and by subtracting the Amplifier Gain from the measured reading. The basic equation is as follows:

$$FS = RA + AF + CF - AG$$

Where: FS = Field Strength

RA = Receiver Amplitude in dBuV

AF = Antenna Factor in dB/m

CF = Cable Attenuation Factor in dB

AG = Amplifier Gain in dB

**11.2.2 Radiated Emissions Test Results**

Test Dates	07/13/2020
Test Distance	3 Meters
Specification	FCC Part 15 Subpart C & RSS-210
Notes	Corr. Factors = cable loss distance factor.
Abbreviations	P = peak; Q = QP Pol = Antenna Polarization; V = Vertical; H = Horizontal
Tested by	Richard Tichgelaar
Note	Host PC is HP model Elite X2

The 125 kHz and the 13.56 MHz transmitter were both on during the following tests.

The following shows the highest emissions during the tests.

EUT		RDF-30041AKU; S/N FP0I000012							
Freq. MHz	Meter Reading dBuV	Dect.	Ant. Pol.	Antenna Factor	Cable & Amp Factors	Distance Factor dB	EUT dBuV/m	Limit dBuV/m	Margin Under Limit dB
30.0	7.6	P	H	13.8	0.6	0.0	22.0	40.0	18.0
33.9	11.7	P	H	12.6	0.6	0.0	24.9	40.0	15.1
47.7	14.8	P	H	9.8	0.8	0.0	25.4	40.0	14.6
51.5	23.6	P	H	9.4	0.8	0.0	33.8	40.0	6.2
53.8	17.0	P	H	9.3	0.8	0.0	27.1	40.0	12.9
67.6	12.9	P	H	9.3	0.9	0.0	23.1	40.0	16.9



EUT		RDF-30041AKU; S/N FP0I000012							
Freq. MHz	Meter Reading dBuV	Decet.	Ant. Pol.	Antenna Factor	Cable & Amp Factors	Distance Factor dB	EUT dBuV/m	Limit dBuV/m	Margin Under Limit dB
95.2	15.8	P	H	10.0	1.0	0.0	26.8	43.5	16.7
111.8	13.9	P	H	11.0	1.1	0.0	26.0	43.5	17.5
120.1	12.9	P	H	11.6	1.2	0.0	25.7	43.5	17.8
135.5	15.0	P	H	12.4	1.3	0.0	28.7	43.5	14.8
143.8	15.2	P	H	12.6	1.3	0.0	29.1	43.5	14.4
149.3	20.3	P	H	12.8	1.3	0.0	34.4	43.5	9.1
162.6	18.7	P	H	12.9	1.4	0.0	33.0	43.5	10.5
233.9	16.6	P	H	15.1	1.6	0.0	33.3	46.0	12.7
247.1	17.2	P	H	15.3	1.7	0.0	34.2	46.0	11.8
249.5	16.5	P	H	11.8	1.7	0.0	30.0	46.0	16.0
264.0	19.2	P	H	12.2	1.7	0.0	33.1	46.0	12.9
270.9	23.1	P	H	12.4	1.8	0.0	37.3	46.0	8.7
279.1	19.0	P	H	13.0	1.8	0.0	33.8	46.0	12.2
298.6	18.3	P	H	14.0	1.9	0.0	34.2	46.0	11.8
325.7	22.3	P	H	14.0	1.9	0.0	38.2	46.0	7.8
352.8	21.9	P	H	14.3	2.0	0.0	38.2	46.0	7.8
379.9	23.8	P	H	14.7	2.1	0.0	40.6	46.0	5.4
384.3	18.6	P	H	14.8	2.1	0.0	35.5	46.0	10.5
392.5	16.5	P	H	15.2	2.1	0.0	33.8	46.0	12.2
407.0	17.4	P	H	15.4	2.2	0.0	35.0	46.0	11.0
434.1	16.3	P	H	16.0	2.3	0.0	34.6	46.0	11.4
461.2	16.0	P	H	16.8	2.3	0.0	35.1	46.0	10.9
488.3	15.3	P	H	17.3	2.4	0.0	35.0	46.0	11.0
500.0	9.1	P	H	17.9	2.4	0.0	29.4	46.0	16.6
502.5	13.7	P	H	18.1	2.4	0.0	34.2	46.0	11.8
516.3	12.0	P	H	18.8	2.5	0.0	33.3	46.0	12.7
523.8	13.0	P	H	18.0	2.5	0.0	33.5	46.0	12.5
530.0	12.3	P	H	17.7	2.5	0.0	32.5	46.0	13.5
581.3	17.0	P	H	18.5	2.6	0.0	38.1	46.0	7.9
706.3	11.3	P	H	21.1	2.9	0.0	35.3	46.0	10.7
732.5	11.9	P	H	20.9	3.0	0.0	35.8	46.0	10.2
747.5	11.7	P	H	20.9	3.0	0.0	35.6	46.0	10.4
760.0	12.7	P	H	21.1	3.0	0.0	36.8	46.0	9.2
868.8	9.3	P	H	22.6	3.2	0.0	35.1	46.0	10.9
1000.0	8.4	P	H	24.0	3.5	0.0	35.9	54.0	18.1
30.0	7.6	P	V	13.8	0.6	0.0	22.0	40.0	18.0
31.7	17.8	P	V	13.2	0.6	0.0	31.6	40.0	8.4
39.4	16.6	P	V	11.2	0.7	0.0	28.5	40.0	11.5
45.5	16.3	P	V	10.1	0.7	0.0	27.1	40.0	12.9
51.5	20.5	P	V	9.4	0.8	0.0	30.7	40.0	9.3
52.7	21.1	P	V	9.4	0.8	0.0	31.3	40.0	8.7
59.8	17.7	P	V	9.2	0.8	0.0	27.7	40.0	12.3
82.5	16.1	P	V	9.4	1.0	0.0	26.5	40.0	13.5
96.9	14.1	P	V	10.1	1.1	0.0	25.3	43.5	18.2
120.1	17.4	P	V	11.6	1.2	0.0	30.2	43.5	13.3
127.2	18.9	P	V	12.0	1.2	0.0	32.1	43.5	11.4
135.5	17.4	P	V	12.4	1.3	0.0	31.1	43.5	12.4
143.8	20.3	P	V	12.6	1.3	0.0	34.2	43.5	9.3
149.1	18.7	Q	V	12.8	1.3	0.0	32.8	43.5	10.7
151.0	17.1	P	V	12.8	1.3	0.0	31.2	43.5	12.3
162.7	18.1	Q	V	12.9	1.4	0.0	32.4	43.5	11.1
176.4	13.8	P	V	13.2	1.4	0.0	28.4	43.5	15.1



EUT		RDF-30041AKU; S/N FP0I000012							
Freq. MHz	Meter Reading dBuV	Decet.	Ant. Pol.	Antenna Factor	Cable & Amp Factors	Distance Factor dB	EUT dBuV/m	Limit dBuV/m	Margin Under Limit dB
199.1	11.6	P	V	14.3	1.5	0.0	27.4	43.5	16.1
211.8	11.0	P	V	14.7	1.6	0.0	27.3	43.5	16.2
234.4	14.0	P	V	15.1	1.6	0.0	30.7	46.0	15.3
245.5	15.4	P	V	15.2	1.7	0.0	32.3	46.0	13.7
249.5	10.1	P	V	11.8	1.7	0.0	23.6	46.0	22.4
270.9	16.0	P	V	12.4	1.8	0.0	30.2	46.0	15.8
298.6	18.2	P	V	14.0	1.9	0.0	34.1	46.0	11.9
325.7	22.8	P	V	14.0	1.9	0.0	38.7	46.0	7.3
335.8	15.3	P	V	14.2	2.0	0.0	31.5	46.0	14.5
352.8	20.0	P	V	14.3	2.0	0.0	36.3	46.0	9.7
379.9	17.0	P	V	14.7	2.1	0.0	33.8	46.0	12.2
407.0	19.4	P	V	15.4	2.2	0.0	37.0	46.0	9.0
434.1	17.1	P	V	16.0	2.3	0.0	35.4	46.0	10.6
500.2	9.7	P	V	17.9	2.4	0.0	30.0	46.0	16.0
502.5	10.2	P	V	18.1	2.4	0.0	30.7	46.0	15.3
583.8	11.1	P	V	18.5	2.6	0.0	32.2	46.0	13.8
795.0	8.2	P	V	20.9	3.1	0.0	32.2	46.0	13.8
941.3	9.0	P	V	23.1	3.4	0.0	35.5	46.0	10.5
1000.0	8.2	P	V	24.0	3.5	0.0	35.7	54.0	18.3

Judgment: Passed by 5.4 dB

Tabulated data from above represented graphically.

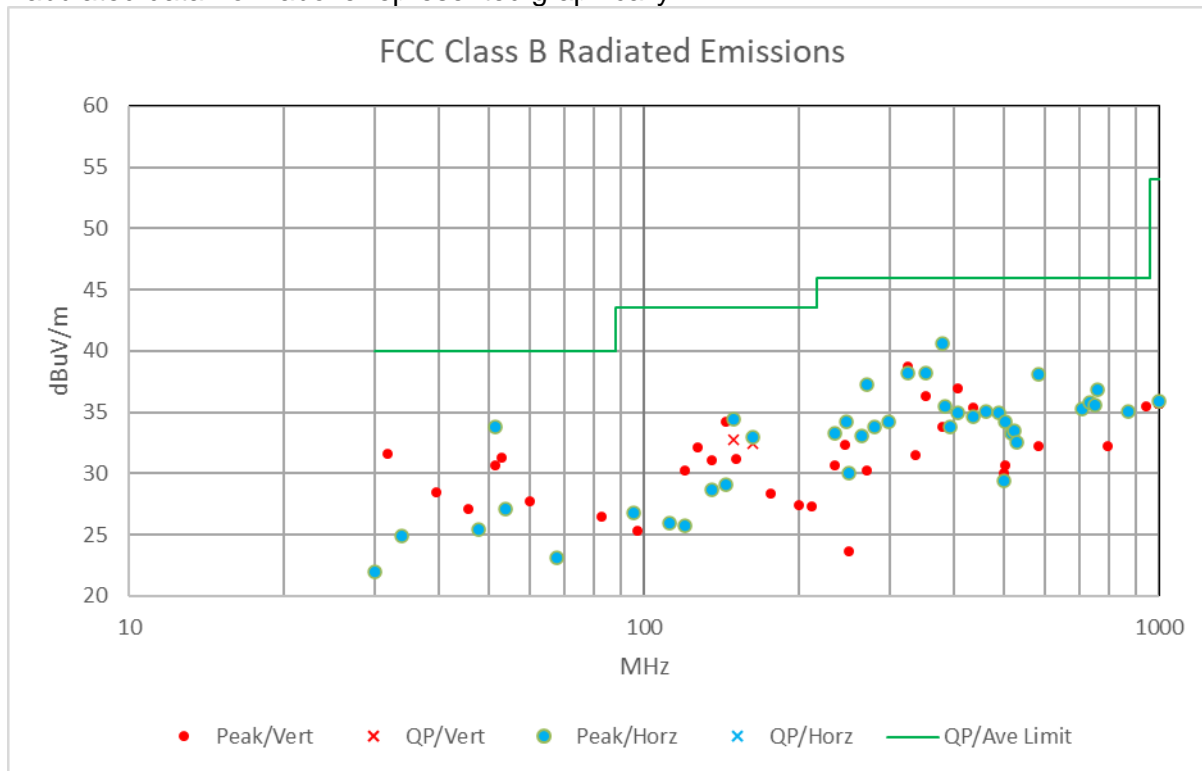
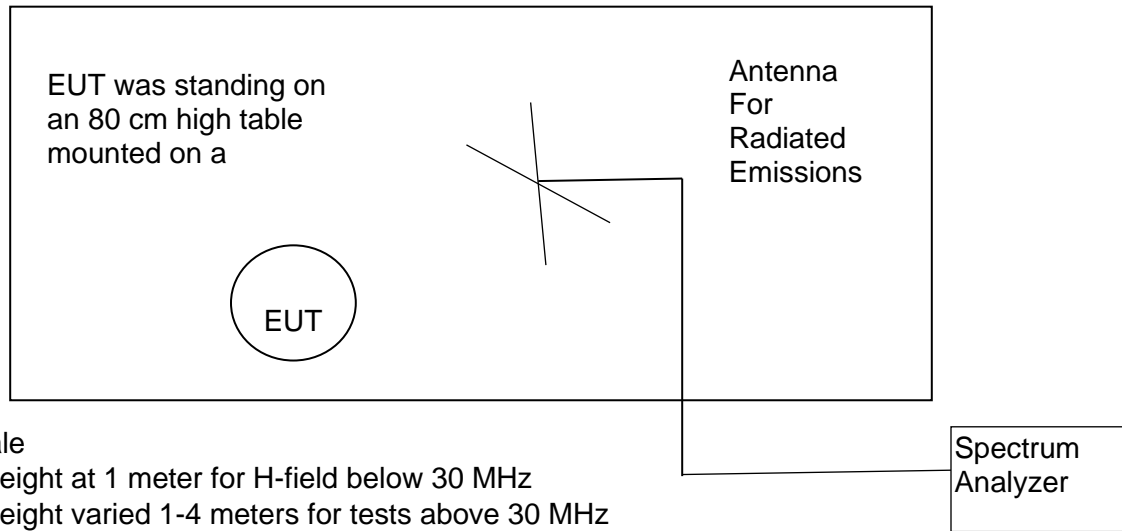



Figure 2. Drawing of Radiated Emissions Test Setup

Chamber E, anechoic



Notes:

- Not to Scale
- Antenna height at 1 meter for H-field below 30 MHz
- Antenna height varied 1-4 meters for tests above 30 MHz
- Distance from antenna to tested system is 3 meters
- AC cords not shown. They are connected to an AC outlet with low-pass filter on turntable

Frequency Range	Receive Antenna	Spectrum Analyzer
0.01 to 30 MHz	ANT-53	REC-11
30 to 200 MHz	ANT-80	REC-11
200 to 1000 MHz	ANT-68	REC-11

### 11.3 Magnetic Field Measurements and Decay Factor Calculations

Radiated emission measurements are performed with an EMCO shielded loop antenna. The antenna was rotated in order to find the maximize readings.

The distance correction factor is calculated as follows:

The distance factor in (dB) =  $DE \cdot 20 \cdot \log(TD/SD)$

Where: DE = Decay Exponent (2.0 is used for this)

TD = Test distance in meters. This is 3 meters

SD = Specification Distance in meters

From 9 kHz to 490 kHz, the Specification Distance is 300m therefore the distance factor is  $2 \cdot 20 \cdot \log(300/3) = 80$  dB.

From 490 kHz to 30 MHz, the Specification Distance is 30m therefore the distance factor is  $2 \cdot 20 \cdot \log(30/3) = 40$  dB.



### 11.3.1 Magnetic Field Radiated Emissions Results (0.009 to 30 MHz)

Test Date	07/13 & 7/22/2020
EUT	RDF-30041AKU; S/N FP0I000012
Test Distance	3 Meters
Specification	FCC 15 & RSS-GEN
Notes	A shielded Loop Antenna was used for this test.
Tested by	Chris D'Alessio; Richard Tichgelaar

Freq (kHz)	Peak reading dBuV	Loop Ant Factor dB/m	Test Dist. (m)	Decay exp	Cable Loss dB	FCC Distance factor dB	Field Strength dBuV/m	RSS & FCC Limit dBuV/m	Margin under limit	Test Date
125.0	63.0	19.1	3.0	2.0	0.1	-80.0	2.2	25.7	23.5	7/13/2020
250.0	56.2	18.9	3.0	2.0	0.1	-80.0	-4.8	19.6	24.4	7/13/2020
375.0	36.5	18.9	3.0	2.0	0.1	-80.0	-24.5	16.1	40.6	7/13/2020
13560	50.7	16.6	3.0	2.0	0.4	-40.0	27.7	29.5	1.8	7/22/2020
27120	13.5	15.9	3.0	2.0	0.5	-40.0	-10.1	29.5	39.6	7/22/2020

All limits are general limits of FCC 15.209 or the RSS-Gen.

The emissions were scanned from 10 kHz to 30 MHz. No other emissions were detected from 10 kHz to 30 MHz within 10 dB of the 15.209 or the RSS-GEN limits.

Judgement: Passed by 1.8 dB.



### 11.4 Occupied Bandwidth Data

The occupied bandwidth of the RF output was measured using a spectrum analyzer using a peak detector function and a narrow resolution bandwidth. A broadband antenna was used to receive the modulated signal. The spectrum analyzer was set to the MAX HOLD mode to record the worst case of the modulation. The spectrum analyzer display was digitized and plotted. The plots of the occupied bandwidth for the EUT are supplied on the following page.

Model	RDF-30041AKU S/N FP0I000012	Specification	FCC Part 15.225 RSS-210
Test Personnel	Richard Tichgelaar	Test Date	07/20/2020

99% OBW = 1.315 kHz

99% OBW = 2.045 kHz

Judgement: Pass

Figure 3. Occupied Bandwidth Plot

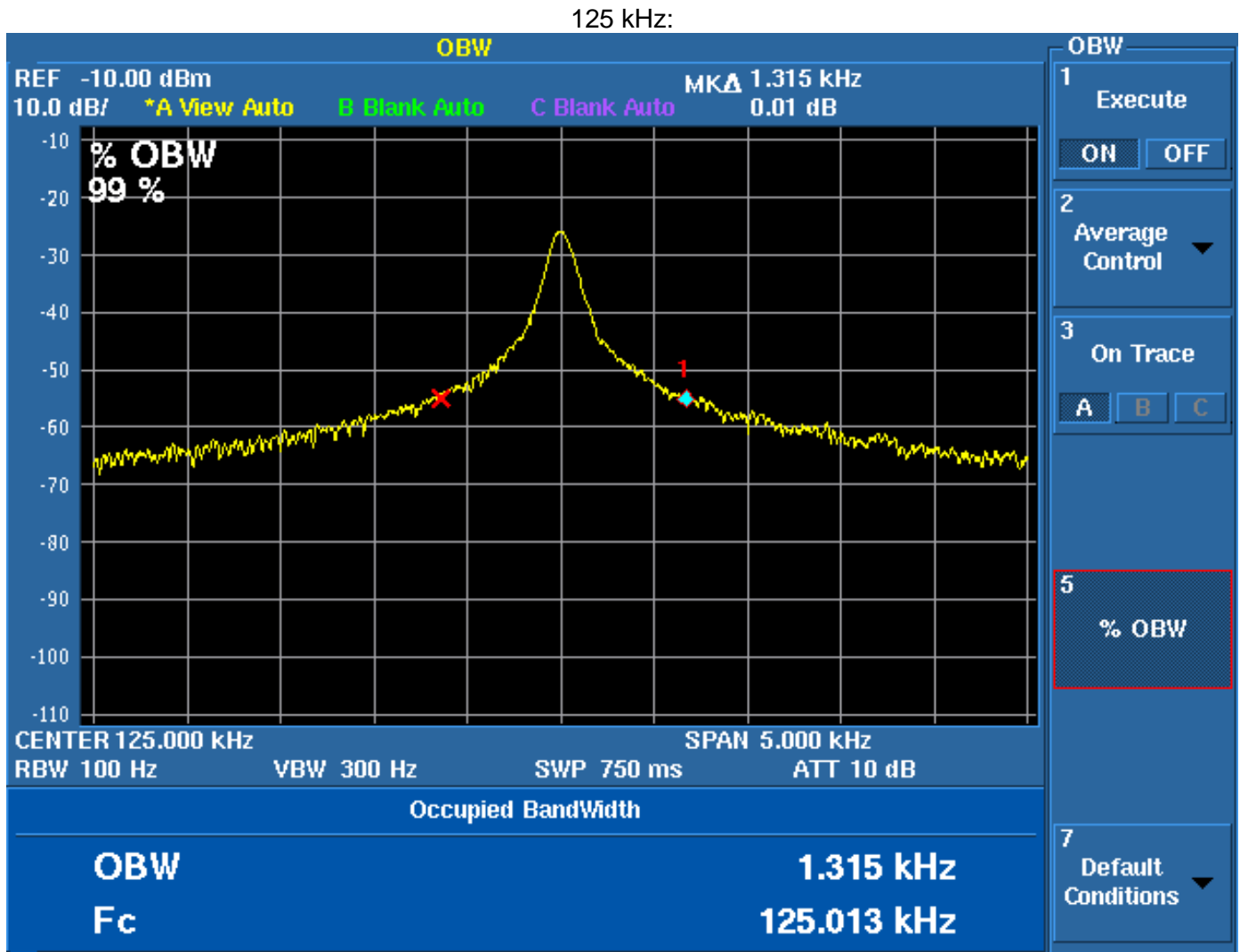





13.56 MHz:



Worst case OBW

### 12.0 MEASUREMENT INSTRUMENTATION UNCERTAINTY

The uncertainties represent expanded uncertainties expressed at approximately the 95% confidence level using a coverage factor of k=2 in accordance with CISPR 16-4-2.

Measurement	Uncertainty
Conducted Emissions, LISN method, 150 kHz to 30 MHz	2.7 dB
Radiated Emissions, H-field, 3 meters, 9 kHz to 30 MHz	2.7 dB
Radiated Emissions, E-field, 3 meters, 30 to 200 MHz	3.3 dB
Radiated Emissions, E-field, 3 meters, 200 to 1000 MHz	4.9 dB
Frequency counter with REC-11	136 Hz
99% Occupied Bandwidth using REC-43	1% of frequency span
Temperature THM-03	0.6 Deg C