

The top half of the cover features a red background. On the left is a solid red vertical bar. To its right is a white line-art illustration of a hand touching a 7-inch TFT LCD screen. The screen is tilted and shows a stylized fan-like graphic. The entire illustration is rendered in a light red color.

User Manual

TREK-743

**Vehicle Mounted Computer
with 7" TFT LCD**

Trusted ePlatform Services

ADVANTECH

Copyright

The documentation and the software included with this product are copyrighted 2008 by Advantech Co., Ltd. All rights are reserved. Advantech Co., Ltd. reserves the right to make improvements in the products described in this manual at any time without notice. No part of this manual may be reproduced, copied, translated or transmitted in any form or by any means without the prior written permission of Advantech Co., Ltd. Information provided in this manual is intended to be accurate and reliable. However, Advantech Co., Ltd. assumes no responsibility for its use, nor for any infringements of the rights of third parties, which may result from its use.

Acknowledgements

AMD and Geode are trademarks of Advanced Micro Devices Corporation.

Microsoft Windows and MS-DOS are registered trademarks of Microsoft Corp.

All other product names or trademarks are properties of their respective owners.

Product Warranty (2 years)

Advantech warrants to you, the original purchaser, that each of its products will be free from defects in materials and workmanship for two years from the date of purchase.

This warranty does not apply to any products which have been repaired or altered by persons other than repair personnel authorized by Advantech, or which have been subject to misuse, abuse, accident or improper installation. Advantech assumes no liability under the terms of this warranty as a consequence of such events.

Because of Advantech's high quality-control standards and rigorous testing, most of our customers never need to use our repair service. If an Advantech product is defective, it will be repaired or replaced at no charge during the warranty period. For out-of-warranty repairs, you will be billed according to the cost of replacement materials, service time and freight. Please consult your dealer for more details.

If you think you have a defective product, follow these steps:

1. Collect all the information about the problem encountered. (For example, CPU speed, Advantech products used, other hardware and software used, etc.) Note anything abnormal and list any onscreen messages you get when the problem occurs.
2. Call your dealer and describe the problem. Please have your manual, product, and any helpful information readily available.
3. If your product is diagnosed as defective, obtain an RMA (return merchandise authorization) number from your dealer. This allows us to process your return more quickly.
4. Carefully pack the defective product, a fully-completed Repair and Replacement Order Card and a photocopy proof of purchase date (such as your sales receipt) in a shippable container. A product returned without proof of the purchase date is not eligible for warranty service.
5. Write the RMA number visibly on the outside of the package and ship it prepaid to your dealer.

Part No. 2006074303

Printed in Taiwan

Edition 4

January 2009

Declaration of Conformity

This product has passed the CE test for environmental specifications. Test conditions for passing included the equipment being operated within an industrial enclosure. In order to protect the product from being damaged by ESD (Electrostatic Discharge) and EMI leakage, we strongly recommend the use of CE-compliant industrial enclosure products.

FCC Class B

Note: This equipment has been tested and found to comply with the limits for a Class B digital device, pursuant to part 15 of the FCC Rules. These limits are designed to provide reasonable protection against harmful interference in a residential installation. This equipment generates, uses and can radiate radio frequency energy and, if not installed and used in accordance with the instructions, may cause harmful interference to radio communications. However, there is no guarantee that interference will not occur in a particular installation. If this equipment does cause harmful interference to radio or television reception, which can be determined by turning the equipment off and on, the user is encouraged to try to correct the interference by one or more of the following measures:

- Reorient or relocate the receiving antenna.
- Increase the separation between the equipment and receiver.
- Connect the equipment into an outlet on a circuit different from that to which the receiver is connected.
- Consult the dealer or an experienced radio/TV technician for help.

FM

This equipment has passed the FM certification. According to the National Fire Protection Association, work sites are classified into different classes, divisions and groups, based on hazard considerations. This equipment is compliant with the specifications of Class I, Division 2, Groups A, B, C and D indoor hazards.

Technical Support and Assistance

1. Visit the Advantech web site at www.advantech.com/support for the latest information about the product.
2. Contact the distributor, sales representative, or Advantech's customer service center for technical support if you need additional assistance. Please have the following information ready before you call:
 - Product name and serial number
 - Description of your peripheral attachments

Technical Support and Assistance

1. Visit the Advantech web site at www.advantech.com/support for the latest information about the product.
2. Contact the distributor, sales representative, or Advantech's customer service center for technical support if you need additional assistance. Please have the following information ready before you call:
 - Product name and serial number
 - Description of your peripheral attachments
 - Description of your software (operating system, version, application software, etc.)
 - A complete description of the problem
 - The exact wording of any error messages

Warnings, Cautions and Notes

Warning! Warnings indicate conditions, which if not observed, can cause personal injury!



Caution! Cautions are included to help you avoid damaging hardware or losing data. e.g.



There is a danger of a new battery exploding if it is incorrectly installed. Do not attempt to recharge, force open, or heat the battery. Replace the battery only with the same or equivalent type recommended by the manufacturer. Discard used batteries according to the manufacturer's instructions.

Note! Notes provide optional additional information.



Document Feedback

To assist us in making improvements to this manual, we would welcome comments and constructive criticism. Send all such in writing to: support@advantech.com

Packing List

Before setting up, check that the items listed below are included, in good condition. If any item does not accord with the table, please contact your dealer immediately.

- TREK-743 series Vehicle Mounted Computer
- Accessories for TREK-743
- Warranty card
- Power cord: DC power inlet cable (180 cm - for TREK-743 only)
- "Drivers, Utilities and User Manual" CD-ROM
- End User License Agreement (XPE and WinCE model)

Safety Instructions

1. Read these safety instructions carefully.
2. Keep this User Manual for later reference.
3. Disconnect this equipment from any AC outlet before cleaning. Use a damp cloth. Do not use liquid or spray detergents for cleaning.
4. For plug-in equipment, the power outlet socket must be located near the equipment and must be easily accessible.
5. Keep this equipment away from humidity.
6. Put this equipment on a reliable surface during installation. Dropping it or letting it fall may cause damage.
7. The openings on the enclosure are for air convection. Protect the equipment from overheating. **DO NOT COVER THE OPENINGS.**
8. Make sure the voltage of the power source is correct before connecting the equipment to the power outlet.
9. Position the power cord so that people cannot step on it. Do not place anything over the power cord.
10. All cautions and warnings on the equipment should be noted.
11. If the equipment is not used for a long time, disconnect it from the power source to avoid damage by transient overvoltage.
12. Never pour any liquid into an opening. This may cause fire or electrical shock.
13. Never open the equipment. For safety reasons, the equipment should be opened only by qualified service personnel.
14. If one of the following situations arises, get the equipment checked by service personnel:
 15. The power cord or plug is damaged.
 16. Liquid has penetrated into the equipment.
 17. The equipment has been exposed to moisture.
 18. The equipment does not work well, or you cannot get it to work according to the user's manual.
 19. The equipment has been dropped and damaged.
 20. The equipment has obvious signs of breakage.
21. **DO NOT LEAVE THIS EQUIPMENT IN AN ENVIRONMENT WHERE THE STORAGE TEMPERATURE MAY GO BELOW -40° C OR ABOVE 60° C (140° F). THIS COULD DAMAGE THE EQUIPMENT. THE EQUIPMENT SHOULD BE IN A CONTROLLED ENVIRONMENT.**
22. **CAUTION: DANGER OF EXPLOSION IF BATTERY IS INCORRECTLY REPLACED. REPLACE ONLY WITH THE SAME OR EQUIVALENT TYPE RECOMMENDED BY THE MANUFACTURER, DISCARD USED BATTERIES ACCORDING TO THE MANUFACTURER'S INSTRUCTIONS.**
23. The sound pressure level at the operator's position according to IEC 704-1:1982 is no more than 70 dB (A).

DISCLAIMER: This set of instructions is given according to IEC 704-1. Advantech disclaims all responsibility for the accuracy of any statements contained herein.

Wichtige Sicherheitshinweise

1. Bitte lesen sie sich diese Hinweise sorgfältig durch.
2. Heben Sie diese Anleitung für den späteren Gebrauch auf.
3. Vor jedem Reinigen ist das Gerät vom Stromnetz zu trennen. Verwenden Sie keine Flüssig- oder Aerosolreiniger. Am besten dient ein angefeuchtetes Tuch zur Reinigung.
4. Die Netzanschlusssteckdose soll nahe dem Gerät angebracht und leicht zugänglich sein.
5. Das Gerät ist vor Feuchtigkeit zu schützen.
6. Bei der Aufstellung des Gerätes ist auf sicheren Stand zu achten. Ein Kippen oder Fallen könnte Verletzungen hervorrufen.
7. Die Belüftungsöffnungen dienen zur Luftzirkulation die das Gerät vor Überhitzung schützt. Sorgen Sie dafür, dass diese Öffnungen nicht abgedeckt werden.
8. Beachten Sie beim Anschluss an das Stromnetz die Anschlusswerte.
9. Verlegen Sie die Netzanschlussleitung so, dass niemand darüber fallen kann. Es sollte auch nichts auf der Leitung abgestellt werden.
10. Alle Hinweise und Warnungen die sich an den Geräten befinden sind zu beachten.
11. Wird das Gerät über einen längeren Zeitraum nicht benutzt, sollten Sie es vom Stromnetz trennen. Somit wird im Falle einer Überspannung eine Beschädigung vermieden.
12. Durch die Lüftungsöffnungen dürfen niemals Gegenstände oder Flüssigkeiten in das Gerät gelangen. Dies könnte einen Brand bzw. elektrischen Schlag auslösen.
13. Öffnen Sie niemals das Gerät. Das Gerät darf aus Gründen der elektrischen Sicherheit nur von autorisiertem Servicepersonal geöffnet werden.
14. Wenn folgende Situationen auftreten ist das Gerät vom Stromnetz zu trennen und von einer qualifizierten Servicestelle zu überprüfen:
 15. Netzkabel oder Netzstecker sind beschädigt.
 16. Flüssigkeit ist in das Gerät eingedrungen.
 17. Das Gerät war Feuchtigkeit ausgesetzt.
18. Wenn das Gerät nicht der Bedienungsanleitung entsprechend funktioniert oder Sie mit Hilfe dieser Anleitung keine Verbesserung erzielen.
19. Das Gerät ist gefallen und/oder das Gehäuse ist beschädigt.
20. Wenn das Gerät deutliche Anzeichen eines Defektes aufweist.
21. **VORSICHT:** Explosionsgefahr bei unsachgemäßen Austausch der Batterie. Ersatz nur durch denselben oder einem vom Hersteller empfohlene-mähnlichen Typ. Entsorgung gebrauchter Batterien nach Angaben des Herstellers.
22. **ACHTUNG:** Es besteht die Explosionsgefahr, falls die Batterie auf nicht fachmännische Weise gewechselt wird. Verfangen Sie die Batterie nur gleicher oder entsprechender Type, wie vom Hersteller empfohlen. Entsorgen Sie Batterien nach Anweisung des Herstellers.
23. Der arbeitsplatzbezogene Schalldruckpegel nach DIN 45 635 Teil 1000 beträgt 70dB(A) oder weniger.

Haftungsausschluss: Die Bedienungsanleitungen wurden entsprechend der IEC-704-1 erstellt. Advantech lehnt jegliche Verantwortung für die Richtigkeit der in diesem Zusammenhang getätigten Aussagen ab.

Safety Precaution - Static Electricity

Follow these simple precautions to protect yourself from harm and the products from damage.

- To avoid electrical shock, always disconnect the power from your PC chassis before you work on it. Don't touch any components on the CPU card or other cards while the PC is on.
- Disconnect power before making any configuration changes. The sudden rush of power as you connect a jumper or install a card may damage sensitive electronic components.

Warning! 1. *Input voltage rated: 9-36 Vdc.*



2. *Transport: carry the unit with both hands and handle with care.*

3. *Maintenance: to properly maintain and clean the surfaces, use only approved products or clean with a dry applicator.*

4. *CompactFlash: Turn off the power before inserting or removing CompactFlash storage cards.*

European Contact information:

Advantech Europe GmbH
Kolberger Straße 7
D-40599 Düsseldorf, Germany
Tel: 49-211-97477350
Fax: 49-211-97477300

FCC Part 15.21 information for user □

You are cautioned that changes or modifications not expressly approved by the party responsible for compliance could void your authority to operate the equipment. □

FCC RF Radiation Exposure Statement: □

1. This Transmitter must not be co-located or operating in conjunction with any other antenna or transmitter. □

2. This equipment complies with FCC RF radiation exposure limits set forth for an uncontrolled environment. This equipment should be installed and operated with a minimum distance of 20 centimeters between the radiator and your body. □

□

FCC Part 15.19

This device complies with Part 15 of the FCC Rules. Operation is subject to the following two conditions: (1) This device may not cause harmful interference, and (2) this device must accept any interference received, including interference that may cause undesired operation.

Contents

Chapter 1	General Information	1
1.1	Introduction	2
1.2	General Specifications	2
1.2.1	General	2
1.2.2	Standard PC Functions	3
1.2.3	PCI Bus Ethernet Interface	3
1.2.4	Touchscreen	3
1.2.5	Environment	4
1.3	LCD Specifications	4
	Table 1.1: LCD Specifications	4
1.4	Dimensions	4
	Figure 1.1 TREK-743 dimensions	4
Chapter 2	System Setup	5
2.1	A Quick Tour of the Vehicle Mounted	6
	Figure 2.1 Front view of the TREK-743	6
	Figure 2.2 Left side of the TREK-743	6
	Figure 2.3 Rear view of the TREK-743	7
	Figure 2.4 Vehicle mounted computer I/O	7
2.2	Installation Procedures	8
2.2.1	Connecting the Power Cord	8
	Table 2.1: Pin Definition of Power Cord	8
2.2.2	Connecting the Keyboard or Mouse	8
2.2.3	Switching on the Power	8
2.3	Running the BIOS Setup Program	9
2.4	Installing System Software	9
2.5	Installing the Drivers	10
2.6	Programming Function Keys and GPIO/CAN BUS	10
Chapter 3	Hardware & Peripheral Installation ..	11
3.1	Overview of Hardware Installation & Upgrading	12
3.2	Installing the Storage Device and Memory	12
3.3	Installing Optional Accessories	12
3.3.1	Installing Ram-mount Kits	12
	Figure 3.1 RAM mount kits	12
3.3.2	Installing the MiniPCI Wireless LAN Module	13
	Figure 3.2 MiniPCI Wireless LAN module	13
3.3.3	Installing the GPS Modules	14
	Figure 3.3 GPS module	14
3.4	Fuse	17
3.4.1	Fuse Specifications	17
3.4.2	Fuse Installation and Replacement	17
	Figure 3.7 Installing the fuse	17
Chapter 4	Jumper Settings and Connectors	19

4.1	Setting Jumpers and Switches.....	20
4.1.1	Locating Jumpers and Switches	20
	Table 4.1: Jumpers & LEDES on the Motherboard	20
4.1.2	Locating Jumpers and LEDs on the Motherboard	21
	Figure 4.1 Locating Jumpers / LEDs	21
4.1.3	Connectors on the Motherboard	22
	Table 4.2: Connectors on the Motherboard.....	22
4.1.4	Locating Connectors on the Motherboard	23
	Figure 4.2 Locating Connectors on the front side.....	23
	Figure 4.3 Locating Connectors on the back side	23
4.2	CPU Installation	24
4.3	Jumper Settings	24
4.3.1	CMOS Clear for External RTC (JP1).....	24
	Table 4.3: Clear CMOS / External RTC (JP1).....	24
4.3.2	Power Feature Setting (JP3)	24
	Table 4.4: Ignition Input Switch Setting (JP3)	24
	Table 4.5: Power off / Hard off Delay Setting (JP3)	25
	Table 4.6: Low Battery Monitor (JP3).....	26
4.4	COM Port Interface	27
	Table 4.7: Serial Port Default Settings	27
4.4.1	COM Port Pin 9 Power Output Setting (CN27).....	28
	Table 4.8: COM Port Pin 9 Power Output Setting (CN27)	28
4.4.2	COM Port Pin 9 Power Output Value Setting (JP2).....	28
	Table 4.9: COM Port Pin 9 Power Output Value Setting (JP2) .	28
Chapter 5	AMD Chipset.....	29
5.1	Introduction	30
5.2	Further Information	30
Chapter 6	Graphic Chipset	31
6.1	Introduction	32
	Figure 6.1 Display properties.....	32
	Figure 6.2 Adapter menu.....	33
	Figure 6.3 LCD resolution selection	33
6.2	Further Information	33
Chapter 7	Audio.....	35
7.1	Introduction	36
7.1.1	Installation of Audio Driver.....	36
Chapter 8	LAN.....	37
8.1	Introduction	38
8.2	Installation of LAN Driver	38
Chapter 9	Touchscreen.....	39
9.1	Introduction	40
9.1.1	General Information	40
9.1.2	General Specifications.....	40
9.2	Installation of Touchscreen Driver	40
9.3	Further Information	40

Appendix A	Pin Assignments	43
A.1	Internal Speaker Connector (CN2 on PCM-028)	44
	Table A.1: Internal Speaker Connector (CN2 on PCM-028).....	44
A.2	COM1, 2 (CN17,19)	44
	Table A.2: COM1, 2 (CN17,19).....	44
A.3	GPIO / CAN BUS Connector (CN31)	45
	Table A.3: GPIO / CAN BUS Connector (CN31)	45
A.4	Inverter / Touch / USB Connector (CN18)	46
	Table A.4: Inverter / Touch / USB Connector (CN18).....	46
A.5	Power Inlet	47
	Table A.5: Power inlet.....	47
Appendix B	Software API	50
B.1	Software API	50
Appendix C	BIOS Settings.....	52
C.1	Power Fail Function Setting in BIOS.....	52
	Figure D.1 Main Menu: Power Management Setup	52
	Figure D.2 Power Fail Function.....	52
C.2	Feature of PC Health Status	52

Chapter 1

General Information

This chapter gives background information on the TREK-743 Vehicle Mounted Computer.

Sections include:

- Introduction
- General Specifications
- LCD Specifications
- Dimensions

1.1 Introduction

TREK-743 is a fanless and compact vehicle mounted computer designed for a wide range of commercial vehicle applications: delivery, fleet management and warehousing/logistics.

The ruggedized aluminum enclosure without ventilation holes makes the TREK-743 waterproof and dust proof. The wide range power input suits vehicles such as forklifts and trucks, which typically operate with 12 V, 24 VDC power. TREK-743 provides options for real-time communication and data capture in vehicle to improve overall productivity.

1.2 General Specifications

1.2.1 General

- **Dimensions:** (W x H x D): 255 x 160 x 50 mm.
- **Weight:** 1.7 kg.
- **Power supply:**
 - **Input voltage:** 9 ~ 36Vdc, support ignition cold crank (min 6Vdc).
 - **Ignition on/off**
 - **Low battery shut-down protection threshold (optional):** When the vehicle battery voltage level drops below 11V for more than 30 seconds, TREK-743 will automatically shut down in order to prevent “deep discharge” situations and TREK-743 can be re-activated only when the voltage is > 11V.
 - **Power on delay:** Default 2 seconds. When the TREK-743 is powered on via ignition key, the system will delay 2 seconds to power on.
 - **Power off delay:** Default 5 seconds. When TREK-743 power is controlled by ignition key and turns off by the key (ignition=off), the TREK-743 will start the shut procedure after 5 seconds.
 - **Hard off delay:** Default 30 seconds. When TREK-743 power is controlled by ignition key and turns off by the key (ignition=off), the TREK-743 will cut off the 5VSB power after 30 seconds. In this event when the shutdown process is longer then 30 seconds, the power will be shut down hard, turning off the TREK-743's power and 5VSB.

Note! For more detail of function please refer to Chapter 4, Section 4.3.2 of this manual.



- **Power consumption:** The maximum current consumption is about 32.4 watts. The power consumption is 12 watts in normal mode (with only XPE running; no I/O device and modules connected to the TREK-743).
- **Front panel and back cover:** IP65 Sealed; NEMA4 compliant (Not including the I/O ports).
- **Enclosure:** Ruggedized aluminum without ventilation holes.

1.2.2 Standard PC Functions

- **CPU:** AMD LX800 500MHz.
- **Chipset:** Integrated in AMD CS5536AD South Bridge.
- **BIOS:** Award 256 KB Flash BIOS, ACPI 2.0 Compliant.
- **System chipset:** AMD CS5536AD.
- **System memory:** One 200-pin SODIMM sockets, accepts up to 1 GB DDR266/333 SDRAM. (Win CE image supports up to 512 MB SDRAM)
- **Solid state disk:** Supports one 50-pin socket for Compact-Flash type I/II (True IDE mode).
- **Serial ports:** Two RS-232/422/485 serial ports. All ports are compatible with 16C550. UARTs, +5V power supply selectable.
- **Universal serial bus (USB) port:** Supports up to three EHCI USB2.0.
- **Mini PCI bus expansion slot:** Accepts one type III A/B mini PCI bus card.
- **Watchdog timer:** 63-level timer intervals automatically generate system reset when the system stops due to a program error or EMI. Jumperless selection and software enabled/disabled.
- **RTC Battery:** 3.0 V @ 195 mA lithium battery.
- **Power management:** Supports power saving modes including Normal/Standby/Suspend modes. APM 1.2 compliant.
- **Digital I/O:** Optically isolated 4 digital input and 4 digital output
- **CAN bus:**
 - Built in CAN/RS-232 converter
 - Max transmission speed up to 1 Mbps for CAN and 57600 bps for RS-232 interface
 - Supports both CAN 2.0A and CAN 2.0B
 - Provides a group of RS-232 devices a method to be the network system (Full-duplex communication mode of RS-232 devices is not supported)
- **Audio controller:** ACL650 AC97 Ver. 2.0 compliant interface, Multi stream Direct sound and Direct Sound 3D acceleration.
- **Stereo sound:** 18-bit full-duplex codec.
- **Audio interface:** One 1.5W speaker, one microphone.
- **Optional modules:** 12 channels GPS, quad-band GSM/GPRS, MiniPCI WLAN card.

1.2.3 PCI Bus Ethernet Interface

- **Chipset:** Realtek RTL8100CL PCI local bus Ethernet controller.
- **Ethernet interface:** Full compliance with IEEE 802.3u 100Base-T and 10 Base-T specifications. Includes software drivers and boot ROM that supports both RPL and PXE.
- **100/10Base-T** auto-sensing capability.

1.2.4 Touchscreen

- **Type:** Analog Resistive
- **Light transmission:** 80%
- **Controller:** RS-232 interface
- **Power consumption:** <5.5 V@ 20 mA
- **Durability:** > 10 million depressions
- **Software driver:** Supports Windows XP/XP Embedded, WinCE

1.2.5 Environment

- **Operating temperature:** -20 ~ 60° C (-4 ~ 140° F)
- **Relative humidity:** 10 ~ 95% @ 40° C (non-condensing)
- **Shock:** 30 G peak acceleration (11 msec duration)
- **Certifications:** EMC: CE, FCC, CCC Safety: UL, CUL, CE; CCC, CB.
- **Vibration:** 5 ~ 500 Hz 4.5G RMS random vibration

1.3 LCD Specifications

Table 1.1: LCD Specifications

Definition	Detail
Display type:	7" TFT LCD
Max. resolution:	800 x 480
Colors:	262K
Dot size (mm)	0.0635 x 0.1905
Luminance:	400 cd/m ²
Viewing Angle (Horizon/Vertical):	100° / 120°

- Note!**
1. The Brightness control is defined by Function key on the front panel.
 2. The color LCD display installed in the Vehicle Mounted Computer is high-quality and reliable. However, it may contain a few defective pixels which do not always illuminate. With current technology, it is impossible to completely eliminate defective pixels. Advantech is actively working to improve this technology.



1.4 Dimensions

All dimensions are in millimeters.

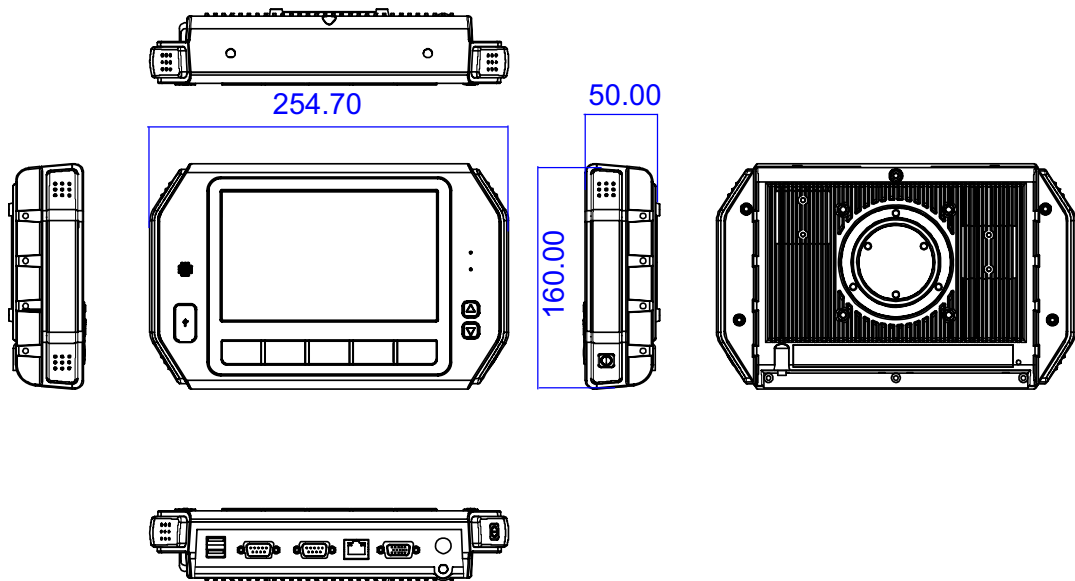

Figure 1.1 TREK-743 dimensions

Chapter 2

System Setup

This chapter details system setup on TREK-743.

Sections include:

- A Quick Tour of the Vehicle Mounted Computer
- Installation Procedures
- Running the BIOS Setup Program

2.1 A Quick Tour of the Vehicle Mounted

Before starting to set up the Vehicle Mounted Computer, take a moment to become familiar with the locations and purposes of the controls, drives, connectors and ports, which are illustrated in the figures below. When the Vehicle Mounted Computer is placed upright on the desktop, its front panel appears as shown in Figure 2.1. Look for the brightness control key, microphone and power LED indicator on the right, five illuminated programmable function keys on the bottom, and one USB connector with water/dust-proof cover and a speaker on the left.

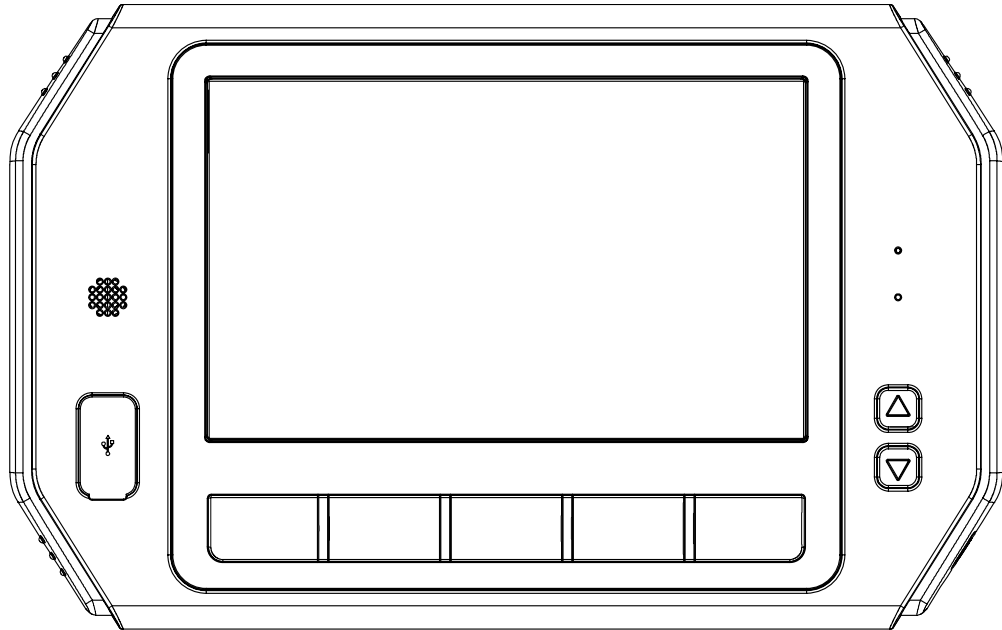

Figure 2.1 Front view of the TREK-743

Facing the left side of the Vehicle Mounted Computer, the power button is visible on the lower side, as shown in Figure 2.2.

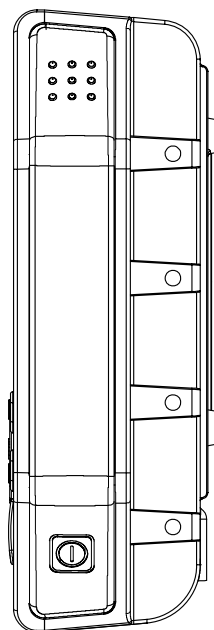

Figure 2.2 Left side of the TREK-743

The Vehicle Mounted Computer rear cover is fitted with several standard VESA mounting holes, (75 x 75mm) and other extra holes for mounting. The unit is completely sealed, and there are no ventilation holes on the back cover, as shown in Figure 2.3.

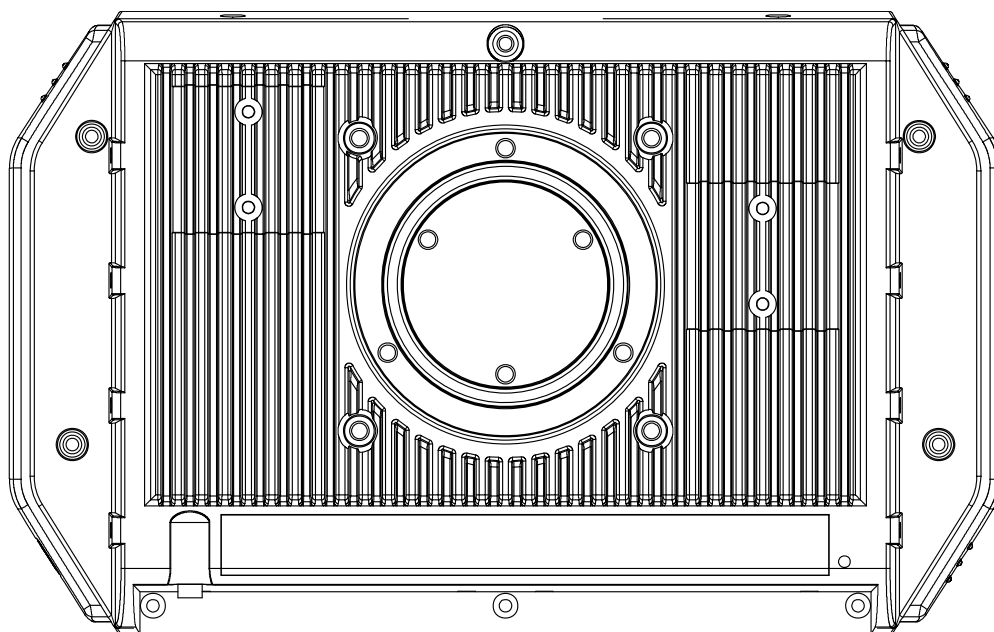
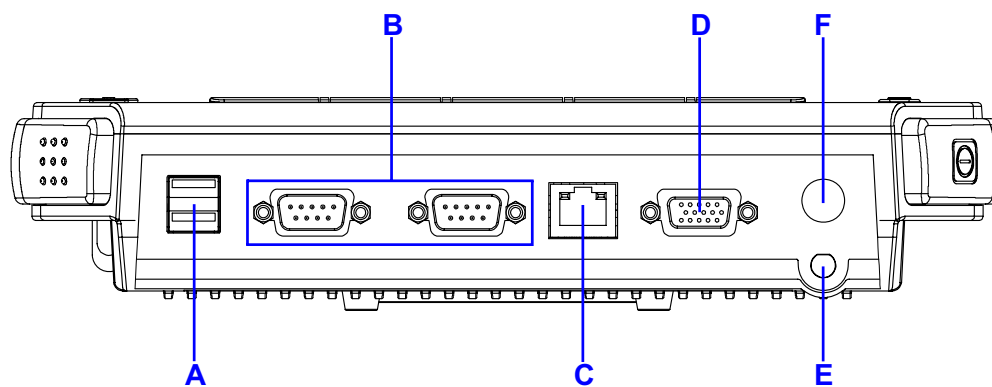

Figure 2.3 Rear view of the TREK-743

The I/O section is located on the bottom of the Vehicle Mounted Computer, as shown in Figure 2.4



- | | |
|-------------------------------|-------------------------------------|
| A: 2 x USB 2.0 | D: CAN BUS & 4 DI/DO |
| B: 2 x COM (RS232/422/485) | E: GPS antenna connector (reserved) |
| C: One 10/100 Base-T ethernet | F: DC power inlet |

Figure 2.4 Vehicle mounted computer I/O

2.2 Installation Procedures

2.2.1 Connecting the Power Cord

Connect the three pin waterproof power cord to the DC inlet of the Vehicle Mounted Computer. On the open-wire end, one pin is reserved for positive voltage and is marked, "+"; one pin is reserved for ground and is marked, "-"; and, one pin is reserved for the ignition signal with an "ignition" mark.

Note!  Power on/off the TREK-743 via the TREK-743's power switch. Please connect its "+" and "ignition" pins together with the power source's "+". Or change the JP3 jumper setting. (For JP3 jumper setting please see section 4.3.2.1)

Note!  Ignition on/off setting : The TREK-743 supports an ignition on/off function so that you can power on/off the TREK-743 via the ignition signal/voltage. Either connect the TREK-743's "ignition" pin to vehicle ignition and the TREK-743 "+" to "+-"; or connect the TREK-743's "ignition & +" pins together with power source's "+", and "-" to "-". Please also set the "power on after power failure" function to "always on" in BIOS.(for BIOS settings, please see Appendix D). The delay on/off will be active once the ignition on/off is selected.

Table 2.1: Pin Definition of Power Cord

Pin	Definition	Color
1	+	yellow
3	-	black
4	Ignition	white

2.2.2 Connecting the Keyboard or Mouse

Before starting the computer, it is required to connect the mouse or keyboard to the USB ports.

2.2.3 Switching on the Power

The power switch is located on the bottom of the computer.

2.3 Running the BIOS Setup Program

In most cases, the computer will have been properly set up and configured by the dealer or SI prior to delivery. However, it may still be necessary to adjust some of the computer's BIOS (Basic Input-Output System) setup programs to change the system configuration data, like the current date and time, or the specific type of hard drive currently installed.

The setup program is stored in read-only memory (ROM). It can be accessed either when turning on or resetting the computer, by pressing the "Del" key on the keyboard immediately after powering up the computer.

The settings that are specified with the setup program are recorded in a special area of the memory called CMOS RAM. This memory is backed up by a battery so that it will not be erased when turning off or resetting the system. Whenever the power is turned on, the system reads the settings stored in CMOS RAM and compares them to the equipment check conducted during the "power on self-test" (POST). If an error occurs, an error message is displayed on screen, and the user is prompted to run the setup program.

2.4 Installing System Software

Recent releases of operating systems from major vendors include setup programs which load automatically and guide users through the entire process of operating system installation. The guidelines below help to determine the steps necessary to install your operating system on the computer hard drive.

Note! *Some distributors and system integrators may have already pre-installed system software prior to shipment of your Vehicle Mounted Computer.*



The BIOS of the computer supports system boots-up directly from the CD-ROM drive whenever it is connected using a USB interface. Insert the system installation CD-ROM into the CD-ROM drive.

Power on the computer, or reset the system by pressing the "Ctrl" + "Alt" + "Del" keys simultaneously. The computer will automatically load the operating system from the diskette or CD-ROM.

When presented with the opening screen of a setup / installation program, simply follow the onscreen instructions. The setup program guides users through preparations of the hard drive, and installation of the operating system.

When presented with an operating system command prompt, like, A:\>, then it is necessary to partition and format the hard drive, and manually copy the operating system files to it. Refer to the operating system user instructions about partitioning and formatting the hard drive.

2.5 Installing the Drivers

After installing system software, the computer is ready to set up the AMD chipset, VGA, audio, LAN, and touch screen functions. All the pre-requisite drivers are stored on a CD-ROM disc entitled “Drivers and Utilities” (Check the correct wording on the CD, which can be found in the accessory box.)

The utility directory includes multimedia programs. Some drivers and utilities in the CD-ROM disc have their own text files which help users install the drivers and understand their functions.

These files are a very useful supplement to the information in this manual. For more details of driver installation please refer to Chapter 5 to 10 of this manual.

Note! *The drivers and utilities used for the TREK-743 are subject to change without notice. If in doubt, check Advantech's website or contact our application engineers for the latest information regarding drivers and utilities.*



2.6 Programming Function Keys and GPIO/CAN BUS

The Vehicle Mount Computer provides five function keys, GPIO and CAN bus as shown in section 2.1. These functions must be activated with the correct software, that's why we provide an AP library for customers to design their own software. Refer to Appendix C for more detail.

Chapter 3

Hardware & Peripheral Installation

This chapter details the installation of hardware for TREK-743.

Sections include:

- Overview of Hardware Installation and Upgrading
- Installing the Storage Device and Memory
- Installing Optional Accessories
- Fuse

3.1 Overview of Hardware Installation & Upgrading

The Vehicle Mounted Computer consists of a PC-based computer that is housed in a ruggedized aluminum enclosure. Any maintenance or hardware upgrades can be completed after removing both cover panels.

Warning!



Warning! Do not remove the ruggedized aluminum covers until verifying that no power is flowing within the computer. Power must be switched off and the power cord must be unplugged. Take care in order to avoid injury or damage to the equipment.

3.2 Installing the Storage Device and Memory

The Vehicle Mounted Computer can only use a CompactFlash Card (CFC) as a storage device. Put the CFC into the CF slot and insert the RAM into the 200-pin SODIMM socket on the main board.

3.3 Installing Optional Accessories

Optional accessories, like mounting kits or other functional modules are available for purchase to complement TREK-743. The following are instructions for accessory installation.

3.3.1 Installing Ram-mount Kits

Three different types of RAM-MOUNT kits are available to fit various applications; RAM-MOUNT-01 and RAM-MOUNT-02 support units weighing up to 4.5 kg (approximate 10 lbs); RAM-MOUNT-03 and RAM-MOUNT-05E mount supports units weighing up to 6.75 kg (approximate 15 lbs).

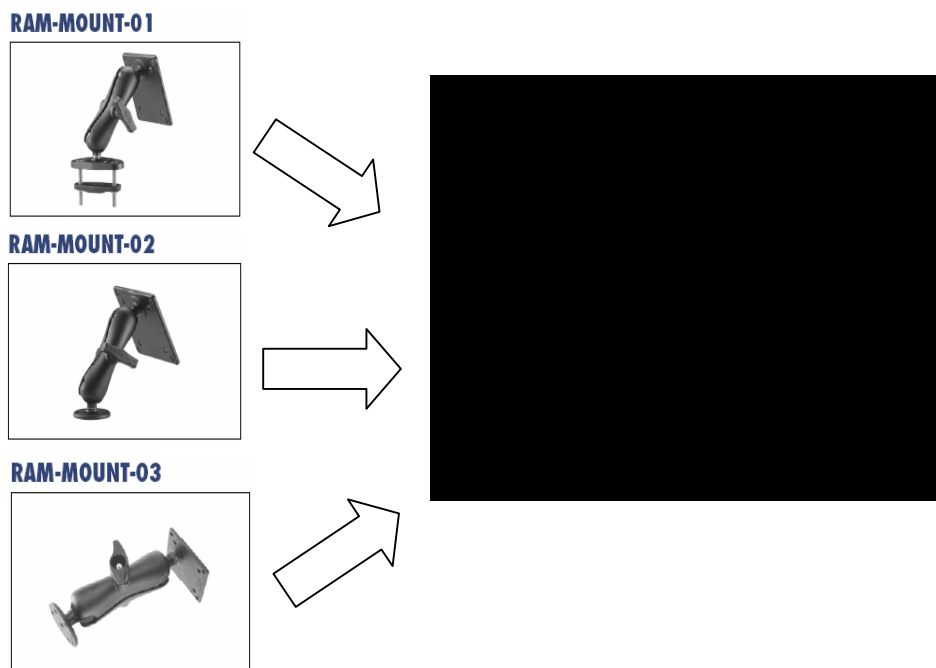

Figure 3.1 RAM mount kits

3.4 Fuse

3.4.1 Fuse Specifications

- **Rating:** 125 V AC, 5 A
- **Size:** 5 x 9.7 mm

3.4.2 Fuse Installation and Replacement

1. Remove the fuse cover.
2. Install the new fuse or replace the damaged fuse with a new one.
3. Replace the fuse cover.

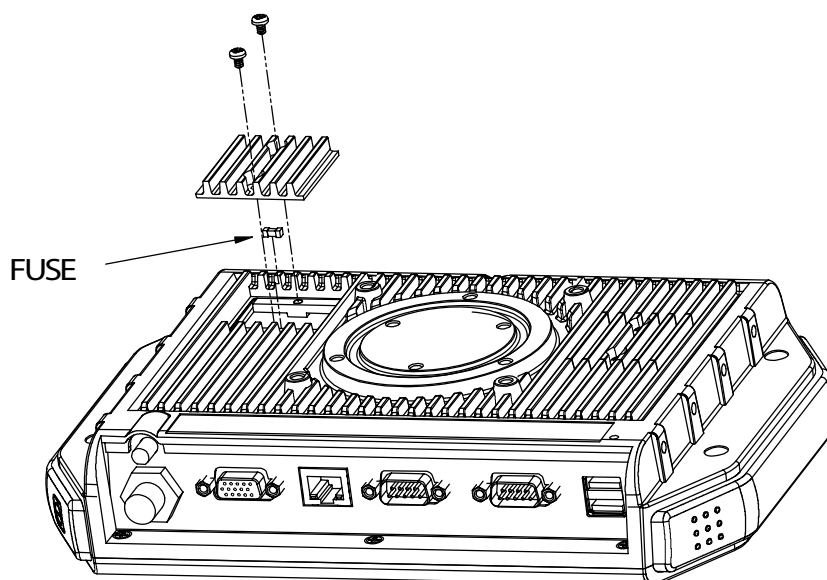

Figure 3.7 Installing the fuse

Chapter 4

Jumper Settings and Connectors

This chapter explains how to set up the Vehicle Mounted Computer hardware, including instructions on setting jumpers and connecting peripherals, and how to set switches and read indicators. Be sure to read all the safety precautions before beginning the installation procedure.

Sections include:

- Setting Jumpers
- CPU Installation
- Jumper Setting on Mother-Board
- COM-port Interface

4.1 Setting Jumpers and Switches

It is possible to configure the Vehicle Mounted Computer to match the needs of the application by resetting the jumpers. A jumper is the simplest kind of electrical switch. It consists of two metal pins and a small metal clip, often protected by a plastic cover that slides over the pins to connect them. To “close” a jumper, connect the pins with the clip. To “open” a jumper, remove the clip. Sometimes a jumper has three pins, labeled 1, 2, and 3. In this case, connect either pins 1 and 2, or pins 2 and 3.

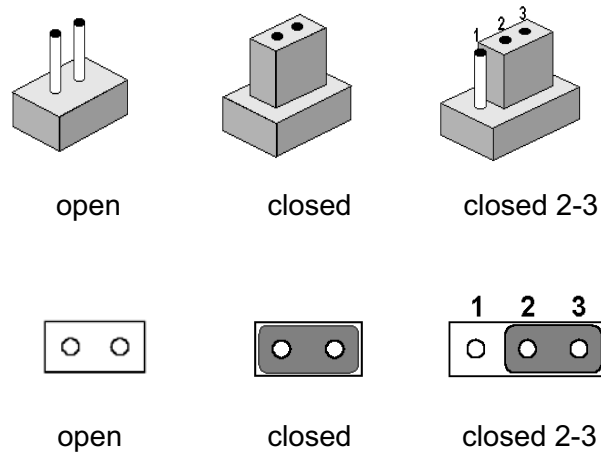

A pair of needle-nose pliers may be helpful when working with jumpers. If there are any doubts about the best hardware configuration for the application, contact the local distributor or sales representative before making any changes.

An arrow is used on the motherboard to indicate the first pin of each jumper.

4.1.1 Locating Jumpers and Switches

The motherboard of the Vehicle Mounted Computer has a number of jumpers that are used to set various configuration options best suited to the function of applications installed on the computer. LEDs that indicate the system operation status are also located on the motherboard. The table below lists the function of each jumper and LED.

Table 4.1: Jumpers & LEDs on the Motherboard

Label	Function
JP1	CMOS clear for external RTC
JP2	COM1/COM2 Pin 9 power output value setting
CN27	COM1/COM2 Pin 9 Ring & power output type setting
JP3	Power feature setting
LED1	Wireless Radio operation indicator
LED2	CAN BUS operation indicator (Tx signal)
LED3	CAN BUS operation indicator (Rx signal)
LED6	Power indicator
LED7	CF operation indicator

4.1.2 Locating Jumpers and LEDs on the Motherboard

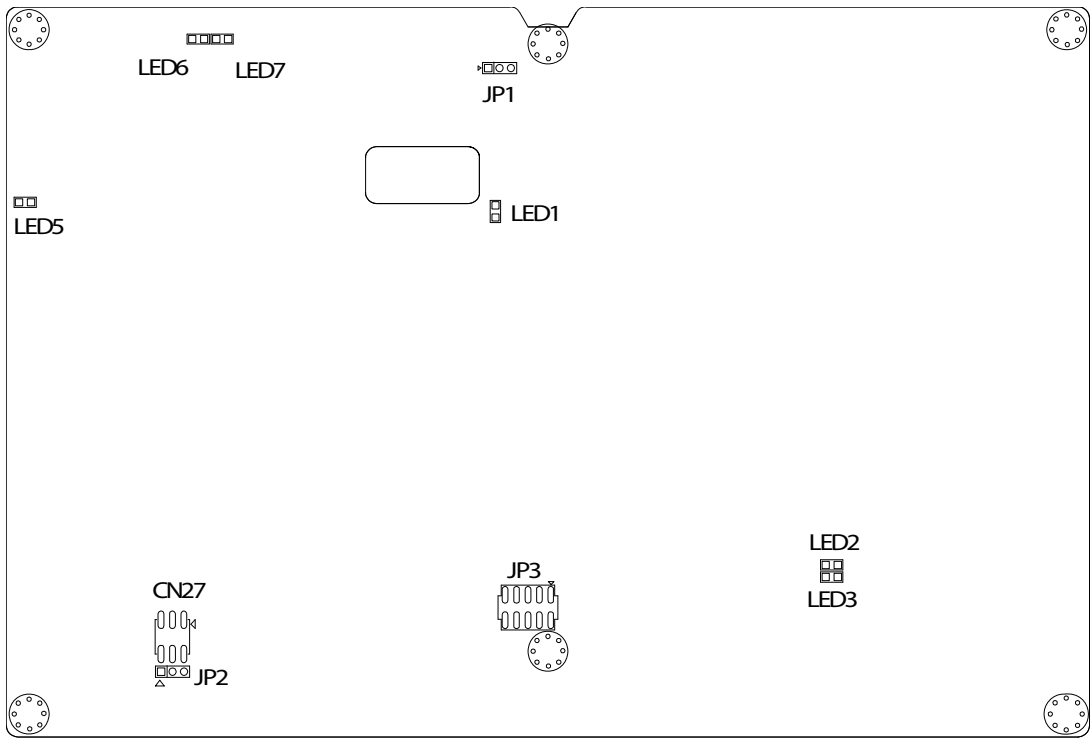

Figure 4.1 Locating Jumpers / LEDs

4.1.3 Connectors on the Motherboard

On-board connectors link the Vehicle Mounted Computer to external devices such as hard disk drives. The table below lists the function of each connector.

Table 4.2: Connectors on the Motherboard

Label	Function
BH1	RTC battery
DIMM1	Dual In-line Memory Module Socket for SDRAM
CN2	RESET
FS3	Fuse
CN4	Power input connector
CN5	SIM holder
CN8	LAN
CN9	Mini PCI socket
CN10	Line in connector (Reserved)
CN11	Line out connector (Reserved)
CN13	USB1+USB2
CN14	USB3 (Blue Tooth)
CN16	Internal COM4 connector for GPRS
CN17	COM1
CN18	Internal COM3 for touchscreen / Inverter power connector / USB4
CN19	COM2
CN20	Internal COM5 connector for GPS
CN25	CF connector
CN26	BIOS
CN31	GPIO/CAN Connector
CN33	Connector for Function Board
CN35	Connector for LCD timing control Board

4.1.4 Locating Connectors on the Motherboard

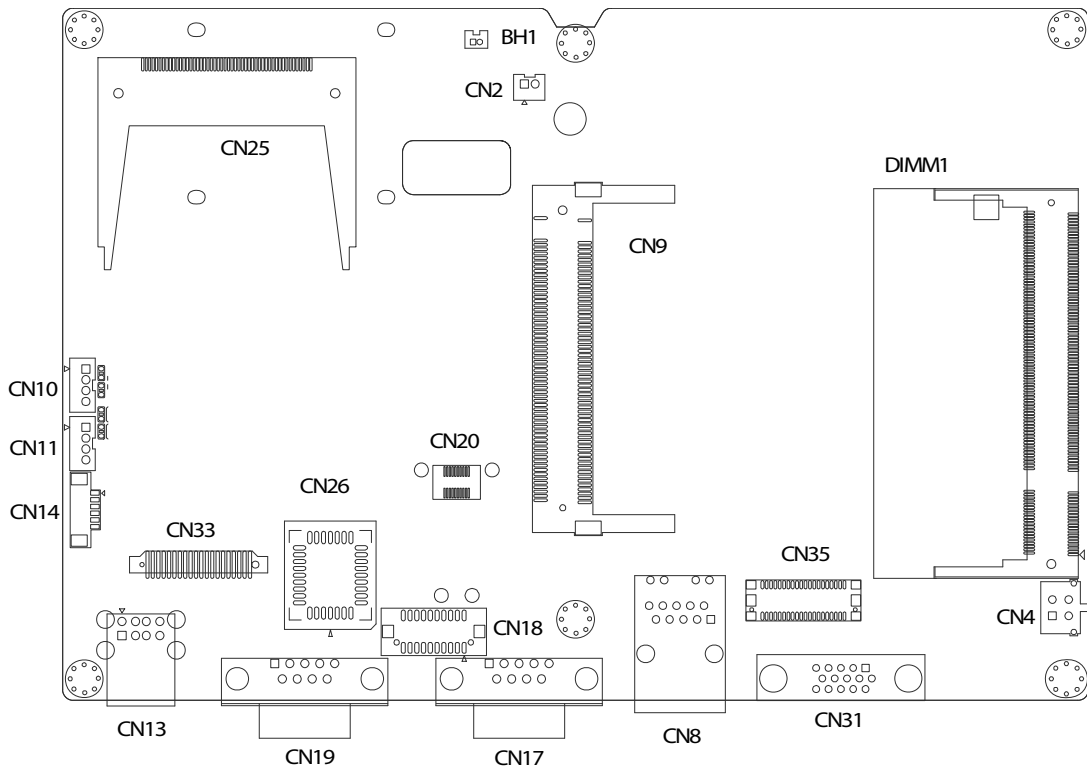

Figure 4.2 Locating Connectors on the front side

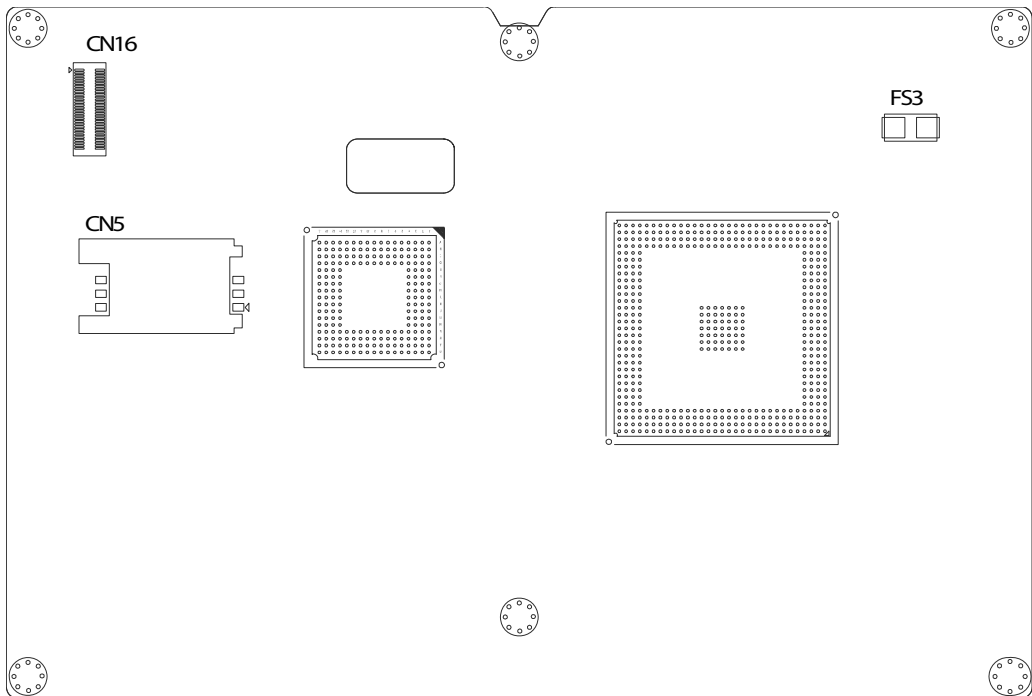

Figure 4.3 Locating Connectors on the back side

4.2 CPU Installation

The CPU is embedded on the motherboard, therefore no settings for frequency ratio or voltage are configured.

4.3 Jumper Settings

4.3.1 CMOS Clear for External RTC (JP1)

- Warning!** 1. To avoid damaging the computer, always turn off the power supply before setting "Clear CMOS."
- 
2. Set the jumper back to "Normal Operation" before turning on the power supply!

Table 4.3: Clear CMOS / External RTC (JP1)

Normal Operation (Default)



Clear CMOS

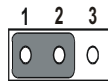
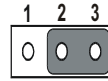

4.3.2 Power Feature Setting (JP3)

Three power feature settings are provided for in the Vehicle Mounted Computer: ignition input switch; power off / hard off delay; and low battery monitor. The functions are controlled by adjusting the jumpers on the 10-pin connector, (JP3), as described below.

4.3.2.1 Ignition Input Switch Setting

JP3 and BIOS settings determine whether the Vehicle Mounted Computer can be activated by an ignition switch or not. By default JP3 is enabled. If you also change the "Power on after power failure" to "always on" in BIOS (Appendix D), and connect the ignition pin (see section 2.2.1), this will enable automatic computer on/off with a vehicle ignition/key. Ignition on/off is disabled by default or by disabling JP3.

Table 4.4: Ignition Input Switch Setting (JP3)

Ignition turn-on enable (Default)

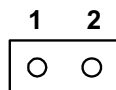

Ignition turn-on disable

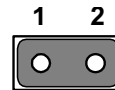

4.3.2.2 Power off / Hard off Delay Setting

Pins 3 to pin 6 of JP3 determine the duration of the time delay before powering off / hard off (5VSB off). The jumper provides four different settings. Refer to the chart below for more detail. The delay time may be custom set by making an OEM request.

Table 4.5: Power off / Hard off Delay Setting (JP3)

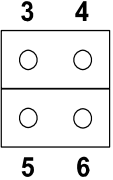
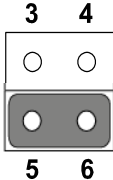
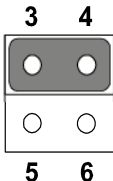
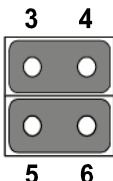
Off delay	Hard off	Jumper setting
0 sec	5 sec	
5 sec (Default)	30 sec (Default)	
1 min	5 min	
5 min	15 min	

The power-off delay function is available in coordination with the ignition input power control, as described in the previous section.

4.3.2.3 Low Battery Monitor

Pins 7 to pin 10 of JP3 determine the optional low battery monitor function which is designed to prevent the DC battery power on the vehicle from draining. When battery voltage drops under a specific level (11V for DC12V battery and 22V for DC24V battery) the function will be activated, and then the OS will be terminated after 30 seconds and system power will shut down after one minute. The default setting keeps all pins open to disable the function; however, DC24V battery protection by closing pin 7-8, or, it can also be changed to DC12V battery protection by closing pin 9-10.

Table 4.6: Low Battery Monitor (JP3)

No battery protection (Default)	DC24V battery protection	DC12V battery protection
---------------------------------	--------------------------	--------------------------

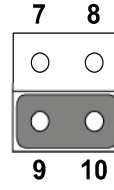
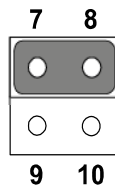
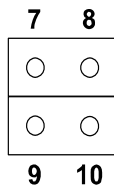

4.4 COM Port Interface

The computer provides two external serial ports: COM1, COM 2: RS-232/422/485 (selectable via BIOS setting), and four internal ports: COM3 to COM6 for touch-screen, GSM/GPRS, GPS and CAN BUS respectively. The IRQ and the address ranges for COM1 to COM6 are fixed.

However, if it is necessary to disable a port or change parameters later, it is possible to do so in the system BIOS setup. The table overleaf shows the default settings for the serial ports on the computer.

COM1 and COM2 comprise one set. It is possible to exchange the address range and interrupt IRQ of COM1 for the address range and interrupt IRQ of COM2. After exchanging:

COM1's address range is 3F8 ~ 3FF and its IRQ is IRQ4.

COM2's address range is 2F8 ~ 2FF and its IRQ is IRQ3.

COM3 and COM4 are another set. It is possible to exchange the address range and interrupt IRQ of COM3 for the address range and interrupt IRQ of COM4. After exchanging:

COM3's address range is 3E8 ~ 3EF and its IRQ is IRQ7.

COM4's address range is 2E8 ~ 2EF and its IRQ is IRQ5.

COM5 and COM6 are another set. It is possible to exchange the address range and interrupt IRQ of COM3 for the address range and interrupt IRQ of COM6. After exchanging:

COM5's address range is 4F8 ~ 4FF and its IRQ is IRQ6.

COM6's address range is 4E8 ~ 4EF and its IRQ is IRQ10.

Table 4.7: Serial Port Default Settings

Port	Address Range	Interrupt
COM1	3F8 ~ 3FF	4
COM2	2F8 ~ 2FF	3
COM3	3E8 ~ 3EF	7
COM4	2E8 ~ 2EF	5
COM5	4F8 ~ 4FF	6
COM6	4E8 ~ 4EF	10

4.4.1 COM Port Pin 9 Power Output Setting (CN27)

Pin 9 on COM1, COM2 port can activate external power output.

Table 4.8: COM Port Pin 9 Power Output Setting (CN27)

External power output disable (Default) **External power output enable**

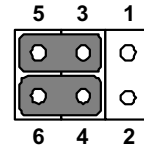
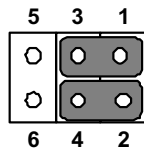

Note!



1. Normally, Pins 1, 3, 5 are assigned to COM1; and Pins 2, 4, 6 are assigned to COM2.
2. The normal external power output value is DC 5V. For DC 12V, an OEM request is required to modify the motherboard.

4.4.2 COM Port Pin 9 Power Output Value Setting (JP2)

Table 4.9: COM Port Pin 9 Power Output Value Setting (JP2)

5V (Default)

12V (Optional)

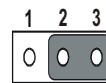
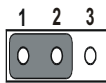

Chapter 5

AMD Chipset

This chapter provides information on AMD chipset configuration.

Sections include:

- Introduction
- Further Information

5.1 Introduction

The TREK-743 uses a combination of the AMD Geode™ (LX800 0.9W 500MHz) CPU and the CS5536AD South Bridge.

The AMD Geode processor has evolved to meet the specific requirements of extended temperature applications in the telecommunications infrastructure (including wired, wireless, and BSC/MSB), single board computing, automotive and transportation systems along with industrial control and monitoring.

The AMD Geode CS5536AD companion device now supports industrial temperature ranges and is optimized to work with the AMD Geode LX processors to deliver an integrated solution with a very low power consumption and internal data speeds exceeding 1 GB/s.

Note! 1. *It is important to pay attention to the instructions which appear on the screen.*



2. *The CD-ROM drive is designated as “D” throughout this chapter.*

1. Place the driver CD into a USB CD-ROM drive.
2. Open control panel - system - hardware and find the Device Manager.
3. Select “Crypto device.” To install the driver, choose “install from a list or specific location.”
4. Select the path into which the driver will be installed: [D:\TREK-743 Driver and Utilities\GX3 AES\GeodeLX_XP_WDM_AES_v2.01.01](#).
5. Click “Yes” to continue.
6. Reboot system to activate the driver.

5.2 Further Information

For further information about the AMD chipset installation on the TREK-743, including driver updates, troubleshooting guides and FAQ lists, visit the following web sites:

- AMD website: www.amd.com
- Advantech websites: www.advantech.com

Chapter 6

Graphic Chipset

This chapter provides information on Graphic chipset configuration.

Sections include:

- Introduction
- Further information

6.1 Introduction

The TREK-743 motherboard is supplied with an on-board integrated VGA chipset. WinCE and Win XP Embedded drivers are already installed.

Win XP Pro users can follow the procedures below for driver installation.

- Note!**
1. *It is important to pay attention to the instructions which appear on the screen.*
 2. *The CD-ROM drive is designated as “D” throughout this chapter.*



1. Place the driver CD into a USB CD-ROM drive.
2. Open control panel - system - hardware and find the Device Manager.
3. Select “Monitors.” To install the driver, choose “install from a list or specific location.”
4. Select the path into which the driver will be installed: [D:\TREK-743 Driver and Utilities\GX3 VGA\lx_win](#).
5. Click “Yes” to continue.
6. Reboot the system to activate the driver.
7. After installing the VGA driver, the color quality of display will be set to 8-bit as the default due to limitation of driver capacities. It is possible to change the color quality in the “display properties” setting under the control panel by following these steps:
 - Right click on desktop and choose properties and find the page “setting” of display properties, and select “Advanced” to continue.

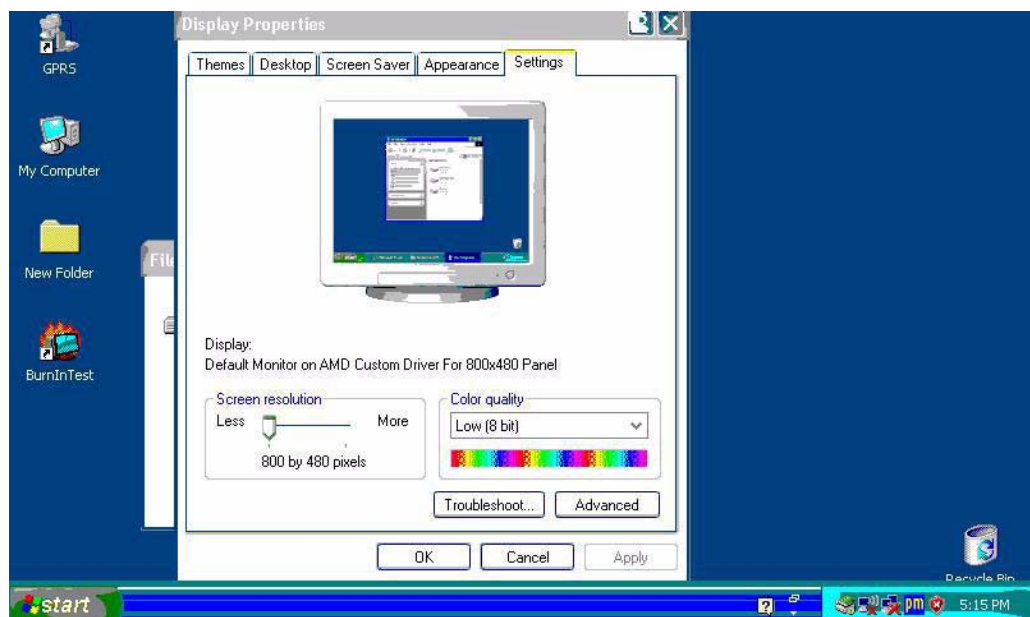

Figure 6.1 Display properties

- Choose the “adapter” menu and click “List Models.”

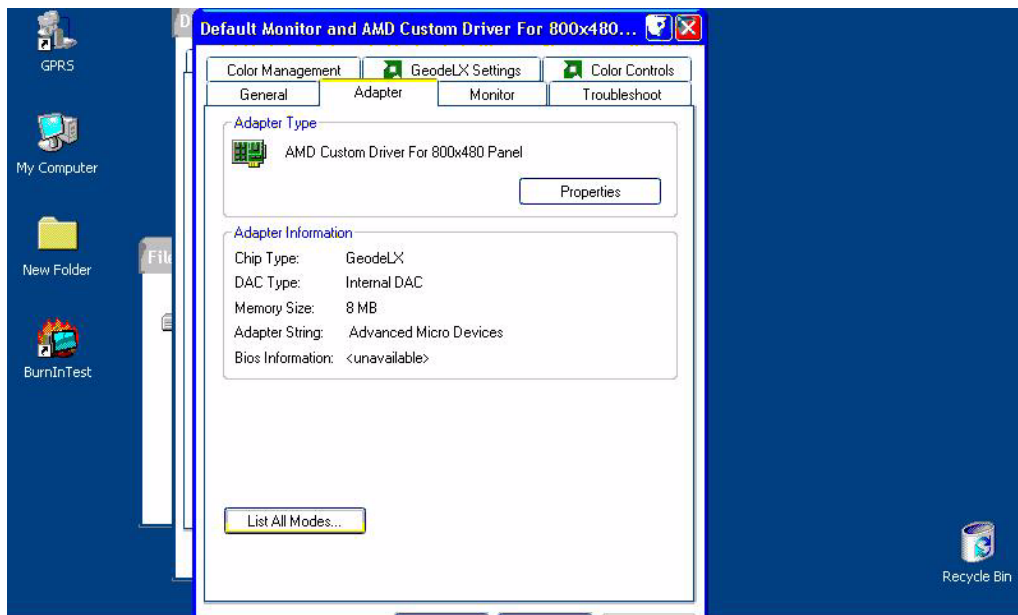

Figure 6.2 Adapter menu

- Find the desired LCD resolution and press OK to update the setting.

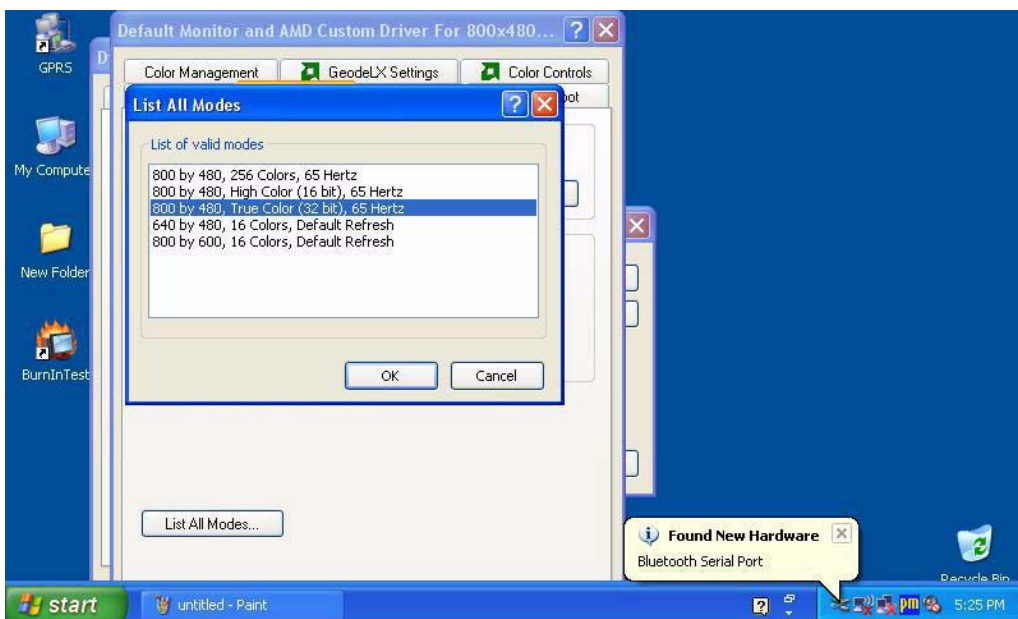

Figure 6.3 LCD resolution selection

6.2 Further Information

For further information about the AMD chipset installation on the TREK-743, including driver updates, troubleshooting guides and FAQ lists, visit the following web sites:

- AMD website: www.amd.com.
- Advantech websites: www.advantech.com

Chapter 7

Audio

This chapter provides information on installation of audio drivers on TREK-743.

Sections include:

- Introduction
- Installation of Audio Driver

7.1 Introduction

The ALC650 is an 18-bit, full duplex AC97 2.2 compatible stereo audio CODEC designed for PC multimedia systems, including host/soft audio and AMR/CNR based designs. The ALC650 AC97 CODEC supports multiple CODEC extensions with independent variable sampling rates and built-in 3D effects.

7.1.1 Installation of Audio Driver

Before installing the audio driver, take note of the procedures detailed below. It is important to be aware of the operating system in use on the TREK-743, and then refer accordingly to the correct installation procedure.

Note! 1. *It is important to pay attention to the instructions which appear on the screen.*



2. *The CD-ROM drive is designated as "D" throughout this chapter.*

1. Execute: [D:\TREK-743 Driver and Utilities\Audio\WDM_A400.exe](#).
2. Select the path into which the driver will be installed and press "Next" to proceed.
3. Follow the on-screen instructions to finish installation.

Chapter 8

LAN

This chapter provides information on installation of LAN drivers on TREK-743.

Sections include:

- Introduction
- Installation of LAN Driver

8.1 Introduction

The driver for the LAN chip, RTL8100CL, is an Auto-installation program.

For support of other Operating Systems like, Win XP 64 / Win98SE / WinME / Win2K / WinXP ver.663, follow the steps below to install the driver.

8.2 Installation of LAN Driver

Note! 1. *It is important to pay attention to the instructions which appear on the screen.*



2. *The CD-ROM drive is designated as "D" throughout this chapter.*

1. Execute: "[D:\TREK-743 Driver and Utilities\LAN\RTL8169_8139_810x_663\setup.exe.](#)"
2. Select the path into which the driver will be installed and press "Next" to proceed.
3. Follow the on-screen instructions.
4. Choose "Yes, I want to restart my computer," and press "Finish." The system will reboot automatically.

Chapter 9

Touchscreen

This chapter provides information on installation of touchscreen drivers on TREK-743.

Sections include:

- Introduction
- Installation of Touchscreen Drivers

9.1 Introduction

9.1.1 General Information

The touchscreen for the TREK-743 series is a resistive touchscreen.

The resistive touchscreen incorporates advanced second-generation resistive, impact-resistant technology, which allows 80% light transmission. There is also an antiglare surface for greatly enhanced visual resolution. It also has new and improved scratch-resistant features. For more detailed information, please visit the following websites:

<http://www.amtouch.com.tw>

Advantech reserves the right to alter the touchscreen at any time without notice.

9.1.2 General Specifications

Please refer to Chapter 1, Section 1.2 of this manual.

9.2 Installation of Touchscreen Driver

The touchscreen driver for Windows contains a native, 32-bit driver and a 32-bit control panel program for the TREK-743 system.

- Note!**
1. *It is important to pay attention to the instructions which appear on the screen.*
 2. *The CD-ROM drive is designated as "D" throughout this chapter.*



Instructions for installing touchscreen drivers for Windows XP / XP Embedded:

To install the driver software, the TREK-743 must have a Windows XP system running and PenMount control board already installed. If an older version of the PenMount Windows XP driver is installed on the TREK-743, please remove it.

Follow the steps below to install the PenMount Windows XP driver:

1. Execute: [D:\TREK-743 Driver and Utilities\DMC6000\Driver\PenMount Windows Universal Driver V1.0.1020_AP V1.0.0.8\setup.exe](#) to install the PenMount Windows XP driver and press "Next" to proceed.
2. Press "Next" and follow the on-screen instructions; and press "install" to start.
3. The "Restarting Windows" dialog box appears. Click "Yes I want to restart my computer now," then click "OK" to restart the computer.

9.3 Further Information

Advantech	www.advantech.com
Salt	www.salt.com.tw
AMT	www.amtouch.com.tw

Appendix **A**

Pin Assignments

This appendix explains pin assignments on the TREK-743.

Sections include:

- Internal Speaker Connector
- COM1, 2
- GPIO / CAN BUS connector (CN31)
- Inverter / Touch / USB connector (CN18)
- Power Inlet

A.1 Internal Speaker Connector (CN2 on PCM-028)



Table A.1: Internal Speaker Connector (CN2 on PCM-028)

Pin	Signal
1	Speaker out_ -
2	Speaker out_ +

A.2 COM1, 2 (CN17,19)

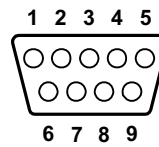

Table A.2: COM1, 2 (CN17,19)

Pin	Signal		
	RS-232	RS-422	RS-485
1	DCD	TX-	DATA-
2	RX	TX+	DATA+
3	TX	RX+	-
4	DTR	RX-	-
5	GND	GND	-
6	DSR	-	-
7	RTS	-	-
8	CTS	-	-
9	RI	-	-

A.3 GPIO / CAN BUS Connector (CN31)

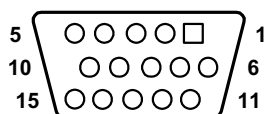

Table A.3: GPIO / CAN BUS Connector (CN31)

Pin	Signal
1	CAN_H
2	CAN_H
3	CAN_L
4	CAN_L
5	GND
6	GPIO
7	GPI1
8	GPI2
9	GPI3
10	ISO_GND
11	GPO4
12	GPO5
13	GPO6
14	GPO7
15	ISO_GND

A.4 Inverter / Touch / USB Connector (CN18)

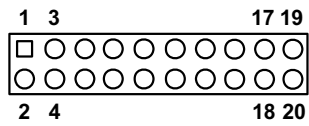

Table A.4: Inverter / Touch / USB Connector (CN18)

Pin	Sign
1	DSR
2	DCD
3	RTS
4	RX
5	CTS
6	TX
7	RI
8	DTR
9	+5V
10	GND
11	VBR
12	GND
13	ENABKL
14	DATA -
15	GND
16	DATA +
17	+5V
18	GND
19	+12V
20	Vcc

A.5 Power Inlet

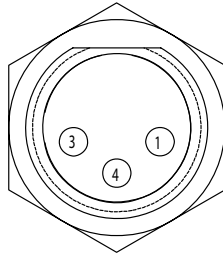

Table A.5: Power inlet

Pin	Signal
1	- (GND)
3	+ (Power)
4	Ignition

Appendix **B**

Software API

This appendix explains the software API for TREK-743.

B.1 Software API

To make the hardware easier to access for programmers, Advantech has developed an API suite, (Application Programming Interface), named SUSI (Secure & Unified Smart Interface), in the form of a program reference library. For technical support and news updates, please visit website: <http://www.advantech.com.tw/ess/SUSI.asp> . SUSI currently supports two OS - Windows CE and Windows XP / XPe which can be downloaded from <http://www.advantech.com.tw/ess/download.aspx>

The website describes detailed information for each Advantech API so that application developers can become more familiar with using them.

Please find the CAN BUS API and user manual from TREK-743 "Drivers, utilities and User manual" CD. Or you can contact Advantech application engineers worldwide.

Note! The list may be changed without notice.



Appendix **C**

BIOS Settings

This appendix explains the features of BIOS on the TREK-743.

Sections include:

- Power Fail Function Setting in BIOS
- Features of PC Health Status

C.1 Power Fail Function Setting in BIOS

To set the “power fail” function in BIOS and to activate the “power on/off function via ignition switch”, follow these instructions:

Figure D.1 Main Menu: Power Management Setup

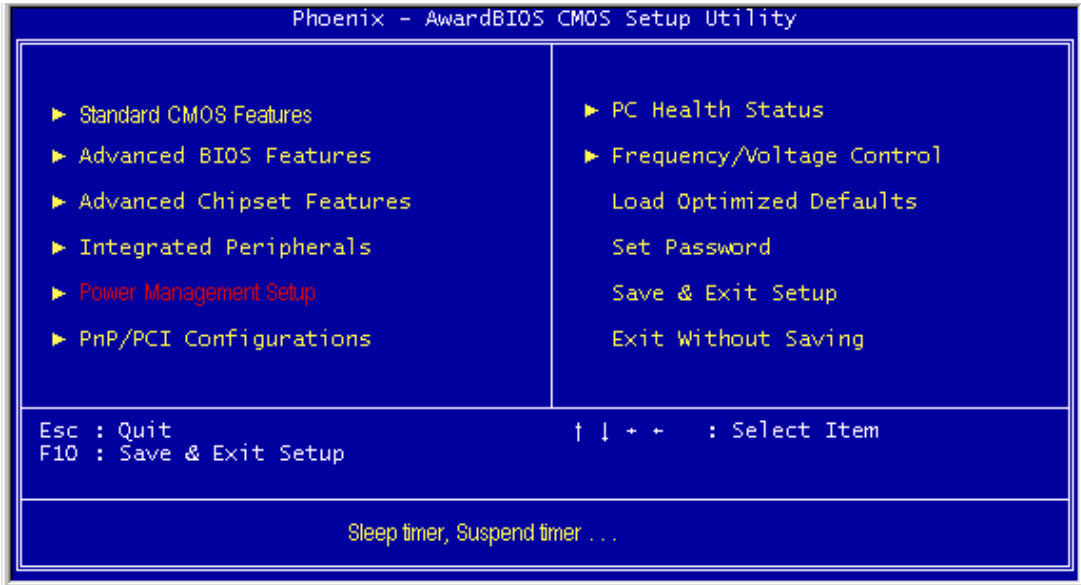

1. Choose “Power Management Setup” from the BIOS main menu

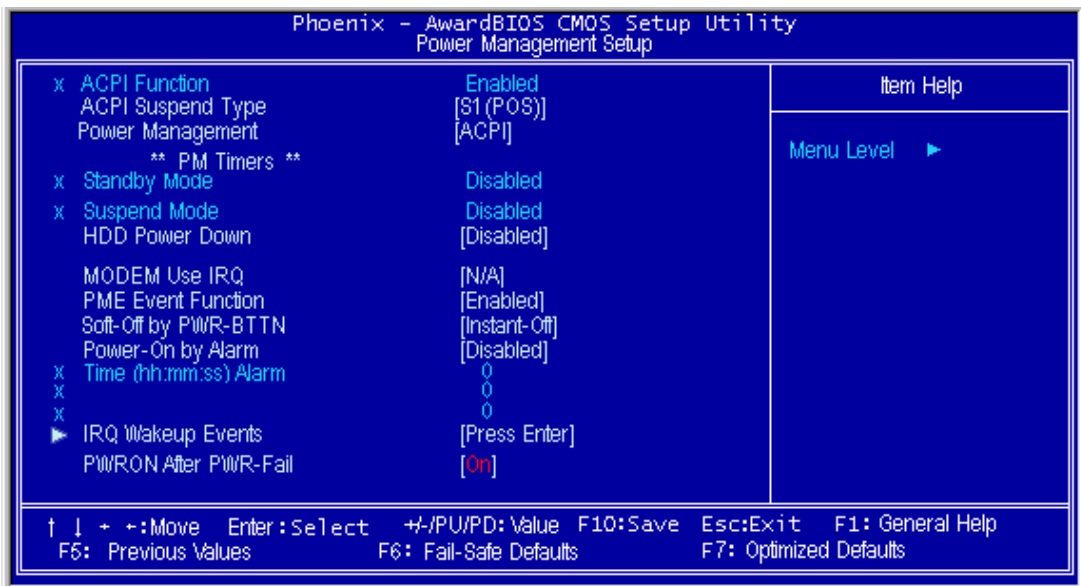

Figure D.2 Power Fail Function

2. Choose “Power Fail Function” and then select “Always On”.
3. To disable the Power-On/Off function by using the ignition switch, select “Always Off”, so the Power-On/Off function can be controlled by the TREK-743 power switch

C.2 Feature of PC Health Status

The input voltage of TREK-743 can be examined in the BIOS so user can check the status of car battery or power supply easily; please follow below step.

1. Choose "PC Health Status" from the BIOS main menu.

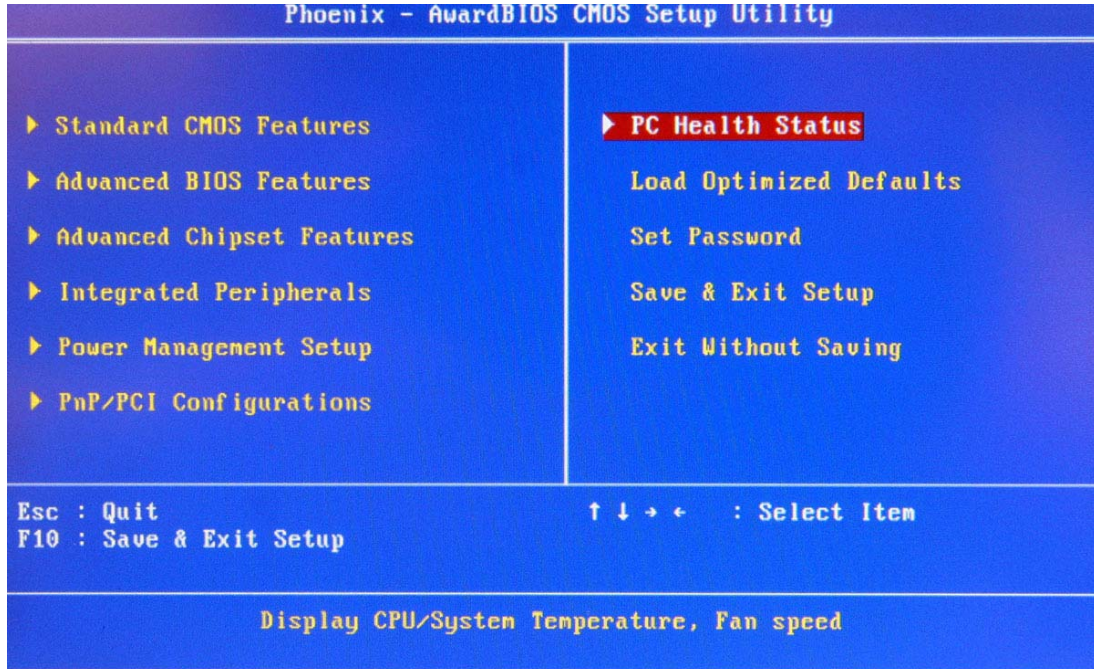

2. Find the VIN in this page.

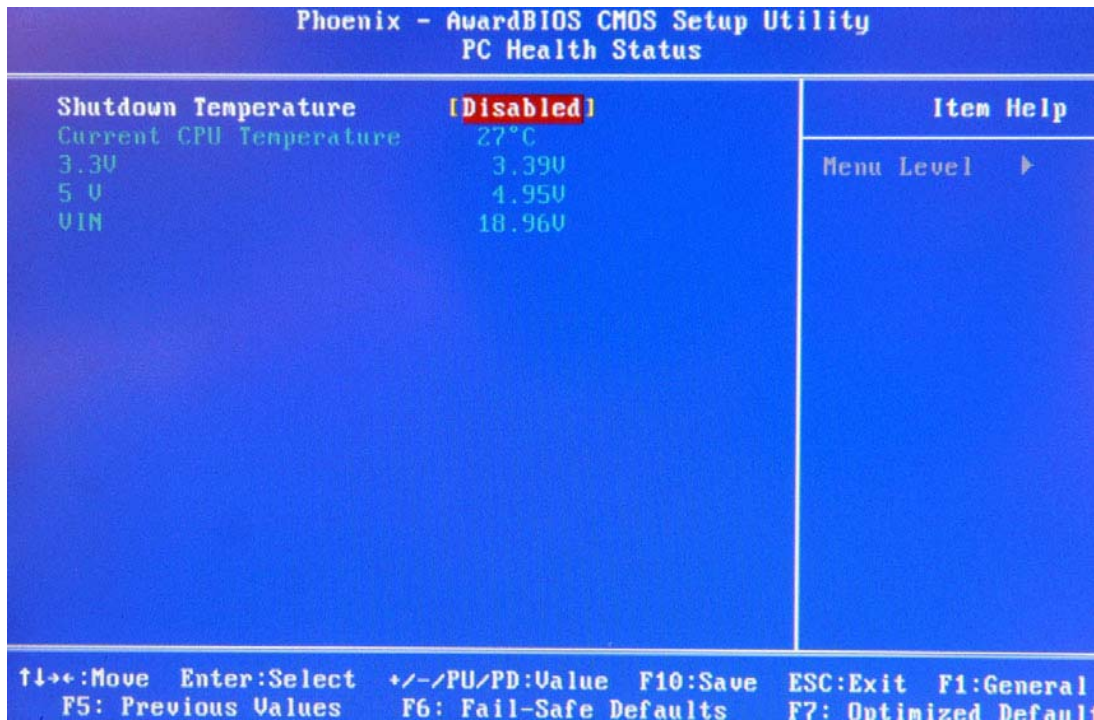

Trusted ePlatform Services

ADVANTECH

www.advantech.com

Please verify specifications before quoting. This guide is intended for reference purposes only.

All product specifications are subject to change without notice.

No part of this publication may be reproduced in any form or by any means, electronic, photocopying, recording or otherwise, without prior written permission of the publisher.

All brand and product names are trademarks or registered trademarks of their respective companies.

© Advantech Co., Ltd. 2008