



**FCC 47 CFR PART 15 SUBPART E  
TEST REPORT**

**For**

**Computer**

**Model : TREK-572 ; TREK-572XXXXXXXXXXXXXXXXXX**  
(where "X" may be any alphanumeric character , "-" or blank)

**Trade Name : ADVANTECH**

**Issued for**

**Advantech Co. Ltd.**

**No.1, Alley 20, Lane 26, Rueiguang Road, Neihu District, Taipei 114, Taiwan,  
R.O.C.**

**Issued by**

**Compliance Certification Services Inc.  
Hsinchu Lab.**

**NO. 989-1 Wen Shan Rd., Shang Shan Village,  
Qionglin Shiang Hsinchu County 30741, Taiwan, R.O.C  
TEL: +886-3-5921698  
FAX: +886-3-5921108**

**<http://www.ccsrf.com>  
E-Mail : [service@ccsrf.com](mailto:service@ccsrf.com)**

**Issued Date: March 11, 2015**



**Note:** This report shall not be reproduced except in full, without the written approval of Compliance Certification Services Inc. This document may be altered or revised by Compliance Certification Services Inc. personnel only, and shall be noted in the revision section of the document. The client should not use it to claim product endorsement by TAF or any government agencies. The test results of this report relate only to the tested sample identified in this report.



## Revision History

Rev.	Issue Date	Revisions	Effect Page	Revised By
00	03/11/2015	Initial Issue	All Page 25	Dola Hsieh



**TABLE OF CONTENTS**

<b>TITLE</b>	<b>PAGE NO.</b>
<b>1. TEST REPORT CERTIFICATION .....</b>	<b>4</b>
<b>2. EUT DESCRIPTION .....</b>	<b>5</b>
<b>3. DESCRIPTION OF TEST MODES .....</b>	<b>7</b>
<b>4. TEST METHODOLOGY .....</b>	<b>7</b>
<b>5. FACILITIES AND ACCREDITATION .....</b>	<b>8</b>
5.1 FACILITIES .....	8
5.2 ACCREDITATIONS.....	8
5.3 MEASUREMENT UNCERTAINTY .....	9
<b>6. SETUP OF EQUIPMENT UNDER TEST.....</b>	<b>10</b>
<b>7. DYNAMIC FREQUENCY SELECTION (DFS) .....</b>	<b>11</b>
<b>APPENDIX SETUP PHOTOS .....</b>	<b>25</b>



# 1. TEST REPORT CERTIFICATION

**Applicant** : Advantech Co. Ltd.  
**Address** : No.1, Alley 20, Lane 26, Rueiguang Road, Neihu District, Taipei 114, Taiwan, R.O.C.  
**Equipment Under Test** : Computer  
**Model** : TREK-572; TREK-572XXXXXXXXXXXXXXXXXX  
 (where "X" may be any alphanumeric character , "-" or blank)  
**Trade Name** : ADVANTECH  
**Tested Date** : September 11 ~ December 02, 2014

APPLICABLE STANDARD	
Standard	Test Result
FCC Part 15 Subpart E	PASS

WE HEREBY CERTIFY THAT: The measurements shown in the attachment were made in accordance with the procedures indicated, and the energy emitted by the equipment was found to be within the limits applicable. We assume full responsibility for the accuracy and completeness of these measurements and vouch for the qualifications of all persons taking them.

**Approved by:**

Sb. Lu  
Sr. Engineer

**Reviewed by:**

Gundam Lin  
Sr. Engineer



## 2. EUT DESCRIPTION

<b>Product Name</b>	Computer
<b>Model Number</b>	TREK-572; TREK-572XXXXXXXXXXXXXXXXXX (where "X" may be any alphanumeric character , "-" or blank)
<b>Identify Number</b>	T140911L12-A
<b>Received Date</b>	September 11, 2014
<b>Frequency Range</b>	UNII Band 2A: IEEE 802.11a, 802.11an HT20 : 5260MHz ~ 5320MHz IEEE 802.11an HT40 : 5270MHz ~ 5310MHz UNII Band 2C: IEEE 802.11a, 802.11an HT20 : 5500MHz ~ 5700MHz IEEE 802.11an HT40 : 5510MHz ~ 5670MHz
<b>Channel Spacing</b>	IEEE 802.11a, 802.11an HT20 : 20MHz IEEE 802.11an HT40 : 40MHz
<b>Channel Number</b>	IEEE 802.11a, 802.11an HT20 : 5250MHz ~ 5350MHz : 4 Channels 5470MHz ~ 5725MHz : 8 Channels IEEE 802.11an HT40 : 5250MHz ~ 5350MHz : 2 Channels 5470MHz ~ 5725MHz : 3 Channels
<b>Transmit Data Rate</b>	IEEE 802.11a : up to 54 Mbps IEEE 802.11an (VHT20,800ns GI) : up to 65.00 Mbps IEEE 802.11an (VHT20,400ns GI) : up to 72.20 Mbps IEEE 802.11an (VHT40,800ns GI) : up to 135.00 Mbps IEEE 802.11an (VHT40,400ns GI) : up to 150.00 Mbps
<b>Type of Modulation</b>	IEEE 802.11a : OFDM (64QAM, 16QAM, QPSK, BPSK) IEEE 802.11an HT20/40 : OFDM (64QAM, 16QAM, QPSK, BPSK)
<b>Firmware version</b>	10.0.0.288
<b>Antenna Type</b>	PIFA Antenna , Antenna Gain : 2.75 dBi
<b>Power Rating</b>	9-32Vdc
<b>Test Voltage</b>	120Vac, 60Hz
<b>DC Power Cable Type</b>	Non-shielded cable, 1.5m × 1 (Detachable)
<b>I/O Port</b>	EUT : RJ-45 Port × 1, USB Port × 1, Power Port × 1, VGA Port × 1, Signal Port × 1, Audio Port × 2 Panel : Signal Port × 1, USB Port × 1
<b>Signal Cable</b>	Shielded signal cable, 2m × 1 (Detachable), with two ferrite core



**The difference of the series model :**

Model Number	Difference
TREK-572	1. For marketing purpose only. 2. where "X" may be any alphanumeric character , "-" or blank
TREK-572XXXXXXXXXXXXXXXXXX	

- Remark :**
1. For more details, please refer to the User's manual of the EUT.
  2. The model TREK-572 was considered the main model for testing.
  3. This submittal(s) (test report) is intended for FCC ID: M82-TREK572LTE filing to comply with Section 15.207, 15.209 and 15.407 of the FCC Part 15, Subpart E Rules.



### **3. DESCRIPTION OF TEST MODES**

The EUT (TREK-572) had been tested under operating condition. Software used to control the EUT for staying in continuous transmitting mode was programmed.

IEEE 802.11an HT20:

Channel Low (5300MHz) and Channel Low (5500MHz).

IEEE 802.11an HT40:

Channel Low (5310MHz) and Channel Low (5510MHz).

### **4. TEST METHODOLOGY**

The tests documented in this report were performed in accordance with FCC 06-96 and the DFS portions of FCC CFR 47 Part 15.



## 5. FACILITIES AND ACCREDITATION

### 5.1 FACILITIES

All measurement facilities used to collect the measurement data are located at

NO. 989-1 Wen Shan Rd., Shang Shan Village,  
Qionglin Shiang Hsinchu County 30741, Taiwan, R.O.C

The sites are constructed in conformance with the requirements of ANSI C63.4:2009 and CISPR 22. All receiving equipment conforms to CISPR 16-1-1, CISPR 16-1-2, CISPR 16-1-3, CISPR 16-1-4, CISPR 16-1-5.

### 5.2 ACCREDITATIONS

Our laboratories are accredited and approved by the following approval agencies according to ISO/IEC 17025.

<b>Taiwan</b>	TAF
---------------	-----

The measuring facility of laboratories has been authorized or registered by the following approval agencies.

<b>Canada</b>	INDUSTRY CANADA
<b>Japan</b>	VCCI
<b>Taiwan</b>	BSMI
<b>USA</b>	FCC MRA

Copies of granted accreditation certificates are available for downloading from our web site, <http://www.ccsrf.com>

**Remark:** FCC Designation Number TW1027.





### 5.3 MEASUREMENT UNCERTAINTY

The interpretation of the results for the measurements described in the present document shall be as follows:

- (1) The measured value related to the corresponding limit will be used to decide whether an equipment meets the requirements of the present document.
- (2) The measurement uncertainty value for the measurement of each parameter shall be recorded.
- (3) The recorded value of the measurement uncertainty shall be, for each measurement, equal to or lower than the figures under the table.

PARAMETER	UNCERTAINTY
RF frequency	+/-1 * 10 <sup>-5</sup>
RF power conducted	+/- 1,5 dB
RF power radiated	+/- 6 dB
Spurious emissions, conducted	+/- 3 dB
Spurious emissions, radiated	+/- 6 dB
Humidity	+/- 5 %
Temperature	+/- 1°C
Time	+/-10 %

For the test methods, according to the present document, the measurement uncertainty figures shall be calculated in accordance with TR 100 028-1 [2] and shall correspond to an expansion factor (coverage factor) k = 1.96 or k = 2 (which provide confidence levels of respectively 95 % and 95.45 % in the case where the distributions characterizing the actual measurement uncertainties are normal (Gaussian)).



## 6. SETUP OF EQUIPMENT UNDER TEST

### SUPPORT EQUIPMENT

No.	Product	Manufacturer	Model No.	Serial No.
1	Notebook PC	DELL	PP19L	CN-0MG532-70166 -71G-03EC
2	Wireless AC1750 Dual Band Gigabit Cloud Router	D-Link	DIR-868L	R3WE1E1001943
3	DC Power Supply	Rohde & Schwarz	NGSM 32/10	100232

No.	Signal Cable Description
1	Non-shielded RJ-45 cable, 1.5m × 1

### SETUP DIAGRAM FOR TESTS

EUT & peripherals setup diagram is shown in appendix setup photos.

### EUT OPERATING CONDITION

1. EUT & peripherals setup diagram is shown in appendix setup photos.
2. Enter the web configuration:
  - ⇒ **Select channel**
    - 6.5Mbps Bandwidth 20 (IEEE 802.11n HT20 mode)
    - 13.5Mbps Bandwidth 40 (IEEE 802.11n HT40 mode)
  - ⇒ **Select channel**
    - IEEE 802.11n HT20 Channel Low (5300MHz)
    - IEEE 802.11n HT20 Channel Middle (5500MHz)
    - IEEE 802.11n HT40 Channel Low (5310MHz)
    - IEEE 802.11n HT40 Channel Middle (5510MHz)
4. All of the functions are under run.
5. Start testing



## 7. DYNAMIC FREQUENCY SELECTION (DFS)

### Interference Threshold values, Master or Client incorporating In-Service

Maximum Transmit Power	Value (see note)
≥ 200 mW	-64 dBm
< 200 mW	-62 dBm

Note: 1. This is the level at the input of the receiver assuming a 0 dBi receive antenna.

2. Throughout these test procedures an additional 1 dB has been added to the amplitude of the test transmission waveforms to account for variations in measurement equipment. This will ensure that the test signal is at or above the detection threshold level to trigger a DFS response.

### DFS Response requirement values

Parameter	Value
Non-occupancy period	Minimum 30 minutes
Channel Availability Check Time	60 seconds
Channel Move Time	10 seconds
Channel Closing Transmission Time	200 milliseconds + approx. 60 milliseconds over remaining 10 second period
U-NII Detection Bandwidth	Minimum 80% of the 99% transmission power bandwidth.

Note 1. The instant that the Channel Move Time and the Channel Closing Transmission Time begins is as follows:

- For the Short pulse radar Test Signals this instant is the end of the Burst.
- For the Frequency Hopping radar Test Signal, this instant is the end of the last radar burst generated.
- For the Long Pulse radar Test Signal this instant is the end of the 12 second period defining the radar transmission.

Note 2. The Channel Closing Transmission Time is comprised of 200 milliseconds starting at the beginning of the Channel Move Time plus any additional intermittent control signals required to facilitate channel changes (an aggregate of approximately 60 milliseconds) during the remainder of the 10 second period. The aggregate duration of control signals will not count quiet periods in between transmissions.

Note 3. During the U-NII Detection Bandwidth detection test, radar type 1 is used and for each frequency step the minimum percentage of detection is 90%. Measurements are performed with no data traffic.

### Radar Test Waveforms Minimum Step

Step intervals of 0.1 microsecond for Pulse Width, 1 microsecond for PRI, 1 MHz for chirp width and 1 for the number of pulses will be utilized for the random determination of specific test waveforms.



**Short Pulse Radar Test Waveforms**

Radar Type	Pulse Width (Microseconds)	PRI (Microseconds)	Pulses	Minimum Percentage of Successful Detection	Minimum Trials
1	1	1428	18	60%	30
2	1-5	150-230	23-29	60%	30
3	6-10	200-500	16-18	60%	30
4	11-20	200-500	12-16	60%	30
Aggregate (Radar Types 1-4)				80%	120

A minimum of 30 unique waveforms are required for each of the short pulse radar types 2 through 4. For short pulse radar type 1, the same waveform is used a minimum of 30 times. If more than 30 waveforms are used for short pulse radar types 2 through 4, then each additional waveform must also be unique and not repeated from the previous waveforms. The aggregate is the average of the percentage of successful detections of short pulse radar types 1-4.

**Long Pulse Radar Test Waveform**

Radar Waveform	Pulse Width (µsec)	Chirp Width (µsec)	PRI (µsec)	Pulses per Burst	Bursts	Minimum Percentage of Successful Detection	Minimum Trials
5	50-100	5-20	1000-2000	1-3	8-20	80%	30

**Frequency Hopping Radar Test Signal**

Radar Waveform	Pulse Width (µsec)	PRI (µsec)	Pulses Per Hop	Hopping Rate (kHz)	Burst Length (ms)	Minimum Percentage of Successful Detection	Minimum Trials
6	1	333	9	0.33	300	70%	30



**Applicability of DFS requirements prior to use of a channel**

Requirement	Operational Mode		
	Master	Client (without radar detection)	Client(with radar detection)
Non-Occupancy Period	Yes	Yes	Yes
DFS Detection Threshold	Yes	Not Required	Yes
Channel Availability Check Time	Yes	Not Required	Not Required
Uniform Spreading	Yes	Not Required	Not Required
U-NII Detection Bandwidth	Yes	Not Required	Yes

**Applicability of DFS requirements during normal operation**

Requirement	Operational Mode		
	Master	Client (without radar detection)	Client(with radar detection)
DFS Detection Threshold	Yes	Not Required	Yes
Channel Closing Transmission Time	Yes	Yes	Yes
Channel Move Time	Yes	Yes	Yes
U-NII Detection Bandwidth	Yes	Not Required	Yes

**CONDUCTED METHOD SYSTEM BLOCK DIAGRAM**

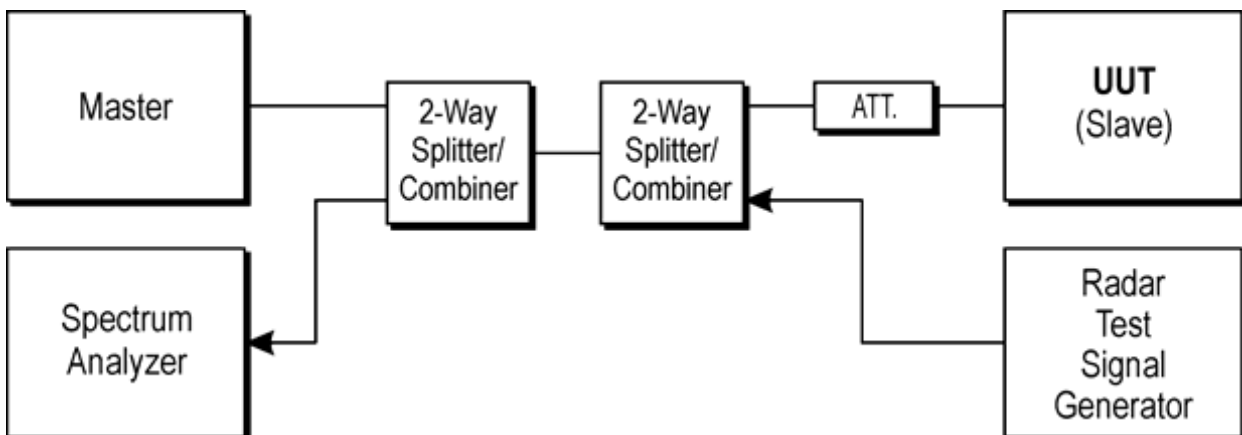



**DESCRIPTION OF EUT**

**Overview Of EUT With Requirements**

The firmware installed in the EUT during testing was:

Firmware Rev: 10.0.0.288

The EUT operates over the 5250-5350 MHz and 5470-5725MHz ranges.

The EUT is a Client without radar detection.

**TEST CHANNELS AND METHOD**

All tests were performed at a channel center frequency of 5300MHz / 5310MHz;  
5500MHz / 5510MHz.

Measurements were performed using conducted test methods.

**TEST SETUP**

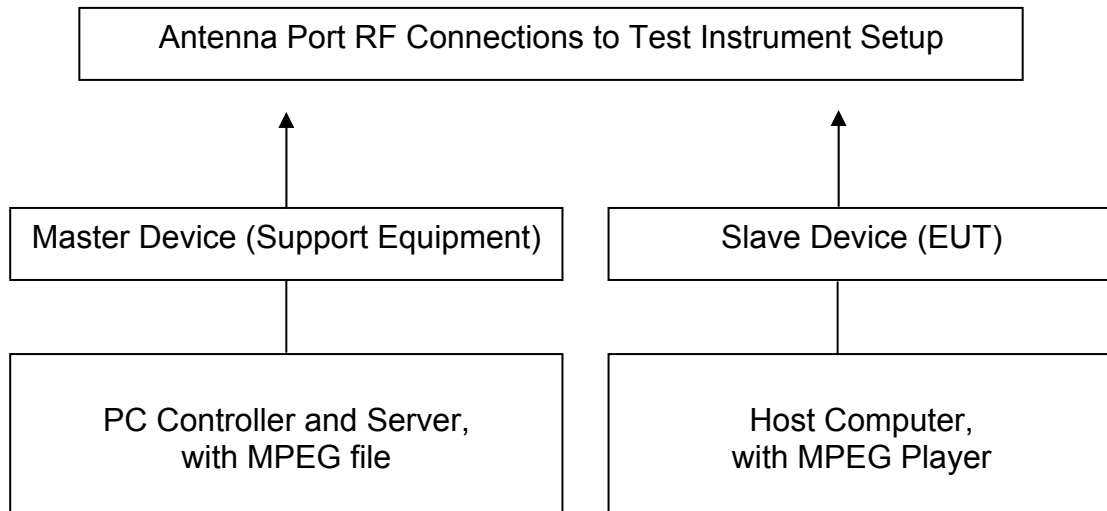



**Radar Waveform calibration Plot**

Radar test signal type 1 / 5300MHz

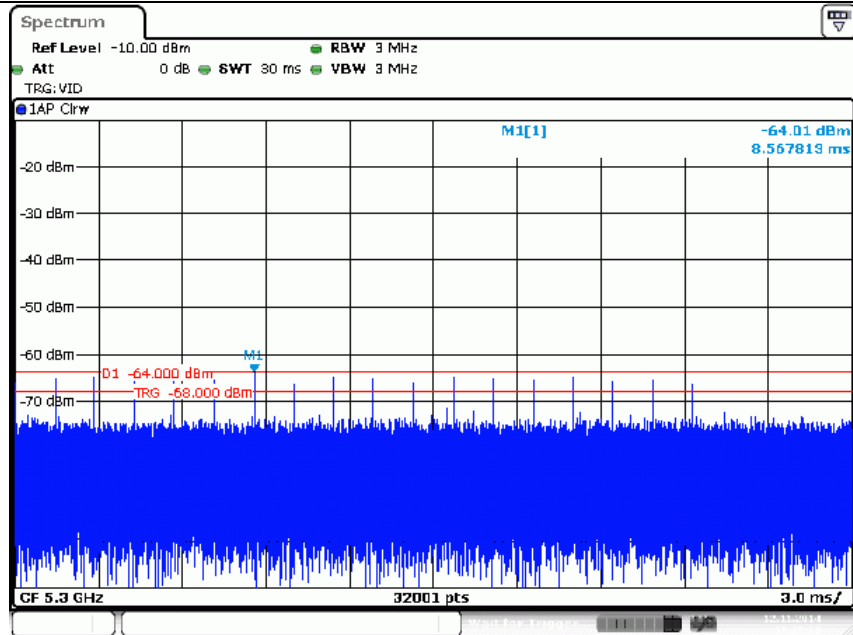

Date: 12.NOV.2014 17:20:23

Radar test signal type 1 / 5500MHz

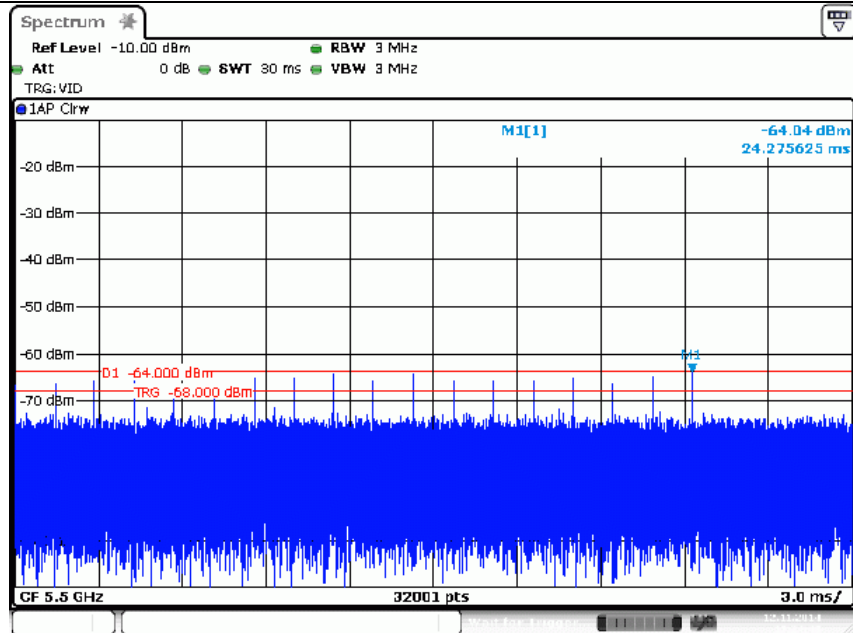

Date: 12.NOV.2014 17:24:48



Radar test signal type 1 / 5310MHz

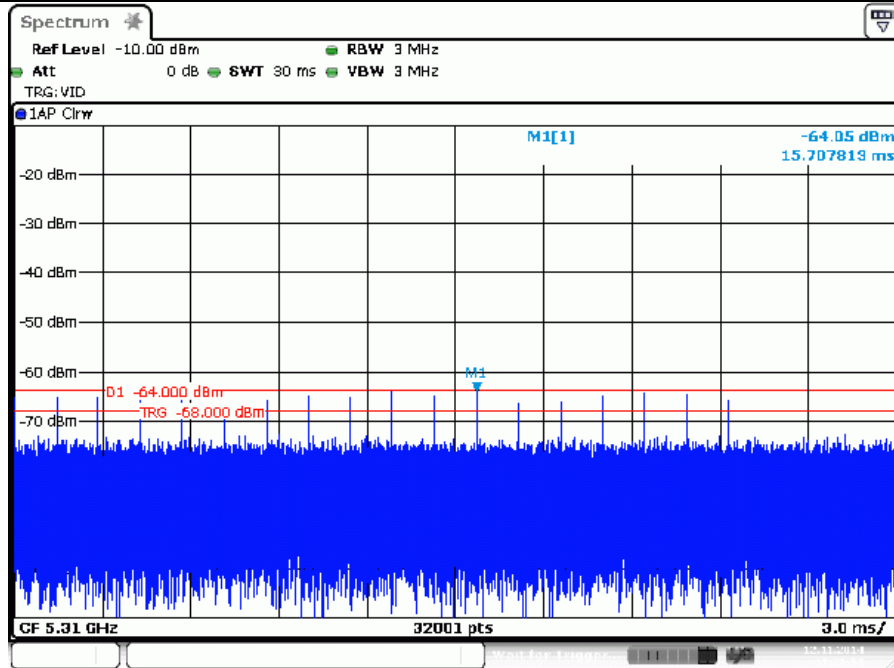

Date: 12.NOV.2014 17:26:33

Radar test signal type 1 / 5510MHz

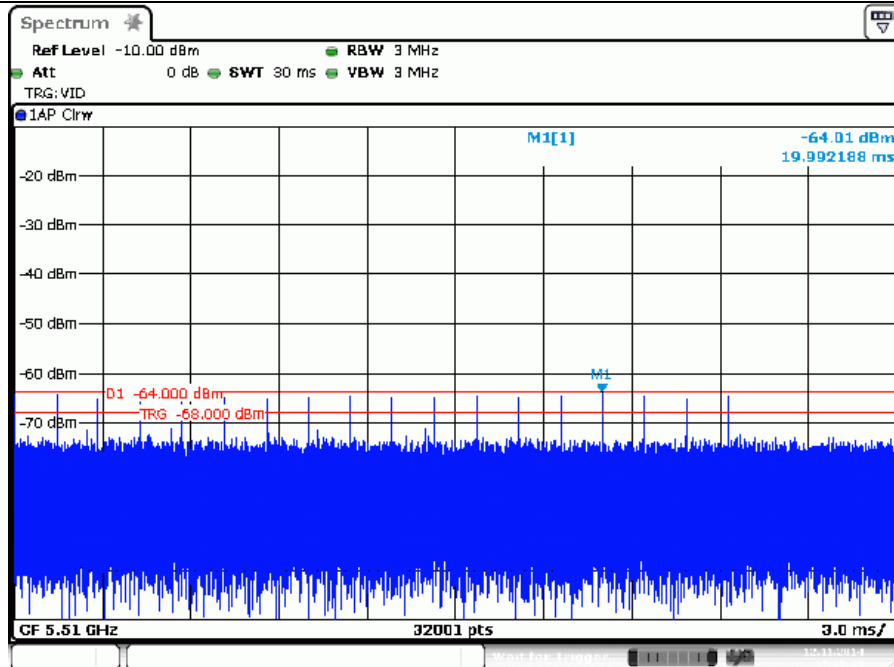

Date: 12.NOV.2014 17:25:30





**Test Result of Duty Plots**

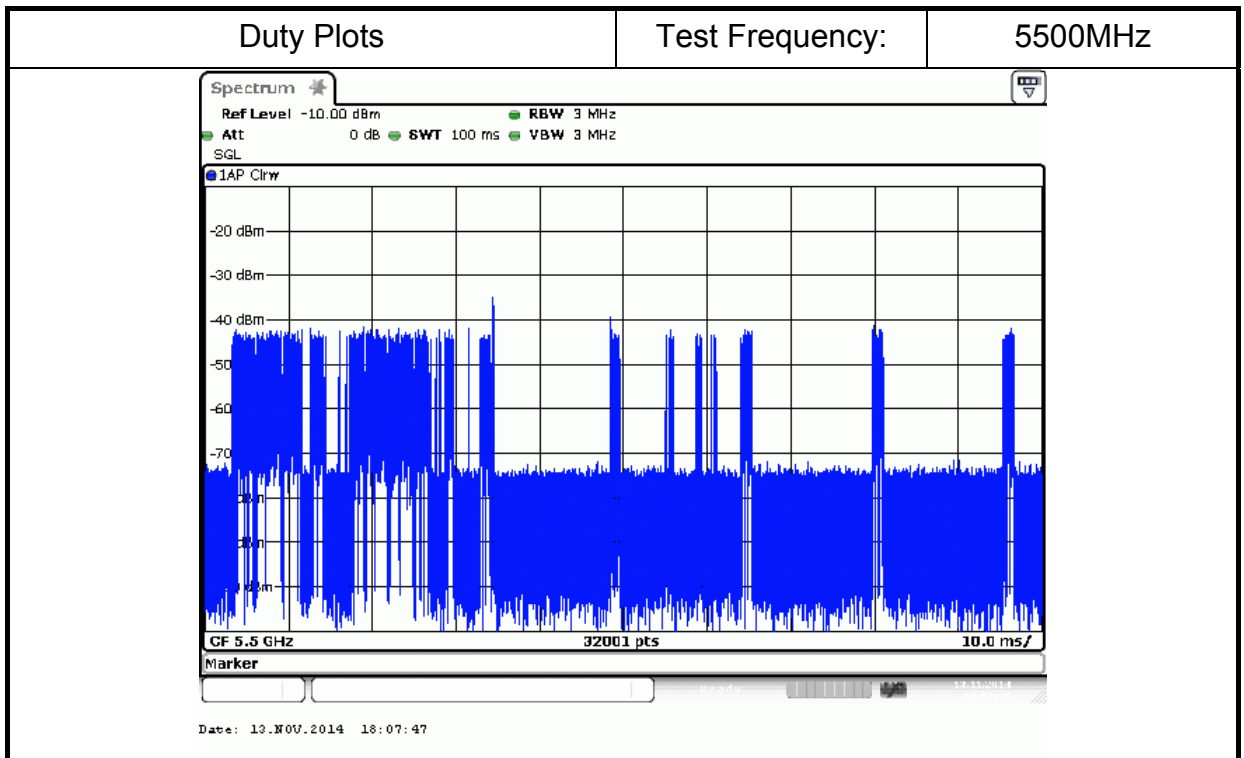
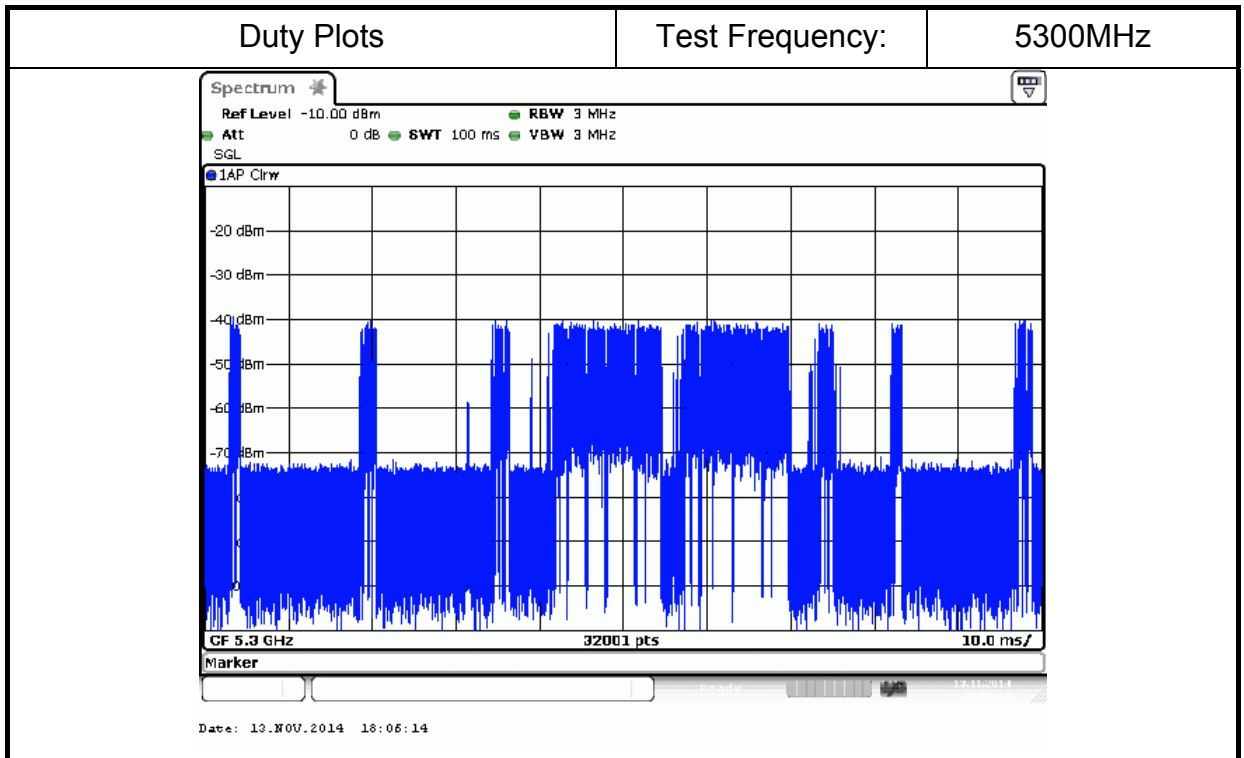

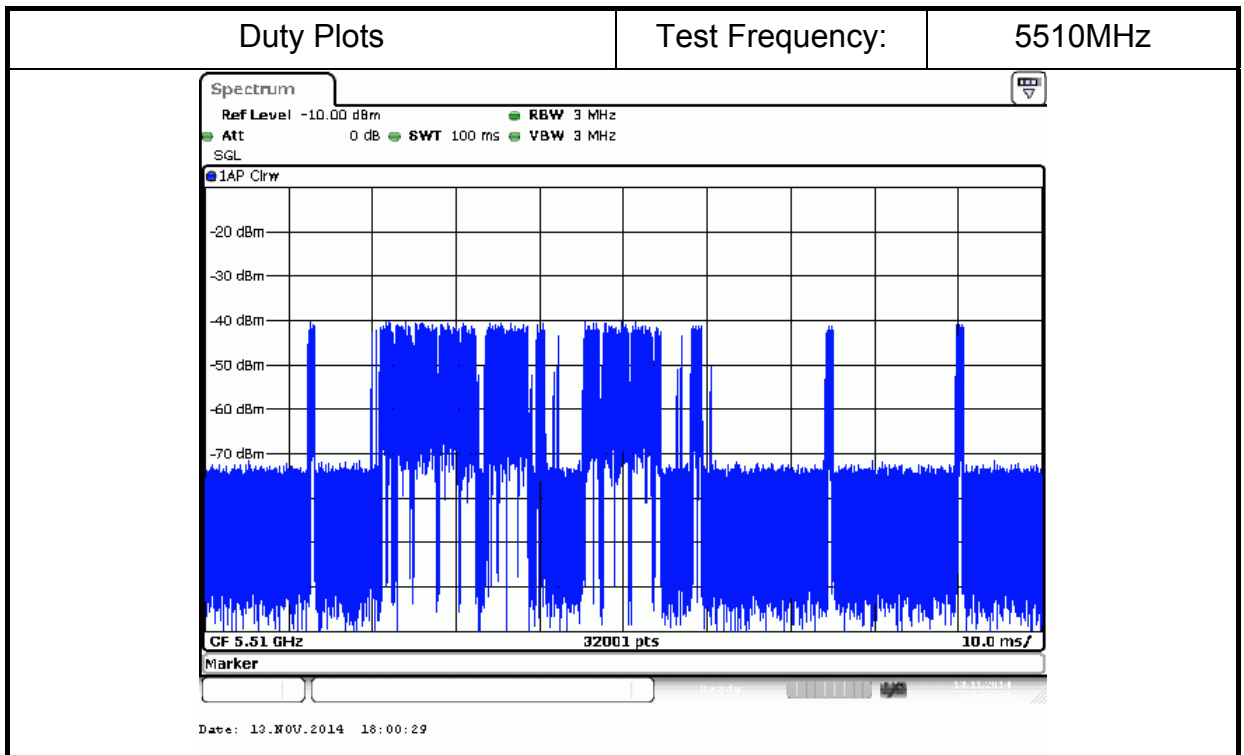
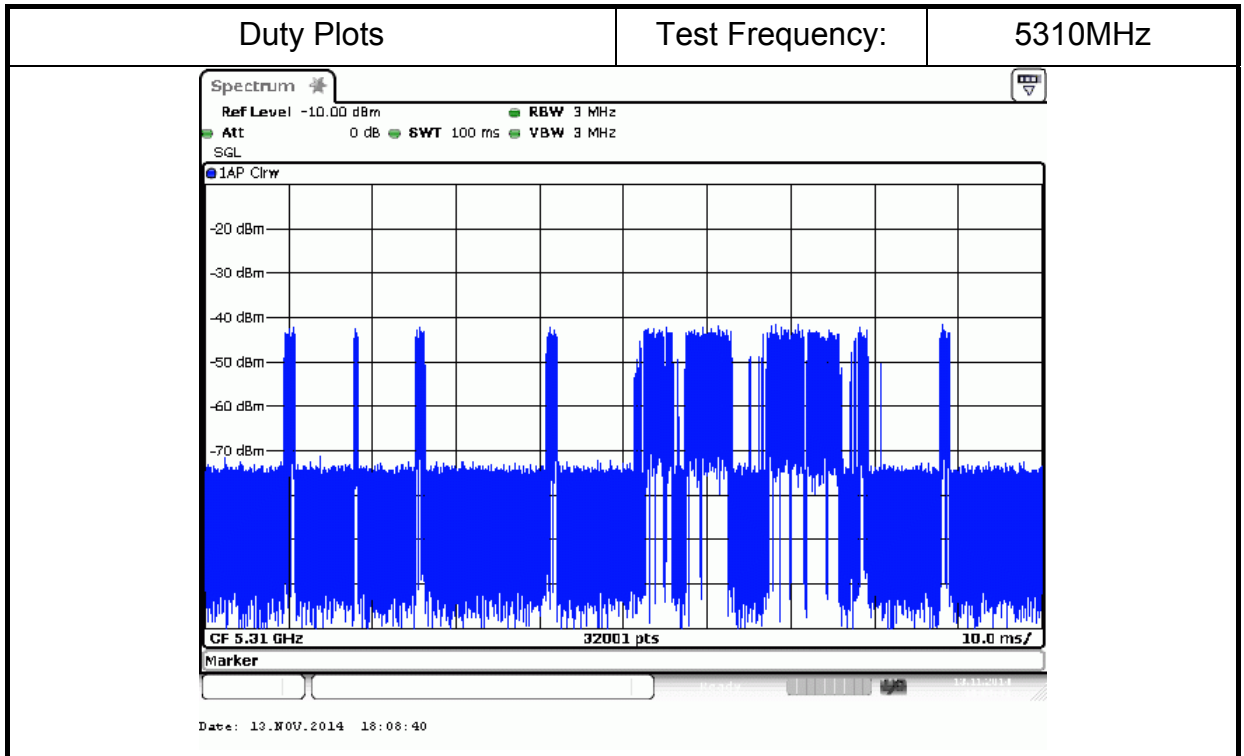



Test Result of Channel Shutdown Time Plots

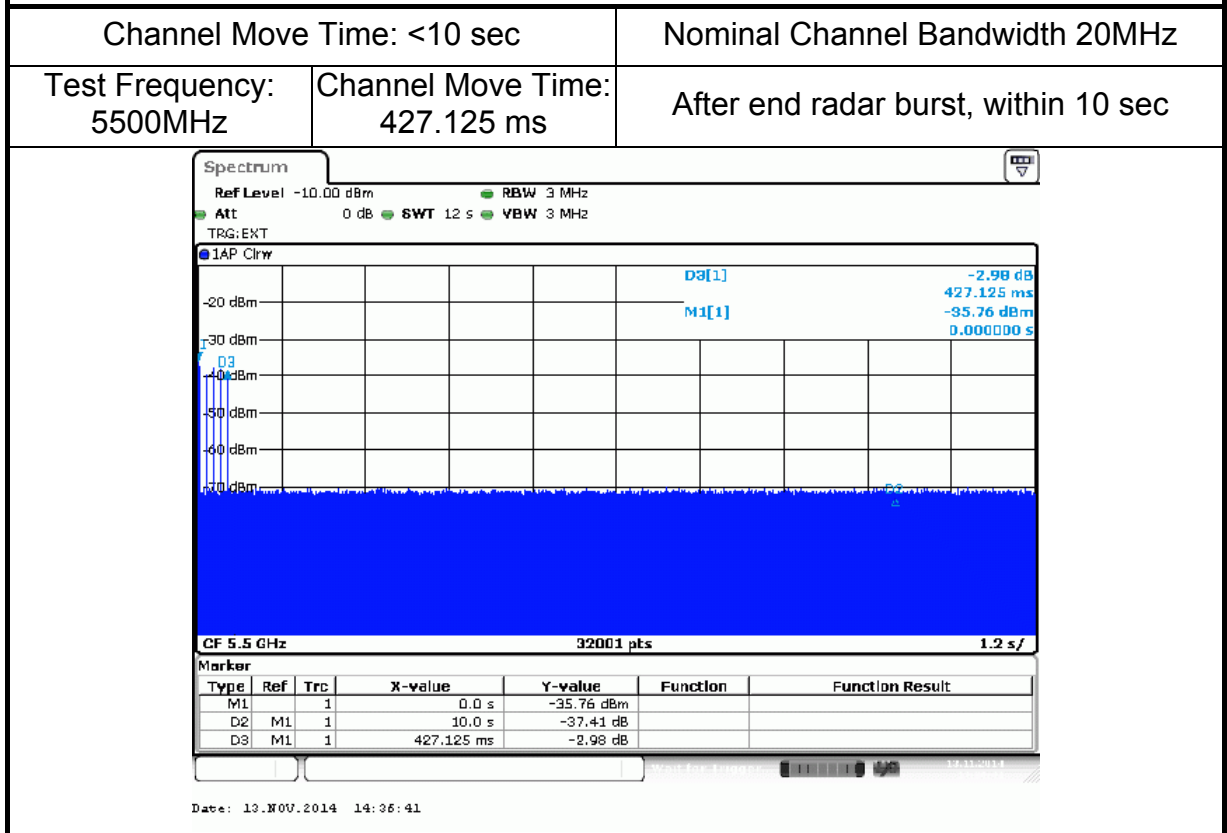
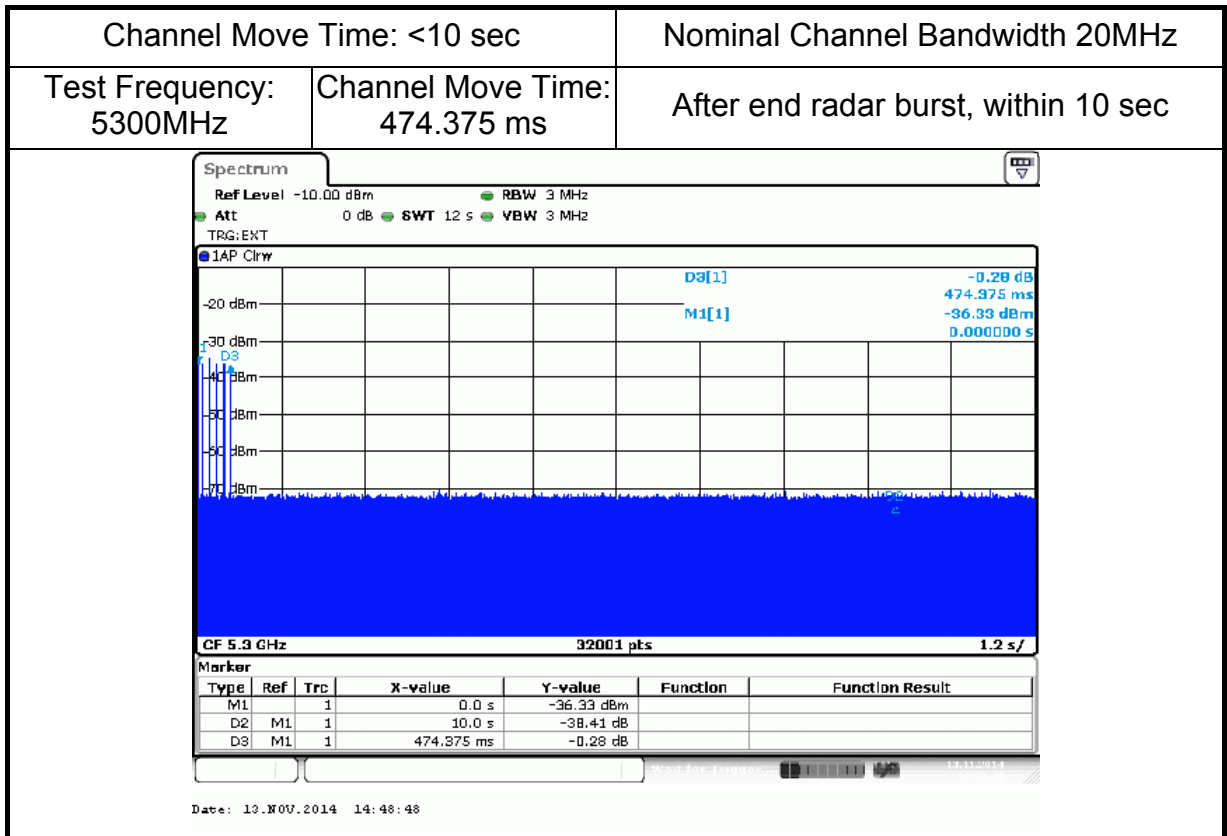

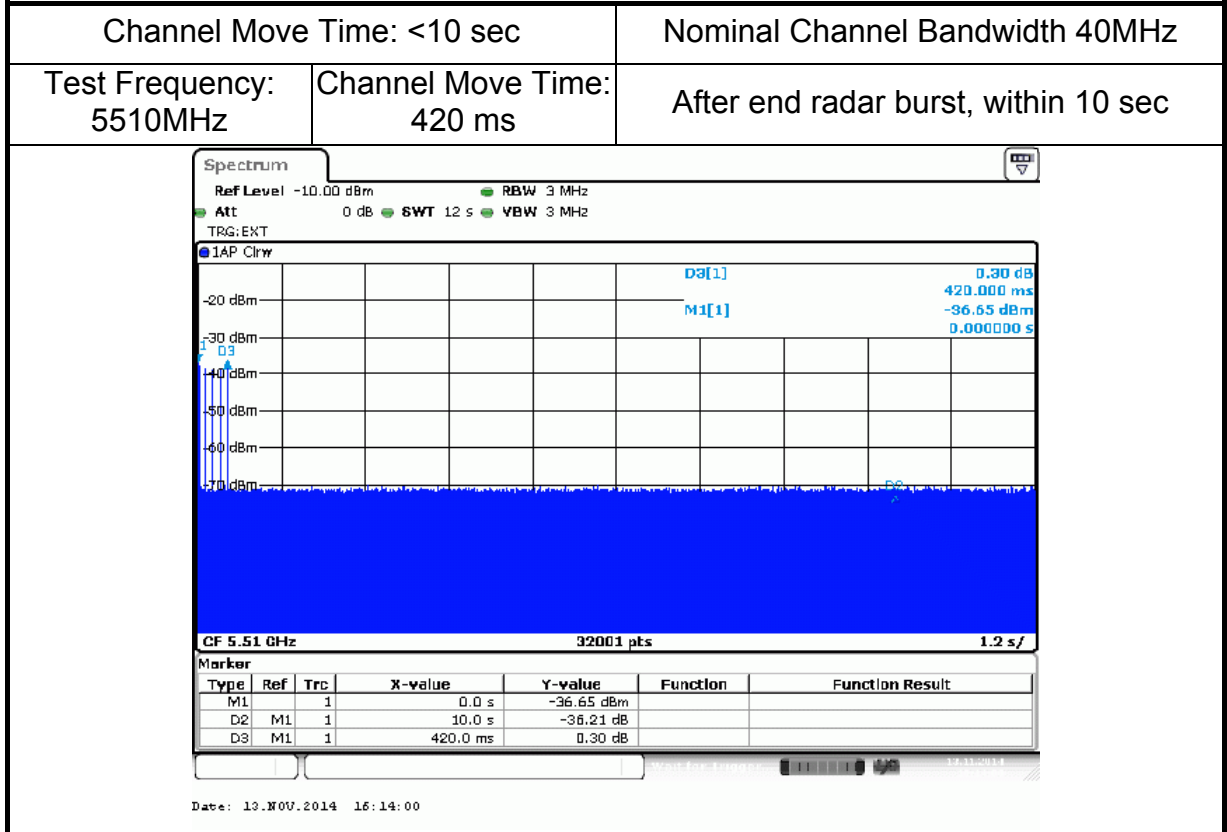
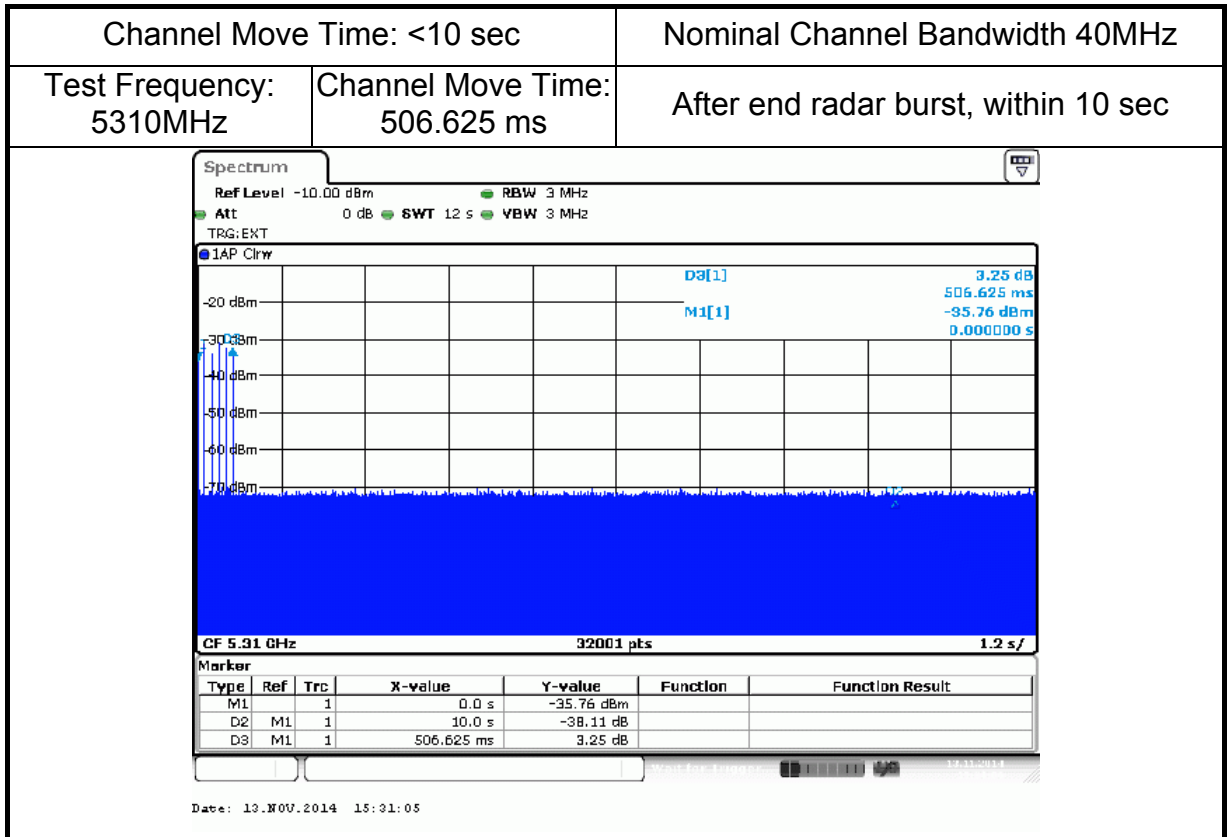

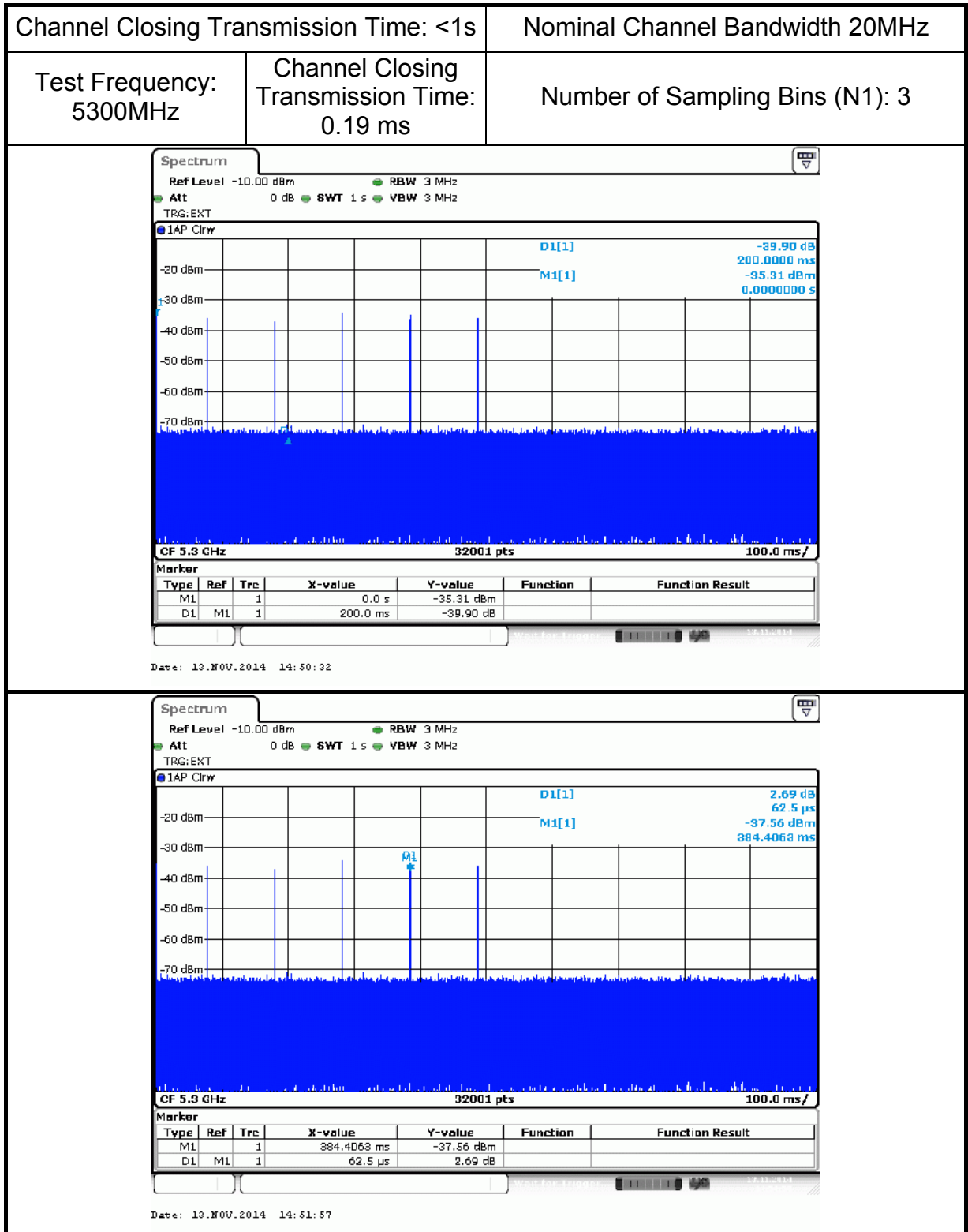

Note1: 5300 = N1 × Dwell1 = 62.5us × 3 = 0.19ms



Channel Closing Transmission Time: <1s		Nominal Channel Bandwidth 20MHz
Test Frequency: 5500MHz	Channel Closing Transmission Time: 0.56ms	Number of Sampling Bins (N1): 3

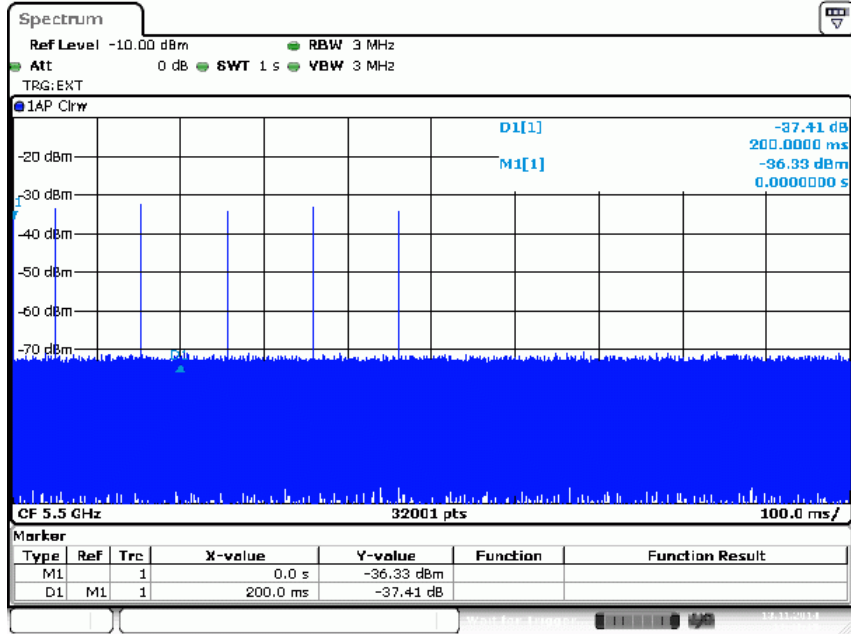

Date: 13.NOV.2014 14:41:15

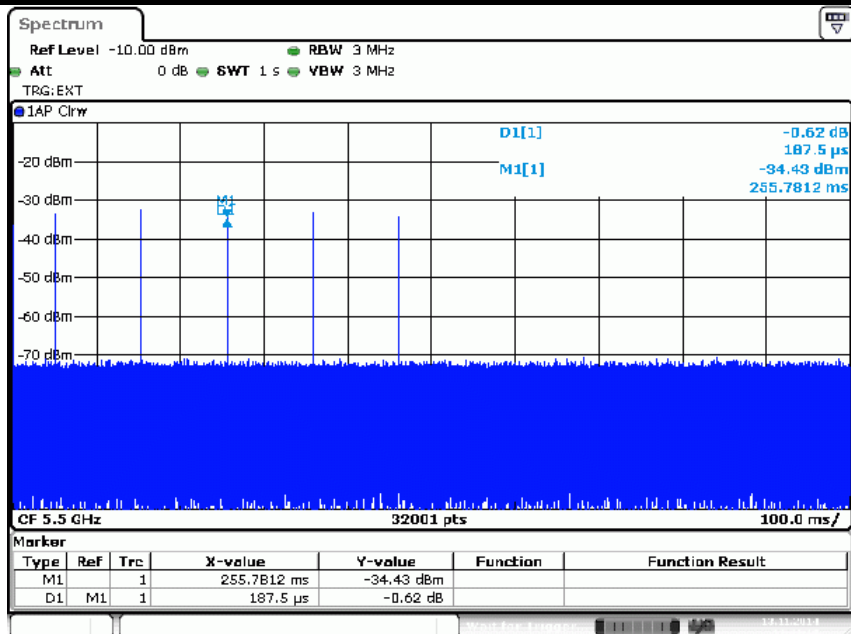

Date: 13.NOV.2014 14:43:18

Note1: 5500 = N1 × Dwell1 = 187.5us × 3 = 0.56ms



Channel Closing Transmission Time: <1s		Nominal Channel Bandwidth 40MHz
Test Frequency: 5310MHz	Channel Closing Transmission Time: 0.66ms	Number of Sampling Bins (N1): 3

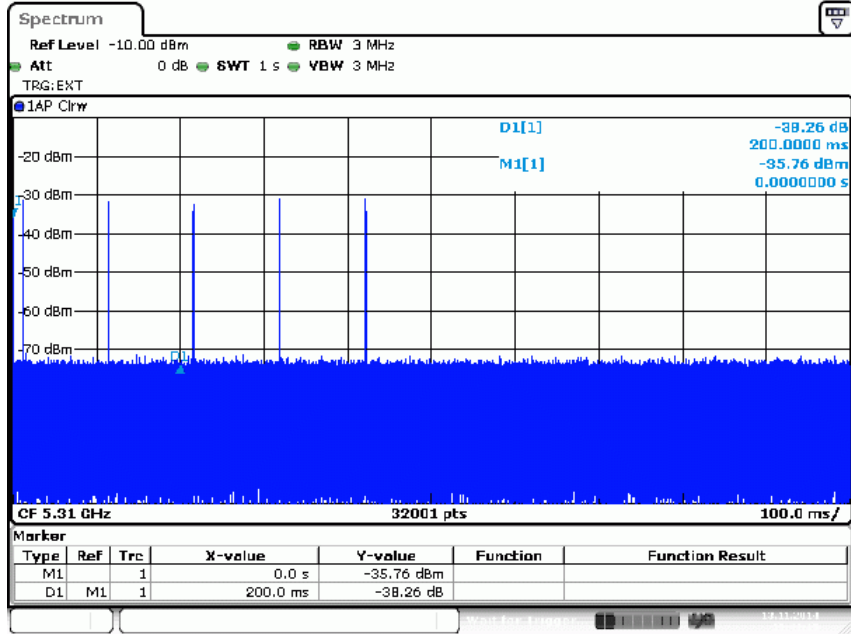

Date: 13.NOV.2014 15:43:15

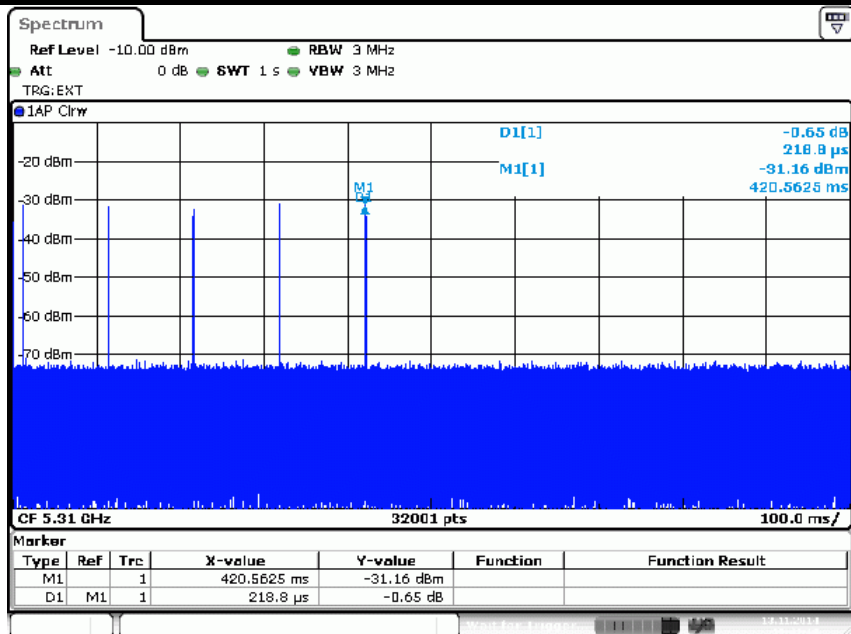

Date: 13.NOV.2014 15:44:18

Note1: 5310 = N1 × Dwell1 = 218.8us × 3 = 0.66ms



Channel Closing Transmission Time: <1s		Nominal Channel Bandwidth 40MHz
Test Frequency: 5510MHz	Channel Closing Transmission Time: 0.75ms	Number of Sampling Bins (N1): 3

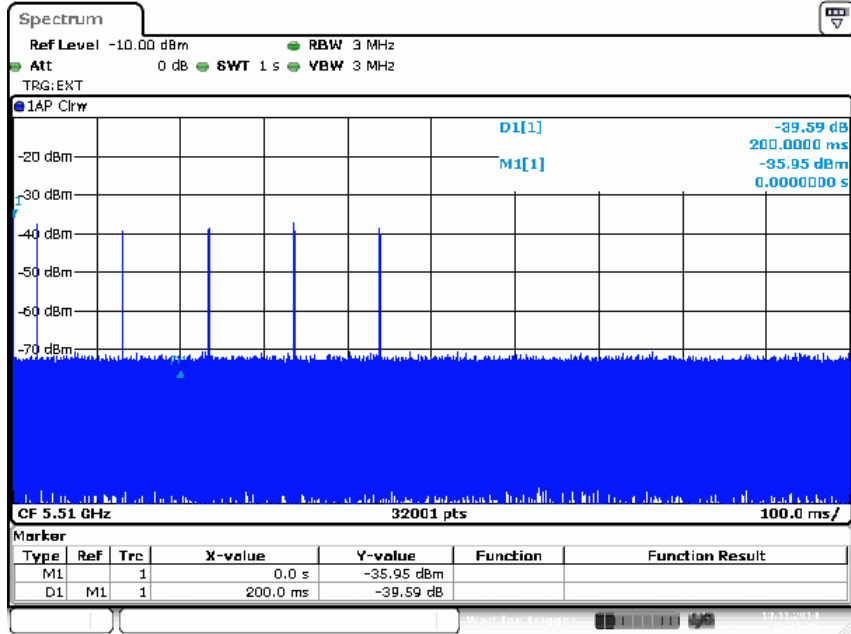

Date: 13.NOV.2014 16:16:36

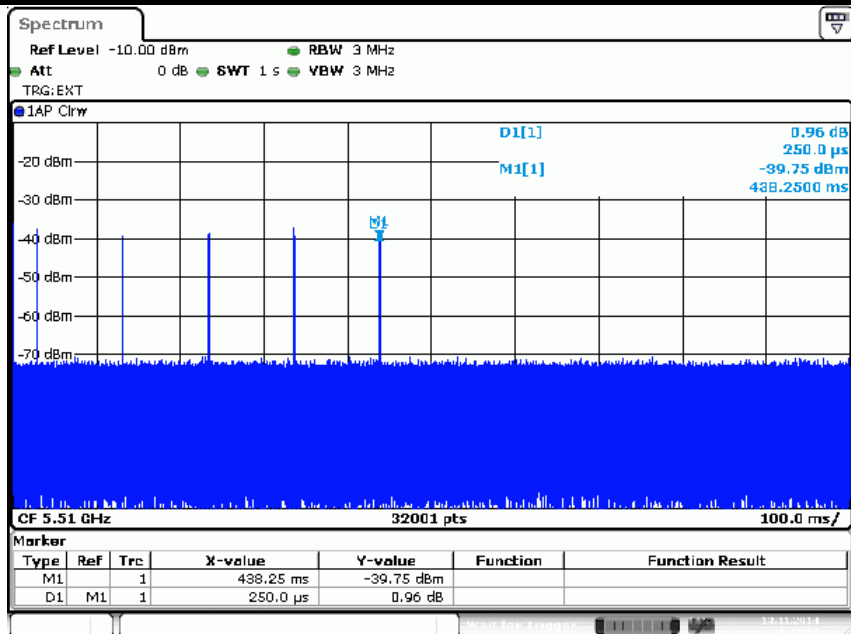

Date: 13.NOV.2014 16:17:57

Note1: 5510 = N1 × Dwell1 = 250us × 3 =0.75ms