



FCC 47 CFR PART 15 SUBPART C

TEST REPORT

For

Computer

Model: TREK-520; TREK-520XXXXXXXXXXXXXXXXXXXX;

TREK520XXXXXXXXXXXXXXXXXXXX

(where "X" may be any alphanumeric character, "-", "_" or blank)

Trade Name: ADVANTECH

Issued to

Advantech Co. Ltd.

**No.1, Alley 20, Lane 26, Rueiguang Road, Neihu District, Taipei 114,
Taiwan, R.O.C.**

Issued by

Compliance Certification Services Inc.

**No.81-1, Lane 210, Bade 2nd Rd., Lujhu Township,
Taoyuan County 33841, Taiwan, R.O.C.**

TEL: 886-3-324-0332

FAX: 886-3-324-5235

<http://www.ccsrf.com>

service@ccsrf.com



Note: This report shall not be reproduced except in full, without the written approval of Compliance Certification Services Inc. This document may be altered or revised by Compliance Certification Services Inc. personnel only, and shall be noted in the revision section of the document. The client should not use it to claim product endorsement by TAF, A2LA, NIST or any government agencies. The test results in the report only apply to the tested sample.



Revision History

Rev.	Issue Date	Revisions	Effect Page	Revised By
00	October 30, 2013	Initial Issue	All	Iren Wang



TABLE OF CONTENTS

1. TEST RESULT CERTIFICATION	4
2. EUT DESCRIPTION	5
3. TEST METHODOLOGY	6
3.1 EUT CONFIGURATION	6
3.2 EUT EXERCISE	6
3.3 GENERAL TEST PROCEDURES	6
3.4 FCC PART 15.205 RESTRICTED BANDS OF OPERATIONS	7
3.5 DESCRIPTION OF TEST MODES	8
4. INSTRUMENT CALIBRATION	9
4.1 MEASURING INSTRUMENT CALIBRATION	9
4.2 MEASUREMENT EQUIPMENT USED	9
4.3 MEASUREMENT UNCERTAINTY	10
5. FACILITIES AND ACCREDITATIONS	11
5.1 FACILITIES	11
5.2 EQUIPMENT	11
5.3 TABLE OF ACCREDITATIONS AND LISTINGS	12
6. SETUP OF EQUIPMENT UNDER TEST	13
6.1 SETUP CONFIGURATION OF EUT	13
6.2 SUPPORT EQUIPMENT	13
7. FCC PART 15.247 REQUIREMENTS	14
7.1 6dB BANDWIDTH	14
7.2 PEAK POWER	21
7.3 AVERAGE POWER	23
7.4 BAND EDGES MEASUREMENT	25
7.5 PEAK POWER SPECTRAL DENSITY	38
7.6 SPURIOUS EMISSIONS	45
7.7 POWERLINE CONDUCTED EMISSIONS	68
8. APPENDIX I PHOTOGRAPHS OF TEST SETUP	69
APPENDIX 1: PHOTOGRAPHS OF EUT	72



1. TEST RESULT CERTIFICATION

Applicant: **Advantech Co. Ltd.**
No.1, Alley 20, Lane 26, Rueiguang Road, Neihu District,
Taipei 114, Taiwan, R.O.C.

Manufacturer: **Advantech Co. Ltd.**
No.1, Alley 20, Lane 26, Rueiguang Road, Neihu District,
Taipei 114, Taiwan, R.O.C.

Product: Computer

Trade Name: ADVANTECH

Model Number: TREK-520; TREK-520XXXXXXXXXXXXXXXXXXXX;
TREK520XXXXXXXXXXXXXXXXXXXX (where "X" may be any
alphanumeric character, "-", "_ " or blank)

Date of Test: October 27 ~ 30, 2013

APPLICABLE STANDARDS	
STANDARD	TEST RESULT
FCC 47 CFR Part 15 Subpart C	No non-compliance noted

We hereby certify that:

The above equipment was tested by Compliance Certification Services Inc. The test data, data evaluation, test procedures, and equipment configurations shown in this report were made in accordance with the procedures given in ANSI C63.4 and the energy emitted by the sample EUT tested as described in this report is in compliance with the requirements of FCC Rules Part 15.207, 15.209, 15.247.

The test results of this report relate only to the tested sample EUT identified in this report.

Approved by:

Reviewed by:

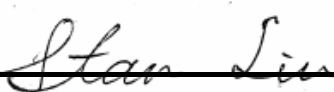

Stan Lin
Section Manager

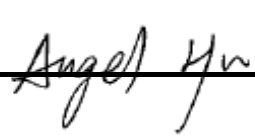

Angel Hu
Section Manager



2. EUT DESCRIPTION

Product	Computer		
Trade Name	ADVANTECH		
Model Number	TREK-520; TREK-520XXXXXXXXXXXXXXXXXX; TREK520XXXXXXXXXXXXXXXXXX (where "X" may be any alphanumeric character, "-", "_ " or blank)		
Model Discrepancy	N/A		
EUT Power Rating	12-32VDC		
RF Module Manufacturer	JORJIN Technology(S)	Model	WG7311-EA
Operating Frequency Range	IEEE 802.11 b/g/HT20 mode: 2412 ~ 2462 MHz		
Transmit Power	IEEE 802.11b mode: 20.15 dBm (0.1035 W) IEEE 802.11g mode: 22.33 dBm (0.1710 W) IEEE 802.11n HT20 mode: 22.25 dBm (0.1679 W)		
Modulation Technique	IEEE 802.11b mode: DSSS (1, 2, 5.5 and 11 Mbps) IEEE 802.11g mode: OFDM (6, 9, 12, 18, 24, 36, 48 and 54 Mbps) IEEE 802.11n HT20 mode: OFDM (6.5, 7.2, 13, 14.4, 14.44, 19.5, 21.7, 26, 28.89, 28.9, 39, 43.3, 43.33 52, 57.78, 57.8, 58.5, 65.0, 72.2, 78, 86.67, 104, 115.56, 117, 130, 144.44 Mbps)		
Number of Channels	IEEE 802.11b/g mode: 11 Channels IEEE 802.11n HT20 mode: 11 Channels		
Antenna Specification	Dipole Antenna / Gain: -3.03dBi		

Remark:

1. The sample selected for test was production product and was provided by manufacturer.
2. This submittal(s) (test report) is intended for FCC ID: **M82-TREK520** filing to comply with Section 15.207, 15.209 and 15.247 of the FCC Part 15, Subpart C Rules.



3. TEST METHODOLOGY

The tests documented in this report were performed in accordance with ANSI C63.4 and FCC CFR 47 Part 2, Part 15.207, 15.209 and 15.247.

3.1 EUT CONFIGURATION

The EUT configuration for testing is installed on RF field strength measurement to meet the Commissions requirement and operating in a manner that intends to maximize its emission characteristics in a continuous normal application.

3.2 EUT EXERCISE

The EUT was operated in the engineering mode to fix the TX frequency that was for the purpose of the measurements.

According to its specifications, the EUT must comply with the requirements of the Section 15.207, 15.209 and 15.247 under the FCC Rules Part 15 Subpart C.

3.3 GENERAL TEST PROCEDURES

Conducted Emissions

The EUT is placed on the turntable, which is 0.8 m above ground plane. According to the requirements in Section 13.1.4.1 of ANSI C63.4 Conducted emissions from the EUT measured in the frequency range between 0.15 MHz and 30MHz using CISPR Quasi-peak and average detector modes.

Radiated Emissions

The EUT is placed on a turn table, which is 0.8 m above ground plane. The turntable shall rotate 360 degrees to determine the position of maximum emission level. EUT is set 3m away from the receiving antenna, which varied from 1m to 4m to find out the highest emission. And also, each emission was to be maximized by changing the polarization of receiving antenna both horizontal and vertical. In order to find out the maximum emissions, exploratory radiated emission measurements were made according to the requirements in Section 13.1.4.1 of ANSI C63.4..



3.4 FCC PART 15.205 RESTRICTED BANDS OF OPERATIONS

(a) Except as shown in paragraph (d) of this section, only spurious emissions are permitted in any of the frequency bands listed below:

MHz	MHz	MHz	GHz
0.090 - 0.110	16.42 - 16.423	399.9 - 410	4.5 - 5.15
¹ 0.495 - 0.505	16.69475 - 16.69525	608 - 614	5.35 - 5.46
2.1735 - 2.1905	16.80425 - 16.80475	960 - 1240	7.25 - 7.75
4.125 - 4.128	25.5 - 25.67	1300 - 1427	8.025 - 8.5
4.17725 - 4.17775	37.5 - 38.25	1435 - 1626.5	9.0 - 9.2
4.20725 - 4.20775	73 - 74.6	1645.5 - 1646.5	9.3 - 9.5
6.215 - 6.218	74.8 - 75.2	1660 - 1710	10.6 - 12.7
6.26775 - 6.26825	108 - 121.94	1718.8 - 1722.2	13.25 - 13.4
6.31175 - 6.31225	123 - 138	2200 - 2300	14.47 - 14.5
8.291 - 8.294	149.9 - 150.05	2310 - 2390	15.35 - 16.2
8.362 - 8.366	156.52475 -	2483.5 - 2500	17.7 - 21.4
8.37625 - 8.38675	156.52525	2655 - 2900	22.01 - 23.12
8.41425 - 8.41475	156.7 - 156.9	3260 - 3267	23.6 - 24.0
12.29 - 12.293	162.0125 - 167.17	3332 - 3339	31.2 - 31.8
12.51975 - 12.52025	167.72 - 173.2	3345.8 - 3358	36.43 - 36.5
12.57675 - 12.57725	240 - 285	3600 - 4400	(²)
13.36 - 13.41	322 - 335.4		

¹ Until February 1, 1999, this restricted band shall be 0.490-0.510 MHz.

² Above 38.6

(b) Except as provided in paragraphs (d) and (e), the field strength of emissions appearing within these frequency bands shall not exceed the limits shown in Section 15.209. At frequencies equal to or less than 1000 MHz, compliance with the limits in Section 15.209 shall be demonstrated using measurement instrumentation employing a CISPR quasi-peak detector. Above 1000 MHz, compliance with the emission limits in Section 15.209 shall be demonstrated based on the average value of the measured emissions. The provisions in Section 15.35 apply to these measurements.



3.5 DESCRIPTION OF TEST MODES

The EUT (model: TREK-520) had been tested under operating condition.

Software used to control the EUT for staying in continuous transmitting mode was programmed.

The worst case data rate is determined as the data rate with highest output power. After verification, all tests were carried out with the worst case test modes as shown below except radiated spurious emission below 1GHz, which worst case was in normal link mode only.

IEEE 802.11b:

Channel Low (2412MHz), Channel Mid (2437MHz) and Channel High (2462MHz) with 1Mbps data rate was chosen for full testing.

IEEE 802.11g:

Channel Low (2412MHz), Channel Mid (2437MHz) and Channel High (2462MHz) with 6Mbps data rate was chosen for full testing.

IEEE 802.11n HT20:

Channel Low (2412MHz), Channel Mid (2437MHz) and Channel High (2462MHz) with 6.5Mbps data rate were chosen for full testing.



4. INSTRUMENT CALIBRATION

4.1 MEASURING INSTRUMENT CALIBRATION

The measuring equipment, which was utilized in performing the tests documented herein, has been calibrated in accordance with the manufacturer's recommendations for utilizing calibration equipment, which is traceable to recognized national standards.

4.2 MEASUREMENT EQUIPMENT USED

Equipment Used for Emissions Measurement

Remark: Each piece of equipment is scheduled for calibration once a year and Loop Antenna is scheduled for calibration once three years.

Conducted Emissions Test Site				
Name of Equipment	Manufacturer	Model	Serial Number	Calibration Due
Spectrum Analyzer	Agilent	E4446A	MY48250064	01/13/2014
Spectrum Analyzer	Agilent	N9010A	MY52220817	02/22/2014
Power meter	Anritsu	ML2495A	1033009	09/29/2014
Power Sensor	Anritsu	MA2411B	0917221	09/29/2014

3M Semi Anechoic Chamber				
Name of Equipment	Manufacturer	Model	Serial Number	Calibration Due
Spectrum Analyzer	Agilent	E4446A	MY48250064	01/13/2014
Pre-Amplifier	HP	8447D	2944A06530	04/23/2014
Pre-Amplifier	EMEC	EM01M26G	060570	07/25/2014
Pre-Amplifier	MITEQ	AMF-6F-26040 0-40-8P	985646	08/08/2014
Pre-Amplifier	Agilent	8449B	3008A01738	04/23/2014
EMI Test Receiver	SCHAFFNER	SCR 3501	430	03/24/2014
Loop Antenna	EMCO	6502	2356	06/12/2014
Bilog Antenna	TESEQ	CBL 6112D	35378	09/11/2014
Horn Antenna	EMCO	3115	00022250	08/04/2014
Horn Antenna	EMCO	3116	00026370	01/07/2014
Antenna Tower	CCS	CC-A-1F	N/A	N.C.R
Test S/W	EZ-EMC			

NOTE: 1. The calibration interval of the above test instruments is 12 months and the calibrations are traceable to NML/ROC and NIST/USA.
2. N.C.R = No Calibration Request.



4.3 MEASUREMENT UNCERTAINTY

Parameter	Uncertainty
Powerline Conducted Emission	N/A
3M Semi Anechoic Chamber / 30MHz ~ 200MHz	±3.5921
3M Semi Anechoic Chamber / 200MHz ~ 1GHz	±3.5657
3M Semi Anechoic Chamber / 1 ~ 8GHz	±2.5873
3M Semi Anechoic Chamber / 8 ~ 18GHz	±2.6646
3M Semi Anechoic Chamber / 18 ~ 26GHz	±2.9617
3M Semi Anechoic Chamber / 26 ~ 40GHz	±3.4250

Remark: This uncertainty represents an expanded uncertainty expressed at approximately the 95% confidence level using a coverage factor of $k=2$.



5. FACILITIES AND ACCREDITATIONS

5.1 FACILITIES

All measurement facilities used to collect the measurement data are located at

- No. 163-1, Jhongsheng Rd., Sindien District, Taipei City 23151, Taiwan
Tel: 886-2-2217-0894 / Fax: 886-2-2217-1029
- No 11, Wugong 6th Rd, Wugu District, New Taipei City 24891, Taiwan (R.O.C)
Tel: 886-2-2299-9720 / Fax: 886-2-2298-4045
- No.81-1, Lane 210, Bade 2nd Rd., Lujhu Township, Taoyuan County 33841, Taiwan
Tel: 886-3-324-0332 / Fax: 886-3-324-5235

The sites are constructed in conformance with the requirements of ANSI C63.7, ANSI C63.4 and CISPR Publication 22.

5.2 EQUIPMENT

Radiated emissions are measured with one or more of the following types of linearly polarized antennas: tuned dipole, biconical, log periodic, bi-log, and/or ridged waveguide, horn. Spectrum analyzers with pre-selectors and quasi-peak detectors are used to perform radiated measurements.





Conducted emissions are measured with Line Impedance Stabilization Networks and EMI Test Receivers.

Calibrated wideband preamplifiers, coaxial cables, and coaxial attenuators are also used for making measurements.

All receiving equipment conforms to CISPR Publication 16-1, "Radio Interference Measuring Apparatus and Measurement Methods."



5.3 TABLE OF ACCREDITATIONS AND LISTINGS

Country	Agency	Scope of Accreditation	Logo
USA	A2LA	CFR 47, FCC Part15/18, CISPR 22, EN 55022, ICES-003, AS/NZS CISPR 22, VCCI V-3, EN 55011, CISPR 11, IEC/EN 61000-4-2/3/4/5/6/8/11, EN 61000-6-1/2/3/4, EN 55024, CISPR 24, AS/NZS CISPR 24, AS/NZS 61000.6.2, EN 55014-1/-2, ETSI EN 300 386 v1.3.2/v1.3.3, IEC/EN 61000-3-2, AS/NZS 61000.3.2, IEC/EN 61000-3-3, AS/NZS 61000.3.3	 TESTING CERT #0824.01
USA	FCC MRA	3 meter Open Area Test Sites to perform FCC Part 15/18 measurements	
Japan	VCCI	3/10 meter Open Area Test Sites and conducted test sites to perform radiated/conducted measurements	VCCI R-2882/2541/2798/725/1868 C-402/747/912 T-1930/1646
Taiwan	TAF	EN 55014-1, CISPR 14, CNS 13781-1, EN 55013, CISPR 13, CNS 13439, EN 55011, CISPR 11, CNS 13803, PLMN09, IS2045-0, LP0002 FCC Part 27/90, Part 15B/C/D/E, RSS-192/193/210/310 ETSI EN 300 328/ 300 220-1/ 300 220-2/ 301 893/ 301 489-01/ 301 489-03/ 301 489-07 / 301 489-17/ 300 440-1/ 300 440-2 AS/NZS 4268, AS/NZS 4771 CISPR 22, EN 55022, CNS 13438, AS/NZS CISPR 22, VCCI, IEC/EN 61000-4-2/3/4/5/6/8/11, CNS 14676-2/3/4/5/6/8, CNS 14934-2/3, CNS 13783-1, CNS 13439, CNS 13803	
Taiwan	BSMI	CNS 13438, CNS 13783-1, CNS 13439, CNS 14115	SL2-IS-E-0014 / IN-E-0014 /A1-E-0014 /R1-E-0014 /R2-E-0014 /L1-E-0014
Canada	Industry Canada	RSS-Gen Issue 3	

Note: No part of this report may be used to claim or imply product endorsement by A2LA, TAF or other government agency.



6. SETUP OF EQUIPMENT UNDER TEST

6.1 SETUP CONFIGURATION OF EUT

See test photographs attached in Appendix 1 for the actual connections between EUT and support equipment.

6.2 SUPPORT EQUIPMENT

For Conducted Emissions and Radiated Emissions(Above 1GHz)

No.	Device Type	Brand	Model	Series No.	FCC ID	Data Cable	Power Cord
1	7" LCD Display	ADVANTECH	TREK-303	N/A	N/A	GPIB Cable: Shielded, 1.8m With two cores	N/A

For Radiated Emissions(Below 1GHz)

No.	Device Type	Brand	Model	Series No.	FCC ID	Data Cable	Power Cord
1	7" LCD Display	ADVANTECH	TREK-303	N/A	N/A	GPIB Cable: Shielded, 1.8m With two cores	N/A
2	Notebook Computer	TP00013A	LR-9XH2K	FCC DOC	LENOVO	USB Cable: Unshielded, 1.8m	AC I/P: Unshielded, 1.8m DC O/P: Unshielded, 1.8m with a core
3	Modem	ACEEX	DM-1414	304012261	IFAXDM1414	Unshielded, 1.8m	Shielded, 1.8m
4	Earphone	Logitech	ClearChat	N/A	N/A	Unshielded, 1.8m	N/A
5	USB Mouse	HP	MO19UCA	020440953	FCC DoC	Unshielded, 1.8m	N/A

Remark: Grounding was established in accordance with the manufacturer's requirements and conditions for the intended use.



7. FCC PART 15.247 REQUIREMENTS

7.1 6dB BANDWIDTH

LIMIT

According to §15.247(a)(2), systems using digital modulation techniques may operate in the 902 - 928 MHz, 2400 - 2483.5 MHz, and 5725 - 5850 MHz bands. The minimum 6 dB bandwidth shall be at least 500 kHz.

TEST CONFIGURATION

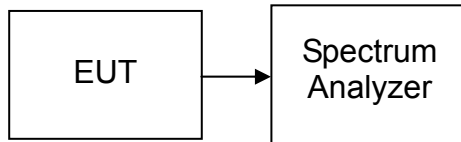

TEST PROCEDURE

1. Place the EUT on the table and set it in the transmitting mode.
2. Remove the antenna from the EUT and then connect a low loss RF cable from the antenna port to the spectrum analyzer.
3. Set the spectrum analyzer as RBW = 100kHz, VBW = 300kHz, Sweep = auto, Span = 30MHz (IEEE 802.11b, IEEE 802.11g, IEEE 802.11n HT20) or Span = 50MHz (IEEE 802.11n HT40).
4. Mark the peak frequency and -6dB (upper and lower) frequency.
5. Repeat until all the rest channels are investigated.

TEST RESULTS

No non-compliance noted



TEST DATA

Test mode: IEEE 802.11b mode

Channel	Frequency (MHz)	Bandwidth (MHz)	Limit (kHz)	Result
Low	2412	10.00	>500	PASS
Mid	2437	10.00		PASS
High	2462	10.00		PASS

Test mode: IEEE 802.11g mode

Channel	Frequency (MHz)	Bandwidth (MHz)	Limit (kHz)	Result
Low	2412	15.65	>500	PASS
Mid	2437	15.65		PASS
High	2462	15.65		PASS

Test mode: IEEE 802.11n HT20 mode

Channel	Frequency (MHz)	Bandwidth (MHz)	Limit (kHz)	Result
Low	2412	16.50	>500	PASS
Mid	2437	16.50		PASS
High	2462	16.50		PASS



Test Plot

IEEE 802.11b
6dB Bandwidth (CH Low)

Agilent

R T

Mkr1 10.00 MHz
0.17 dB

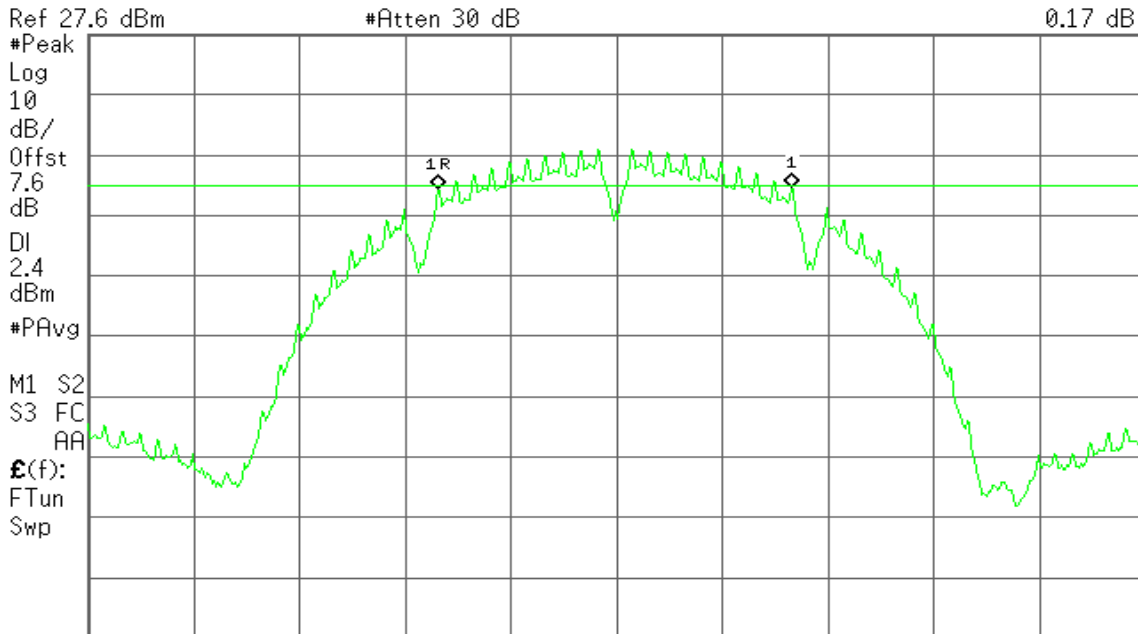

Ref 27.6 dBm #Atten 30 dB

6dB Bandwidth (CH Mid)

Agilent

R T

Mkr1 10.00 MHz
0.23 dB

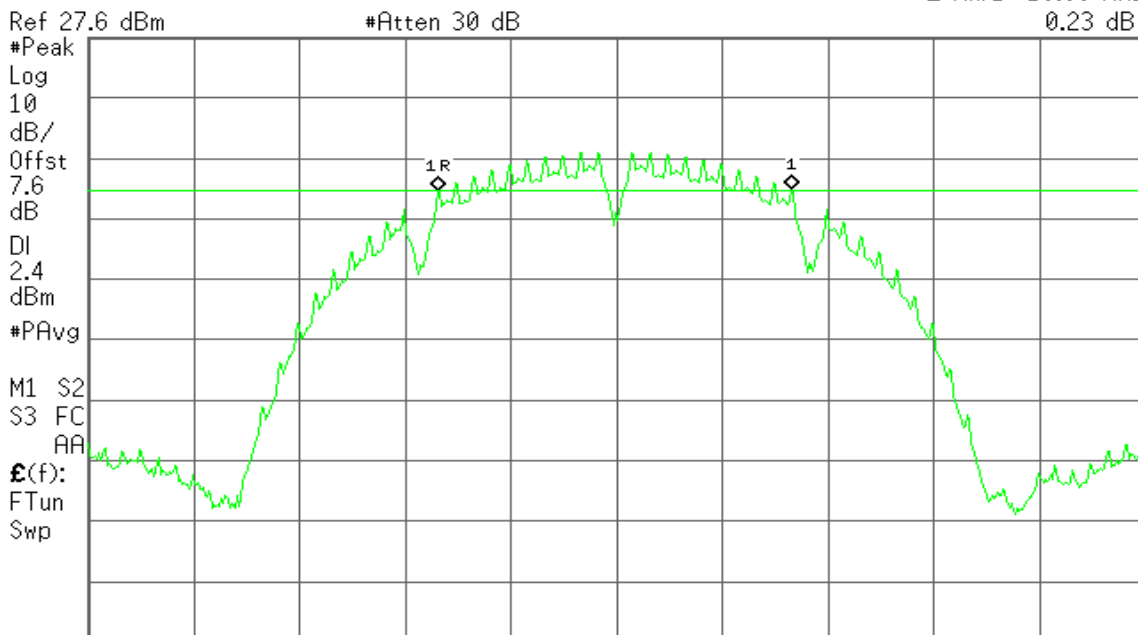

Ref 27.6 dBm #Atten 30 dB



6dB Bandwidth (CH High)

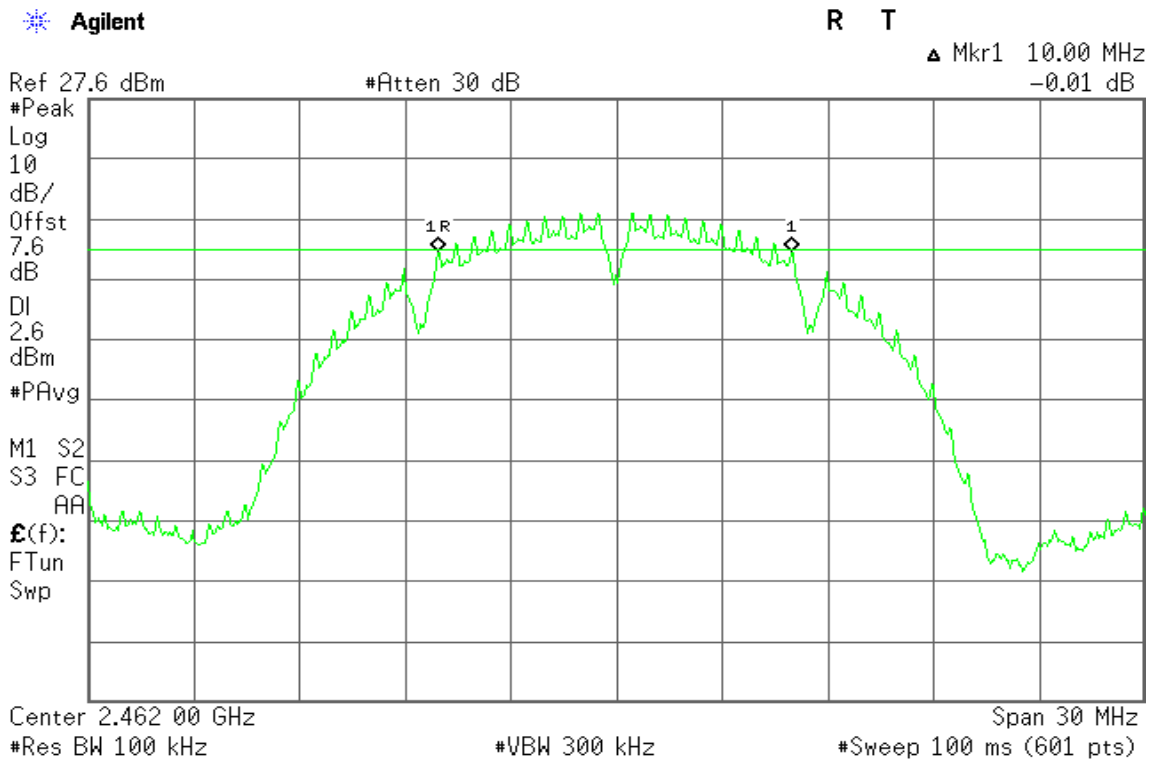

IEEE 802.11g mode

6dB Bandwidth (CH Low)

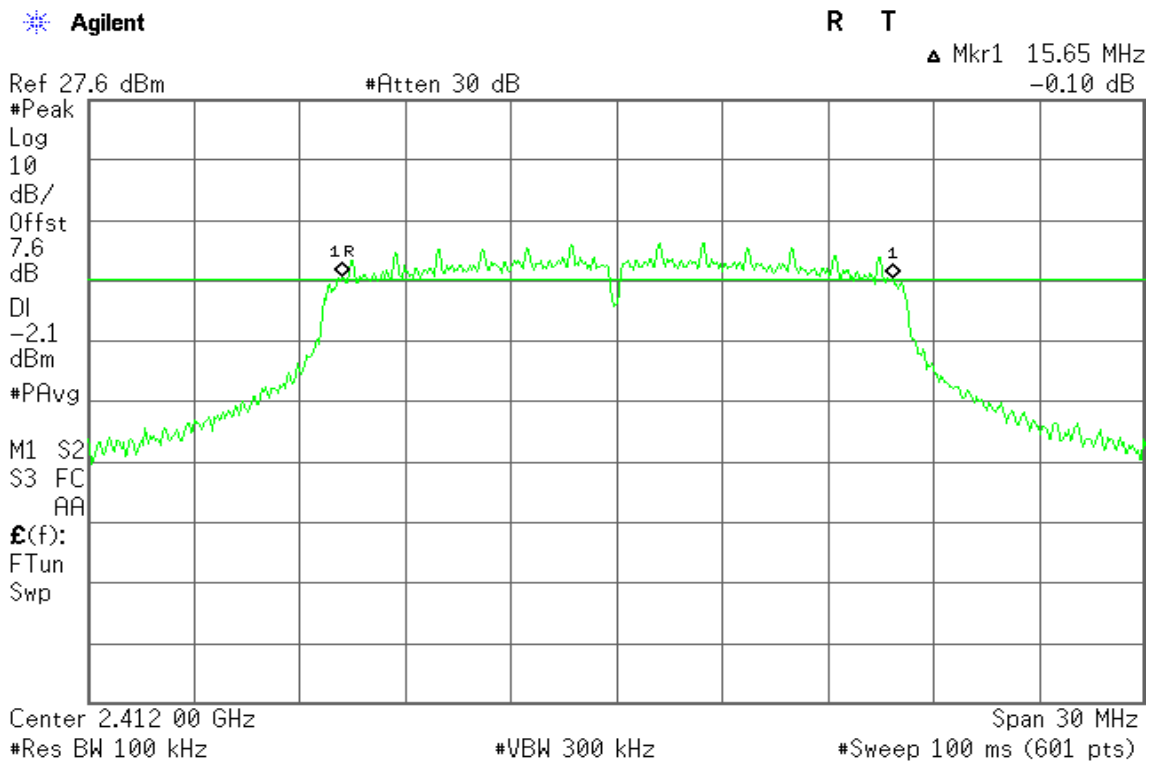



6dB Bandwidth (CH Mid)

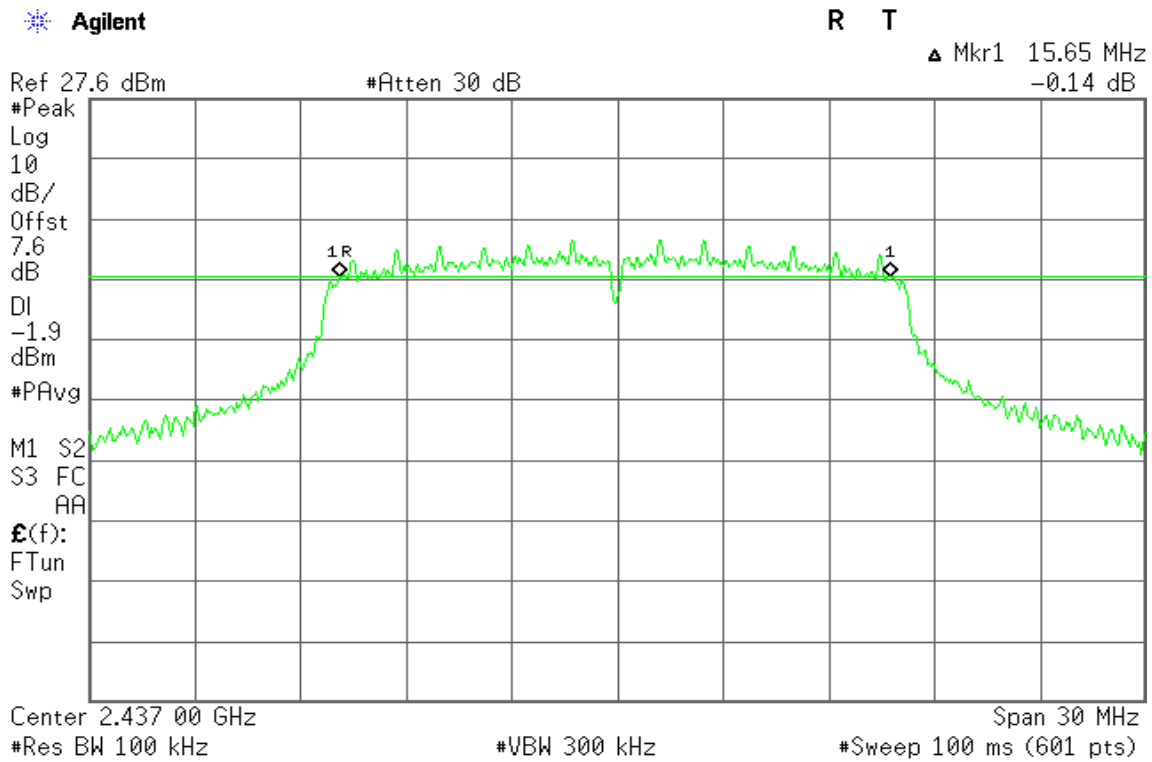

6dB Bandwidth (CH High)

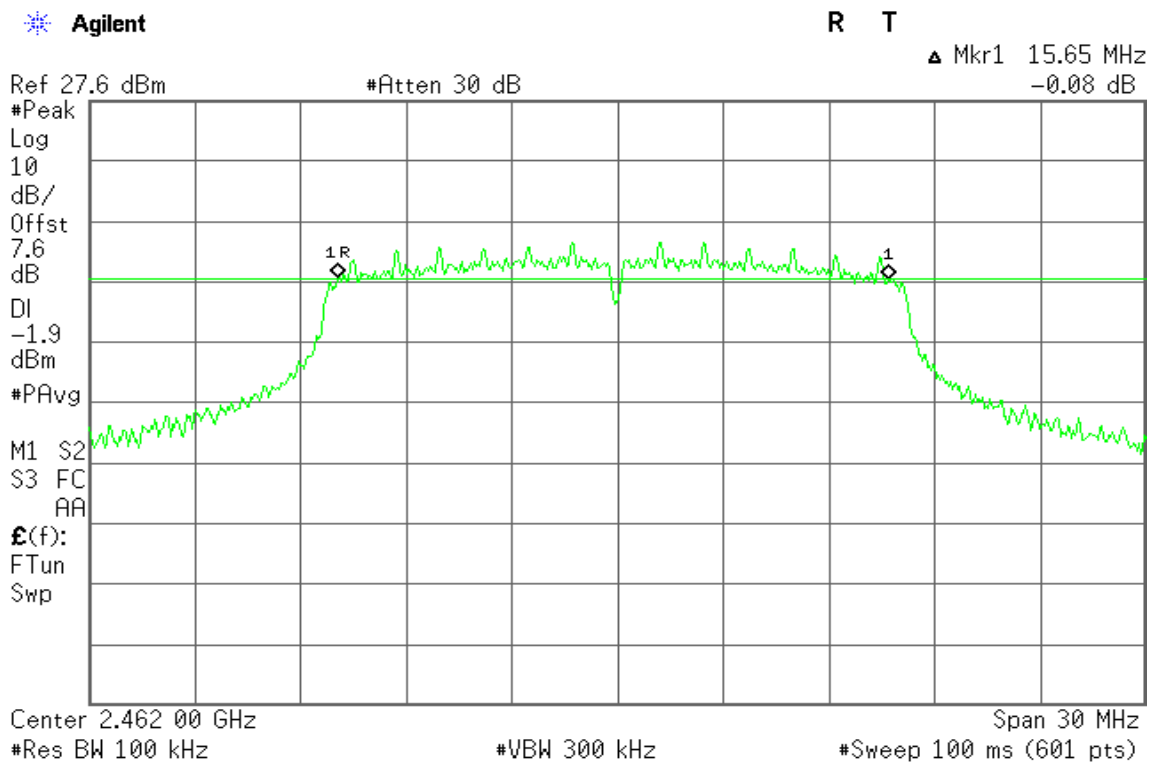



IEEE 802.11n HT20 mode

6dB Bandwidth (CH Low)

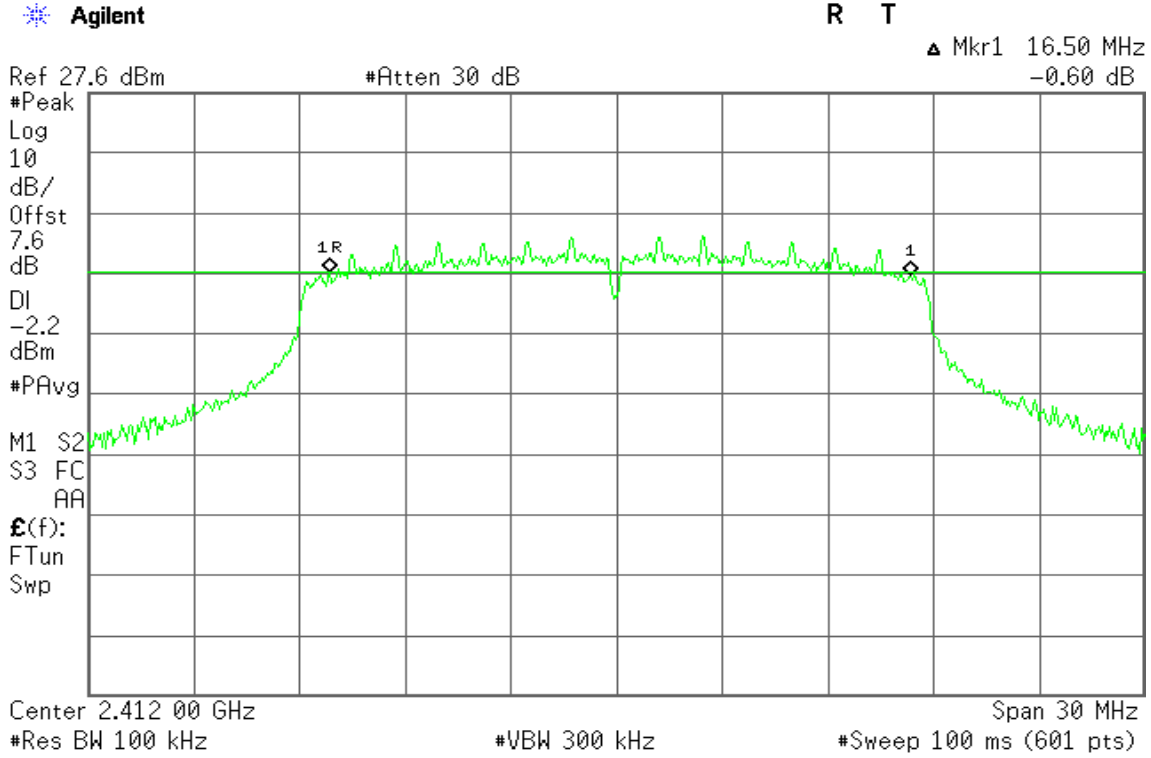

6dB Bandwidth (CH Mid)

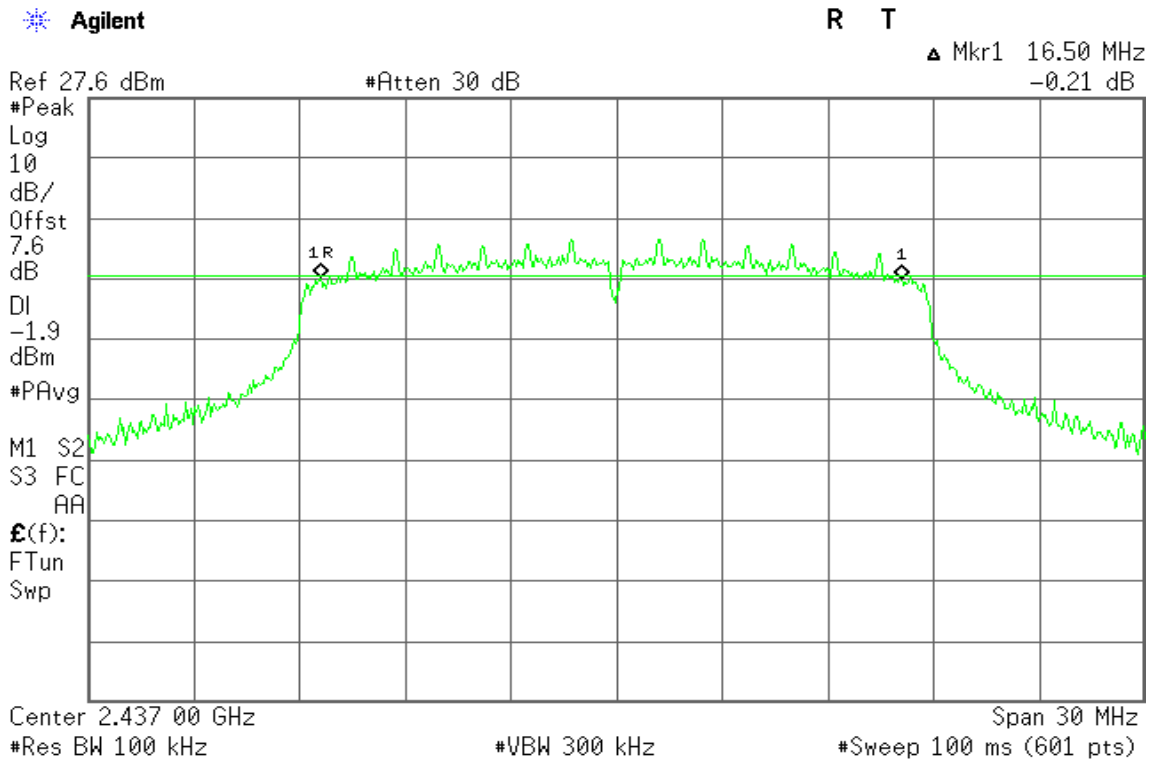



6dB Bandwidth (CH High)

Agilent

R T

Mkr1 16.50 MHz
-0.58 dB

Ref 27.6 dBm

#Atten 30 dB

#Peak

Log

10

dB/

Offst

7.6

dB

DI

-1.9

dBm

#PAvg

M1 S2

S3 FC

AA

$\mathcal{E}(f)$:

FTun

Swp

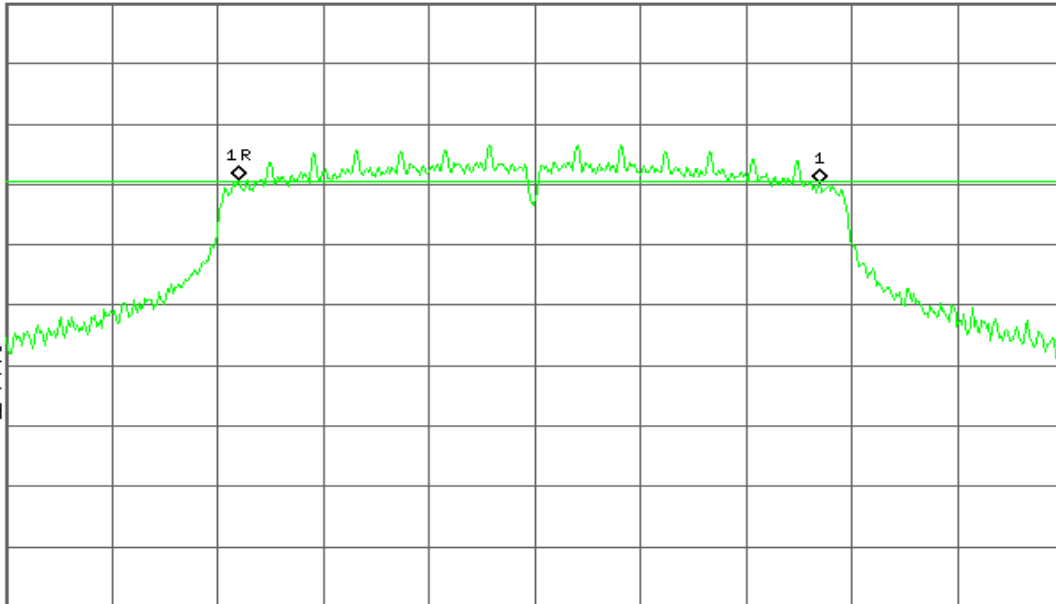

Center 2.462 00 GHz

Span 30 MHz

#Res BW 100 kHz

#VBW 300 kHz

#Sweep 100 ms (601 pts)



7.2 PEAK POWER

LIMIT

The maximum peak output power of the intentional radiator shall not exceed the following:

1. According to §15.247(b)(3), for systems using digital modulation in the bands of 902-928 MHz, 2400-2483.5 MHz, and 5725-5850 MHz: 1 Watt.
2. According to §15.247(b)(4), the conducted output power limit specified in paragraph (b) of this section is based on the use of antennas with directional gains that do not exceed 6 dBi. Except as shown in paragraph (c) of this section, if transmitting antennas of directional gain greater than 6 dBi are used, the conducted output power from the intentional radiator shall be reduced below the stated values in paragraphs (b)(1), (b)(2), and (b)(3) of this section, as appropriate, by the amount in dB that the directional gain of the antenna exceeds 6 dBi.

TEST CONFIGURATION

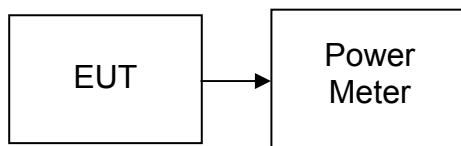

TEST PROCEDURE

Per KDB 558074 v03r01

The transmitter output is connected to the Power Meter. The Power Meter is set to the peak power detection.

TEST RESULTS

No non-compliance noted



TEST DATA

Test mode: IEEE 802.11b mode

Channel	Frequency (MHz)	Output Power (dBm)	Output Power (W)	Limit (W)	Result
Low	2412	19.75	0.0944	1.00	PASS
Mid	2437	20.09	0.1021		PASS
High	2462	20.15	0.1035		PASS

Test mode: IEEE 802.11g mode

Channel	Frequency (MHz)	Output Power (dBm)	Output Power (W)	Limit (W)	Result
Low	2412	21.99	0.1581	1.00	PASS
Mid	2437	22.33	0.1710		PASS
High	2462	22.25	0.1679		PASS

Test mode: IEEE 802.11n HT20 mode

Channel	Frequency (MHz)	Output Power (dBm)	Output Power (W)	Limit (W)	Result
Low	2412	21.88	0.1542	1.00	PASS
Mid	2437	22.25	0.1679		PASS
High	2462	22.22	0.1667		PASS



7.3 AVERAGE POWER

LIMIT

None; for reporting purposes only.

TEST CONFIGURATION

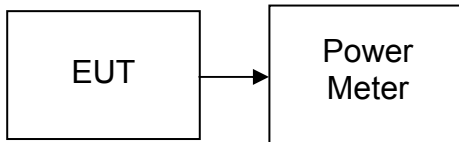

TEST PROCEDURE

Per KDB 558074 v03r01

The transmitter output is connected to the Power Meter. The Power Meter is set to the peak power detection.

TEST RESULTS

No non-compliance noted



TEST DATA

Test mode: IEEE 802.11b mode

Channel	Frequency (MHz)	Output Power (dBm)	Output Power (W)
Low	2412	16.81	0.0480
Mid	2437	17.01	0.0502
High	2462	17.07	0.0509

Test mode: IEEE 802.11g mode

Channel	Frequency (MHz)	Output Power (dBm)	Output Power (W)
Low	2412	14.61	0.0289
Mid	2437	15.00	0.0316
High	2462	14.83	0.0304

Test mode: IEEE 802.11n HT20 mode

Channel	Frequency (MHz)	Output Power (dBm)	Output Power (W)
Low	2412	14.44	0.0278
Mid	2437	14.66	0.0292
High	2462	14.53	0.0284



7.4 BAND EDGES MEASUREMENT

LIMIT

According to §15.247(d), in any 100 kHz bandwidth outside the frequency bands in which the spread spectrum intentional radiator is operating, the radio frequency power that is produced by the intentional radiator shall be at least 20 dB below that in the 100 kHz bandwidth within the band that contains the highest level of the desired power, based on either an RF conducted or a radiated measurement, provided the transmitter demonstrates compliance with the peak conducted power limits. In addition, radiated emissions which fall in the restricted bands, as defined in §15.205(a), must also comply with the radiated emission limits specified in 15.209(a) (see Section 15.205(c)).

TEST CONFIGURATION

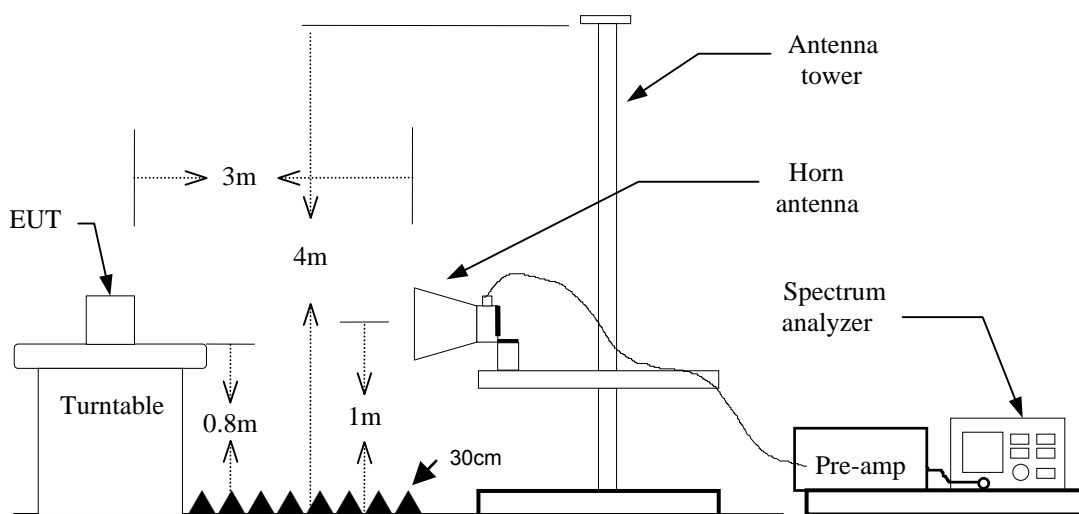

TEST PROCEDURE

1. The EUT is placed on a turntable, which is 0.8m above the ground plane.
2. The turntable shall be rotated for 360 degrees to determine the position of maximum emission level.
3. EUT is set 3m away from the receiving antenna, which is varied from 1m to 4m to find out the highest emission.
4. Set the spectrum analyzer in the following setting in order to capture the lower and upper band-edges of the emission:
 - (a) PEAK:RBW=1MHz VBW=RBW*3 / Sweep=100ms
 - (b) AVERAGE: RBW=1MHz / VBW=300Hz / Sweep=AUTO
5. Repeat the procedures until all the PEAK and AVERAGE versus POLARIZATION are measured.

TEST RESULTS

Refer to attach spectrum analyzer data chart.



Test Plot

Band Edges (IEEE 802.11b mode / CH Low)

Detector mode: Peak

Polarity: Vertical

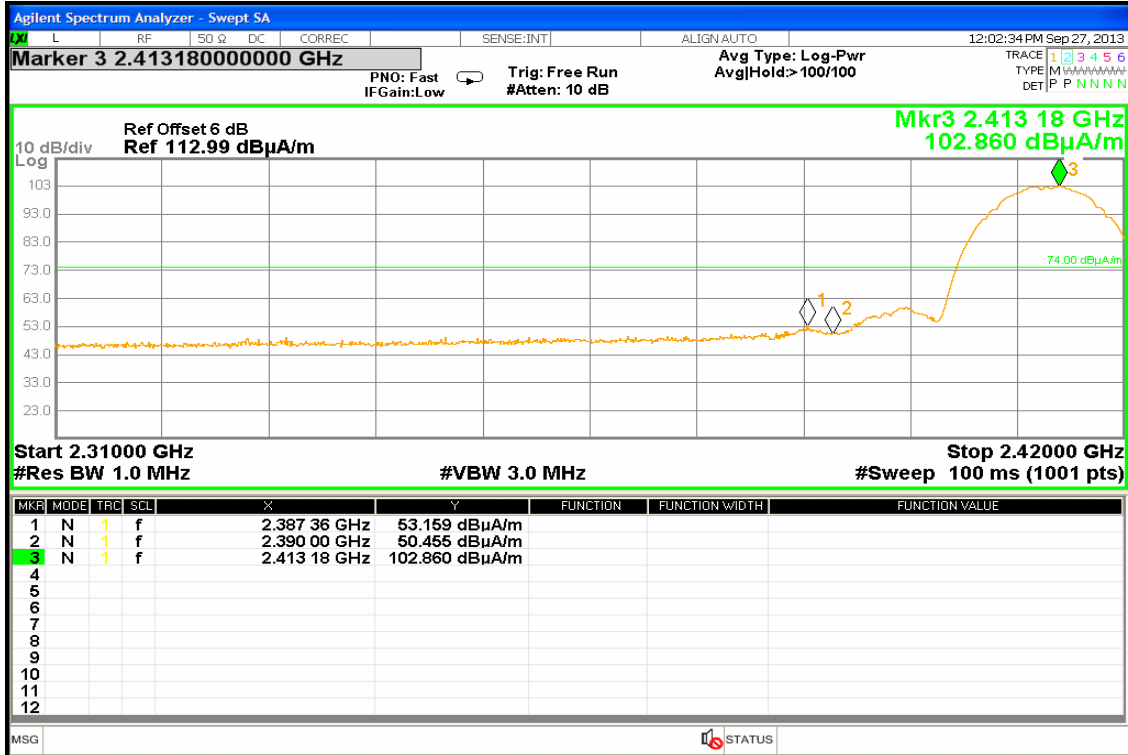

Detector mode: Average

Polarity: Vertical





Detector mode: Peak

Polarity: Horizontal

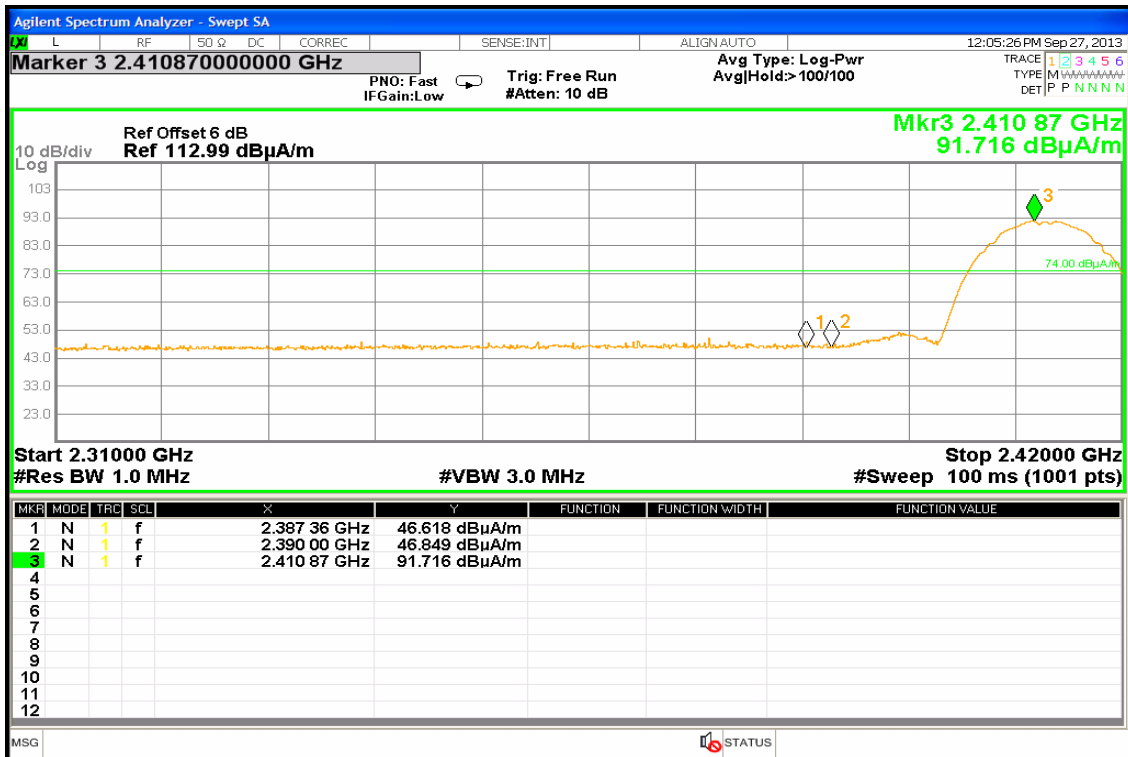

Detector mode: Average

Polarity: Horizontal

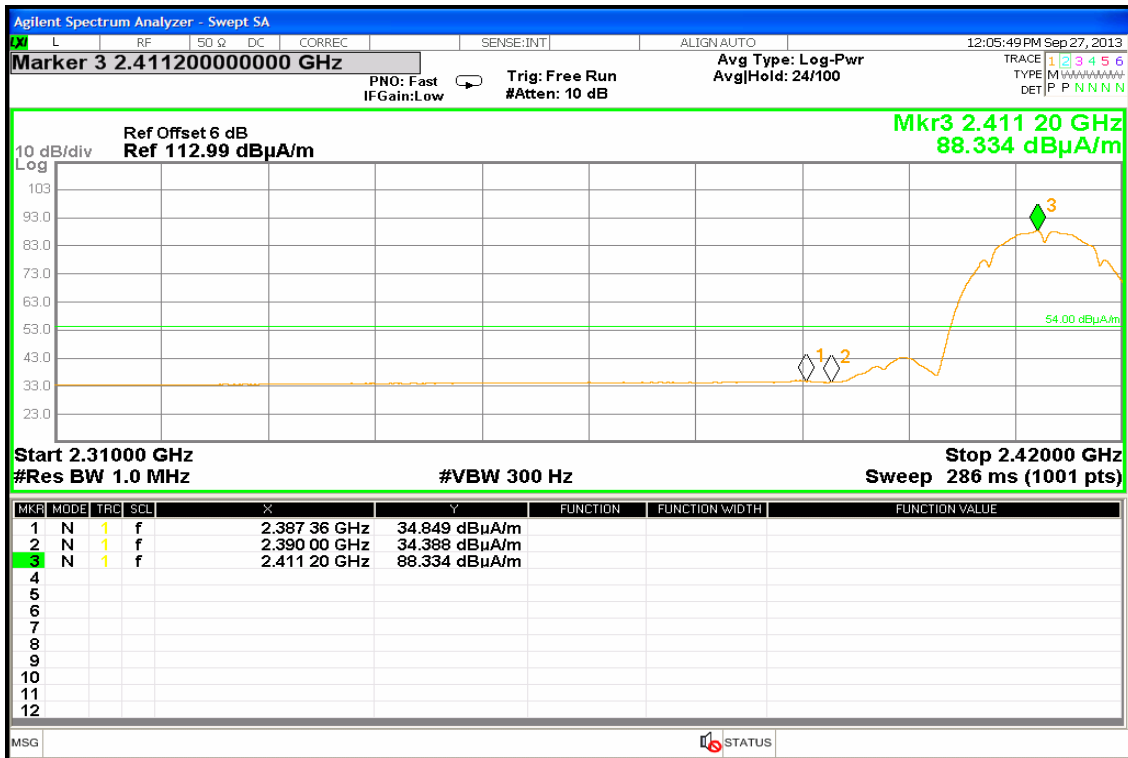



Band Edges (IEEE 802.11b mode / CH High)

Detector mode: Peak

Polarity: Vertical

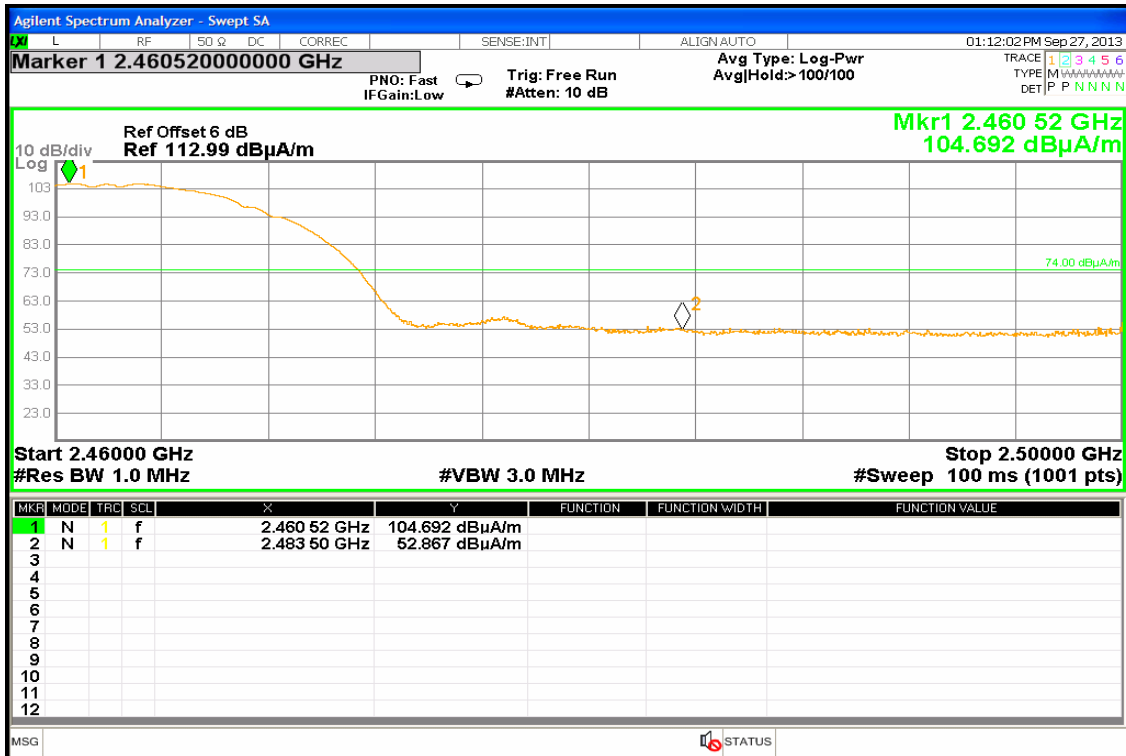

Detector mode: Average

Polarity: Vertical

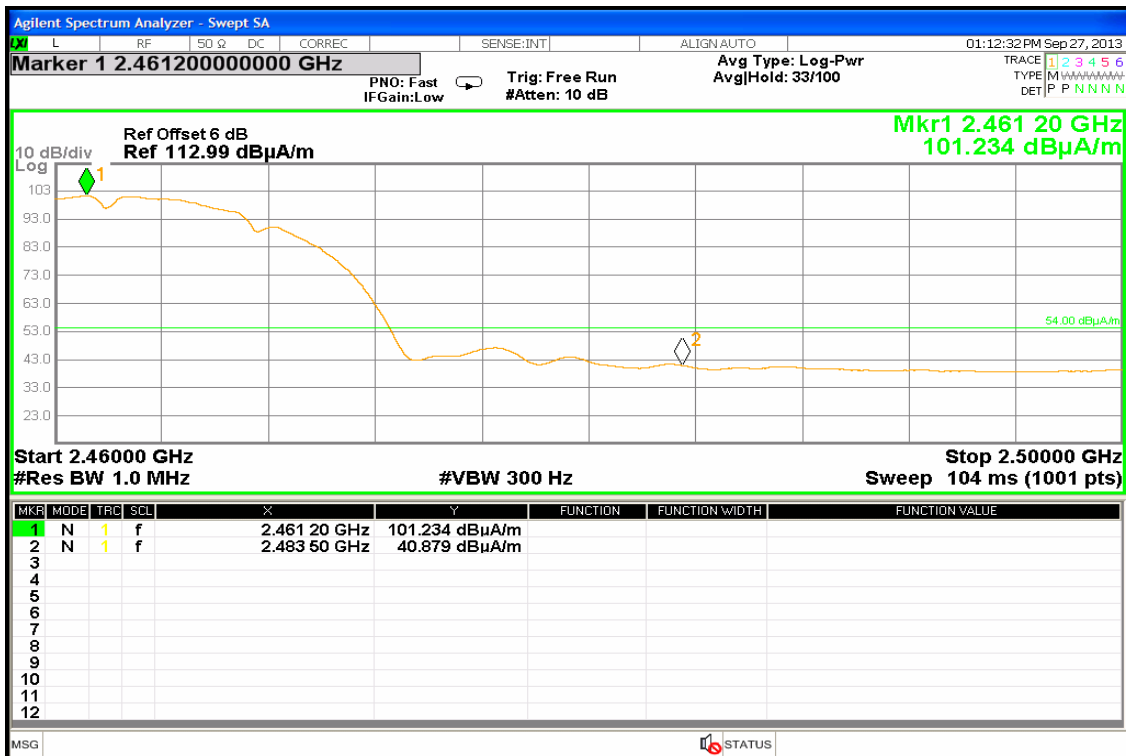



Detector mode: Peak

Polarity: Horizontal

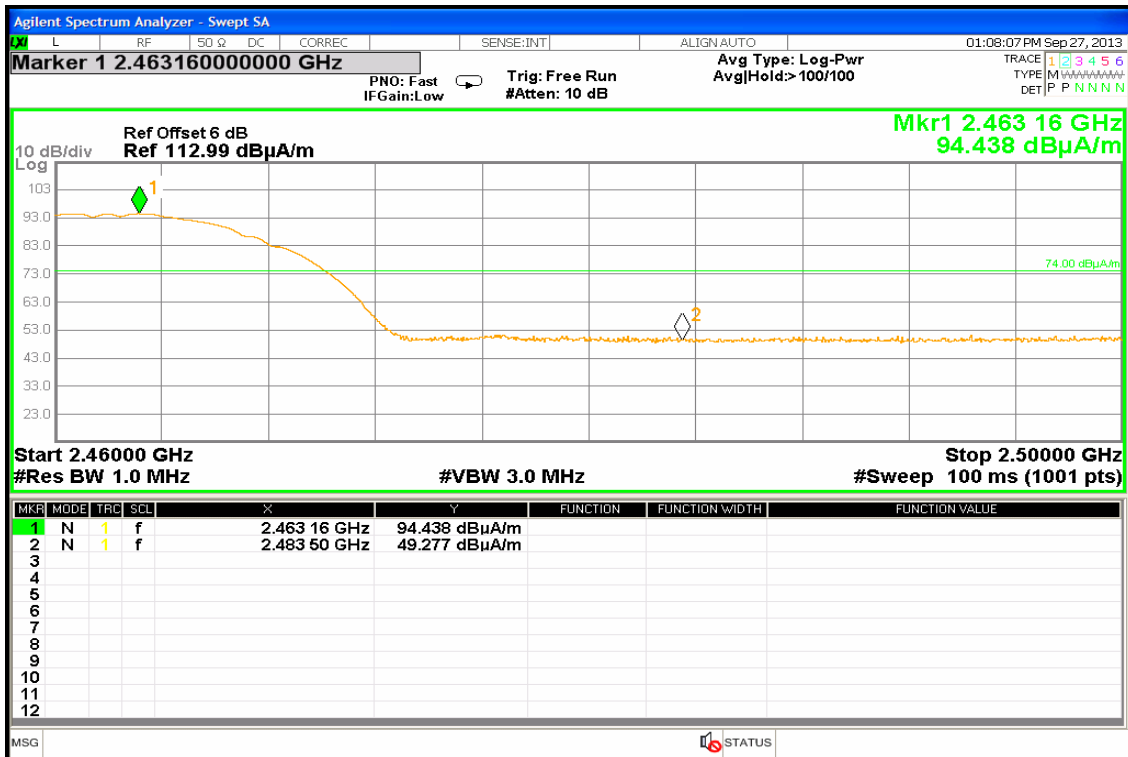

Detector mode: Average

Polarity: Horizontal

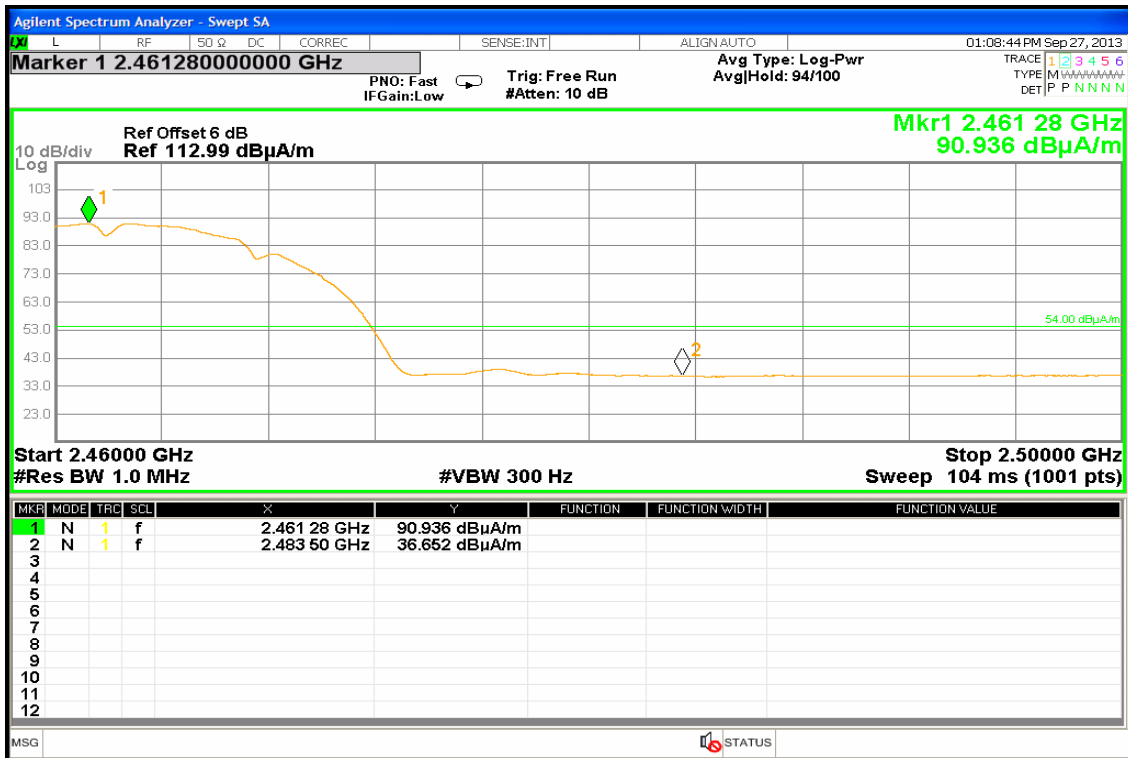



Band Edges (IEEE 802.11g mode / CH Low)

Detector mode: Peak

Polarity: Vertical

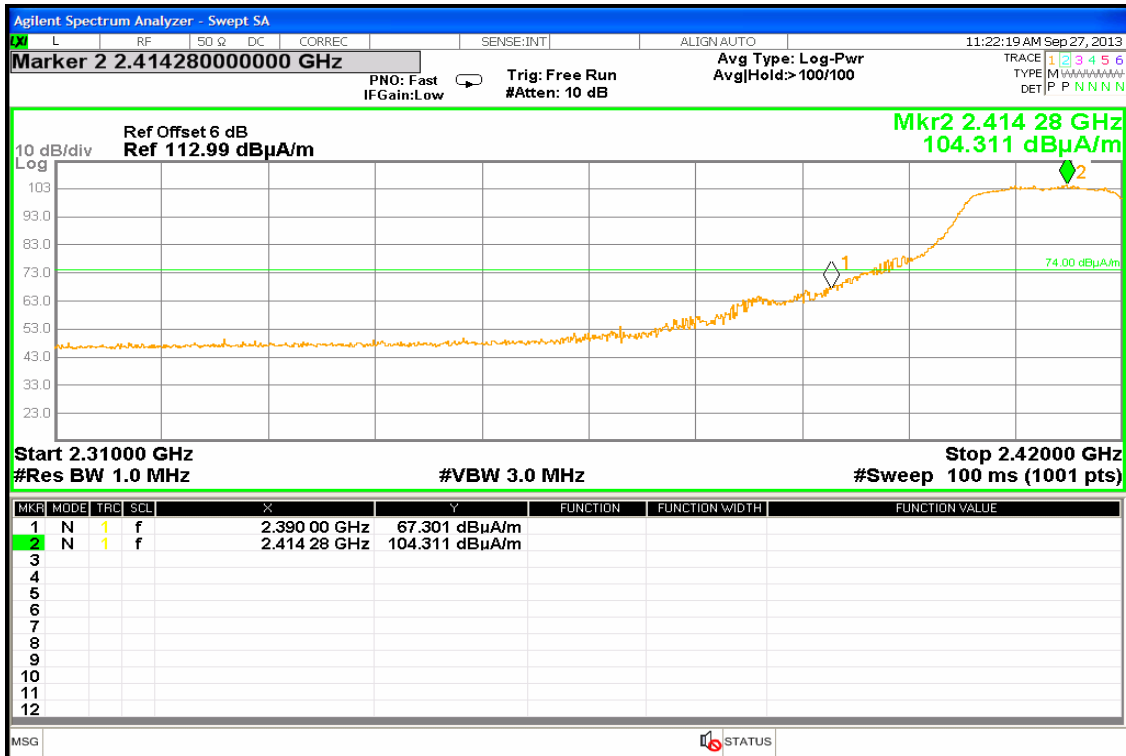

Detector mode: Average

Polarity: Vertical





Detector mode: Peak

Polarity: Horizontal

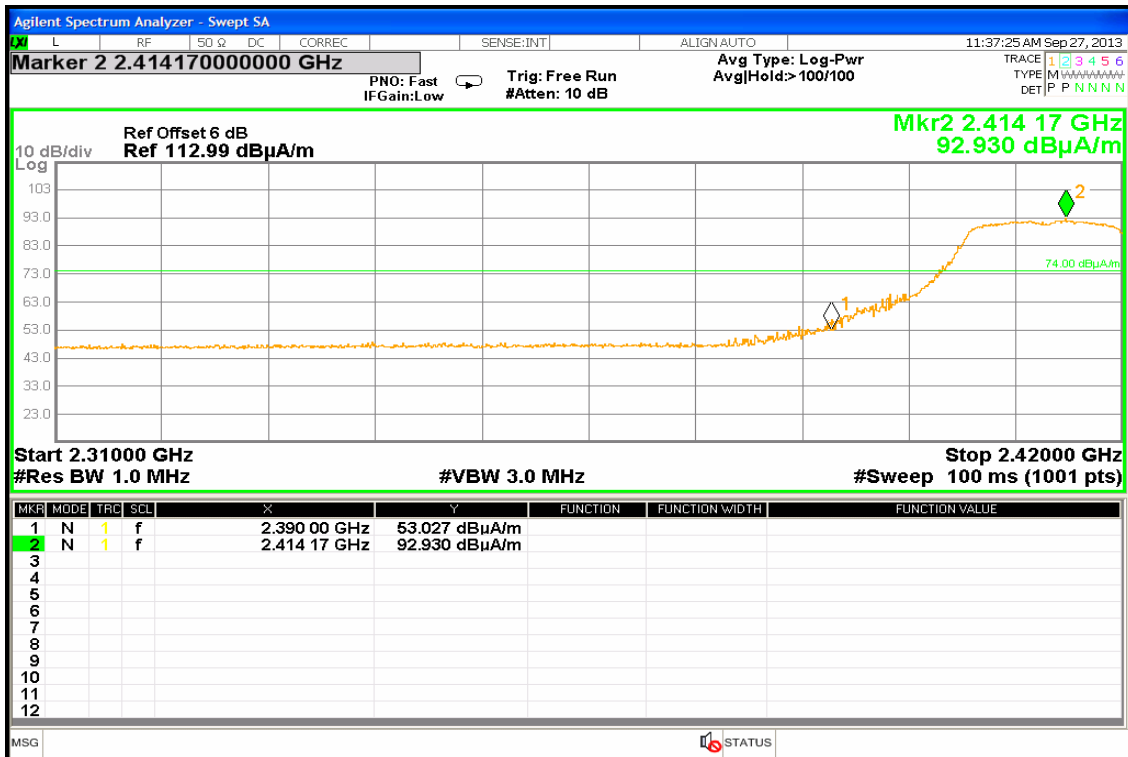

Detector mode: Average

Polarity: Horizontal

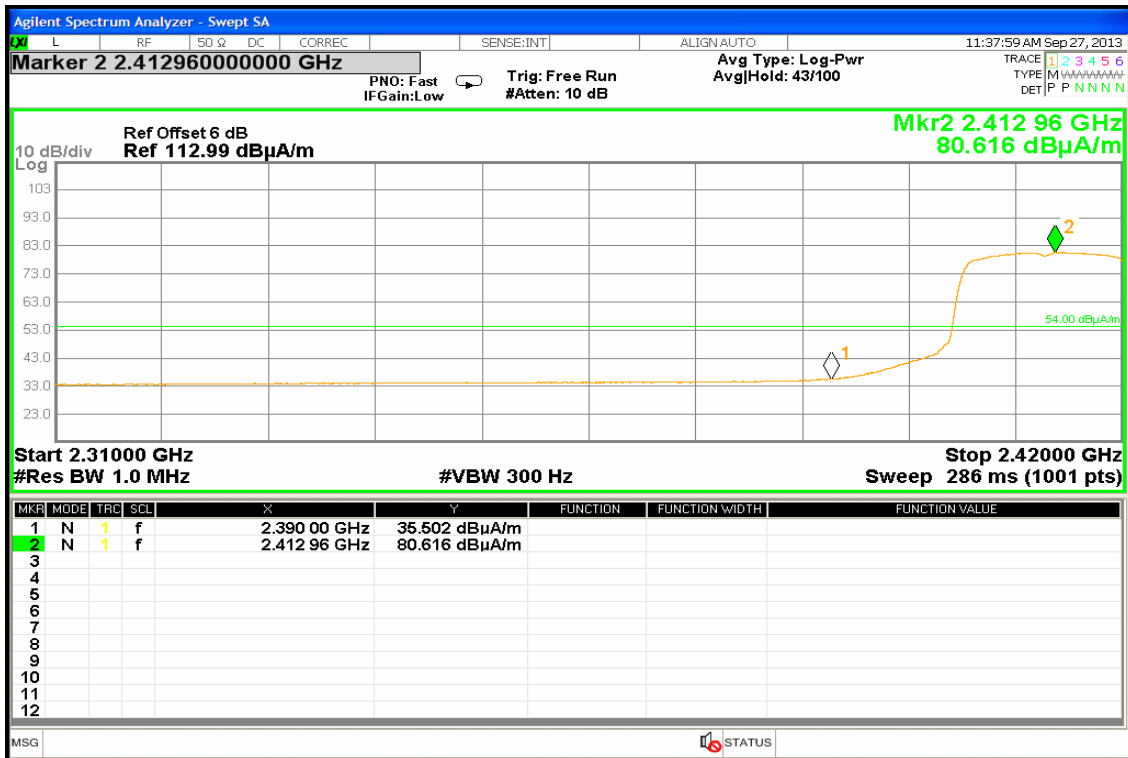



Band Edges (IEEE 802.11g mode / CH High)

Detector mode: Peak

Polarity: Vertical

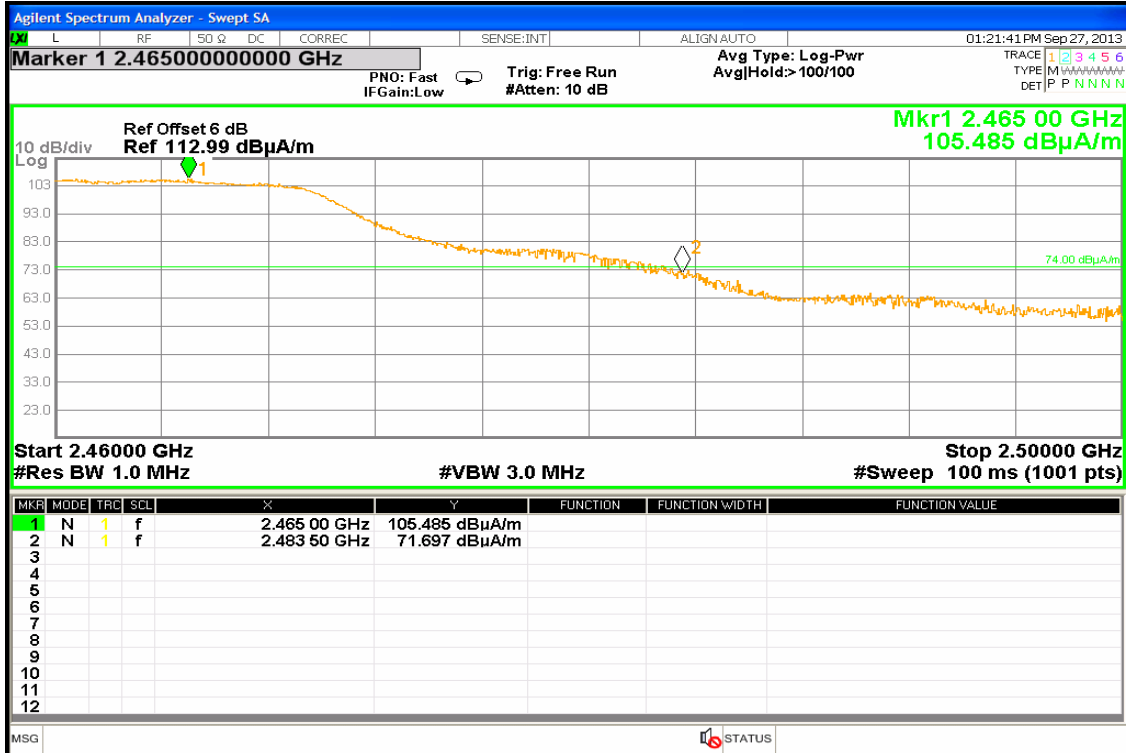

Detector mode: Average

Polarity: Vertical

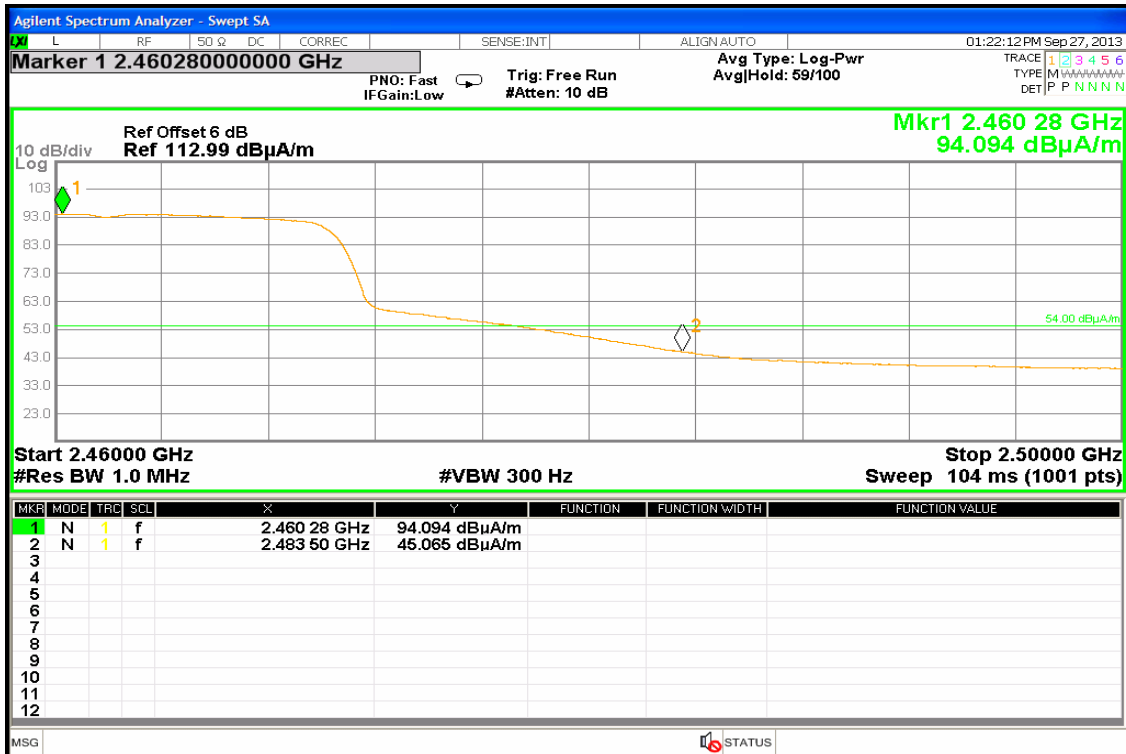



Detector mode: Peak

Polarity: Horizontal

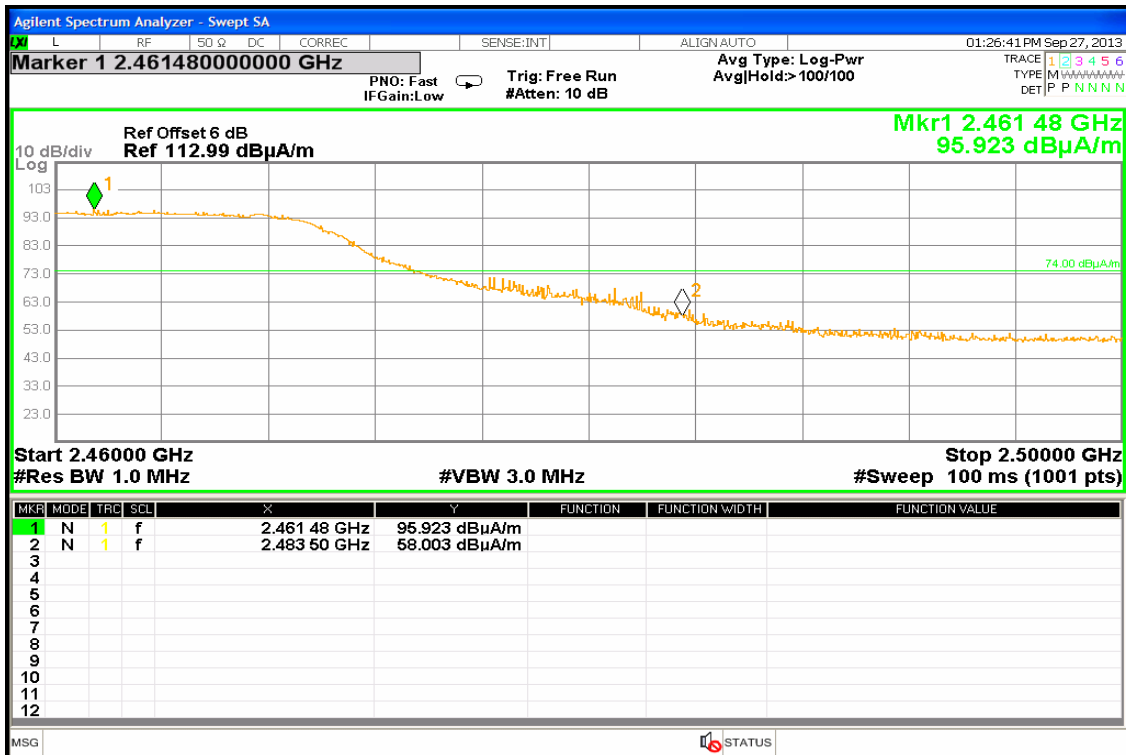

Detector mode: Average

Polarity: Horizontal

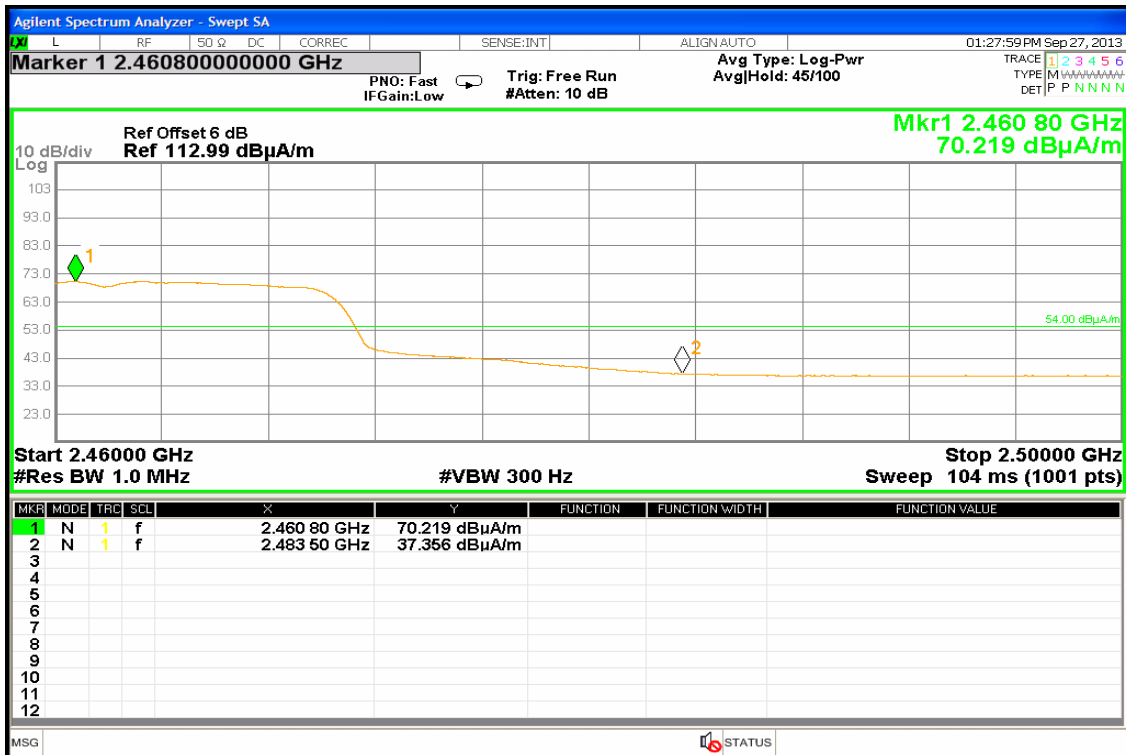



Band Edges (IEEE 802.11n HT20 mode / CH Low)

Detector mode: Peak

Polarity: Vertical

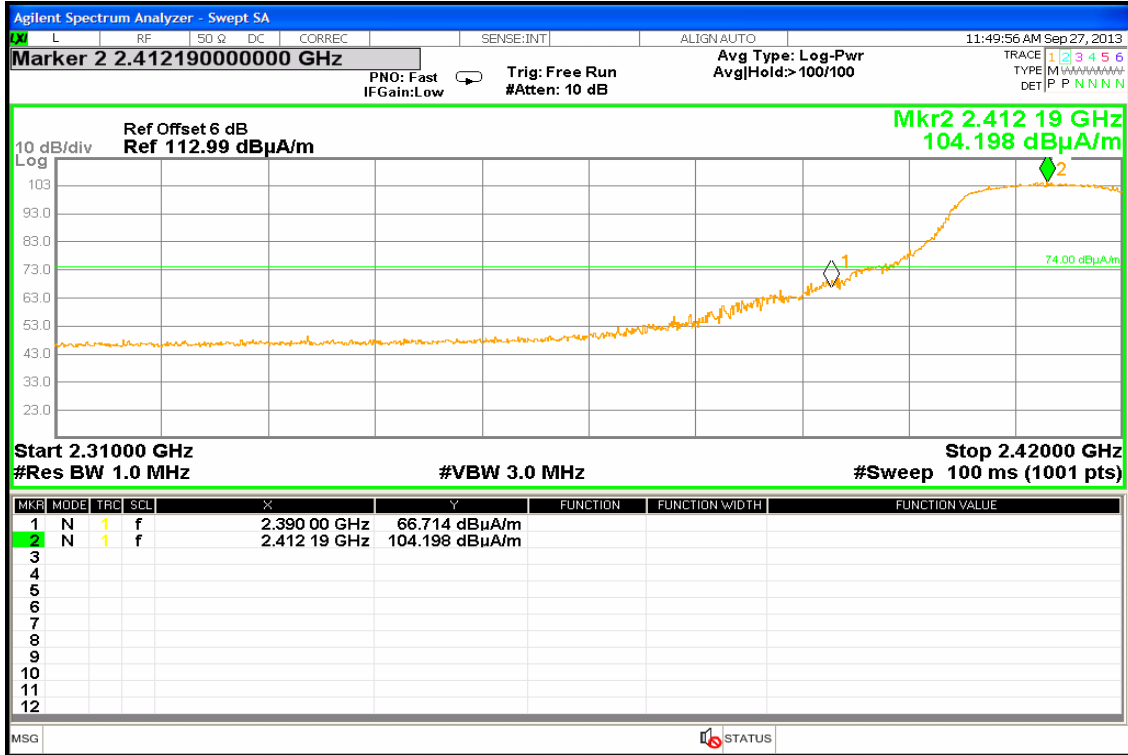

Detector mode: Average

Polarity: Vertical

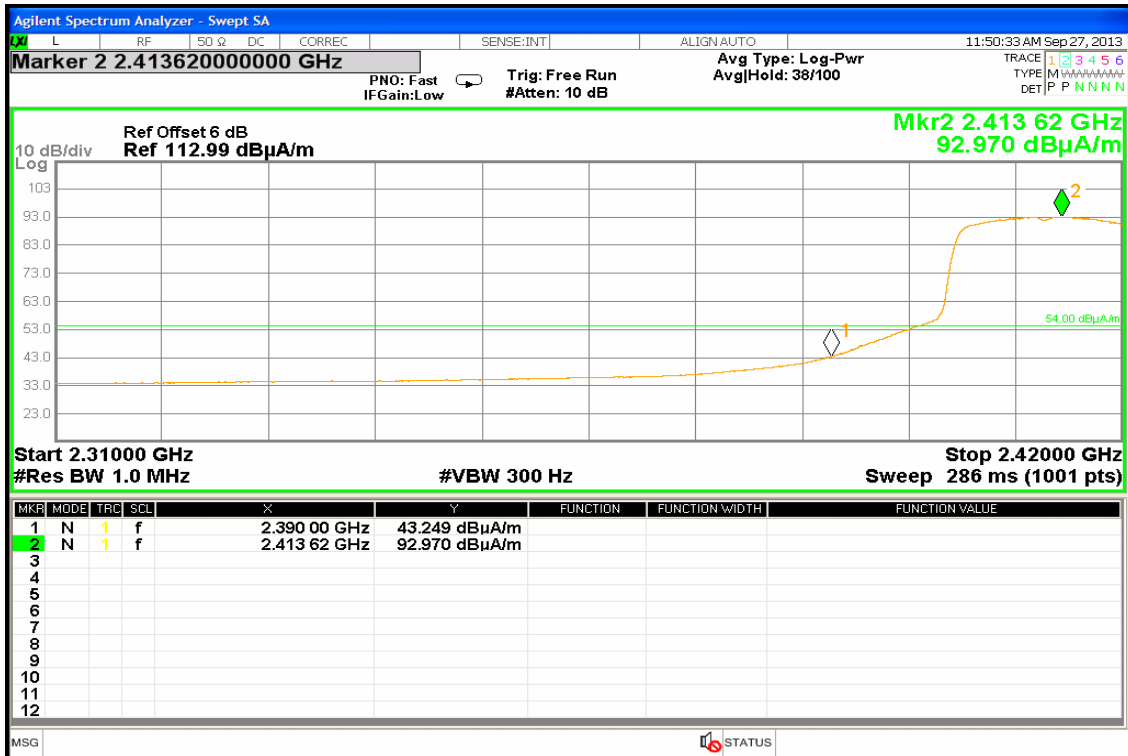



Detector mode: Peak

Polarity: Horizontal

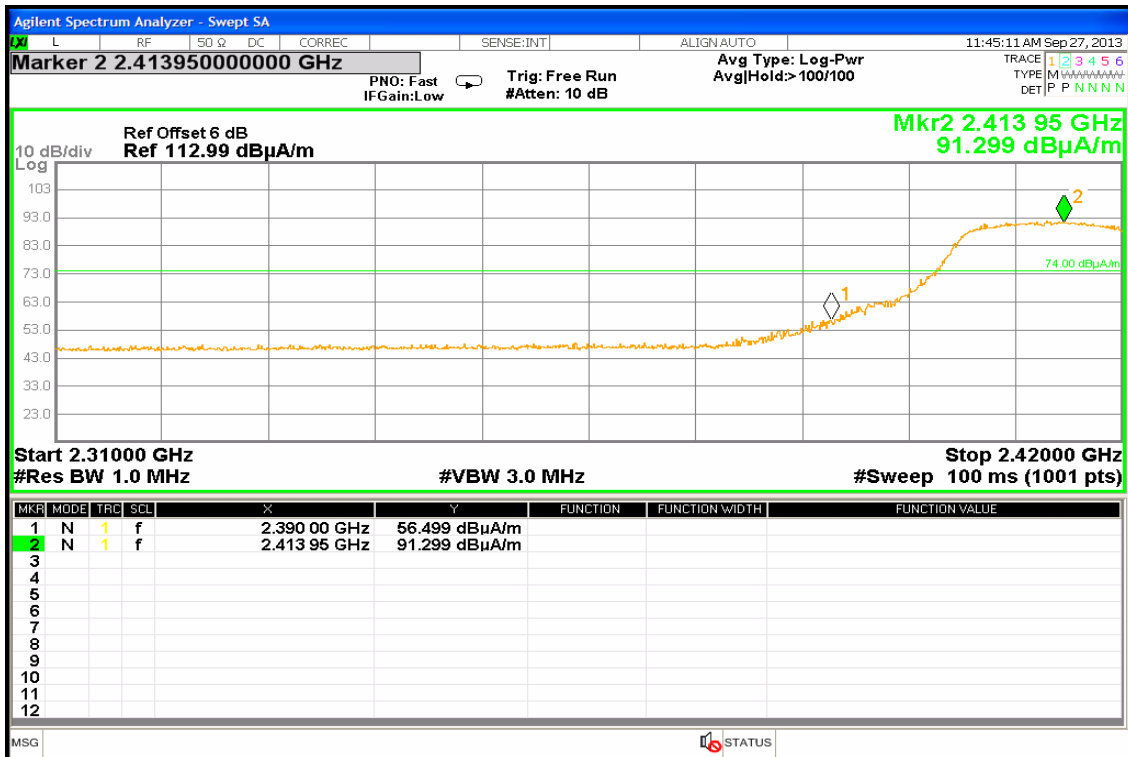

Detector mode: Average

Polarity: Horizontal

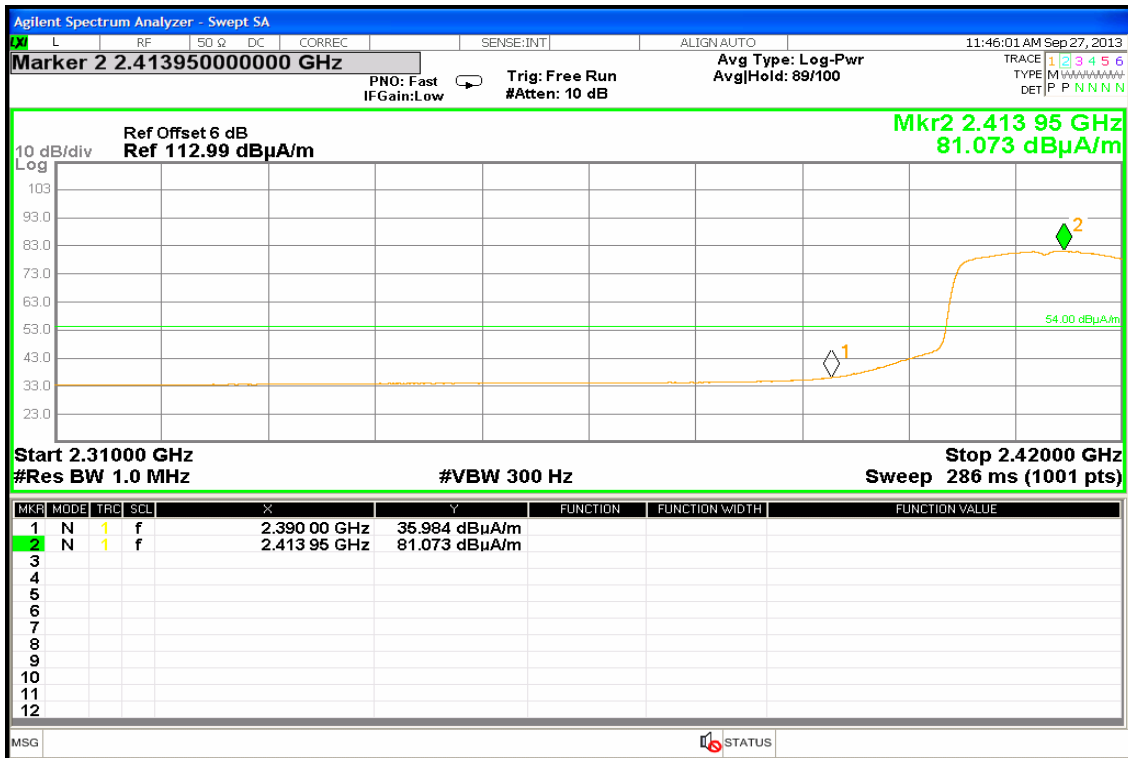



Band Edges (IEEE 802.11n HT20 mode / CH High)

Detector mode: Peak

Polarity: Vertical

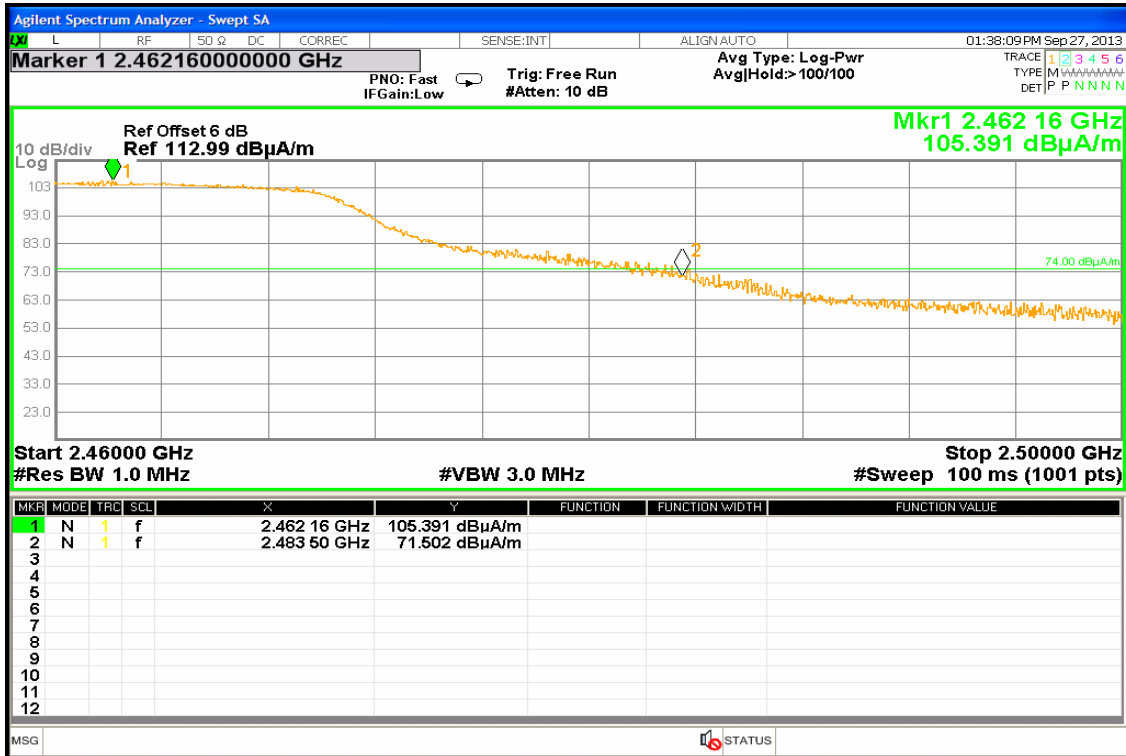

Detector mode: Average

Polarity: Vertical

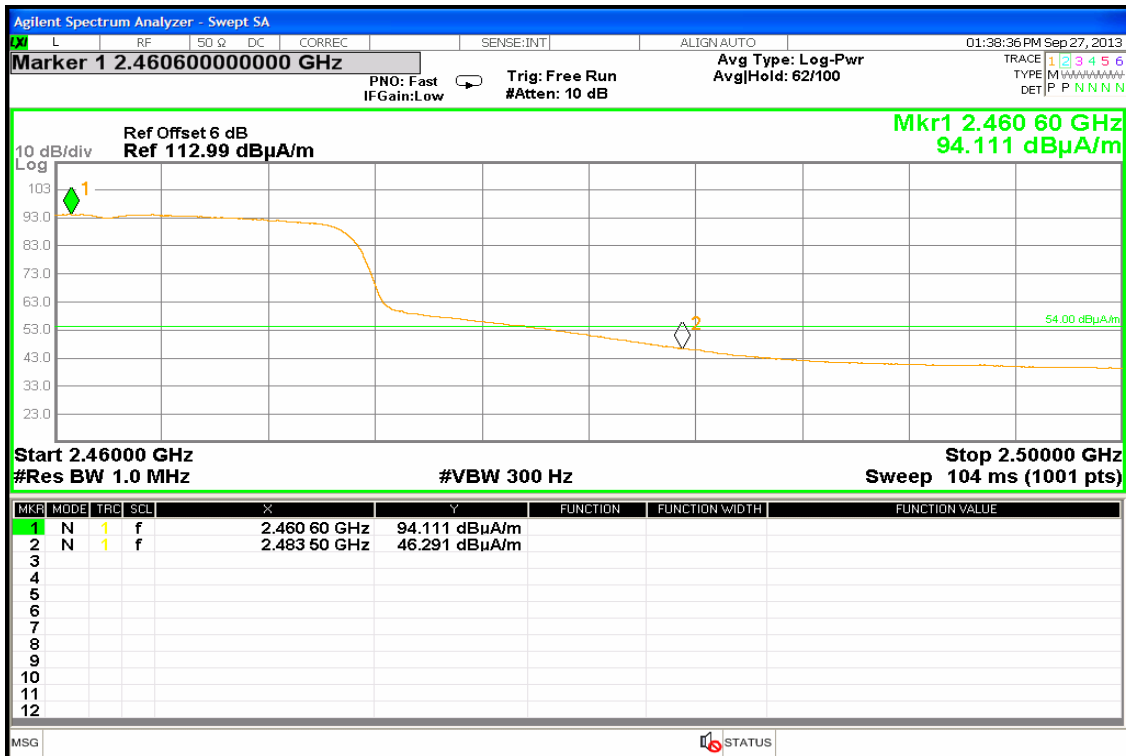



Detector mode: Peak

Polarity: Horizontal

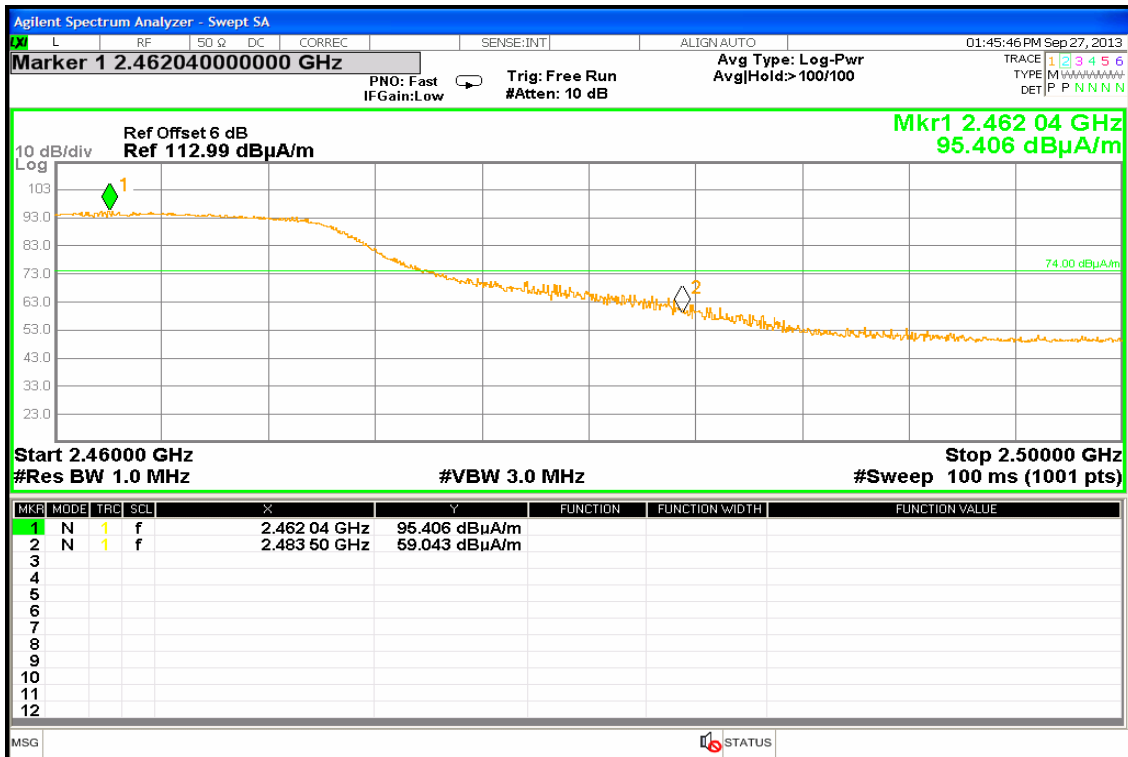

Detector mode: Average

Polarity: Horizontal

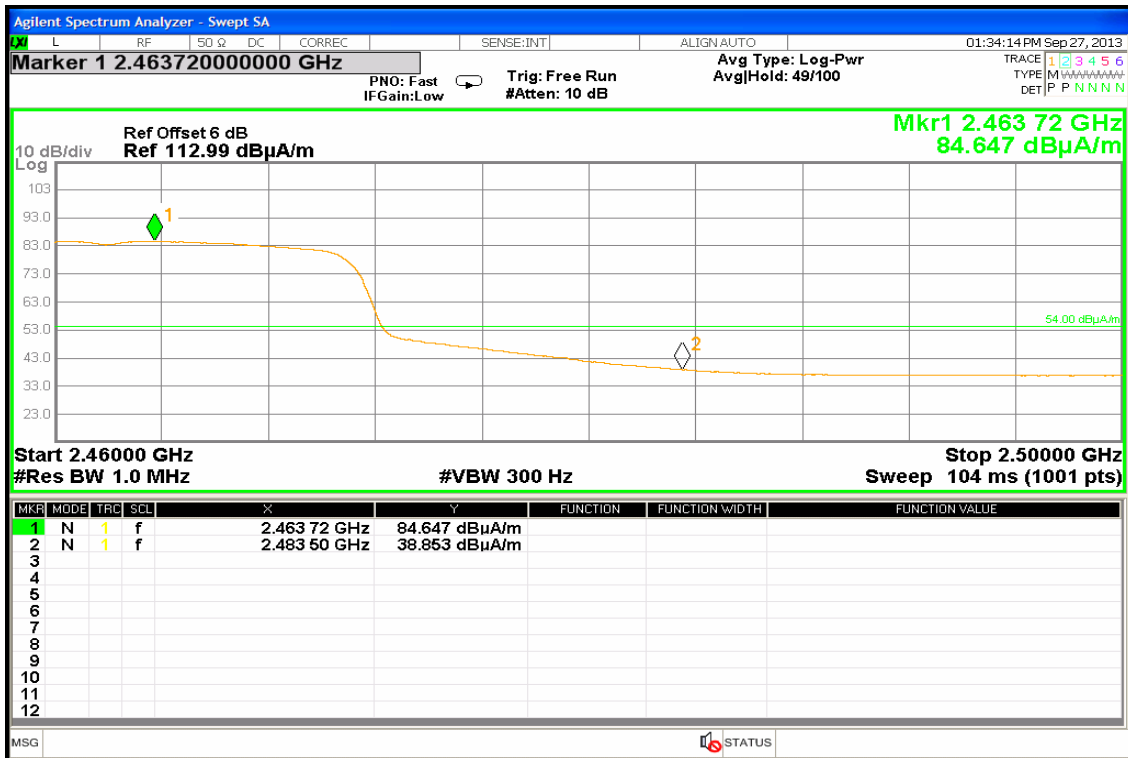



7.5 PEAK POWER SPECTRAL DENSITY

LIMIT

1. According to §15.247(e), for digitally modulated systems, the power spectral density conducted from the intentional radiator to the antenna shall not be greater than 8 dBm in any 3 kHz band during any time interval of continuous transmission.
2. According to §15.247(f), the digital modulation operation of the hybrid system, with the frequency hopping turned off, shall comply with the power density requirements of paragraph (d) of this section.

TEST CONFIGURATION

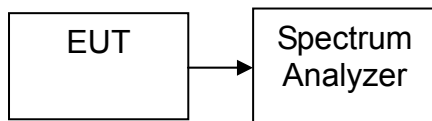

TEST PROCEDURE

Per KDB 558074 D01 DTS Meas Guidance v02

This procedure must be used if maximum peak conducted output power was used to demonstrate compliance to the fundamental output power limit, and is optional if the maximum (average) conducted output power was used to demonstrate compliance.

1. Set analyzer center frequency to DTS channel center frequency.
2. Set the span to 1.5 times the DTS channel bandwidth.
3. Set the RBW \geq 3 kHz.
4. Set the VBW \geq 3 x RBW.
5. Detector = peak.
6. Sweep time = auto couple.
7. Trace mode = max hold.
8. Allow trace to fully stabilize.

Use the peak marker function to determine the maximum amplitude level.

If measured value exceeds limit, reduce RBW (no less than 3 kHz) and repeat.

TEST RESULTS

No non-compliance noted



TEST DATA

Test mode: IEEE 802.11b mode

Channel	Frequency (MHz)	PPSD (dBm)	Limit (dBm)	Result
Low	2412	-4.75	8.00	PASS
Mid	2437	-5.60		PASS
High	2462	-6.73		PASS

Test mode: IEEE 802.11g mode

Channel	Frequency (MHz)	PPSD (dBm)	Limit (dBm)	Result
Low	2412	-9.35	8.00	PASS
Mid	2437	-10.23		PASS
High	2462	-9.58		PASS

Test mode: draft 802.11n 20 MHz Channel mode

Channel	Frequency (MHz)	PPSD (dBm)	Limit (dBm)	Result
Low	2412	-10.89	8.00	PASS
Mid	2437	-10.31		PASS
High	2462	-10.30		PASS



Test Plot

IEEE 802.11b mode

PPSD (CH Low)

Agilent

R T

Mkr1 2.412 70 GHz
-4.75 dBm

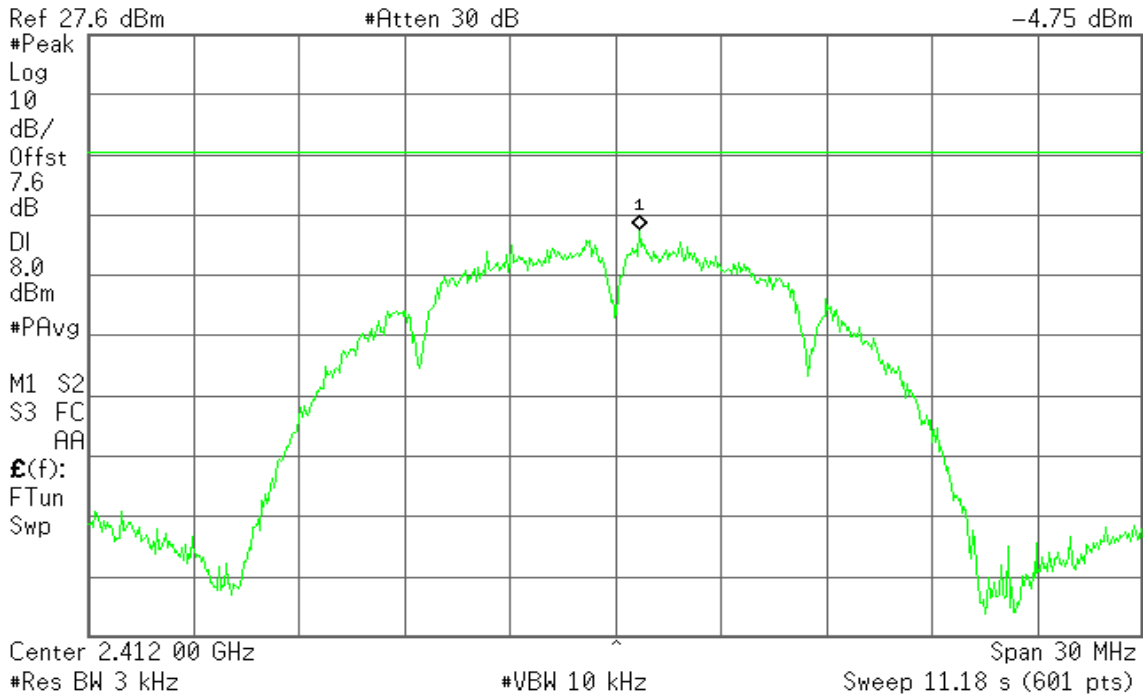

PPSD (CH Mid)

Agilent

R T

Mkr1 2.437 65 GHz
-5.60 dBm

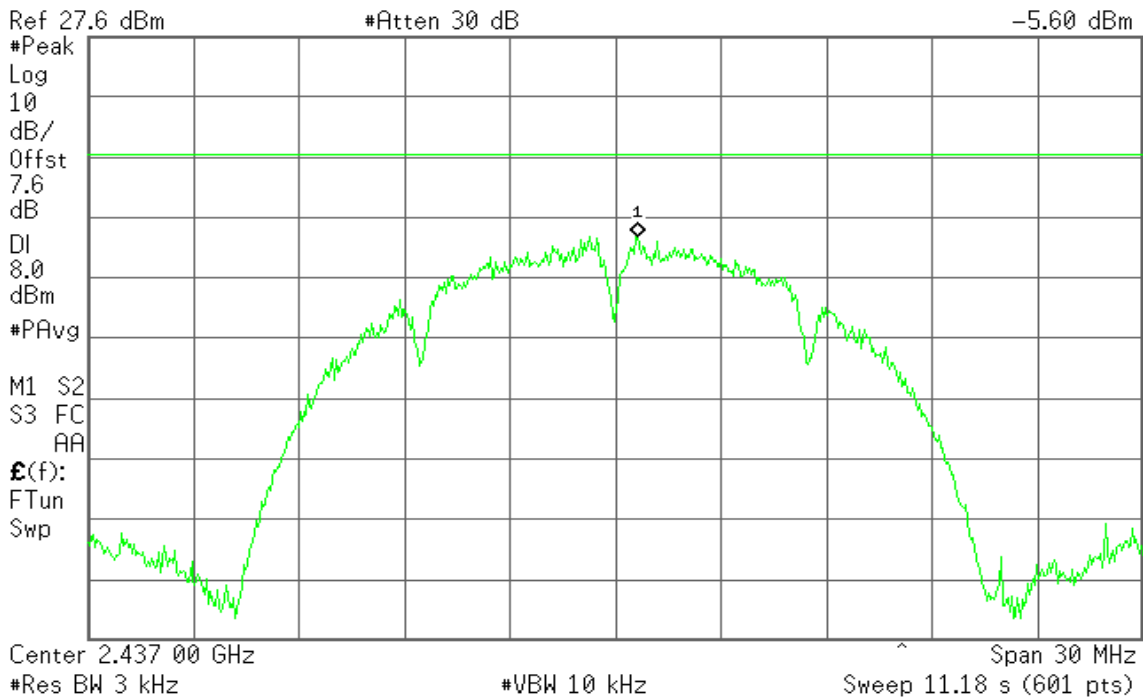



PPSD (CH High)

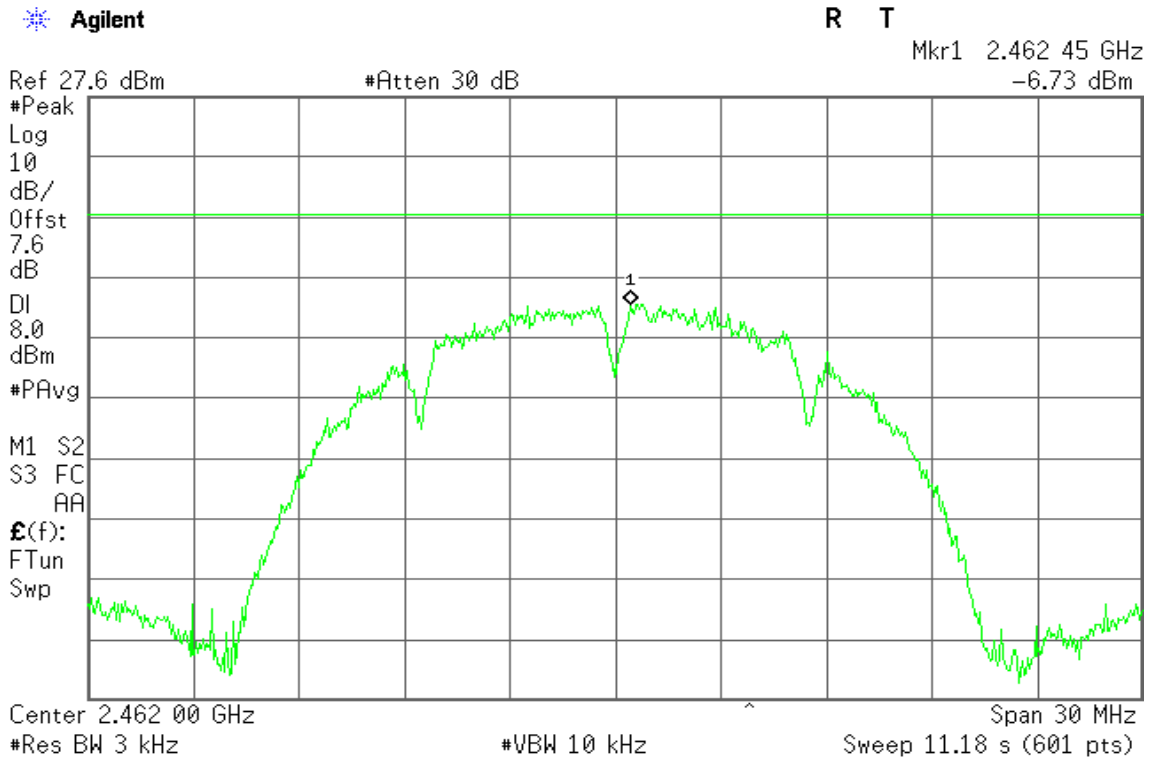

IEEE 802.11g mode

PPSD (CH Low)

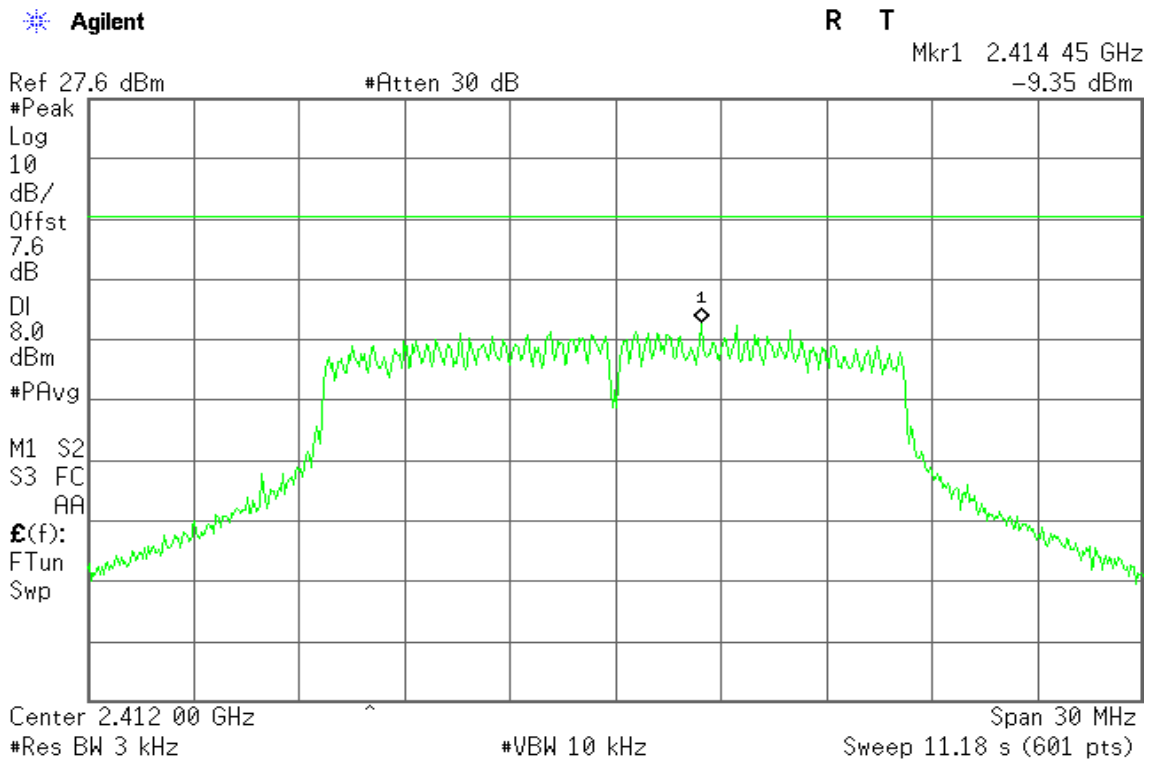



PPSD (CH Mid)

Agilent

R T

Mkr1 2.439 75 GHz
-10.23 dBm

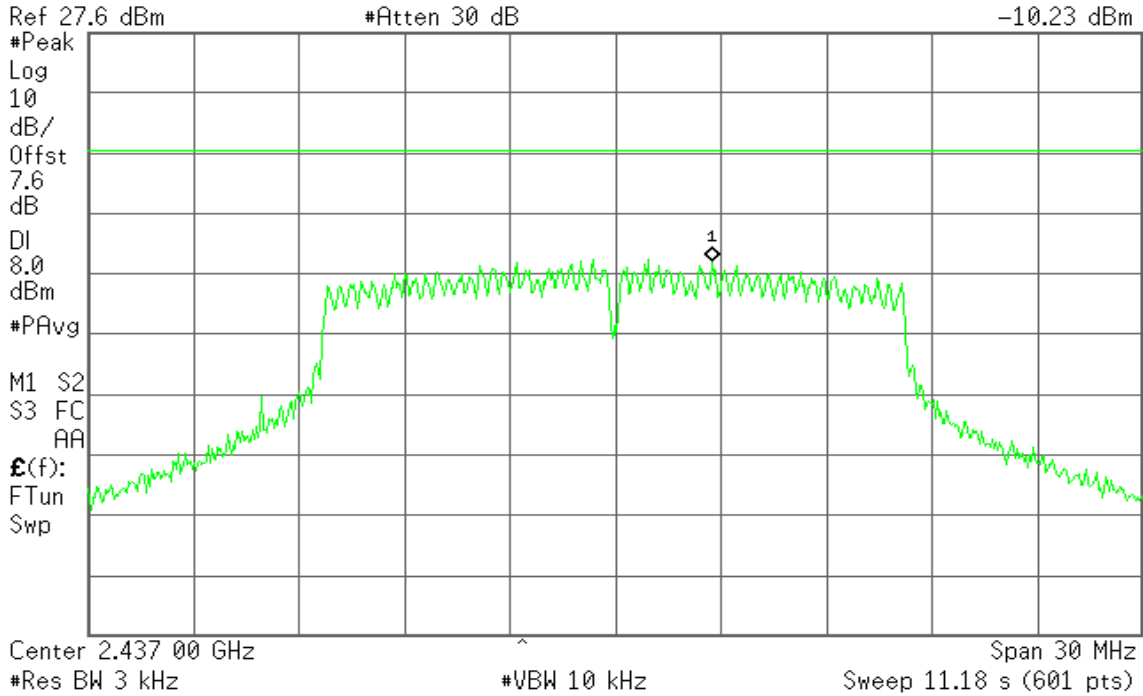

PPSD (CH High)

Agilent

R T

Mkr1 2.462 90 GHz
-9.58 dBm

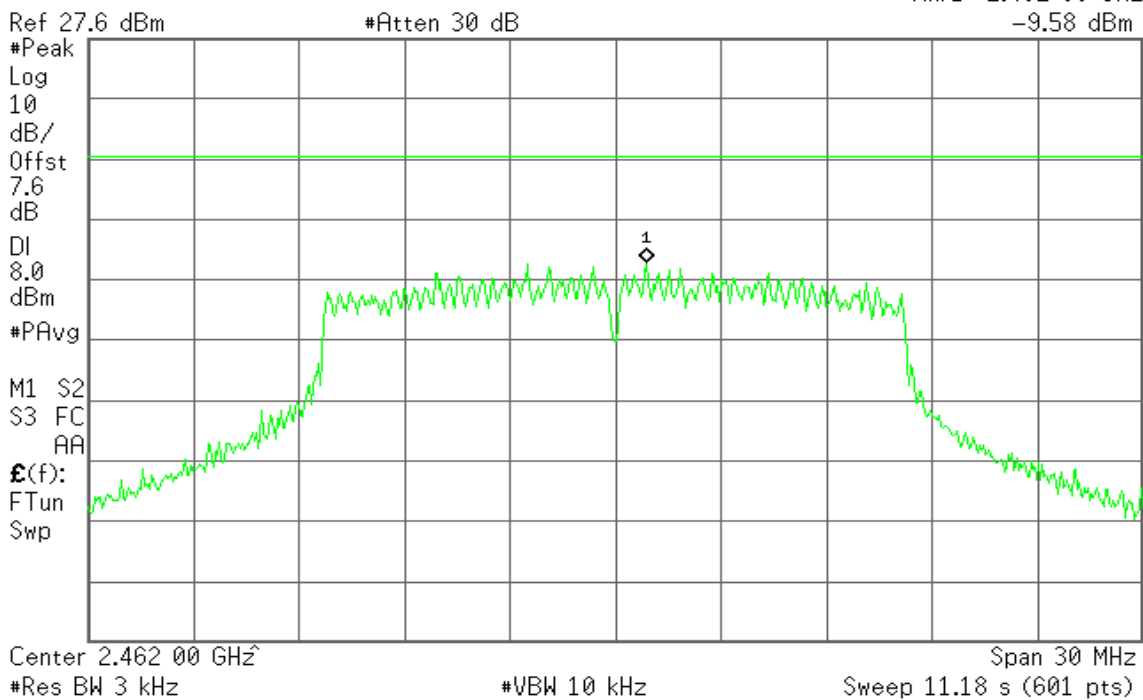



IEEE 802.11n HT20 mode

PPSD (CH Low)

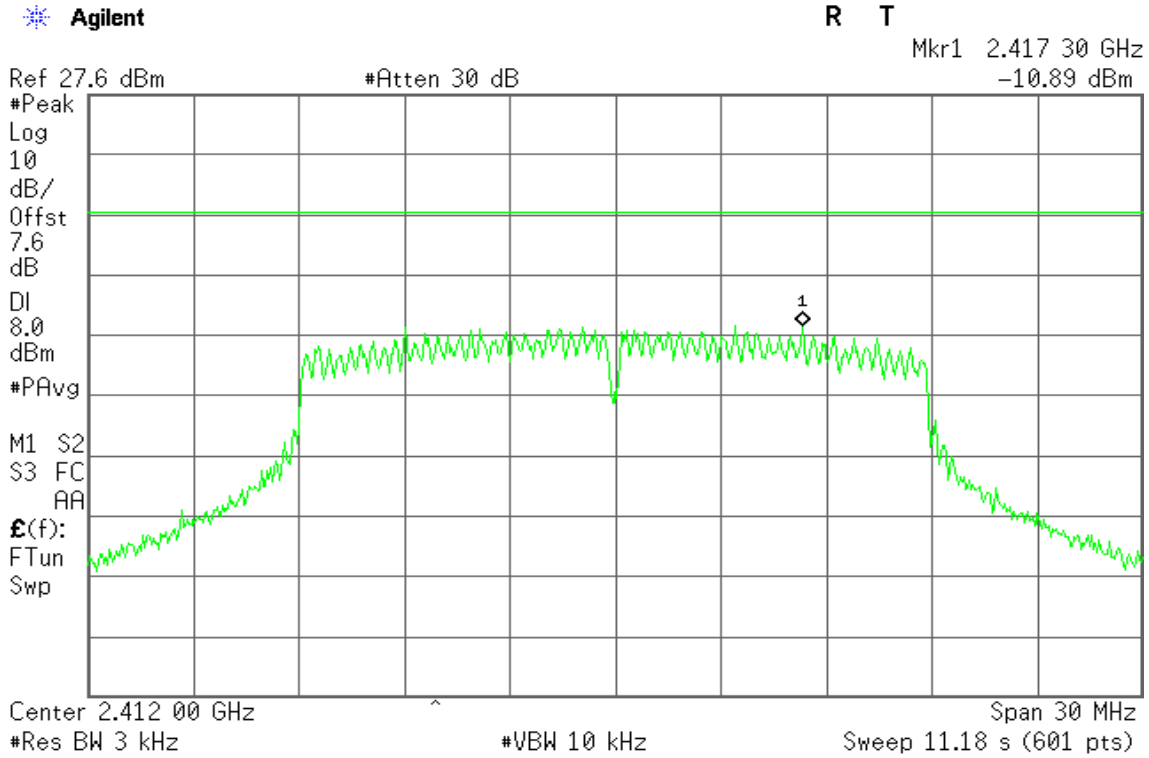

PPSD (CH Mid)

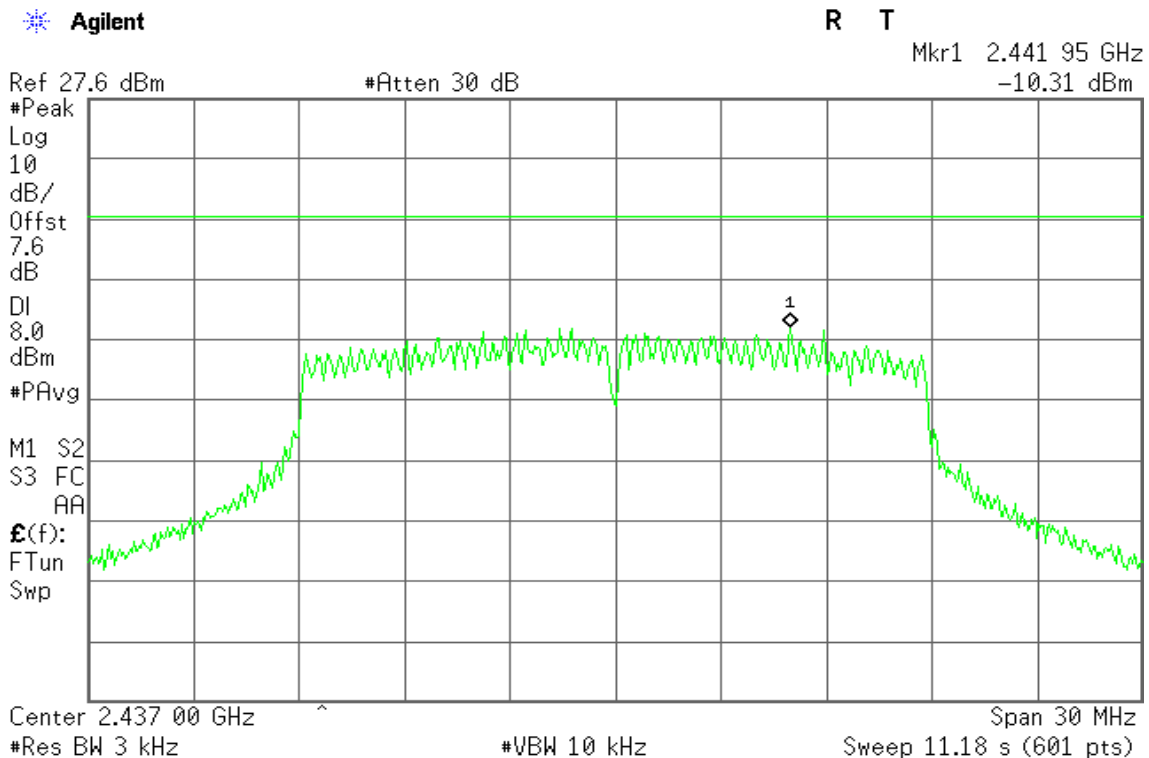



PPSD (CH High)

Agilent

R T

Mkr1 2.459 15 GHz
-10.30 dBm

Ref 27.6 dBm

#Atten 30 dB

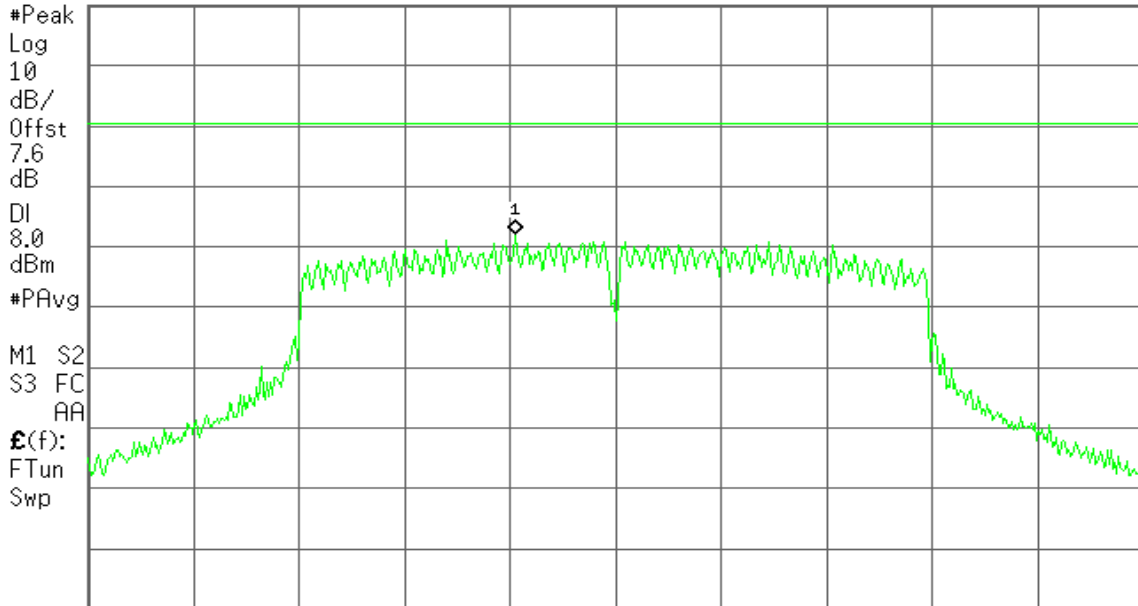

Center 2.462 00 GHz

Span 30 MHz

#Res BW 3 kHz

#VBW 10 kHz

Sweep 11.18 s (601 pts)



7.6 SPURIOUS EMISSIONS

7.6.1 CONDUCTED MEASUREMENT

LIMIT

According to §15.247(d), in any 100 kHz bandwidth outside the frequency bands in which the spread spectrum intentional radiator is operating, the radio frequency power that is produced by the intentional radiator shall be at least 20 dB below that in the 100 kHz bandwidth within the band that contains the highest level of the desired power, based on either an RF conducted or a radiated measurement, provided the transmitter demonstrates compliance with the peak conducted power limits. In addition, radiated emissions which fall in the restricted bands, as defined in §15.205(a), must also comply with the radiated emission limits specified in 15.209(a) (see Section 15.205(c)).

TEST CONFIGURATION

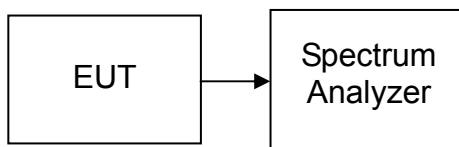

TEST PROCEDURE

Conducted RF measurements of the transmitter output were made to confirm that the EUT antenna port conducted emissions meet the specified limit and to identify any spurious signals that require further investigation or measurements on the radiated emissions site.

The transmitter output is connected to the spectrum analyzer. The resolution bandwidth is set to 100 kHz. The video bandwidth is set to 100 kHz.

Measurements are made over the 30MHz to 26GHz range with the transmitter set to the lowest, middle, and highest channels.

TEST RESULTS

No non-compliance noted.



Test Plot

Spurious Emissions

IEEE 802.11b mode

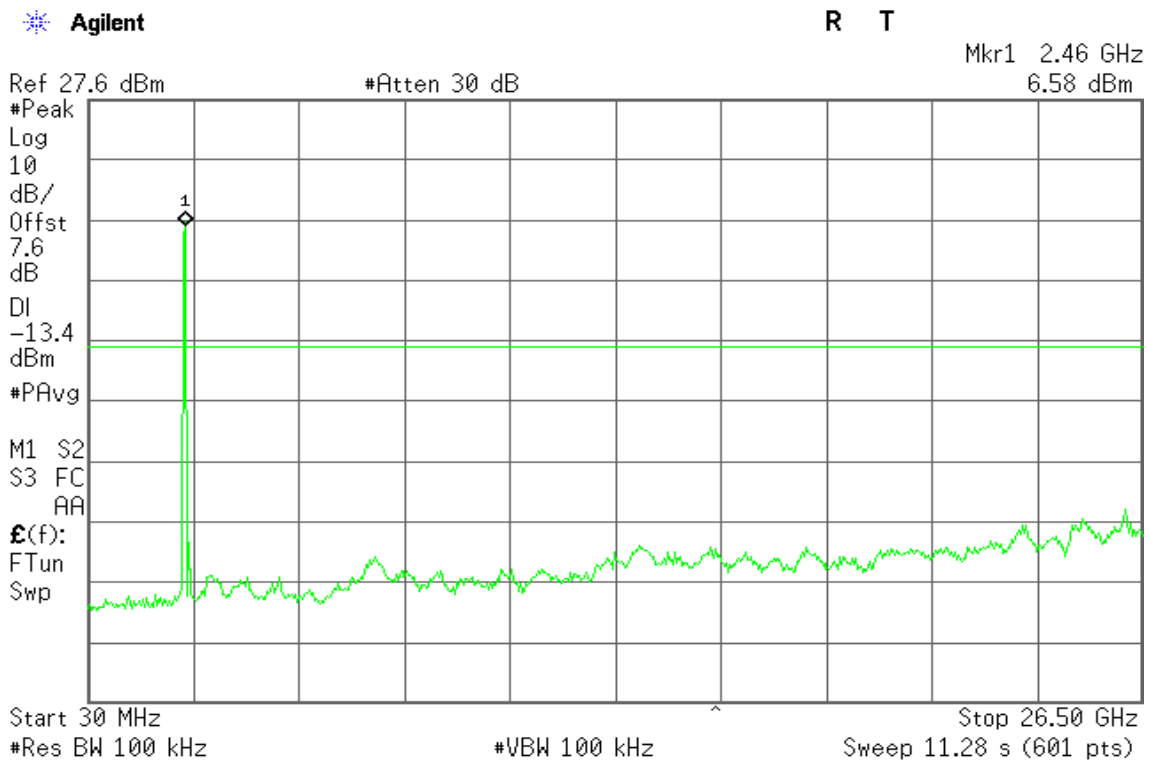
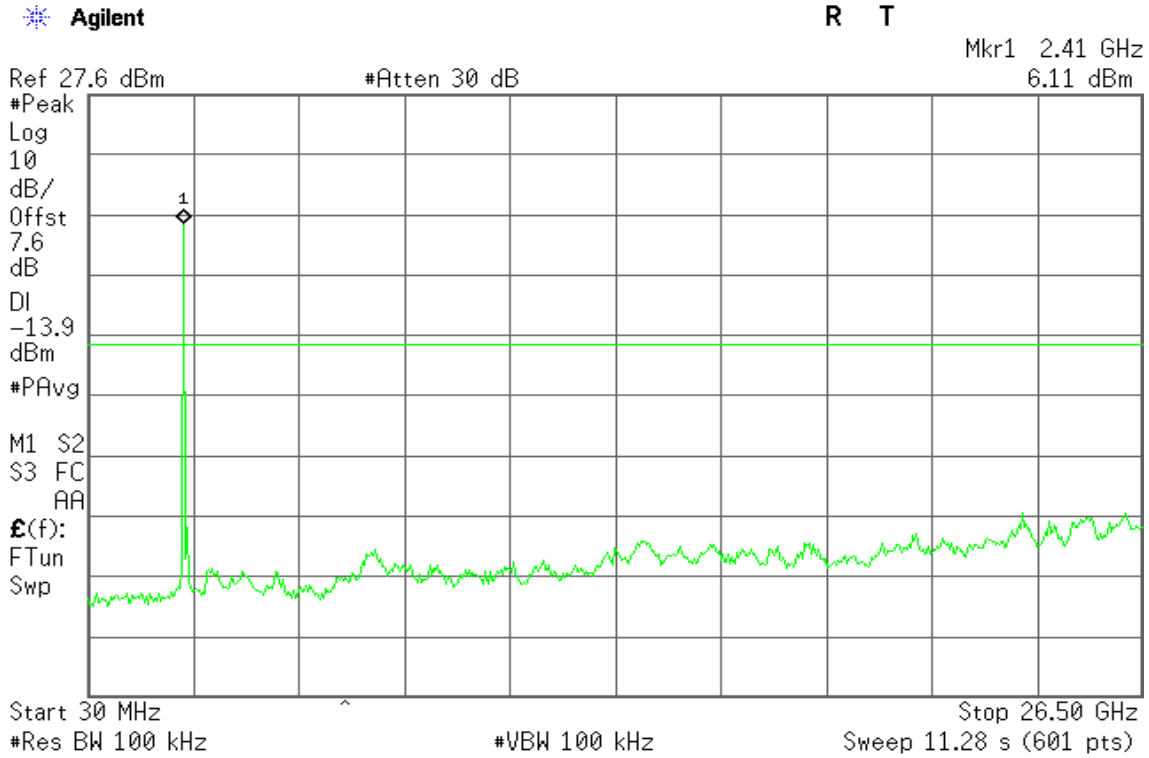



Agilent

R T

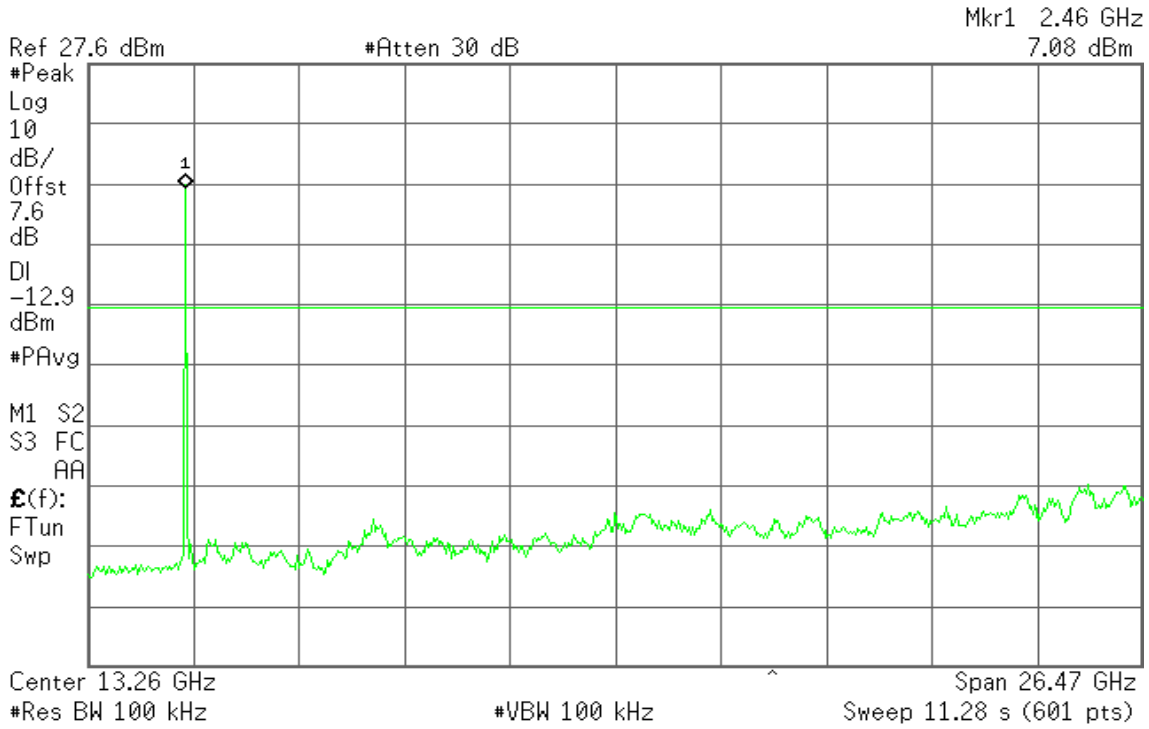

IEEE 802.11g mode

Agilent

R T

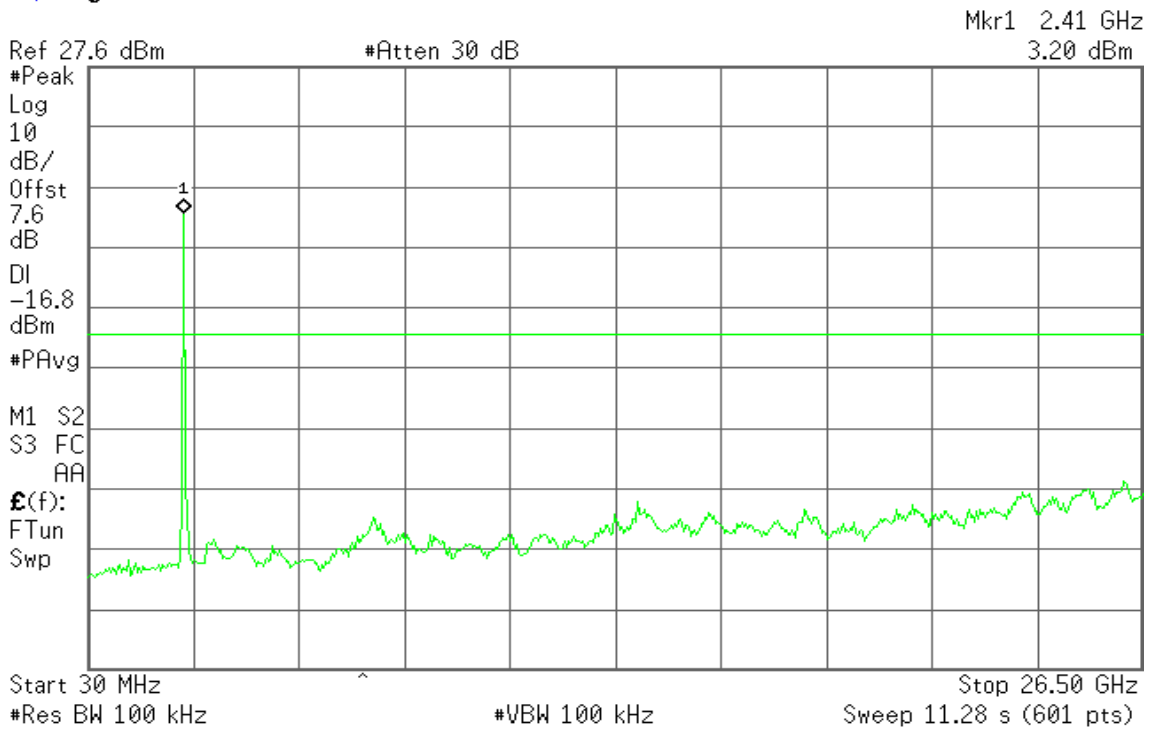



Agilent

R T

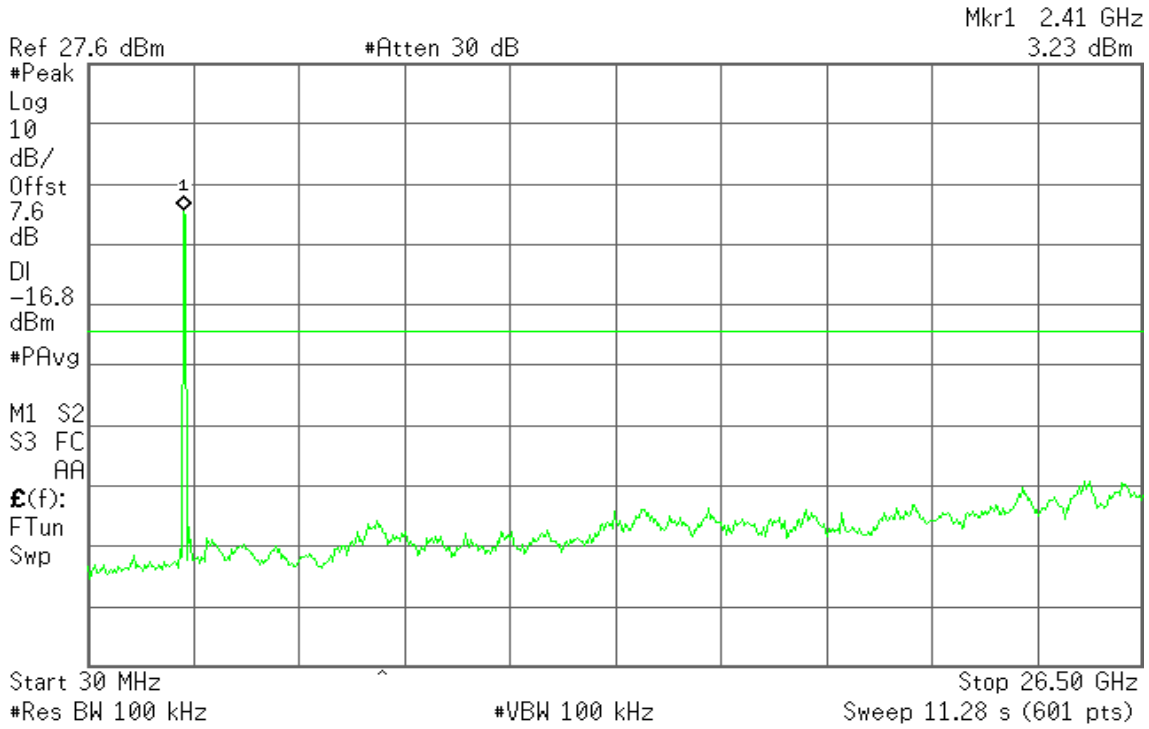

Agilent

R T

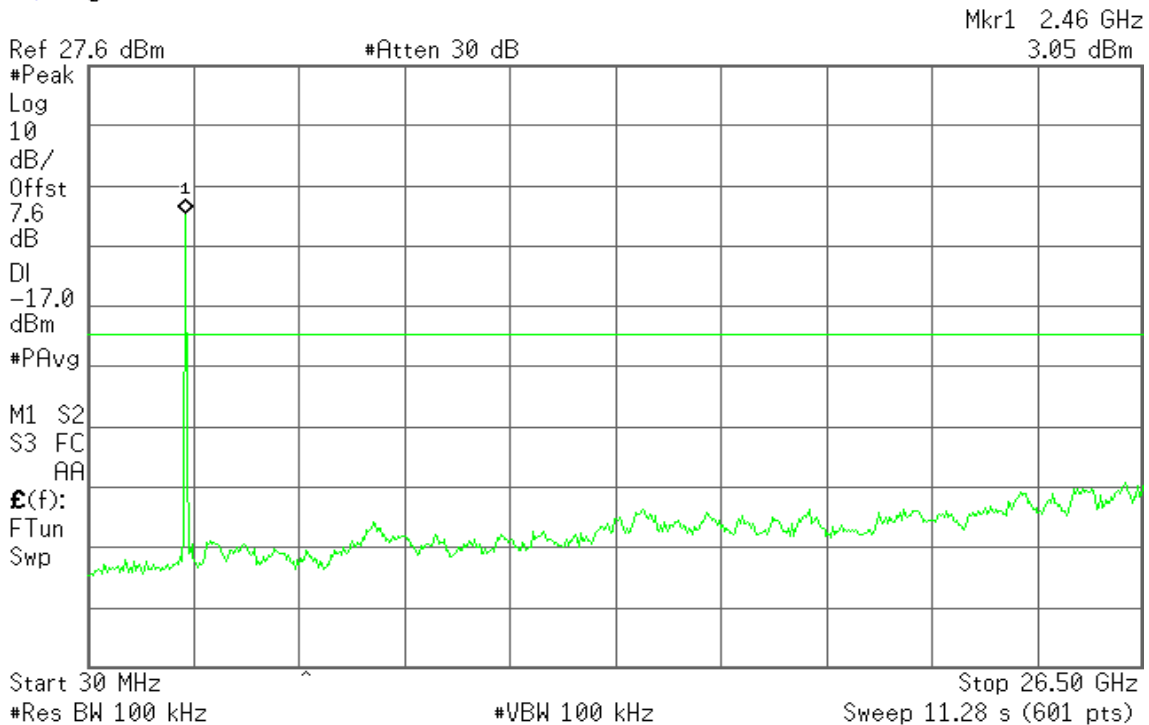



IEEE 802.11n HT20 mode

Agilent

R T

Mkr1 2.41 GHz
2.14 dBm

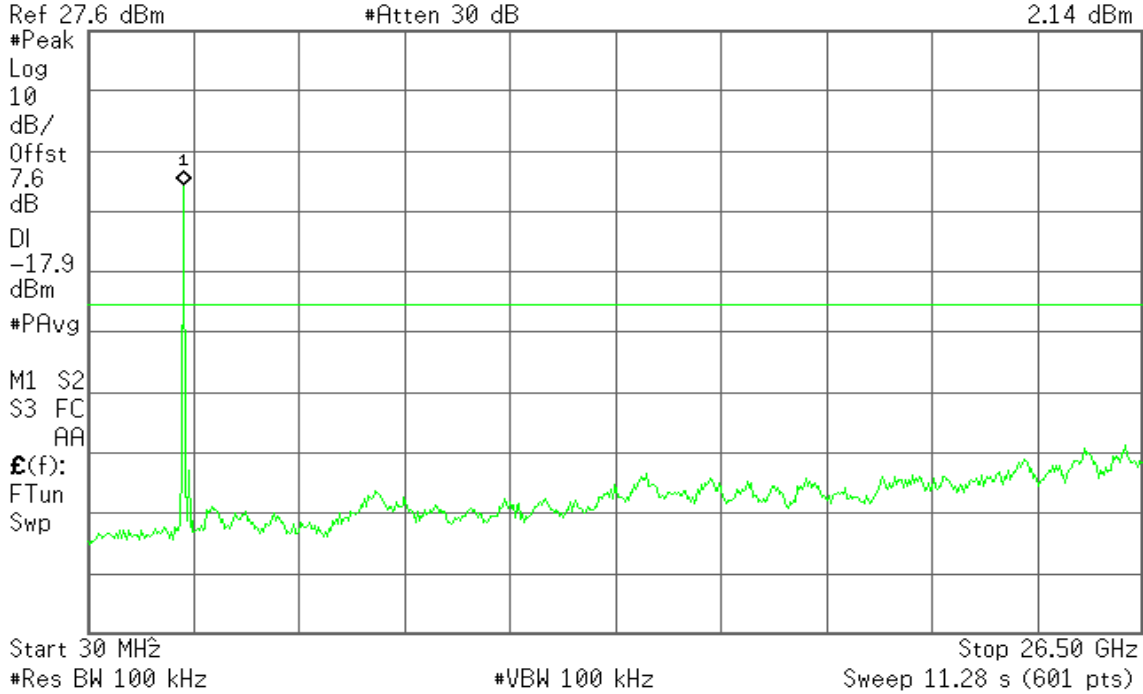

Agilent

R T

Mkr1 2.46 GHz
4.11 dBm

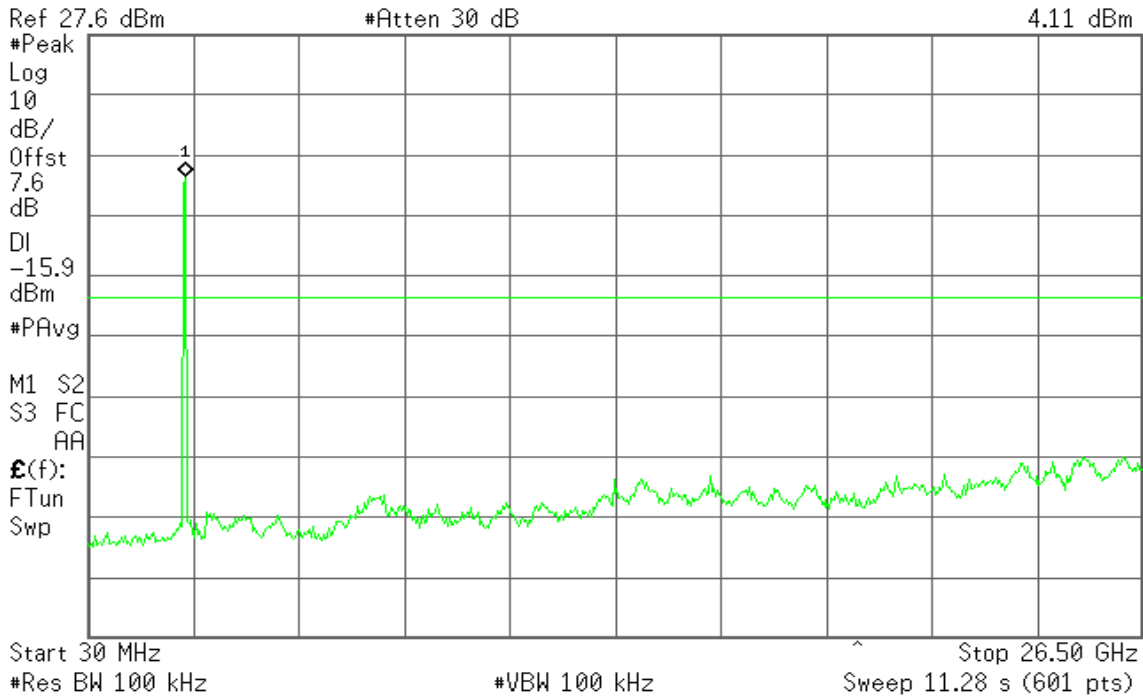



Agilent

R T

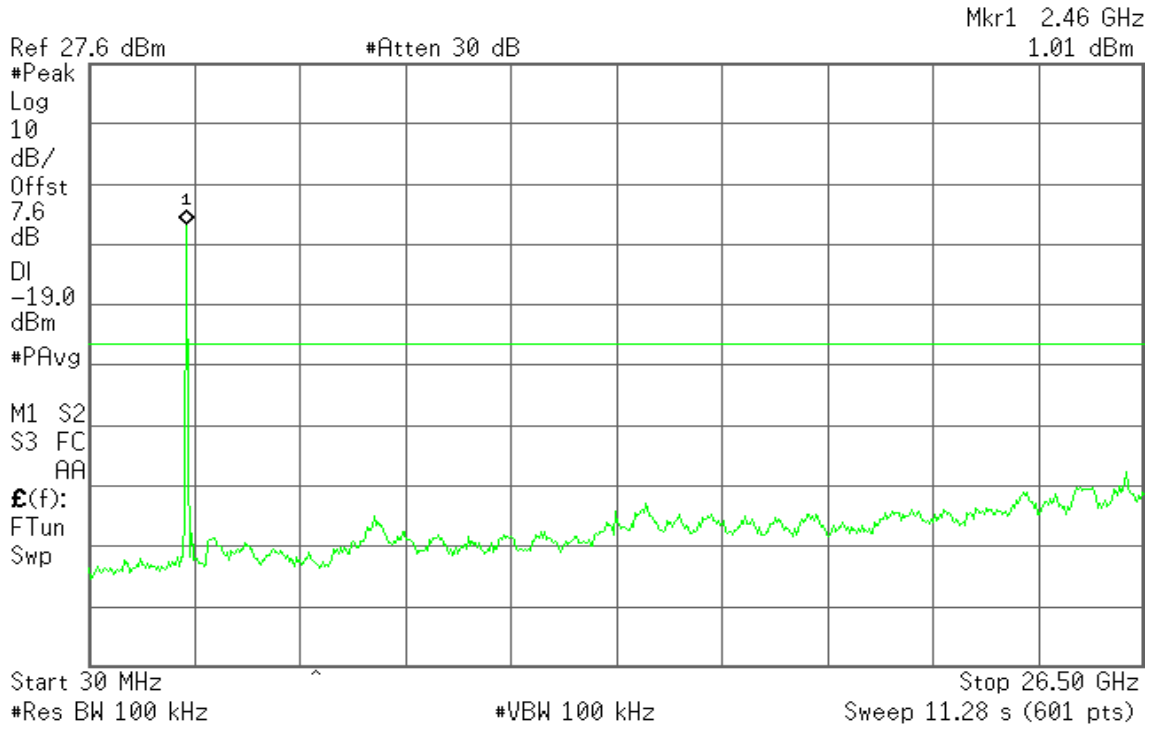



Conducted band-edge

IEEE 802.11b mode

CH Low

Agilent

R T

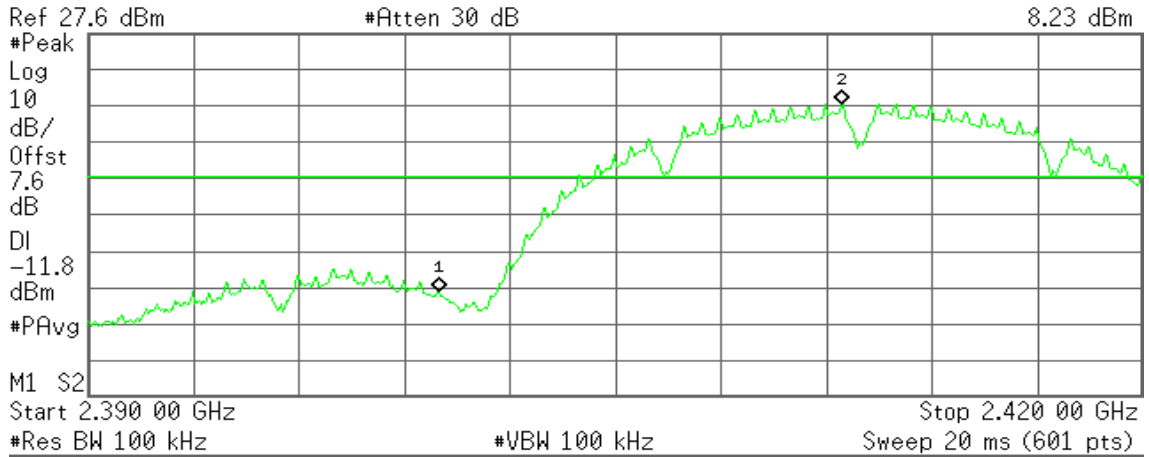

Marker	Trace	Type	X Axis	Amplitude
1	(1)	Freq	2.400 00 GHz	-43.22 dBm
2	(1)	Freq	2.411 45 GHz	8.23 dBm

CH High

Agilent

R T



Marker	Trace	Type	X Axis	Amplitude
1	(1)	Freq	2.463 47 GHz	8.48 dBm
2	(1)	Freq	2.483 50 GHz	-52.02 dBm



IEEE 802.11g mode

CH Low

Agilent

R T

Mkr2 2.414 45 GHz
3.49 dBm

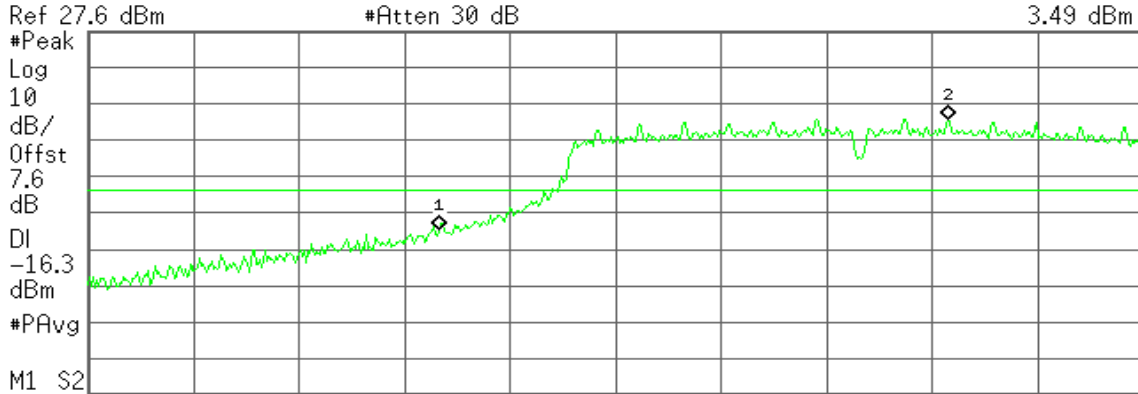

Start 2.390 00 GHz Stop 2.420 00 GHz
 #Res BW 100 kHz #VBW 100 kHz Sweep 20 ms (601 pts)

Marker	Trace	Type	X Axis	Amplitude
1	(1)	Freq	2.400 00 GHz	-27.01 dBm
2	(1)	Freq	2.414 45 GHz	3.49 dBm

CH High

Agilent

R T

Mkr1 2.463 20 GHz
3.72 dBm

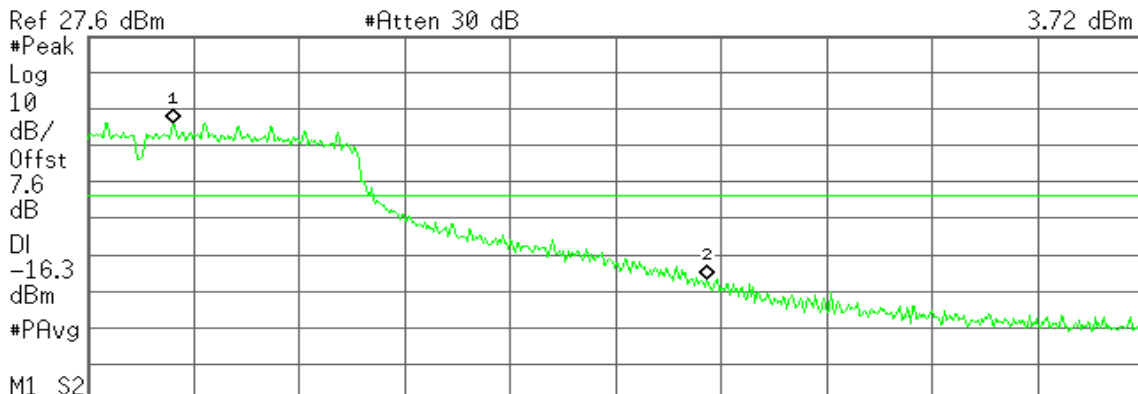

Start 2.460 00 GHz Stop 2.500 00 GHz
 #Res BW 100 kHz #VBW 100 kHz Sweep 20 ms (601 pts)

Marker	Trace	Type	X Axis	Amplitude
1	(1)	Freq	2.463 20 GHz	3.72 dBm
2	(1)	Freq	2.483 50 GHz	-39.19 dBm



IEEE 802.11n HT20 mode

CH Low

Agilent

R T

Mkr2 2.413 25 GHz
3.37 dBm

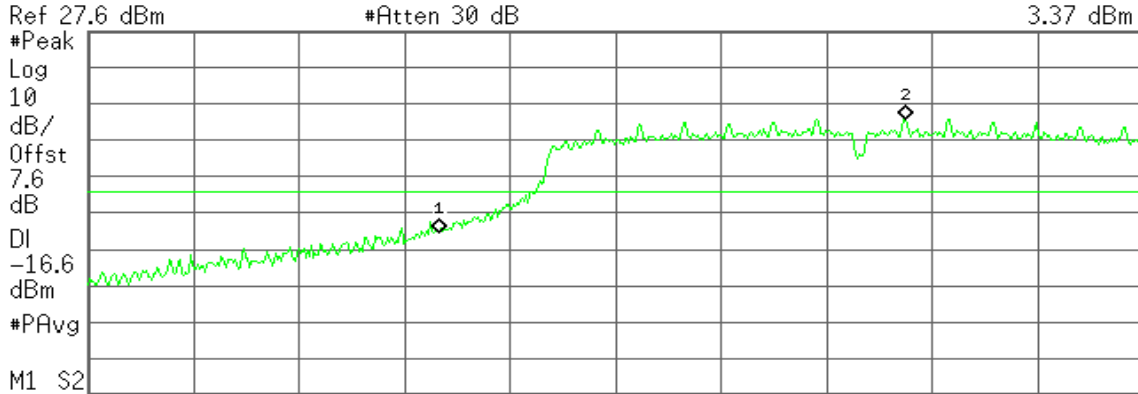

Marker	Trace	Type	X Axis	Amplitude
1	(1)	Freq	2.400 00 GHz	-27.73 dBm
2	(1)	Freq	2.413 25 GHz	3.37 dBm

CH High

Agilent

R T

Mkr1 2.464 47 GHz
3.86 dBm

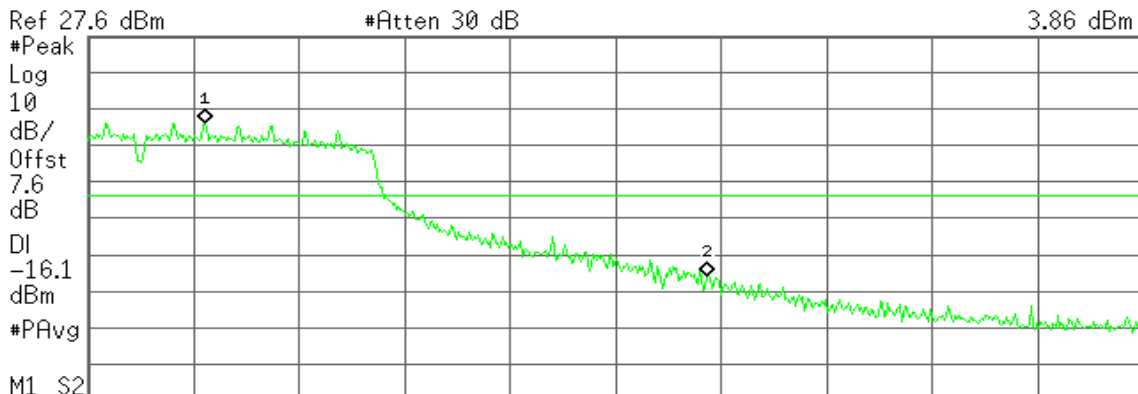

Marker	Trace	Type	X Axis	Amplitude
1	(1)	Freq	2.464 47 GHz	3.86 dBm
2	(1)	Freq	2.483 50 GHz	-38.28 dBm



7.6.2 RADIATED EMISSIONS

LIMIT

1. According to §15.209(a), except as provided elsewhere in this Subpart, the emissions from an intentional radiator shall not exceed the field strength levels specified in the following table:

Frequency (MHz)	Field Strength ($\mu\text{V}/\text{m}$)	Measurement Distance (m)
30-88	100*	3
88-216	150*	3
216-960	200*	3
Above 960	500	3

Remark: Except as provided in paragraph (g), fundamental emissions from intentional radiators operating under this Section shall not be located in the frequency bands 54-72 MHz, 76-88 MHz, 174-216 MHz or 470-806 MHz. However, operation within these frequency bands is permitted under other sections of this Part, e.g., Sections 15.231 and 15.241.

2. In the emission table above, the tighter limit applies at the band edges.

Frequency (MHz)	Field Strength ($\mu\text{V}/\text{m}$ at 3-meter)	Field Strength (dB $\mu\text{V}/\text{m}$ at 3-meter)
30-88	100	40
88-216	150	43.5
216-960	200	46
Above 960	500	54



TEST CONFIGURATION

Below 1 GHz

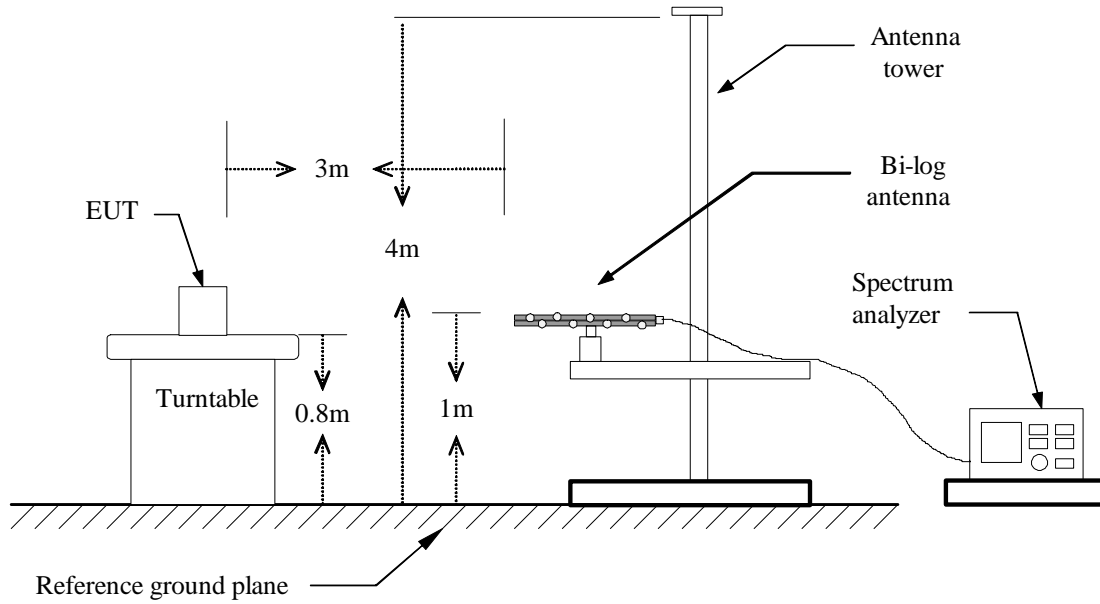

Above 1 GHz

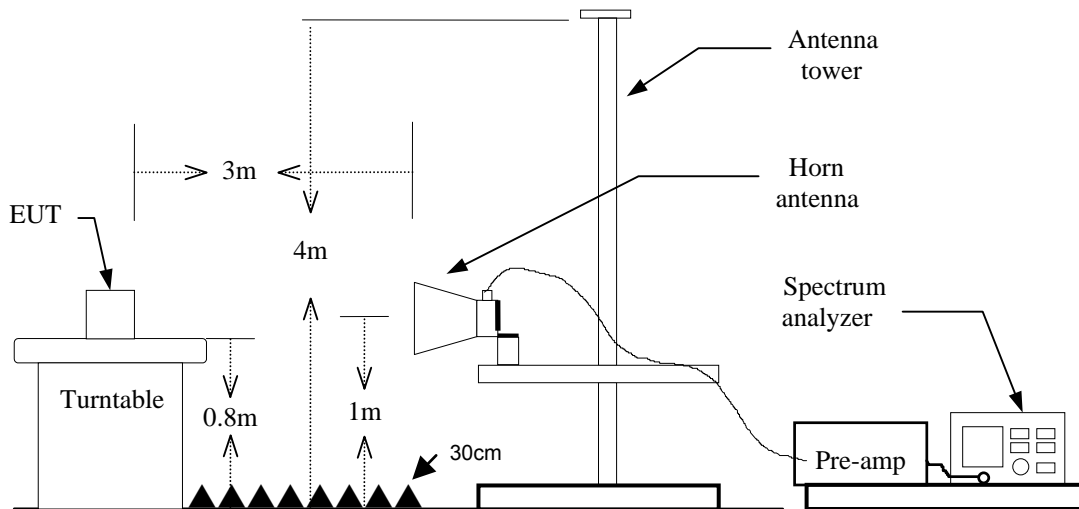



TEST PROCEDURE

1. The EUT is placed on a turntable, which is 0.8m above ground plane.
2. The turntable shall be rotated for 360 degrees to determine the position of maximum emission level.
3. EUT is set 3m away from the receiving antenna, which is varied from 1m to 4m to find out the highest emissions.
4. Maximum procedure was performed on the six highest emissions to ensure EUT compliance.
5. And also, each emission was to be maximized by changing the polarization of receiving antenna both horizontal and vertical.
6. Set the spectrum analyzer in the following setting as:

Below 30MHz

RBW=10kHz / VBW=30kHz / Sweep=AUTO

30 ~ 1000MHz:

RBW=100kHz / VBW=300KHz / Sweep=AUTO

Above 1GHz:

a) PEAK:RBW=1MHz VBW=RBW*3 / Sweep=100ms

b) AVERAGE: RBW=1MHz / VBW=300Hz / Sweep=AUTO

7. Repeat above procedures until the measurements for all frequencies are complete.

TEST RESULTS

No non-compliance noted.



TEST DATA

Below 1GHz

Operation Mode: Data Link **Test Date:** 2013/9/30
Temperature: 26°C **Tested by:** Louis Shen
Humidity: 56% RH **Polarity:** Ver. / Hor.

Frequency (MHz)	Reading (dBuV)	Correction Factor (dB/m)	Result (dBuV/m)	Limit (dBuV/m)	Margin (dB)	Ant. Pol. (H/V)	Remark
35.8200	22.00	-11.29	10.71	40.00	-29.29	V	QP
75.2000	35.30	-20.45	14.85	40.00	-25.15	V	QP
647.9900	51.80	-7.00	44.80	46.00	-1.20	V	QP
678.8500	32.90	-6.82	26.08	46.00	-19.92	V	QP
699.3000	27.91	-6.72	21.19	46.00	-24.81	V	QP
771.4254	39.50	-5.50	34.00	46.00	-12.00	V	QP
894.8600	34.00	-3.54	30.46	46.00	-15.54	V	QP
36.0168	50.30	-11.40	38.90	40.00	-1.10	H	QP
75.1000	51.00	-20.46	30.54	40.00	-9.46	H	QP
92.5500	46.50	-17.72	28.78	43.50	-14.72	H	QP
339.4300	36.70	-11.13	25.57	46.00	-20.43	H	QP
647.9967	41.10	-7.00	34.10	46.00	-11.90	H	QP
802.3000	43.00	-5.07	37.93	46.00	-8.07	H	QP
898.6500	33.70	-3.47	30.23	46.00	-15.77	H	QP
36.0168	50.30	-11.40	38.90	40.00	-1.10	H	QP

Remark:

1. No emission found between lowest internal used / generated frequency to 30 MHz. (9kHz ~ 30MHz)
2. Measuring frequencies from 9 kHz to the 1GHz.
3. Radiated emissions measured in the measured frequency range were made with an instrument using peak detector or quasi-peak detector mode.
4. Data of measurement within this frequency range shown " --- " in the table above means the reading of emissions are attenuated more than 20dB below the permissible limits or the field strength is too small to be measured.
5. The IF bandwidth of SPA between 30MHz to 1GHz was 100kHz.



Above 1 GHz

Operation Mode: TX / IEEE 802.11b / CH Low

Test Date: 2013/9/27

Temperature: 26°C

Tested by: Francis Lee

Humidity: 56% RH

Polarity: Ver. / Hor.

Freq. (MHz)	Reading (dBuV)	Correct Factor (dB/m)	Result (dBuV/m)	Limit (dBuV/m)	Margin (dB)	Ant. Pol H/V	Remark
1482.000	53.95	-5.51	48.44	74.00	-25.56	V	peak
2208.000	52.77	-1.35	51.42	74.00	-22.58	V	peak
2786.000	52.45	-2.01	50.44	74.00	-23.56	V	peak
3780.000	35.55	3.45	39.00	74.00	-35.00	V	peak
5225.000	34.16	5.46	39.62	74.00	-34.38	V	peak
7610.000	34.34	11.79	46.13	74.00	-27.87	V	peak
1454.000	52.69	-8.03	44.66	74.00	-29.34	H	peak
2226.000	52.79	-4.29	48.50	74.00	-25.50	H	peak
2588.000	52.00	-3.41	48.59	74.00	-25.41	H	peak
4350.000	35.47	7.29	42.76	74.00	-31.24	H	peak
5520.000	34.89	8.93	43.82	74.00	-30.18	H	peak
7275.000	33.82	11.49	45.31	74.00	-28.69	H	peak

Remark:

1. Measuring frequencies from 1 GHz to the 10th harmonic of highest fundamental frequency.
2. Radiated emissions measured in frequency above 1000MHz were made with an instrument using peak/average detector mode.
3. Average test would be performed if the peak result were greater than the average limit or as required by the applicant.
4. Data of measurement within this frequency range shown " --- " in the table above means the reading of emissions are attenuated more than 20dB below the permissible limits or the field strength is too small to be measured.
5. Measurements above show only up to 6 maximum emissions noted, or would be lesser, with " N/A " remark, if no specific emissions from the EUT are recorded (ie: margin>20dB from the applicable limit) and considered that's already beyond the background noise floor.



Operation Mode: TX / IEEE 802.11b / CH Mid

Test Date: 2013/9/27

Temperature: 26°C

Tested by: Francis Lee

Humidity: 56% RH

Polarity: Ver. / Hor.

Freq. (MHz)	Reading (dBuV)	Correct Factor (dB/m)	Result (dBuV/m)	Limit (dBuV/m)	Margin (dB)	Ant. Pol H/V	Remark
1628.000	53.13	-5.03	48.10	74.00	-25.90	V	peak
2132.000	55.72	-2.85	52.87	74.00	-21.13	V	peak
2132.000	41.32	-2.85	38.47	54.00	-15.53	V	AVG
2516.000	58.62	-1.13	57.49	74.00	-16.51	V	peak
2516.000	39.81	-1.13	38.68	54.00	-15.32	V	peak
3815.000	36.03	3.36	39.39	74.00	-34.61	V	peak
5505.000	33.41	6.21	39.62	74.00	-34.38	V	peak
7260.000	34.41	10.31	44.72	74.00	-29.28	V	peak
1474.000	53.30	-8.45	44.85	74.00	-29.15	H	peak
2132.000	53.68	-3.71	49.97	74.00	-24.03	H	peak
2718.000	52.55	-3.21	49.34	74.00	-24.66	H	peak
3840.000	36.11	5.15	41.26	74.00	-32.74	H	peak
5605.000	33.29	9.14	42.43	74.00	-31.57	H	peak
7295.000	34.45	11.75	46.20	74.00	-27.80	H	peak

Remark:

1. Measuring frequencies from 1 GHz to the 10th harmonic of highest fundamental frequency.
2. Radiated emissions measured in frequency above 1000MHz were made with an instrument using peak/average detector mode.
3. Average test would be performed if the peak result were greater than the average limit or as required by the applicant.
4. Data of measurement within this frequency range shown " --- " in the table above means the reading of emissions are attenuated more than 20dB below the permissible limits or the field strength is too small to be measured.
5. Measurements above show only up to 6 maximum emissions noted, or would be lesser, with " N/A " remark, if no specific emissions from the EUT are recorded (ie: margin>20dB from the applicable limit) and considered that's already beyond the background noise floor.



Operation Mode: TX / IEEE 802.11b / CH High

Test Date: 2013/9/27

Temperature: 26°C

Tested by: Francis Lee

Humidity: 56% RH

Polarity: Ver. / Hor.

Freq. (MHz)	Reading (dBuV)	Correct Factor (dB/m)	Result (dBuV/m)	Limit (dBuV/m)	Margin (dB)	Ant. Pol H/V	Remark
1476.000	52.86	-5.59	47.27	74.00	-26.73	V	peak
2132.000	55.65	-2.85	52.80	74.00	-21.20	V	peak
2132.000	38.27	-2.85	35.42	54.00	-18.58	V	AVG
2132.000	41.98	-2.85	39.13	54.00	-14.87	V	AVG
2584.000	54.90	-1.97	52.93	74.00	-21.07	V	peak
3795.000	35.31	3.63	38.94	74.00	-35.06	V	peak
5135.000	35.09	4.78	39.87	74.00	-34.13	V	peak
7385.000	34.31	11.18	45.49	74.00	-28.51	V	peak
1416.000	51.69	-7.24	44.45	74.00	-29.55	H	peak
2134.000	54.03	-3.71	50.32	74.00	-23.68	H	peak
2748.000	51.62	-2.94	48.68	74.00	-25.32	H	peak
3905.000	35.59	5.20	40.79	74.00	-33.21	H	peak
5575.000	33.55	9.11	42.66	74.00	-31.34	H	peak
7280.000	34.76	11.55	46.31	74.00	-27.69	H	peak

Remark:

1. Measuring frequencies from 1 GHz to the 10th harmonic of highest fundamental frequency.
2. Radiated emissions measured in frequency above 1000MHz were made with an instrument using peak/average detector mode.
3. Average test would be performed if the peak result were greater than the average limit or as required by the applicant.
4. Data of measurement within this frequency range shown " --- " in the table above means the reading of emissions are attenuated more than 20dB below the permissible limits or the field strength is too small to be measured.
5. Measurements above show only up to 6 maximum emissions noted, or would be lesser, with " N/A " remark, if no specific emissions from the EUT are recorded (ie: margin>20dB from the applicable limit) and considered that's already beyond the background noise floor.



Operation Mode: TX / IEEE 802.11g / CH Low

Test Date: 2013/9/27

Temperature: 26°C

Tested by: Francis Lee

Humidity: 56% RH

Polarity: Ver. / Hor.

Freq. (MHz)	Reading (dBuV)	Correct Factor (dB/m)	Result (dBuV/m)	Limit (dBuV/m)	Margin (dB)	Ant. Pol H/V	Remark
2132.000	53.43	-2.85	50.58	74.00	-23.42	V	peak
2496.000	54.45	-0.96	53.49	74.00	-20.51	V	peak
2496.000	38.77	-0.96	37.81	54.00	-16.19	V	AVG
2576.000	56.41	-1.87	54.54	74.00	-19.46	V	peak
2576.000	38.17	-1.87	36.30	54.00	-17.70	V	AVG
3805.000	35.47	3.58	39.05	74.00	-34.95	V	peak
5670.000	34.91	5.93	40.84	74.00	-33.16	V	peak
7540.000	34.02	11.69	45.71	74.00	-28.29	V	peak
1410.000	52.02	-7.11	44.91	74.00	-29.09	H	peak
2134.000	53.55	-3.71	49.84	74.00	-24.16	H	peak
2836.000	50.92	-2.21	48.71	74.00	-25.29	H	peak
3865.000	36.17	5.18	41.35	74.00	-32.65	H	peak
5580.000	33.95	9.13	43.08	74.00	-30.92	H	peak
7285.000	33.37	11.62	44.99	74.00	-29.01	H	peak

Remark:

1. Measuring frequencies from 1 GHz to the 10th harmonic of highest fundamental frequency.
2. Radiated emissions measured in frequency above 1000MHz were made with an instrument using peak/average detector mode.
3. Average test would be performed if the peak result were greater than the average limit or as required by the applicant.
4. Data of measurement within this frequency range shown " --- " in the table above means the reading of emissions are attenuated more than 20dB below the permissible limits or the field strength is too small to be measured.
5. Measurements above show only up to 6 maximum emissions noted, or would be lesser, with " N/A " remark, if no specific emissions from the EUT are recorded (ie: margin>20dB from the applicable limit) and considered that's already beyond the background noise floor.



Operation Mode: TX / IEEE 802.11g / CH Mid

Test Date: 2013/9/27

Temperature: 26°C

Tested by: Francis Lee

Humidity: 56% RH

Polarity: Ver. / Hor.

Freq. (MHz)	Reading (dBuV)	Correct Factor (dB/m)	Result (dBuV/m)	Limit (dBuV/m)	Margin (dB)	Ant. Pol H/V	Remark
1984.000	51.65	-1.55	50.10	74.00	-23.90	V	peak
2520.000	55.32	-1.18	54.14	74.00	-19.86	V	peak
2520.000	38.44	-1.18	37.26	54.00	-16.74	V	AVG
2600.000	55.23	-2.17	53.06	74.00	-20.94	V	peak
2600.000	38.44	-2.17	36.27	54.00	-17.73	V	AVG
3800.000	35.37	3.69	39.06	74.00	-34.94	V	peak
5140.000	34.97	4.84	39.81	74.00	-34.19	V	peak
7570.000	34.50	11.80	46.30	74.00	-27.70	V	peak
1356.000	52.46	-8.03	44.43	74.00	-29.57	H	peak
2102.000	52.36	-3.78	48.58	74.00	-25.42	H	peak
2728.000	52.00	-3.12	48.88	74.00	-25.12	H	peak
4345.000	34.20	7.33	41.53	74.00	-32.47	H	peak
5640.000	34.08	8.76	42.84	74.00	-31.16	H	peak
7260.000	33.63	11.29	44.92	74.00	-29.08	H	peak

Remark:

1. Measuring frequencies from 1 GHz to the 10th harmonic of highest fundamental frequency.
2. Radiated emissions measured in frequency above 1000MHz were made with an instrument using peak/average detector mode.
3. Average test would be performed if the peak result were greater than the average limit or as required by the applicant.
4. Data of measurement within this frequency range shown " --- " in the table above means the reading of emissions are attenuated more than 20dB below the permissible limits or the field strength is too small to be measured.
5. Measurements above show only up to 6 maximum emissions noted, or would be lesser, with " N/A " remark, if no specific emissions from the EUT are recorded (ie: margin>20dB from the applicable limit) and considered that's already beyond the background noise floor.



Operation Mode: TX / IEEE 802.11g / CH High

Test Date: 2013/9/27

Temperature: 26°C

Tested by: Francis Lee

Humidity: 56% RH

Polarity: Ver. / Hor.

Freq. (MHz)	Reading (dBuV)	Correct Factor (dB/m)	Result (dBuV/m)	Limit (dBuV/m)	Margin (dB)	Ant. Pol H/V	Remark
1986.000	51.83	-1.52	50.31	74.00	-23.69	V	peak
2580.000	54.38	-1.92	52.46	74.00	-21.54	V	peak
2580.000	38.20	-1.92	36.28	54.00	-17.72	V	AVG
2628.000	60.41	-1.97	58.44	74.00	-15.56	V	peak
2628.000	38.97	-1.97	37.00	54.00	-17.00	V	AVG
3740.000	36.38	2.96	39.34	74.00	-34.66	V	peak
6400.000	34.92	6.58	41.50	74.00	-32.50	V	peak
7610.000	33.66	11.79	45.45	74.00	-28.55	V	peak
1408.000	51.71	-7.07	44.64	74.00	-29.36	H	peak
2132.000	52.44	-3.71	48.73	74.00	-25.27	H	peak
2778.000	51.65	-2.68	48.97	74.00	-25.03	H	peak
3785.000	35.92	4.90	40.82	74.00	-33.18	H	peak
5605.000	33.58	9.14	42.72	74.00	-31.28	H	peak
7320.000	34.08	11.72	45.80	74.00	-28.20	H	peak

Remark:

1. Measuring frequencies from 1 GHz to the 10th harmonic of highest fundamental frequency.
2. Radiated emissions measured in frequency above 1000MHz were made with an instrument using peak/average detector mode.
3. Average test would be performed if the peak result were greater than the average limit or as required by the applicant.
4. Data of measurement within this frequency range shown " --- " in the table above means the reading of emissions are attenuated more than 20dB below the permissible limits or the field strength is too small to be measured.
5. Measurements above show only up to 6 maximum emissions noted, or would be lesser, with " N/A " remark, if no specific emissions from the EUT are recorded (ie: margin>20dB from the applicable limit) and considered that's already beyond the background noise floor.



Operation Mode: TX / IEEE 802.11n HT20 / CH Low

Test Date: 2013/9/27

Temperature: 26°C

Tested by: Francis Lee

Humidity: 56% RH

Polarity: Ver. / Hor.

Freq. (MHz)	Reading (dBuV)	Correct Factor (dB/m)	Result (dBuV/m)	Limit (dBuV/m)	Margin (dB)	Ant. Pol H/V	Remark
2008.000	51.80	-1.48	50.32	74.00	-23.68	V	peak
2494.000	55.67	-0.97	54.70	74.00	-19.30	V	peak
2494.000	39.53	-0.97	38.56	54.00	-15.44	V	AVG
2574.000	57.11	-1.85	55.26	74.00	-18.74	V	peak
2574.000	38.37	-1.85	36.52	54.00	-17.48	V	AVG
3795.000	36.07	3.63	39.70	74.00	-34.30	V	peak
5640.000	34.35	5.92	40.27	74.00	-33.73	V	peak
7640.000	34.47	11.45	45.92	74.00	-28.08	V	peak
1352.000	53.01	-8.13	44.88	74.00	-29.12	H	peak
1752.000	53.86	-7.17	46.69	74.00	-27.31	H	peak
2630.000	52.29	-3.36	48.93	74.00	-25.07	H	peak
4320.000	35.37	7.51	42.88	74.00	-31.12	H	peak
5550.000	34.10	9.03	43.13	74.00	-30.87	H	peak
7315.000	34.39	11.74	46.13	74.00	-27.87	H	peak

Remark:

1. Measuring frequencies from 1 GHz to the 10th harmonic of highest fundamental frequency.
2. Radiated emissions measured in frequency above 1000MHz were made with an instrument using peak/average detector mode.
3. Average test would be performed if the peak result were greater than the average limit or as required by the applicant.
4. Data of measurement within this frequency range shown " --- " in the table above means the reading of emissions are attenuated more than 20dB below the permissible limits or the field strength is too small to be measured.
5. Measurements above show only up to 6 maximum emissions noted, or would be lesser, with " N/A " remark, if no specific emissions from the EUT are recorded (ie: margin>20dB from the applicable limit) and considered that's already beyond the background noise floor.



Operation Mode: TX / IEEE 802.11n HT20 / CH Mid

Test Date: 2013/9/27

Temperature: 26°C

Tested by: Francis Lee

Humidity: 56% RH

Polarity: Ver. / Hor.

Freq. (MHz)	Reading (dBuV)	Correct Factor (dB/m)	Result (dBuV/m)	Limit (dBuV/m)	Margin (dB)	Ant. Pol H/V	Remark
1492.000	52.68	-5.37	47.31	74.00	-26.69	V	peak
1988.000	51.45	-1.49	49.96	74.00	-24.04	V	peak
2520.000	57.04	-1.18	55.86	74.00	-18.14	V	peak
2520.000	38.00	-1.18	36.82	54.00	-17.18	V	AVG
3835.000	35.91	2.91	38.82	74.00	-35.18	V	peak
5425.000	33.76	6.35	40.11	74.00	-33.89	V	peak
7580.000	34.06	11.84	45.90	74.00	-28.10	V	peak
1486.000	53.17	-8.71	44.46	74.00	-29.54	H	peak
2118.000	52.22	-3.74	48.48	74.00	-25.52	H	peak
2782.000	51.10	-2.64	48.46	74.00	-25.54	H	peak
3830.000	36.16	5.14	41.30	74.00	-32.70	H	peak
5960.000	34.93	8.99	43.92	74.00	-30.08	H	peak
7345.000	33.91	11.59	45.50	74.00	-28.50	H	peak

Remark:

1. Measuring frequencies from 1 GHz to the 10th harmonic of highest fundamental frequency.
2. Radiated emissions measured in frequency above 1000MHz were made with an instrument using peak/average detector mode.
3. Average test would be performed if the peak result were greater than the average limit or as required by the applicant.
4. Data of measurement within this frequency range shown " --- " in the table above means the reading of emissions are attenuated more than 20dB below the permissible limits or the field strength is too small to be measured.
5. Measurements above show only up to 6 maximum emissions noted, or would be lesser, with " N/A " remark, if no specific emissions from the EUT are recorded (ie: margin>20dB from the applicable limit) and considered that's already beyond the background noise floor.



Operation Mode: TX / IEEE 802.11n HT20 / CH High

Test Date: 2013/9/27

Temperature: 26°C

Tested by: Francis Lee

Humidity: 56% RH

Polarity: Ver. / Hor.

Freq. (MHz)	Reading (dBuV)	Correct Factor (dB/m)	Result (dBuV/m)	Limit (dBuV/m)	Margin (dB)	Ant. Pol H/V	Remark
1508.000	52.26	-5.22	47.04	74.00	-26.96	V	peak
1992.000	51.80	-1.43	50.37	74.00	-23.63	V	peak
2546.000	53.89	-1.50	52.39	74.00	-21.61	V	peak
2546.000	38.08	-1.50	36.58	54.00	-17.42	V	AVG
3640.000	36.16	2.75	38.91	74.00	-35.09	V	peak
5940.000	35.27	5.84	41.11	74.00	-32.89	V	peak
7620.000	34.58	11.68	46.26	74.00	-27.74	V	peak
1390.000	51.27	-7.16	44.11	74.00	-29.89	H	peak
2132.000	52.42	-3.71	48.71	74.00	-25.29	H	peak
2772.000	51.47	-2.73	48.74	74.00	-25.26	H	peak
3800.000	36.47	5.10	41.57	74.00	-32.43	H	peak
5615.000	34.06	9.03	43.09	74.00	-30.91	H	peak
7330.000	34.12	11.67	45.79	74.00	-28.21	H	peak

Remark:

1. Measuring frequencies from 1 GHz to the 10th harmonic of highest fundamental frequency.
2. Radiated emissions measured in frequency above 1000MHz were made with an instrument using peak/average detector mode.
3. Average test would be performed if the peak result were greater than the average limit or as required by the applicant.
4. Data of measurement within this frequency range shown " --- " in the table above means the reading of emissions are attenuated more than 20dB below the permissible limits or the field strength is too small to be measured.
5. Measurements above show only up to 6 maximum emissions noted, or would be lesser, with " N/A " remark, if no specific emissions from the EUT are recorded (ie: margin>20dB from the applicable limit) and considered that's already beyond the background noise floor.



Operation Mode: RX
Temperature: 26°C
Humidity: 56% RH

Test Date: 2013/9/27
Tested by: Francis Lee
Polarity: Ver. / Hor.

Table with 8 columns: Freq. (MHz), Reading (dBuV), Correct Factor (dB/m), Result (dBuV/m), Limit (dBuV/m), Margin (dB), Ant. Pol H/V, Remark. It contains two sets of data rows for different frequencies and antenna polarities.

Remark:

- 1. Measuring frequencies from 1 GHz to the 10th harmonic of highest fundamental frequency.
2. Radiated emissions measured in frequency above 1000MHz were made with an instrument using peak/average detector mode.
3. Average test would be performed if the peak result were greater than the average limit or as required by the applicant.
4. Data of measurement within this frequency range shown " --- " in the table above means the reading of emissions are attenuated more than 20dB below the permissible limits or the field strength is too small to be measured.
5. Measurements above show only up to 6 maximum emissions noted, or would be lesser, with " N/A " remark, if no specific emissions from the EUT are recorded (ie: margin>20dB from the applicable limit) and considered that's already beyond the background noise floor.



7.7 POWERLINE CONDUCTED EMISSIONS

LIMIT

According to §15.207(a), except as shown in paragraphs (b) and (c) of this section, for an intentional radiator that is designed to be connected to the public utility (AC) power line, the radio frequency voltage that is conducted back onto the AC power line on any frequency or frequencies within the band 150 kHz to 30 MHz shall not exceed the limits in the following table, as measured using a 50 μ H/50 ohms line impedance stabilization network (LISN). Compliance with the provisions of this paragraph shall be based on the measurement of the radio frequency voltage between each power line and ground at the power terminal. The lower limit applies at the boundary between the frequency ranges.

Frequency Range (MHz)	Limits (dB μ V)	
	Quasi-peak	Average
0.15 to 0.50	66 to 56*	56 to 46*
0.50 to 5	56	46
5 to 30	60	50

* Decreases with the logarithm of the frequency.

TEST CONFIGURATION

See test photographs attached in Appendix II for the actual connections between EUT and support equipment.

TEST PROCEDURE

1. The EUT was placed on a table, which is 0.8m above ground plane.
2. Maximum procedure was performed on the six highest emissions to ensure EUT compliance.
3. Repeat above procedures until all frequency measured were complete.

TEST RESULTS

The initial step in collecting conducted data is a spectrum analyzer peak scan of the measurement range. Significant peaks are then marked as shown on the following data page, and these signals are then quasi-peaked.

TEST DATA

Not applicable, because the EUT is not connected to AC Main Source directly.



8. APPENDIX I PHOTOGRAPHS OF TEST SETUP

Radiated Emissions Setup Photos

Below 1GHz

Data Link

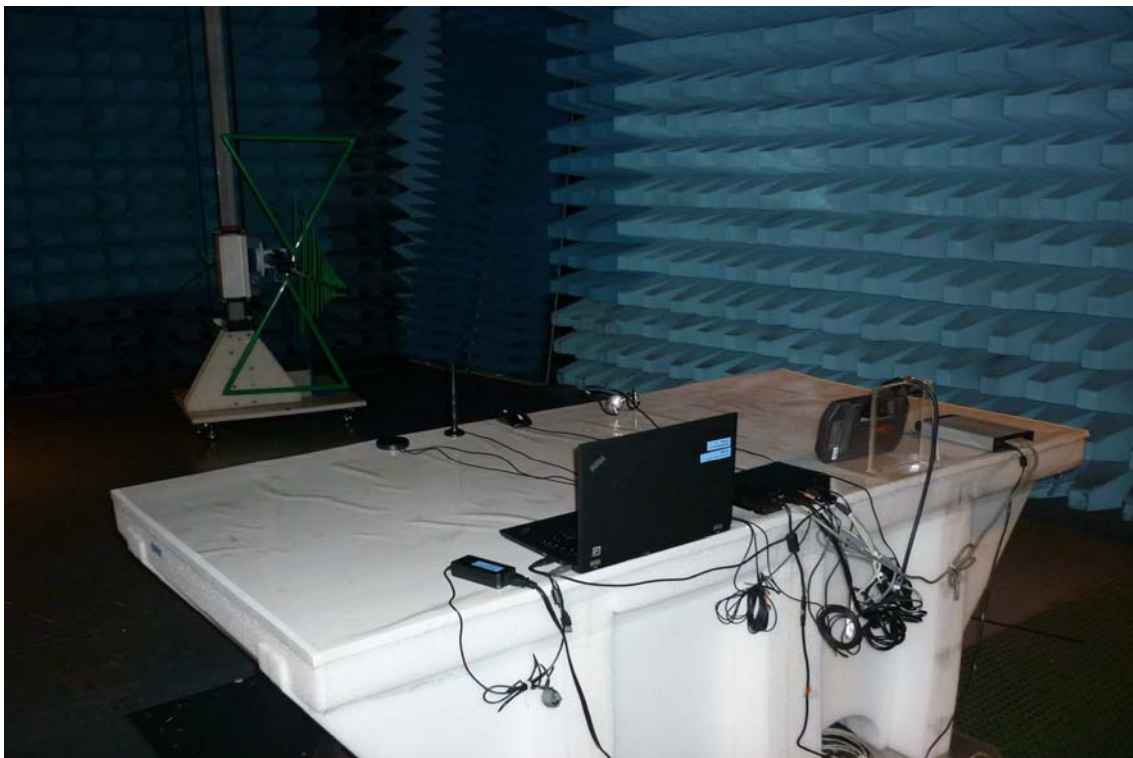



Above 1GHz Transmitting Mode





Conducted Emissions Setup Photo





APPENDIX 1: PHOTOGRAPHS OF EUT
Refer to T130822L04 External Photographs.