

## SAR Test Report

Product Name : PWS-8033M

Model No. : PWS-8033M-R0AE

Applicant : Advantech Co., Ltd

Address : 1, Alley 20, Lane 26, Rueiguang Rd, Neihu  
District, Taipei

Date of Receipt : 2009/02/10

Issued Date : 2009/03/24

Report No. : 093348R-HPUSP10V01

Version : V1.0

The test results relate only to the samples tested.

The test report shall not be reproduced except in full without the written approval of QuieTek Corporation.

# Test Report Certification

Issued Date: 2009/03/24

Report No.:093348R-HPUSP10V01



Product Name : PWS-8033M  
 Applicant : Advantech Co., Ltd  
 Address : 1, Alley 20, Lane 26, Rueiguang Rd, Neihu District, Taipei  
 Manufacturer : ACA Digital Corporation  
 Model No. : PWS-8033M-R0AE  
 Trade Name : ADVANTECH  
 FCC ID : M82-PWS-8033M  
 Applicable Standard : FCC Oet65 Supplement C June 2001  
 IEEE Std. 1528-2003 47CFR § 2.1093  
 Test Result : Max. SAR Measurement (1g)  
**0.054** W/kg  
 Application Type : Certification

The test results relate only to the samples tested.

The test report shall not be reproduced except in full without the written approval of Quietek Corporation.

Documented By : Nicole Huang  
 (Engineering Adm. Assistant / Nicole Huang)

Tested By : Jung Chang  
 (Engineer / Jung Chang)

Approved By : Vincent Lin  
 (Manager / Vincent Lin)

## TABLE OF CONTENTS

Description	Page
<b>1. General Information.....</b>	<b>5</b>
1.1 EUT Description .....	5
1.2 Test Environment .....	6
<b>2. SAR Measurement System.....</b>	<b>7</b>
2.1 ALSAS-10U System Description .....	7
2.1.1 Applications .....	7
2.1.2 Area Scans.....	7
2.1.3 Zoom Scan (Cube Scan Averaging).....	8
2.1.4 ALSAS-10U Interpolation and Extrapolation Uncertainty.....	8
2.2 Isotropic E-Field Probe .....	8
2.2.1 Isotropic E-Field Probe Specification .....	10
2.3 Boundary Detection Unit and Probe Mounting Device .....	10
2.4 Daq-Paq (Analog to Digital Electronics).....	11
2.5 Axis Articulated Robot .....	11
2.6 ALSAS Universal Workstation.....	12
2.7 Universal Device Positioner.....	12
2.8 Phantom Types.....	12
2.8.1 APREL SAM Phantoms .....	13
2.8.2 APREL Laboratories Universal Phantom .....	13
<b>3. Tissue Simulating Liquid .....</b>	<b>14</b>
3.1 The composition of the tissue simulating liquid .....	14
3.2 Tissue Calibration Result .....	14
3.3 Tissue Dielectric Parameters for Head and Body Phantoms .....	15
<b>4. SAR Measurement Procedure.....</b>	<b>16</b>
4.1 SAR System Validation.....	16
4.1.1 Validation Dipoles.....	16
4.1.2 Validation Result .....	16
4.2 SAR Measurement Procedure.....	17
<b>5. SAR Exposure Limits .....</b>	<b>18</b>
<b>6. Test Equipment List.....</b>	<b>19</b>
<b>7. Measurement Uncertainty.....</b>	<b>20</b>
<b>8. Test Results .....</b>	<b>21</b>
8.1 SAR Test Results Summary .....	21

Appendix..... 22

Appendix A. SAR System Validation Data

Appendix B. SAR measurement Data

Appendix C. Test Setup Photographs & EUT Photographs

Appendix D. Probe Calibration Data

Appendix E. Dipole Calibration Data

## 1. General Information

### 1.1 EUT Description

Product Name	PWS-8033M
Trade Name	ADVANTECH
Model No.	PWS-8033M-R0AE
FCC ID	M82-PWS-8033M
TX Frequency	2412MHz ~ 2462MHz
Number of Channel	11
Type of Modulation	DSSS/OFDM
Antenna Type	1/2 $\lambda$ DIPOLE Antenna
Device Category	Portable
RF Exposure Environment	Uncontrolled
Max. Output Power (Conducted)	802.11b: 15.80 dBm 802.11g: 17.29 dBm

Note: This report is copy QTK NO: 092100R-HPUSP10V01 merely to change Applicant Model and Trade Name.

## 1.2 Test Environment

Ambient conditions in the laboratory:

Items	Required	Actual
Temperature (°C)	18-25	22.2
Humidity (%RH)	30-70	51

Site Description:

Accredited by TAF  
 Accredited Number: 0914  
 Effective through: December 12, 2011



Site Name: Quietek Corporation

Site Address: No. 5, Ruei-Shu Valley, Ruei-Ping Tsuen,  
 Lin-Kou Shiang, Taipei,  
 Taiwan, R.O.C.  
 TEL : 886-2-8601-3788 / FAX : 886-2-8601-3789  
 E-Mail : [service@quietek.com](mailto:service@quietek.com)

## 2. SAR Measurement System

### 2.1 ALSAS-10U System Description

ALSAS-10-U is fully compliant with the technical and scientific requirements of IEEE 1528, IEC 62209, CENELEC, ARIB, ACA, and the Federal Communications Commission. The system comprises of a six axes articulated robot which utilizes a dedicated controller.

ALSAS-10U uses the latest methodologies and FDTD modeling to provide a platform which is repeatable with minimum uncertainty.

#### 2.1.1 Applications

Predefined measurement procedures compliant with the guidelines of CENELEC, IEEE, IEC, FCC, etc are utilized during the assessment for the device. Automatic detection for all SAR

maxima are embedded within the core architecture for the system, ensuring that peak locations used for centering the zoom scan are within a 1mm resolution and a 0.05mm repeatable position. System operation range currently available up-to 6 GHz in simulated tissue.

#### 2.1.2 Area Scans

Area scans are defined prior to the measurement process being executed with a user defined variable spacing between each measurement point (integral) allowing low uncertainty measurements to be conducted. Scans defined for FCC applications utilize a 10mm<sup>2</sup> step integral, with 1mm interpolation used to locate the peak SAR area used for zoom scan assessments.

Where the system identifies multiple SAR peaks (which are within 25% of peak value) the system will provide the user with the option of assessing each peak location individually for zoom scan averaging.



**2.1.3 Zoom Scan (Cube Scan Averaging)**

The averaging zoom scan volume utilized in the ALSAS-10U software is in the shape of a cube and the side dimension of a 1 g or 10 g mass is dependent on the density of the liquid representing the simulated tissue. A density of 1000 kg/m<sup>3</sup> is used to represent the head and body tissue density and not the phantom liquid density, in order to be consistent with the definition of the liquid dielectric properties, i.e. the side length of the 1 g cube is 10mm, with the side length of the 10 g cube 21,5mm.

When the cube intersects with the surface of the phantom, it is oriented so that 3 vertices touch the surface of the shell or the center of a face is tangent to the surface. The face of the cube closest to the surface is modified in order to conform to the tangent surface.

The zoom scan integer steps can be user defined so as to reduce uncertainty, but normal practice for typical test applications (including FCC) utilize a physical step of 5x5x8 (8mmx8mmx5mm) providing a volume of 32mm in the X & Y axis, and 35mm in the Z axis.

**2.1.4 ALSAS-10U Interpolation and Extrapolation Uncertainty**

The overall uncertainty for the methodology and algorithms the used during the SAR calculation was evaluated using the data from IEEE 1528 based on the example f3 algorithm:

$$f_3(x, y, z) = A \frac{a^2}{\frac{a^2}{4} + x'^2 + y'^2} \cdot \left( e^{-\frac{2z}{a}} + \frac{a^2}{2(a + 2z)^2} \right)$$

**2.2 Isotropic E-Field Probe**

The isotropic E-Field probe has been fully calibrated and assessed for isotropicity, and boundary effect within a controlled environment. Depending on the frequency for which the probe is calibrated the method utilized for calibration will change. A number of methods is used for calibrating probes, and these are outlined in the table below:

Calibration Frequency	Air Calibration	Tissue Calibration
2450MHz	TEM Cell	Temperature



The E-Field probe utilizes a triangular sensor arrangement as detailed in the diagram below:

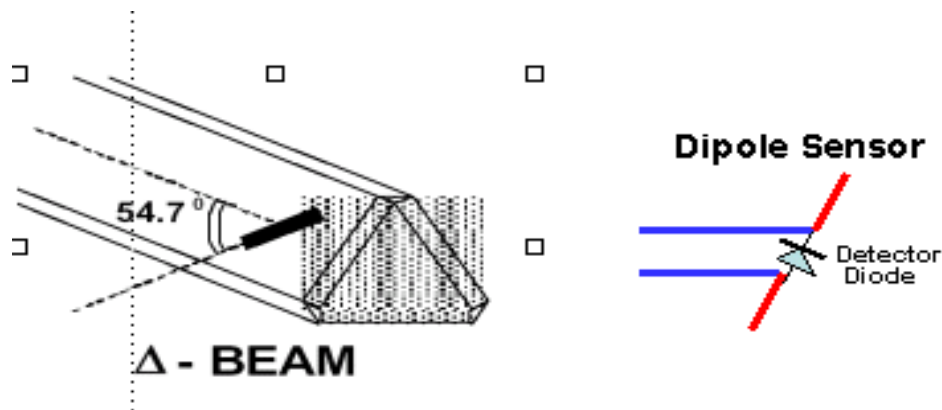

SAR is assessed with a calibrated probe which moves at a default height of 5mm from the center of the diode, which is mounted to the sensor, to the phantom surface (in the Z Axis). The 5mm offset height has been selected so as to minimize any resultant boundary effect due to the probe being in close proximity to the phantom surface.

The following algorithm is an example of the function used by the system for linearization of the output from the probe when measuring complex modulation schemes.

$$V_i = U_i + U_i^2 \cdot \frac{cf}{dcp_i}$$

**2.2.1 Isotropic E-Field Probe Specification**

<b>Calibration in Air</b>	Frequency Dependent Below 2GHz Calibration in air performed in a TEM Cell Above 2GHz Calibration in air performed in waveguide
<b>Sensitivity</b>	0.70 $\mu\text{V}/(\text{V}/\text{m})^2$ to 0.85 $\mu\text{V}/(\text{V}/\text{m})^2$
<b>Dynamic Range</b>	0.0005 W/kg to 100W/kg
<b>Isotropic Response</b>	Better than 0.2dB
<b>Diode Compression point (DCP)</b>	Calibration for Specific Frequency
<b>Probe Tip Radius</b>	< 5mm
<b>Sensor Offset</b>	1.56 (+/- 0.02mm)
<b>Probe Length</b>	290mm
<b>Video Bandwidth</b>	@ 500 Hz: 1dB @1.02 KHz: 3dB
<b>Boundary Effect</b>	Less than 2% for distance greater than 2.4mm
<b>Spatial Resolution</b>	Diameter less than 5mm Compliant with Standards

**2.3 Boundary Detection Unit and Probe Mounting Device**

ALSAS-10U incorporates a boundary detection unit with a sensitivity of 0.05mm for detecting all types of surfaces. The robust design allows for detection during probe tilt (probe normalize) exercises, and utilizes a second stage emergency stop. The signal electronics are fed directly into the robot controller for high accuracy surface detection in lateral and axial detection modes (X, Y, & Z).

The probe is mounted directly onto the Boundary Detection unit for accurate tooling and displacement calculations controlled by the robot kinematics. The probe is connect to an isolated probe interconnect where the output stage of the probe is fed directly into the amplifier stage of the Daq-Paq.

**2.4 Daq-Paq (Analog to Digital Electronics)**

ALSAS-10U incorporates a fully calibrated Daq-Paq (analog to digital conversion system) which has a 4 channel input stage, sent via a 2 stage auto-set amplifier module. The input signal is amplified accordingly so as to offer a dynamic range from 5µV to 800mV. Integration of the fields measured is carried out at board level utilizing a Co-Processor which then sends the measured fields down into the main computational module in digitized form via an RS232 communications port. Probe linearity and duty cycle compensation is carried out within the main Daq-Paq module.

<b>ADC</b>	12 Bit
<b>Amplifier Range</b>	20mV to 200mV and 150mV to 800mV
<b>Field Integration</b>	Local Co-Processor utilizing proprietary integration algorithms
<b>Number of Input Channels</b>	4 in total 3 dedicated and 1 spare
<b>Communication</b>	Packet data via RS232

**2.5 Axis Articulated Robot**



ALSAS-10U utilizes a six axis articulated robot, which is controlled using a Pentium based real-time movement controller. The movement kinematics engine utilizes proprietary (Thermo CRS) interpolation and extrapolation algorithms, which allow full freedom of movement for each of the six joints within the working envelope. Utilization of joint 6 allows for full probe rotation with a tolerance better than 0.05mm around the central axis.

<b>Robot/Controller Manufacturer</b>	Thermo CRS
<b>Number of Axis</b>	Six independently controlled axis
<b>Positioning Repeatability</b>	0.05mm
<b>Controller Type</b>	Single phase Pentium based C500C
<b>Robot Reach</b>	710mm
<b>Communication</b>	RS232 and LAN compatible

## 2.6 ALSAS Universal Workstation

ALSAS Universal workstation allows for repeatability and fast adaptability. It allows users to do calibration, testing and measurements using different types of phantoms with one set up, which significantly speeds up the measurement process.

## 2.7 Universal Device Positioner

The universal device positioner allow complete freedom of movement of the EUT. Developed to hold a EUT in a free-space scenario any additional loading attributable to the material used in the construction of the positioner has been eliminated. Repeatability has been enhanced through the linear scales which form the design used to indicate positioning for any given test scenario in all major axes. A 15° tilt indicator is included for the of aid cheek to tilt movements for head SAR analysis. Overall uncertainty for measurements have been reduced due to the design of the Universal device positioner, which allows positioning of a device in as near to a free-space scenario as possible, and by providing the means for complete repeatability.



## 2.8 Phantom Types

The ALSAS-10U allows the integration of multiple phantom types. SAM Phantoms fully compliant with IEEE 1528, Universal Phantom, and Universal Flat.

### 2.8.1 APREL SAM Phantoms

The SAM phantoms developed using the IEEE SAM CAD file. They are fully compliant with the requirements for both IEEE 1528 and FCC Supplement C. Both the left and right SAM phantoms are interchangeable, transparent and include the IEEE 1528 grid with visible NF and MB lines.

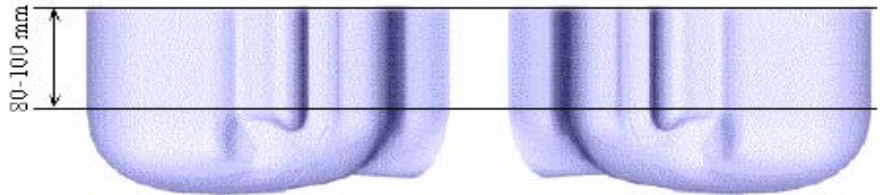

### 2.8.2 APREL Laboratories Universal Phantom

The Universal Phantom is used on the ALSAS-10U as a system validation phantom. The Universal Phantom has been fully validated both experimentally from 800MHz to 6GHz and numerically using XFDTD numerical software. The shell thickness is 2mm overall, with a 4mm spacer located at the NF/MB intersection providing an overall thickness of 6mm in line with the requirements of IEEE-1528.

The design allows for fast and accurate measurements, of handsets, by allowing the conservative SAR to be evaluated at on frequency for both left and right head experiments in one measurement.



**3. Tissue Simulating Liquid**

**3.1 The composition of the tissue simulating liquid**

INGREDIENT (% Weight)	900MHz Head	1800MHz Head	2450MHz Head	2450MHz Body
<b>Water</b>	--	--	46.7	73.2
<b>Salt</b>	--	--	0.00	0.04
<b>Sugar</b>	--	--	0.00	0.00
<b>HEC</b>	--	--	0.00	0.00
<b>Preventol</b>	--	--	0.00	0.00
<b>DGBE</b>	--	--	53.3	26.7

**3.2 Tissue Calibration Result**

The dielectric parameters of the liquids were verified prior to the SAR evaluation using APREL Dielectric Probe Kit and Anritsu MS4623B Vector Network Analyzer.

<b>Head Tissue Simulant Measurement</b>				
Frequency [MHz]	Description	Dielectric Parameters		Tissue Temp. [°C]
		$\epsilon_r$	$\sigma$ [s/m]	
2450MHz	Reference result ± 5% window	40.1 38.095 to 42.105	1.78 1.691 to 1.869	N/A
	10-Mar-09	41.69	1.81	21.4

<b>Body Tissue Simulant Measurement</b>				
Frequency [MHz]	Description	Dielectric Parameters		Tissue Temp. [°C]
		$\epsilon_r$	$\sigma$ [s/m]	
2450MHz	Reference result ± 5% window	52.7 50.065 to 55.335	1.95 1.8525 to 2.0475	N/A
	10-Mar-09	53.64	1.97	21.4
2412 MHz	Low channel	53.79	1.89	21.4
2437 MHz	Mid channel	53.73	1.93	21.4
2462 MHz	High channel	53.43	2.01	21.4

**3.3 Tissue Dielectric Parameters for Head and Body Phantoms**

The head tissue dielectric parameters recommended by the IEEE SCC-34/SC-2 in P1528 have been incorporated in the following table. These head parameters are derived from planar layer models simulating the highest expected SAR for the dielectric properties and tissue thickness variations in a human head. Other head and body tissue parameters that have not been specified in P1528 are derived from the tissue dielectric parameters computed from the 4-Cole-Cole equations described in Reference [12] and extrapolated according to the head parameters specified in P1528.

Target Frequency (MHz)	Head		Body	
	$\epsilon_r$	$\sigma$ (S/m)	$\epsilon_r$	$\sigma$ (S/m)
150	52.3	0.76	61.9	0.80
300	45.3	0.87	58.2	0.92
450	43.5	0.87	56.7	0.94
835	41.5	0.90	55.2	0.97
900	41.5	0.97	55.0	1.05
915	41.5	0.98	55.0	1.06
1450	40.5	1.20	54.0	1.30
1610	40.3	1.29	53.8	1.40
1800 – 2000	40.0	1.40	53.3	1.52
2450	39.2	1.80	52.7	1.95
3000	38.5	2.40	52.0	2.73
5800	35.3	5.27	48.2	6.00

( $\epsilon_r$  = relative permittivity,  $\sigma$  = conductivity and  $\rho = 1000 \text{ kg/m}^3$ )

## 4. SAR Measurement Procedure

### 4.1 SAR System Validation

#### 4.1.1 Validation Dipoles

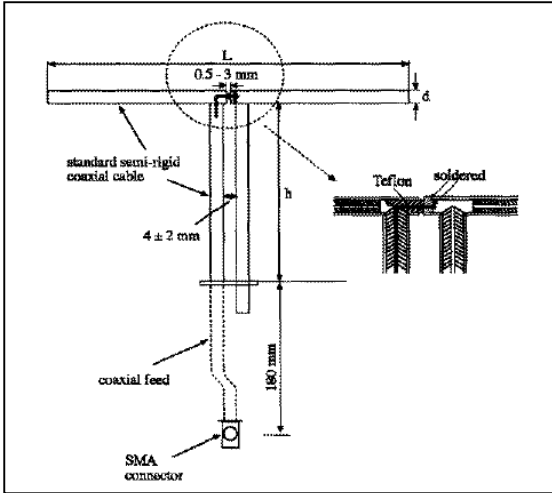

The dipoles used is based on the IEEE-1528 standard, and is complied with mechanical and electrical specifications in line with the requirements of both IEEE and FCC Supplement C. the table below provides details for the mechanical and electrical specifications for the dipoles.

Frequency	L (mm)	h (mm)	d (mm)
2450MHz	53.5	30.4	3.6

#### 4.1.2 Validation Result

System Performance Check at 2450MHz				
Validation Kit: ASL-D-2450-S-2				
Frequency [MHz]	Description	SAR [w/kg] 1g	SAR [w/kg] 10g	Tissue Temp. [°C]
2450 MHz	Reference result ± 10% window	48.07 43.263 to 52.877	25.65 23.085 to 28.215	N/A
	10-Mar-09	51.575	25.357	21.4

Note: All SAR values are normalized to 1W forward power.



**4.2 SAR Measurement Procedure**

The ALSAS-10U calculates SAR using the following equation,

$$SAR = \frac{\sigma |E|^2}{\rho}$$

$\sigma$ : represents the simulated tissue conductivity

$\rho$ : represents the tissue density

The EUT is set to transmit at the required power in line with product specification, at each frequency relating to the LOW, MID, and HIGH channel settings.

Pre-scans are made on the device to establish the location for the transmitting antenna, using a large area scan in either air or tissue simulation fluid.

The EUT is placed against the Universal Phantom where the maximum area scan dimensions are larger than the physical size of the resonating antenna. When the scan size is not large enough to cover the peak SAR distribution, it is modified by either extending the area scan size in both the X and Y directions, or the device is shifted within the predefined area.

The area scan is then run to establish the peak SAR location (interpolated resolution set at 1mm<sup>2</sup> )which is then used to orient the center of the zoom scan. The zoom scan is then executed and the 1g and 10g averages are derived from the zoom scan volume (interpolated resolution set at 1mm<sup>3</sup> ).

**5. SAR Exposure Limits**

SAR assessments have been made in line with the requirements of IEEE-1528, FCC Supplement C, and comply with ANSI/IEEE C95.1-1992 “Uncontrolled Environments” limits. These limits apply to a location which is deemed as “Uncontrolled Environment” which can be described as a situation where the general public may be exposed to an RF source with no prior knowledge or control over their exposure.

**Limits for General Population/Uncontrolled Exposure (W/kg)**

<b>Type Exposure</b>	<b>Uncontrolled Environment Limit</b>
Spatial Peak SAR (1g cube tissue for brain or body)	<b>1.60 W/kg</b>
Spatial Average SAR (whole body)	<b>0.08 W/kg</b>
Spatial Peak SAR (10g for hands, feet, ankles and wrist)	<b>4.00 W/kg</b>

## 6. Test Equipment List

Instrument	Manufacturer	Model No.	Serial No.	Last Calibration	Next Calibration
Data Acquisition Package	Apriel	ALS-DAQ-PAQ-2	QTK-337	Nov. 2006	only once
Apriel Laboratories Probe	Apriel	ALS-E020	265	May. 2008	May. 2009
Apriel Reference Dipole 2450Mhz	Apriel	ALS-D-2450-S-2	QTK-319	May. 2008	May. 2010
Boundary Detection Sensor System	Apriel	ALS-PMDPS-2	QTK-336	N/A	N/A
Dielectric Probe Kit	Apriel	ALS-PR-DIEL	QTK-296	N/A	N/A
Universal Work Station	Apriel	ALS-UWS	QTK-326	N/A	N/A
Device Holder 2.0	Apriel	ALS-H-E-SET-2	QTK-294	N/A	N/A
Left Ear SAM Phantom	Apriel	ALS-P-SAM-L	QTK-292	N/A	N/A
Right Ear SAM Phantom	Apriel	ALS-P-SAM-R	QTK-288	N/A	N/A
Universal Phantom	Apriel	ALS-P-UP-1	QTK-246	N/A	N/A
Apriel Dipole Spacer	Apriel	ALS-DS-U	QTK-295	N/A	N/A
SAR Software	Apriel	ALSAS-10	Ver. 2.3.6	N/A	N/A
CRS C500C Controller	Thermo	ALS-C500	RCF0404433	N/A	N/A
CRF F3 Robot	Thermo	ALS-F3	RAF0412222	N/A	N/A
Power Amplifier	Mini-Circuit	ZHL-42	D051404-20	N/A	N/A
Directional Coupler	Agilent	778D-012	50550	N/A	N/A
Universal Radio Communication Tester	Rohde & Schwarz	CMU 200	104846	Mar. 2009	Mar. 2010
Vector Network	Anritsu	MS4623B	992801	Aug. 2008	Aug. 2009
Signal Generator	Anritsu	MG3692A	042319	Jun. 2008	Jun. 2009
Power Meter	Anritsu	ML2487A	6K00001447	Apr. 2008	Apr. 2009
Wide Bandwidth Sensor	Anritsu	MA2491	030677	Apr. 2008	Apr. 2009

7. Measurement Uncertainty

Exposure Assessment Measurement Uncertainty

Source of Uncertainty	Tolerance Value	Probability Distribution	Divisor	$c_i^*$ (1-g)	$c_i^*$ (10-g)	Standard Uncertainty (1-g) %	Standard Uncertainty (10-g) %
Measurement System							
Probe Calibration	3.5	normal	1	1	1	3.5	3.5
Axial Isotropy	3.7	rectangular	$\sqrt{3}$	$(1-cp)^{1/2}$	$(1-cp)^{1/2}$	1.5	1.5
Hemispherical Isotropy	10.9	rectangular	$\sqrt{3}$	$\sqrt{cp}$	$\sqrt{cp}$	4.4	4.4
Boundary Effect	1.0	rectangular	$\sqrt{3}$	1	1	0.6	0.6
Linearity	4.7	rectangular	$\sqrt{3}$	1	1	2.7	2.7
Detection Limit	1.0	rectangular	$\sqrt{3}$	1	1	0.6	0.6
Readout Electronics	1.0	normal	1	1	1	1.0	1.0
Response Time	0.8	rectangular	$\sqrt{3}$	1	1	0.5	0.5
Integration Time	1.7	rectangular	$\sqrt{3}$	1	1	1.0	1.0
RF Ambient Condition	3.0	rectangular	$\sqrt{3}$	1	1	1.7	1.7
Probe Positioner Mech.	0.4	rectangular	$\sqrt{3}$	1	1	0.2	0.2
Restriction							
Probe Positioning with respect to Phantom Shell	2.9	rectangular	$\sqrt{3}$	1	1	1.7	1.7
Extrapolation and Integration	3.7	rectangular	$\sqrt{3}$	1	1	2.1	2.1
Test Sample Positioning	4.0	normal	1	1	1	4.0	4.0
Device Holder Uncertainty	2.0	normal	1	1	1	2.0	2.0
Drift of output Power	4.7	rectangular	$\sqrt{3}$	1	1	2.7	2.7
Phantom and Setup							
Phantom Uncertainty(shape & thickness tolerance)	3.4	rectangular	$\sqrt{3}$	1	1	2.0	2.0
Liquid Conductivity(target)	5.0	rectangular	$\sqrt{3}$	0.7	0.5	2.0	1.4
Liquid Conductivity(meas.)	0.1	normal	1	0.7	0.5	0.1	0.0
Liquid Permittivity(target)	2.0	rectangular	$\sqrt{3}$	0.6	0.5	0.7	0.6
Liquid Permittivity(meas.)	2.6	normal	1	0.6	0.5	1.6	1.3
Combined Uncertainty		RSS				9.6	9.5
Combined Uncertainty (coverage factor=2)		Normal(k=2)				19.3	18.9

**8. Test Results**

**8.1 SAR Test Results Summary**

SAR MEASUREMENT						
Ambient Temperature (°C) : 22.2 ±2				Relative Humidity (%): 51		
Liquid Temperature (°C) : 21.4 ±2				Depth of Liquid (cm):>15		
Product: PWS-8033M						
Test Mode: 802.11b						
Test Position Body	Antenna Position	Frequency		Conducted Power (dBm)	SAR 1g (W/kg)	Limit (W/kg)
		Channel	MHz			
Right-side	Fixed	6	2437	14.40	0.039	1.6
Test Mode: 802.11g						
Right-side	Fixed	6	2437	16.02	0.041	1.6
Bottom	Fixed	6	2437	16.02	0.027	1.6
Back	Fixed	6	2437	16.02	0.039	1.6
Top	Fixed	6	2437	16.02	0.014	1.6
Test Mode: 802.11g						
Right-side	Fixed	1	2412	17.29	0.041	1.6
Right-side	Fixed	11	2462	16.56	0.054	1.6

**Appendix****Appendix A. SAR System Validation Data****Appendix B. SAR measurement Data****Appendix C. Test Setup Photographs & EUT Photographs****Appendix D. Probe Calibration Data****Appendix E. Dipole Calibration Data**

**Appendix A. SAR System Validation Data**

ALSAS-10U VER 2.3.6 APREL Laboratories

## SAR Test Report

Report Date : 10-Mar-2009  
Measurement Date : 10-Mar-2009

## Product Data

Device Name : Dipole-2450  
Type : Dipole  
Frequency : 2450.00 MHz  
Max. Transmit Pwr : 1 W  
Drift Time : 0 min(s)  
Length : 51.5 mm  
Width : 3.6 mm  
Depth : 30.4 mm  
Power Drift-Start : 60.486 W/kg  
Power Drift-Finish: 59.690 W/kg  
Power Drift (%) : -1.316

## Phantom Data

Type : Uni-Phantom  
Size (mm) : 280 x 280 x 200  
Location : Center

## Tissue Data

Type : HEAD  
Serial No. : 325-H  
Frequency : 2450.00 MHz  
Last Calib. Date : 10-Mar-2009  
Temperature : 21.40 °C  
Ambient Temp. : 22.20 °C  
Humidity : 51.00 RH%  
Epsilon : 41.69 F/m  
Sigma : 1.81 S/m  
Density : 1000.00 kg/cu. m

## Probe Data

Name : Probe 265  
Model : E020  
Type : E-Field Triangle  
Serial No. : 265  
Last Calib. Date : 09-May-2008  
Frequency : 2450.00 MHz  
Duty Cycle Factor: 1  
Conversion Factor: 3.67  
Probe Sensitivity: 1.20 1.20 1.20  $\mu\text{V}/(\text{V}/\text{m})^2$   
Compression Point: 95.00 mV  
Offset : 1.56 mm

Measurement Data

Crest Factor : 1  
 Temperature : 21.40 °C  
 Ambient Temp. : 22.20 °C  
 Area Scan : 5x9x1 : Measurement x=15mm, y=15mm, z=4mm  
 Zoom Scan : 7x7x7 : Measurement x=5mm, y=5mm, z=5mm  
 Frequency : 2450 MHz

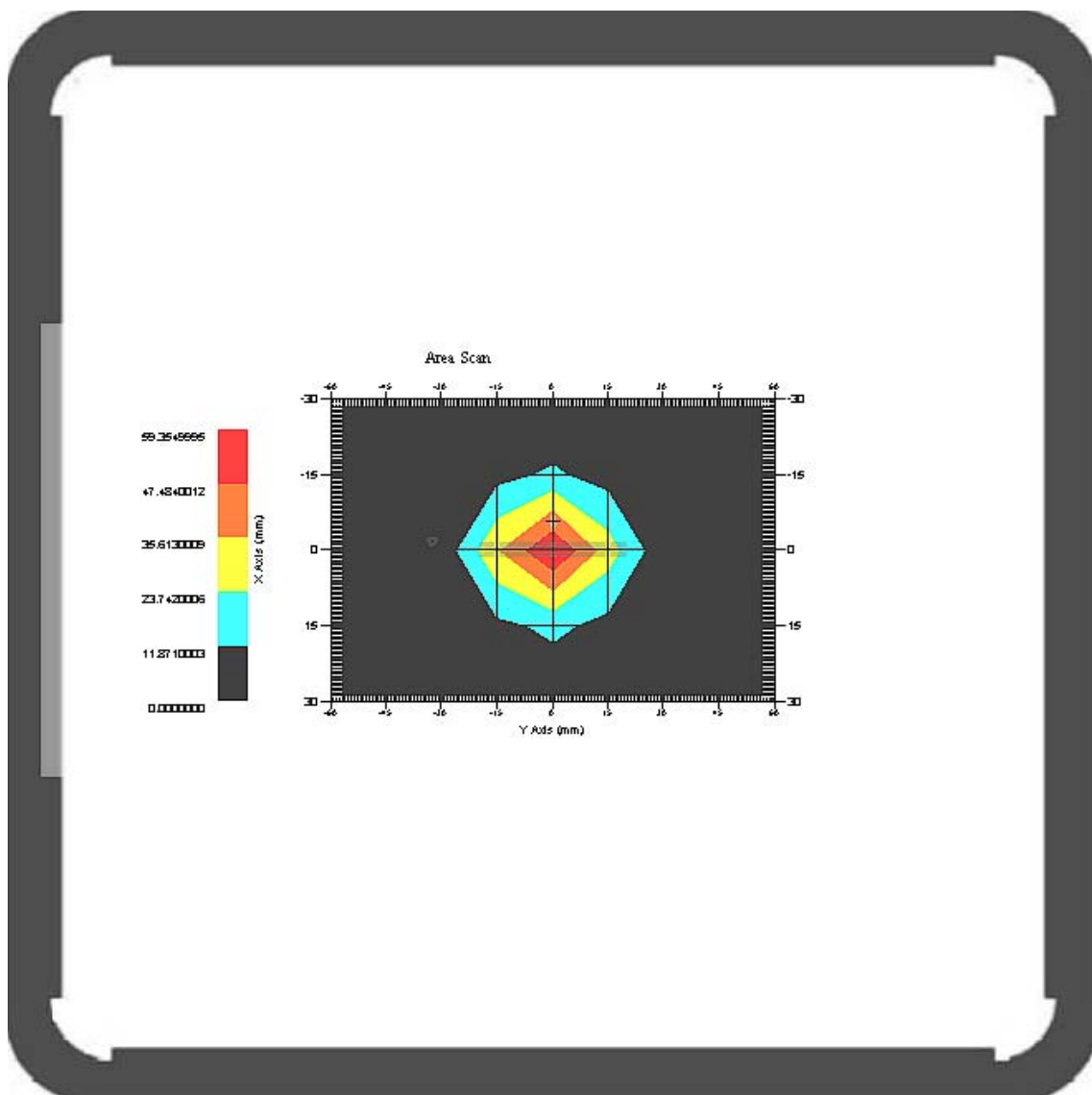

1 gram SAR value : 51.575 W/kg  
 10 gram SAR value : 25.357 W/kg  
 Area Scan Peak SAR : 59.355 W/kg  
 Zoom Scan Peak SAR : 111.950 W/kg



This is previous page plot (zoom in)

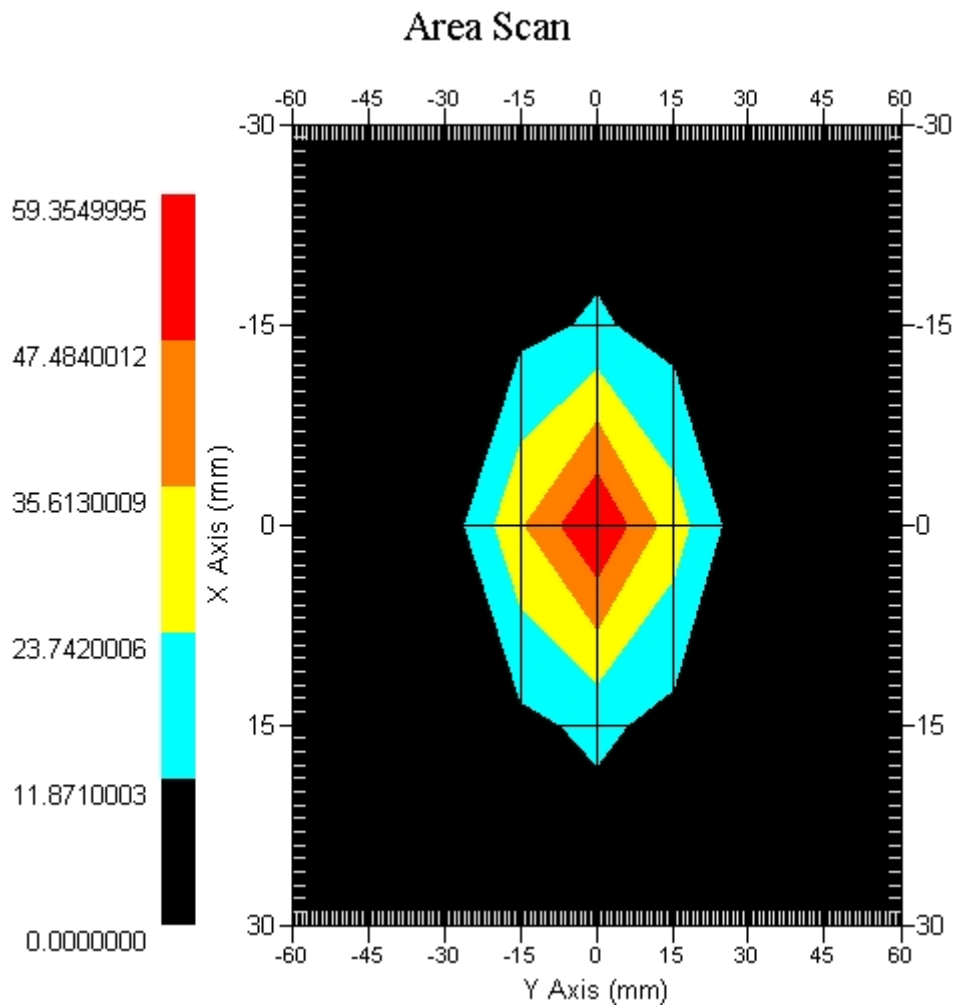

SAR-Z Axis  
at Hotspot x:0.04 y:-0.01

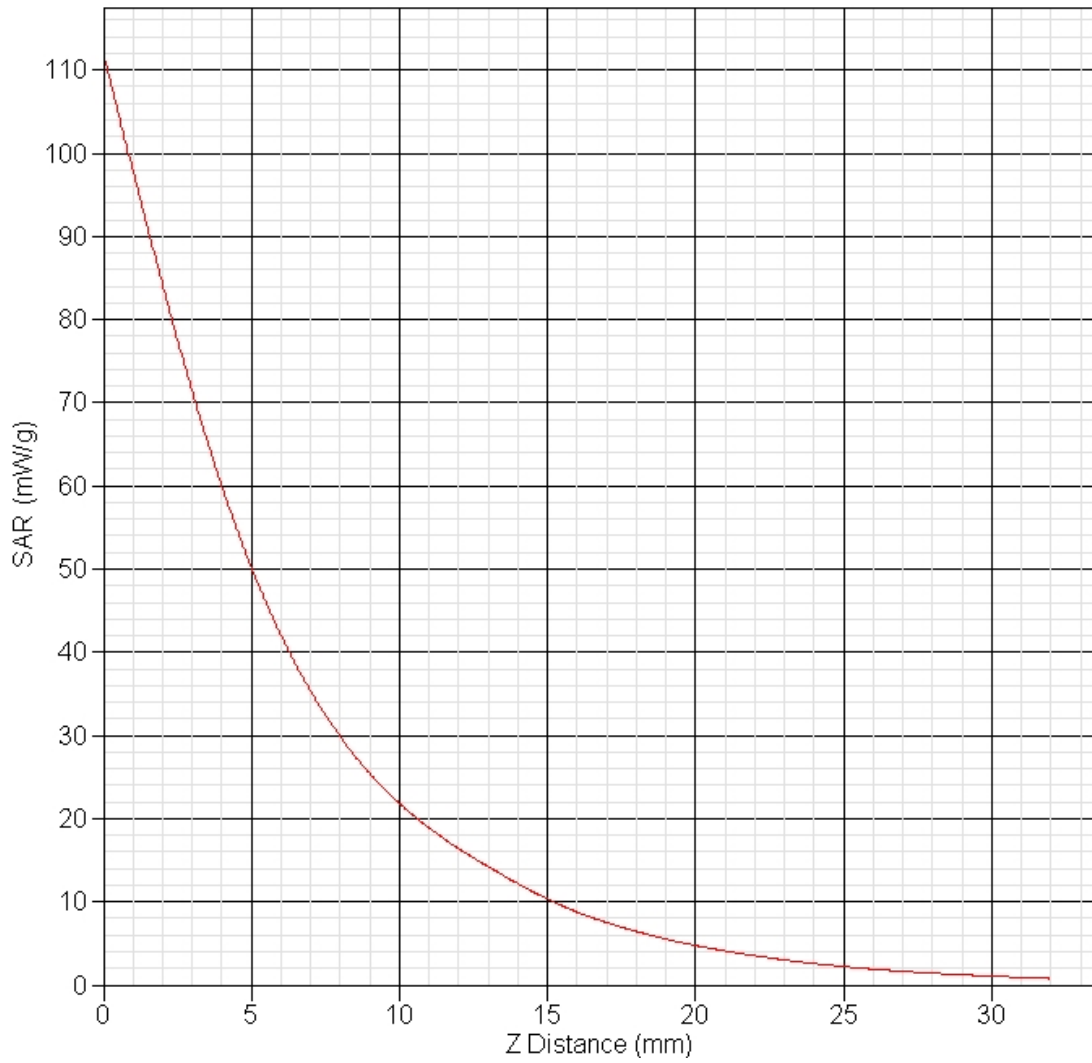

**Appendix B. SAR measurement Data**

ALSAS-10U VER 2.3.6 APREL Laboratories

SAR Test Report -802.11b

Report Date : 10-Mar-2009  
Measurement Date : 10-Mar-2009

## Product Data

Device Name : PDA  
Type : PDA  
Model : PWS-8033M-ROAE  
Frequency : 2450.00 MHz  
Drift Time : 0 min(s)  
Length : 42 mm  
Width : 155 mm  
Depth : 95mm  
Antenna Type : Dipole

## Phantom Data

Type : Uni-Phantom  
Size (mm) : 280 x 280 x 200  
Location : Center

## Tissue Data

Type : BODY  
Serial No. : 325-B  
Frequency : 2450.00 MHz  
Last Calib. Date : 10-Mar-2009  
Temperature : 21.40 °C  
Ambient Temp. : 22.20 °C  
Humidity : 51.00 RH%  
Epsilon : 53.64 F/m  
Sigma : 1.97 S/m  
Density : 1000.00 kg/cu. m

## Probe Data

Name : Probe 265  
Model : E020  
Type : E-Field Triangle  
Serial No. : 265  
Last Calib. Date : 09-May-2008  
Frequency : 2450.00 MHz  
Duty Cycle Factor: 1  
Conversion Factor: 3.55  
Probe Sensitivity: 1.20 1.20 1.20  $\mu\text{V}/(\text{V}/\text{m})^2$   
Compression Point: 95.00 mV  
Offset : 1.56 mm

Measurement Data

Crest Factor : 1  
Tissue Temp. : 21.40 °C  
Ambient Temp. : 22.20 °C  
Area Scan : 5x5x1 : Measurement x=12mm, y=12mm, z=4mm  
Zoom Scan : 5x5x8 : Measurement x=8mm, y=8mm, z=4mm  
Power Drift-Start : 0.018 W/kg  
Power Drift-Finish: 0.018 W/kg  
Power Drift (%) : -0.194

DUT Position : Touch EUT Right Side  
Channel : 6

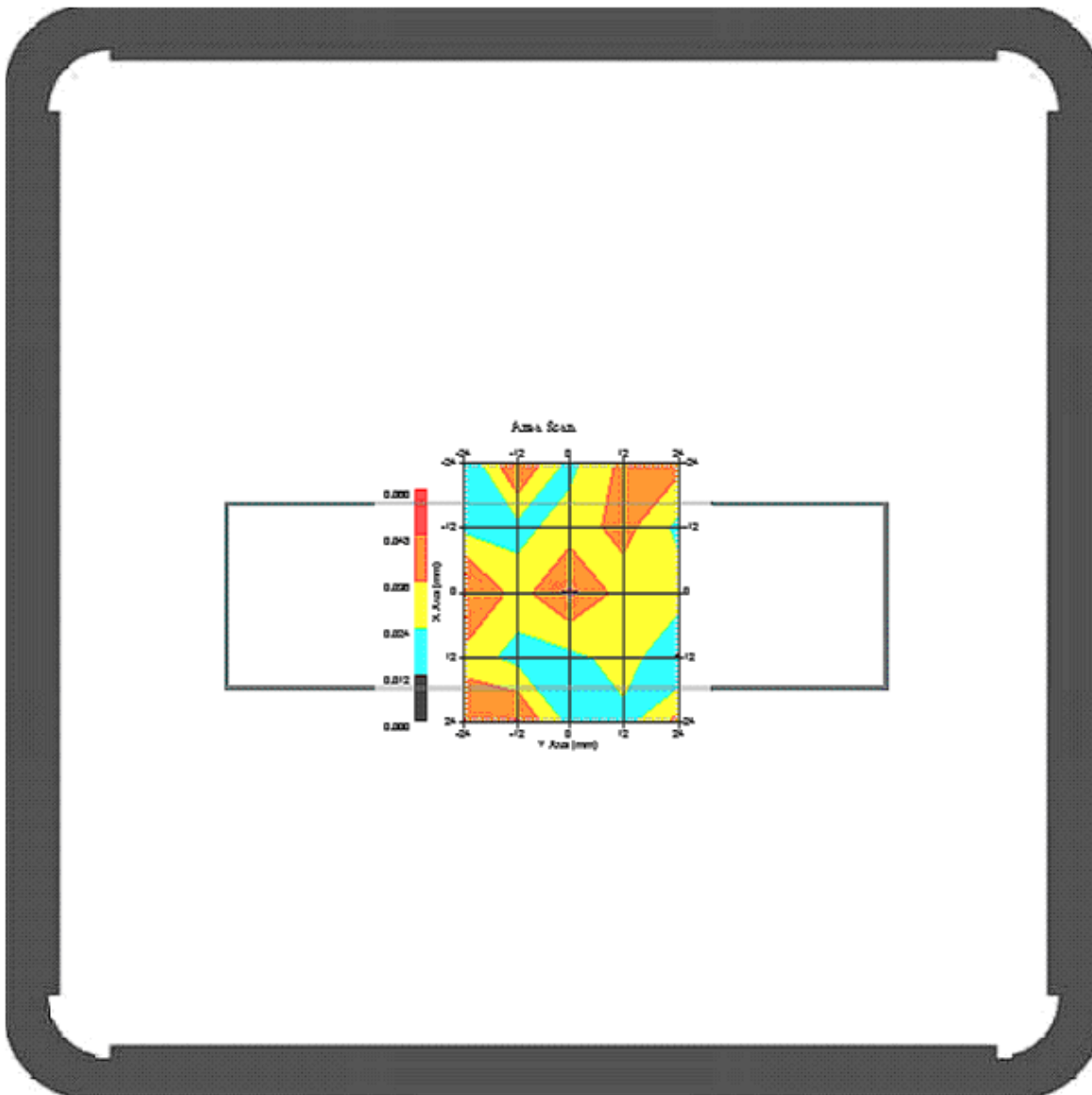

1 gram SAR value : 0.039 W/kg  
10 gram SAR value : 0.025 W/kg  
Area Scan Peak SAR : 0.060 W/kg  
Zoom Scan Peak SAR : 0.078 W/kg

This is previous page plot (zoom in)

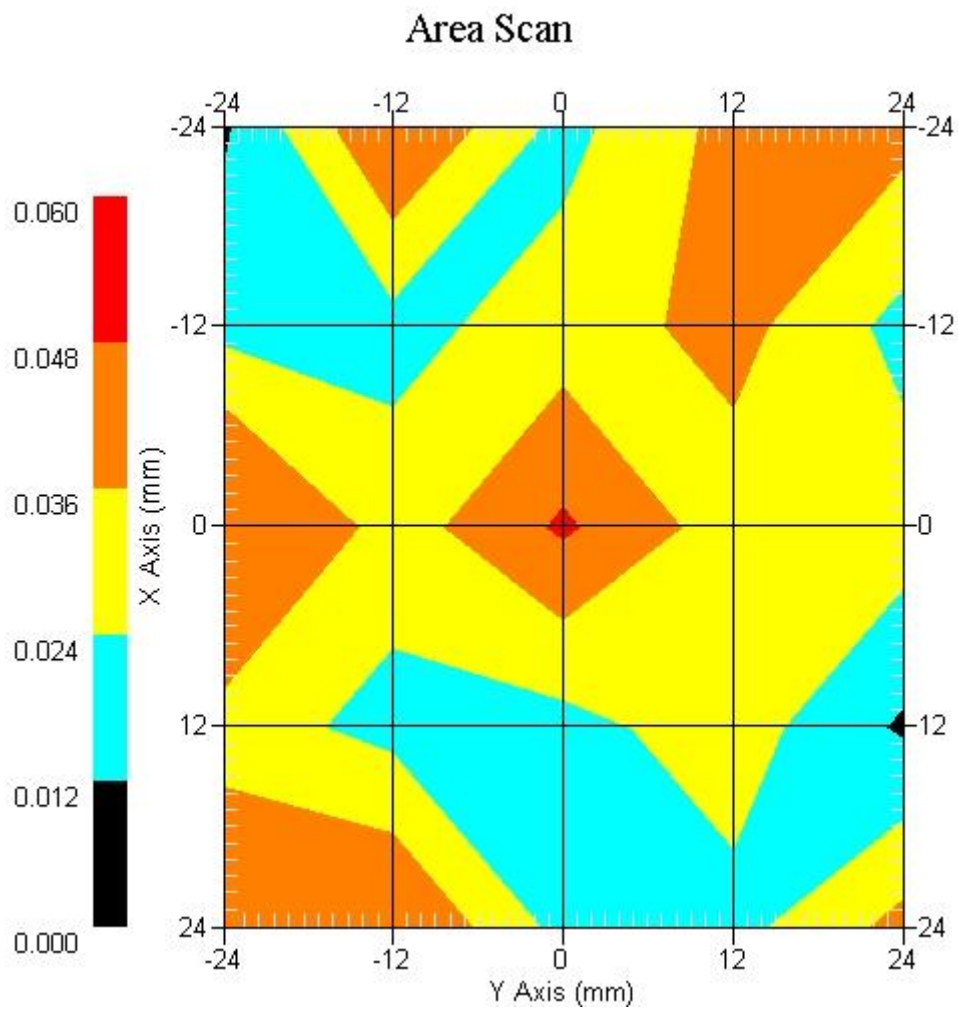

## ALSAS-10U VER 2.3.6 APREL Laboratories

## SAR Test Report -802.11g

Report Date : 10-Mar-2009  
Measurement Date : 10-Mar-2009

## Product Data

Device Name : PDA  
Type : PDA  
Model : PWS-8033M-ROAE  
Frequency : 2450.00 MHz  
Drift Time : 0 min(s)  
Length : 42 mm  
Width : 155 mm  
Depth : 95 mm  
Antenna Type : Dipole

## Phantom Data

Type : Uni-Phantom  
Size (mm) : 280 x 280 x 200  
Location : Center

## Tissue Data

Type : BODY  
Serial No. : 325-B  
Frequency : 2450.00 MHz  
Last Calib. Date : 10-Mar-2009  
Temperature : 21.40 °C  
Ambient Temp. : 22.20 °C  
Humidity : 51.00 RH%  
Epsilon : 53.64 F/m  
Sigma : 1.97 S/m  
Density : 1000.00 kg/cu. m

## Probe Data

Name : Probe 265  
Model : E020  
Type : E-Field Triangle  
Serial No. : 265  
Last Calib. Date : 09-May-2008  
Frequency : 2450.00 MHz  
Duty Cycle Factor: 1  
Conversion Factor: 3.55  
Probe Sensitivity: 1.20 1.20 1.20  $\mu\text{V}/(\text{V}/\text{m})^2$   
Compression Point: 95.00 mV  
Offset : 1.56 mm

Measurement Data

Crest Factor : 1  
Tissue Temp. : 21.40 °C  
Ambient Temp. : 22.20 °C  
Area Scan : 5x5x1 : Measurement x=12mm, y=12mm, z=4mm  
Zoom Scan : 5x5x8 : Measurement x=8mm, y=8mm, z=4mm  
Power Drift-Start : 0.040 W/kg  
Power Drift-Finish: 0.041 W/kg  
Power Drift (%) : 2.500

DUT Position : Touch EUT Right Side  
Channel : 6

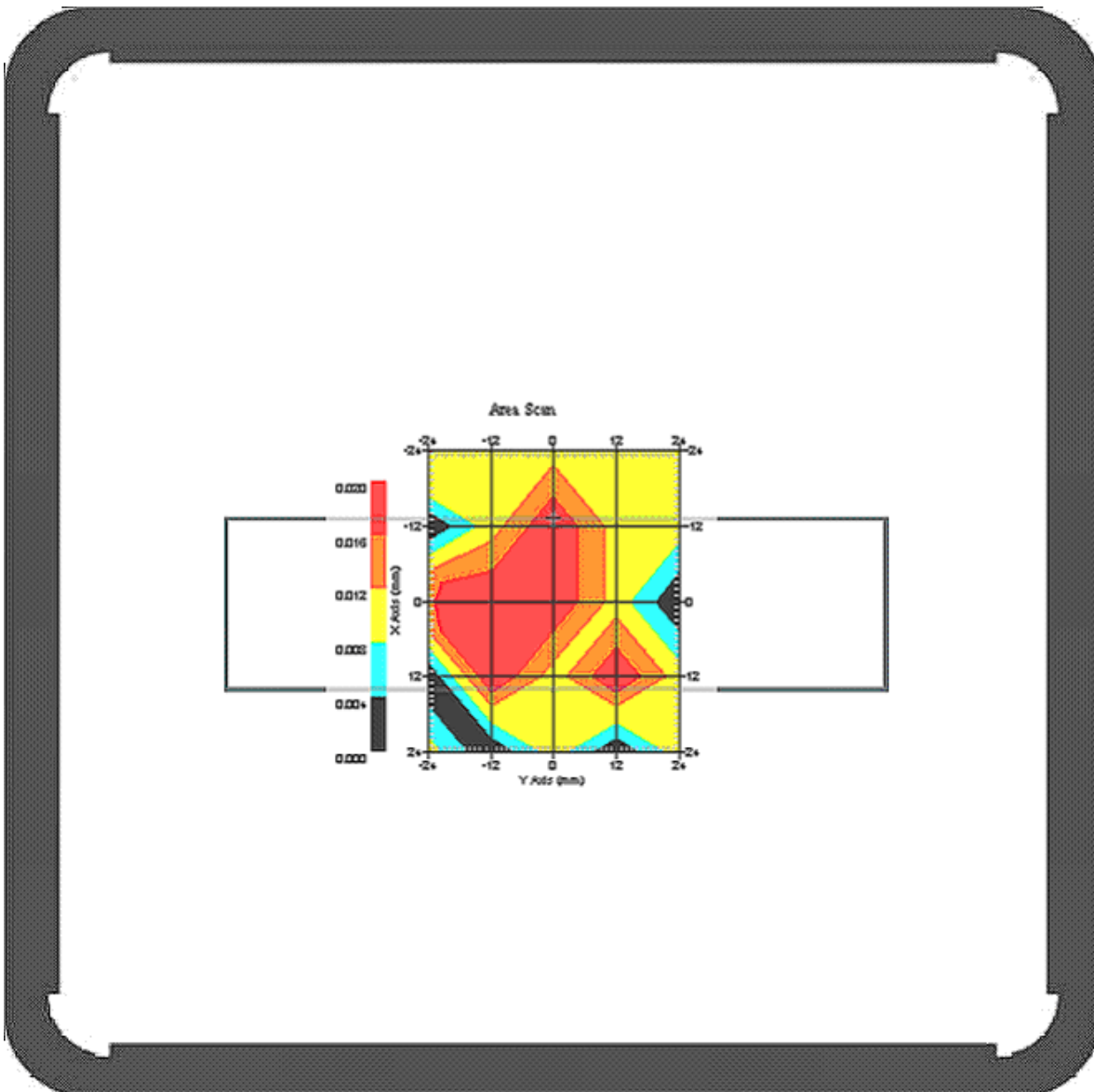

1 gram SAR value : 0.041 W/kg  
10 gram SAR value : 0.026 W/kg  
Area Scan Peak SAR : 0.060 W/kg  
Zoom Scan Peak SAR : 0.082 W/kg

This is previous page plot (zoom in)

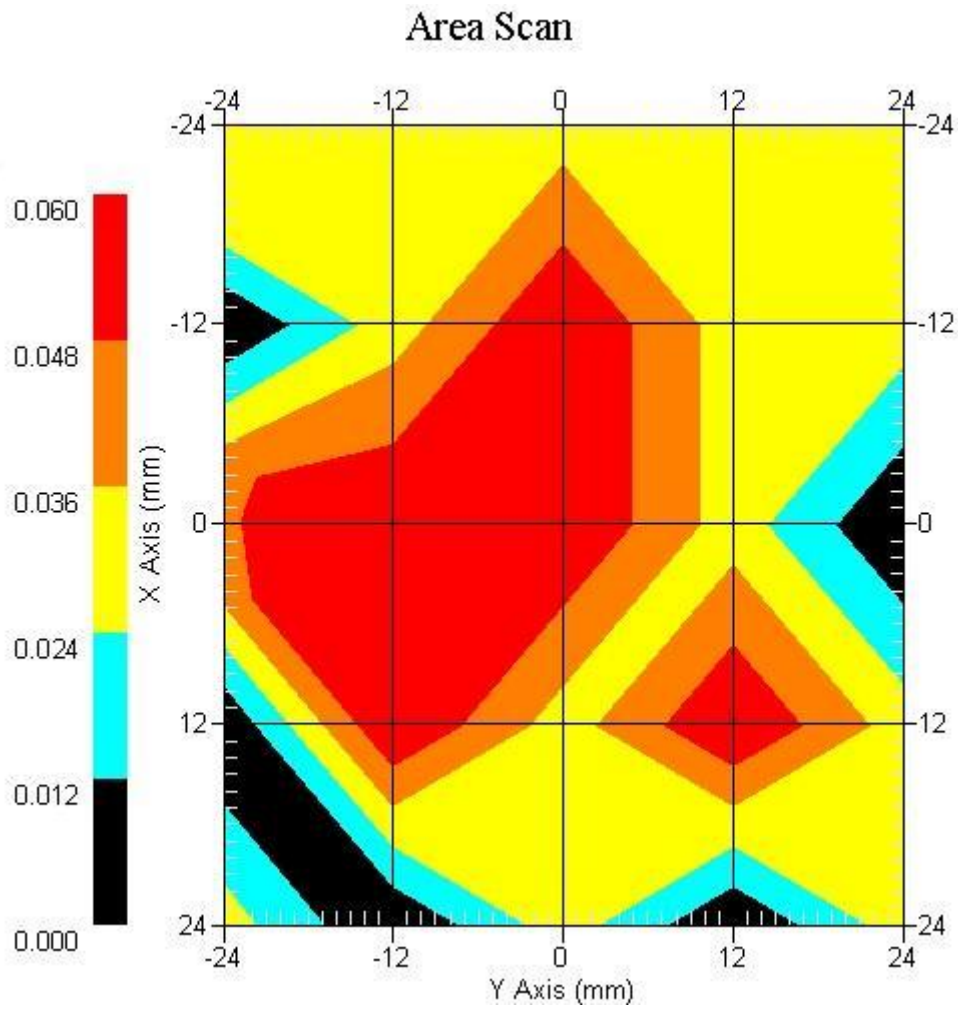



### Measurement Data

Crest Factor : 1  
Tissue Temp. : 21.40 °C  
Ambient Temp. : 22.20 °C  
Area Scan : 5x5x1 : Measurement x=12mm, y=12mm, z=4mm  
Zoom Scan : 5x5x8 : Measurement x=8mm, y=8mm, z=4mm  
Power Drift-Start : 0.037 W/kg  
Power Drift-Finish: 0.037 W/kg  
Power Drift (%) : 0.497

DUT Position : Touch EUT Bottom  
Channel : 6

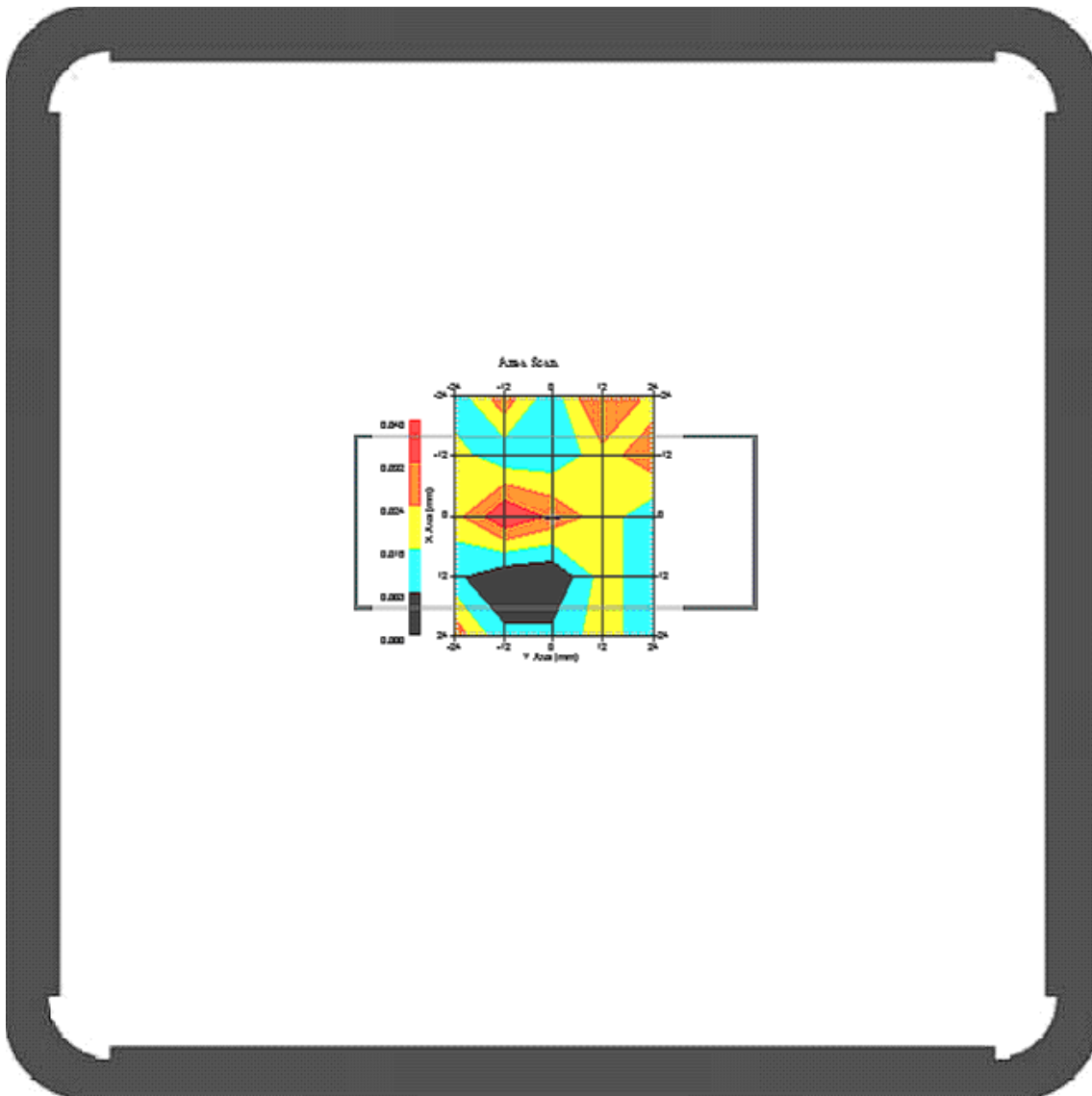

1 gram SAR value : 0.027 W/kg  
10 gram SAR value : 0.019 W/kg  
Area Scan Peak SAR : 0.040 W/kg  
Zoom Scan Peak SAR : 0.030 W/kg

This is previous page plot (zoom in)

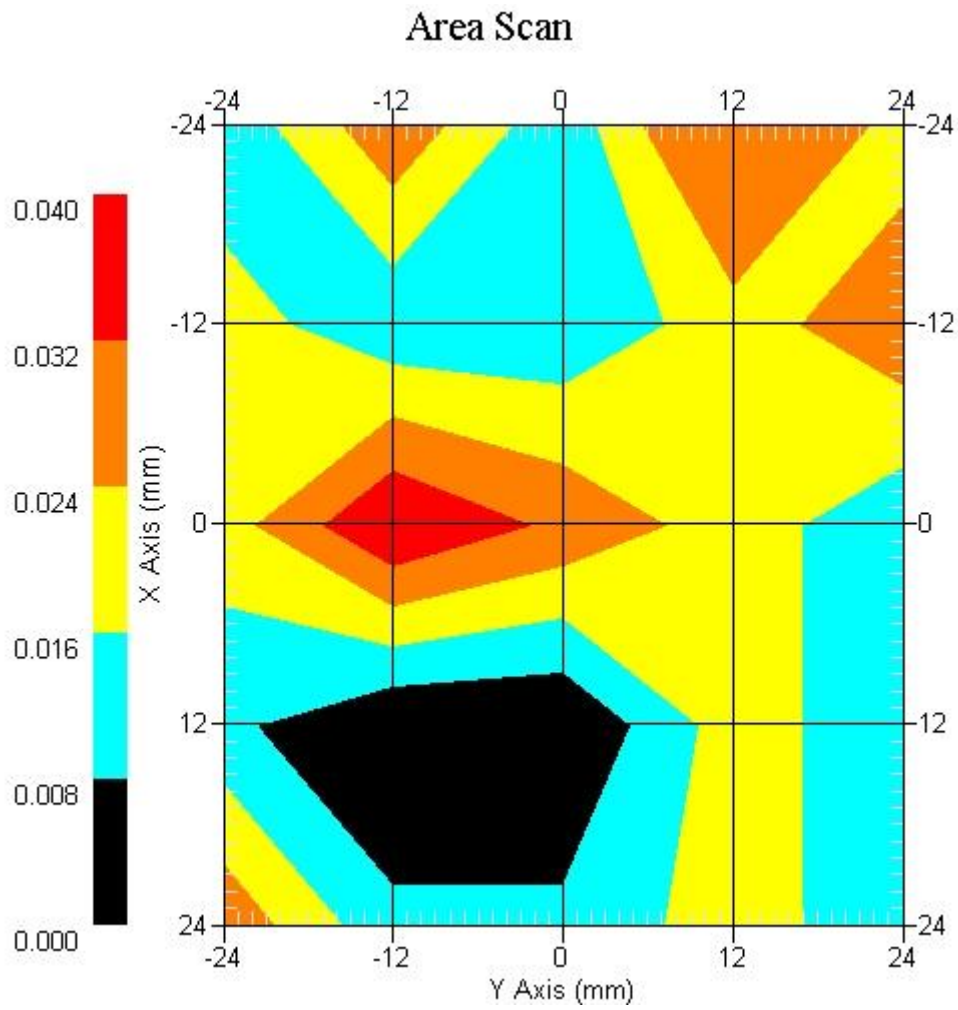

Measurement Data

Crest Factor : 1  
Tissue Temp. : 21.40 °C  
Ambient Temp. : 22.20 °C  
Area Scan : 5x5x1 : Measurement x=12mm, y=12mm, z=4mm  
Zoom Scan : 5x5x8 : Measurement x=8mm, y=8mm, z=4mm  
Power Drift-Start : 0.040 W/kg  
Power Drift-Finish: 0.040 W/kg  
Power Drift (%) : -0.609

DUT Position : Touch EUT Back  
Channel : 6

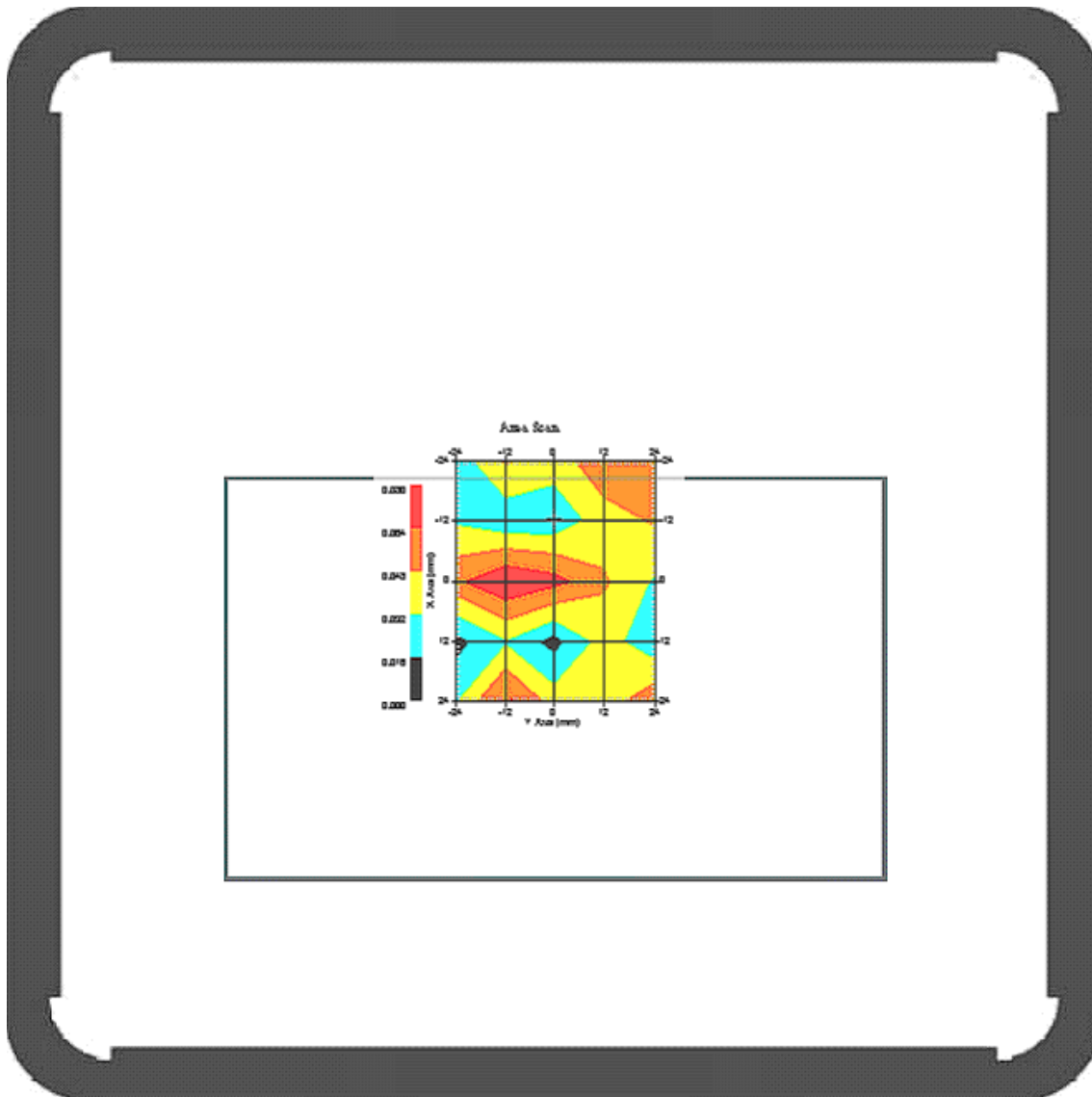

1 gram SAR value : 0.039 W/kg  
10 gram SAR value : 0.027 W/kg  
Area Scan Peak SAR : 0.072 W/kg  
Zoom Scan Peak SAR : 0.084 W/kg

This is previous page plot (zoom in)

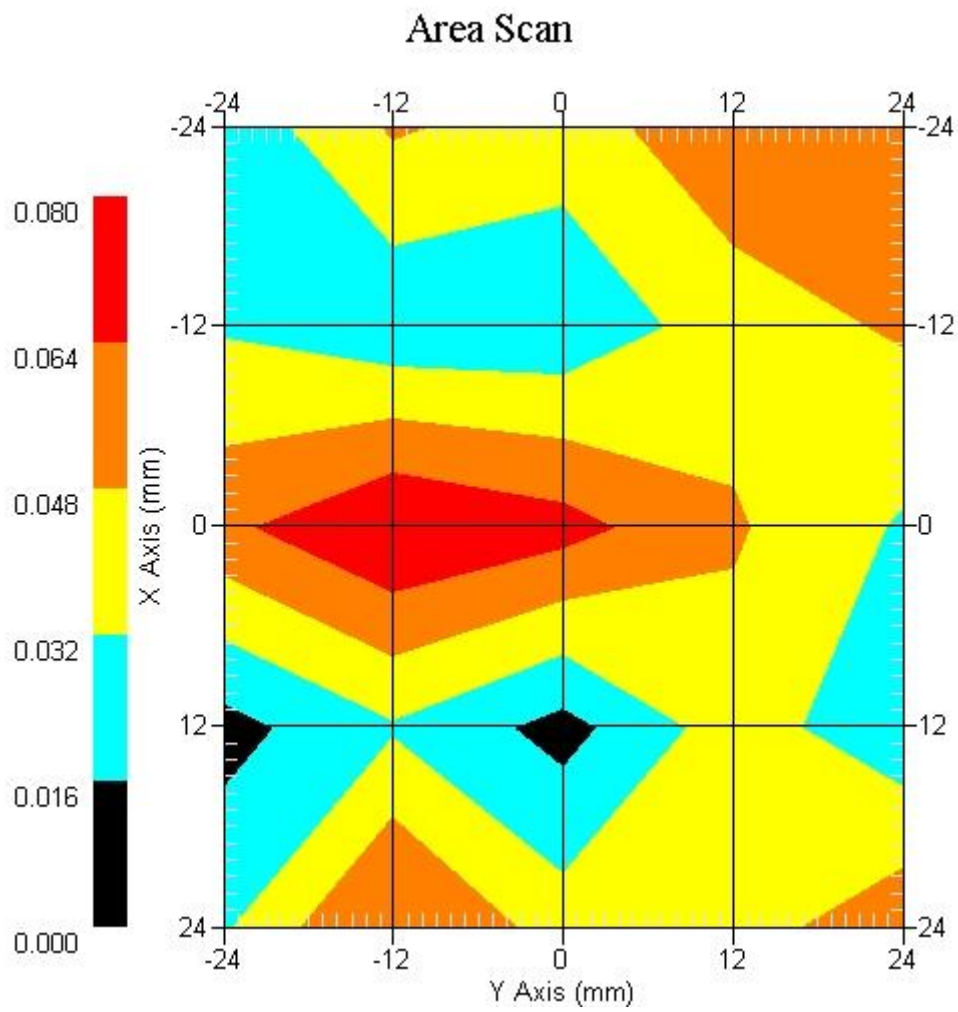

Measurement Data

Crest Factor : 1  
 Tissue Temp. : 21.40 °C  
 Ambient Temp. : 22.20 °C  
 Area Scan : 5x5x1 : Measurement x=12mm, y=12mm, z=4mm  
 Zoom Scan : 5x5x8 : Measurement x=8mm, y=8mm, z=4mm  
 Power Drift-Start : 0.020 W/kg  
 Power Drift-Finish: 0.020 W/kg  
 Power Drift (%) : 0.162

DUT Position : Touch EUT Top  
 Channel : 6

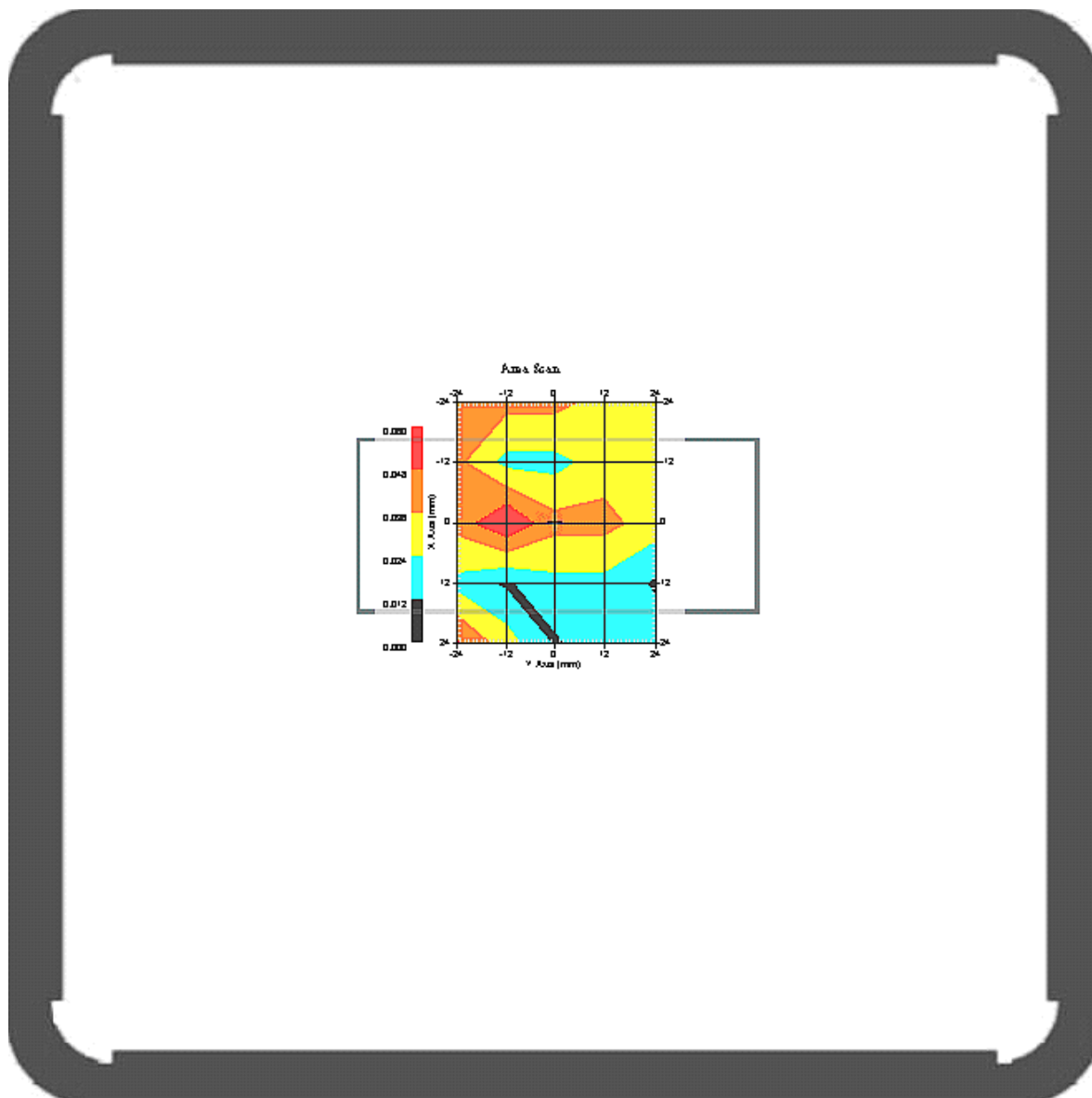

1 gram SAR value : 0.014 W/kg  
 10 gram SAR value : 0.010 W/kg  
 Area Scan Peak SAR : 0.020 W/kg  
 Zoom Scan Peak SAR : 0.030 W/kg

This is previous page plot (zoom in)

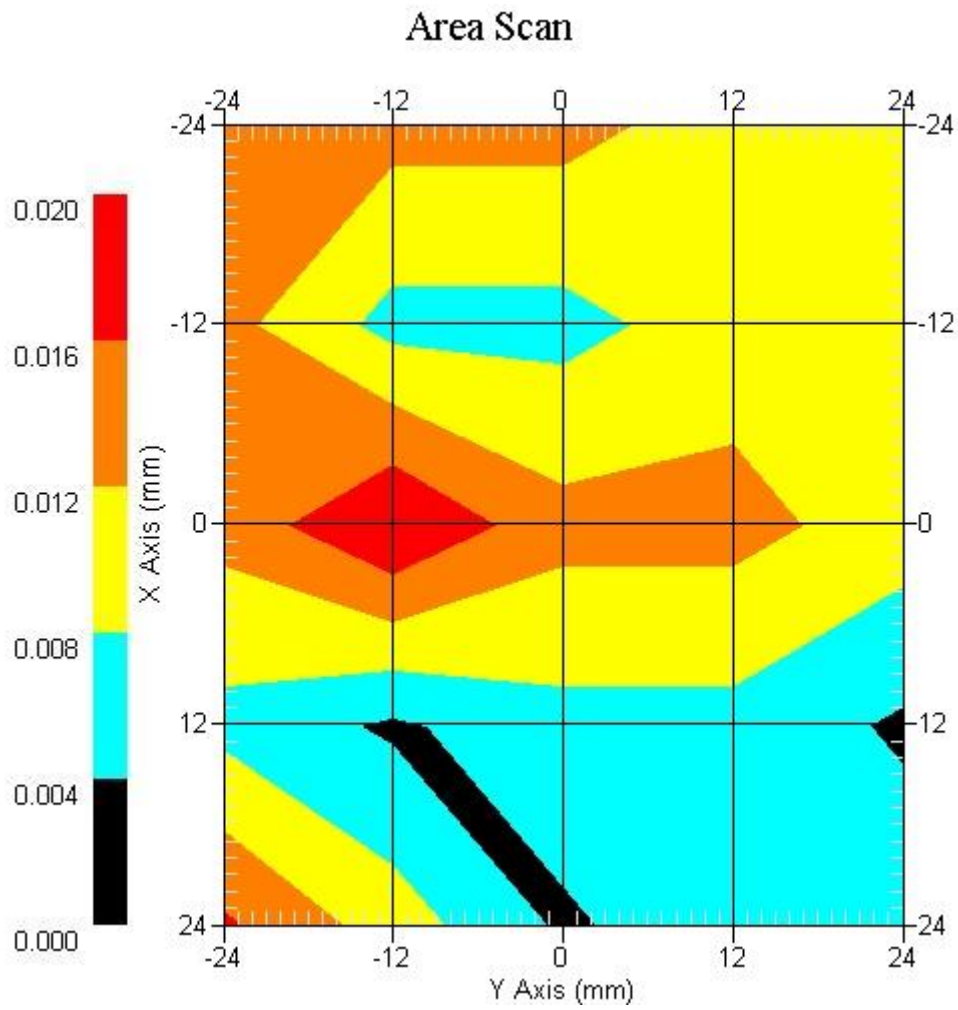

**ALSAS-10U VER 2.3.6 APREL Laboratories  
SAR Test Report -802.11g**

Report Date : 10-Mar-2009  
Measurement Date : 10-Mar-2009

**Product Data**

Device Name : PDA  
Type : PDA  
Model : PWS-8033M-ROAE  
Frequency : 2450.00 MHz  
Drift Time : 0 min(s)  
Length : 42 mm  
Width : 155 mm  
Depth : 95 mm  
Antenna Type : Dipole

**Phantom Data**

Type : Uni-Phantom  
Size (mm) : 280 x 280 x 200  
Location : Center

**Tissue Data**

Type : BODY  
Serial No. : 325-B  
Frequency : 2450.00 MHz  
Last Calib. Date : 10-Mar-2009  
Temperature : 21.40 °C  
Ambient Temp. : 22.20 °C  
Humidity : 51.00 RH%  
Epsilon : 53.64 F/m  
Sigma : 1.97 S/m  
Density : 1000.00 kg/cu. m

**Probe Data**

Name : Probe 265  
Model : E020  
Type : E-Field Triangle  
Serial No. : 265  
Last Calib. Date : 09-May-2008  
Frequency : 2450.00 MHz  
Duty Cycle Factor: 1  
Conversion Factor: 3.55  
Probe Sensitivity: 1.20 1.20 1.20  $\mu\text{V}/(\text{V}/\text{m})^2$   
Compression Point: 95.00 mV  
Offset : 1.56 mm

Measurement Data

Crest Factor : 1  
Tissue Temp. : 21.40 °C  
Ambient Temp. : 22.20 °C  
Area Scan : 5x5x1 : Measurement x=12mm, y=12mm, z=4mm  
Zoom Scan : 5x5x8 : Measurement x=8mm, y=8mm, z=4mm  
Power Drift-Start : 0.035 W/kg  
Power Drift-Finish: 0.035 W/kg  
Power Drift (%) : 2.102

DUT Position : Touch EUT Right Side  
Channel : 1

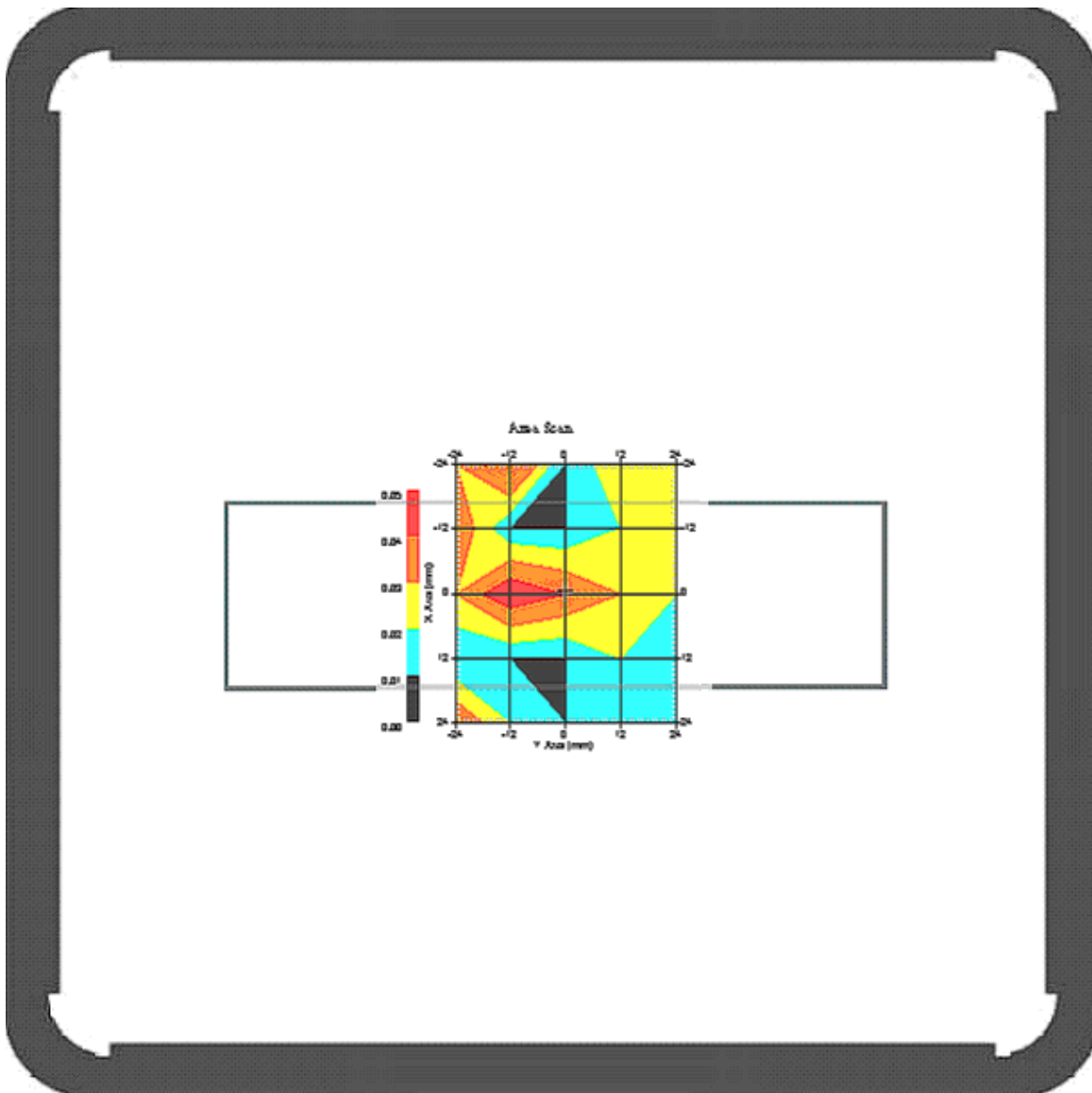

1 gram SAR value : 0.041 W/kg  
10 gram SAR value : 0.026 W/kg  
Area Scan Peak SAR : 0.050 W/kg  
Zoom Scan Peak SAR : 0.082 W/kg



This is previous page plot (zoom in)

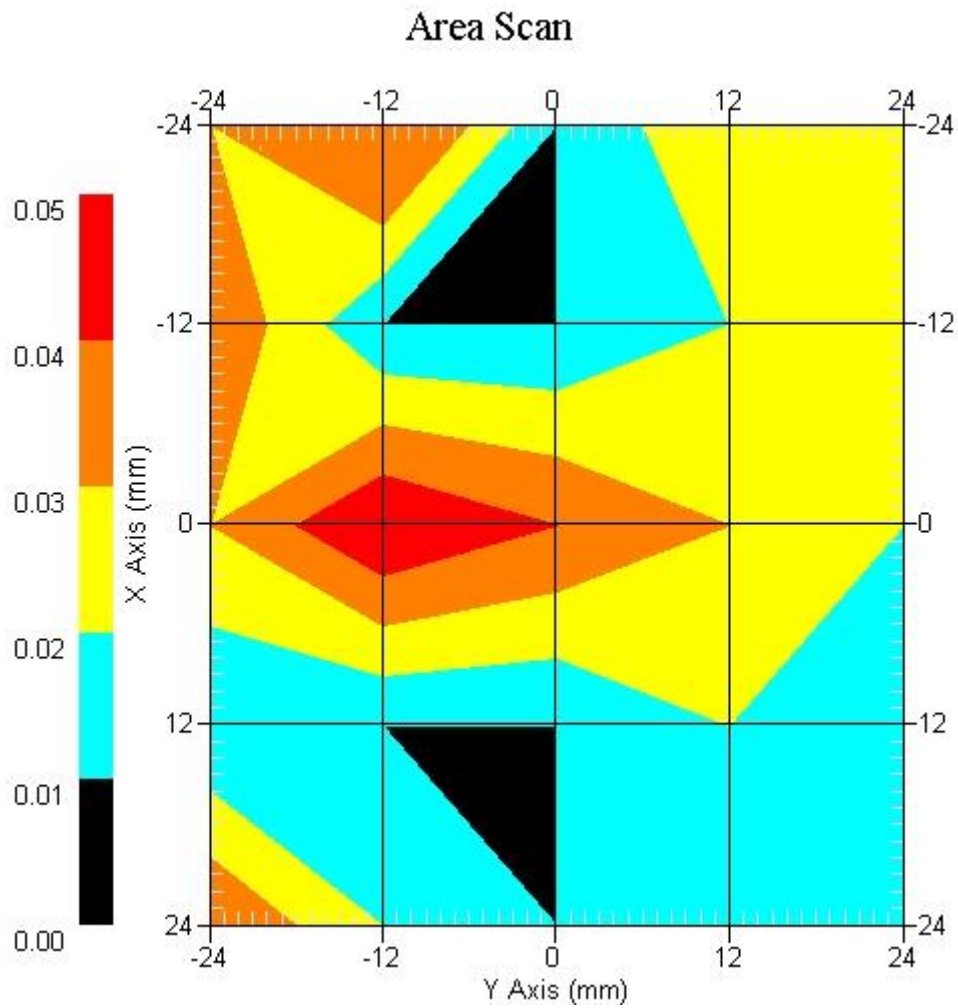

Measurement Data

Crest Factor : 1  
 Tissue Temp. : 21.40 °C  
 Ambient Temp. : 22.20 °C  
 Area Scan : 5x5x1 : Measurement x=12mm, y=12mm, z=4mm  
 Zoom Scan : 5x5x8 : Measurement x=8mm, y=8mm, z=4mm  
 Power Drift-Start : 0.023 W/kg  
 Power Drift-Finish: 0.023 W/kg  
 Power Drift (%) : -0.909

DUT Position : Touch EUT Right Side  
 Channel : 11

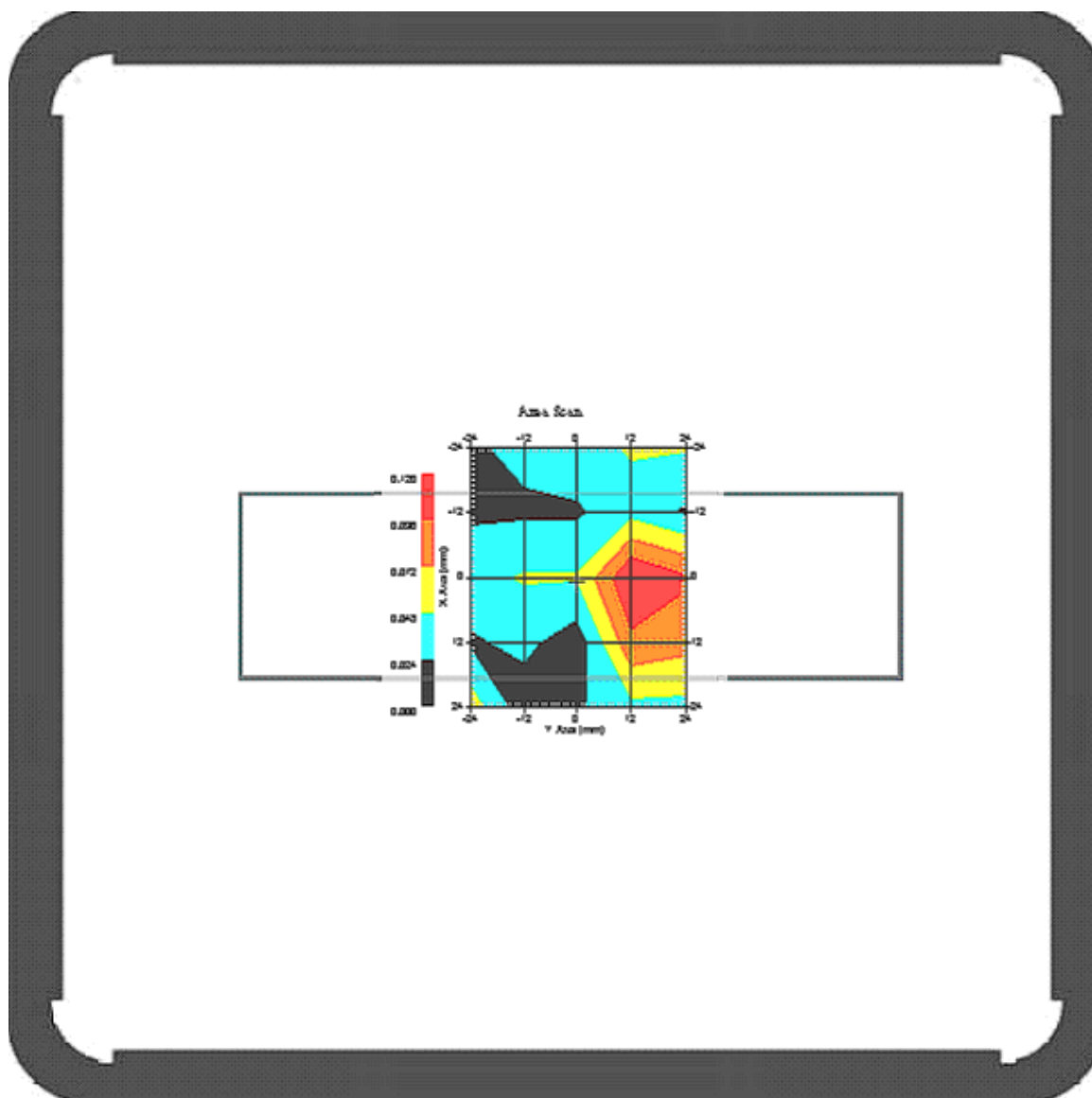

1 gram SAR value : 0.054 W/kg  
 10 gram SAR value : 0.036 W/kg  
 Area Scan Peak SAR : 0.098 W/kg  
 Zoom Scan Peak SAR : 0.096 W/kg

This is previous page plot (zoom in)

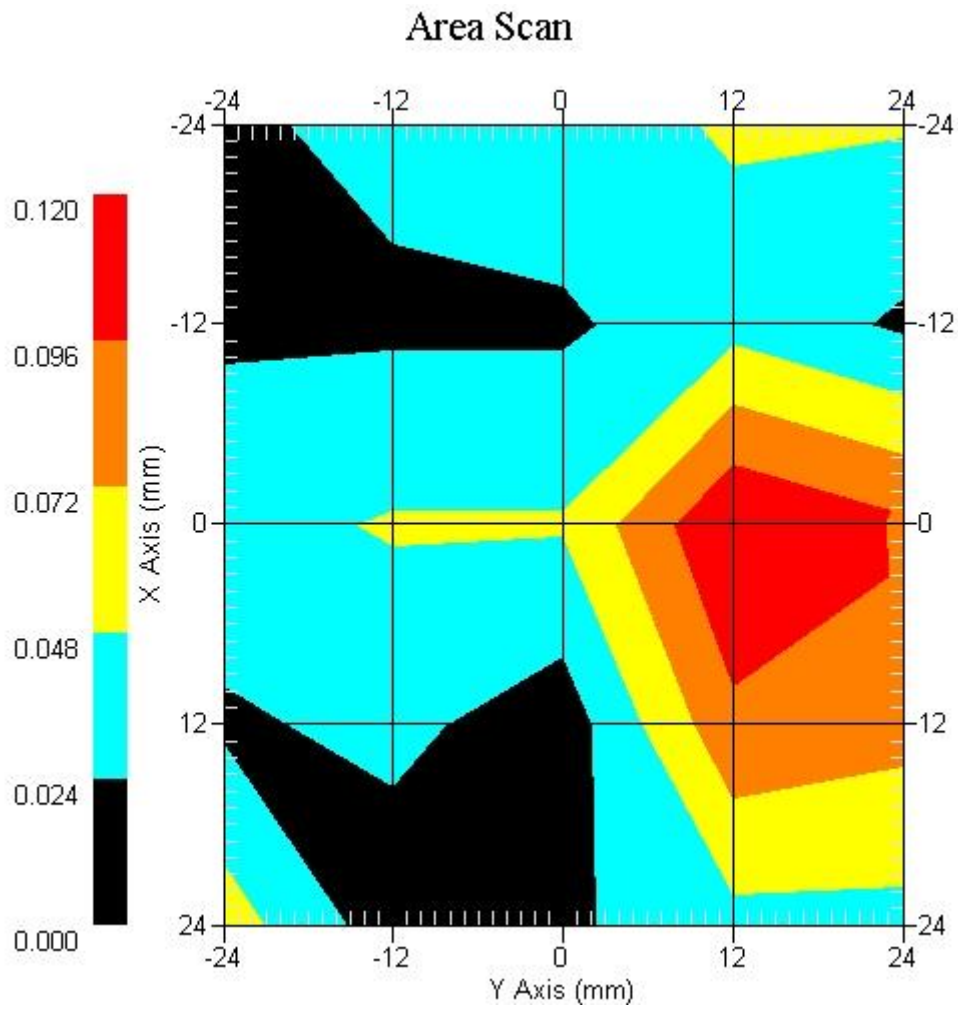

802.11g Touch EUT Right Side Z-Axis plot

Channel: 11

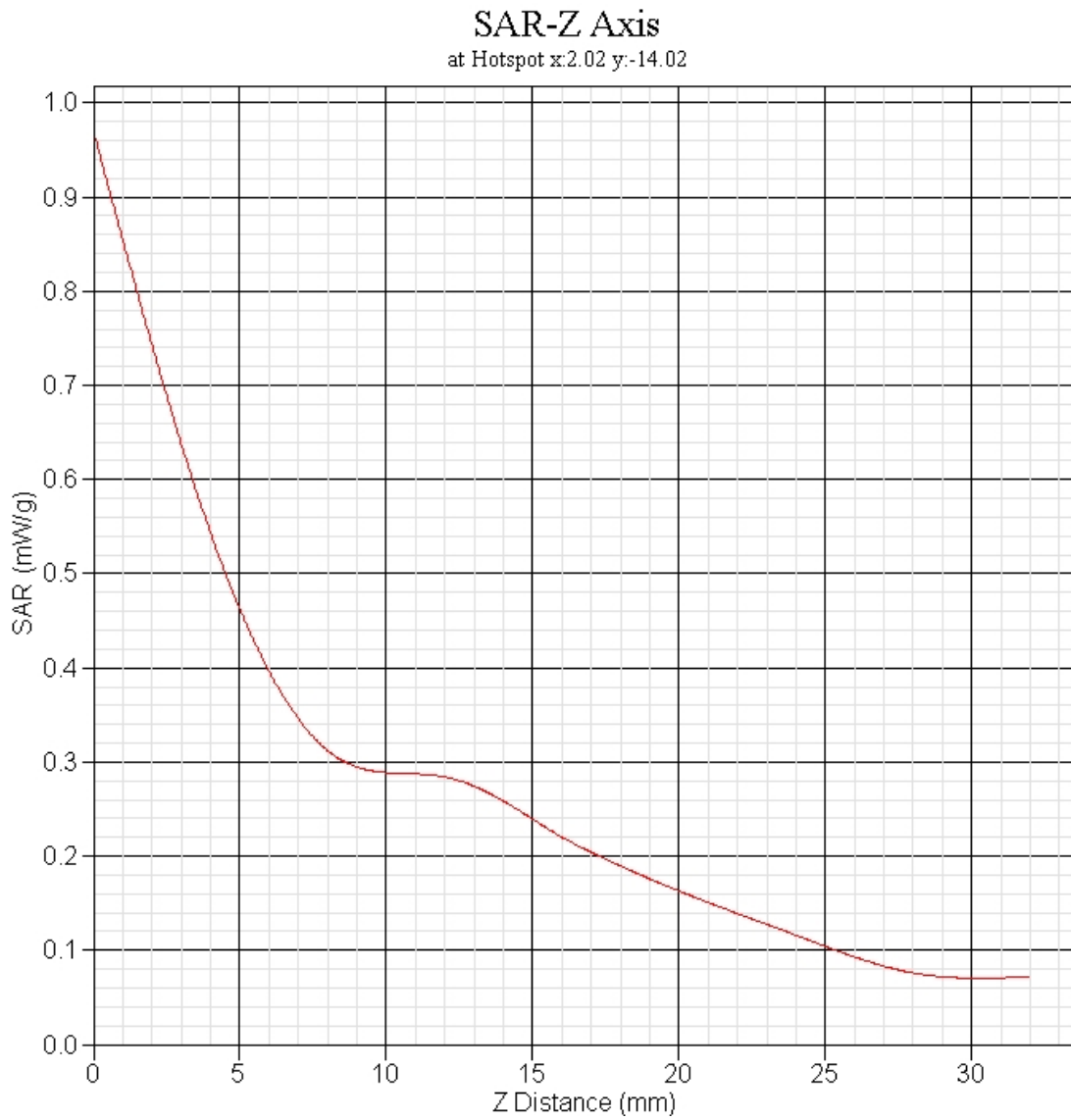

**Appendix C. Test Setup Photographs & EUT Photographs**  
**Test Setup Photographs**

**EUT Top**



**EUT Bottom**

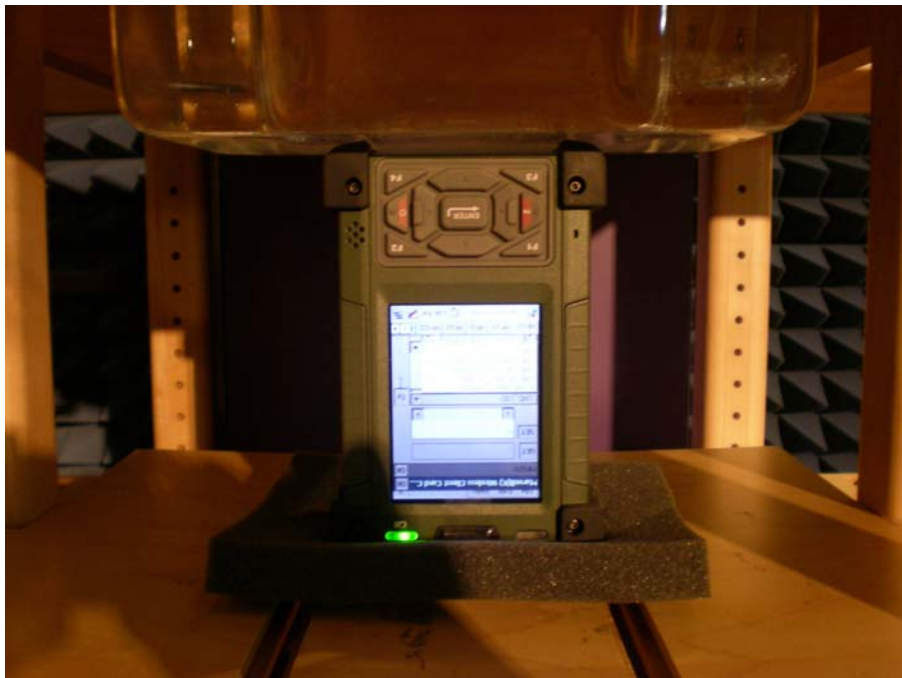

**EUT Back**



**EUT Right-side**



Note: The positions used in the measurements were according to IEEE 1528-2003.



EUT Photographs





## **Appendix D. Probe Calibration Data**

**Miniature Isotropic RF Probe**

**M/N: ALS-E-020**

**S/N: 265**

**2450 MHz Head Calibration**

**2450 MHz Body Calibration**



# NCL CALIBRATION LABORATORIES

Calibration File No.: CP-879

Client: QUIETEK

## CERTIFICATE OF CALIBRATION

It is certified that the equipment identified below has been calibrated in the **NCL CALIBRATION LABORATORIES** by qualified personnel following recognized procedures and using transfer standards traceable to NRC/NIST.

Equipment: Miniature Isotropic RF Probe 2450 MHz

Manufacturer: APREL Laboratories

Model No.: ALS-E-020

Serial No.: 265

HEAD Calibration

Calibration Procedure: SSI/DRB-TP-D01-032-E020-V2

Project No: QTKB-ALS-E20-CAL-5335

Calibrated: 9<sup>th</sup> May 2008  
Released on: 9<sup>th</sup> May 2008

This Calibration Certificate is Incomplete Unless Accompanied with the Calibration Results Summary

Released By: \_\_\_\_\_

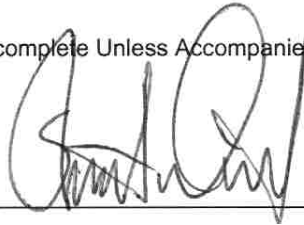

**NCL** CALIBRATION LABORATORIES

51 SPECTRUM WAY  
NEPEAN, ONTARIO  
CANADA K2R 1E6

Division of APREL Lab.  
TEL: (613) 820-4988  
FAX: (613) 820-4161

## Introduction

This Calibration Report reproduces the results of the calibration performed in line with the SSI/DRB-TP-D01-032-E020-V2 E-Field Probe Calibration Procedure. The results contained within this report are for APREL E-Field Probe E-020 265.

## References

SSI/DRB-TP-D01-032-E020-V2 E-Field Probe Calibration Procedure

IEEE 1528 "Recommended Practice for Determining the Peak Spatial-Average Specific Absorption Rate (SAR) in the Human Head Due to Wireless Communications Devices: Experimental Techniques"

SSI-TP-011 Tissue Calibration Procedure

IEC 62209 "Human exposure to radio frequency fields from hand-held and Head-mounted wireless communication devices – Human models, instrumentation, and procedures –Part 1 & 2: Procedure to determine the Specific Absorption Rate (SAR) for hand-held devices used in close proximity of the ear (frequency range of 300 MHz to 3 GHz)"

IEEE 1309 Draft Standard for Calibration of Electromagnetic Field Sensors and Probes, Excluding Antennas, from 9kHz to 40GHz

## Conditions

Probe 265 is a re-calibration.

**Ambient Temperature of the Laboratory:** 22 °C +/- 0.5°C

**Temperature of the Tissue:** 21 °C +/- 0.5°C

**We the undersigned attest that to the best of our knowledge the calibration of this probe has been accurately conducted and that all information contained within this report has been reviewed for accuracy.**

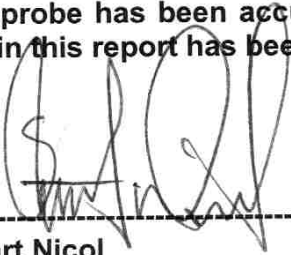
  
-----  
**Stuart Nicol**

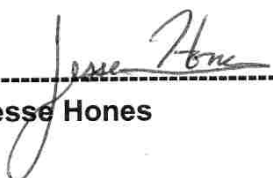
  
-----  
**Jesse Hones**

## Calibration Results Summary

<b>Probe Type:</b>	E-Field Probe E-020
<b>Serial Number:</b>	265
<b>Frequency:</b>	2450 MHz
<b>Sensor Offset:</b>	1.56 mm
<b>Sensor Length:</b>	2.5 mm
<b>Tip Enclosure:</b>	Ertalyte*
<b>Tip Diameter:</b>	<5 mm
<b>Tip Length:</b>	60 mm
<b>Total Length:</b>	290 mm

\*Resistive to recommended tissue recipes per IEEE-1528

## Sensitivity in Air

<b>Channel X:</b>	$1.2 \mu\text{V}/(\text{V}/\text{m})^2$
<b>Channel Y:</b>	$1.2 \mu\text{V}/(\text{V}/\text{m})^2$
<b>Channel Z:</b>	$1.2 \mu\text{V}/(\text{V}/\text{m})^2$
<b>Diode Compression Point:</b>	95 mV

## **Sensitivity in Head Tissue**

**Frequency:** 2450 MHz

**Epsilon:** 39.2 (+/-5%)      **Sigma:** 1.80 S/m (+/-5%)

### **ConvF**

**Channel X:** 3.67

**Channel Y:** 3.67

**Channel Z:** 3.67

Tissue sensitivity values were calculated using the load impedance of the APREL Laboratories Daq-Paq.

### **Boundary Effect:**

Uncertainty resulting from the boundary effect is less than 2% for the distance between the tip of the probe and the tissue boundary, when less than 2.44mm.

### **Spatial Resolution:**

The measured probe tip diameter is 5 mm (+/- 0.01 mm) and therefore meets the requirements of SSI/DRB-TP-D01-032 for spatial resolution.

## Receiving Pattern 2450 MHz (Air)

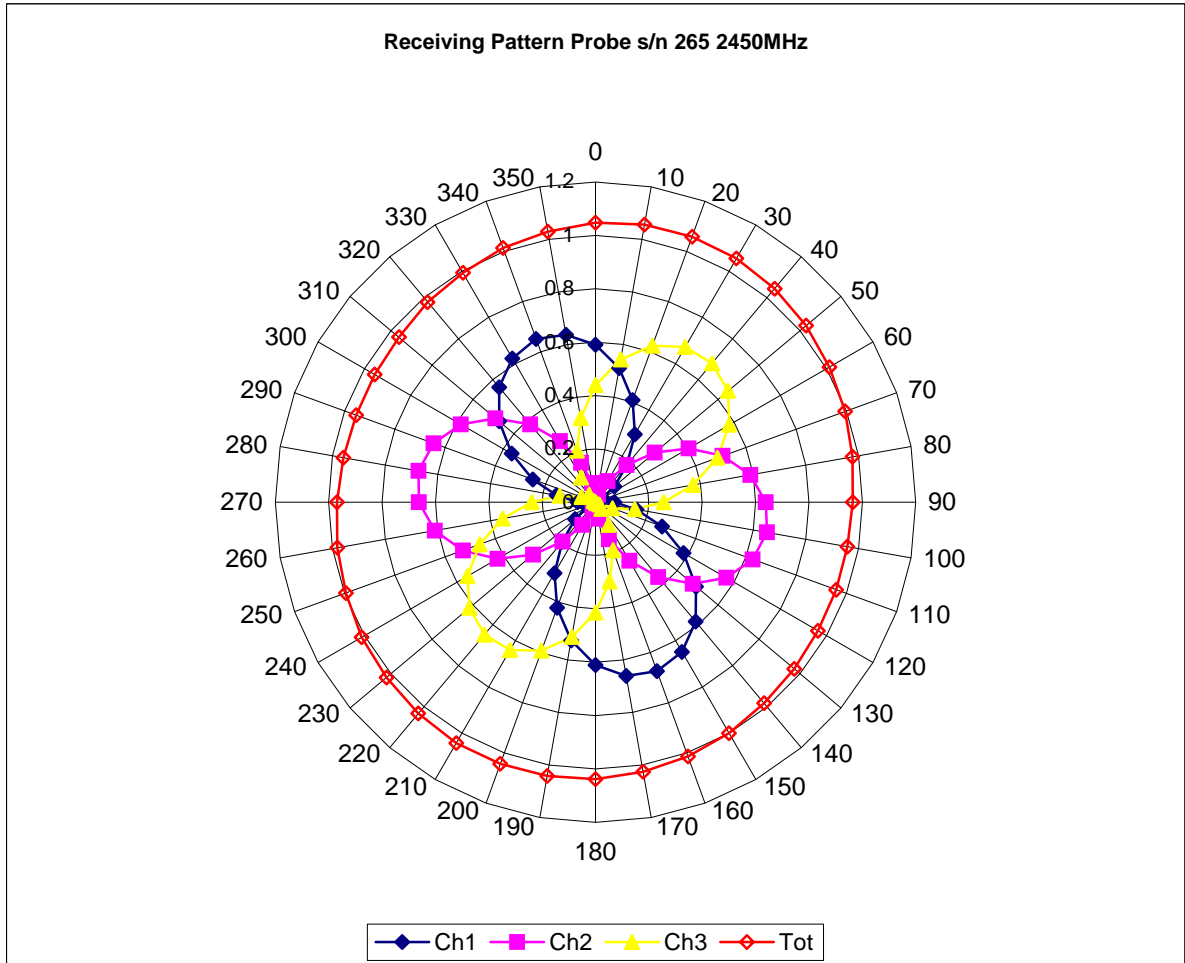

### Isotropy Error 2450 MHz (Air)

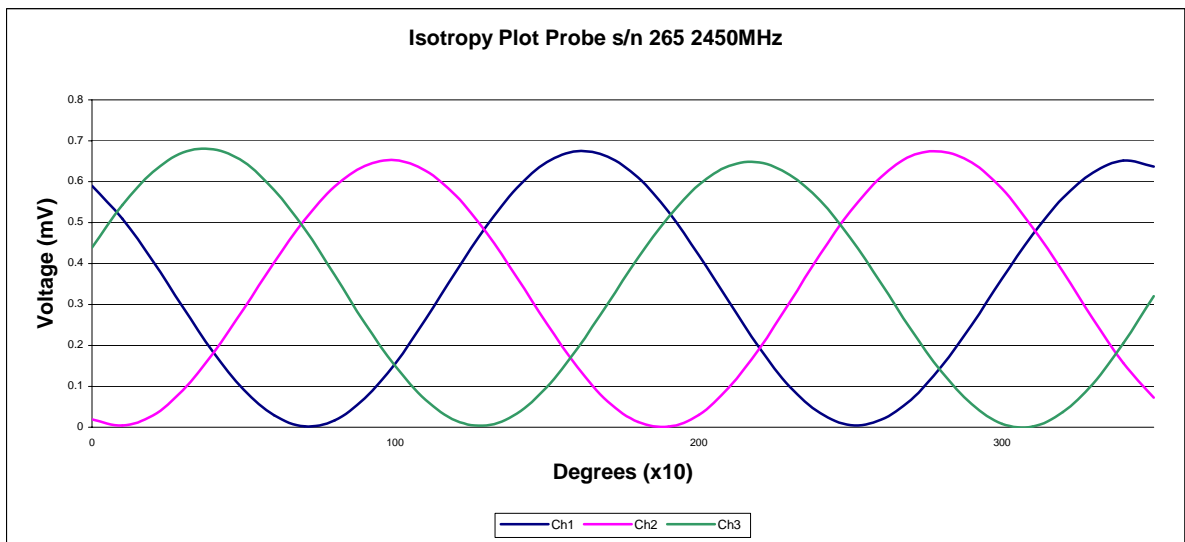
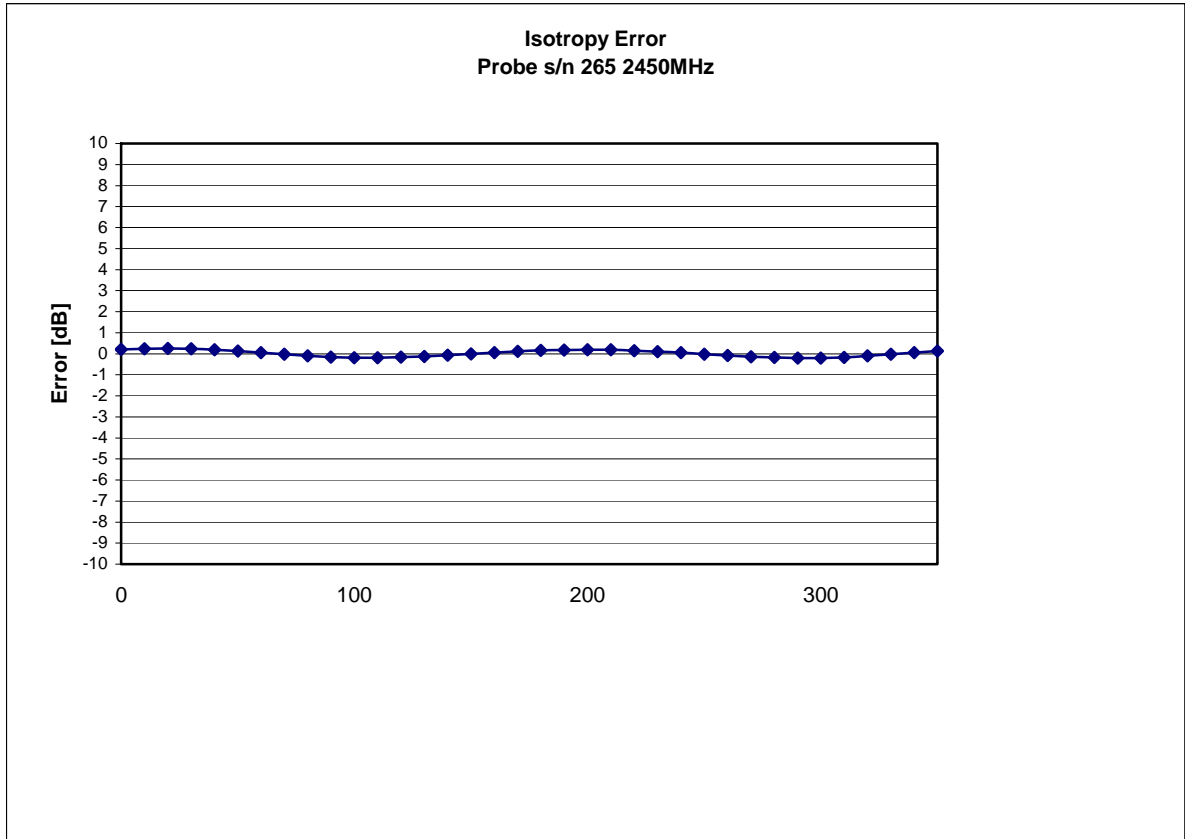

Isotropicity in Tissue:

0.10 dB

## Dynamic Range

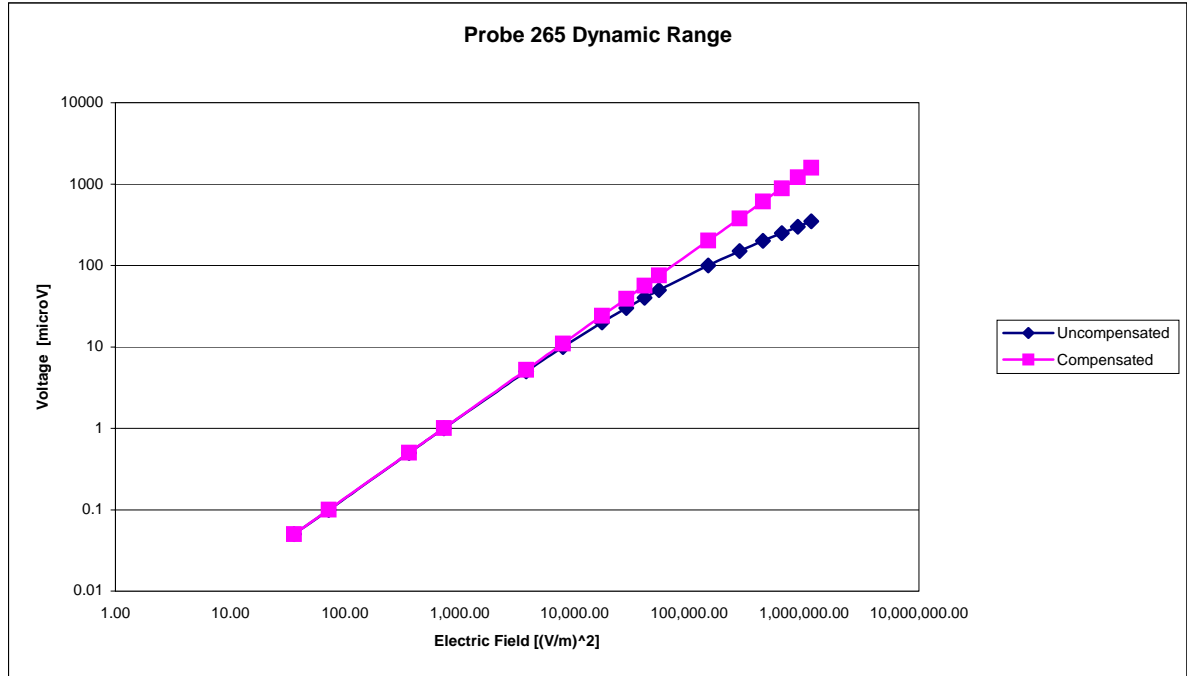

## Video Bandwidth

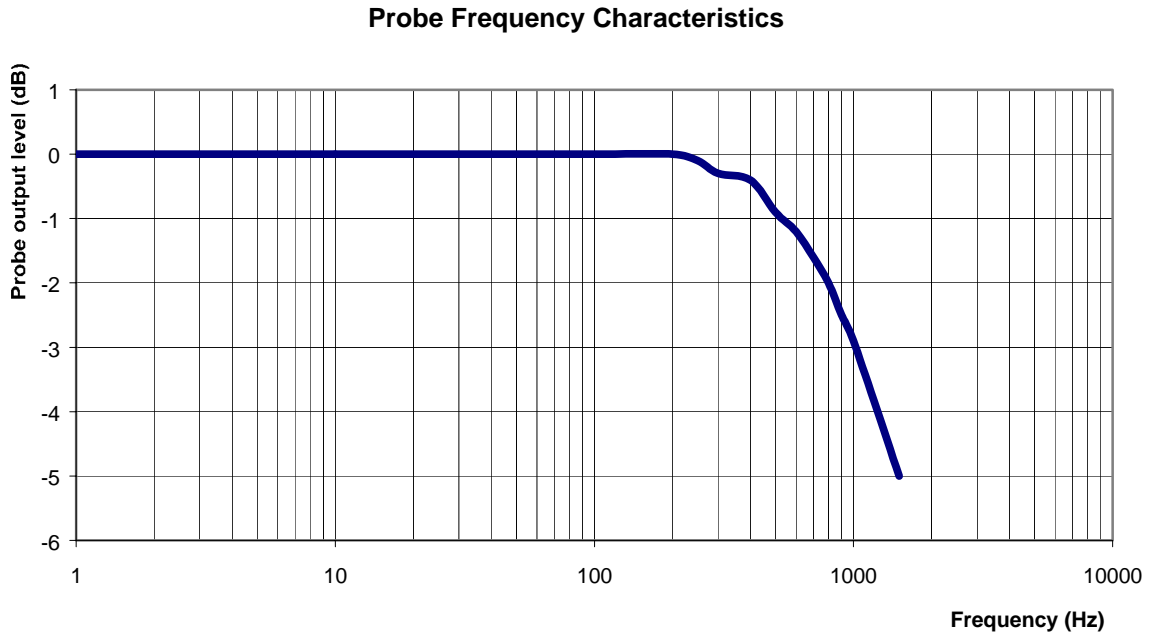

**Video Bandwidth at 500 Hz**            1 dB  
**Video Bandwidth at 1000 Hz**        3 dB



## **Conversion Factor Uncertainty Assessment**

**Frequency:** 2450MHz  
**Epsilon:** 39.2 (+/-5%)      **Sigma:** 1.80 S/m (+/-5%)

### **ConvF**

**Channel X:** 3.67      7%(K=2)

**Channel Y:** 3.67      7%(K=2)

**Channel Z:** 3.67      7%(K=2)

To minimize the uncertainty calculation all tissue sensitivity values were calculated using a load impedance of 5 MΩ.

### **Boundary Effect:**

For a distance of 2.4mm the evaluated uncertainty (increase in the probe sensitivity) is less than 2%.

## **Test Equipment**

The test equipment used during Probe Calibration, manufacturer, model number and, current calibration status are listed and located on the main APREL server R:\NCL\Calibration Equipment\Instrument List May 2008.

# NCL CALIBRATION LABORATORIES

Calibration File No.: CP-880

Client: QUIETEK

## CERTIFICATE OF CALIBRATION

It is certified that the equipment identified below has been calibrated in the **NCL CALIBRATION LABORATORIES** by qualified personnel following recognized procedures and using transfer standards traceable to NRC/NIST.

Equipment: Miniature Isotropic RF Probe 2450 MHz

Manufacturer: APREL Laboratories

Model No.: ALS-E-020

Serial No.: 265

BODY Calibration

Calibration Procedure: SSI/DRB-TP-D01-032-E020-V2

Project No: QTKB-ALS-E20-CAL-5335

Calibrated: 9<sup>th</sup> May 2008  
Released on: 9<sup>th</sup> May 2008

This Calibration Certificate is Incomplete Unless Accompanied with the Calibration Results Summary

Released By: \_\_\_\_\_

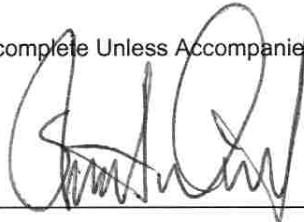

**NCL** CALIBRATION LABORATORIES

51 SPECTRUM WAY  
NEPEAN, ONTARIO  
CANADA K2R 1E6

Division of APREL Lab.  
TEL: (613) 820-4988  
FAX: (613) 820-4161

## Introduction

This Calibration Report reproduces the results of the calibration performed in line with the SSI/DRB-TP-D01-032-E020-V2 E-Field Probe Calibration Procedure. The results contained within this report are for APREL E-Field Probe E-020 265.

## References

SSI/DRB-TP-D01-032-E020-V2 E-Field Probe Calibration Procedure

IEEE 1528 "Recommended Practice for Determining the Peak Spatial-Average Specific Absorption Rate (SAR) in the Human Head Due to Wireless Communications Devices: Experimental Techniques"

SSI-TP-011 Tissue Calibration Procedure

IEC 62209 "Human exposure to radio frequency fields from hand-held and Head-mounted wireless communication devices – Human models, instrumentation, and procedures –Part 1 & 2: Procedure to determine the Specific Absorption Rate (SAR) for hand-held devices used in close proximity of the ear (frequency range of 300 MHz to 3 GHz)"

IEEE 1309 Draft Standard for Calibration of Electromagnetic Field Sensors and Probes, Excluding Antennas, from 9kHz to 40GHz

## Conditions

Probe 265 is a re-calibration.

**Ambient Temperature of the Laboratory:** 22 °C +/- 0.5°C

**Temperature of the Tissue:** 21 °C +/- 0.5°C

**We the undersigned attest that to the best of our knowledge the calibration of this probe has been accurately conducted and that all information contained within this report has been reviewed for accuracy.**

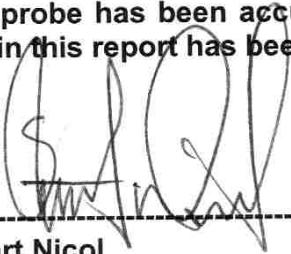
  
-----  
**Stuart Nicol**

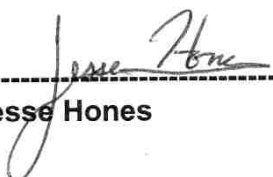
  
-----  
**Jesse Hones**

## Calibration Results Summary

<b>Probe Type:</b>	E-Field Probe E-020
<b>Serial Number:</b>	265
<b>Frequency:</b>	2450 MHz
<b>Sensor Offset:</b>	1.56 mm
<b>Sensor Length:</b>	2.5 mm
<b>Tip Enclosure:</b>	Ertalyte*
<b>Tip Diameter:</b>	<5 mm
<b>Tip Length:</b>	60 mm
<b>Total Length:</b>	290 mm

\*Resistive to recommended tissue recipes per IEEE-1528

## Sensitivity in Air

<b>Channel X:</b>	1.2 $\mu\text{V}/(\text{V}/\text{m})^2$
<b>Channel Y:</b>	1.2 $\mu\text{V}/(\text{V}/\text{m})^2$
<b>Channel Z:</b>	1.2 $\mu\text{V}/(\text{V}/\text{m})^2$
<b>Diode Compression Point:</b>	95 mV

## **Sensitivity in Body Tissue**

**Frequency:** 2450 MHz

**Epsilon:** 52.7 (+/-5%)      **Sigma:** 1.95 S/m (+/-5%)

### **ConvF**

**Channel X:** 3.55

**Channel Y:** 3.55

**Channel Z:** 3.55

Tissue sensitivity values were calculated using the load impedance of the APREL Laboratories Daq-Paq.

### **Boundary Effect:**

Uncertainty resulting from the boundary effect is less than 2% for the distance between the tip of the probe and the tissue boundary, when less than 2.44mm.

### **Spatial Resolution:**

The measured probe tip diameter is 5 mm (+/- 0.01 mm) and therefore meets the requirements of SSI/DRB-TP-D01-032 for spatial resolution.

## Receiving Pattern 2450 MHz (Air)

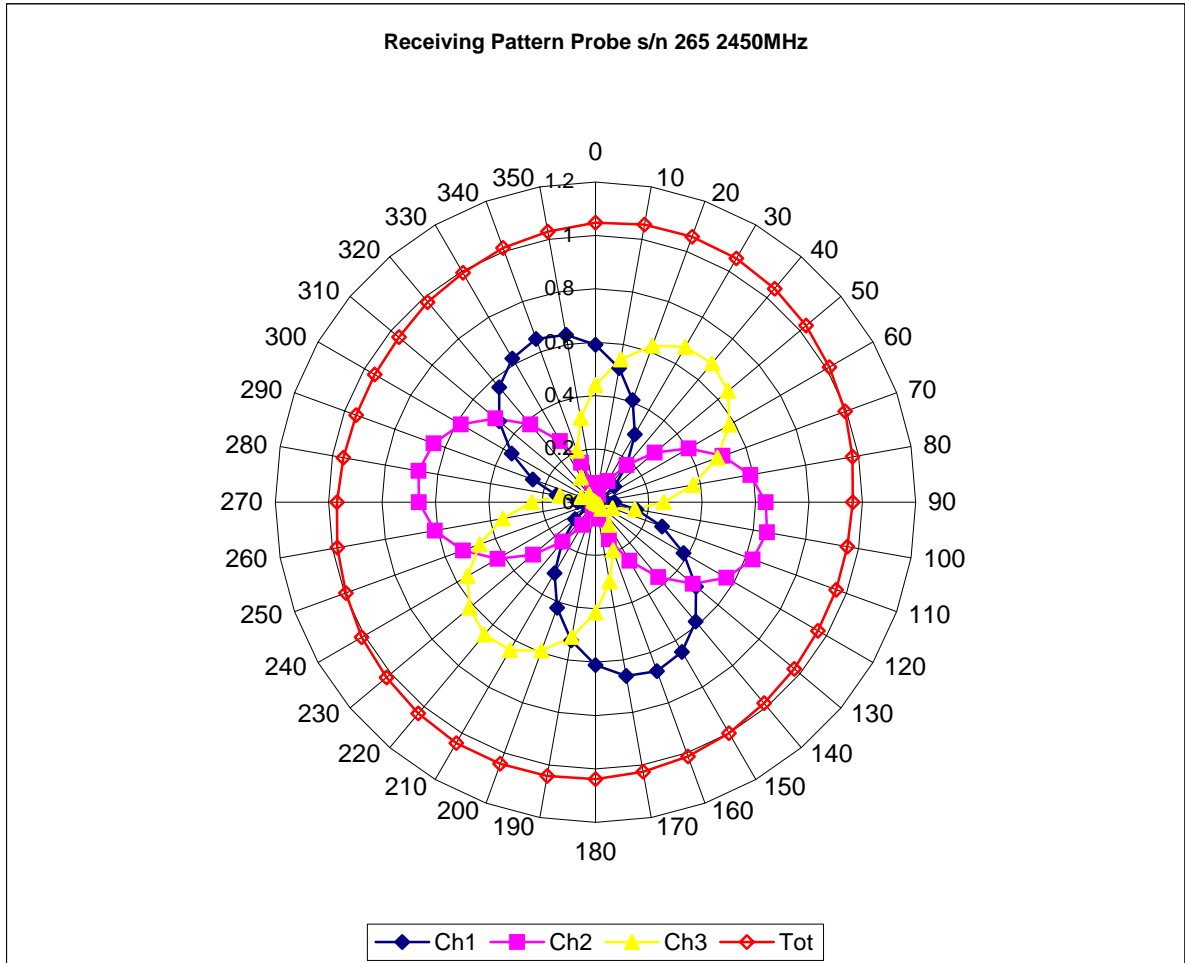

### Isotropy Error 2450 MHz (Air)

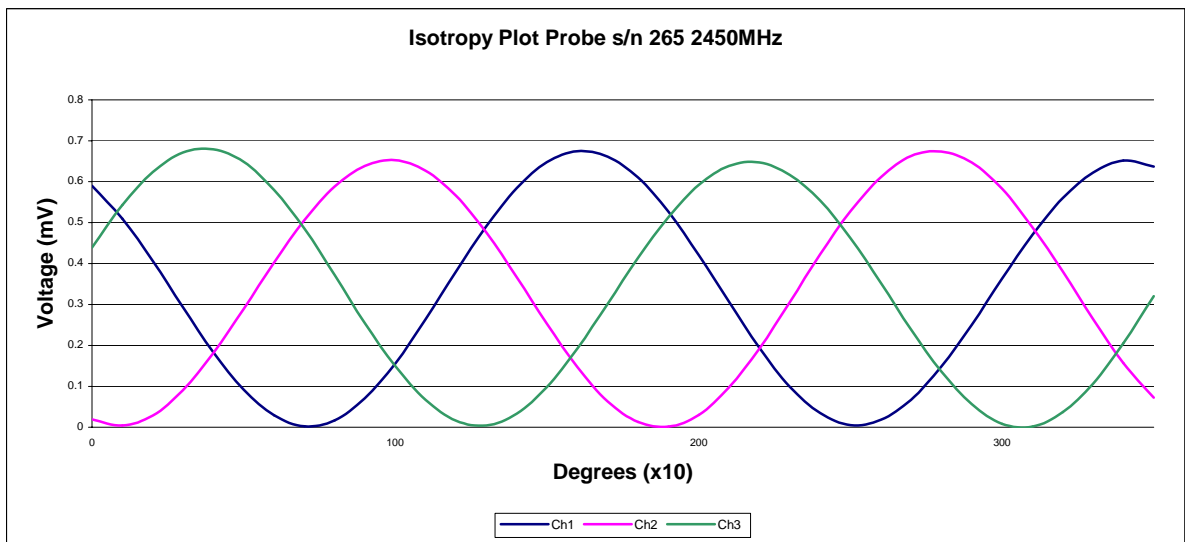
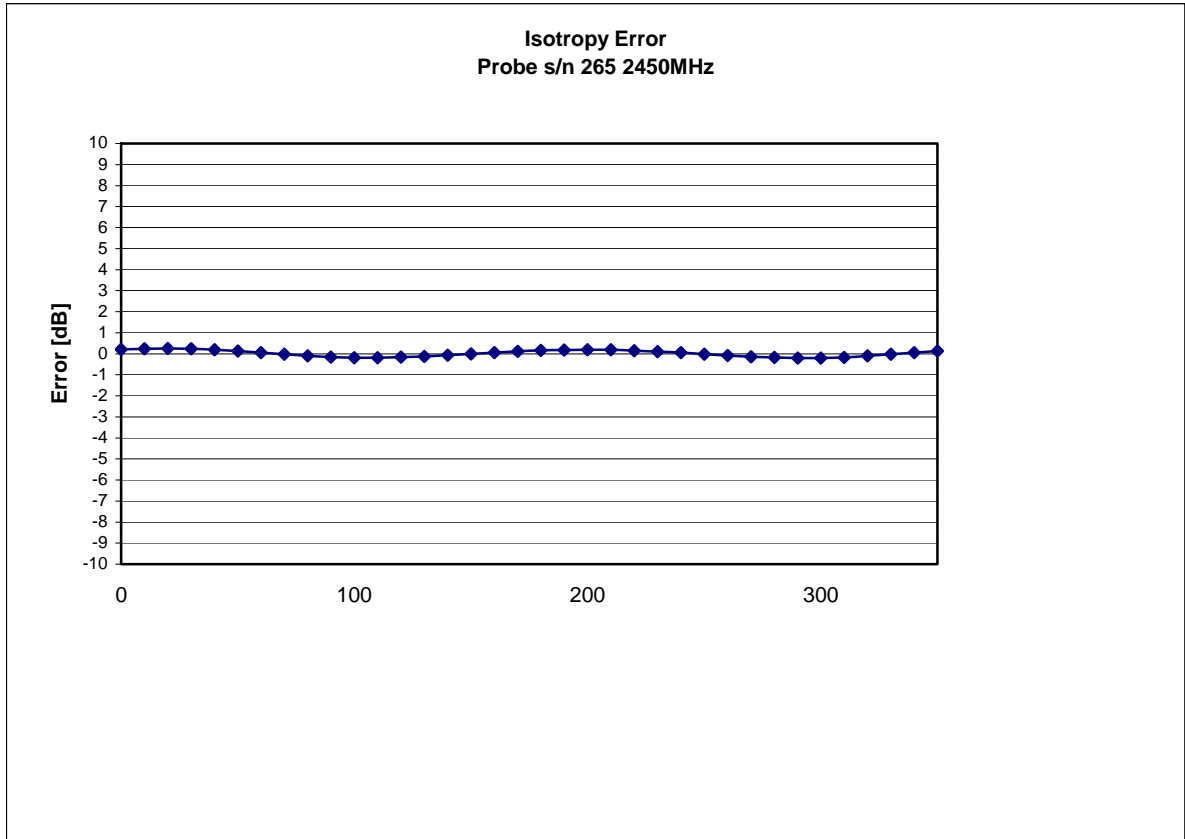

Isotropicity in Tissue:

0.10 dB



## Dynamic Range

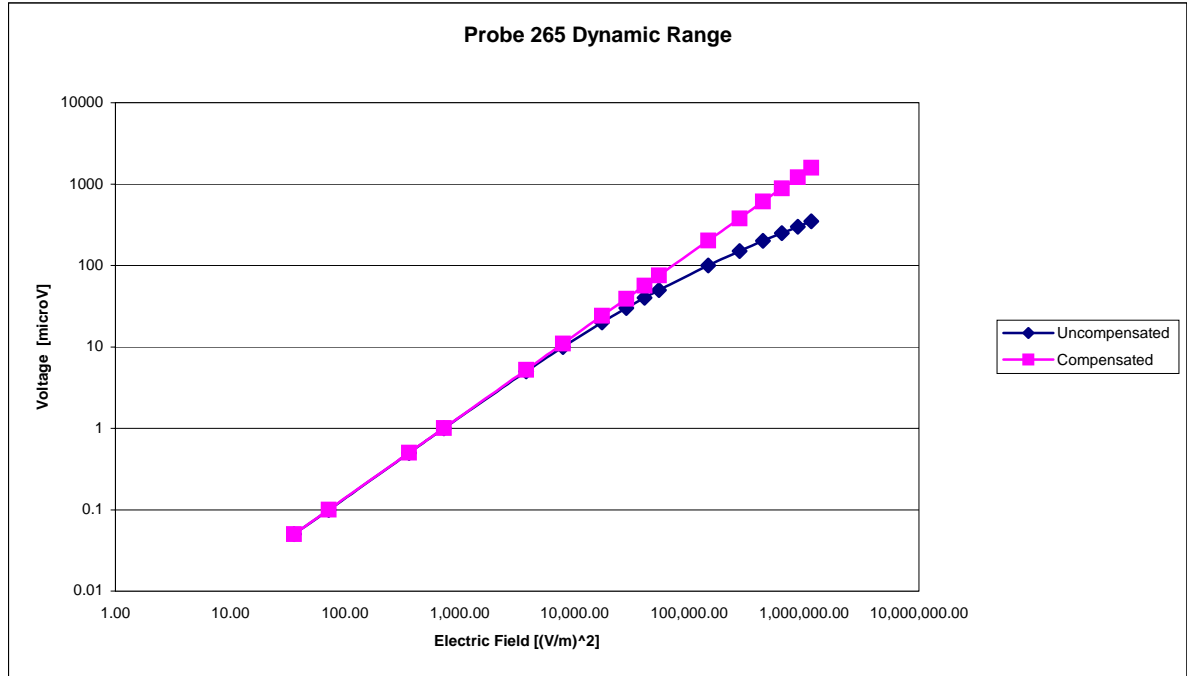

## Video Bandwidth

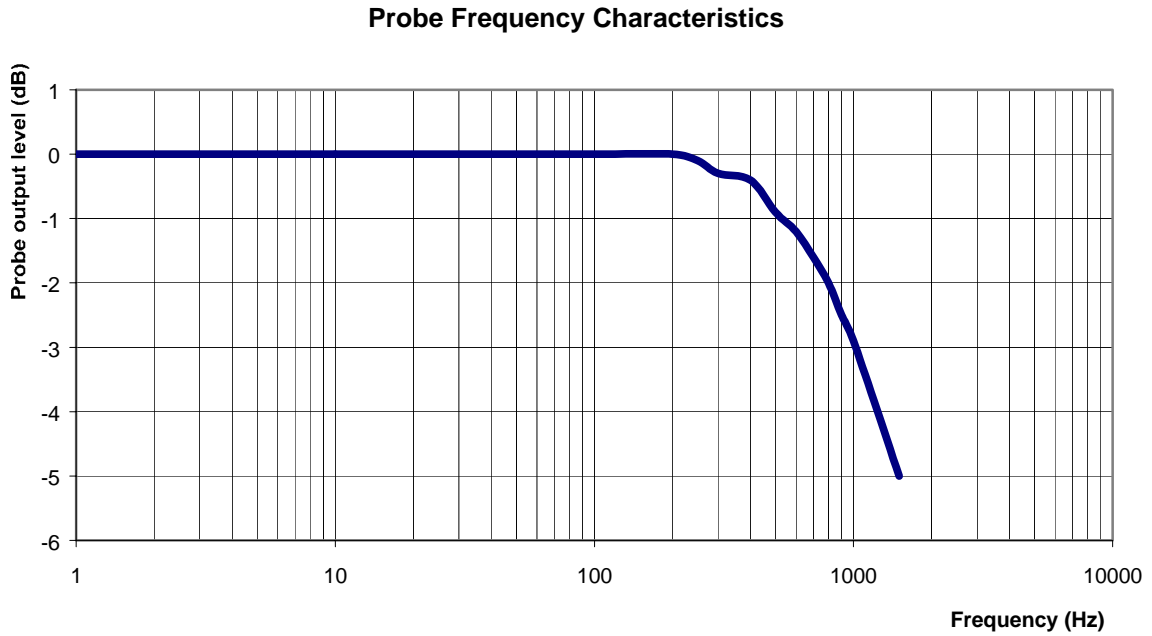

**Video Bandwidth at 500 Hz**            1 dB  
**Video Bandwidth at 1000 Hz**        3 dB

## **Conversion Factor Uncertainty Assessment**

**Frequency:** 2450MHz  
**Epsilon:** 52.7 (+/-5%)      **Sigma:** 1.95 S/m (+/-5%)

### **ConvF**

**Channel X:** 3.55      7%(K=2)

**Channel Y:** 3.55      7%(K=2)

**Channel Z:** 3.55      7%(K=2)

To minimize the uncertainty calculation all tissue sensitivity values were calculated using a load impedance of 5 MΩ.

### **Boundary Effect:**

For a distance of 2.4mm the evaluated uncertainty (increase in the probe sensitivity) is less than 2%.

## **Test Equipment**

The test equipment used during Probe Calibration, manufacturer, model number and, current calibration status are listed and located on the main APREL server R:\NCL\Calibration Equipment\Instrument List May 2008.



## **Appendix E. Dipole Calibration**

**Validation Dipole 2450 MHz**

**M/N: ALS-D-2450-S-2**

**S/N: QTK-319**

# NCL CALIBRATION LABORATORIES

Calibration File No: DC-891

## CERTIFICATE OF CALIBRATION

It is certified that the equipment identified below has been calibrated in the **NCL CALIBRATION LABORATORIES** by qualified personnel following recognized procedures and using transfer standards traceable to NRC/NIST.

Quietek Validation Dipole

Manufacturer: APREL Laboratories

Part number: ALS-D-2450-S-2

Frequency: 2.45 GHz

Serial No: QTK-319

Customer: Quietek

Project Number: QTKB-Dipole-CAL-5336

Calibrated: 9<sup>th</sup> May 2008  
Released on: 9<sup>th</sup> May 2008

This Calibration Certificate is Incomplete Unless Accompanied with the Calibration Results Summary

Released By: \_\_\_\_\_

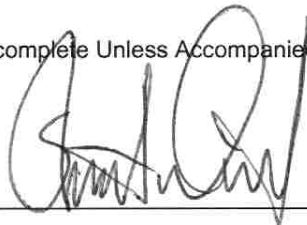

**NCL CALIBRATION LABORATORIES**

51 SPECTRUM WAY  
NEPEAN, ONTARIO  
CANADA K2R 1E6

Division of APREL Lab.  
TEL: (613) 820-4988  
FAX: (613) 820-4161

## Calibration Results Summary

The following results relate the Calibrated Dipole and should be used as a quick reference for the user.

### Mechanical Dimensions

**Length:** 53.5 mm  
**Height:** 30.4 mm

### Electrical Specification

**SWR:** 1.19 U  
**Return Loss:** -20.8 dB  
**Impedance:** 49.4  $\Omega$

### System Validation Results

Frequency	1 Gram	10 Gram	Peak
2.45 GHz	48.07	25.65	95.6

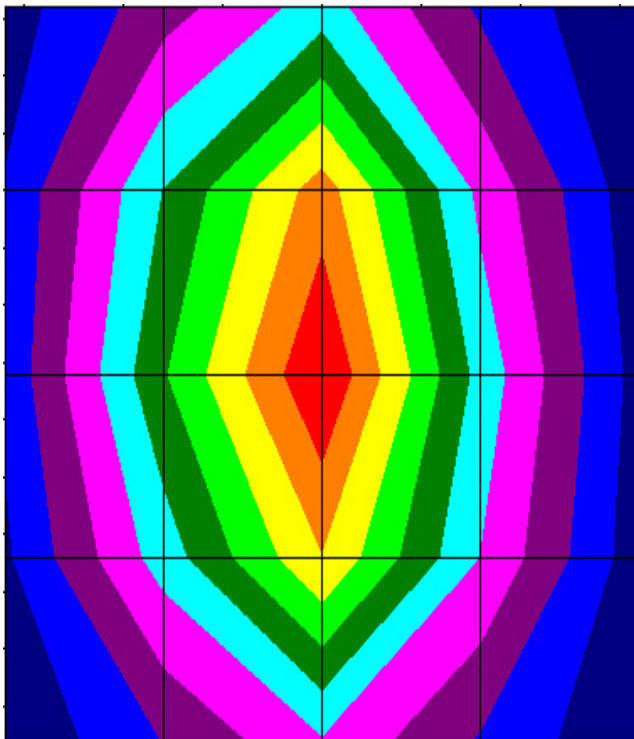

## Conditions

Dipole 319 is a recalibration.

**Ambient Temperature of the Laboratory:** 22 °C +/- 0.5°C  
**Temperature of the Tissue:** 21 °C +/- 0.5°C

## References

SSI-TP-018-ALSAS Dipole Calibration Procedure

SSI-TP-016 Tissue Calibration Procedure

IEEE 1528 "Recommended Practice for Determining the Peak Spatial-Average Specific Absorption Rate (SAR) in the Human Body Due to Wireless Communications Devices: Experimental Techniques"

IEC 62209 "Human exposure to radio frequency fields from hand-held and body-mounted wireless communication devices – Human models, instrumentation, and procedures –Part 1 & Part 2: Procedure to determine the specific absorption rate (SAR) for mobile wireless communication devices used in close proximity to the human body (frequency range of 30 MHz to 6 GHz)

We the undersigned attest that to the best of our knowledge the calibration of this device has been accurately conducted and that all information contained within this report has been reviewed for accuracy.



-----  
**Stuart Nicol**



-----  
**C. Teodorian**



## **Dipole Calibration Results**

### **Mechanical Verification**

<b>IEEE Length</b>	<b>IEEE Height</b>	<b>Measured Length</b>	<b>Measured Height</b>
51.5 mm	30.4 mm	53.5 mm	30.4 mm

### **Tissue Validation**

<b>Head Tissue 2450 MHz</b>	<b>Measured</b>
<b>Dielectric constant, <math>\epsilon_r</math></b>	40.1
<b>Conductivity, <math>\sigma</math> [S/m]</b>	1.78

**Electrical Calibration**

Test	Result
S11 R/L	-20.8 dB
SWR	1.2 U
Impedance	49.4 $\Omega$

The Following Graphs are the results as displayed on the Vector Network Analyzer.

**S11 Parameter Return Loss**

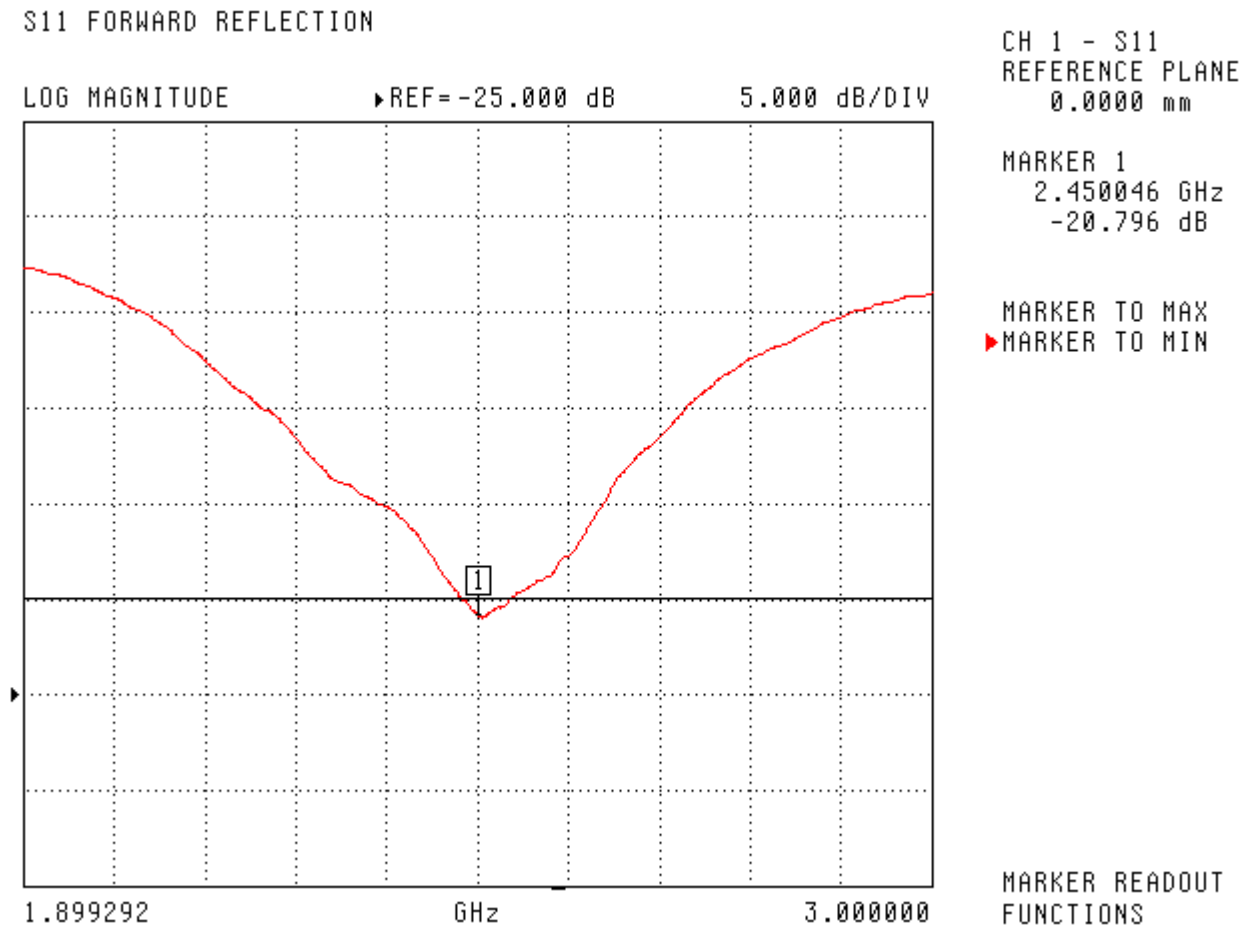

SWR

S11 FORWARD REFLECTION

SWR

REF=500.000 mU

1.000 U/DIV

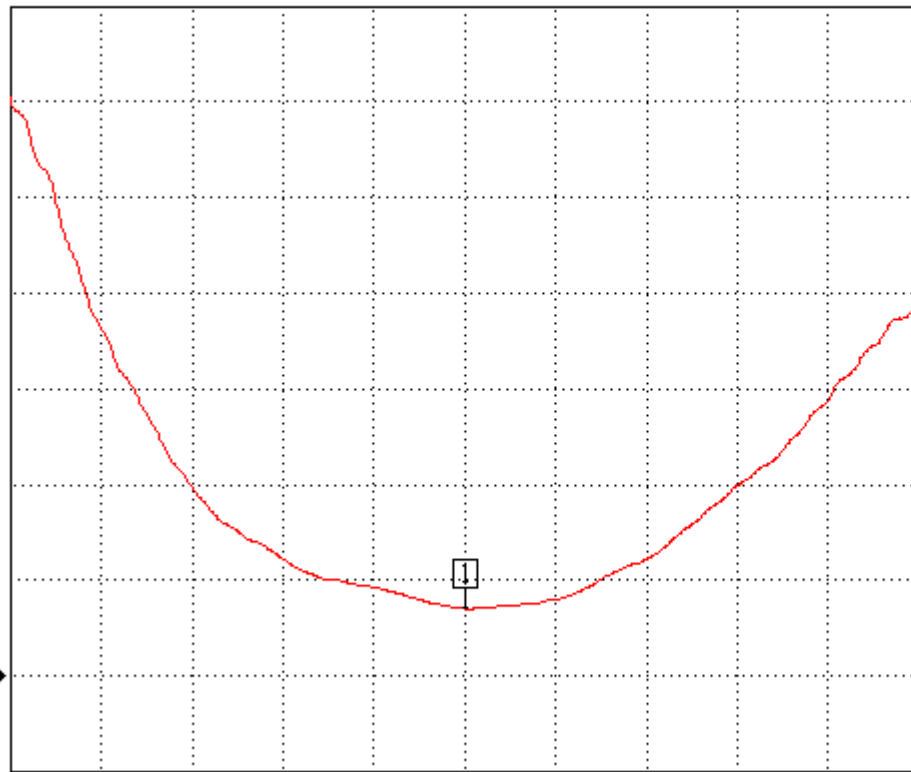

CH 1 - S11  
REFERENCE PLANE  
0.0000 mm

MARKER 1  
2.450046 GHz  
1.199 U

MARKER TO MAX  
▶ MARKER TO MIN

1.899292

GHz

3.000000

MARKER READOUT  
FUNCTIONS

## Smith Chart Dipole Impedance

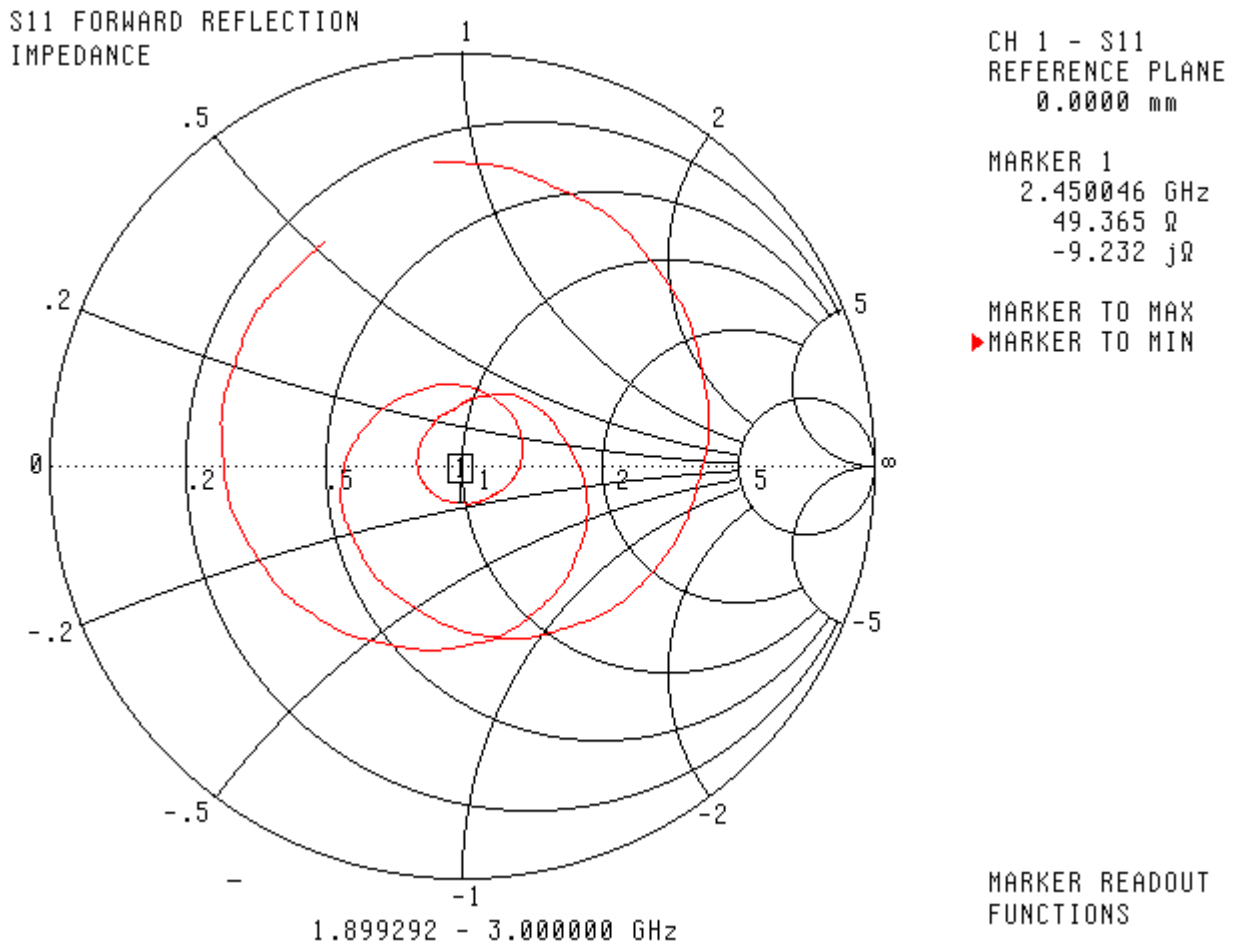

**System Validation Results Using the Electrically Calibrated Dipole**

<b>Frequency</b>	<b>1 Gram</b>	<b>10 Gram</b>	<b>Peak Above Feed Point</b>
2.45 GHz	48.07	25.65	95.6

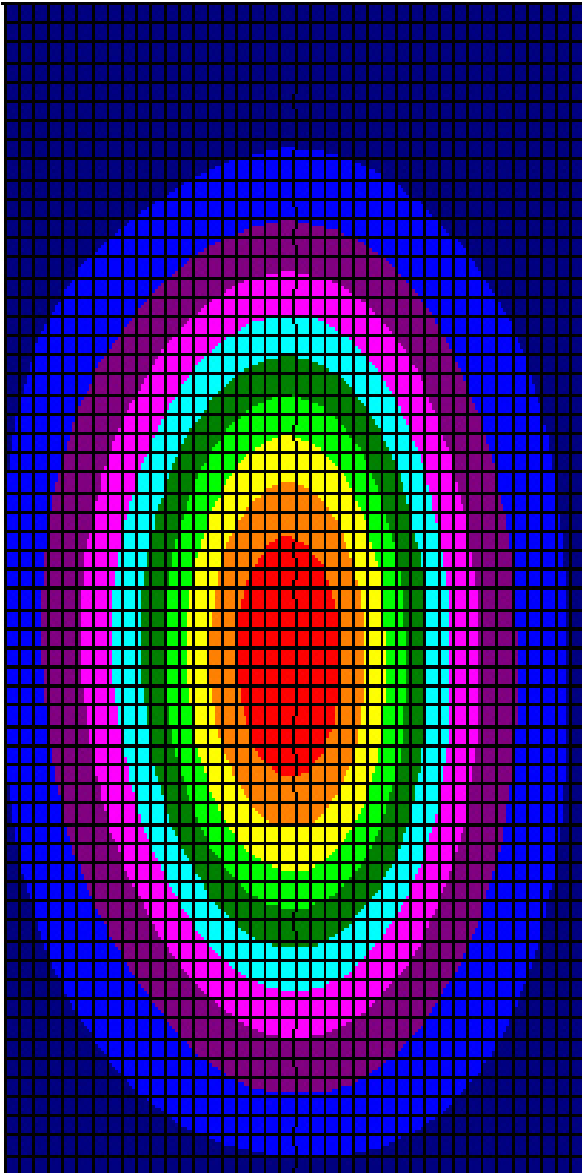

## **NCL Calibration Laboratories**

---

Division of APREL Laboratories.

### **Test Equipment**

The test equipment used during Probe Calibration, manufacturer, model number and, current calibration status are listed and located on the main APREL server R:\NCL\Calibration Equipment\Instrument List May 2008.