

FCC TEST REPORT

according to

FCC Rules and Regulations

Part 15 Subpart C

Applicant	: Advantech CO., Ltd.
Address	: No.1, Alley20, Lane 26, Rueiquang Road, Neihu District, Taipei, Taiwan 114, R.O.C.
Equipment	: Industrial Tablet PC
Model No.	: MARS-3100R
FCC ID	: M82-M31R01
Trade Name	: ADVANTECH

Laboratory Accreditation



- The test result refers exclusively to the test presented test model / sample.,
- Without written approval of **Exclusive Certification Corp.** the test report shall not be reproduced except in full.
- The EUT is also considered as a kind of computer peripheral, because the connection to computer is necessary for typical use. It has been verified to comply with the requirements of FCC Part 15, Subpart B, Class B (DoC). The test report has been issued separately.

Contents

1.	Report of Measurements and Examinations.....	5
1.1	List of Measurements and Examinations	5
2.	Test Configuration of Equipment under Test.....	6
2.1	Feature of Equipment under Test.....	6
2.2	RF Specifications	7
2.3	Test Mode & Test Software	8
2.4	Description of Test System.....	8
2.5	Connection Diagram of Test System.....	9
2.6	General Information of Test.....	10
2.7	Measurement Uncertainty	10
2.8	History of this test report	11
3.	Antenna Requirements	12
3.1	Standard Applicable	12
3.2	Antenna Construction and Directional Gain.....	12
4.	Test of Conducted Emission	13
4.1	Test Limit.....	13
4.2	Test Procedures.....	13
4.3	Typical Test Setup	14
4.4	Measurement equipment	14
4.5	Test Result and Data.....	15
4.6	Test Photographs	21
5.	Test of Radiated Emission	22
5.1	Test Limit.....	22
5.2	Test Procedures.....	23
5.3	Typical Test Setup	24
5.4	Measurement equipment	24
5.5	Test Result and Data.....	25
5.6	Test Photographs	55
6.	20dB Bandwidth Measurement Data.....	56
6.1	Test Limit	56
6.2	Test Procedures	56
6.3	Test Setup Layout	56
6.4	Measurement equipment	56
6.5	Test Result and Data.....	56
7.	Frequencies Separation	62
7.1	Test Limit	62
7.2	Test Procedures	62
7.3	Test Setup Layout	62
7.4	Measurement equipment	62
7.5	Test Result and Data.....	62
8.	Dwell Time on each channel	68
8.1	Test Limit	68
8.2	Test Procedures	68
8.3	Test Setup Layout	68
8.4	Measurement equipment	68
8.5	Test Result and Data.....	68

9. Number of Hopping Channels	78
9.1 Test Limit	78
9.2 Test Procedures	78
9.3 Test Setup Layout	78
9.4 Measurement equipment	78
9.5 Test Result and Data	78
10. Maximum Peak Output Power	81
10.1 Test Limit	81
10.2 Test Procedures	81
10.3 Test Setup Layout	81
10.4 Measurement equipment	81
10.5 Test Result and Data	81
11. Band Edges Measurement	87
11.1 Test Limit	87
11.2 Test Procedure :	87
11.3 Test Setup Layout	87
11.4 List of Measuring Equipment Used	87
11.5 Test Result and Data	87
11.6 Restrict band emission Measurement Data	94
12. Power Spectral Density	96
12.1 Test Limit	96
12.2 Test Procedures	96
12.3 Test Setup Layout :	96
12.4 List of Measuring Equipment Used	96
12.5 Test Result and Data	96
13. Restricted Bands of Operation	102
13.1 Labeling Requirement	102
Appendix A. Photographs of EUT	A1 ~ A24

CERTIFICATE OF COMPLIANCE

according to

FCC Rules and Regulations

Part 15 Subpart C

Applicant : Advantech CO., Ltd.
Address : No.1, Alley20, Lane 26, Rueiquang Road, Neihu
District, Taipei, Taiwan 114, R.O.C.
Equipment : Industrial Tablet PC
Model No. : MARS-3100R
FCC ID : M82-M31R01

I HEREBY CERTIFY THAT :

The measurements shown in this test report were made in accordance with the procedures given in **ANSI C63.4** The equipment was **passed** the test performed according to **FCC Rules and Regulations Part 15 Subpart C (2003)**.

The test was carried out on May. 12, 2008 at **Exclusive Certification Corp.**

Signature

Anson Chou / Manager

1. Report of Measurements and Examinations

1.1 List of Measurements and Examinations

FCC Rule	Description of Test	Result
15.203	. Antenna Requirement	Pass
15.207	. Conducted Emission	Pass
15.209	. Radiated Emission	Pass
15.247(a)(1)	. Channel Carrier Frequencies Separation	Pass
15.247(a)(1)	. 20dB Bandwidth Measurement	Pass
15.247(a)(1)	. Dwell Time	Pass
15.247(b)	. Number of Hopping Channels	Pass
15.247(b)	. Peak Output Power Measurement Data	Pass
15.247(d)	. Band Edges Measurement Data	Pass
15.247(e)	. Power Spectral Density Measurement Data	Pass

2. Test Configuration of Equipment under Test

2.1 Feature of Equipment under Test

OS	MS XP Professional
Dimension W x D x H	293 x 210 x 38 mm
Weight	2.1 kg
Panel	10.4" XGA TFT (Sunlight readable option)
Touchscreen	Digitizer / Resistant touchscreen
CPU	Intel Pentium Duo Core Ultra Low Voltage U2500 1.2GHz
DRAM	1GB DDRII533 (One memory module support)
L2 cache	1 MB
Chipset	Intel 945GME
Graphic	Intel 945GME with shared memory
Storage	2.5" shock mounted HDD (CF storage option)
Keypad	5-way navigation key; 3 x function key (programmable)
Wireless	802.11 a/b/g
WAN	SmartBay option GSM/GPRS/EDGE
PAN	Bluetooth V2.0/EDR (default)
Microphone Jack	Yes
Headset Jack	Yes
RS232	Yes (COM3)
USB	USB2.0 x 2
RJ-45	10/100 Base-T
DC-in	Yes
VGA D_sub connector	Yes
Docking / Port Replicator	Yes
AC97 Audio I/F	HD Audio I/F
Speaker	One integrated speaker
Battery	Removable 11.1V@3600mAh Li-ion battery pack; swappable
Battery Life	3 hour battery life
Charging Time	2.5 hours to 90%
Backup Battery	7.2V, 120mAh
Adapter	Auto-switching 100-240V, 50-60Hz; supplies 19VDC at 3.42A

2.2 RF Specifications

Type of Modulation	802.11b: DSSS (CCK, DQPSK, DBPSK) 802.11g: OFDM (64-QAM, 16-QAM, QPSK, BPSK) 802.11a: OFDM BT: GFSK, $\pi/4$ -DQPSK, 8DPSK
Data Rate	802.11b(11, 5.5, 2, 1 Mbps) 802.11g(54 Mbps, 48 Mbps, 36 Mbps, 24 Mbps, 18 Mbps, 12 Mbps, 9 Mbps, 6 Mbps) 802.11a(54 Mbps, 48 Mbps, 36 Mbps, 24 Mbps, 18 Mbps, 12 Mbps, 9 Mbps, 6 Mbps) 802.11BT(3Mbps, 2Mbps, 1Mbps)
Number of Channels	Number of Channels 802.11b / 802.11g USA, Canada and Taiwan: 1 ~ 11 (11 Channels) Most European Countries: 1 ~ 13 (13 Channels) France: 1 ~ 7 (7 Channels) 802.11a USA, Canada and Taiwan: 36 ~ 48, 149 ~ 165 (9 Channels) Most European Countries: 36 ~ 64, 100 ~ 140 (19 Channels) BT: 0 ~ 78 (79 Channels)
Frequency Band	USA, Canada and Taiwan: 802.11b/g, BT: 2.4 ~ 2.4835GHz 802.11a: 5.15 ~ 5.25GHz, 5.725 ~ 5.85GHz Most European Countries: 802.11b/g, BT: 2.4 ~ 2.4835GHz 802.11a: 5.15 ~ 5.35GHz, 5.47 ~ 5.725GHz
Carrier Frequency of each channel	802.11b / 802.11g US: 2412 + 5 * K MHz; K = 0 ~ 10 EU: 2412 + 5 * K MHz; K = 0 ~ 12 France: 2412 + 5 * K MHz; K = 0 ~ 6 802.11a US : 5150 ~ 5250: 5180 + 20 K MHz; K = 0 ~ 3 5725 ~ 5850: 5745 + 20 K MHz; K = 0 ~ 4 EU: 5150 ~ 5250: 5180 + 20 K MHz; K = 0 ~ 7 5470 ~ 5725: 5500 + 20 K MHz; K = 0 ~ 10 BT: 2402 + K MHz; K = 0 ~ 78
Channel Spacing	802.11b/g: 5MHz ; 802.11a: 20MHz ; BT: 1MHz
Output Power	Max. Peak Output power (FCC): 802.11b: 18 dBm; 802.11g: 15 dBm; 802.11a: 13 dBm; BT: 0 dBm E.I.R.P (CE) 802.11b: 17 dBm; 802.11g: 14 dBm 802.11a: 12 dBm; BT: 0 dBm
Antenna Type	GPRS + WL Antenna (AT103-105) PCB Antenna (GB04001-A01)
Antenna Gain	AT103-105 (WLAN) 1.54 dBi (2.4GHz) 1.74 dBi (5GHz) GB04001-A01 (BT) 2.2 dBi

2.3 Test Mode & Test Software

- a. During testing, the interface cables and equipment positions were varied according to ANSI C63.4
- b. The complete test system included the remote workstation, Monitor, Modem, Flash Memory, Earphone and EUT for EMC test. The remote workstation means Toshiba Notebook.
- c. An executive program, EMITEST.exe under WIN XP, which generates a complete line of continuously repeating "H" pattern was used as the test software.

The program was executed as follows:

1. Turn on the power of all equipment.
 2. The EUT reads the test program from the hard disk drive and runs it.
 3. The EUT sends "H" messages to the monitor, and the monitor displays "H" patterns on the screen.
 4. The PC sends "H" messages to the modem.
 5. The PC sends "H" messages to the internal Hard Disk, and the Hard Disk reads and writes the message.
 6. Repeat the steps from 2 to 5.
- d. An executive program, Bluesuite.exe under WIN XP, which generates a continuous signal by the following frequency to test.
 - GFSK: CH 00: 2402MHz, CH 39: 2441MHz, CH 78: 2480MHz.
 - $\pi/4$ -DQPSK: CH 00: 2402MHz, CH 39: 2441MHz, CH 78: 2480MHz.
 - 8DPSK: CH 00: 2402MHz, CH 39: 2441MHz, CH 78: 2480MHz.

Note: All the transmitter rates had been pre-tested, and the test data is worst case.

2.4 Description of Test System

Device	Manufacturer	Model No.	Description
Monitor	SlimAGE	IGV	Power Cable, Adapter Unshielding 1.8 m Data Cable, VGA Shielding 1.35 m
Modem	ACEXX	DM-1414	Power Cable, Adapter Unshielding 1.8 m Data Cable, RS232 Shielding 1.35 m
Flash memory*2	TranSend	JF150 512MB	N/A
Earphone	MIC	MIC-4	Data Cable, Audio Shielding 1.6 m
Notebook (Remote workstation)	TOSHIBA	PSA50T-05M00C	Power Cable, Adapter Unshielding 1.8 m
AP Router (Remote Workstation)	Netgear	WAG102	Power Cable, Adapter Unshielding 1.8 m

Use Cable:

Cable	Quantity	Description
RJ45	1	Unshielding, 5.0m

2.5 Connection Diagram of Test System

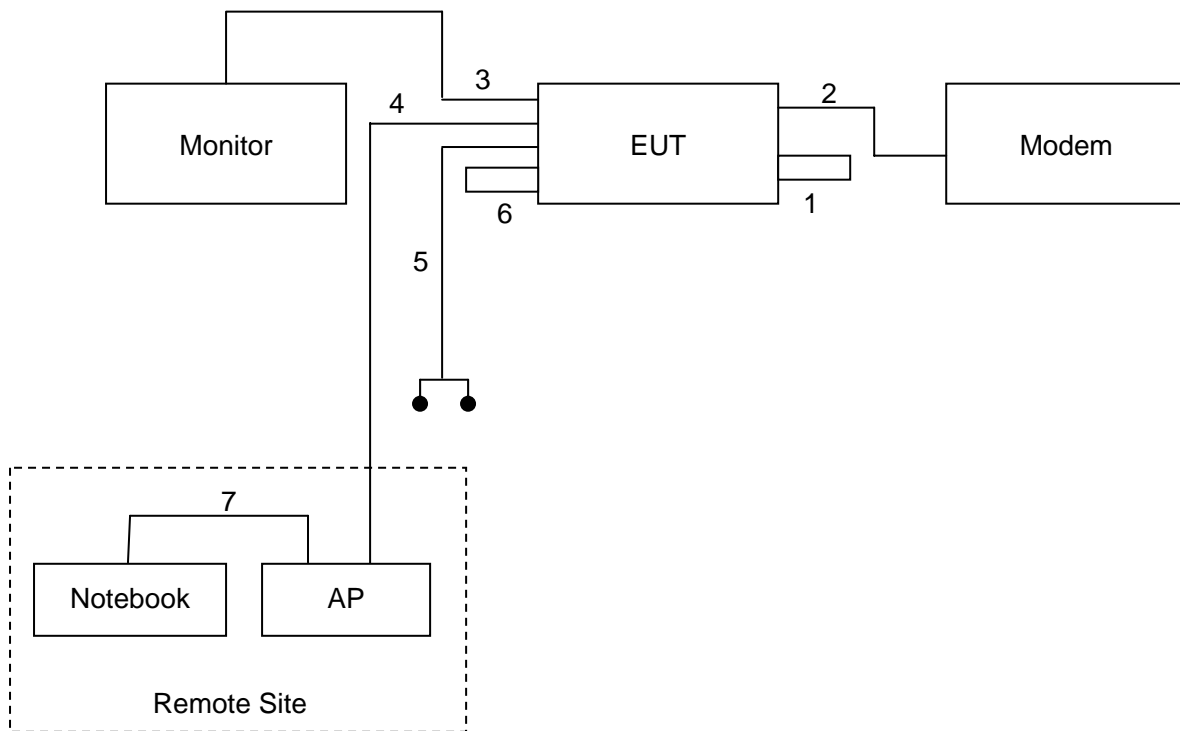

1. The Flash Memory is connected to EUT by USB Port.
2. The RS232 cable is connected from EUT to the Modem.
3. The VGA cable is connected from EUT to the Monitor.
4. The RJ45 cable is connected from EUT to the AP.
5. The Audio cable is connected from EUT to the Earphone.
6. The Flash Memory is connected to EUT by USB Port.
7. The RJ45 cable is connected from Notebook to the AP.

2.6 General Information of Test

Test Site :	Exclusive Certification Corp. 4F-2, No. 28, Lane 78, Xing-Ai Rd. Nei-hu, Taipei City 114 Taiwan R.O.C.
Test Site Location (OATS1-SD):	No.68-1, Shihbachongsi, shihding Township, Taipei City 223, Taiwan, R.O.C. Registration Number: 632249.
FCC Registration Number :	632249
IC Registration Number :	6597A-1
VCCI Registration Number :	T-338 for Telecommunication Test C-2188 for Conducted emission test R-1902 for Radiated emission test
Test Voltage:	AC 120V/ 60Hz
Test in Compliance with:	ANSI C63.4-2003 FCC Part 15 Subpart C
Frequency Range Investigated:	Conducted: from 150kHz to 30 MHz Radiation: from 30 MHz to 24620MHz
Test Distance:	The test distance of radiated emission from antenna to EUT is 3 M.

2.7 Measurement Uncertainty

Measurement Item	Measurement Frequency	Polarization	Uncertainty
Conducted Emission	9 kHz ~ 30 MHz	LINE/NEUTRAL	2.71 dB
Radiated Emission	30 MHz ~ 1GHz	Vertical	4.11 dB
		Horizontal	4.10 dB
6 dB Bandwidth	---	---	7500 Hz
Maximum Peak Output Power	---	---	1.4 dB
100kHz Bandwidth of Frequency Band Edges	---	---	2.2 dB
Power Spectral Density	---	---	2.2 dB

3. Antenna Requirements

3.1 Standard Applicable

For intentional device, according to FCC 47 CFR Section 15.203, an intentional radiator shall be designed to ensure that no antenna other than that furnished by the responsible party shall be used with the device.

And according to FCC 47 CFR Section 15.247 (b), if transmitting antennas of directional gain greater than 6dBi are used, the power shall be reduced by the amount in dB that the directional gain of the antenna exceeds 6dBi.

3.2 Antenna Construction and Directional Gain

Antenna 1 (WLAN Antenna):

Antenna Model: AT103-105

Antenna type: GPRS + WL Antenna

Antenna Gain: 1.54 dBi for 2.4GHz Band / 1.74 dBi for 5GHz Band.

Antenna 2 (BT Antenna):

Antenna Model: GB04001-A01

Antenna type: PCB Antenna

Antenna Gain: 2.2 dBi

4. Test of Conducted Emission

4.1 Test Limit

Conducted Emissions were measured from 150 kHz to 30 MHz with a bandwidth of 9 KHz on the 120 VAC power and return leads of the EUT according to the methods defined in ANSI C63.4-2003 Section 3.1. The EUT was placed on a nonmetallic stand in a shielded room 0.8 meters above the ground plane as shown in section 2.2. The interface cables and equipment positioning were varied within limits of reasonable applications to determine the position produced maximum conducted emissions.

Frequency (MHz)	Quasi Peak (dB μ V)	Average (dB μ V)
0.15 – 0.5	66-56*	56-46*
0.5 – 5.0	56	46
5.0 – 30.0	60	50

*Decreases with the logarithm of the frequency.

4.2 Test Procedures

- a. The EUT was placed 0.4 meter from the conducting wall of the shielding room was kept at least 80 centimeters from any other grounded conducting surface.
- b. Connect EUT to the power mains through a line impedance stabilization network (LISN).
- c. All the support units are connecting to the other LISN.
- d. The LISN provides 50 ohm coupling impedance for the measuring instrument.
- e. The FCC states that a 50 ohm, 50 micro-Henry LISN should be used.
- f. Both sides of AC line were checked for maximum conducted interference.
- g. The frequency range from 150 kHz to 30 MHz was searched.
- h. Set the test-receiver system to Peak Detect Function and Specified Bandwidth with Maximum Hold Mode.

4.3 Typical Test Setup

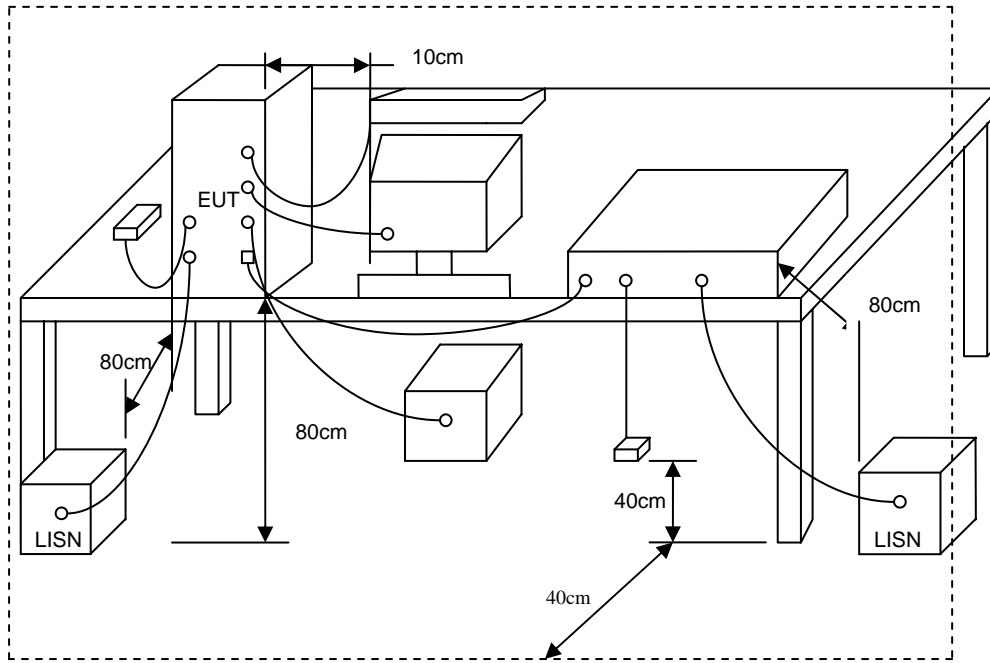

4.4 Measurement equipment

Instrument/Ancillary	Model No.	Manufacturer	Serial No.	Calibration Date	Valid Date.
Receiver	R&S	ESCI	100443	2007/09/27	2008/09/26
LISN	MESS TEC	NNB-2/16Z	02/10191	2008/05/15	2009/05/14
LISN	Rolf Heine	NNB-2/16Z	03/10058	2008/04/22	2009/04/21

4.5 Test Result and Data

Power	: AC 120V	Pol/Phase	: LINE
Test Mode	: GFSK CH0	Temperature	: 24 °C
Memo	: LE-9702B-01	Humidity	: 58 %

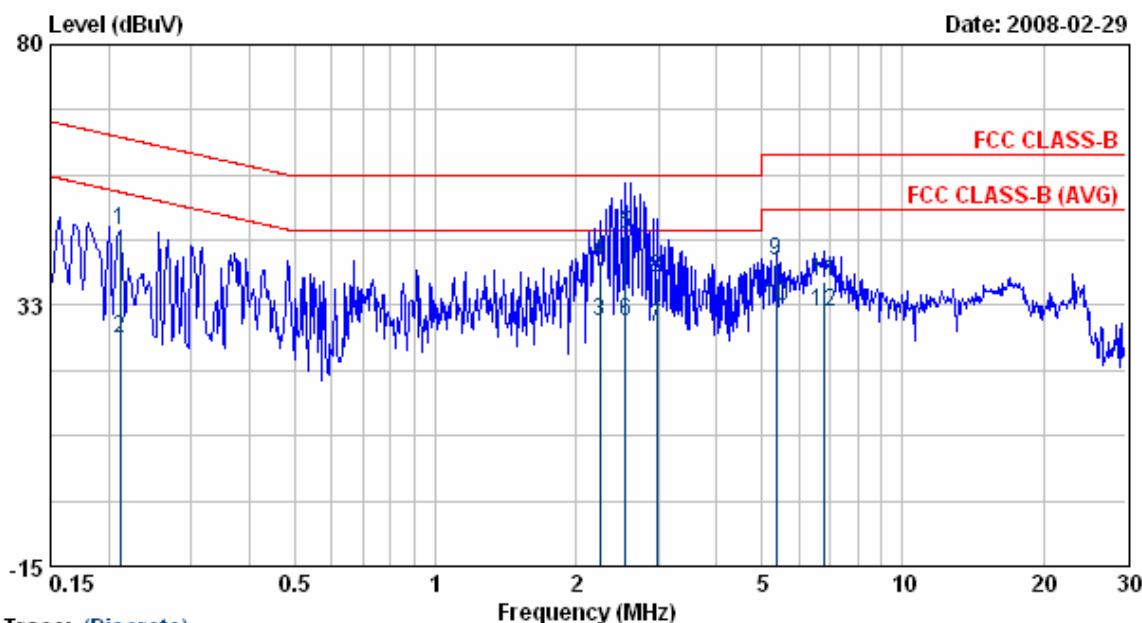

Trace: (Discrete)

Item	Freq	Read Value	Factor	Result	Limit	Margin	Remark
	MHz	dBuV	dB	dBuV	dBuV	dBuV	
1	0.21	46.21	0.11	46.32	63.14	-16.82	QP
2	0.21	26.36	0.11	26.47	53.14	-26.67	AVERAGE
3	2.25	29.38	0.21	29.59	46.00	-16.41	AVERAGE
4	2.25	40.31	0.21	40.51	56.00	-15.49	QP
5	2.55	45.36	0.21	45.57	56.00	-10.43	QP
6	2.55	29.25	0.21	29.46	46.00	-16.54	AVERAGE
7	2.98	28.34	0.22	28.56	46.00	-17.44	AVERAGE
8	2.98	37.35	0.22	37.57	56.00	-18.43	QP
9	5.36	40.38	0.27	40.64	60.00	-19.36	QP
10	5.36	31.97	0.27	32.24	50.00	-17.76	AVERAGE
11	6.77	36.42	0.29	36.71	60.00	-23.29	QP
12	6.77	30.96	0.29	31.25	50.00	-18.75	AVERAGE

- Remarks:
1. Level = Read Level + Factor
 2. Factor = LISN(ISN) Factor + Cable Loss
 3. According to technical experiences, all spurious emission of FM mode at channel 0,39,78 are almost the same below 1GHz, so that the channel 0 was chosen as representative in final test.
 4. The data is worst case.

Power	: AC 120V	Pol/Phase	: NEUTRAL
Test Mode	: GFSK CH0	Temperature	: 24 °C
Memo	: LE-9702B-01	Humidity	: 58 %

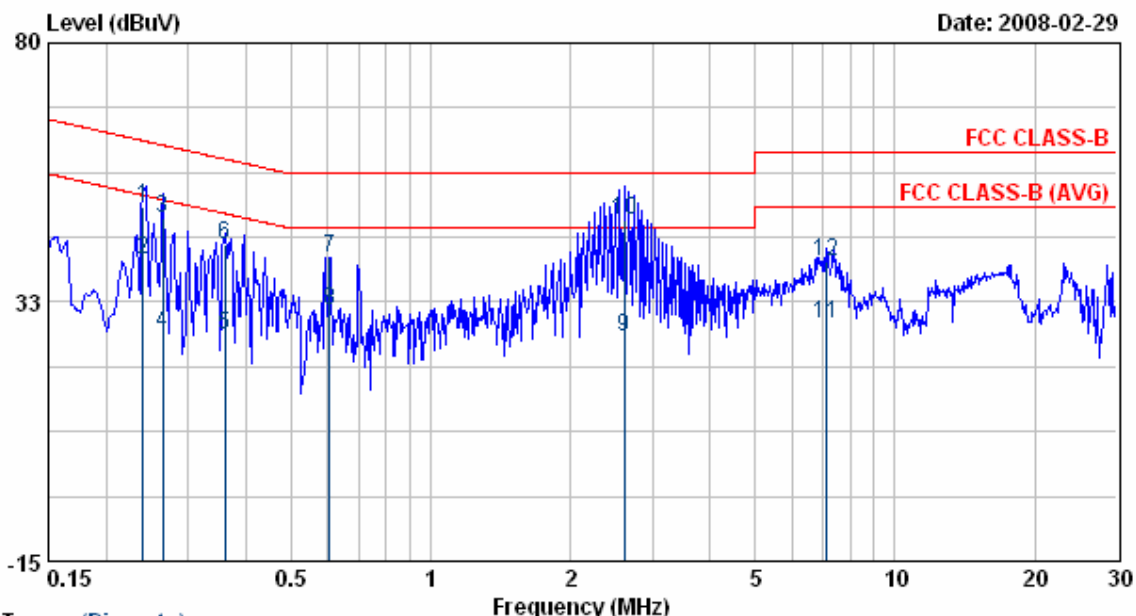

Trace: (Discrete)

Item	Freq	Read Value	Factor	Result	Limit	Margin	Remark
	MHz	dBuV	dB	dBuV	dBuV	dBuV	
1	0.24	49.83	0.09	49.92	62.08	-12.16	QP
2	0.24	40.31	0.09	40.41	52.08	-11.68	AVERAGE
3	0.26	47.72	0.09	47.82	61.29	-13.47	QP
4	0.26	26.63	0.09	26.72	51.29	-24.57	AVERAGE
5	0.36	26.33	0.10	26.43	48.74	-22.31	AVERAGE
6	0.36	42.92	0.10	43.02	58.74	-15.72	QP
7	0.60	40.33	0.12	40.45	56.00	-15.55	QP
8	0.60	30.75	0.12	30.87	46.00	-15.13	AVERAGE
9	2.61	25.85	0.21	26.06	46.00	-19.94	AVERAGE
10	2.61	47.28	0.21	47.49	56.00	-8.51	QP
11	7.14	28.34	0.33	28.67	50.00	-21.33	AVERAGE
12	7.14	39.45	0.33	39.78	60.00	-20.22	QP

- Remarks:
1. Level = Read Level + Factor
 2. Factor = LISN(ISN) Factor + Cable Loss
 3. According to technical experiences, all spurious emission of FM mode at channel 0,39,78 are almost the same below 1GHz, so that the channel 0 was chosen as representative in final test.
 4. The data is worst case.

Power	: AC 120V	Pol/Phase	: LINE
Test Mode	: $\pi/4$ -DQPSK CH0	Temperature	: 25 °C
Memo	: LE-9702B-01	Humidity	: 58 %

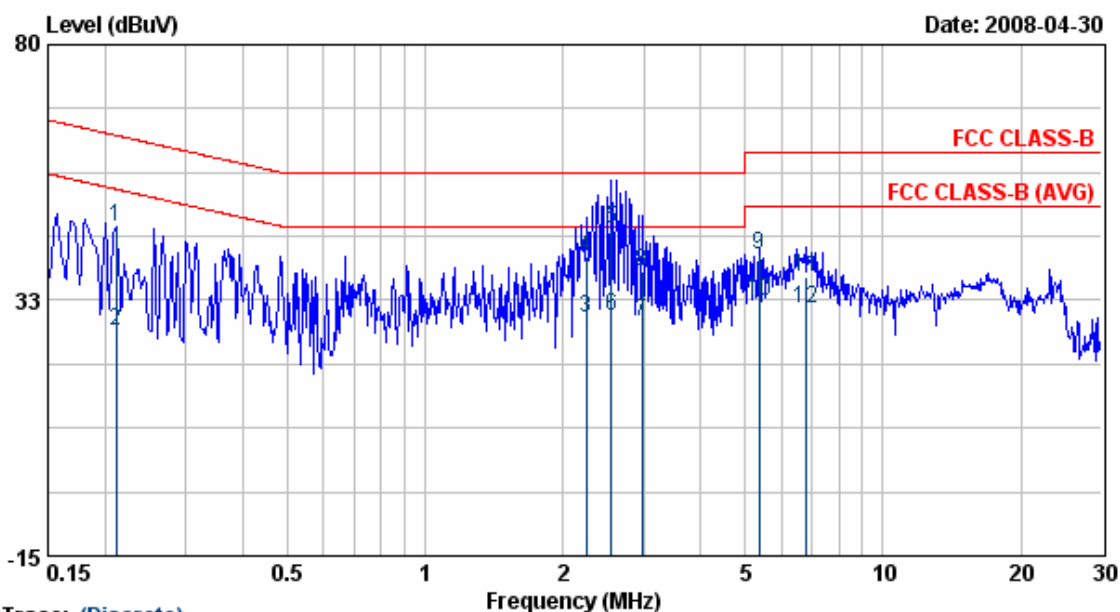

Trace: (Discrete)

Item	Freq	Read Value	Factor	Result	Limit	Margin	Remark
	MHz	dBuV	dB	dBuV	dBuV	dBuV	
1	0.21	46.20	0.11	46.31	63.14	-16.83	QP
2	0.21	26.53	0.11	26.64	53.14	-26.50	AVERAGE
3	2.25	29.18	0.21	29.39	46.00	-16.61	AVERAGE
4	2.25	40.36	0.21	40.57	56.00	-15.43	QP
5	2.55	45.62	0.21	45.83	56.00	-10.17	QP
6	2.55	29.29	0.21	29.50	46.00	-16.50	AVERAGE
7	2.98	28.42	0.22	28.64	46.00	-17.36	AVERAGE
8	2.98	37.48	0.22	37.70	56.00	-18.30	QP
9	5.36	40.78	0.27	41.04	60.00	-18.96	QP
10	5.36	31.92	0.27	32.19	50.00	-17.81	AVERAGE
11	6.77	36.49	0.29	36.78	60.00	-23.22	QP
12	6.77	30.59	0.29	30.88	50.00	-19.12	AVERAGE

- Remarks:
1. Level = Read Level + Factor
 2. Factor = LISN(ISN) Factor + Cable Loss
 3. According to technical experiences, all spurious emission of FM mode at channel 0,39,78 are almost the same below 1GHz, so that the channel 0 was chosen as representative in final test.
 4. The data is worst case.

Power	: AC 120V	Pol/Phase	: NEUTRAL
Test Mode	: $\pi/4$ -DQPSK CH0	Temperature	: 25 °C
Memo	: LE-9702B-01	Humidity	: 58 %

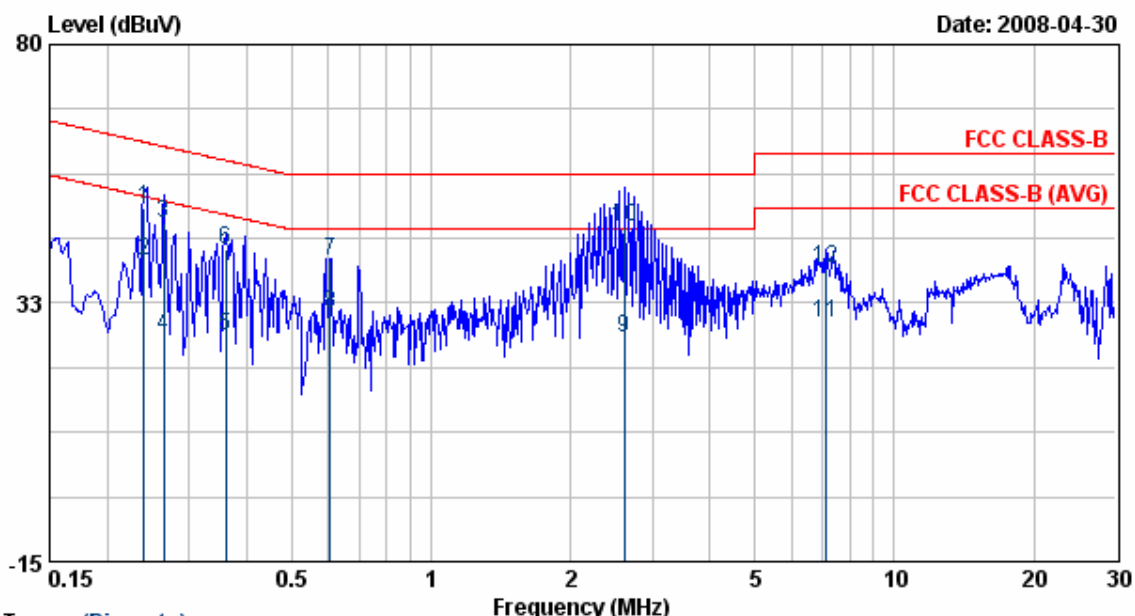

Trace: (Discrete)

Item	Freq	Read Value	Factor	Result	Limit	Margin	Remark
	MHz	dBuV	dB	dBuV	dBuV	dBuV	
1	0.24	49.89	0.09	49.98	62.08	-12.10	QP
2	0.24	40.14	0.09	40.23	52.08	-11.85	AVERAGE
3	0.26	47.25	0.09	47.34	61.29	-13.95	QP
4	0.26	26.34	0.09	26.43	51.29	-24.86	AVERAGE
5	0.36	26.35	0.10	26.44	48.74	-22.29	AVERAGE
6	0.36	42.25	0.10	42.35	58.74	-16.39	QP
7	0.60	40.31	0.12	40.43	56.00	-15.57	QP
8	0.60	30.49	0.12	30.61	46.00	-15.39	AVERAGE
9	2.61	25.87	0.21	26.08	46.00	-19.92	AVERAGE
10	2.61	46.28	0.21	46.49	56.00	-9.51	QP
11	7.14	28.43	0.33	28.76	50.00	-21.24	AVERAGE
12	7.14	38.45	0.33	38.78	60.00	-21.22	QP

- Remarks:
1. Level = Read Level + Factor
 2. Factor = LISN(ISN) Factor + Cable Loss
 3. According to technical experiences, all spurious emission of FM mode at channel 0,39,78 are almost the same below 1GHz, so that the channel 0 was chosen as representative in final test.
 4. The data is worst case.

Power	: AC 120V	Pol/Phase	: LINE
Test Mode	: 8DPSK CH0	Temperature	: 25 °C
Memo	: LE-9702B-01	Humidity	: 58 %

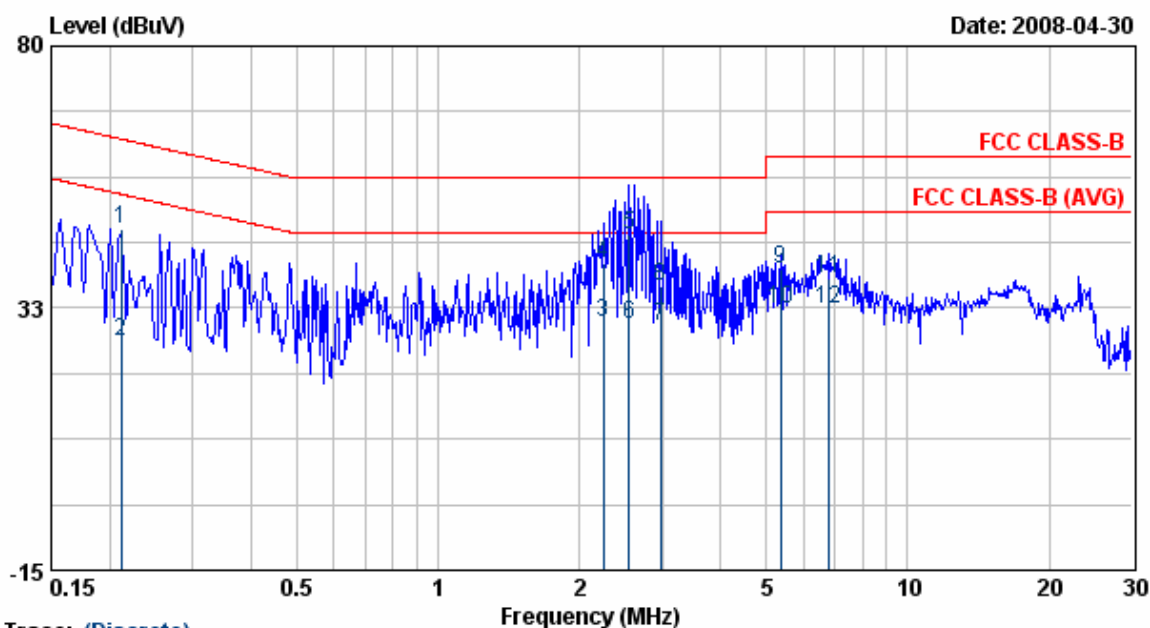

Trace: (Discrete)

Item	Freq	Read Value	Factor	Result	Limit	Margin	Remark
	MHz	dBuV	dB	dBuV	dBuV	dBuV	
1	0.21	46.61	0.11	46.72	63.14	-16.42	QP
2	0.21	26.39	0.11	26.50	53.14	-26.64	AVERAGE
3	2.25	29.81	0.21	30.02	46.00	-15.98	AVERAGE
4	2.25	40.36	0.21	40.57	56.00	-15.43	QP
5	2.55	45.52	0.21	45.73	56.00	-10.27	QP
6	2.55	29.35	0.21	29.56	46.00	-16.44	AVERAGE
7	2.98	28.84	0.22	29.06	46.00	-16.94	AVERAGE
8	2.98	36.35	0.22	36.57	56.00	-19.43	QP
9	5.36	39.38	0.27	39.64	60.00	-20.36	QP
10	5.36	31.92	0.27	32.19	50.00	-17.81	AVERAGE
11	6.77	37.42	0.29	37.71	60.00	-22.29	QP
12	6.77	31.96	0.29	32.25	50.00	-17.75	AVERAGE

- Remarks:
1. Level = Read Level + Factor
 2. Factor = LISN(ISN) Factor + Cable Loss
 3. According to technical experiences, all spurious emission of FM mode at channel 0,39,78 are almost the same below 1GHz, so that the channel 0 was chosen as representative in final test.
 4. The data is worst case.

Power	: AC 120V	Pol/Phase	: NEUTRAL
Test Mode	: 8DPSK CH0	Temperature	: 25 °C
Memo	: LE-9702B-01	Humidity	: 58 %

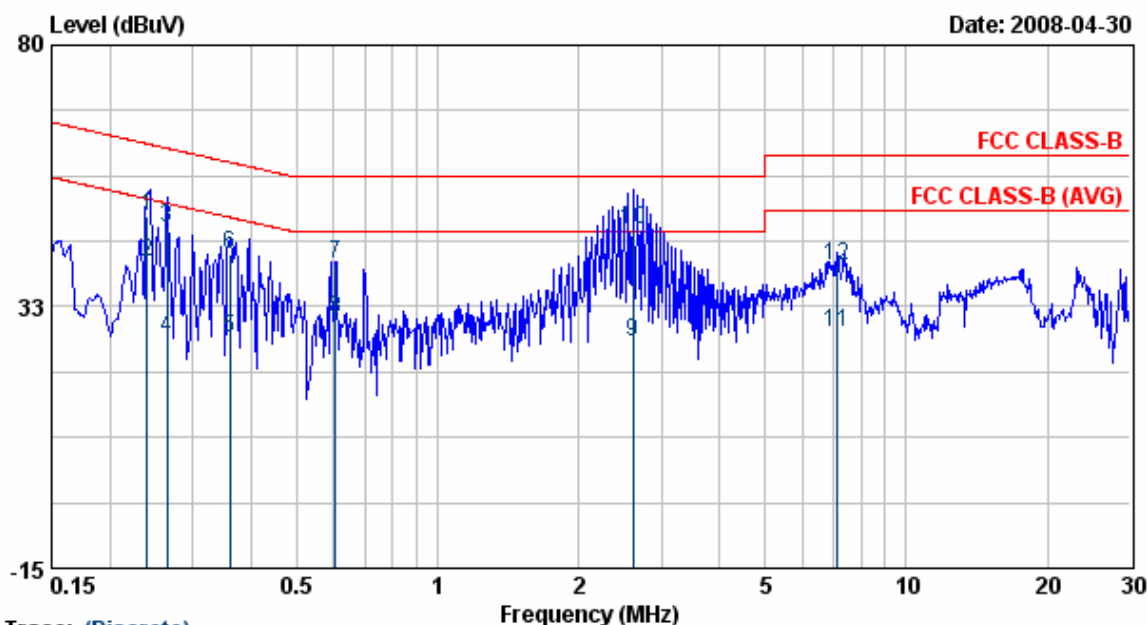

Trace: (Discrete)

Item	Freq	Read Value	Factor	Result	Limit	Margin	Remark
	MHz	dBuV	dB	dBuV	dBuV	dBuV	
1	0.24	48.83	0.09	48.92	62.08	-13.16	QP
2	0.24	40.64	0.09	40.73	52.08	-11.35	AVERAGE
3	0.26	46.72	0.09	46.82	61.29	-14.47	QP
4	0.26	26.69	0.09	26.78	51.29	-24.51	AVERAGE
5	0.36	26.53	0.10	26.63	48.74	-22.11	AVERAGE
6	0.36	41.92	0.10	42.02	58.74	-16.72	QP
7	0.60	40.10	0.12	40.21	56.00	-15.79	QP
8	0.60	30.25	0.12	30.37	46.00	-15.63	AVERAGE
9	2.61	25.98	0.21	26.20	46.00	-19.80	AVERAGE
10	2.61	46.28	0.21	46.49	56.00	-9.51	QP
11	7.14	27.34	0.33	27.67	50.00	-22.33	AVERAGE
12	7.14	39.50	0.33	39.83	60.00	-20.17	QP

- Remarks:
1. Level = Read Level + Factor
 2. Factor = LISN(ISN) Factor + Cable Loss
 3. According to technical experiences, all spurious emission of FM mode at channel 0,39,78 are almost the same below 1GHz, so that the channel 0 was chosen as representative in final test.
 4. The data is worst case.

Test engineer: Ben

5. Test of Radiated Emission

5.1 Test Limit

Radiated emissions from 30 MHz to 25 GHz were measured according to the methods defines in ANSI C63.4-2003. The EUT was placed, 0.8 meter above the ground plane, as shown in section 5.6.3. The interface cables and equipment positions were varied within limits of reasonable applications to determine the positions producing maximum radiated emissions For unintentional device, according to § 15.109(a), except for Class A digital devices, the field strength of radiated emissions from unintentional radiators at a distance of 3 meters shall not exceed the following values:

Frequency (MHz)	Distance Meters	Radiated (μ V / M)	Radiated (dB μ V / M)
30-88	3	100	40.0
88-216	3	150	43.5
216-960	3	200	46.0
Above 960	3	500	54.0

For unintentional device, according to CISPR PUB.22, for Class B digital devices, the general requirement of field strength of radiated emissions from intentional radiators at a distance of 10 meters shall not exceed the above table.

Frequency (MHz)	Distance Meters	Radiated (dB μ V / M)
30-230	10	30
230-1000	10	37

5.2 Test Procedures

- a. The EUT was placed on a rotatable table top 0.8 meter above ground.
- b. The EUT was set 3 meters from the interference receiving antenna which was mounted on the top of a variable height antenna tower.
- c. The table was rotated 360 degrees to determine the position of the highest radiation.
- d. The antenna is a broadband antenna and its height is varied between one meter and four meters above ground to find the maximum value of the field strength both horizontal polarization and vertical polarization of the antenna are set to make the measurement.
- e. For each suspected emission the EUT was arranged to its worst case and then tune the antenna tower (from 1 M to 4 M) and turn table (from 0 degree to 360 degrees) to find the maximum reading.
- f. Set the test-receiver system to Peak or CISPR quasi-peak Detect Function and specified bandwidth with Maximum Hold Mode.
- g. If the emission level of the EUT in peak mode was 3 dB lower than the limit specified, then testing will be stopped and peak values of EUT will be reported, otherwise, the emissions which do not have 3 dB margin will be repeated one by one using the quasi-peak method and reported.
- h. For testing above 1GHz, the emission level of the EUT in peak mode was 20dB lower than average limit (that means the emission level in peak mode also complies with the limit in average mode), then testing will be stopped and peak values of EUT will be reported, otherwise, the emissions will be measured in average mode again and reported.

5.3 Typical Test Setup

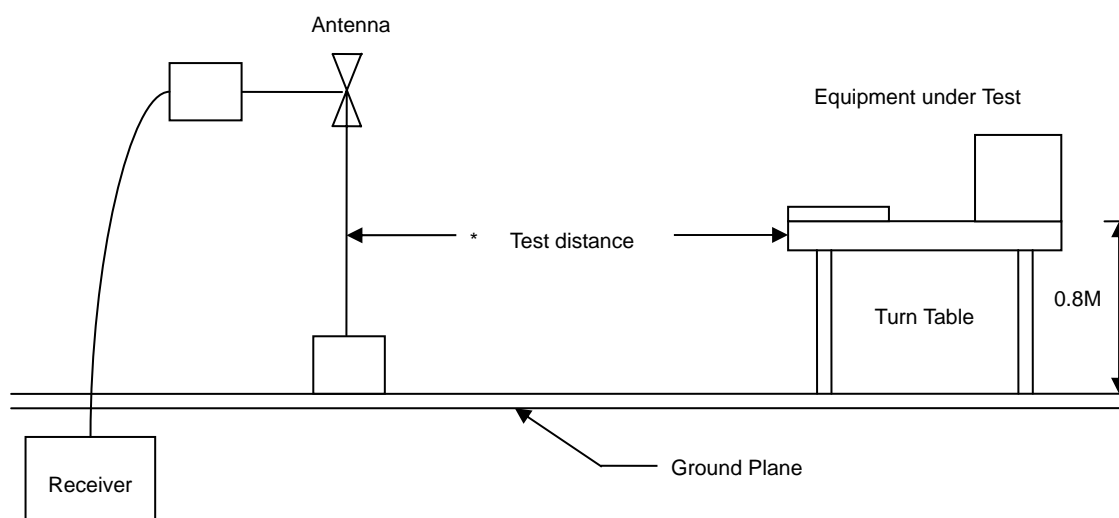

5.4 Measurement equipment

Instrument/Ancillary	Model No.	Manufacturer	Serial No.	Calibration Date	Valid Date
EMI Receiver	85460A	HP	3807A00454	2007/06/05	2008/06/04
Spectrum Analyzer	FSP40	R&S	10047	2008/02/22	2009/02/21
Horn Antenna	3115	EMCO	31589	2008/03/28	2009/03/27
Horn Antenna	3116	EMCO	31970	2008/04/08	2009/04/07
Bilog Antenna	CBL6112B	Schaffner	2840	2008/04/26	2009/04/25
Amplifier	8449B	Agilent	3008A01954	2008/01/24	2009/01/23
Amplifier	8447D	Agilent	2944A10531	2007/09/26	2008/09/25
Amplifier	PA-840	Com-Power	711885	2007/08/28	2008/08/27

5.5 Test Result and Data

Power	: AC 120V	Pol/Phase	: VERTICAL
Test Mode	: Transmit / Receive	Temperature	: 15 °C
Operation Channel	: 0	Humidity	: 70 %
Modulation Type	: GFSK	Atmospheric Pressure	: 1030 hPa
Memo	:	Rate	: 1 Mbps

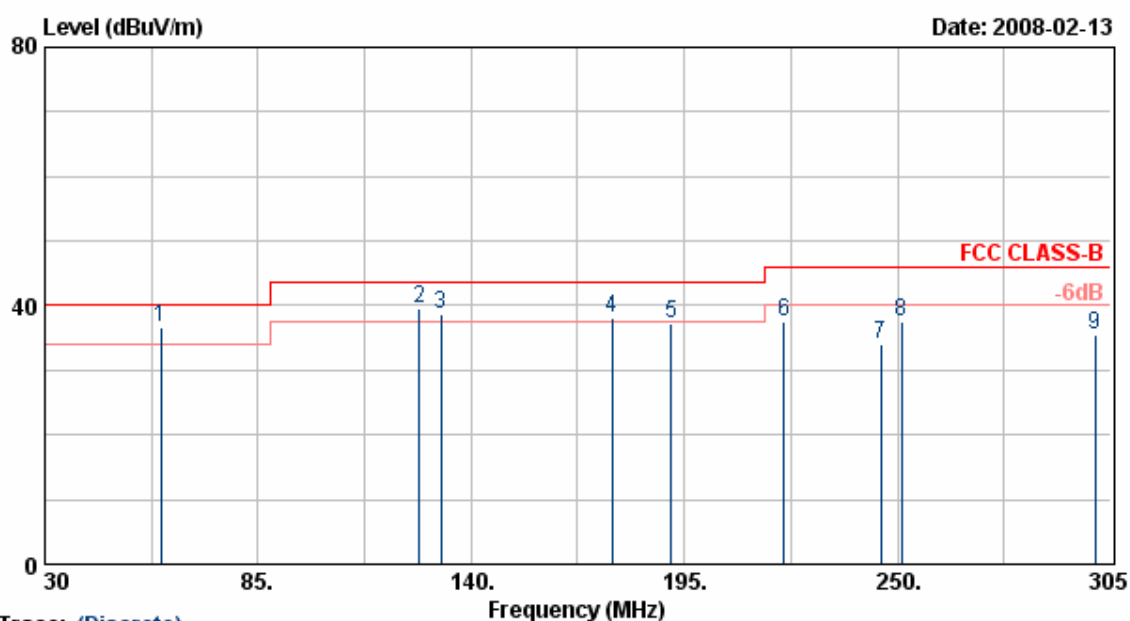

Trace: (Discrete)

Item	Freq MHz	Read Value dBuV/m	Factor dB	Result dBuV/m	Limit dBuV/m	Margin dB	Remark	Ant Pos cm	Tab Pos Deg
1	59.98	54.43	-17.69	36.74	40.00	-3.26	QP	100	179
2	126.53	51.42	-11.85	39.57	43.50	-3.93	QP	100	161
3	132.30	51.61	-13.00	38.61	43.50	-4.89	QP	100	199
4	176.30	52.24	-14.23	38.01	43.50	-5.49	QP	100	222
5	191.70	49.82	-12.58	37.24	43.50	-6.26	Peak	100	222
6	220.85	51.45	-13.86	37.58	46.00	-8.42	Peak	100	222
7	245.60	45.62	-11.58	34.04	46.00	-11.96	Peak	100	50
8	251.10	48.41	-10.88	37.53	46.00	-8.47	Peak	100	93
9	300.88	47.93	-12.51	35.42	46.00	-10.58	Peak	100	93

Remarks: 1. Result = Read Value + Factor
 2. Factor = Antenna Factor + Cable Loss - Amplifier
 3. According to technical experiences, all spurious emission of FM mode at channel 0,39,78 are almost the same below 1GHz, so that the channel 0 was chosen as representative in final test.
 4. The data is worst case.

Power	: AC 120V	Pol/Phase	: VERTICAL
Test Mode	: Transmit / Receive	Temperature	: 15 °C
Operation Channel	: 0	Humidity	: 70 %
Modulation Type	: GFSK	Atmospheric Pressure	: 1030 hPa
Memo	:	Rate	: 1 Mbps

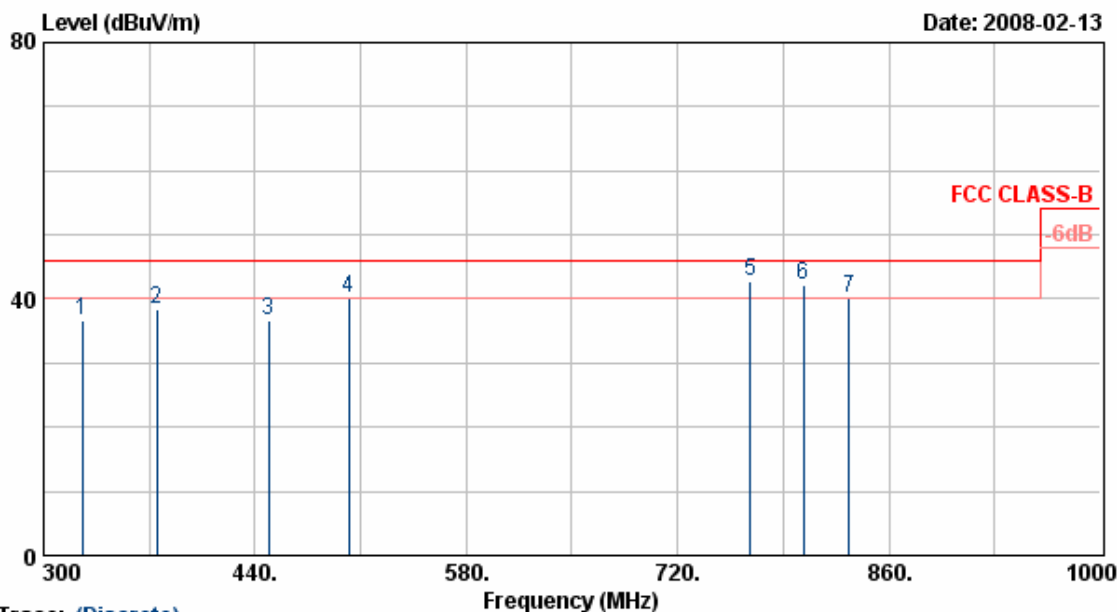

Trace: (Discrete)

Item	Freq	Read Value	Factor	Result	Limit	Margin	Remark	Ant Pos	Tab Pos
	MHz	dBuV/m	dB	dBuV/m	dBuV/m	dB		cm	Deg
1	325.90	48.43	-11.71	36.72	46.00	-9.28	Peak	100	74
2	374.90	47.87	-9.35	38.52	46.00	-7.48	Peak	100	99
3	449.10	46.55	-9.77	36.78	46.00	-9.22	Peak	100	156
4	502.30	44.60	-4.49	40.11	46.00	-5.89	QP	100	229
5	768.30	45.75	-3.08	42.67	46.00	-3.33	QP	100	360
6	803.30	43.40	-1.10	42.30	46.00	-3.70	QP	100	360
7	833.40	42.42	-2.31	40.11	46.00	-5.89	QP	100	360

- Remarks:
1. Result = Read Value + Factor
 2. Factor = Antenna Factor + Cable Loss - Amplifier
 3. According to technical experiences, all spurious emission of FM mode at channel 0,39,78 are almost the same below 1GHz, so that the channel 0 was chosen as representative in final test.
 4. The data is worst case.

Power	: AC 120V	Pol/Phase	: HORIZONTAL
Test Mode	: Transmit / Receive	Temperature	: 15 °C
Operation Channel	: 0	Humidity	: 70 %
Modulation Type	: GFSK	Atmospheric Pressure	: 1030 hPa
Memo	:	Rate	: 1 Mbps

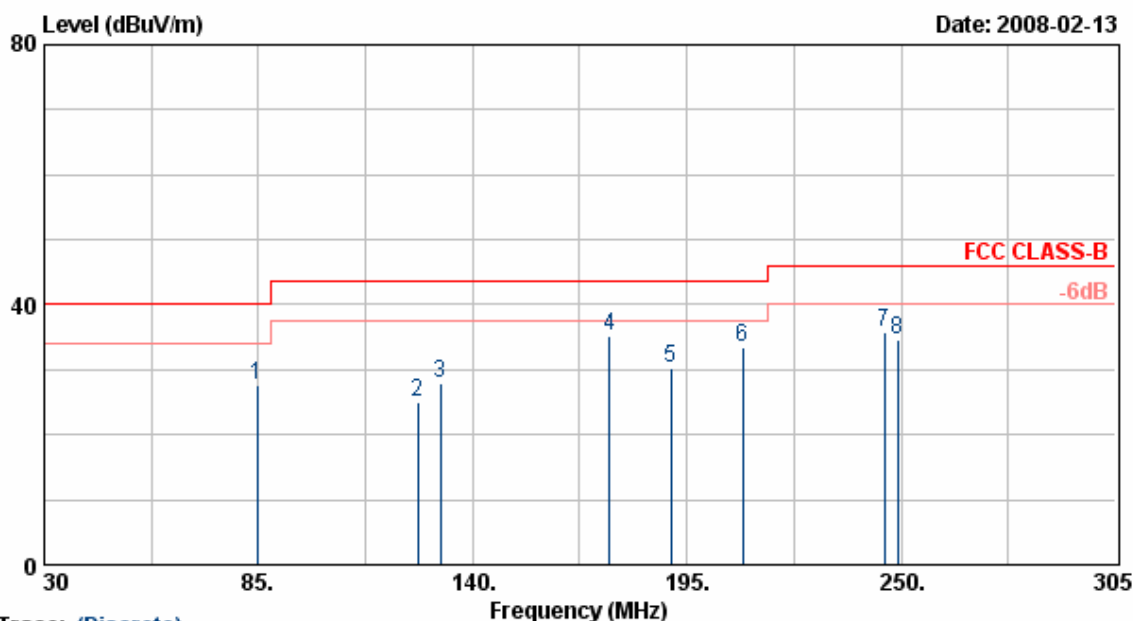

Trace: (Discrete)

Item	Freq	Read Value	Factor	Result	Limit	Margin	Remark	Ant Pos	Tab Pos
	MHz	dBuV/m	dB	dBuV/m	dBuV/m	dB		cm	Deg
1	84.73	51.55	-23.80	27.75	40.00	-12.25	Peak	200	95
2	125.98	45.21	-20.06	25.15	43.50	-18.35	Peak	200	95
3	131.75	47.66	-19.82	27.84	43.50	-15.66	Peak	200	211
4	175.20	56.10	-21.03	35.07	43.50	-8.43	Peak	200	196
5	190.88	51.23	-20.84	30.39	43.50	-13.11	Peak	200	196
6	209.30	52.43	-18.88	33.55	43.50	-9.95	Peak	200	196
7	245.60	52.52	-16.68	35.84	46.00	-10.16	Peak	200	277
8	249.18	50.60	-15.87	34.73	46.00	-11.27	Peak	200	360

Remarks: 1. Result = Read Value + Factor
 2. Factor = Antenna Factor + Cable Loss - Amplifier
 3. According to technical experiences, all spurious emission of FM mode at channel 0,39,78 are almost the same below 1GHz, so that the channel 0 was chosen as representative in final test.
 4. The data is worst case.

Power	: AC 120V	Pol/Phase	: HORIZONTAL
Test Mode	: Transmit / Receive	Temperature	: 15 °C
Operation Channel	: 0	Humidity	: 70 %
Modulation Type	: GFSK	Atmospheric Pressure	: 1030 hPa
Memo	:	Rate	: 1 Mbps

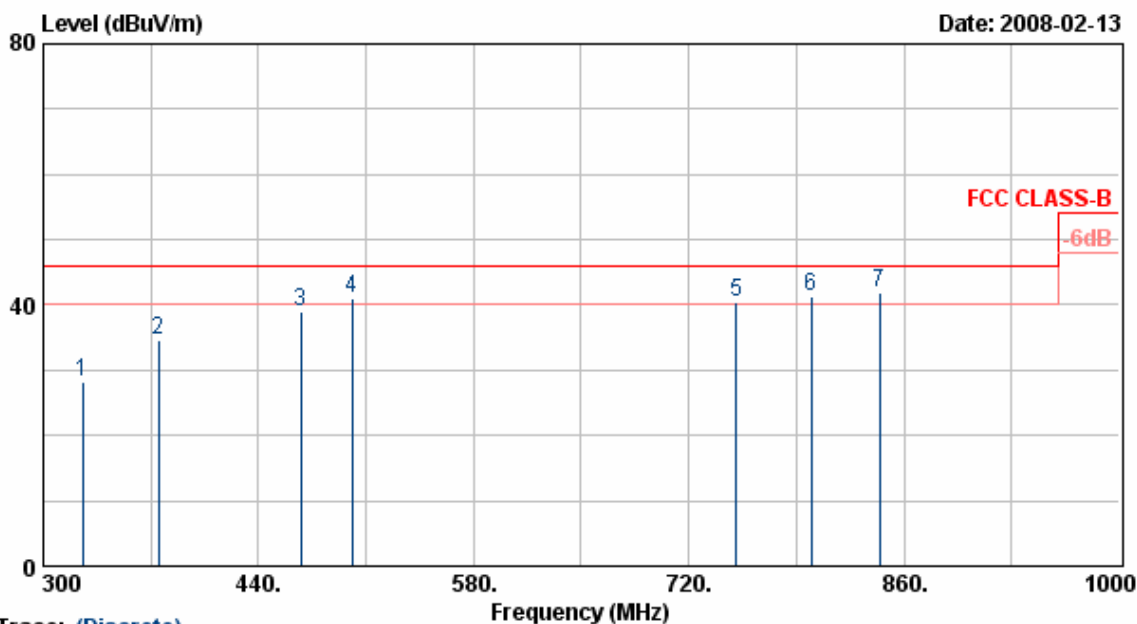

Trace: (Discrete)

Item	Freq	Read Value	Factor	Result	Limit	Margin	Remark	Ant Pos	Tab Pos
	MHz	dBuV/m	dB	dBuV/m	dBuV/m	dB		cm	Deg
1	325.90	41.80	-13.72	28.08	46.00	-17.92	Peak	200	49
2	374.90	45.22	-10.67	34.55	46.00	-11.45	Peak	200	144
3	467.30	46.69	-7.61	39.08	46.00	-6.92	Peak	200	52
4	500.90	47.46	-6.57	40.89	46.00	-5.11	QP	200	111
5	750.80	45.70	-5.20	40.50	46.00	-5.50	QP	200	178
6	799.80	44.88	-3.63	41.25	46.00	-4.75	QP	200	178
7	843.90	45.73	-3.74	41.99	46.00	-4.01	QP	200	105

- Remarks:
1. Result = Read Value + Factor
 2. Factor = Antenna Factor + Cable Loss - Amplifier
 3. According to technical experiences, all spurious emission of FM mode at channel 0,39,78 are almost the same below 1GHz, so that the channel 0 was chosen as representative in final test.
 4. The data is worst case.

Power	: AC 120V	Pol/Phase	: VERTICAL
Test Mode	: Transmit / Receive	Temperature	: 15 °C
Operation Channel	: 0	Humidity	: 70 %
Modulation Type	: GFSK	Atmospheric Pressure	: 1030 hPa
Memo	:	Rate	: 1 Mbps

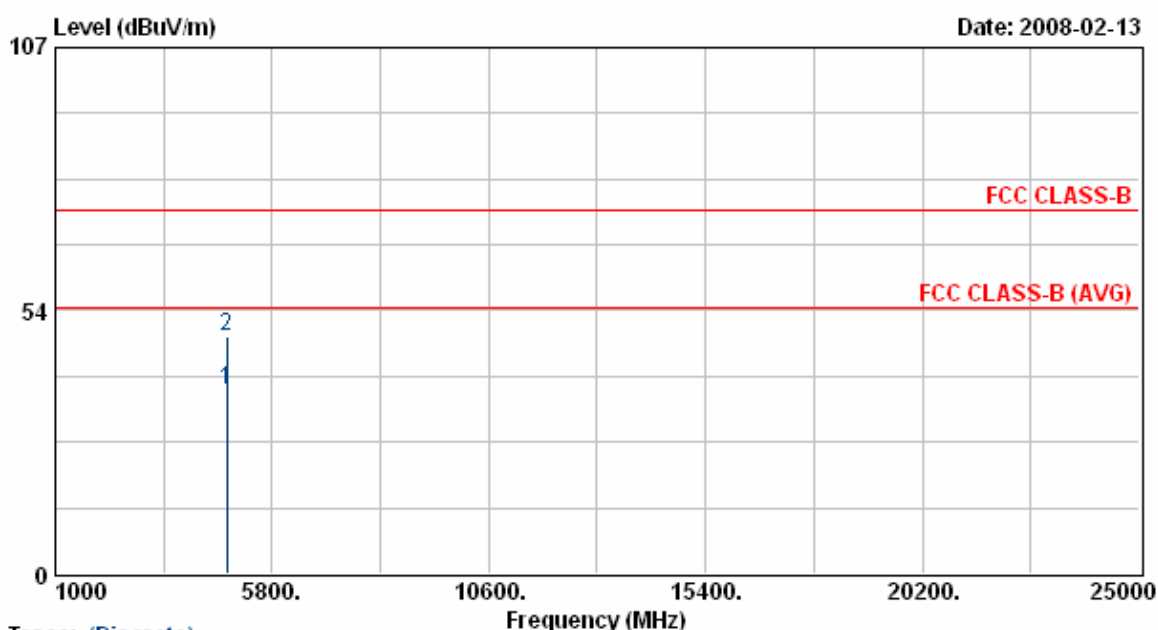

Trace: (Discrete)

Item	Freq	Read Value	Factor	Result	Limit	Margin	Remark	Ant Pos	Tab Pos
	MHz	dBuV/m	dB	dBuV/m	dBuV/m	dB		cm	Deg
1	4804.00	31.32	5.92	37.24	54.00	-16.76	Average	100	194
2	4804.00	42.50	5.92	48.42	74.00	-25.58	Peak	100	194

Notes:

1. Result = Read Value + Factor
2. Factor = Antenna Factor + Cable Loss - Amplifier
3. The resolution bandwidth of test receiver/spectrum analyzer is 120KHz and video bandwidth is 300kHz for Peak detection and Quasi-peak detection at frequency below 1GHz.
4. The resolution bandwidth of test receiver/spectrum analyzer is 1MHz and video bandwidth is 3MHz for Peak detection at frequency above 1GHz.
5. The resolution bandwidth of test receiver/spectrum analyzer is 1MHz and video bandwidth is 10Hz for Average detection at frequency above 1GHz.
6. The other emissions is too low to be measured.

Power	: AC 120V	Pol/Phase	: HORIZONTAL
Test Mode	: Transmit / Receive	Temperature	: 15 °C
Operation Channel	: 0	Humidity	: 70 %
Modulation Type	: GFSK	Atmospheric Pressure	: 1030 hPa
Memo	:	Rate	: 1 Mbps

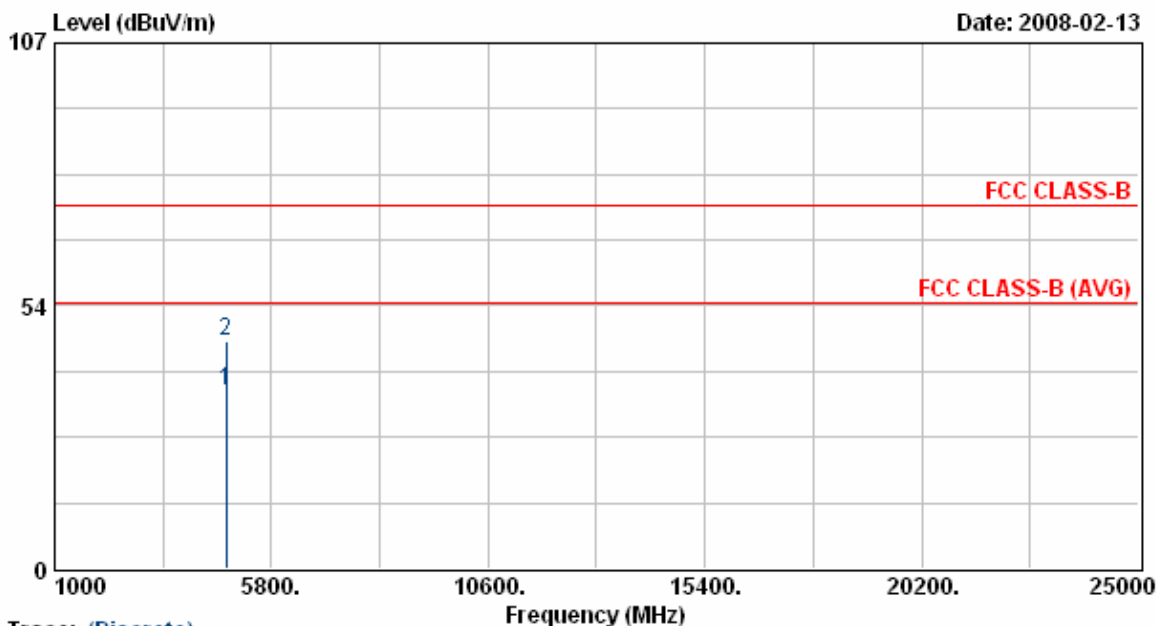

Trace: (Discrete)

Item	Freq	Read Value	Factor	Result	Limit	Margin	Remark	Ant Pos	Tab Pos
	MHz	dBuV/m	dB	dBuV/m	dBuV/m	dB		cm	Deg
1	4804.00	30.12	5.92	36.04	54.00	-17.96	Average	100	238
2	4804.00	40.42	5.92	46.34	74.00	-27.66	Peak	100	238

Notes:

1. Result = Read Value + Factor
2. Factor = Antenna Factor + Cable Loss - Amplifier
3. The resolution bandwidth of test receiver/spectrum analyzer is 120KHz and video bandwidth is 300kHz for Peak detection and Quasi-peak detection at frequency below 1GHz.
4. The resolution bandwidth of test receiver/spectrum analyzer is 1MHz and video bandwidth is 3MHz for Peak detection at frequency above 1GHz.
5. The resolution bandwidth of test receiver/spectrum analyzer is 1MHz and video bandwidth is 10Hz for Average detection at frequency above 1GHz.
6. The other emissions is too low to be measured.

Power	: AC 120V	Pol/Phase	: VERTICAL
Test Mode	: Transmit / Receive	Temperature	: 15 °C
Operation Channel	: 39	Humidity	: 70 %
Modulation Type	: GFSK	Atmospheric Pressure	: 1030 hPa
Memo	:	Rate	: 1 Mbps

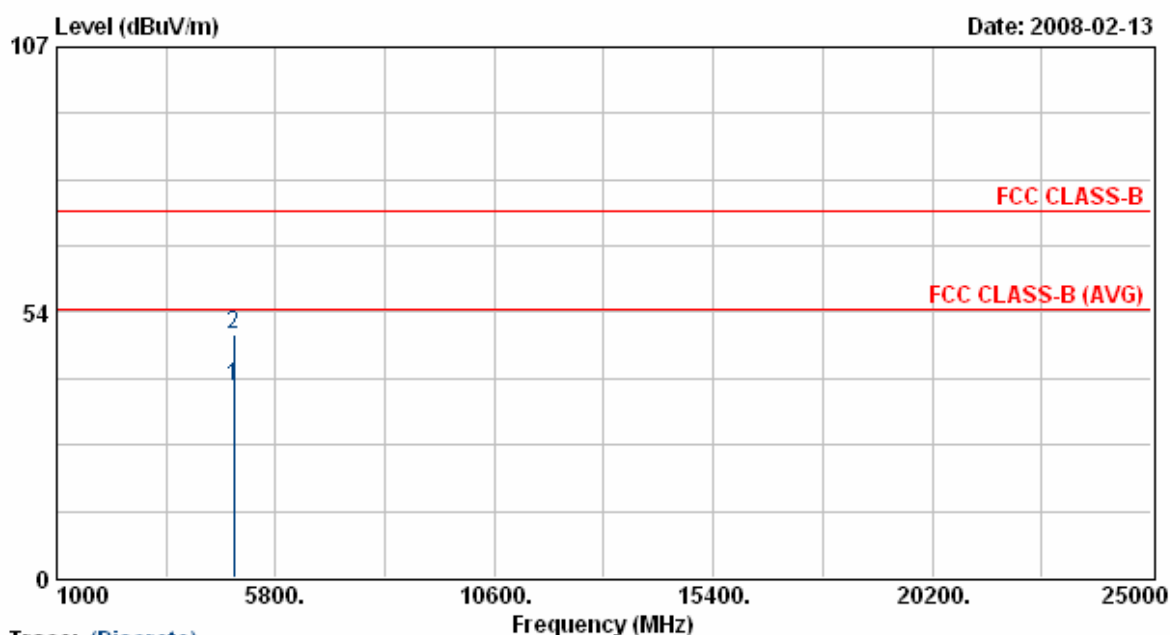

Trace: (Discrete)

Item	Freq	Read Value	Factor	Result	Limit	Margin	Remark	Ant Pos	Tab Pos
	MHz	dBuV/m	dB	dBuV/m	dBuV/m	dB		cm	Deg
1	4881.88	32.49	6.12	38.61	54.00	-15.39	Average	100	194
2	4881.88	42.88	6.12	49.00	74.00	-25.00	Peak	100	194

Notes:

1. Result = Read Value + Factor
2. Factor = Antenna Factor + Cable Loss - Amplifier
3. The resolution bandwidth of test receiver/spectrum analyzer is 120KHz and video bandwidth is 300kHz for Peak detection and Quasi-peak detection at frequency below 1GHz.
4. The resolution bandwidth of test receiver/spectrum analyzer is 1MHz and video bandwidth is 3MHz for Peak detection at frequency above 1GHz.
5. The resolution bandwidth of test receiver/spectrum analyzer is 1MHz and video bandwidth is 10Hz for Average detection at frequency above 1GHz.
6. The other emissions is too low to be measured.

Power	: AC 120V	Pol/Phase	: HORIZONTAL
Test Mode	: Transmit / Receive	Temperature	: 15 °C
Operation Channel	: 39	Humidity	: 70 %
Modulation Type	: GFSK	Atmospheric Pressure	: 1030 hPa
Memo	:	Rate	: 1 Mbps

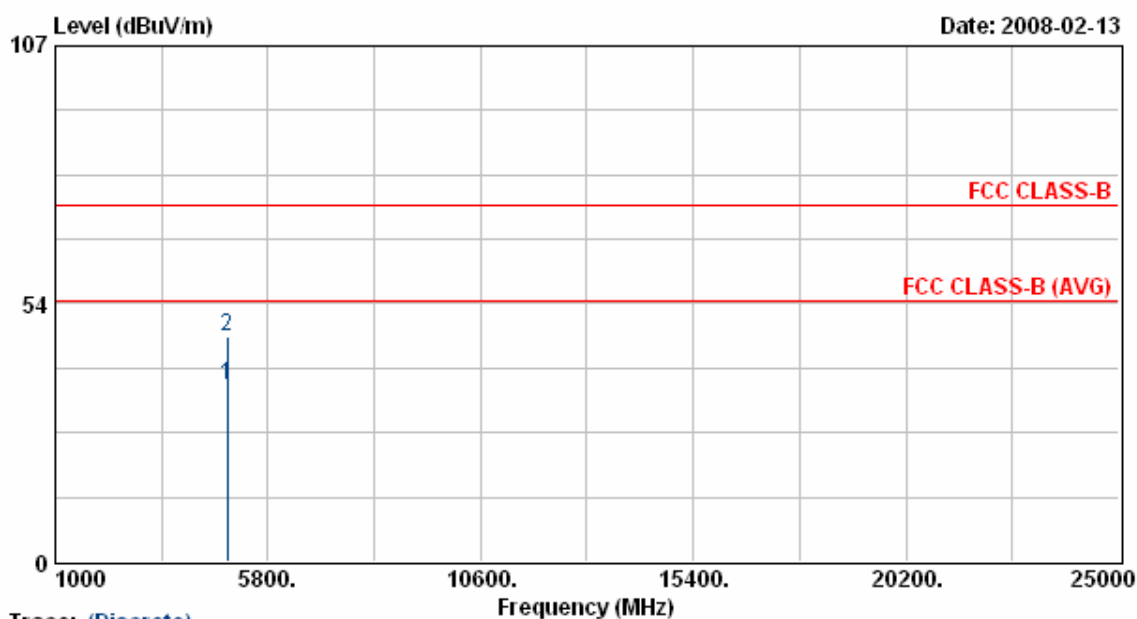

Trace: (Discrete)

Item	Freq	Read Value	Factor	Result	Limit	Margin	Remark	Ant Pos	Tab Pos
	MHz	dBuV/m	dB	dBuV/m	dBuV/m	dB		cm	Deg
1	4882.00	30.26	6.12	36.38	54.00	-17.62	Average	100	238
2	4882.00	40.58	6.12	46.70	74.00	-27.30	Peak	100	238

Notes:

1. Result = Read Value + Factor
2. Factor = Antenna Factor + Cable Loss - Amplifier
3. The resolution bandwidth of test receiver/spectrum analyzer is 120KHz and video bandwidth is 300kHz for Peak detection and Quasi-peak detection at frequency below 1GHz.
4. The resolution bandwidth of test receiver/spectrum analyzer is 1MHz and video bandwidth is 3MHz for Peak detection at frequency above 1GHz.
5. The resolution bandwidth of test receiver/spectrum analyzer is 1MHz and video bandwidth is 10Hz for Average detection at frequency above 1GHz.
6. The other emissions is too low to be measured.

Power	: AC 120V	Pol/Phase	: VERTICAL
Test Mode	: Transmit / Receive	Temperature	: 15 °C
Operation Channel	: 78	Humidity	: 70 %
Modulation Type	: GFSK	Atmospheric Pressure	: 1030 hPa
Memo	:	Rate	: 1 Mbps

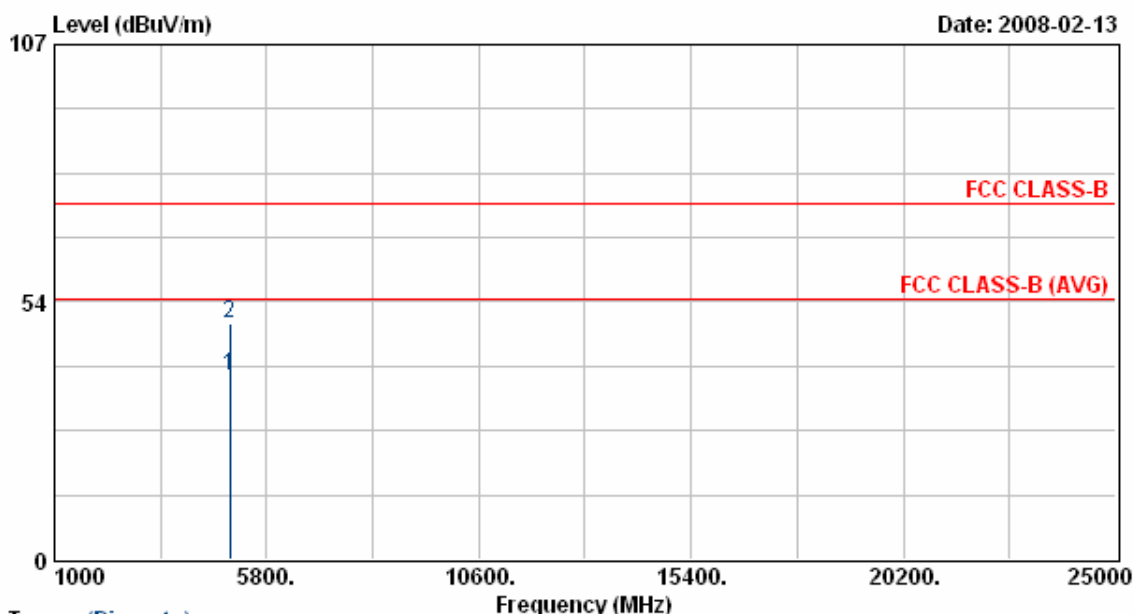

Trace: (Discrete)

Item	Freq	Read Value	Factor	Result	Limit	Margin	Remark	Ant Pos	Tab Pos
	MHz	dBuV/m	dB	dBuV/m	dBuV/m	dB		cm	Deg
1	4959.88	31.75	6.33	38.08	54.00	-15.92	Average	100	194
2	4959.88	42.55	6.33	48.87	74.00	-25.13	Peak	100	194

Notes:

1. Result = Read Value + Factor
2. Factor = Antenna Factor + Cable Loss - Amplifier
3. The resolution bandwidth of test receiver/spectrum analyzer is 120KHz and video bandwidth is 300kHz for Peak detection and Quasi-peak detection at frequency below 1GHz.
4. The resolution bandwidth of test receiver/spectrum analyzer is 1MHz and video bandwidth is 3MHz for Peak detection at frequency above 1GHz.
5. The resolution bandwidth of test receiver/spectrum analyzer is 1MHz and video bandwidth is 10Hz for Average detection at frequency above 1GHz.
6. The other emissions is too low to be measured.

Power	: AC 120V	Pol/Phase	: HORIZONTAL
Test Mode	: Transmit / Receive	Temperature	: 15 °C
Operation Channel	: 78	Humidity	: 70 %
Modulation Type	: GFSK	Atmospheric Pressure	: 1030 hPa
Memo	:	Rate	: 1 Mbps

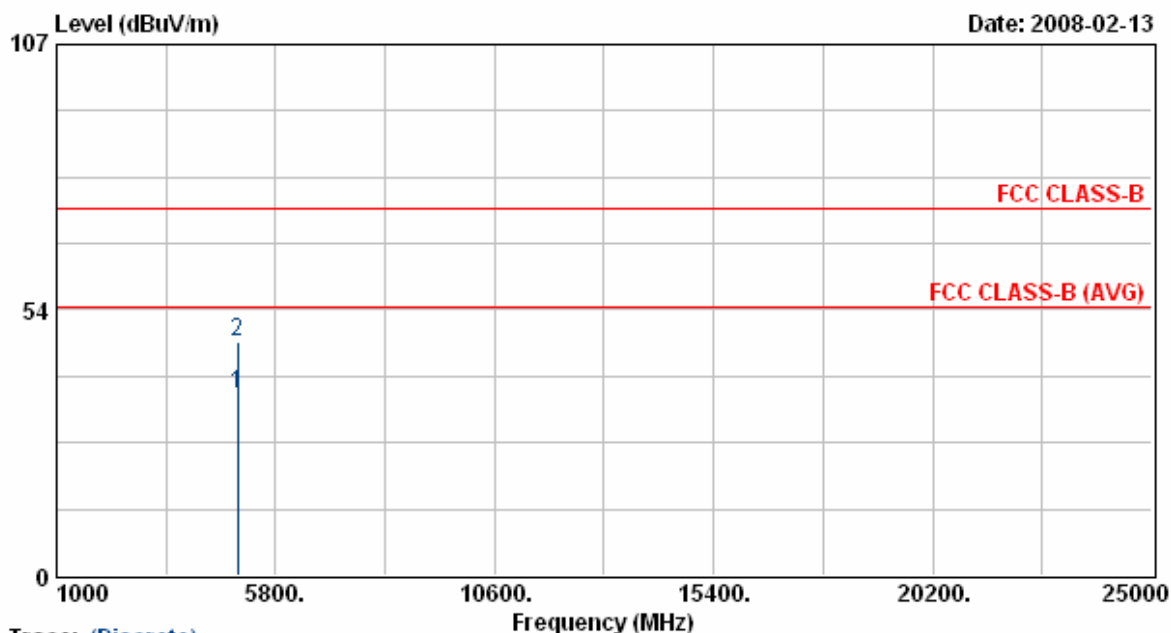

Trace: (Discrete)

Item	Freq	Read Value	Factor	Result	Limit	Margin	Remark	Ant Pos	Tab Pos
	MHz	dBuV/m	dB	dBuV/m	dBuV/m	dB		cm	Deg
1	4960.13	30.26	6.33	36.59	54.00	-17.41	Average	100	238
2	4960.13	40.59	6.33	46.91	74.00	-27.09	Peak	100	238

Notes:

1. Result = Read Value + Factor
2. Factor = Antenna Factor + Cable Loss - Amplifier
3. The resolution bandwidth of test receiver/spectrum analyzer is 120KHz and video bandwidth is 300kHz for Peak detection and Quasi-peak detection at frequency below 1GHz.
4. The resolution bandwidth of test receiver/spectrum analyzer is 1MHz and video bandwidth is 3MHz for Peak detection at frequency above 1GHz.
5. The resolution bandwidth of test receiver/spectrum analyzer is 1MHz and video bandwidth is 10Hz for Average detection at frequency above 1GHz.
6. The other emissions is too low to be measured.

Power	: AC 120V	Pol/Phase	: VERTICAL
Test Mode	: Transmit / Receive	Temperature	: 25 °C
Operation Channel	: 0	Humidity	: 70 %
Modulation Type	: $\pi/4$ -DQPSK	Atmospheric Pressure	: 1030 hPa
Memo	:	Rate	: 2 Mbps

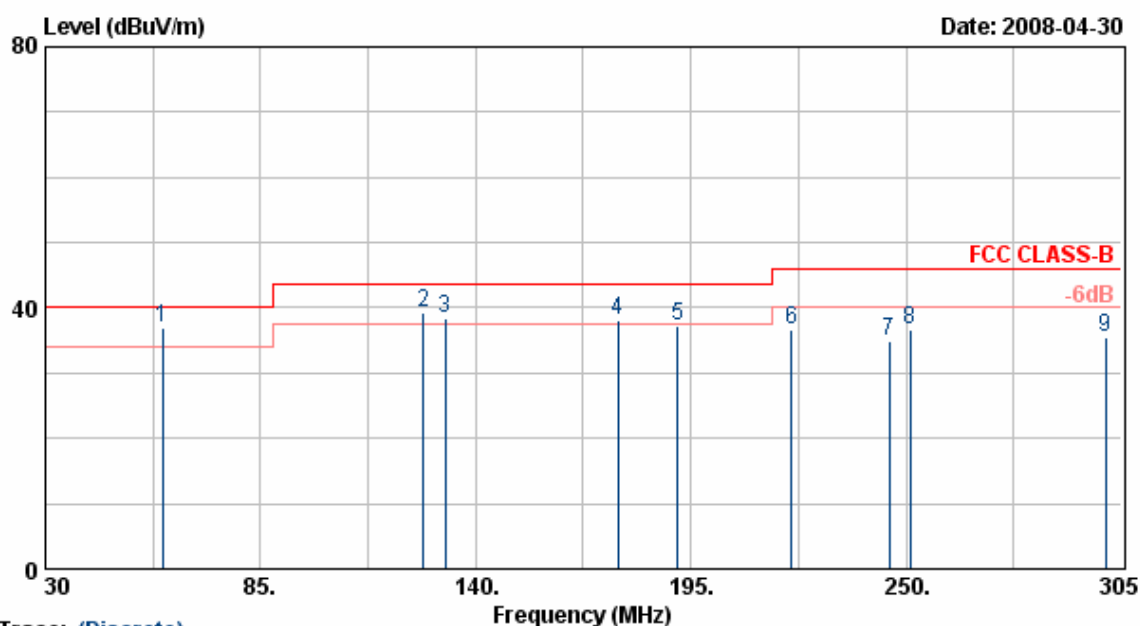

Trace: (Discrete)

Item	Freq	Read Value	Factor	Result	Limit	Margin	Remark	Ant Pos	Tab Pos
	MHz	dBuV/m	dB	dBuV/m	dBuV/m	dB		cm	Deg
1	59.98	54.52	-17.69	36.83	40.00	-3.17	QP	100	179
2	126.53	51.22	-11.85	39.37	43.50	-4.13	QP	100	161
3	132.30	51.53	-13.00	38.53	43.50	-4.97	QP	100	199
4	176.30	52.33	-14.23	38.10	43.50	-5.40	QP	100	222
5	191.70	49.77	-12.58	37.19	43.50	-6.31	Peak	100	222
6	220.85	50.45	-13.86	36.58	46.00	-9.42	Peak	100	222
7	245.60	46.62	-11.58	35.04	46.00	-10.96	Peak	100	50
8	251.10	47.41	-10.88	36.53	46.00	-9.47	Peak	100	93
9	300.88	47.93	-12.51	35.42	46.00	-10.58	Peak	100	93

- Remarks:
1. Result = Read Value + Factor
 2. Factor = Antenna Factor + Cable Loss - Amplifier
 3. According to technical experiences, all spurious emission of FM mode at channel 0,39,78 are almost the same below 1GHz, so that the channel 0 was chosen as representative in final test.
 4. The data is worst case.

Power	: AC 120V	Pol/Phase	: VERTICAL
Test Mode	: Transmit / Receive	Temperature	: 25 °C
Operation Channel	: 0	Humidity	: 70 %
Modulation Type	: $\pi/4$ -DQPSK	Atmospheric Pressure	: 1030 hPa
Memo	:	Rate	: 2 Mbps

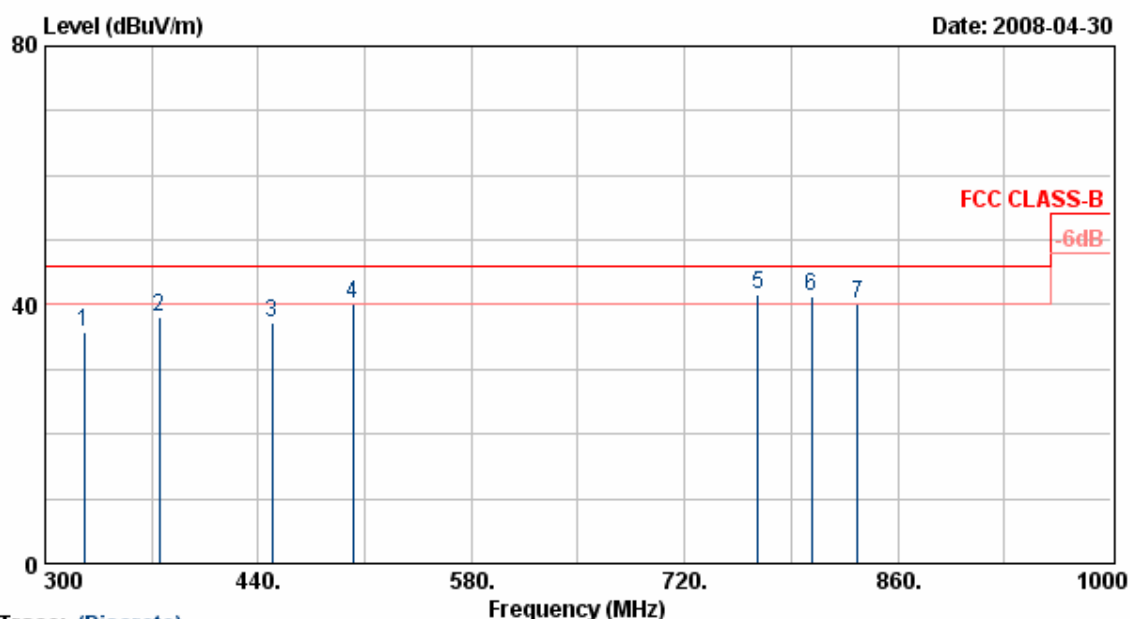

Trace: (Discrete)

Item	Freq	Read Value	Factor	Result	Limit	Margin	Remark	Ant Pos	Tab Pos
	MHz	dBuV/m	dB	dBuV/m	dBuV/m	dB		cm	Deg
1	325.90	47.43	-11.71	35.72	46.00	-10.28	Peak	100	74
2	374.90	47.55	-9.35	38.20	46.00	-7.80	Peak	100	99
3	449.10	46.93	-9.77	37.16	46.00	-8.84	Peak	100	156
4	502.30	44.55	-4.49	40.06	46.00	-5.94	QP	100	229
5	768.30	44.75	-3.08	41.67	46.00	-4.33	QP	100	360
6	803.30	42.40	-1.10	41.30	46.00	-4.70	QP	100	360
7	833.40	42.42	-2.31	40.11	46.00	-5.89	QP	100	360

- Remarks:
1. Result = Read Value + Factor
 2. Factor = Antenna Factor + Cable Loss - Amplifier
 3. According to technical experiences, all spurious emission of FM mode at channel 0,39,78 are almost the same below 1GHz, so that the channel 0 was chosen as representative in final test.
 4. The data is worst case.

Power	: AC 120V	Pol/Phase	: HORIZONTAL
Test Mode	: Transmit / Receive	Temperature	: 25 °C
Operation Channel	: 0	Humidity	: 70 %
Modulation Type	: $\pi/4$ -DQPSK	Atmospheric Pressure	: 1030 hPa
Memo	:	Rate	: 2 Mbps

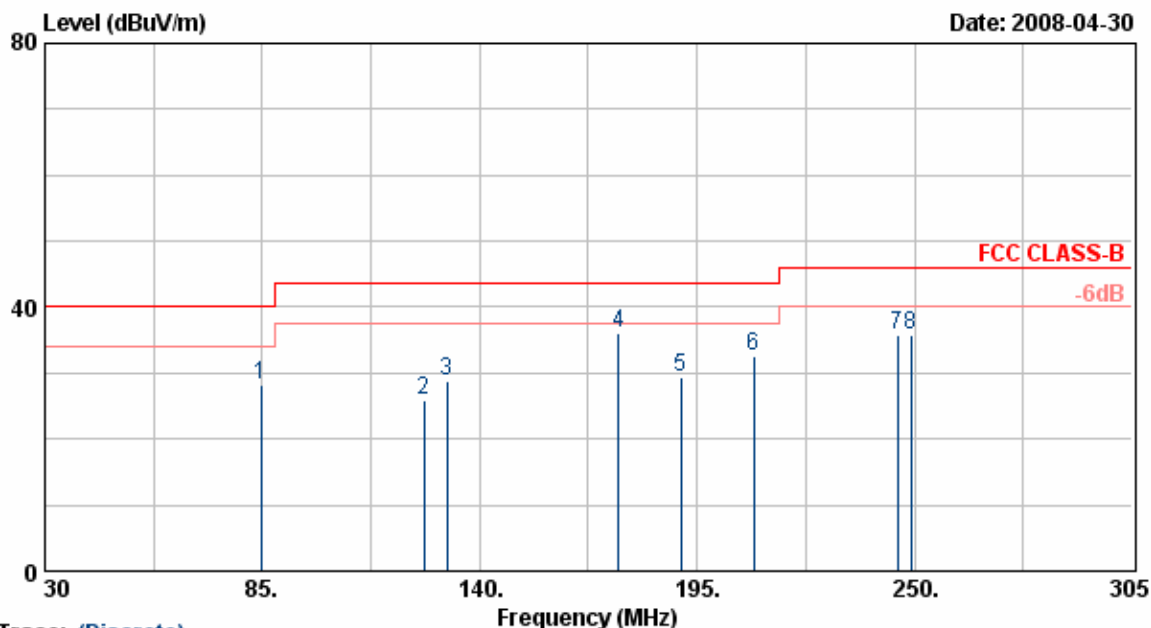

Trace: (Discrete)

Item	Freq	Read Value	Factor	Result	Limit	Margin	Remark	Ant Pos	Tab Pos
	MHz	dBuV/m	dB	dBuV/m	dBuV/m	dB		cm	Deg
1	84.73	51.99	-23.80	28.19	40.00	-11.81	Peak	200	95
2	125.98	45.90	-20.06	25.84	43.50	-17.66	Peak	200	95
3	131.75	48.66	-19.82	28.84	43.50	-14.66	Peak	200	211
4	175.20	57.10	-21.03	36.07	43.50	-7.43	Peak	200	196
5	190.88	50.23	-20.84	29.39	43.50	-14.11	Peak	200	196
6	209.30	51.43	-18.88	32.55	43.50	-10.95	Peak	200	196
7	245.60	52.52	-16.68	35.84	46.00	-10.16	Peak	200	277
8	249.18	51.60	-15.87	35.73	46.00	-10.27	Peak	200	360

- Remarks:
1. Result = Read Value + Factor
 2. Factor = Antenna Factor + Cable Loss - Amplifier
 3. According to technical experiences, all spurious emission of FM mode at channel 0,39,78 are almost the same below 1GHz, so that the channel 0 was chosen as representative in final test.
 4. The data is worst case.

Power	: AC 120V	Pol/Phase	: HORIZONTAL
Test Mode	: Transmit / Receive	Temperature	: 25 °C
Operation Channel	: 0	Humidity	: 70 %
Modulation Type	: $\pi/4$ -DQPSK	Atmospheric Pressure	: 1030 hPa
Memo	:	Rate	: 2 Mbps

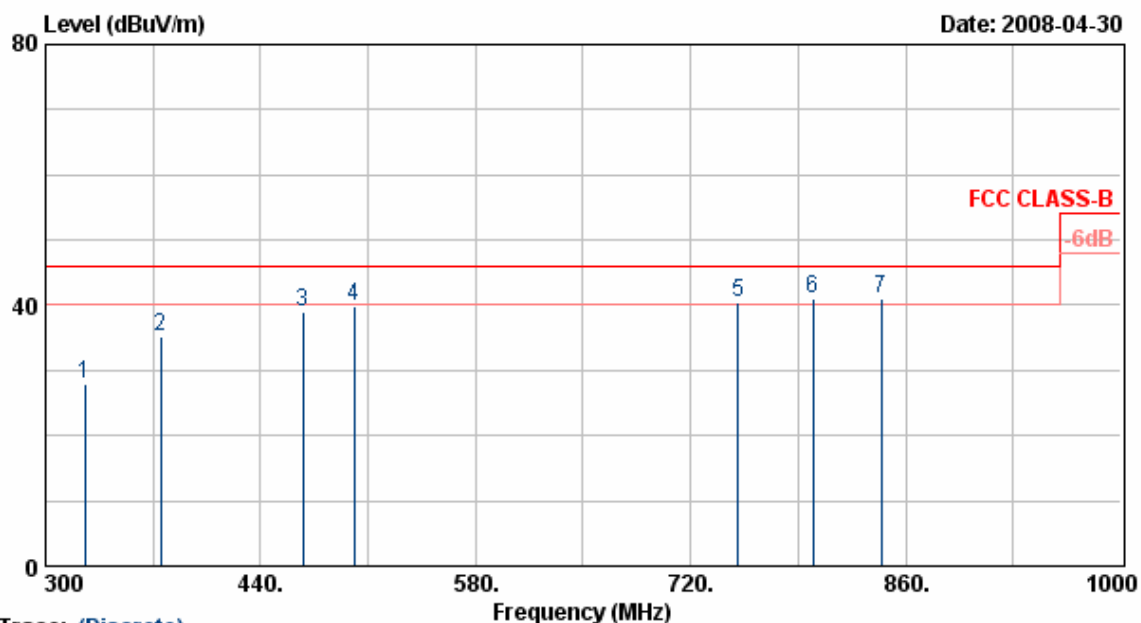

Trace: (Discrete)

Item	Freq	Read Value	Factor	Result	Limit	Margin	Remark	Ant Pos	Tab Pos
	MHz	dBuV/m	dB	dBuV/m	dBuV/m	dB		cm	Deg
1	325.90	41.66	-13.72	27.94	46.00	-18.06	Peak	200	49
2	374.90	45.99	-10.67	35.32	46.00	-10.68	Peak	200	144
3	467.30	46.60	-7.61	38.99	46.00	-7.01	Peak	200	52
4	500.90	46.46	-6.57	39.89	46.00	-6.11	QP	200	111
5	750.80	45.73	-5.20	40.53	46.00	-5.47	QP	200	178
6	799.80	44.51	-3.63	40.88	46.00	-5.12	QP	200	178
7	843.90	44.73	-3.74	40.99	46.00	-5.01	QP	200	105

Remarks: 1. Result = Read Value + Factor
 2. Factor = Antenna Factor + Cable Loss - Amplifier
 3. According to technical experiences, all spurious emission of FM mode at channel 0,39,78 are almost the same below 1GHz, so that the channel 0 was chosen as representative in final test.
 4. The data is worst case.

Power	: AC 120V	Pol/Phase	: VERTICAL
Test Mode	: Transmit / Receive	Temperature	: 25 °C
Operation Channel	: 0	Humidity	: 70 %
Modulation Type	: $\pi/4$ -DQPSK	Atmospheric Pressure	: 1030 hPa
Memo	:	Rate	: 2 Mbps

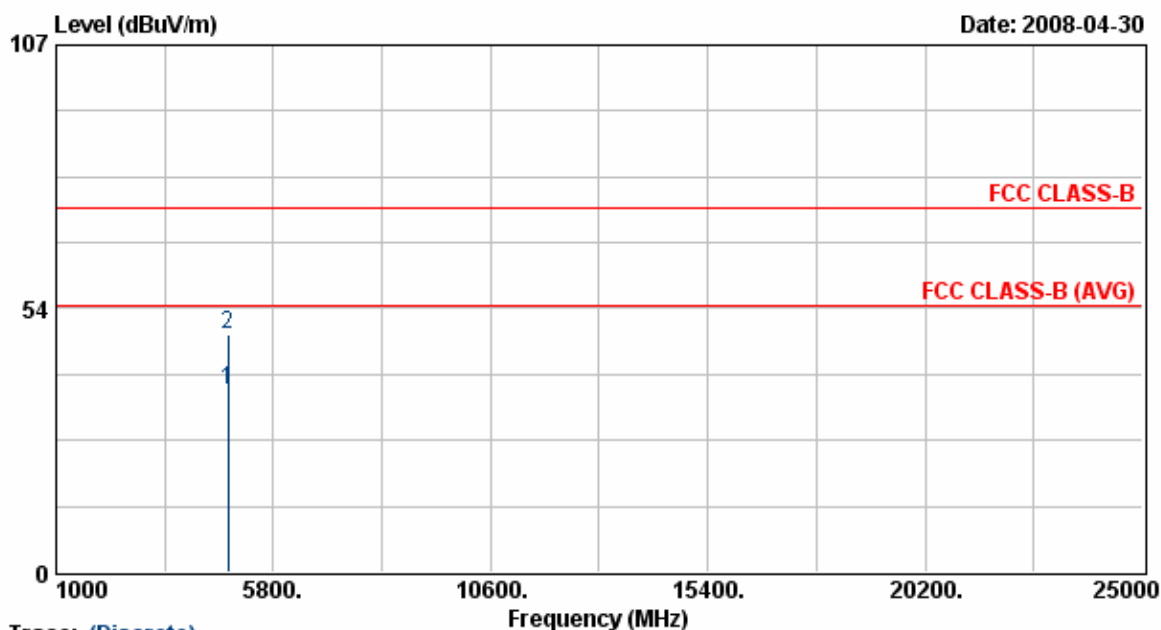

Trace: (Discrete)

Item	Freq	Read Value	Factor	Result	Limit	Margin	Remark	Ant Pos	Tab Pos
	MHz	dBuV/m	dB	dBuV/m	dBuV/m	dB		cm	Deg
1	4804.00	31.32	5.62	36.94	54.00	-17.06	Average	100	194
2	4804.00	42.50	5.62	48.12	74.00	-25.88	Peak	100	194

Notes:

1. Result = Read Value + Factor
2. Factor = Antenna Factor + Cable Loss - Amplifier
3. The resolution bandwidth of test receiver/spectrum analyzer is 120KHz and video bandwidth is 300kHz for Peak detection and Quasi-peak detection at frequency below 1GHz.
4. The resolution bandwidth of test receiver/spectrum analyzer is 1MHz and video bandwidth is 3MHz for Peak detection at frequency above 1GHz.
5. The resolution bandwidth of test receiver/spectrum analyzer is 1MHz and video bandwidth is 10Hz for Average detection at frequency above 1GHz.
6. The other emissions is too low to be measured.

Power	: AC 120V	Pol/Phase	: HORIZONTAL
Test Mode	: Transmit / Receive	Temperature	: 25 °C
Operation Channel	: 0	Humidity	: 70 %
Modulation Type	: $\pi/4$ -DQPSK	Atmospheric Pressure	: 1030 hPa
Memo	:	Rate	: 2 Mbps

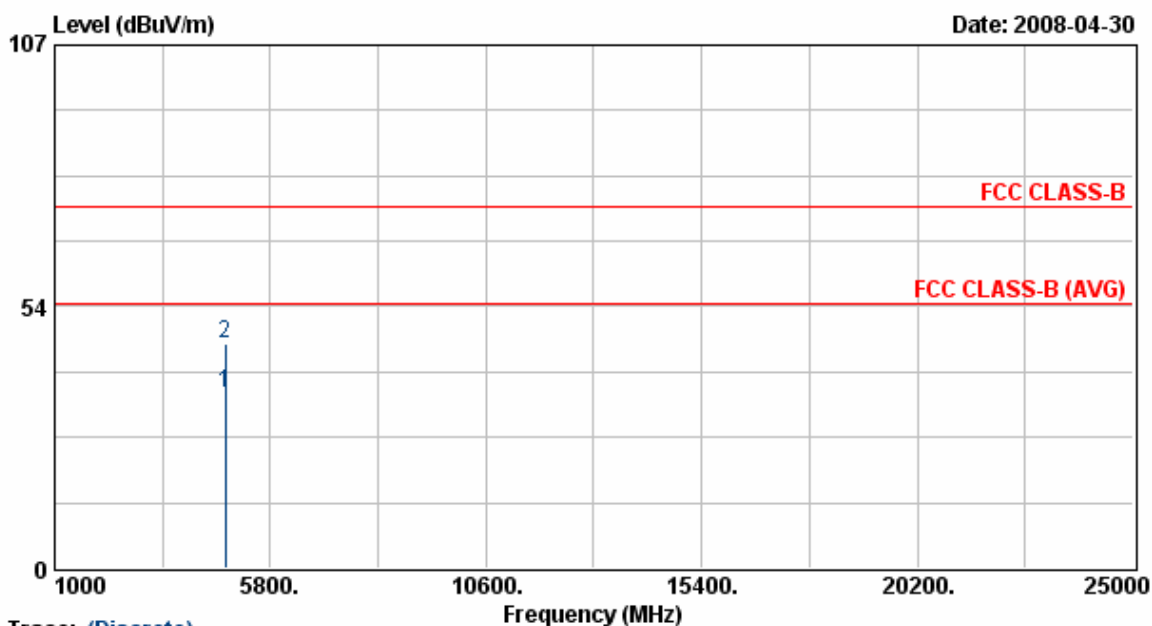

Trace: (Discrete)

Item	Freq	Read Value	Factor	Result	Limit	Margin	Remark	Ant Pos	Tab Pos
	MHz	dBuV/m	dB	dBuV/m	dBuV/m	dB		cm	Deg
1	4804.00	30.12	5.62	35.74	54.00	-18.26	Average	100	238
2	4804.00	40.42	5.62	46.04	74.00	-27.96	Peak	100	238

Notes:

1. Result = Read Value + Factor
2. Factor = Antenna Factor + Cable Loss - Amplifier
3. The resolution bandwidth of test receiver/spectrum analyzer is 120KHz and video bandwidth is 300kHz for Peak detection and Quasi-peak detection at frequency below 1GHz.
4. The resolution bandwidth of test receiver/spectrum analyzer is 1MHz and video bandwidth is 3MHz for Peak detection at frequency above 1GHz.
5. The resolution bandwidth of test receiver/spectrum analyzer is 1MHz and video bandwidth is 10Hz for Average detection at frequency above 1GHz.
6. The other emissions is too low to be measured.

Power	: AC 120V	Pol/Phase	: VERTICAL
Test Mode	: Transmit / Receive	Temperature	: 25 °C
Operation Channel	: 39	Humidity	: 70 %
Modulation Type	: $\pi/4$ -DQPSK	Atmospheric Pressure	: 1030 hPa
Memo	:	Rate	: 2 Mbps

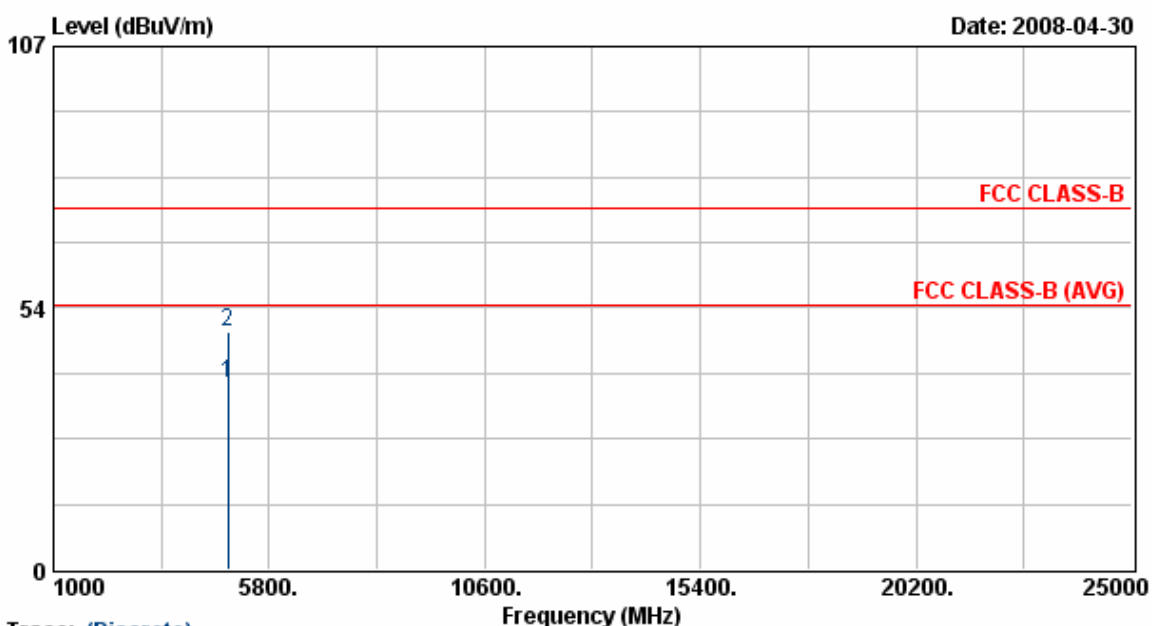

Trace: (Discrete)

Item	Freq	Read Value	Factor	Result	Limit	Margin	Remark	Ant Pos	Tab Pos
	MHz	dBuV/m	dB	dBuV/m	dBuV/m	dB		cm	Deg
1	4881.88	32.49	5.82	38.31	54.00	-15.69	Average	100	194
2	4881.88	42.88	5.82	48.70	74.00	-25.30	Peak	100	194

Notes:

1. Result = Read Value + Factor
2. Factor = Antenna Factor + Cable Loss - Amplifier
3. The resolution bandwidth of test receiver/spectrum analyzer is 120KHz and video bandwidth is 300kHz for Peak detection and Quasi-peak detection at frequency below 1GHz.
4. The resolution bandwidth of test receiver/spectrum analyzer is 1MHz and video bandwidth is 3MHz for Peak detection at frequency above 1GHz.
5. The resolution bandwidth of test receiver/spectrum analyzer is 1MHz and video bandwidth is 10Hz for Average detection at frequency above 1GHz.
6. The other emissions is too low to be measured.

Power	: AC 120V	Pol/Phase	: HORIZONTAL
Test Mode	: Transmit / Receive	Temperature	: 25 °C
Operation Channel	: 39	Humidity	: 70 %
Modulation Type	: $\pi/4$ -DQPSK	Atmospheric Pressure	: 1030 hPa
Memo	:	Rate	: 2 Mbps

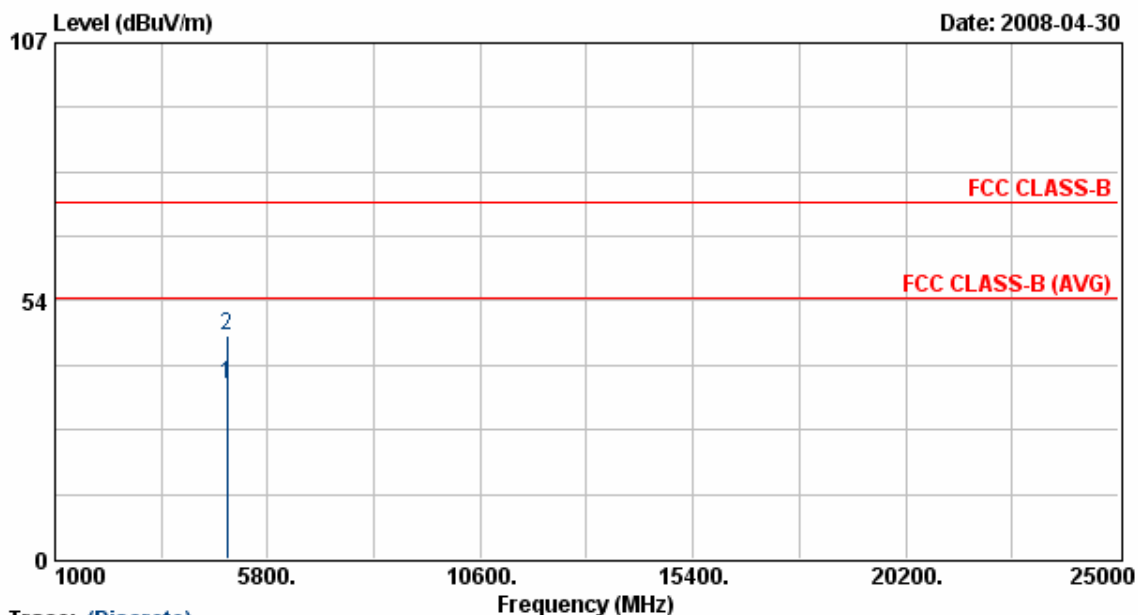

Trace: (Discrete)

Item	Freq	Read Value	Factor	Result	Limit	Margin	Remark	Ant Pos	Tab Pos
	MHz	dBuV/m	dB	dBuV/m	dBuV/m	dB		cm	Deg
1	4882.00	30.26	5.82	36.08	54.00	-17.92	Average	100	238
2	4882.00	40.58	5.82	46.40	74.00	-27.60	Peak	100	238

Notes:

1. Result = Read Value + Factor
2. Factor = Antenna Factor + Cable Loss - Amplifier
3. The resolution bandwidth of test receiver/spectrum analyzer is 120KHz and video bandwidth is 300kHz for Peak detection and Quasi-peak detection at frequency below 1GHz.
4. The resolution bandwidth of test receiver/spectrum analyzer is 1MHz and video bandwidth is 3MHz for Peak detection at frequency above 1GHz.
5. The resolution bandwidth of test receiver/spectrum analyzer is 1MHz and video bandwidth is 10Hz for Average detection at frequency above 1GHz.
6. The other emissions is too low to be measured.

Power	: AC 120V	Pol/Phase	: VERTICAL
Test Mode	: Transmit / Receive	Temperature	: 25 °C
Operation Channel	: 78	Humidity	: 70 %
Modulation Type	: $\pi/4$ -DQPSK	Atmospheric Pressure	: 1030 hPa
Memo	:	Rate	: 2 Mbps

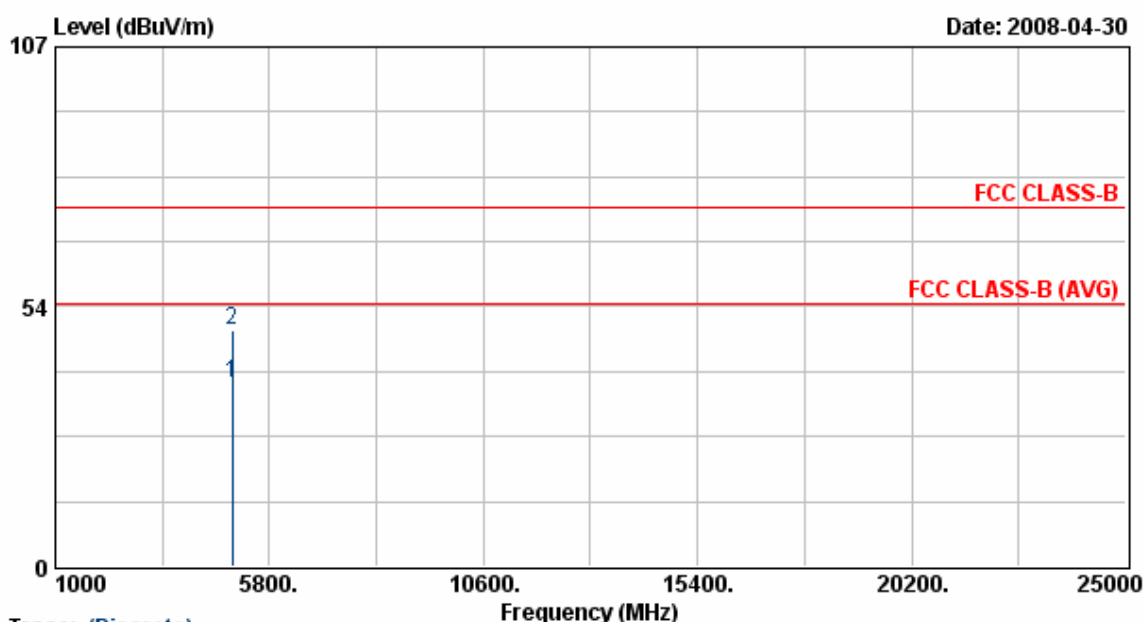

Trace: (Discrete)

Item	Freq	Read Value	Factor	Result	Limit	Margin	Remark	Ant Pos	Tab Pos
	MHz	dBuV/m	dB	dBuV/m	dBuV/m	dB		cm	Deg
1	4959.88	31.75	6.03	37.78	54.00	-16.22	Average	100	194
2	4959.88	42.55	6.03	48.57	74.00	-25.43	Peak	100	194

Notes:

1. Result = Read Value + Factor
2. Factor = Antenna Factor + Cable Loss - Amplifier
3. The resolution bandwidth of test receiver/spectrum analyzer is 120KHz and video bandwidth is 300kHz for Peak detection and Quasi-peak detection at frequency below 1GHz.
4. The resolution bandwidth of test receiver/spectrum analyzer is 1MHz and video bandwidth is 3MHz for Peak detection at frequency above 1GHz.
5. The resolution bandwidth of test receiver/spectrum analyzer is 1MHz and video bandwidth is 10Hz for Average detection at frequency above 1GHz.
6. The other emissions is too low to be measured.

Power	: AC 120V	Pol/Phase	: HORIZONTAL
Test Mode	: Transmit / Receive	Temperature	: 25 °C
Operation Channel	: 78	Humidity	: 70 %
Modulation Type	: $\pi/4$ -DQPSK	Atmospheric Pressure	: 1030 hPa
Memo	:	Rate	: 2 Mbps

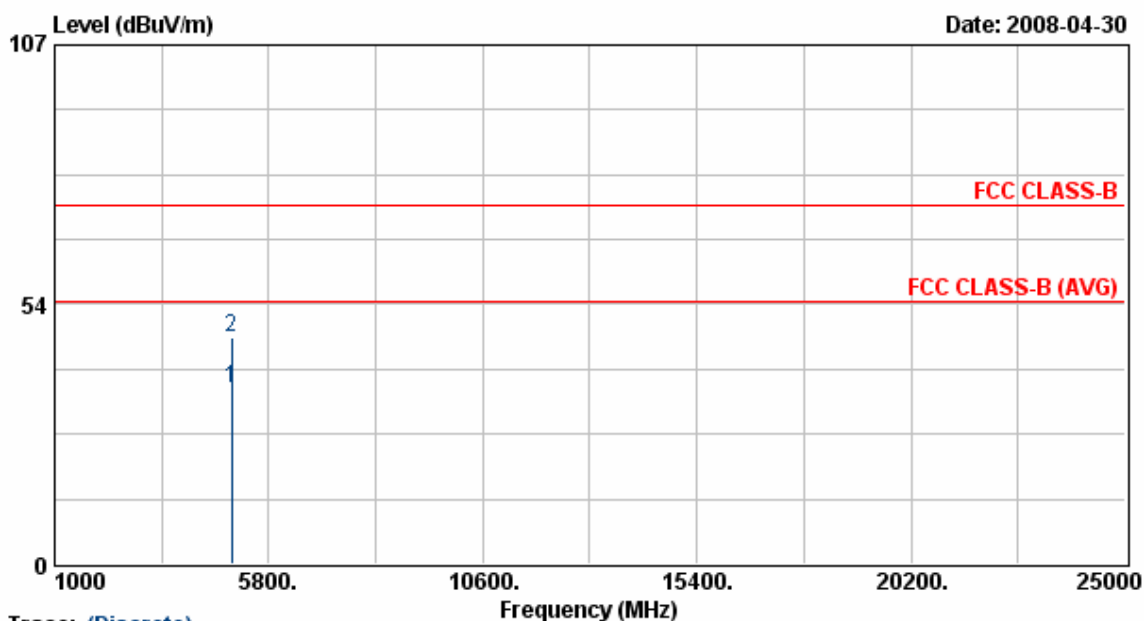

Trace: (Discrete)

Item	Freq	Read Value	Factor	Result	Limit	Margin	Remark	Ant Pos	Tab Pos
	MHz	dBuV/m	dB	dBuV/m	dBuV/m	dB		cm	Deg
1	4960.13	30.26	6.03	36.29	54.00	-17.71	Average	100	238
2	4960.13	40.59	6.03	46.61	74.00	-27.39	Peak	100	238

Notes:

1. Result = Read Value + Factor
2. Factor = Antenna Factor + Cable Loss - Amplifier
3. The resolution bandwidth of test receiver/spectrum analyzer is 120kHz and video bandwidth is 300kHz for Peak detection and Quasi-peak detection at frequency below 1GHz.
4. The resolution bandwidth of test receiver/spectrum analyzer is 1MHz and video bandwidth is 3MHz for Peak detection at frequency above 1GHz.
5. The resolution bandwidth of test receiver/spectrum analyzer is 1MHz and video bandwidth is 10Hz for Average detection at frequency above 1GHz.
6. The other emissions is too low to be measured.

Power	: AC 120V	Pol/Phase	: VERTICAL
Test Mode	: Transmit / Receive	Temperature	: 25 °C
Operation Channel	: 0	Humidity	: 70 %
Modulation Type	: 8DPSK	Atmospheric Pressure	: 1030 hPa
Memo	:	Rate	: 3 Mbps

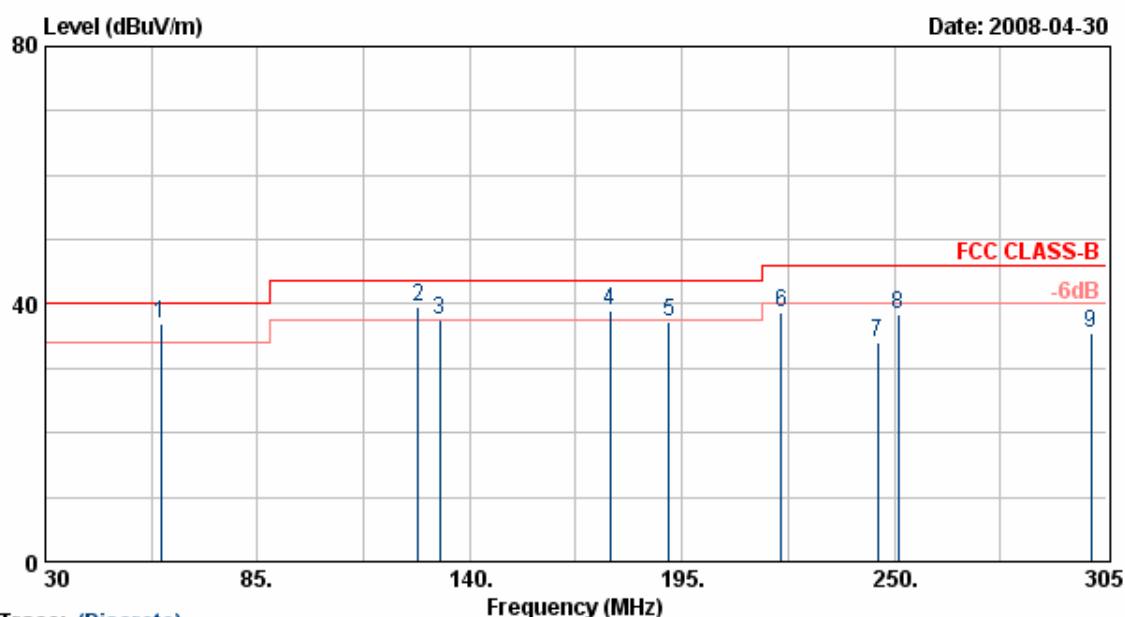

Trace: (Discrete)

Item	Freq	Read Value	Factor	Result	Limit	Margin	Remark	Ant Pos	Tab Pos
	MHz	dBuV/m	dB	dBuV/m	dBuV/m	dB		cm	Deg
1	59.98	54.55	-17.69	36.86	40.00	-3.14	QP	100	179
2	126.53	51.40	-11.85	39.55	43.50	-3.95	QP	100	161
3	132.30	50.61	-13.00	37.61	43.50	-5.89	QP	100	199
4	176.30	53.24	-14.23	39.01	43.50	-4.49	QP	100	222
5	191.70	49.82	-12.58	37.24	43.50	-6.26	Peak	100	222
6	220.85	52.45	-13.86	38.58	46.00	-7.42	Peak	100	222
7	245.60	45.62	-11.58	34.04	46.00	-11.96	Peak	100	50
8	251.10	49.41	-10.88	38.53	46.00	-7.47	Peak	100	93
9	300.88	47.93	-12.51	35.42	46.00	-10.58	Peak	100	93

Remarks: 1. Result = Read Value + Factor
 2. Factor = Antenna Factor + Cable Loss - Amplifier
 3. According to technical experiences, all spurious emission of FM mode at channel 0,39,78 are almost the same below 1GHz, so that the channel 0 was chosen as representative in final test.
 4. The data is worst case.

Power	: AC 120V	Pol/Phase	: VERTICAL
Test Mode	: Transmit / Receive	Temperature	: 25 °C
Operation Channel	: 0	Humidity	: 70 %
Modulation Type	: 8DPSK	Atmospheric Pressure	: 1030 hPa
Memo	:	Rate	: 3 Mbps

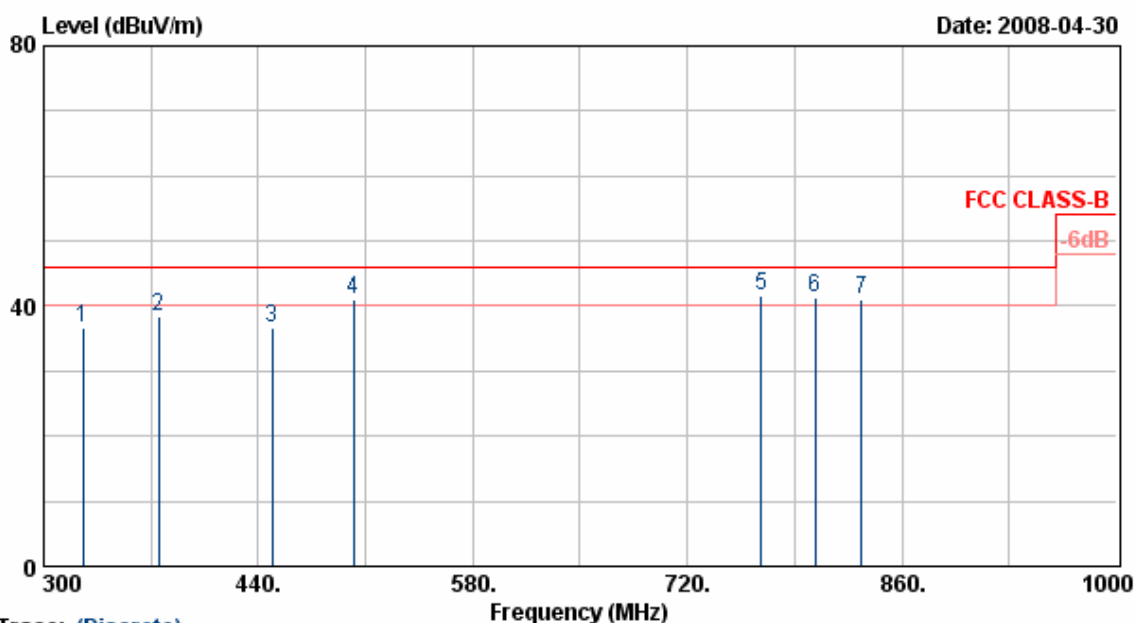

Trace: (Discrete)

Item	Freq	Read Value	Factor	Result	Limit	Margin	Remark	Ant Pos	Tab Pos
	MHz	dBuV/m	dB	dBuV/m	dBuV/m	dB		cm	Deg
1	325.90	48.40	-11.71	36.69	46.00	-9.31	Peak	100	74
2	374.90	47.66	-9.35	38.31	46.00	-7.69	Peak	100	99
3	449.10	46.50	-9.77	36.73	46.00	-9.27	Peak	100	156
4	502.30	45.60	-4.49	41.11	46.00	-4.89	QP	100	229
5	768.30	44.75	-3.08	41.67	46.00	-4.33	QP	100	360
6	803.30	42.40	-1.10	41.30	46.00	-4.70	QP	100	360
7	833.40	43.42	-2.31	41.11	46.00	-4.89	QP	100	360

Remarks: 1. Result = Read Value + Factor
 2. Factor = Antenna Factor + Cable Loss - Amplifier
 3. According to technical experiences, all spurious emission of FM mode at channel 0,39,78 are almost the same below 1GHz, so that the channel 0 was chosen as representative in final test.
 4. The data is worst case.

Power	: AC 120V	Pol/Phase	: HORIZONTAL
Test Mode	: Transmit / Receive	Temperature	: 25 °C
Operation Channel	: 0	Humidity	: 70 %
Modulation Type	: 8DPSK	Atmospheric Pressure	: 1030 hPa
Memo	:	Rate	: 3 Mbps

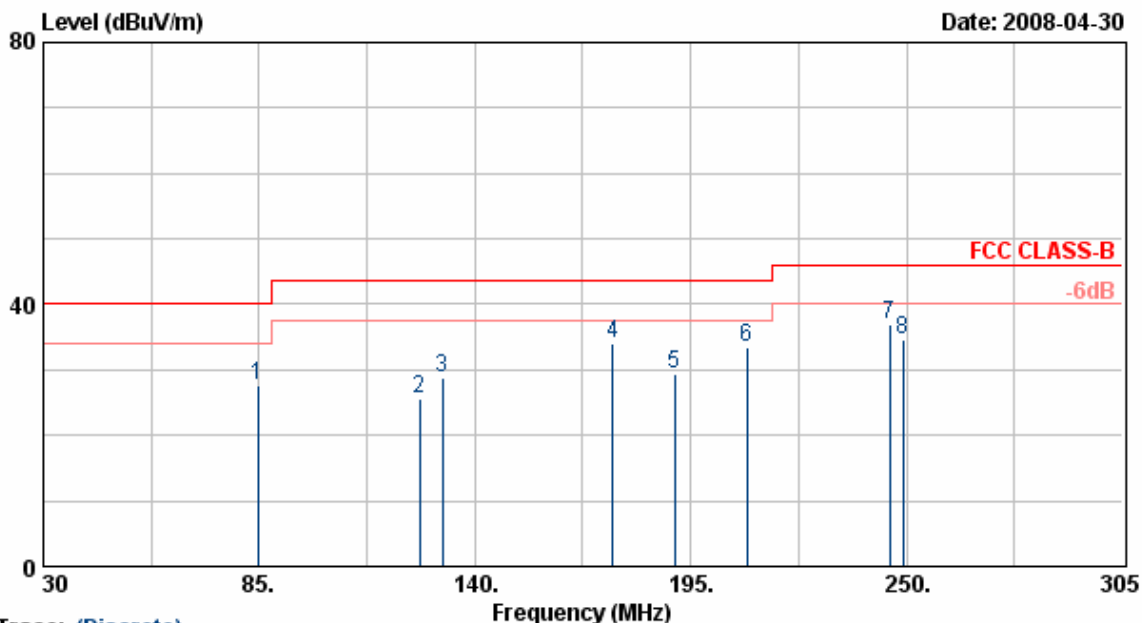

Trace: (Discrete)

Item	Freq MHz	Read Value dBuV/m	Factor dB	Result dBuV/m	Limit dBuV/m	Margin dB	Remark	Ant Pos cm	Tab Pos Deg
1	84.73	51.50	-23.80	27.70	40.00	-12.30	Peak	200	95
2	125.98	45.54	-20.06	25.48	43.50	-18.02	Peak	200	95
3	131.75	48.66	-19.82	28.84	43.50	-14.66	Peak	200	211
4	175.20	55.10	-21.03	34.07	43.50	-9.43	Peak	200	196
5	190.88	50.23	-20.84	29.39	43.50	-14.11	Peak	200	196
6	209.30	52.43	-18.88	33.55	43.50	-9.95	Peak	200	196
7	245.60	53.52	-16.68	36.84	46.00	-9.16	Peak	200	277
8	249.18	50.60	-15.87	34.73	46.00	-11.27	Peak	200	360

- Remarks:
1. Result = Read Value + Factor
 2. Factor = Antenna Factor + Cable Loss - Amplifier
 3. According to technical experiences, all spurious emission of FM mode at channel 0,39,78 are almost the same below 1GHz, so that the channel 0 was chosen as representative in final test.
 4. The data is worst case.

Power	: AC 120V	Pol/Phase	: HORIZONTAL
Test Mode	: Transmit / Receive	Temperature	: 25 °C
Operation Channel	: 0	Humidity	: 70 %
Modulation Type	: 8DPSK	Atmospheric Pressure	: 1030 hPa
Memo	:	Rate	: 3 Mbps

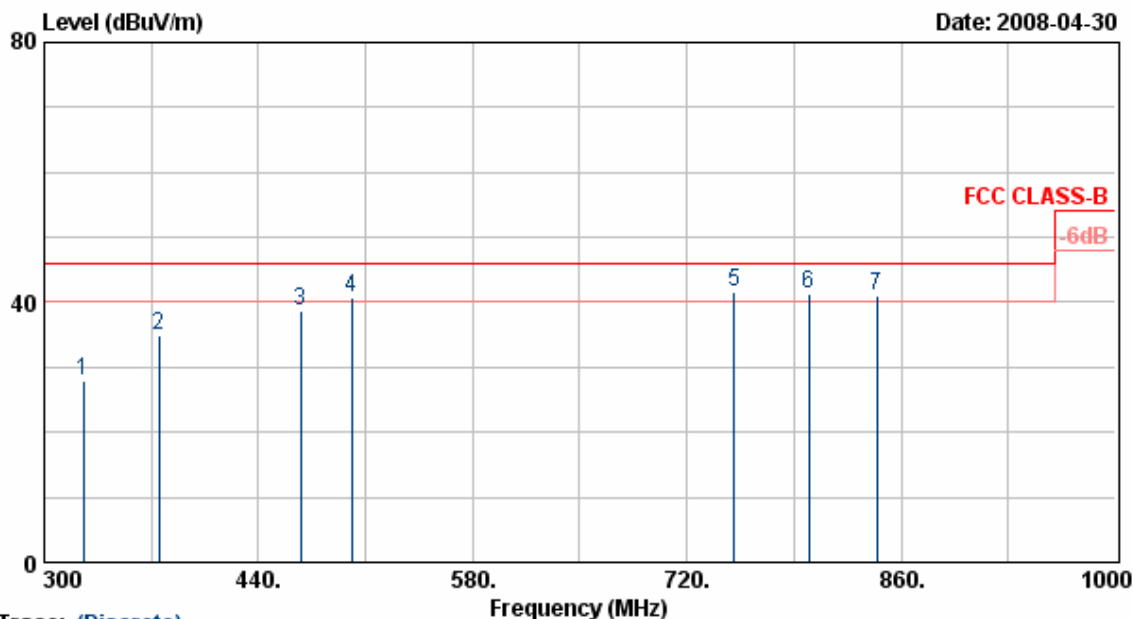

Trace: (Discrete)

Item	Freq	Read Value	Factor	Result	Limit	Margin	Remark	Ant Pos	Tab Pos
	MHz	dBuV/m	dB	dBuV/m	dBuV/m	dB		cm	Deg
1	325.90	41.66	-13.72	27.94	46.00	-18.06	Peak	200	49
2	374.90	45.62	-10.67	34.95	46.00	-11.05	Peak	200	144
3	467.30	46.24	-7.61	38.63	46.00	-7.37	Peak	200	52
4	500.90	47.40	-6.57	40.83	46.00	-5.17	QP	200	111
5	750.80	46.70	-5.20	41.50	46.00	-4.50	QP	200	178
6	799.80	44.88	-3.63	41.25	46.00	-4.75	QP	200	178
7	843.90	44.73	-3.74	40.99	46.00	-5.01	QP	200	105

Remarks: 1. Result = Read Value + Factor
 2. Factor = Antenna Factor + Cable Loss - Amplifier
 3. According to technical experiences, all spurious emission of FM mode at channel 0,39,78 are almost the same below 1GHz, so that the channel 0 was chosen as representative in final test.
 4. The data is worst case.

Power	: AC 120V	Pol/Phase	: VERTICAL
Test Mode	: Transmit / Receive	Temperature	: 25 °C
Operation Channel	: 0	Humidity	: 70 %
Modulation Type	: 8DPSK	Atmospheric Pressure	: 1030 hPa
Memo	:	Rate	: 3 Mbps

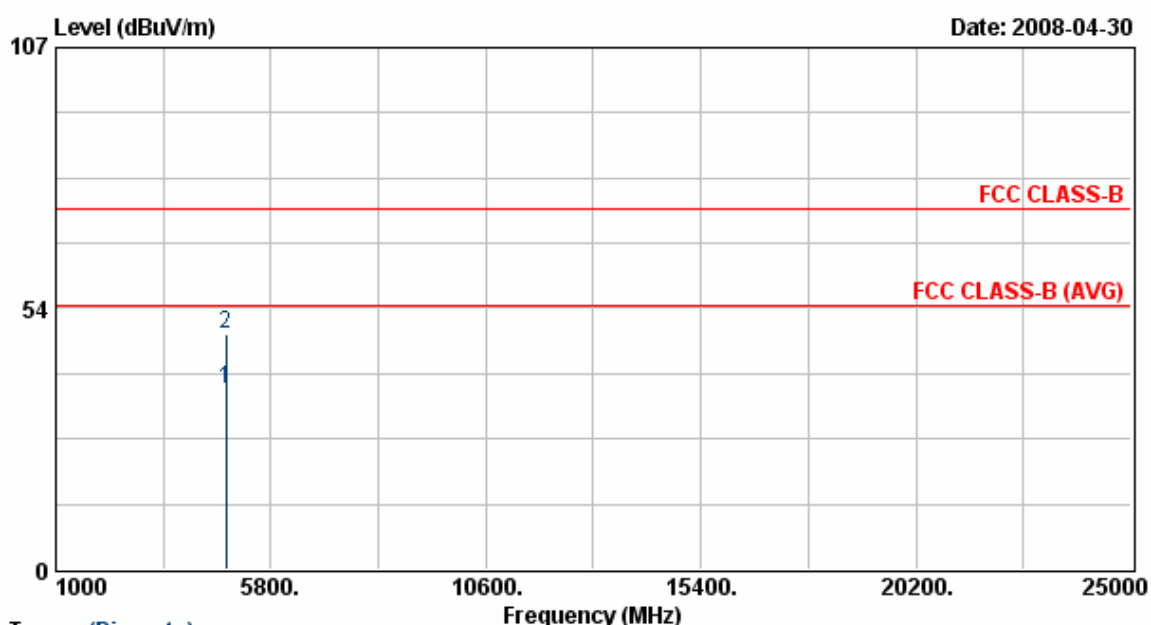

Trace: (Discrete)

Item	Freq	Read Value	Factor	Result	Limit	Margin	Remark	Ant Pos	Tab Pos
	MHz	dBuV/m	dB	dBuV/m	dBuV/m	dB		cm	Deg
1	4804.00	31.32	5.62	36.94	54.00	-17.06	Average	100	194
2	4804.00	42.50	5.62	48.12	74.00	-25.88	Peak	100	194

Notes:

1. Result = Read Value + Factor
2. Factor = Antenna Factor + Cable Loss - Amplifier
3. The resolution bandwidth of test receiver/spectrum analyzer is 120KHz and video bandwidth is 300kHz for Peak detection and Quasi-peak detection at frequency below 1GHz.
4. The resolution bandwidth of test receiver/spectrum analyzer is 1MHz and video bandwidth is 3MHz for Peak detection at frequency above 1GHz.
5. The resolution bandwidth of test receiver/spectrum analyzer is 1MHz and video bandwidth is 10Hz for Average detection at frequency above 1GHz.
6. The other emissions is too low to be measured.

Power	: AC 120V	Pol/Phase	: HORIZONTAL
Test Mode	: Transmit / Receive	Temperature	: 25 °C
Operation Channel	: 0	Humidity	: 70 %
Modulation Type	: 8DPSK	Atmospheric Pressure	: 1030 hPa
Memo	:	Rate	: 3 Mbps

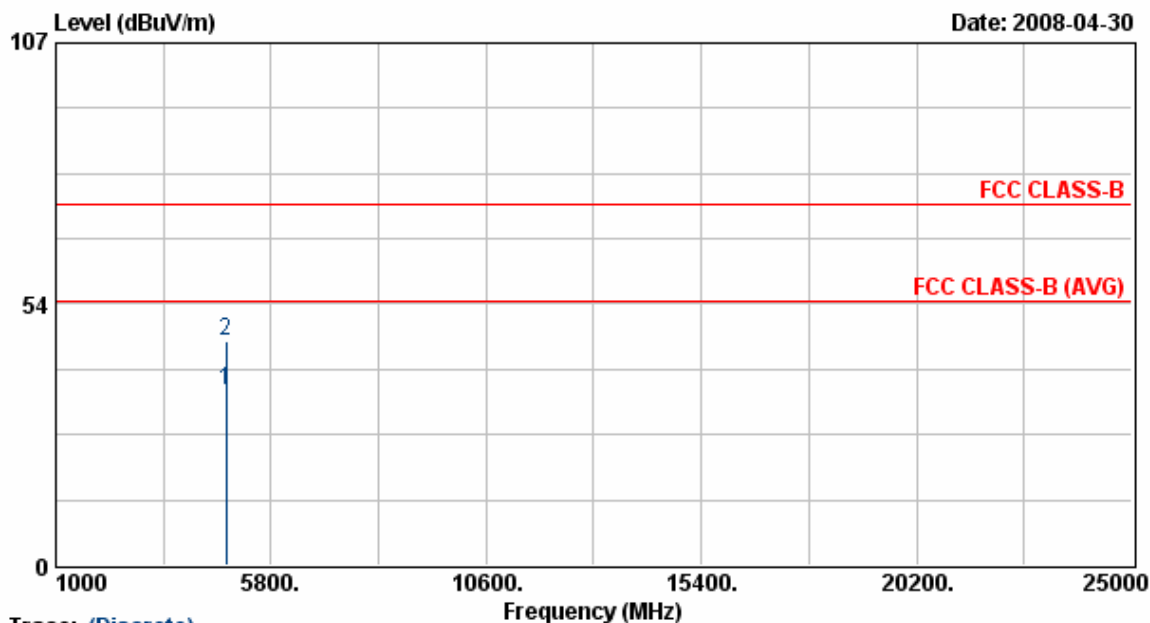

Trace: (Discrete)

Item	Freq	Read Value	Factor	Result	Limit	Margin	Remark	Ant Pos	Tab Pos
	MHz	dBuV/m	dB	dBuV/m	dBuV/m	dB		cm	Deg
1	4804.00	30.12	5.62	35.74	54.00	-18.26	Average	100	238
2	4804.00	40.42	5.62	46.04	74.00	-27.96	Peak	100	238

Notes:

1. Result = Read Value + Factor
2. Factor = Antenna Factor + Cable Loss - Amplifier
3. The resolution bandwidth of test receiver/spectrum analyzer is 120KHz and video bandwidth is 300kHz for Peak detection and Quasi-peak detection at frequency below 1GHz.
4. The resolution bandwidth of test receiver/spectrum analyzer is 1MHz and video bandwidth is 3MHz for Peak detection at frequency above 1GHz.
5. The resolution bandwidth of test receiver/spectrum analyzer is 1MHz and video bandwidth is 10Hz for Average detection at frequency above 1GHz.
6. The other emissions is too low to be measured.

Power	: AC 120V	Pol/Phase	: VERTICAL
Test Mode	: Transmit / Receive	Temperature	: 25 °C
Operation Channel	: 39	Humidity	: 70 %
Modulation Type	: 8DPSK	Atmospheric Pressure	: 1030 hPa
Memo	:	Rate	: 3 Mbps

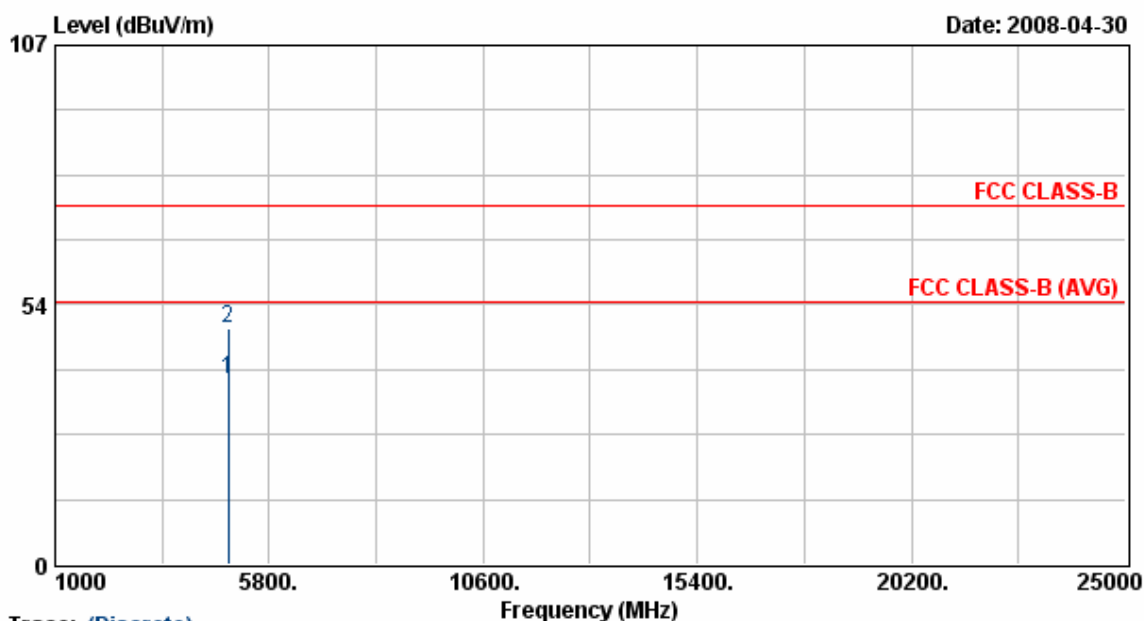

Trace: (Discrete)

Item	Freq	Read Value	Factor	Result	Limit	Margin	Remark	Ant Pos	Tab Pos
	MHz	dBuV/m	dB	dBuV/m	dBuV/m	dB		cm	Deg
1	4881.88	32.49	5.82	38.31	54.00	-15.69	Average	100	194
2	4881.88	42.88	5.82	48.70	74.00	-25.30	Peak	100	194

Notes:

1. Result = Read Value + Factor
2. Factor = Antenna Factor + Cable Loss - Amplifier
3. The resolution bandwidth of test receiver/spectrum analyzer is 120KHz and video bandwidth is 300kHz for Peak detection and Quasi-peak detection at frequency below 1GHz.
4. The resolution bandwidth of test receiver/spectrum analyzer is 1MHz and video bandwidth is 3MHz for Peak detection at frequency above 1GHz.
5. The resolution bandwidth of test receiver/spectrum analyzer is 1MHz and video bandwidth is 10Hz for Average detection at frequency above 1GHz.
6. The other emissions is too low to be measured.

Power	: AC 120V	Pol/Phase	: HORIZONTAL
Test Mode	: Transmit / Receive	Temperature	: 25 °C
Operation Channel	: 39	Humidity	: 70 %
Modulation Type	: 8DPSK	Atmospheric Pressure	: 1030 hPa
Memo	:	Rate	: 3 Mbps

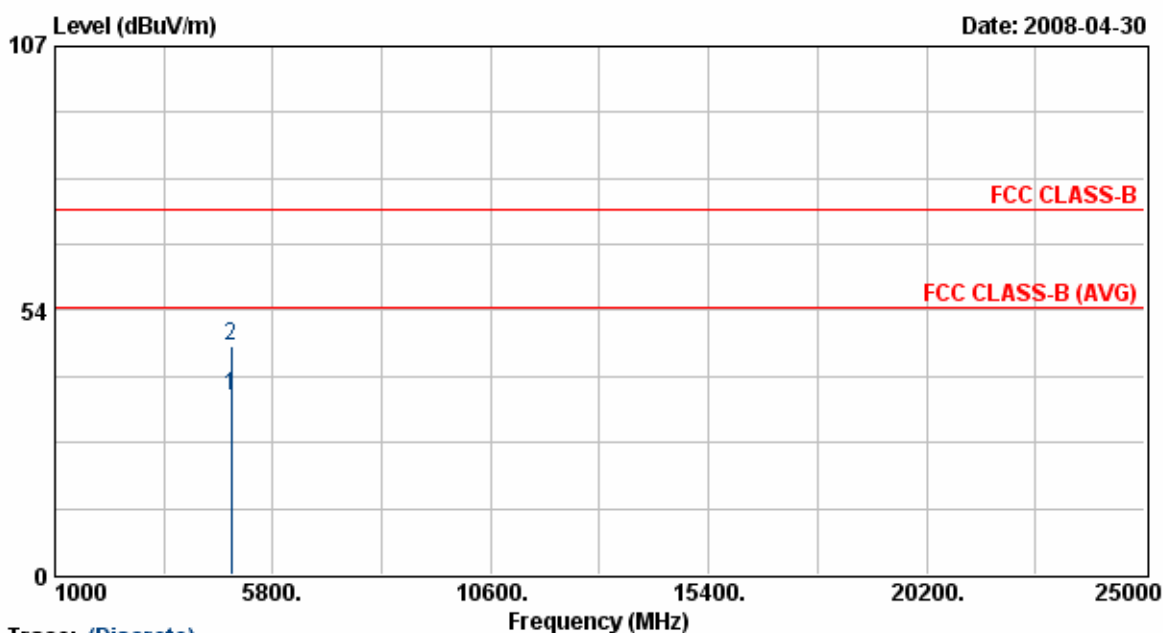

Trace: (Discrete)

Item	Freq	Read Value	Factor	Result	Limit	Margin	Remark	Ant Pos	Tab Pos
	MHz	dBuV/m	dB	dBuV/m	dBuV/m	dB		cm	Deg
1	4882.00	30.26	5.82	36.08	54.00	-17.92	Average	100	238
2	4882.00	40.58	5.82	46.40	74.00	-27.60	Peak	100	238

Notes:

1. Result = Read Value + Factor
2. Factor = Antenna Factor + Cable Loss - Amplifier
3. The resolution bandwidth of test receiver/spectrum analyzer is 120KHz and video bandwidth is 300kHz for Peak detection and Quasi-peak detection at frequency below 1GHz.
4. The resolution bandwidth of test receiver/spectrum analyzer is 1MHz and video bandwidth is 3MHz for Peak detection at frequency above 1GHz.
5. The resolution bandwidth of test receiver/spectrum analyzer is 1MHz and video bandwidth is 10Hz for Average detection at frequency above 1GHz.
6. The other emissions is too low to be measured.

Power	: AC 120V	Pol/Phase	: VERTICAL
Test Mode	: Transmit / Receive	Temperature	: 25 °C
Operation Channel	: 78	Humidity	: 70 %
Modulation Type	: 8DPSK	Atmospheric Pressure	: 1030 hPa
Memo	:	Rate	: 3 Mbps

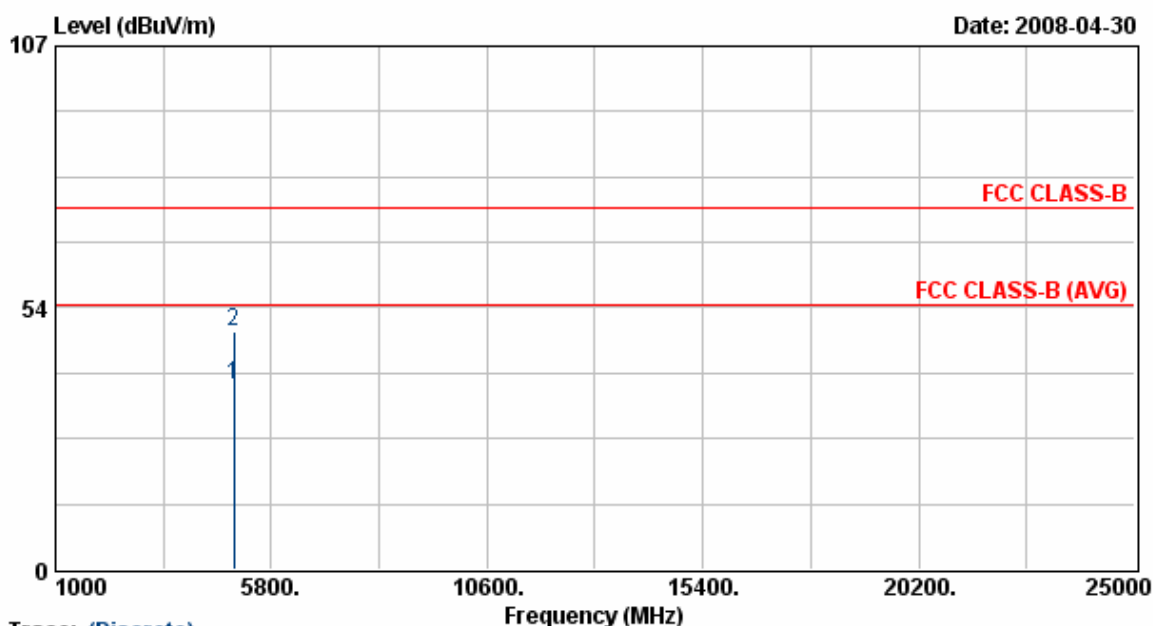

Trace: (Discrete)

Item	Freq	Read Value	Factor	Result	Limit	Margin	Remark	Ant Pos	Tab Pos
	MHz	dBuV/m	dB	dBuV/m	dBuV/m	dB		cm	Deg
1	4959.88	31.75	6.03	37.78	54.00	-16.22	Average	100	194
2	4959.88	42.55	6.03	48.57	74.00	-25.43	Peak	100	194

Notes:

1. Result = Read Value + Factor
2. Factor = Antenna Factor + Cable Loss - Amplifier
3. The resolution bandwidth of test receiver/spectrum analyzer is 120KHz and video bandwidth is 300kHz for Peak detection and Quasi-peak detection at frequency below 1GHz.
4. The resolution bandwidth of test receiver/spectrum analyzer is 1MHz and video bandwidth is 3MHz for Peak detection at frequency above 1GHz.
5. The resolution bandwidth of test receiver/spectrum analyzer is 1MHz and video bandwidth is 10Hz for Average detection at frequency above 1GHz.
6. The other emissions is too low to be measured.

Power	: AC 120V	Pol/Phase	: HORIZONTAL
Test Mode	: Transmit / Receive	Temperature	: 25 °C
Operation Channel	: 78	Humidity	: 70 %
Modulation Type	: 8DPSK	Atmospheric Pressure	: 1030 hPa
Memo	:	Rate	: 3 Mbps

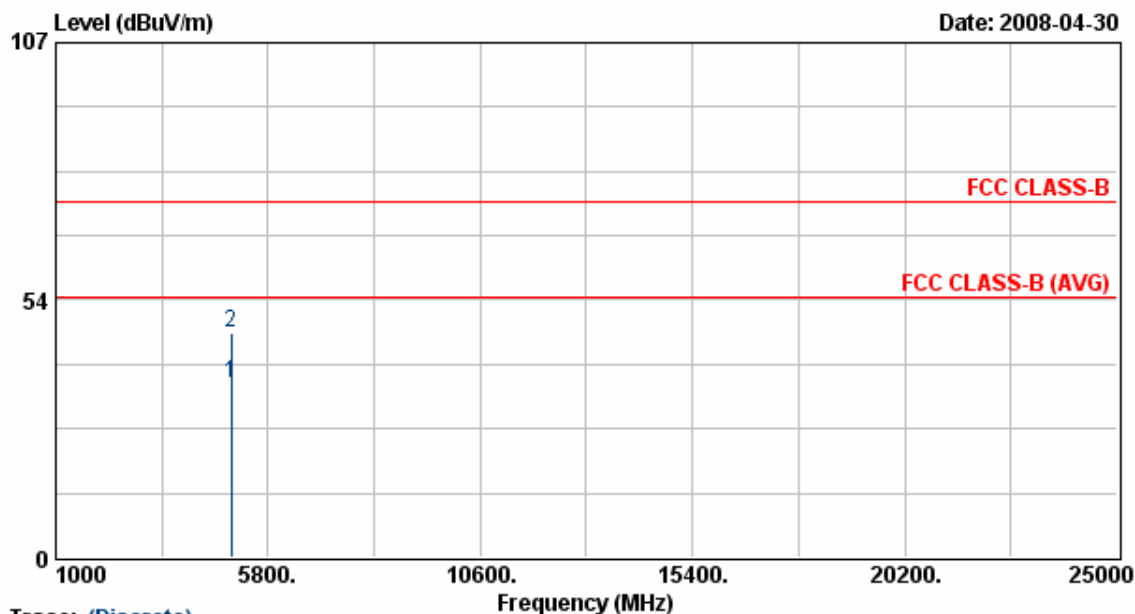

Trace: (Discrete)

Item	Freq	Read Value	Factor	Result	Limit	Margin	Remark	Ant Pos	Tab Pos
	MHz	dBuV/m	dB	dBuV/m	dBuV/m	dB		cm	Deg
1	4960.13	30.26	6.03	36.29	54.00	-17.71	Average	100	238
2	4960.13	40.59	6.03	46.61	74.00	-27.39	Peak	100	238

Notes:

1. Result = Read Value + Factor
2. Factor = Antenna Factor + Cable Loss - Amplifier
3. The resolution bandwidth of test receiver/spectrum analyzer is 120KHz and video bandwidth is 300kHz for Peak detection and Quasi-peak detection at frequency below 1GHz.
4. The resolution bandwidth of test receiver/spectrum analyzer is 1MHz and video bandwidth is 3MHz for Peak detection at frequency above 1GHz.
5. The resolution bandwidth of test receiver/spectrum analyzer is 1MHz and video bandwidth is 10Hz for Average detection at frequency above 1GHz.
6. The other emissions is too low to be measured.

Test engineer: Ben

6. 20dB Bandwidth Measurement Data

6.1 Test Limit

Frequency hopping systems shall have hopping channel carrier frequencies separated by a minimum of 25 kHz or the 20 dB bandwidth of the hopping channel, whichever is greater. Alternatively, frequency hopping systems operating in the 2400–2483.5 MHz band may have hopping channel carrier frequencies that are separated by 25 kHz or two-thirds of the 20 dB bandwidth of the hopping channel, whichever is greater, provided the systems operate with an output power no greater than 125 mW.

6.2 Test Procedures

- a. The transmitter output was connected to the spectrum analyzer.
- b. Set RBW of spectrum analyzer to 30 KHz and VBW to 100 KHz.
- c. The 20 dB bandwidth is defined as the total spectrum the power of which is higher than peak power minus 20 dB.

6.3 Test Setup Layout

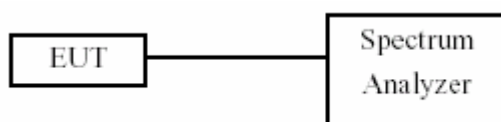

6.4 Measurement equipment

Instrument/Ancillary	Model No.	Manufacturer	Serial No.	Calibration Date	Valid Date
Spectrum Analyzer	FSP40	R&S	10047	2008/02/22	2009/02/21

6.5 Test Result and Data

Modulation Standard: GFSK (1Mbps)

Test Date: Feb. 29, 2008 Temperature: 20 Humidity: 60% Atmospheric pressure: 1008 hPa

Channel	Frequency (MHz)	20dB Bandwidth (KHz)
00	2402	796.00
39	2441	800.00
78	2480	796.00

Modulation Standard: $\pi/4$ -DQPSK (2Mbps)

Test Date: May. 12, 2008 Temperature: 24 Humidity: 64% Atmospheric pressure: 1008 hPa

Channel	Frequency (MHz)	20dB Bandwidth (KHz)
00	2402	1294.00
39	2441	1222.00
78	2480	1250.00

Modulation Standard: GFSK (1Mbps)

Test Date: Apr. 28, 2007 Temperature: 22 Humidity: 62% Atmospheric pressure: 1008 hPa

Channel	Frequency (MHz)	20dB Bandwidth (KHz)
00	2402	1264.00
39	2441	1272.00
78	2480	1260.00

Modulation Standard: GFSK (1Mbps)
 Channel: 00

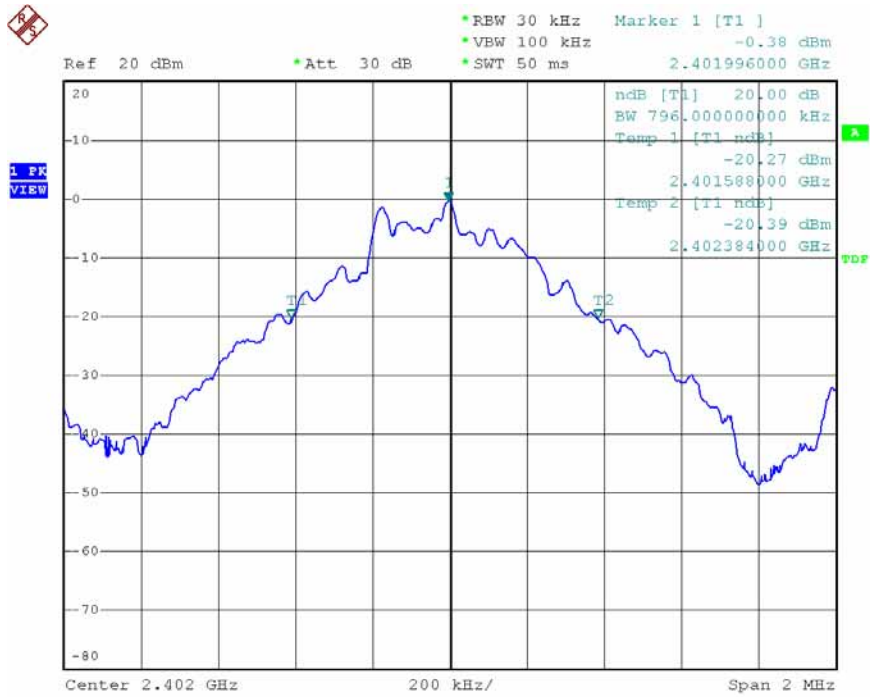

Date: 29.FEB.2008 16:17:29

Modulation Standard: GFSK (1Mbps)
 Channel: 39

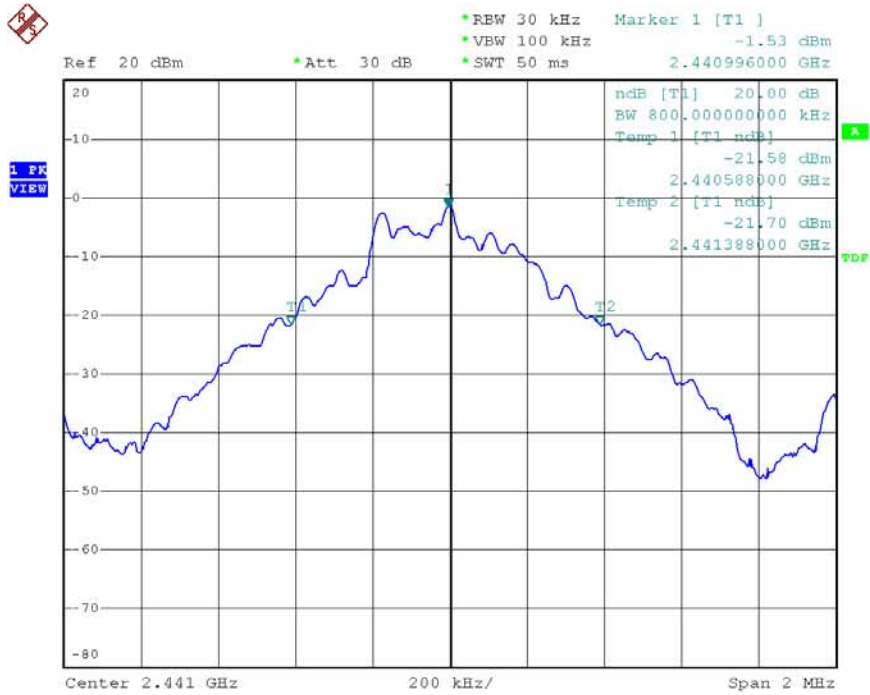

Date: 29.FEB.2008 16:19:49

Modulation Standard: GFSK (1Mbps)
 Channel: 78

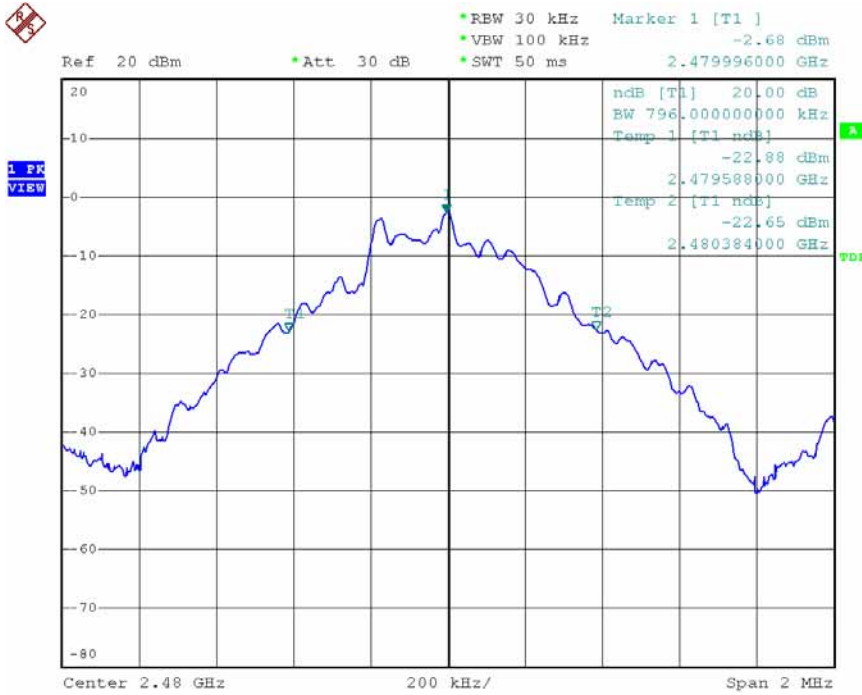

Date: 29.FEB.2008 16:22:43

Modulation Standard: $\pi/4$ -DQPSK (2Mbps)
 Channel: 00

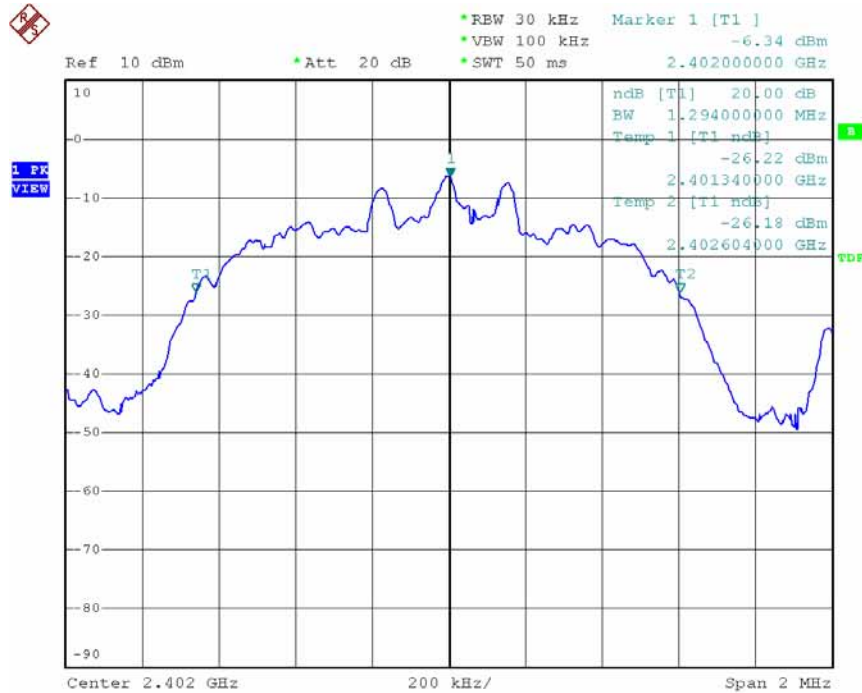

Date: 12.MAY.2008 15:11:22

Modulation Standard: $\pi/4$ -DQPSK (2Mbps)
 Channel: 39

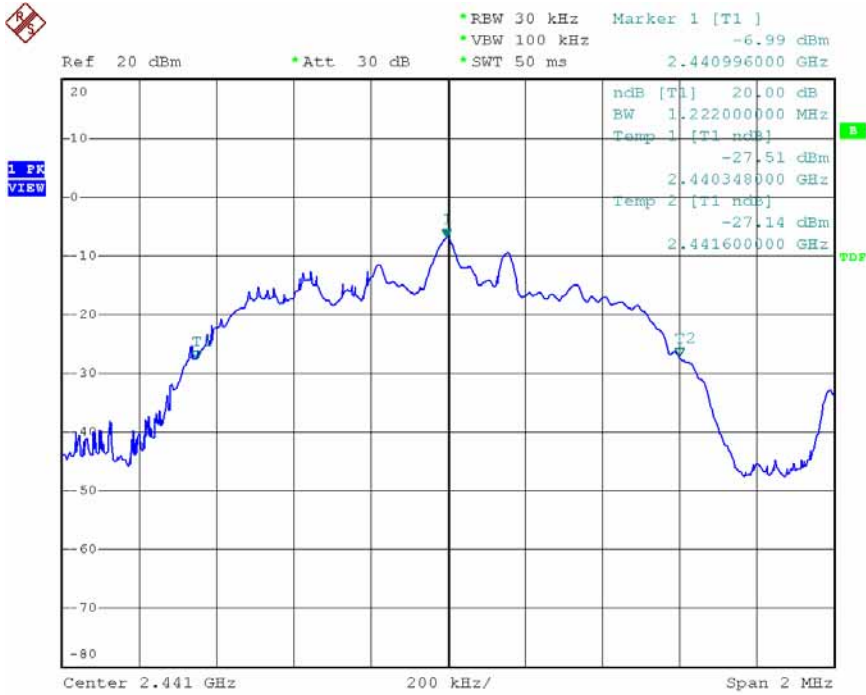

Date: 12.MAY.2008 13:50:49

Modulation Standard: $\pi/4$ -DQPSK (2Mbps)
 Channel: 78

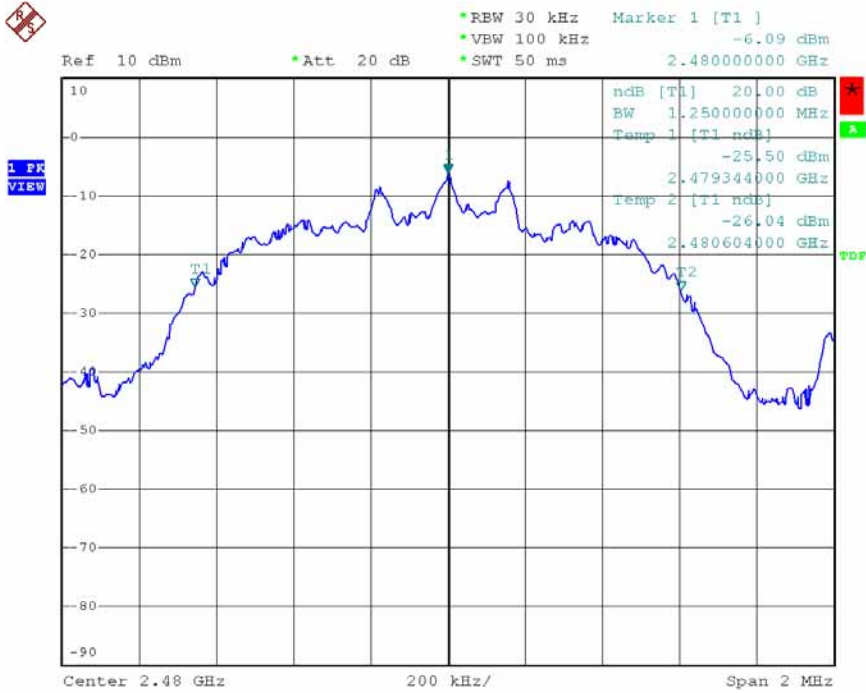

Date: 12.MAY.2008 17:17:17

Modulation Standard: 8DPSK (3Mbps)
 Channel: 00

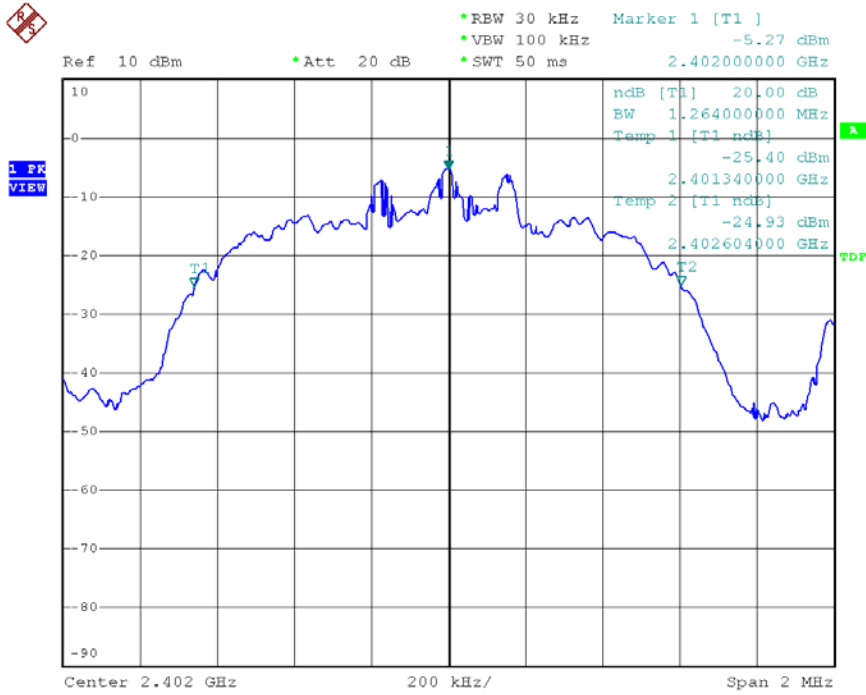

Date: 28.APR.2008 17:13:55

Modulation Standard: 8DPSK (3Mbps)
 Channel: 39

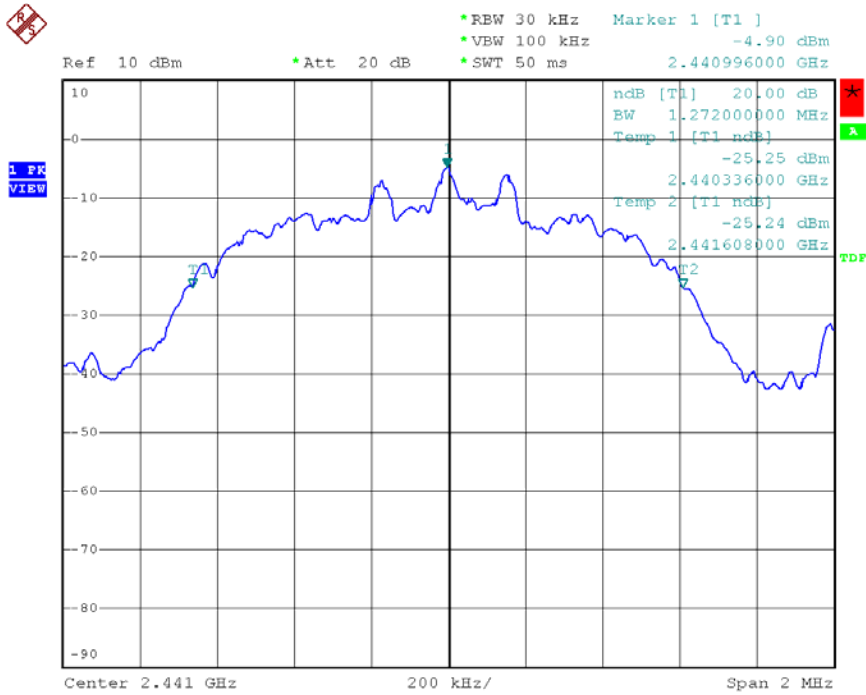

Date: 28.APR.2008 17:15:27

Modulation Standard: 8DPSK (3Mbps)
 Channel: 78

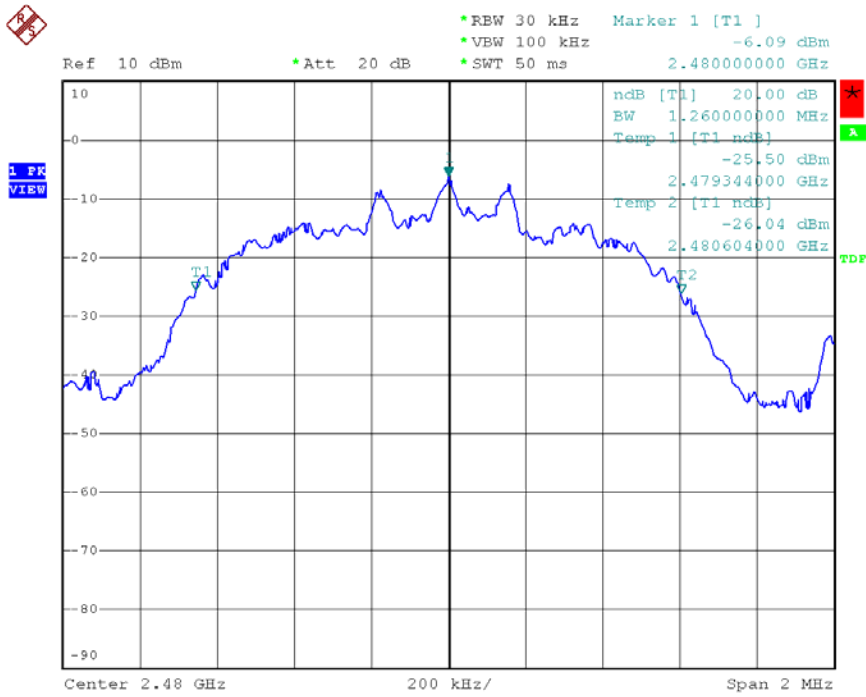

Date: 28.APR.2008 17:17:17

7. Frequencies Separation

7.1 Test Limit

Frequency hopping systems shall have hopping channel carrier frequencies separated by a minimum of 25 kHz or the 20 dB bandwidth of the hopping channel, whichever is greater.

7.2 Test Procedures

- The transmitter output was connected to the spectrum analyzer.
- Set RBW of spectrum analyzer to 100 KHz and VBW to 100 KHz.
- By using the MaxHold function record the separation of two adjacent channels.
- Measure the frequency difference of these two adjacent channels.

7.3 Test Setup Layout

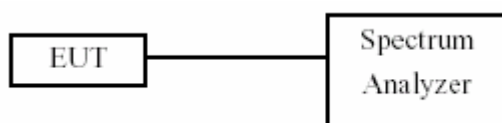

7.4 Measurement equipment

Instrument/Ancillary	Model No.	Manufacturer	Serial No.	Calibration Date	Valid Date
Spectrum Analyzer	FSP40	R&S	10047	2008/02/22	2009/02/21

7.5 Test Result and Data

Modulation Standard: GFSK (1Mbps)

Test Date: Feb. 29, 2008 Temperature: 20 Humidity: 60% Atmospheric pressure: 1008 hPa

Channel	Frequency (MHz)	Channel Separation (MHz)	Minimum Limit (MHz)
00	2402	1.004	0.531
39	2441	1.004	0.533
78	2480	1.000	0.531

Modulation Standard: $\pi/4$ -DQPSK (2Mbps)

Test Date: May. 12, 2008 Temperature: 24 Humidity: 64% Atmospheric pressure: 1008 hPa

Channel	Frequency (MHz)	Channel Separation (MHz)	Minimum Limit (MHz)
00	2402	1.002	0.863
39	2441	1.004	0.815
78	2480	1.000	0.833

Modulation Standard: 8DPSK (3Mbps)

Test Date: Apr. 28, 2008 Temperature: 22 Humidity: 62% Atmospheric pressure: 1008 hPa

Channel	Frequency (MHz)	Channel Separation (MHz)	Minimum Limit (MHz)
00	2402	1.008	0.843
39	2441	0.996	0.848
78	2480	1.008	0.840

Modulation Standard: GFSK (1Mbps)
 Channel: 00

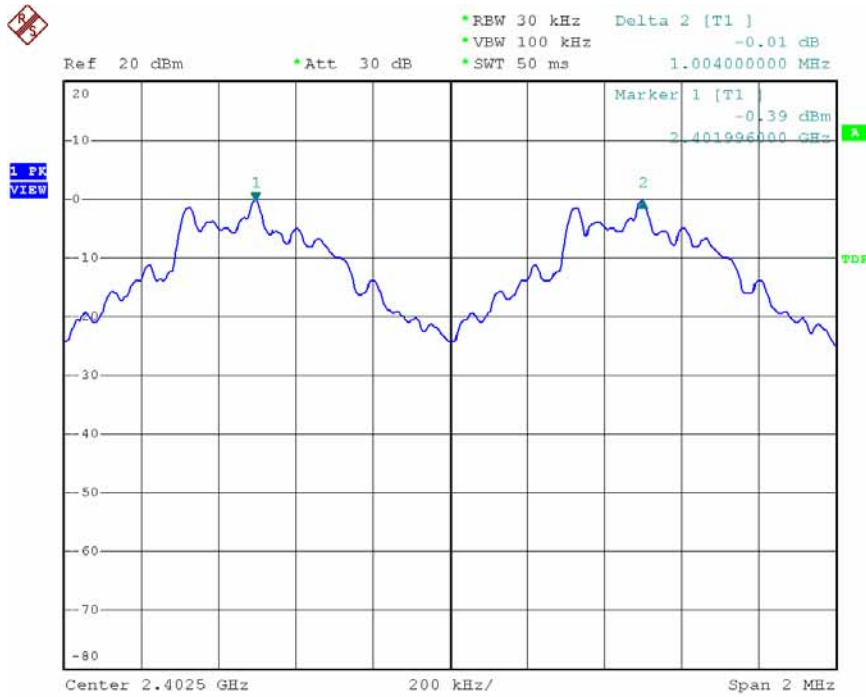

Date: 29.FEB.2008 16:02:16

Modulation Standard: GFSK (1Mbps)
 Channel: 39

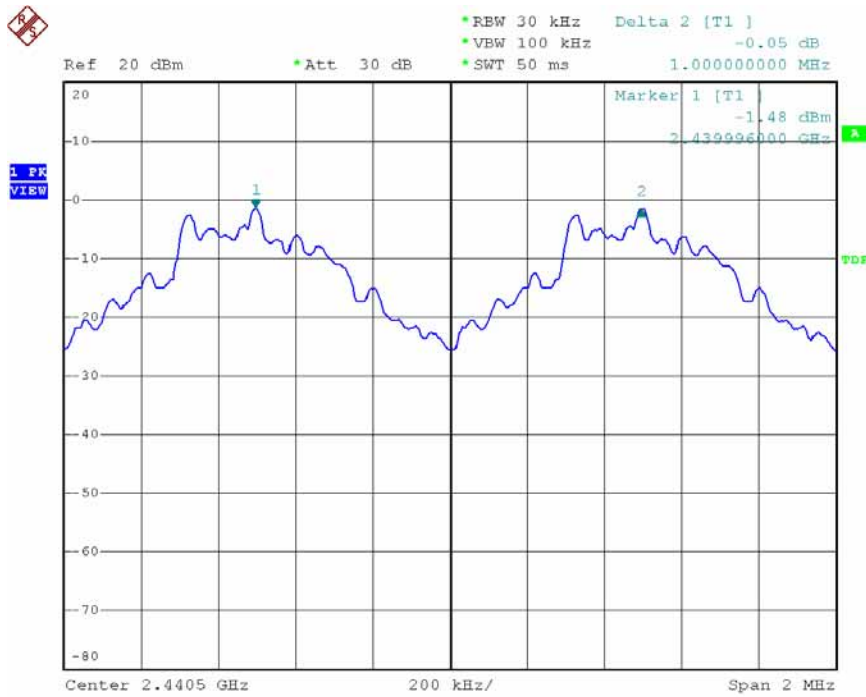

Date: 29.FEB.2008 16:10:48

Modulation Standard: GFSK (1Mbps)
 Channel: 78

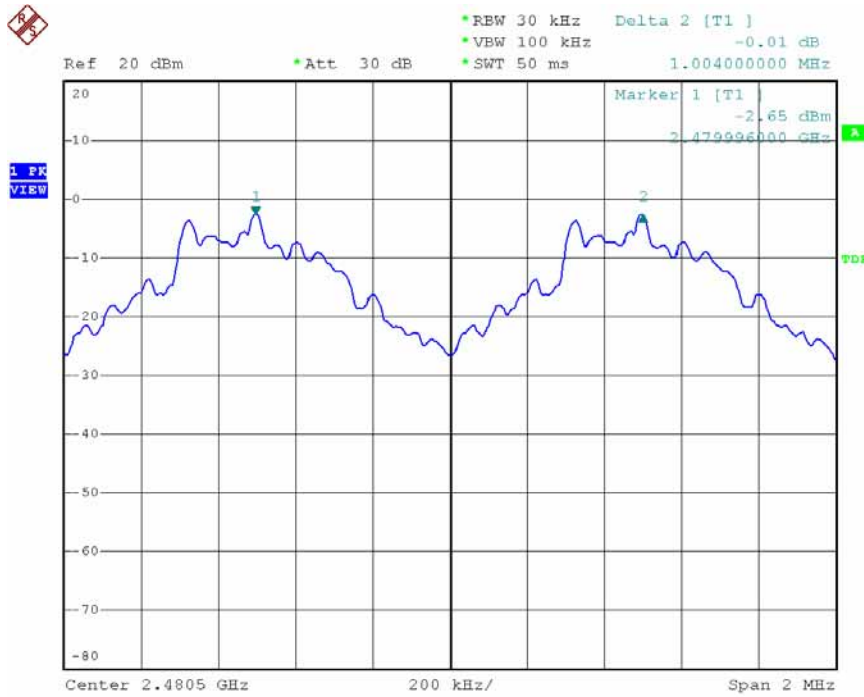

Date: 29.FEB.2008 16:12:14

Modulation Standard: $\pi/4$ -DQPSK (2Mbps)
 Channel: 00

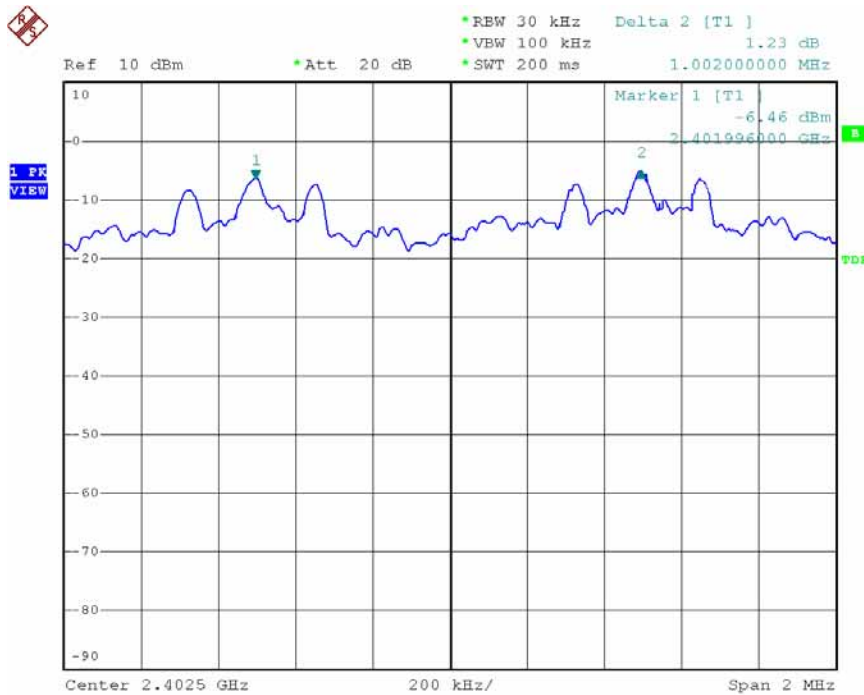

Date: 12.MAY.2008 14:57:00

Modulation Standard: $\pi/4$ -DQPSK (2Mbps)
 Channel: 39

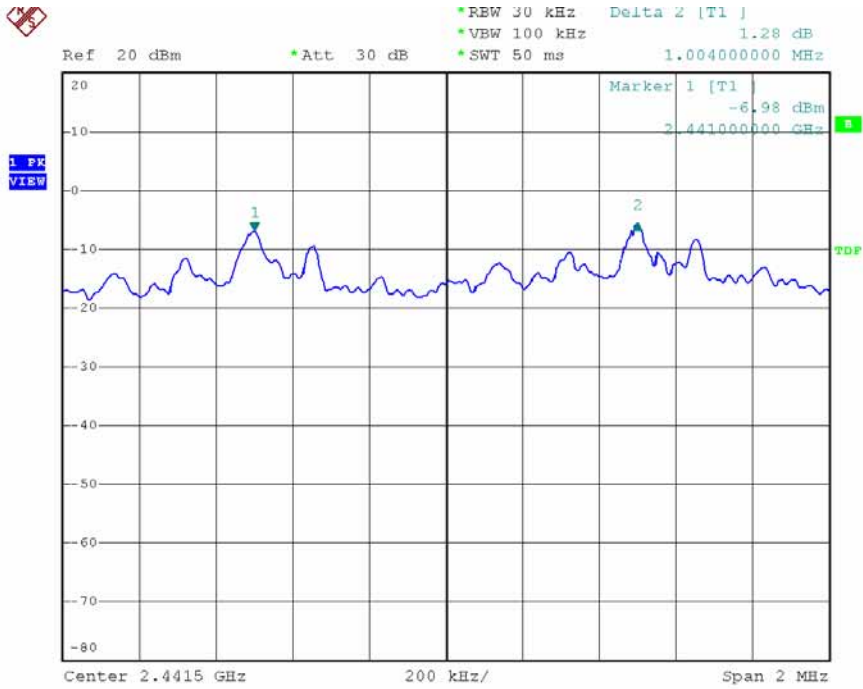

Date: 12.MAY.2008 13:29:30

Modulation Standard: $\pi/4$ -DQPSK (2Mbps)
 Channel: 78

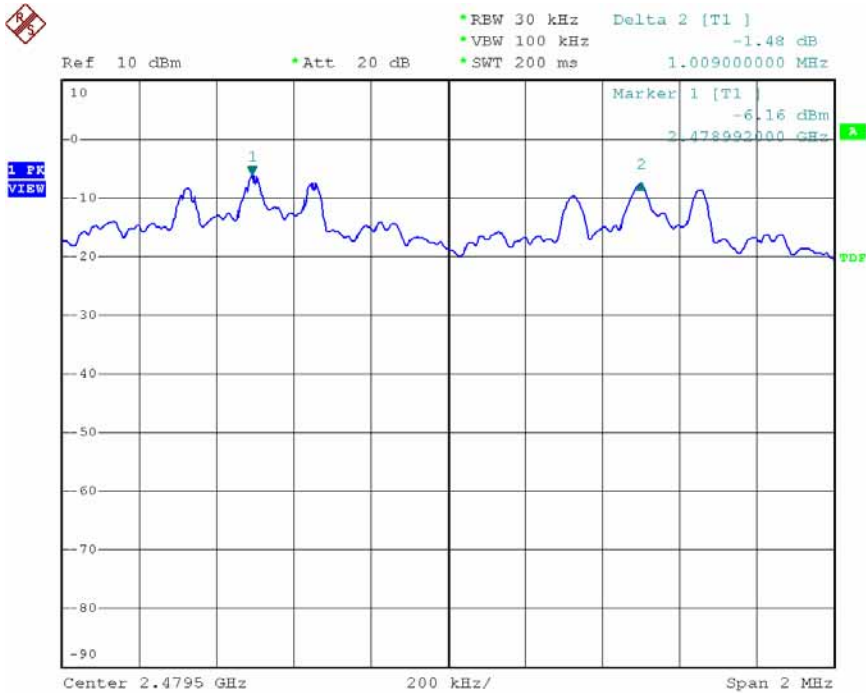

Date: 28.APR.2008 16:55:36

Modulation Standard: 8DQPSK (3Mbps)
 Channel: 00

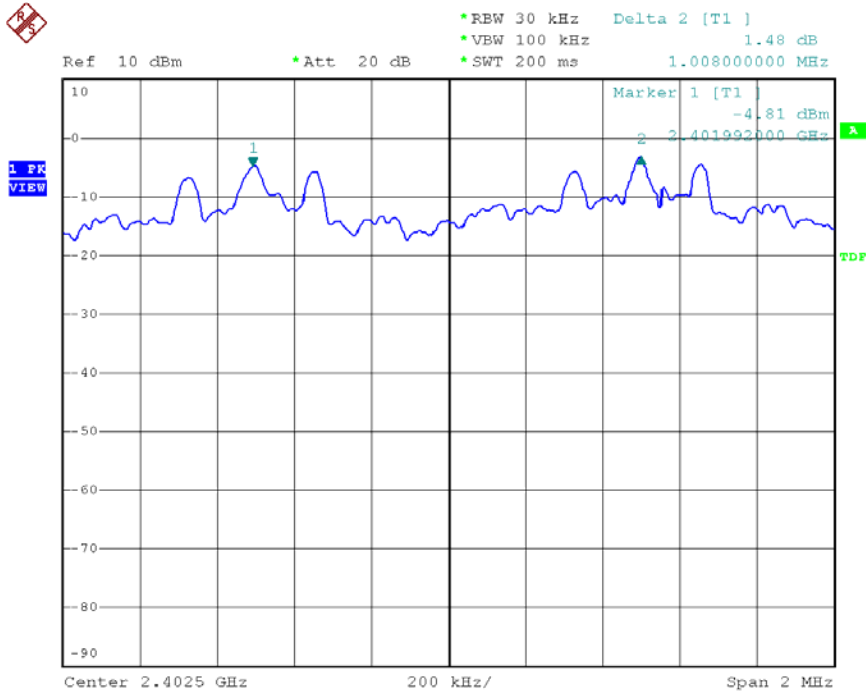

Date: 28.APR.2008 16:48:42

Modulation Standard: 8DQPSK (3Mbps)
 Channel: 39

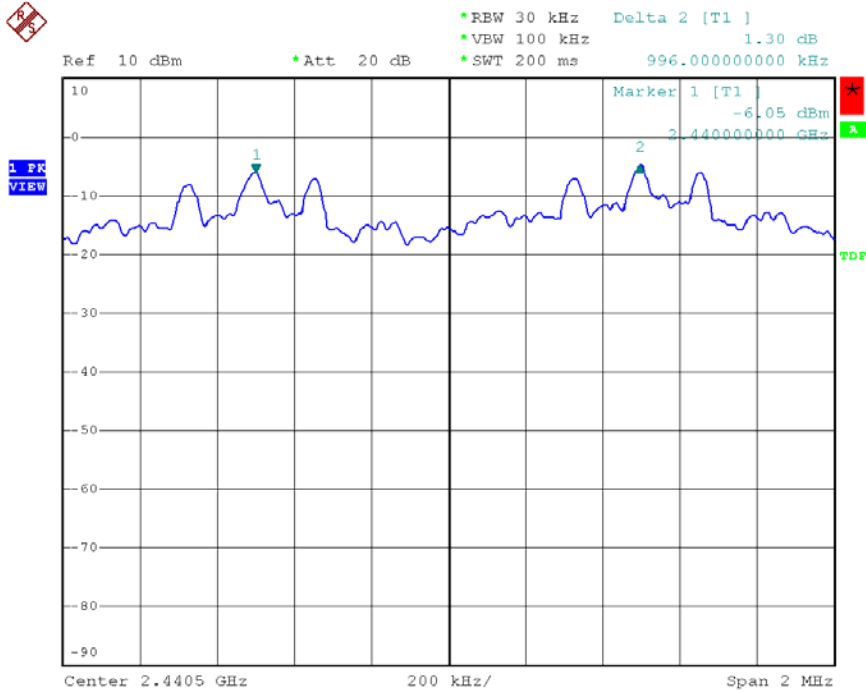

Date: 28.APR.2008 16:50:19

Modulation Standard: 8DQPSK (3Mbps)
Channel: 78

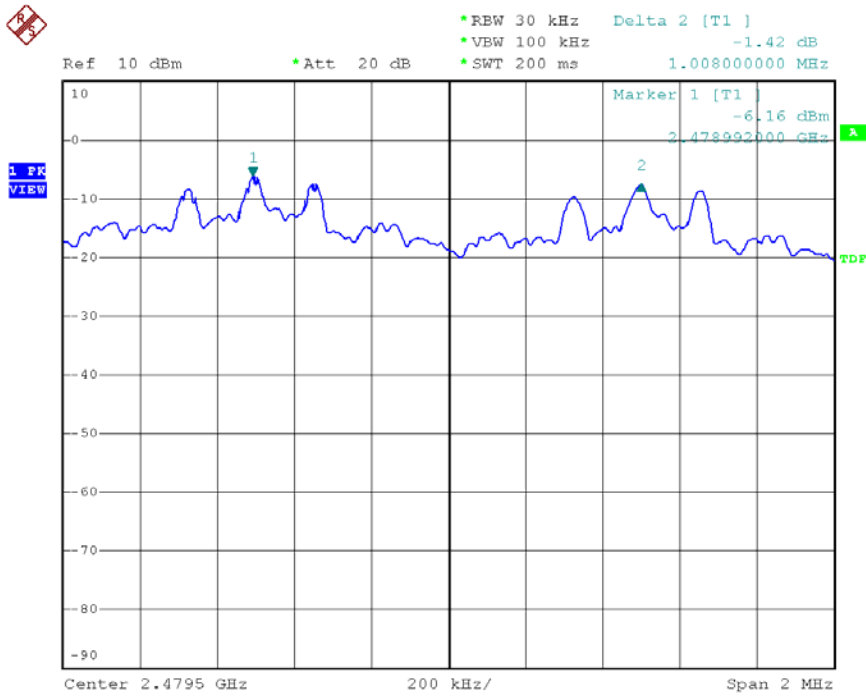

Date: 28.APR.2008 16:55:36

8. Dwell Time on each channel

8.1 Test Limit

The average time of occupancy on any channel shall not be greater than 0.4 seconds within a period of 0.4 seconds multiplied by the number of hopping channels employed.

8.2 Test Procedures

1. The transmitter output was connected to the spectrum analyzer.
2. Adjust the center frequency to measure frequency, then set zero span mode.
2. Set RBW of spectrum analyzer to 100 KHz and VBW to 100 KHz.
4. Measure the time duration of one transmission on the measured frequency.

8.3 Test Setup Layout

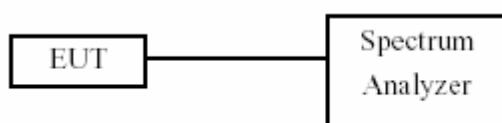

8.4 Measurement equipment

Instrument/Ancillary	Model No.	Manufacturer	Serial No.	Calibration Date	Valid Date
Spectrum Analyzer	FSP40	R&S	10047	2008/02/22	2009/02/21

8.5 Test Result and Data

Modulation Standard: GFSK (1Mbps)

Test Date: Feb. 29, 2008 Temperature: 20 Humidity: 60% Atmospheric pressure: 1008 hPa

Test Period = 0.4 (second/ channel) x 79 Channel = 31.6 sec

- a) 2402 MHz Dwell Time is = 0.414ms x $\frac{31.6}{3.16}$ x 32 = 132.48ms
- b) 2441 MHz Dwell Time is = 0.414ms x $\frac{31.6}{3.16}$ x 32 = 132.48ms
- c) 2480 MHz Dwell Time is = 0.434ms x $\frac{31.6}{3.16}$ x 32 = 130.56ms

Modulation Standard: $\pi/4$ -DQPSK (2Mbps)

Test Date: May. 12, 2008 Temperature: 24 Humidity: 64% Atmospheric pressure: 1008 hPa

Test Period = 0.4 (second/ channel) x 79 Channel = 31.6 sec

- a) 2402 MHz Dwell Time is = 2.944ms x $\frac{31.6}{3.16}$ x 11 = 323.84ms
- b) 2441 MHz Dwell Time is = 2.936ms x $\frac{31.6}{3.16}$ x 11 = 322.96ms
- c) 2480 MHz Dwell Time is = 2.944ms x $\frac{31.6}{3.16}$ x 11 = 323.84ms

Modulation Standard: 8DPSK (3Mbps)

Test Date: Apr. 28, 2008 Temperature: 22 Humidity: 62% Atmospheric pressure: 1008 hPa

Test Period = 0.4 (second/ channel) x 79 Channel = 31.6 sec

- a) 2402 MHz Dwell Time is = 2.944ms x $\frac{31.6}{3.16}$ x 11 = 323.84ms
- b) 2441 MHz Dwell Time is = 2.952ms x $\frac{31.6}{3.16}$ x 11 = 324.94ms
- c) 2480 MHz Dwell Time is = 2.944ms x $\frac{31.6}{3.16}$ x 11 = 323.84ms

Modulation Standard: GFSK (1Mbps)
 Channel: 00

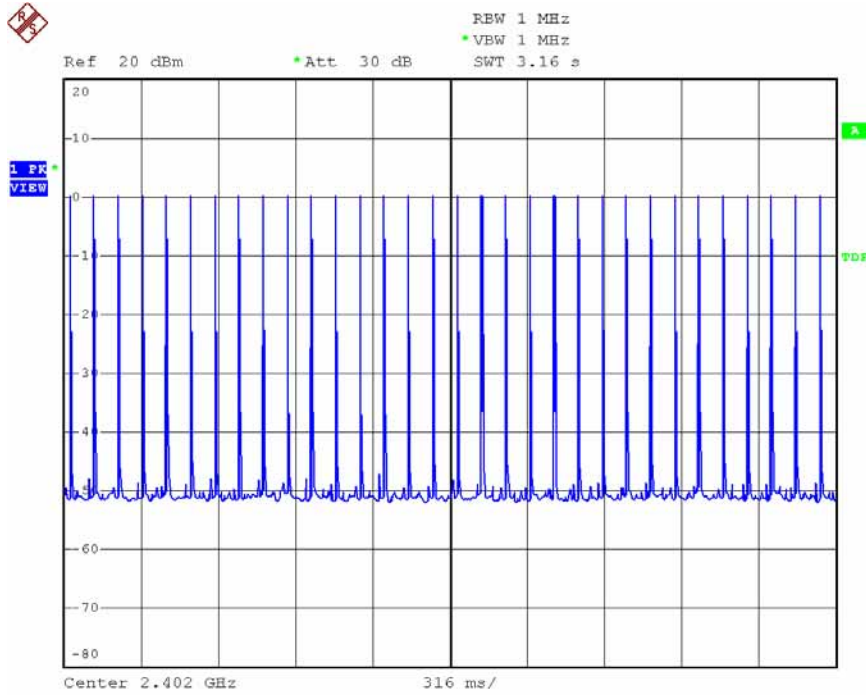

Date: 29.FEB.2008 17:03:06

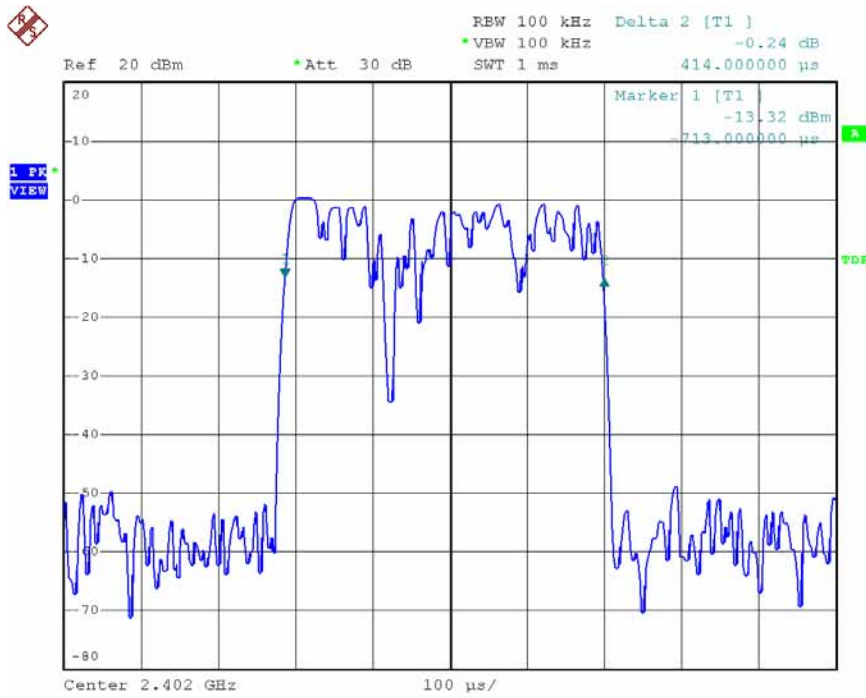

Date: 29.FEB.2008 17:00:41

Modulation Standard: GFSK (1Mbps)
 Channel: 39

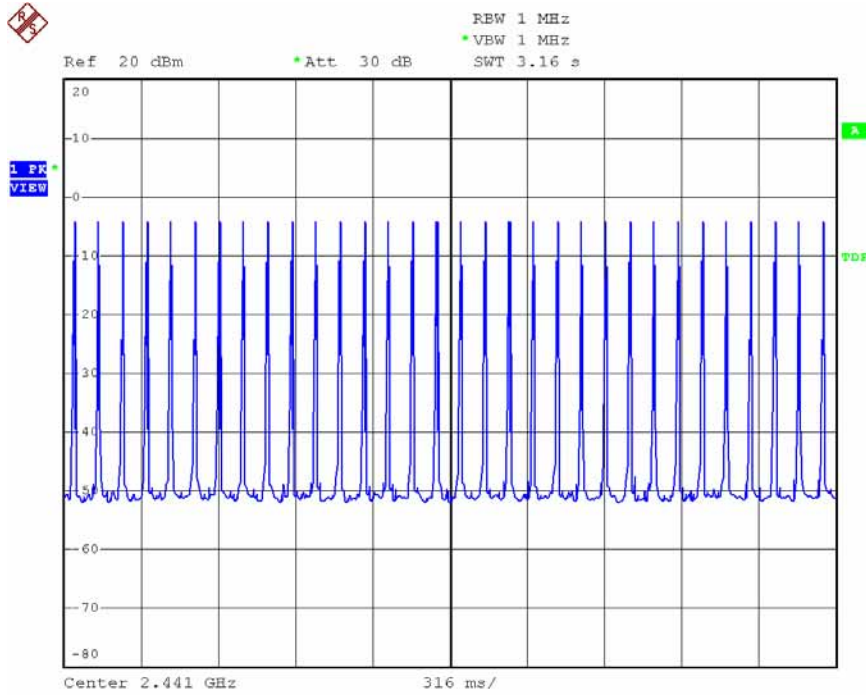

Date: 29.FEB.2008 17:12:56

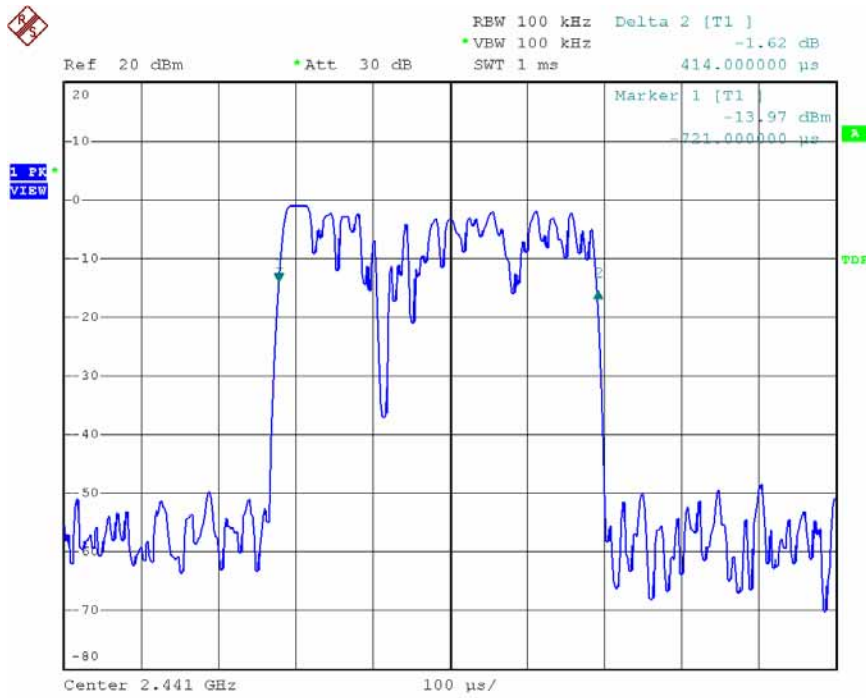

Date: 29.FEB.2008 17:06:51

Modulation Standard: GFSK (1Mbps)
 Channel: 78

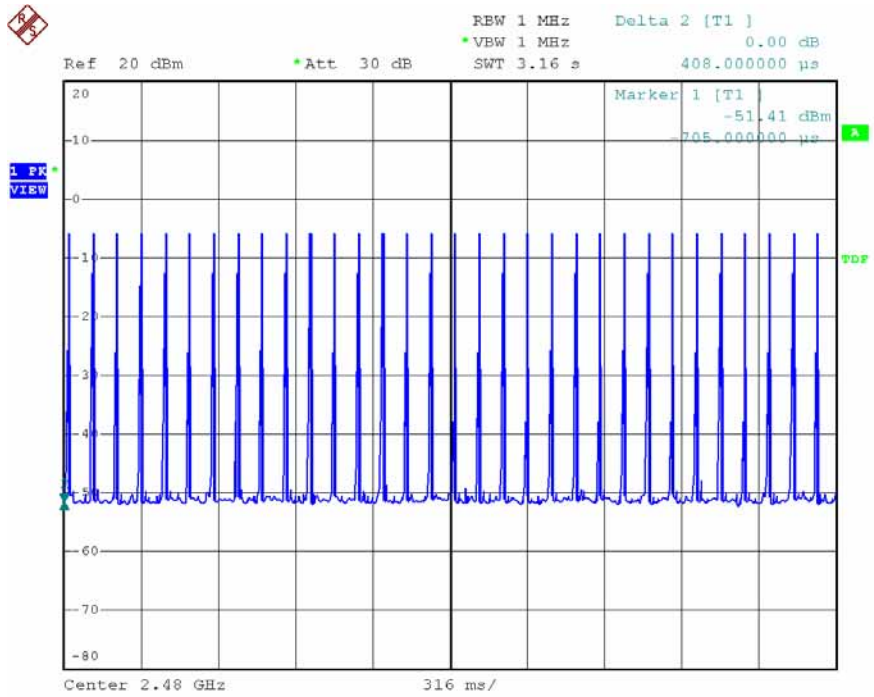

Date: 29.FEB.2008 17:18:55

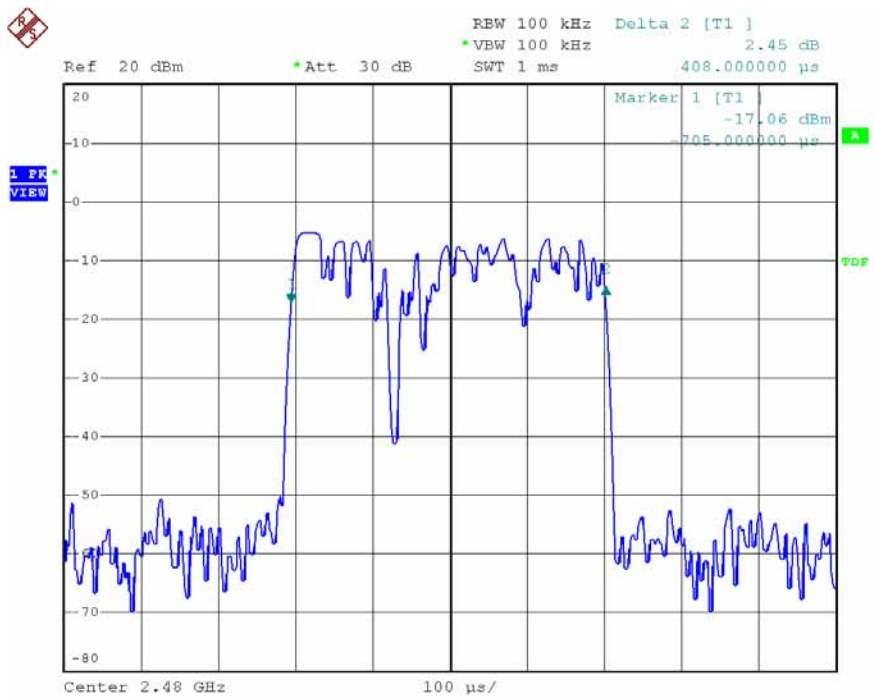

Date: 29.FEB.2008 17:18:23

Modulation Standard: $\pi/4$ -DQPSK (2Mbps)
 Channel: 00

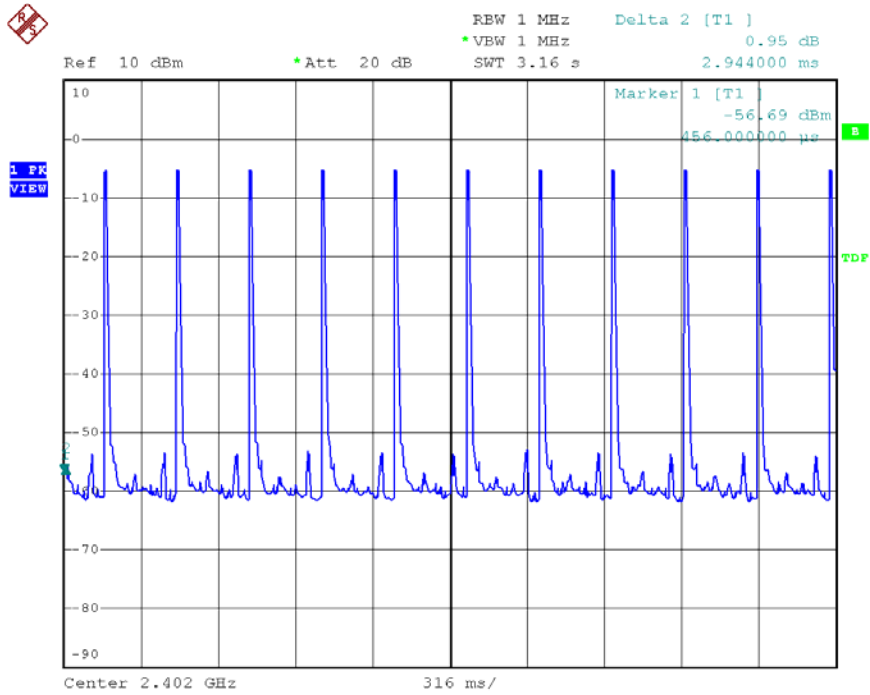

Date: 12.MAY.2008 15:05:42

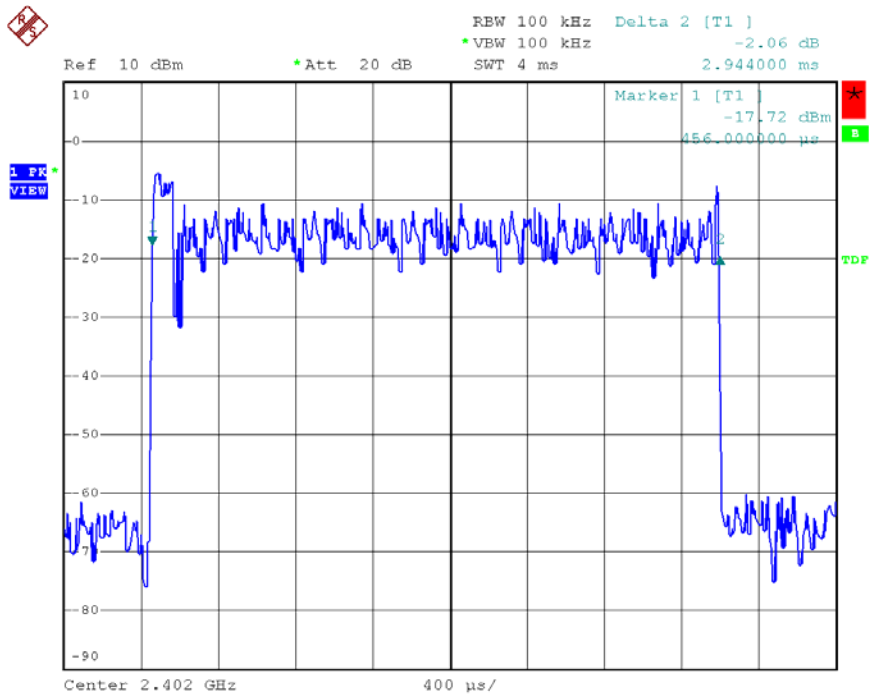

Date: 12.MAY.2008 15:02:52

Modulation Standard: $\pi/4$ -DQPSK (2Mbps)
Channel: 39

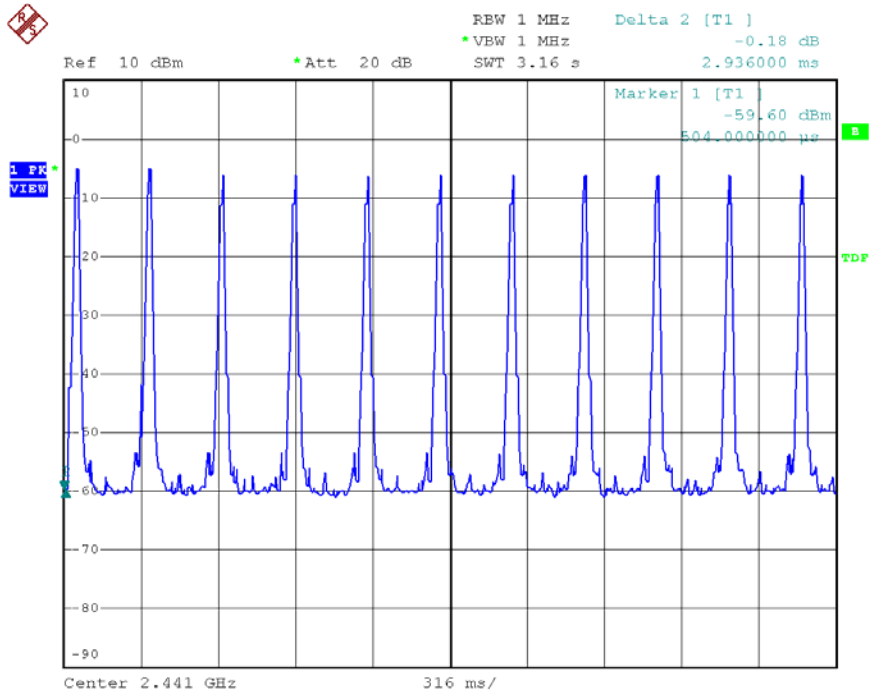

Date: 12.MAY.2008 14:47:04

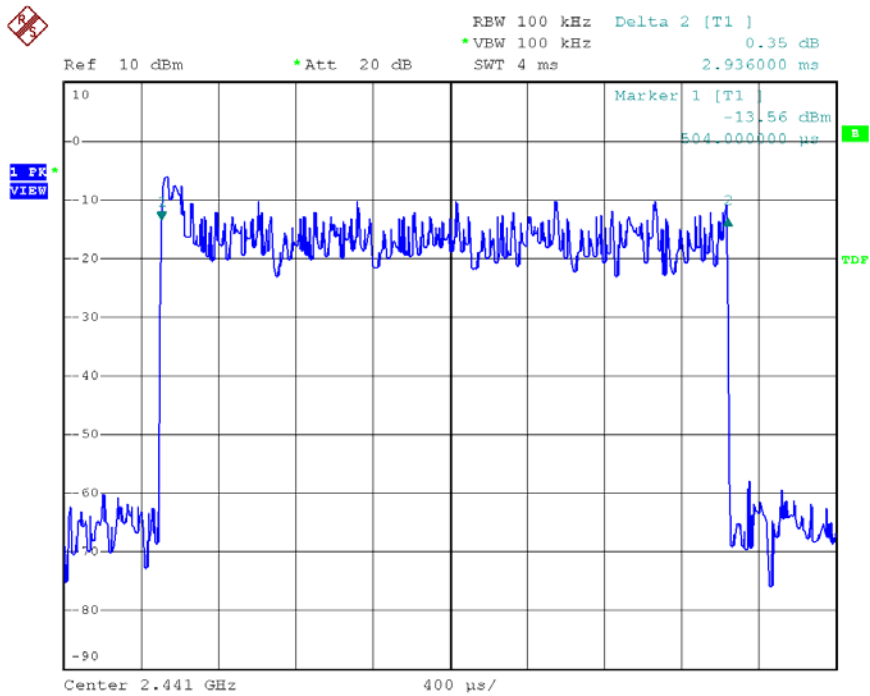

Date: 12.MAY.2008 14:46:18

Modulation Standard: $\pi/4$ -DQPSK (2Mbps)
 Channel: 78

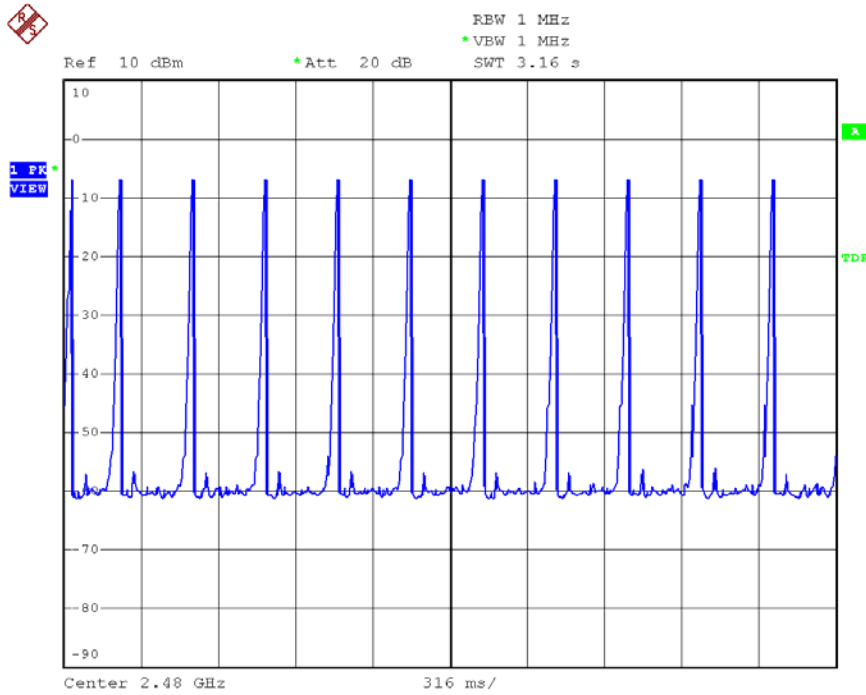

Date: 28.APR.2008 17:12:01

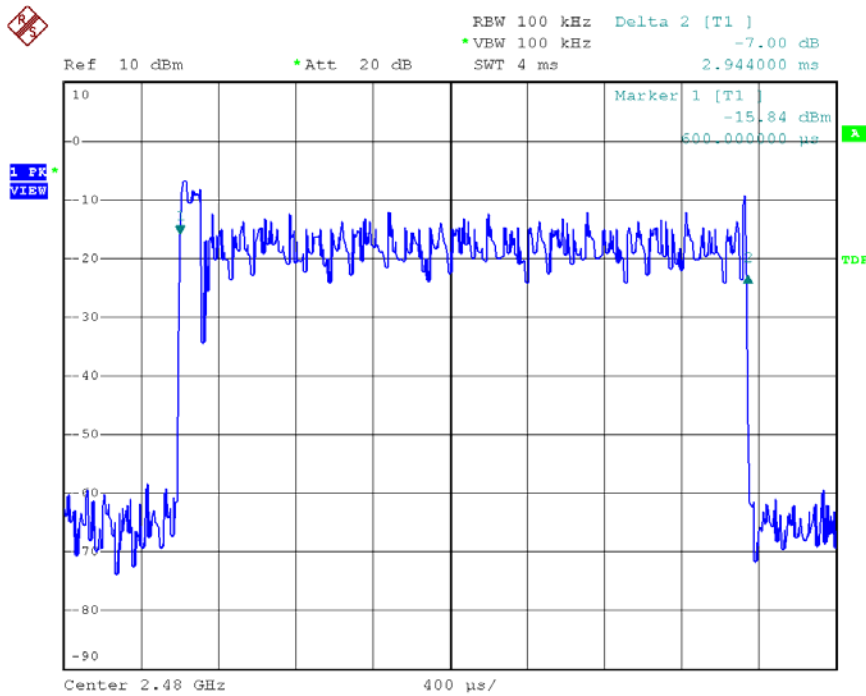

Date: 28.APR.2008 17:10:52

Modulation Standard: 8DPSK (3Mbps)
 Channel: 00

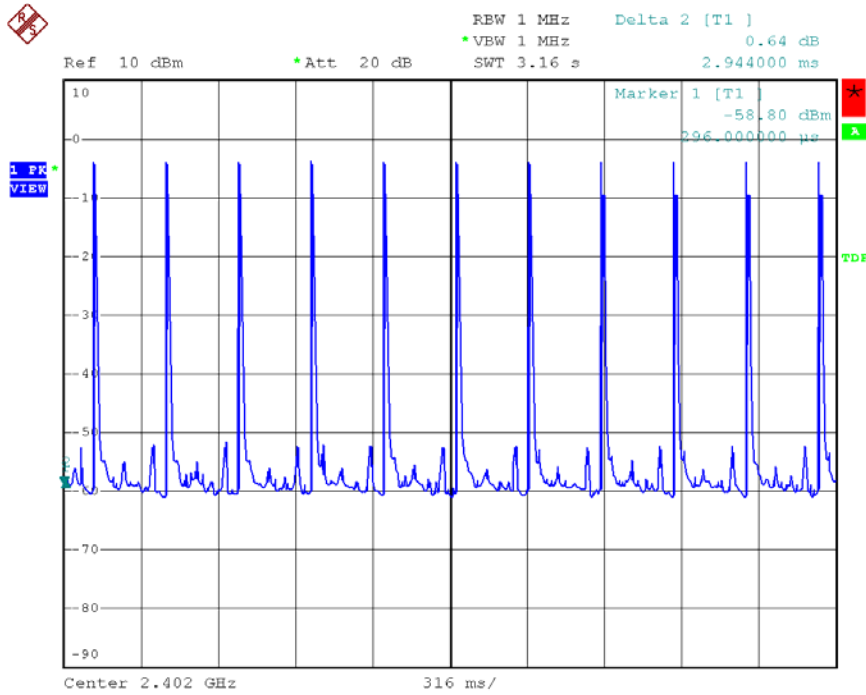

Date: 28.APR.2008 17:03:59

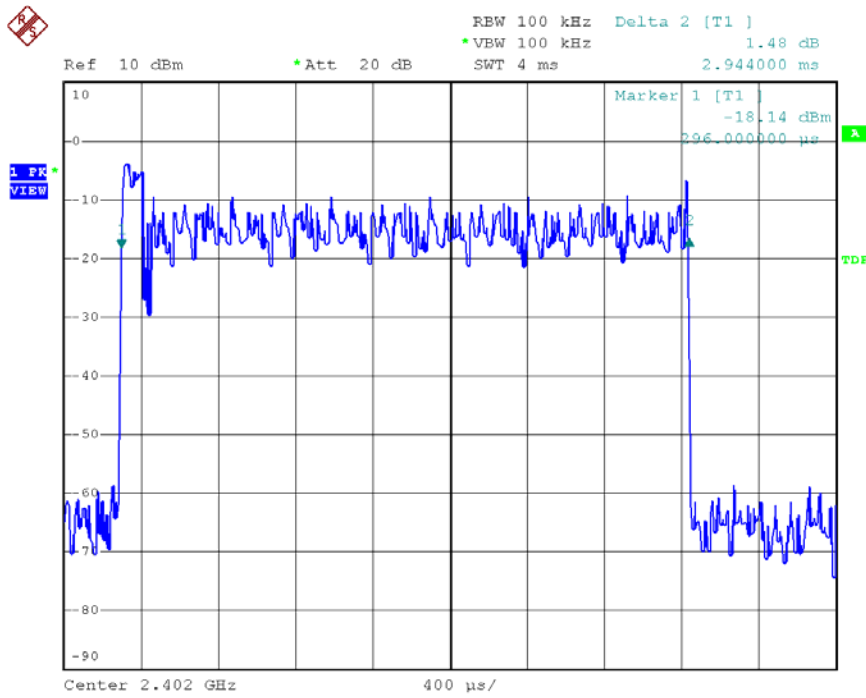

Date: 28.APR.2008 17:02:25

Modulation Standard: 8DPSK (3Mbps)
 Channel: 39

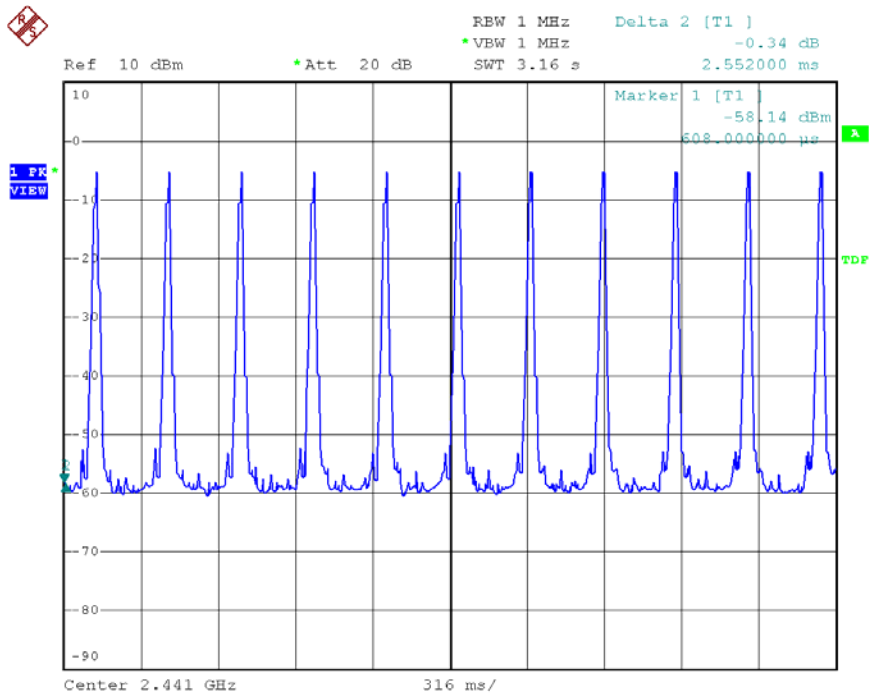

Date: 28.APR.2008 17:09:26

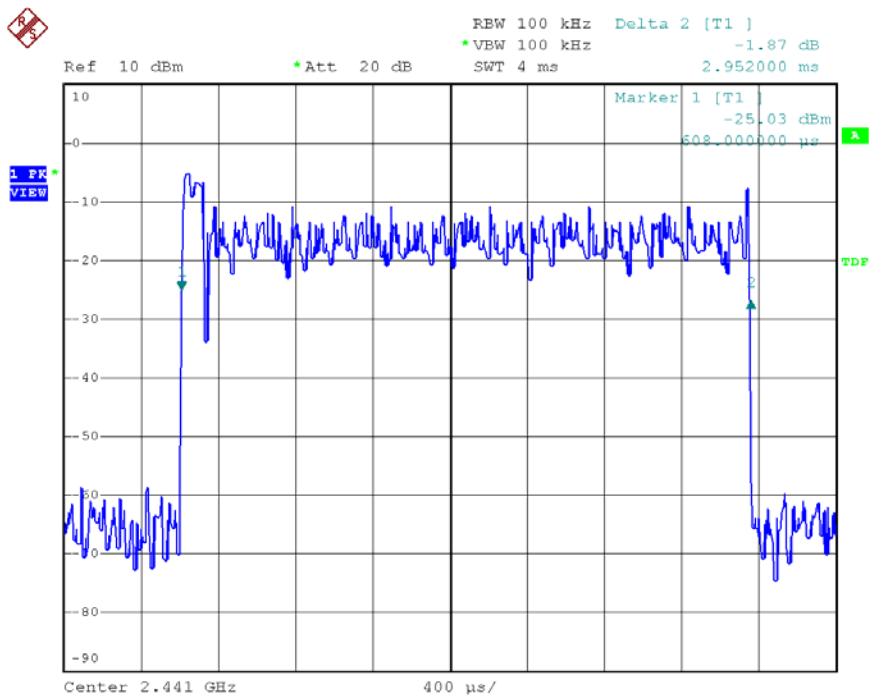

Date: 28.APR.2008 17:08:04

Modulation Standard: 8DPSK (3Mbps)
Channel: 78

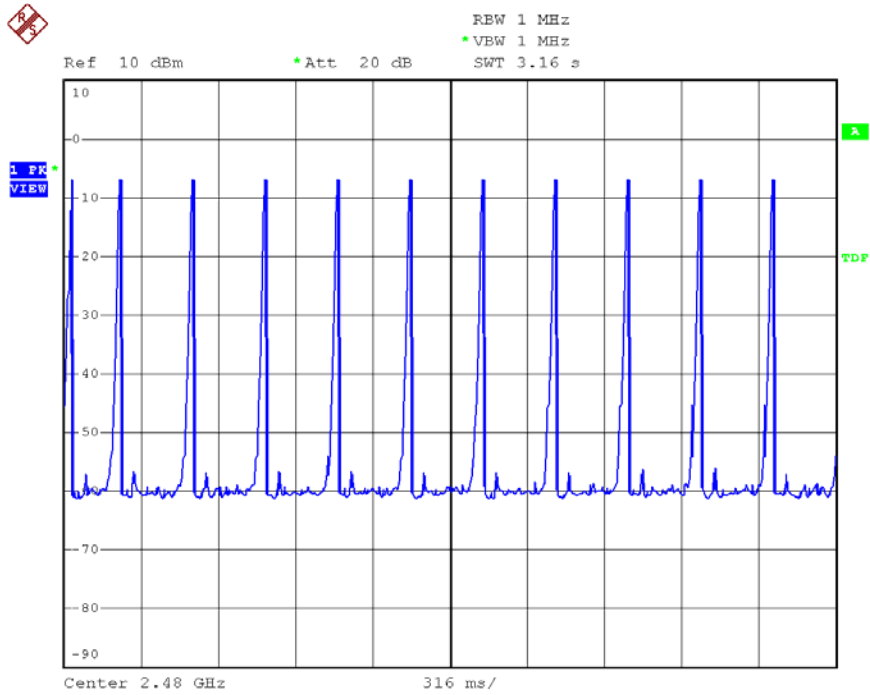

Date: 28.APR.2008 17:12:01

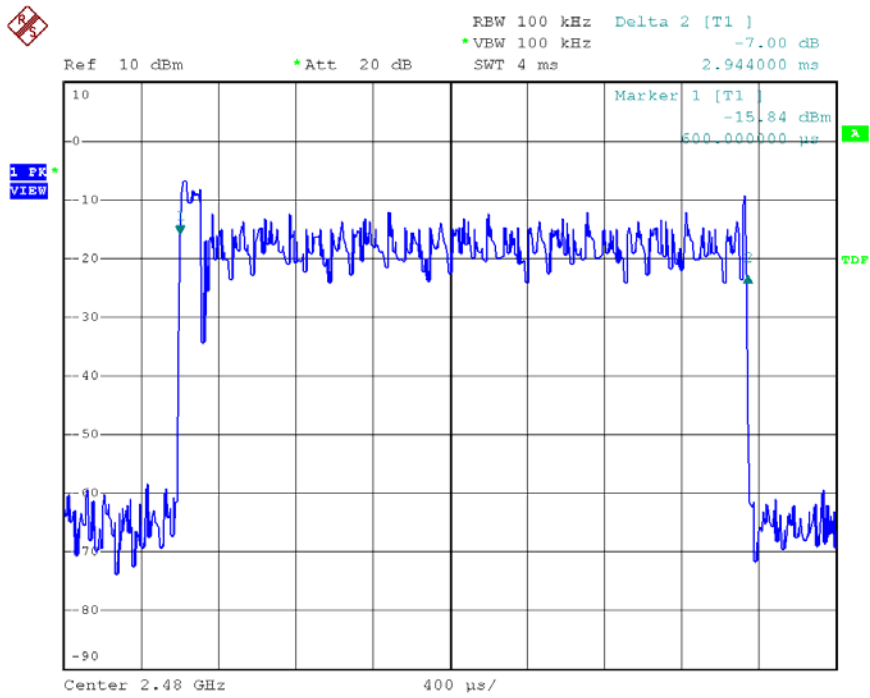

Date: 28.APR.2008 17:10:52

9. Number of Hopping Channels

9.1 Test Limit

Frequency hopping systems in the 2400 ~ 2483.5 MHz band shall use at least 15 channels.

9.2 Test Procedures

- a. The transmitter output was connected to the spectrum analyzer.
- b. 2. Set RBW of spectrum analyzer to 100 KHz and VBW to 100 KHz.
- c. 3. Set the MaxHold function, and then keep the EUT in hopping mode. Record all the signals from each channel until each one has been record.

9.3 Test Setup Layout

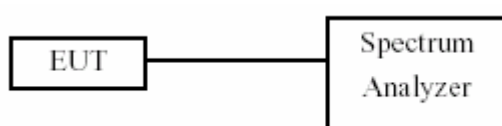

9.4 Measurement equipment

Instrument/Ancillary	Model No.	Manufacturer	Serial No.	Calibration Date	Valid Date
Spectrum Analyzer	FSP40	R&S	10047	2008/02/22	2009/02/21

9.5 Test Result and Data

Modulation Standard: GFSK (1Mbps)

Test Date: Feb. 29, 2008 Temperature: 20 Humidity: 60% Atmospheric pressure: 1008 hPa

Number of hopping channels: 79 Channels

Modulation Standard: $\pi/4$ -DQPSK (2Mbps)

Test Date: May. 12, 2008 Temperature: 24 Humidity: 64% Atmospheric pressure: 1008 hPa

Number of hopping channels: 79 Channels

Modulation Standard: 8DPSK (3Mbps)

Test Date: Apr. 28, 2008 Temperature: 22 Humidity: 62% Atmospheric pressure: 1008 hPa

Number of hopping channels: 79 Channels

Modulation Standard: GFSK (1Mbps)

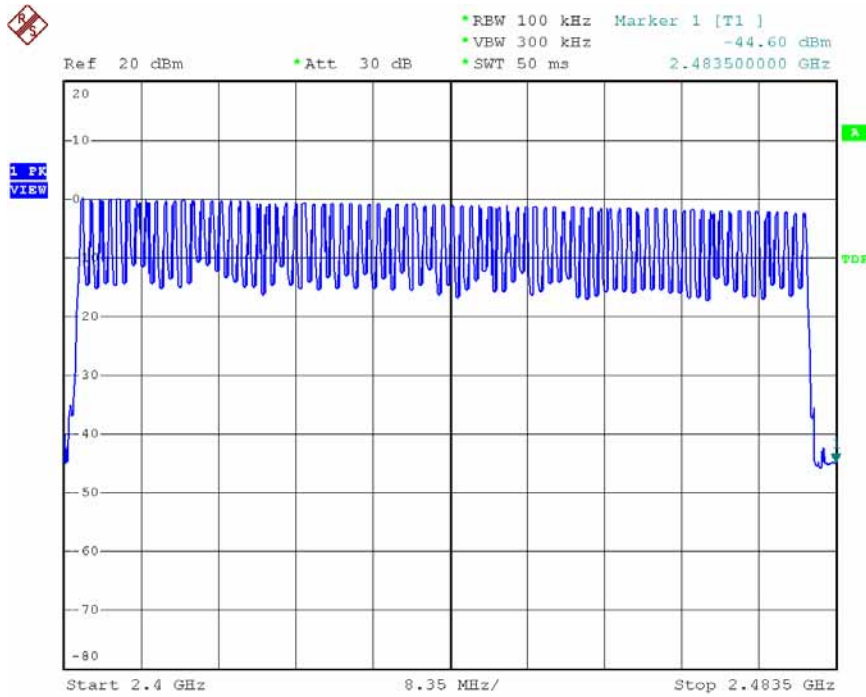

Date: 29.FEB.2008 16:55:31

Modulation Standard: $\pi/4$ -DQPSK (2Mbps)

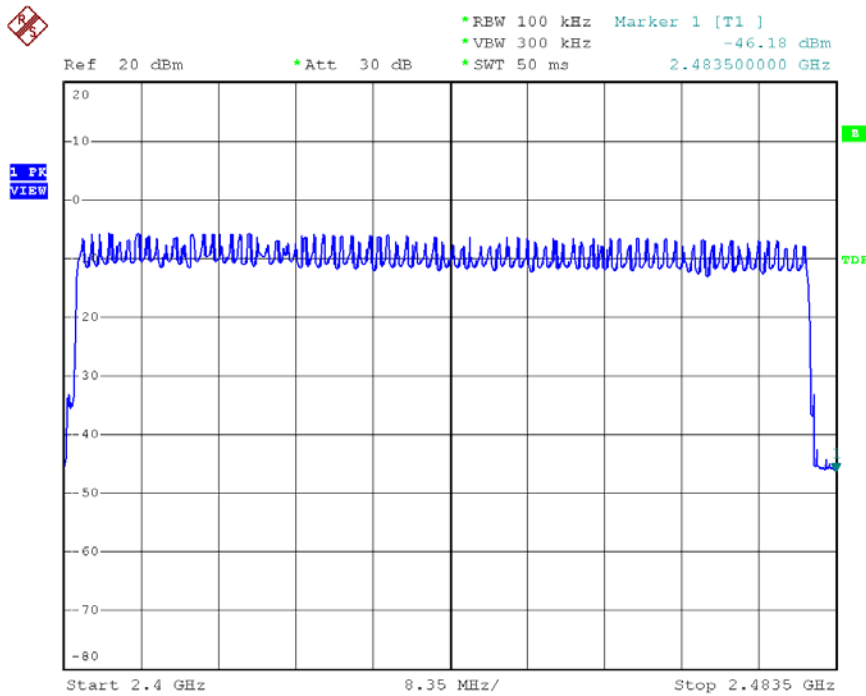

Date: 12.MAY.2008 15:21:59

Modulation Standard: 8DPSK (3Mbps)

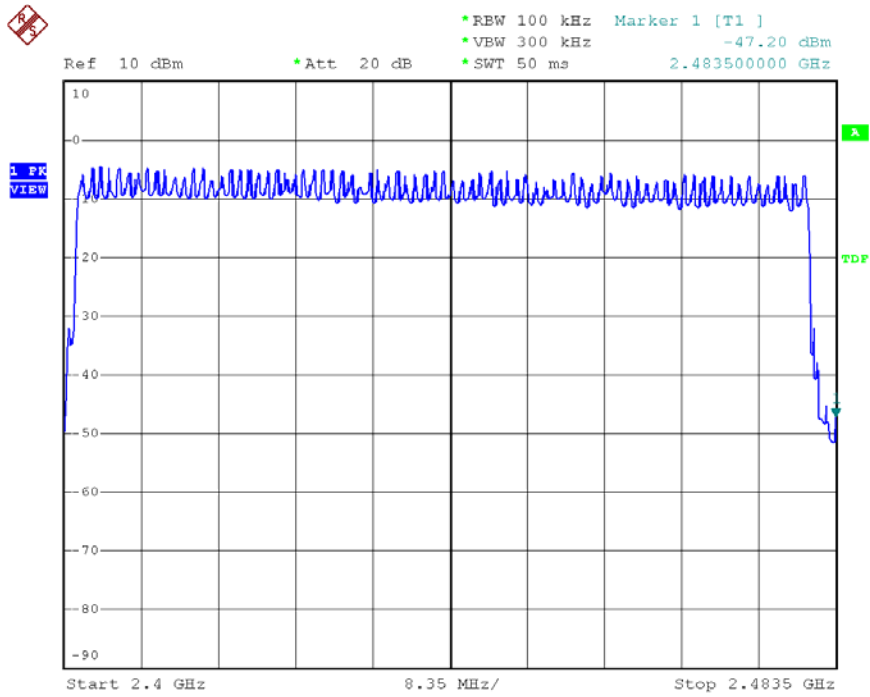

Date: 28.APR.2008 18:32:13

10. Maximum Peak Output Power

10.1 Test Limit

The Maximum Peak Output Power Measurement is 30dBm.

10.2 Test Procedures

The antenna port(RF output)of the EUT was connected to the input(RF input)of a power meter. Power was read directly from the meter and cable loss connection was added to the reading to obtain power at the EUT antenna terminal. The EUT Output Power was set to maximum to produce the worse case test result.

10.3 Test Setup Layout

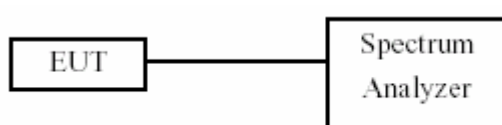

10.4 Measurement equipment

Instrument/Ancillary	Model No.	Manufacturer	Serial No.	Calibration Date	Valid Date
Spectrum Analyzer	FSP40	R&S	10047	2008/02/22	2009/02/21

10.5 Test Result and Data

Modulation Standard: GFSK (1Mbps)

Test Date: Feb. 29, 2008 Temperature: 20 Humidity: 60% Atmospheric pressure: 1008 hPa

Channel	Frequency (MHz)	Peak Power Output (dBm)	Peak Power Output (mW)
00	2402	-0.04	1.0
39	2441	-0.90	0.8
78	2478	-1.77	0.7

Modulation Standard: $\pi/4$ -DQPSK (2Mbps)

Test Date: May. 12, 2008 Temperature: 24 Humidity: 64% Atmospheric pressure: 1008 hPa

Channel	Frequency (MHz)	Peak Power Output (dBm)	Peak Power Output (mW)
00	2402	-5.13	0.30
39	2441	-5.95	0.30
78	2478	-4.33	0.40

Modulation Standard: 8DPSK (3Mbps)

Test Date: Apr. 28, 2008 Temperature: 22 Humidity: 62% Atmospheric pressure: 1008 hPa

Channel	Frequency (MHz)	Peak Power Output (dBm)	Peak Power Output (mW)
00	2402	-4.32	0.40
39	2441	-3.87	0.40
78	2478	-4.33	0.40

Modulation Standard: GFSK (1Mbps)
Channel: 00

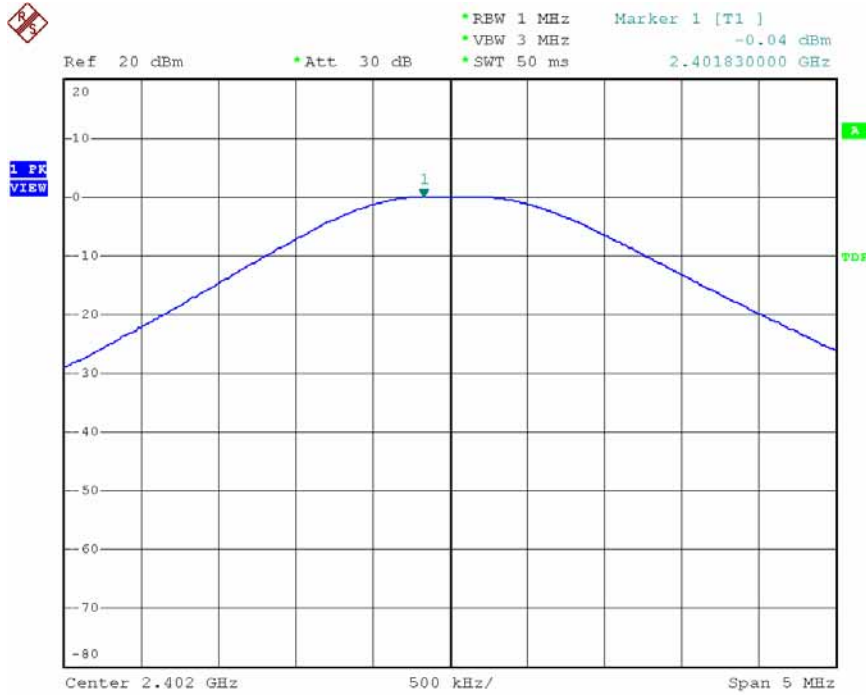

Date: 29.FEB.2008 11:52:42

Modulation Standard: GFSK (1Mbps)
Channel: 39

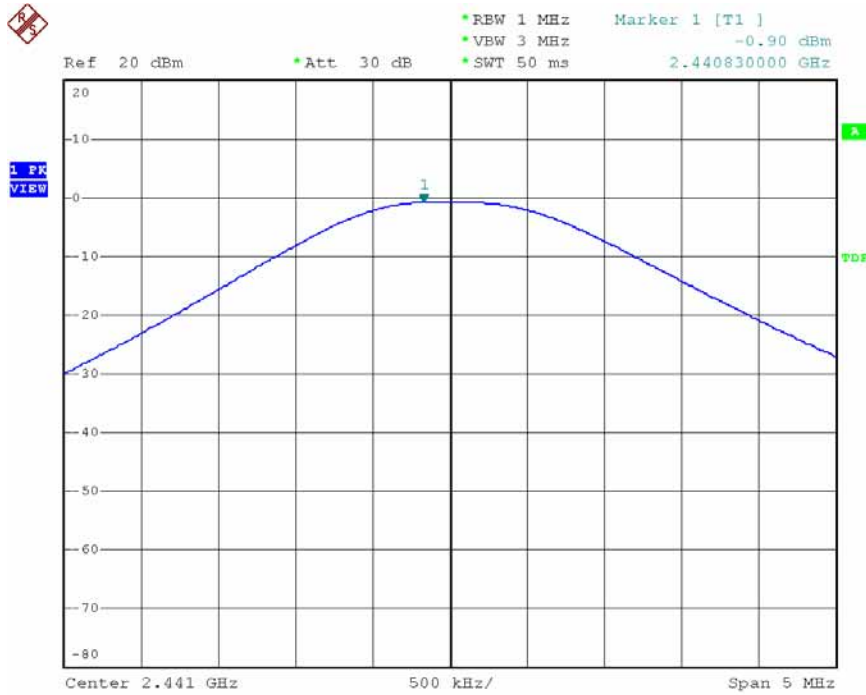

Date: 29.FEB.2008 13:17:21

Modulation Standard: GFSK (1Mbps)
 Channel: 78

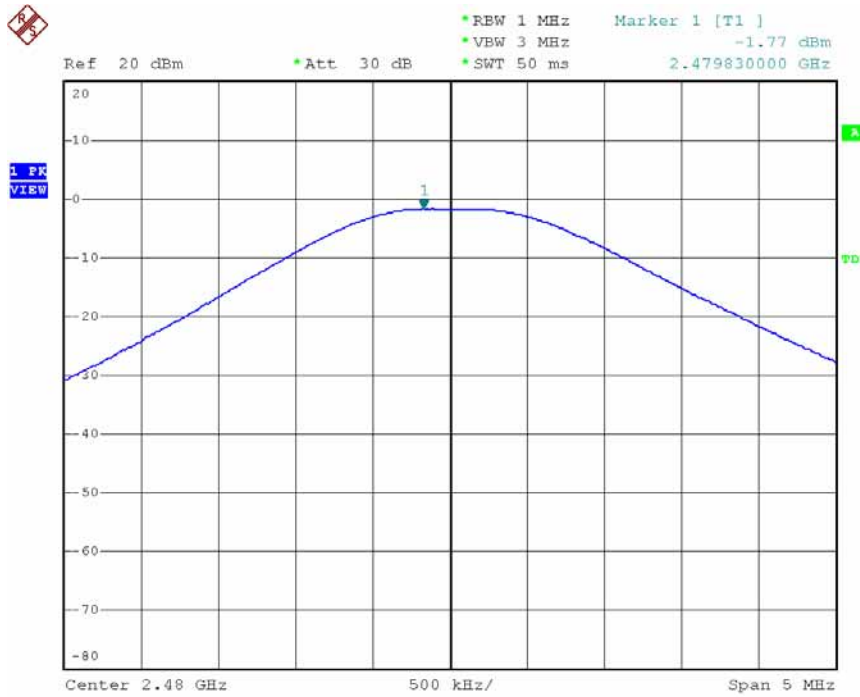

Date: 29.FEB.2008 13:19:35

Modulation Standard: $\pi/4$ -DQPSK (2Mbps)
 Channel: 00

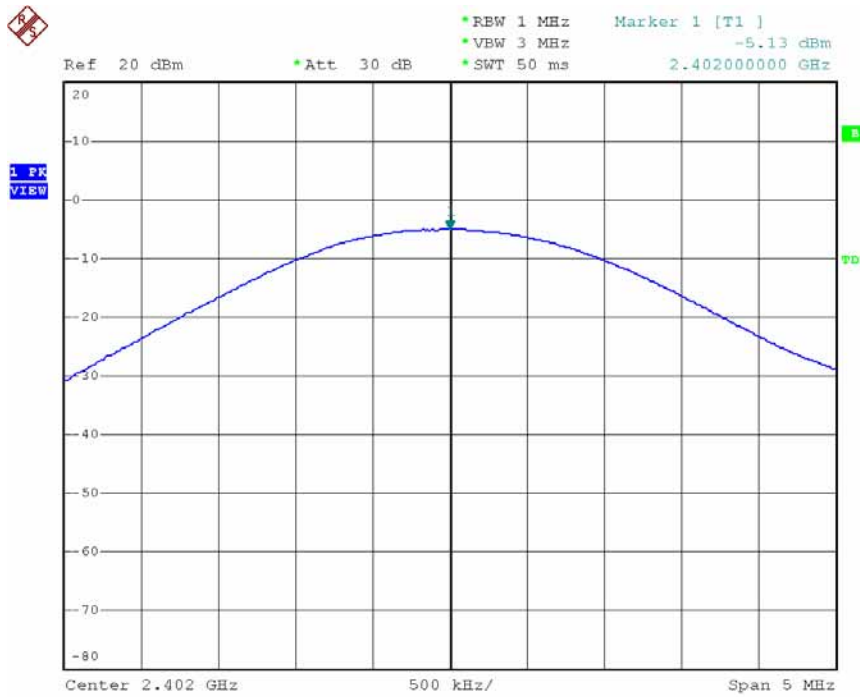

Date: 12.MAY.2008 15:22:57

Modulation Standard: $\pi/4$ -DQPSK (2Mbps)
 Channel: 39

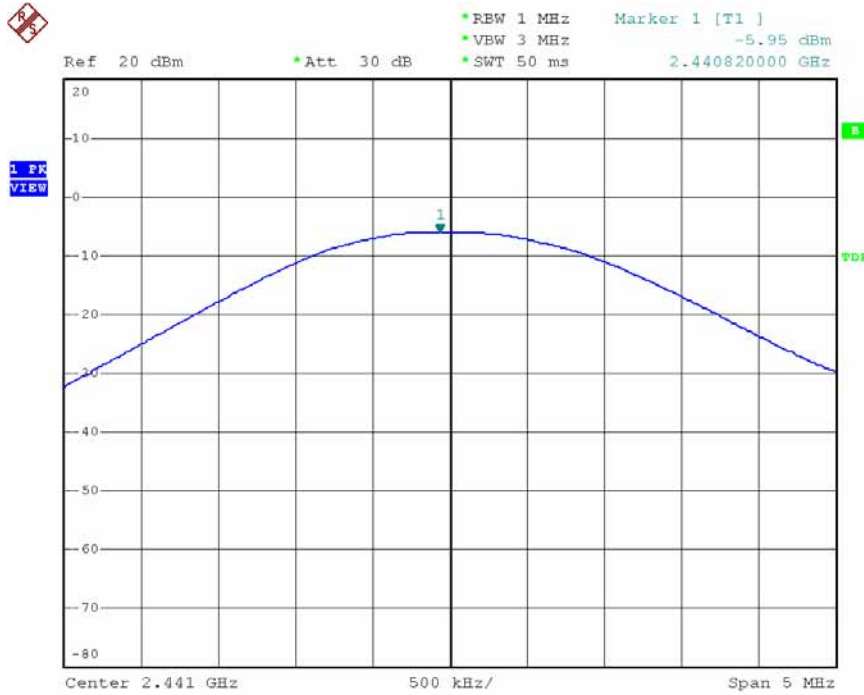

Date: 12.MAY.2008 13:25:03

Modulation Standard: $\pi/4$ -DQPSK (2Mbps)
 Channel: 78

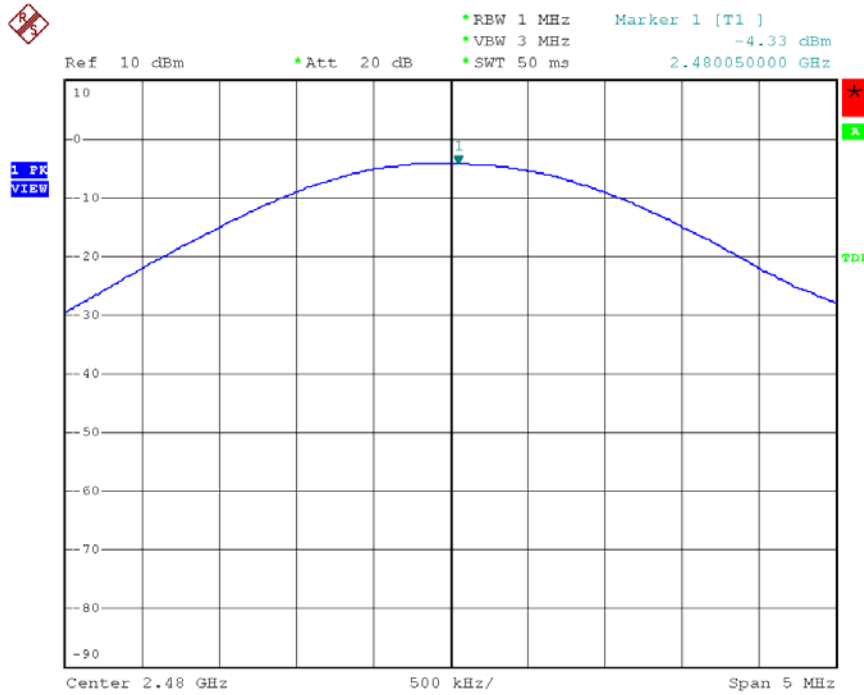

Date: 28.APR.2008 18:20:11

Modulation Standard: 8DPSK (3Mbps)
 Channel: 00

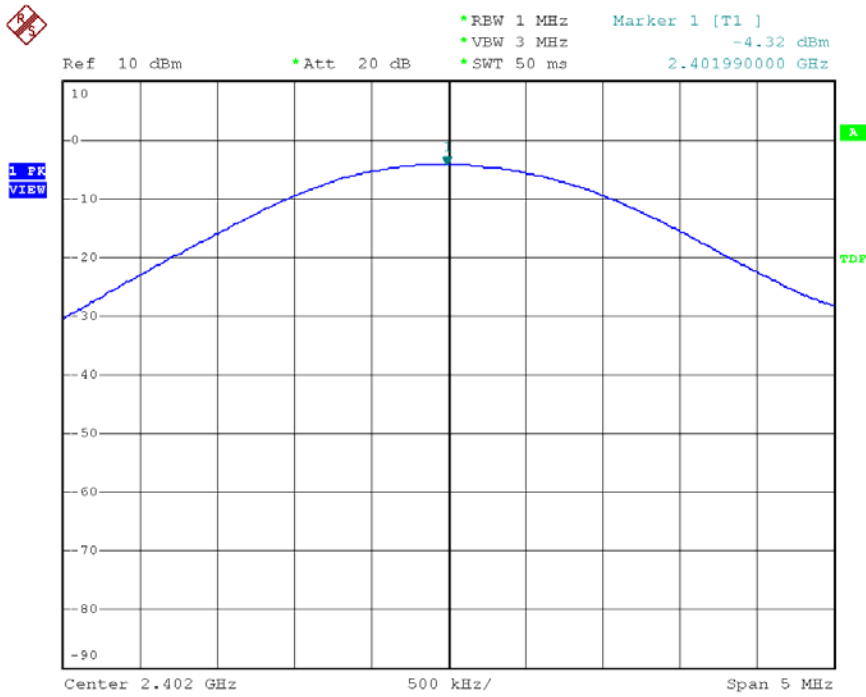

Date: 28.APR.2008 18:18:59

Modulation Standard: 8DPSK (3Mbps)
 Channel: 39

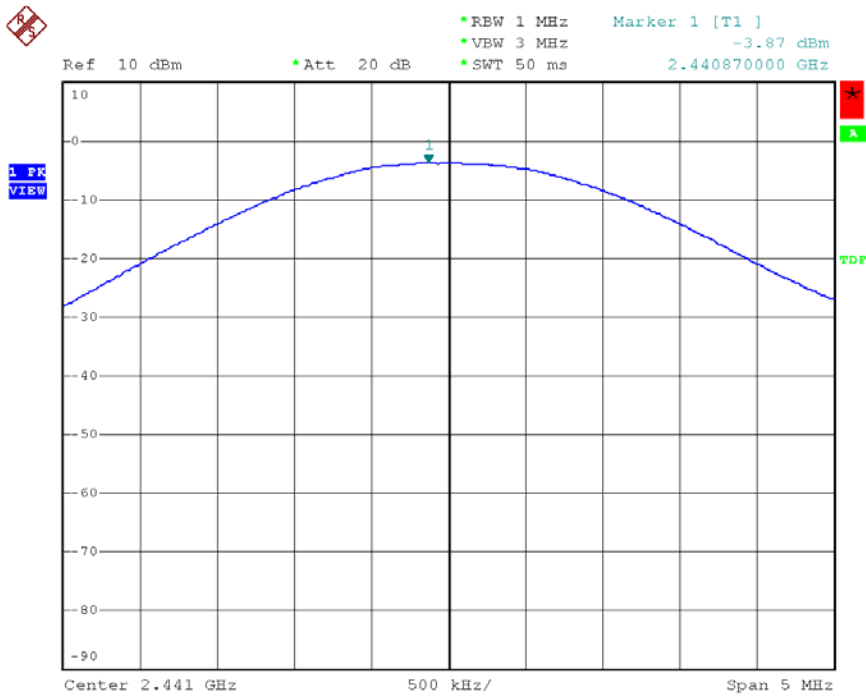

Date: 28.APR.2008 18:19:32

Modulation Standard: 8DPSK (3Mbps)
Channel: 78

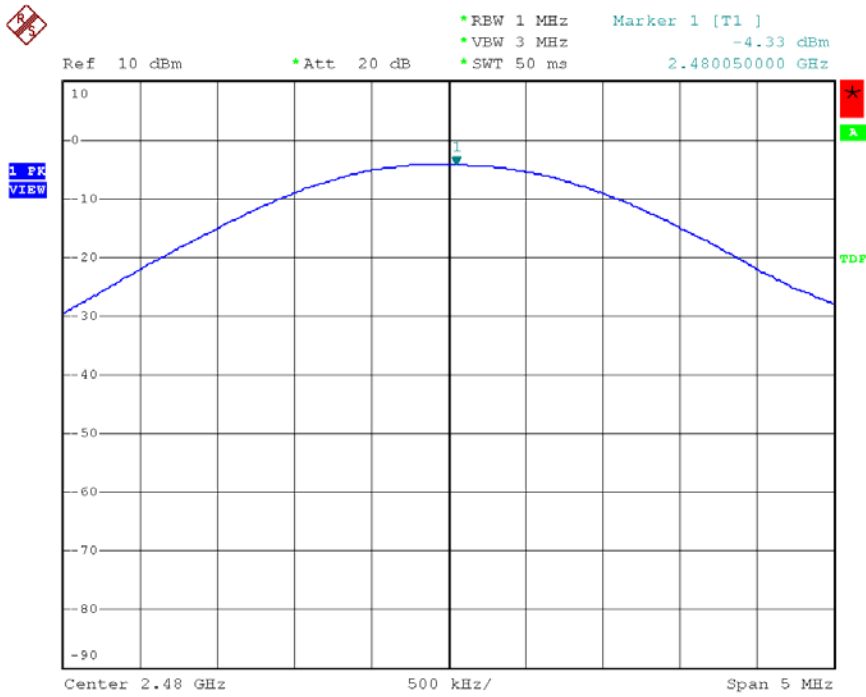

Date: 28.APR.2008 18:20:11

11. Band Edges Measurement

11.1 Test Limit

Below -20dB of the highest emission level of operating band (in 100kHz Resolution Bandwidth).

11.2 Test Procedure :

- The transmitter output was connected to the spectrum analyzer via a low lose cable.
- Set both RBW and VBW of spectrum analyzer to 100 KHz with convenient frequency span including 100 KHz bandwidth from band edge.
- The band edges was measured and recorded.

11.3 Test Setup Layout

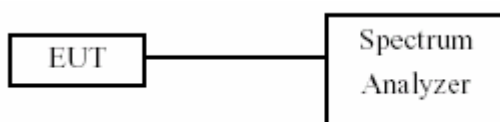

11.4 List of Measuring Equipment Used

Instrument/Ancillary	Model No.	Manufacturer	Serial No.	Calibration Date	Valid Date
Spectrum Analyzer	FSP40	R&S	10047	2008/02/22	2009/02/21

11.5 Test Result and Data

Modulation Standard: GFSK (1Mbps)

Test Date: Feb. 29, 2008 Temperature: 20 Humidity: 60% Atmospheric pressure: 1008 hPa

Channel	Frequency	maximum value in frequency (MHz)	maximum value is (dBm)
00	2402	2399.92	-43.08
78	2480	2484.46	-48.09

Modulation Standard: $\pi/4$ -DQPSK (2Mbps)

Test Date: May. 12, 2008 Temperature: 24 Humidity: 64% Atmospheric pressure: 1008 hPa

Channel	Frequency	maximum value in frequency (MHz)	maximum value is (dBm)
00	2402	2399.40	-52.97
78	2480	2483.79	-51.15

Modulation Standard: 8DPSK (3Mbps)

Test Date: Apr. 28, 2008 Temperature: 22 Humidity: 62% Atmospheric pressure: 1008 hPa

Channel	Frequency	maximum value in frequency (MHz)	maximum value is (dBm)
00	2402	2399.60	-52.05
78	2480	2483.58	-51.17

Modulation Standard: GFSK (1Mbps)
 Channel: 00

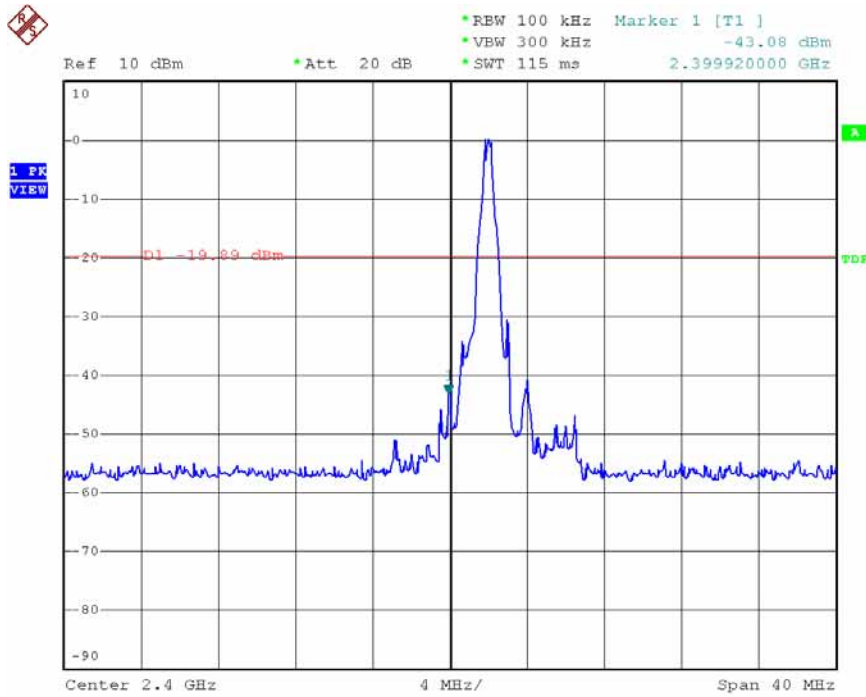

Date: 29.FEB.2008 16:36:22

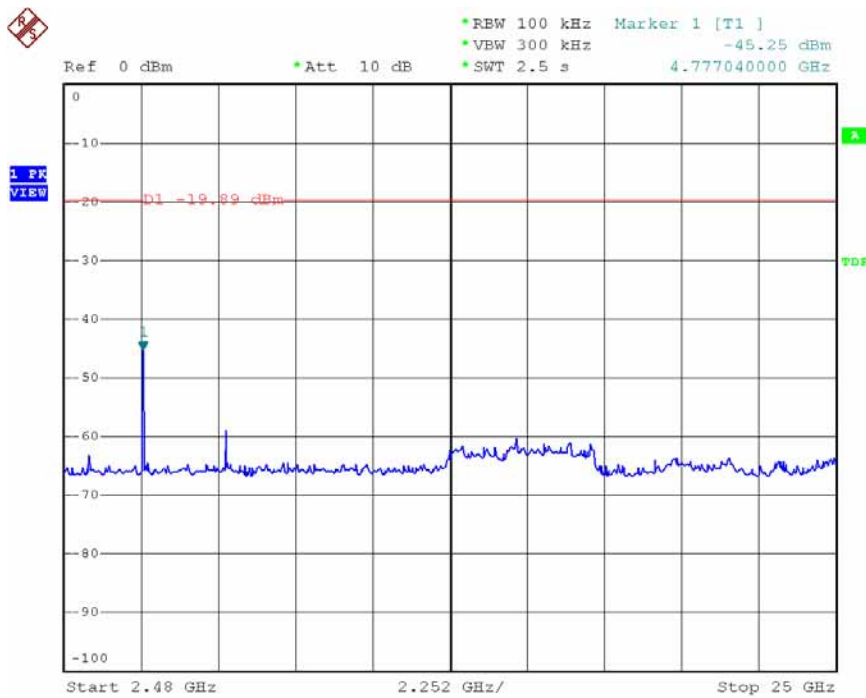

Date: 29.FEB.2008 16:37:35

Modulation Standard: GFSK (1Mbps)
Channel: 78

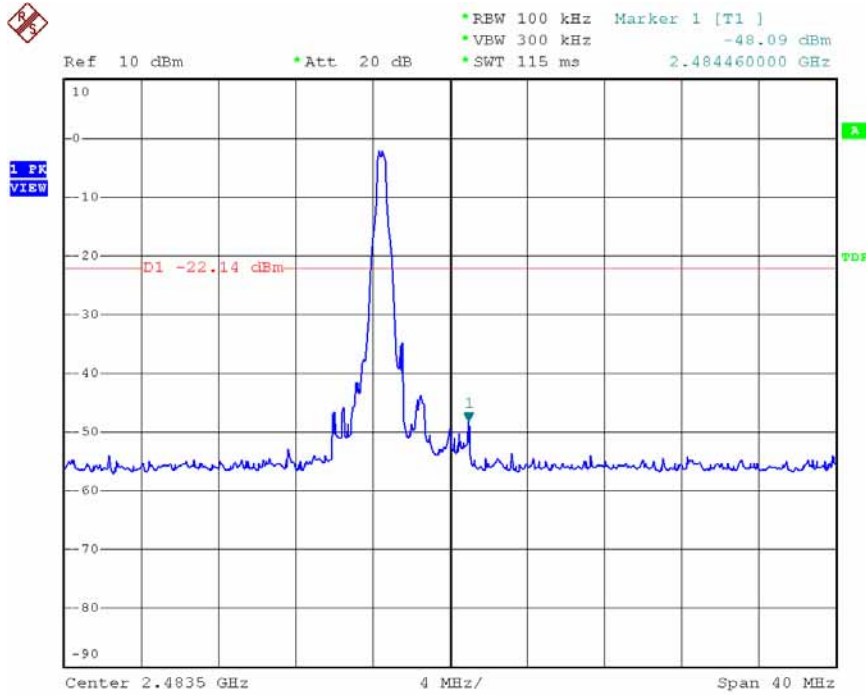

Date: 29.FEB.2008 16:40:23

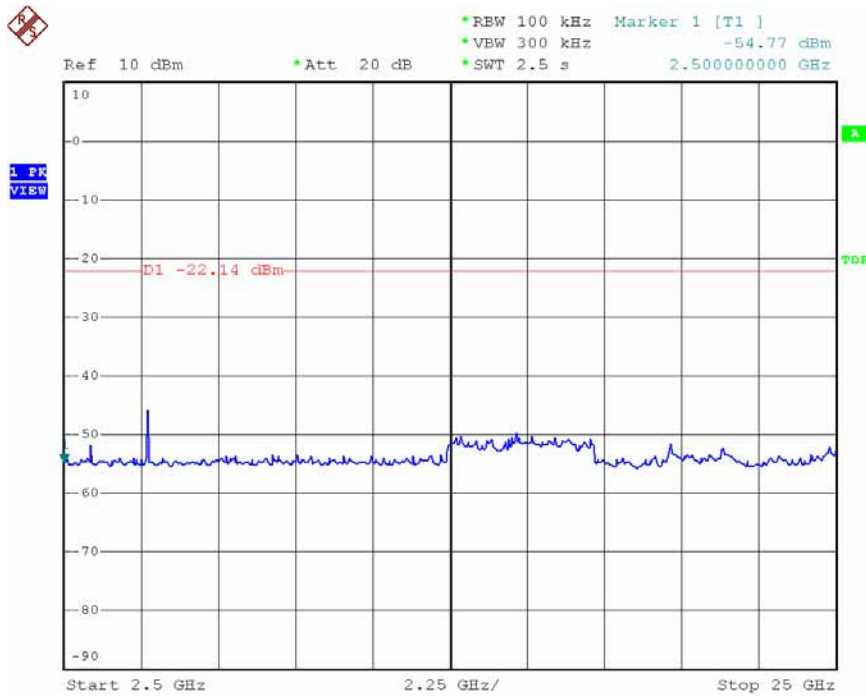

Date: 29.FEB.2008 16:47:35

Modulation Standard: $\pi/4$ -DQPSK (2Mbps)
 Channel: 00

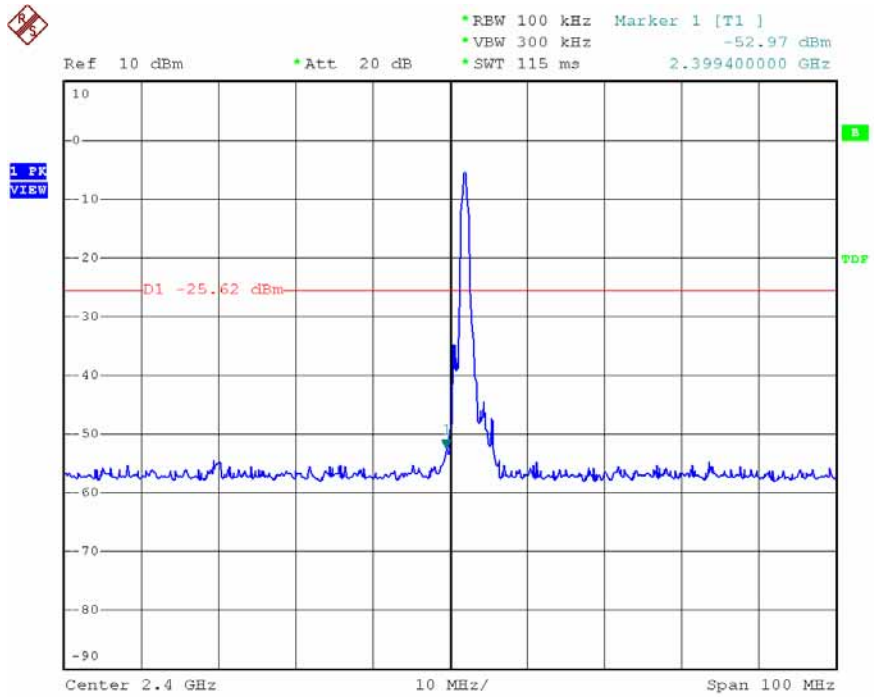

Date: 12.MAY.2008 15:14:08

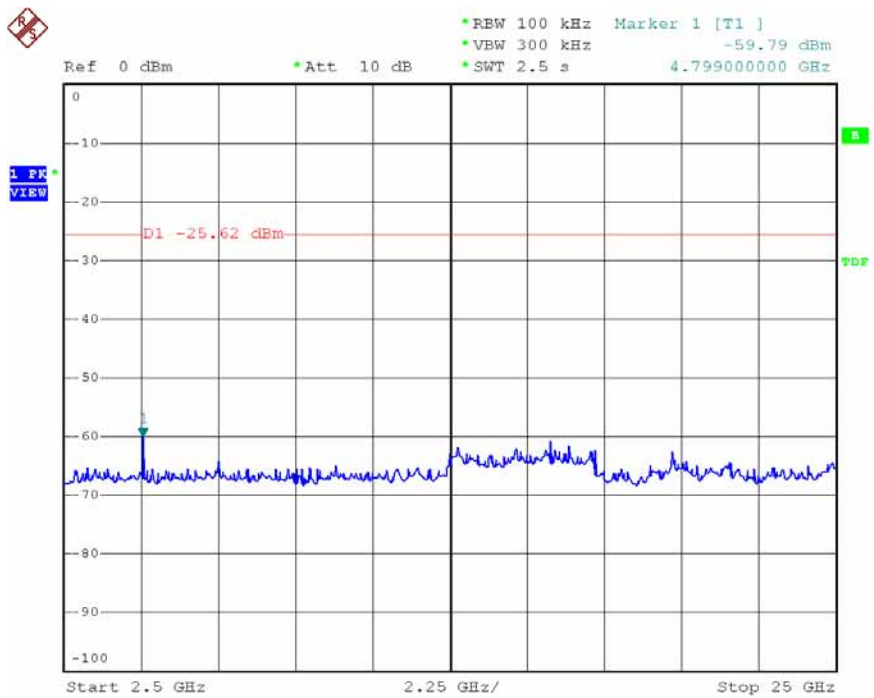

Date: 12.MAY.2008 15:14:35

Modulation Standard: $\pi/4$ -DQPSK (2Mbps)
 Channel: 78

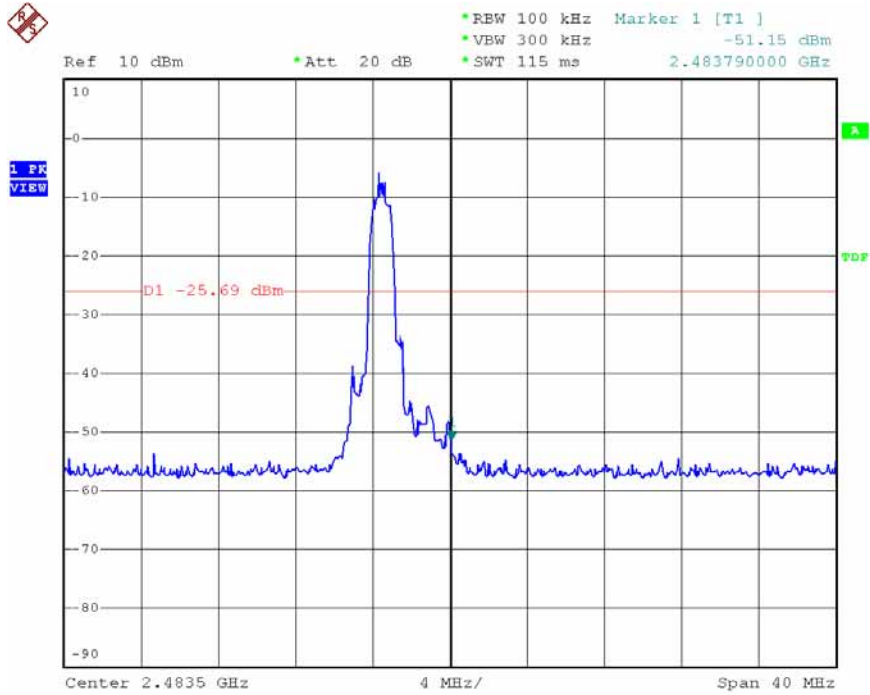

Date: 28.APR.2008 18:24:17

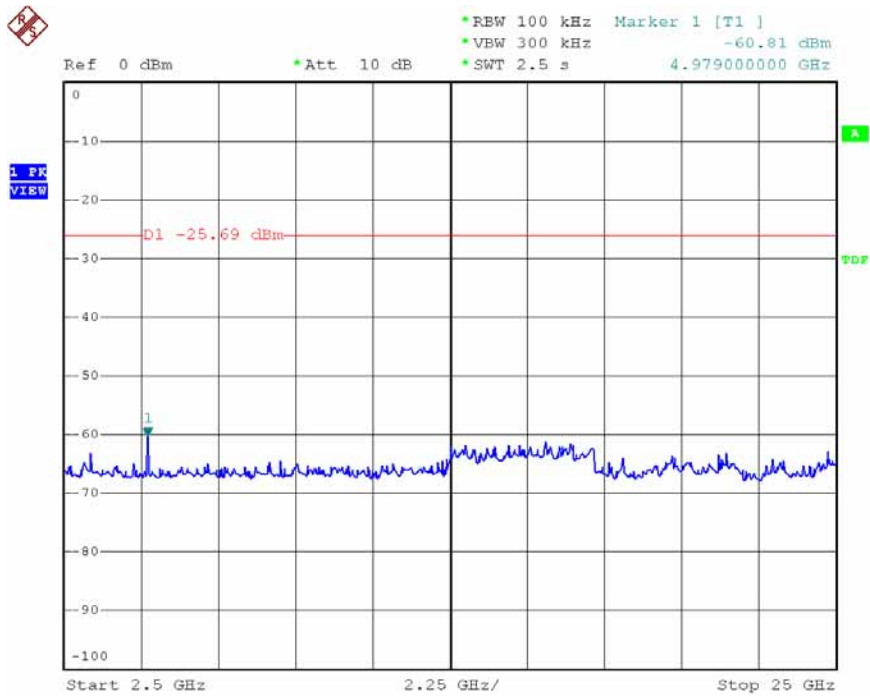

Date: 28.APR.2008 18:24:51

Modulation Standard: 8DPSK (3Mbps)
 Channel: 00

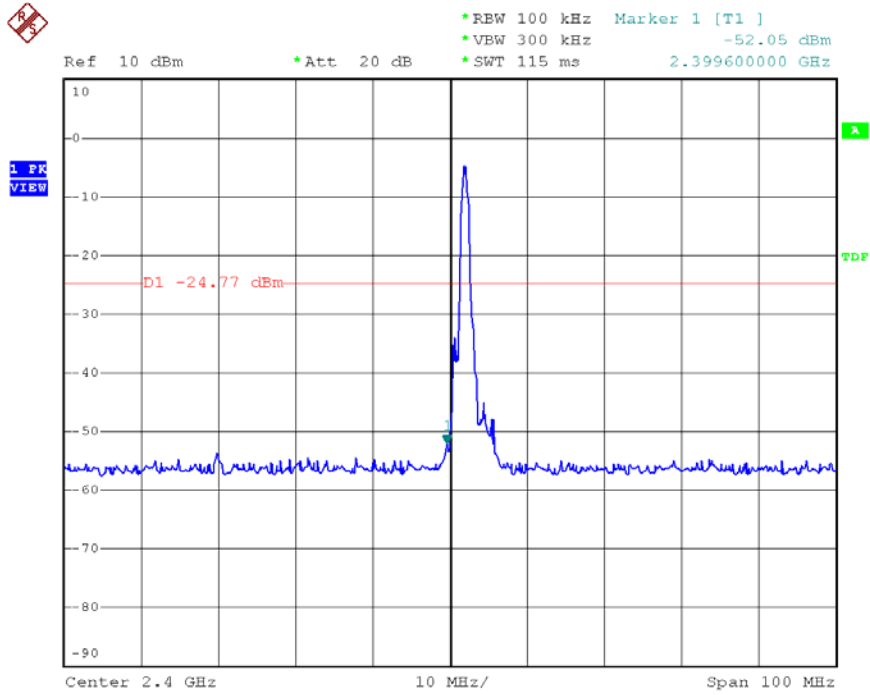

Date: 28.APR.2008 18:22:32

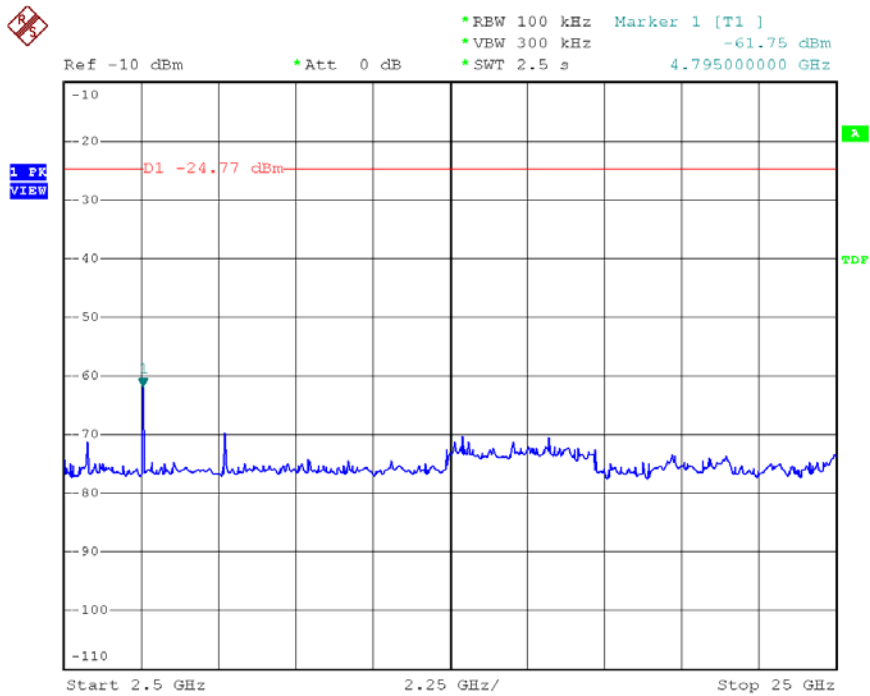

Date: 28.APR.2008 18:23:01

Modulation Standard: $\pi/4$ -DQPSK (2Mbps)
 Channel: 78

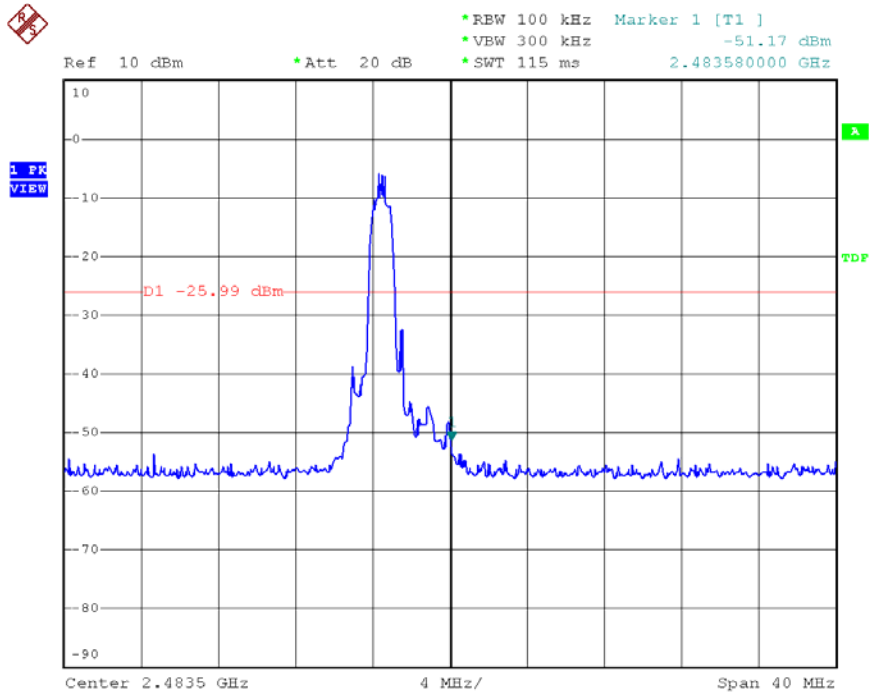

Date: 28.APR.2008 18:24:17

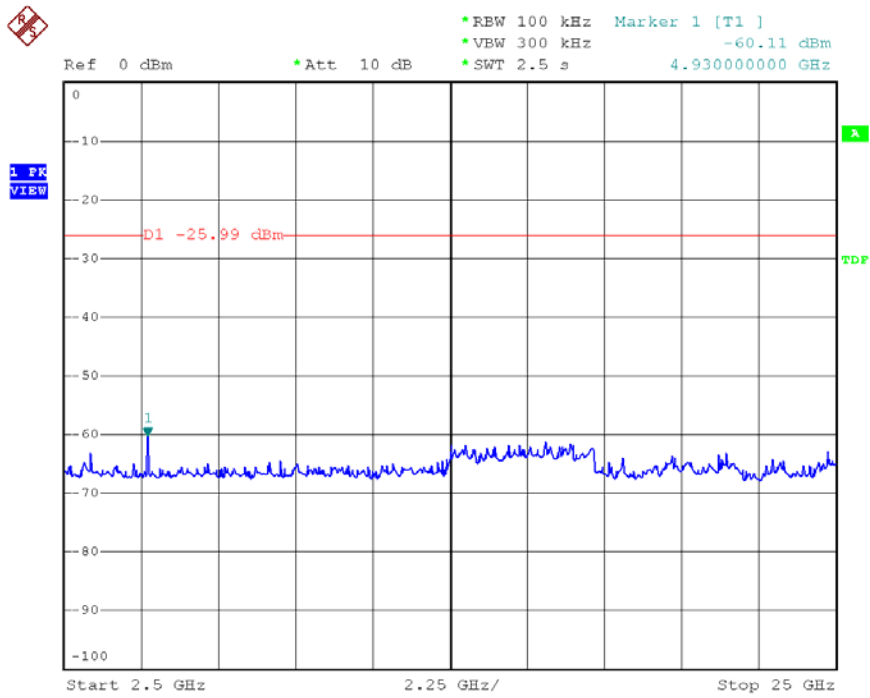

Date: 28.APR.2008 18:24:51

11.6 Restrict band emission Measurement Data

Modulation Standard: GFSK (1Mbps)

Test Date: Feb. 13, 2008 Temperature: 15 Humidity: 70% Atmospheric pressure: 1030 hPa

a) Channel 00

Frequency (MHz)	Ant-Pol H/V	Meter Reading	Corrected Factor	Result (dBuV/m)	Remark	Limit@3m (dBuV/m)		Margin (dB)	Table (Deg.)	Ant High (m)
						Peak	Ave.			
2340.80	H	52.44	-3.27	49.17	Peak	74	54	-24.83	238	1.0
2385.89	H	41.30	-3.11	38.19	Ave	74	54	-16.81	238	1.0
2379.26	V	51.87	-3.13	48.74	Peak	74	54	-25.26	194	1.0
2385.89	V	40.79	-3.11	37.68	Ave	74	54	-16.32	194	1.0

b) Channel 78

Frequency (MHz)	Ant-Pol H/V	Meter Reading	Corrected Factor	Result (dBuV/m)	Remark	Limit@3m (dBuV/m)		Margin (dB)	Table (Deg.)	Ant High (m)
						Peak	Ave.			
2486.64	H	52.00	-2.75	49.25	Peak	74	54	-24.75	238	1.0
2483.51	H	40.17	-2.76	37.41	Ave	74	54	-16.59	238	1.0
2488.04	V	52.22	-2.74	49.48	Peak	74	54	-24.52	194	1.0
2483.51	V	41.68	-2.76	38.92	Ave	74	54	-15.08	194	1.0

Modulation Standard: $\pi/4$ -DQPSK (2Mbps)

Test Date: May. 12, 2008 Temperature: 24 Humidity: 64% Atmospheric pressure: 1008 hPa

a) Channel 00

Frequency (MHz)	Ant-Pol H/V	Meter Reading	Corrected Factor	Result (dBuV/m)	Remark	Limit@3m (dBuV/m)		Margin (dB)	Table (Deg.)	Ant High (m)
						Peak	Ave.			
2340.80	H	52.13	-3.27	48.86	Peak	74	54	-25.14	238	1.0
2385.89	H	41.76	-3.11	38.65	Ave	74	54	-15.35	238	1.0
2379.26	V	51.56	-3.13	48.43	Peak	74	54	-25.57	194	1.0
2385.89	V	40.46	-3.11	37.35	Ave	74	54	-16.65	194	1.0

b) Channel 78

Frequency (MHz)	Ant-Pol H/V	Meter Reading	Corrected Factor	Result (dBuV/m)	Remark	Limit@3m (dBuV/m)		Margin (dB)	Table (Deg.)	Ant High (m)
						Peak	Ave.			
2486.64	H	52.12	-2.75	49.37	Peak	74	54	-24.63	238	1.0
2483.51	H	40.10	-2.76	37.34	Ave	74	54	-16.66	238	1.0
2488.04	V	52.36	-2.74	49.62	Peak	74	54	-24.38	194	1.0
2483.51	V	41.51	-2.76	38.75	Ave	74	54	-15.25	194	1.0

Notes:

1. Result = Meter Reading + Factor
2. Factor = Antenna Factor + Cable Loss – Amplifier
3. The resolution bandwidth of test receiver/spectrum analyzer is 1 MHz and video bandwidth is 3 MHz for Peak detection at frequency above 1GHz.
4. The resolution bandwidth of test receiver/spectrum analyzer is 1MHz and video bandwidth is 10Hz for Average detection at frequency above 1GHz

Modulation Standard: 8DPSK (3Mbps)

Test Date: Apr. 28, 2008 Temperature: 22 Humidity: 62% Atmospheric pressure: 1008 hPa

a) Channel 00

Frequency (MHz)	Ant-Pol H/V	Meter Reading	Corrected Factor	Result (dBuV/m)	Remark	Limit@3m (dBuV/m)		Margin (dB)	Table (Deg.)	Ant High (m)
						Peak	Ave.			
2340.80	H	52.81	-3.27	49.54	Peak	74	54	-24.46	238	1.0
2385.89	H	41.52	-3.11	38.41	Ave	74	54	-16.59	238	1.0
2379.26	V	51.48	-3.13	48.35	Peak	74	54	-25.65	194	1.0
2385.89	V	40.96	-3.11	37.85	Ave	74	54	-16.15	194	1.0

b) Channel 78

Frequency (MHz)	Ant-Pol H/V	Meter Reading	Corrected Factor	Result (dBuV/m)	Remark	Limit@3m (dBuV/m)		Margin (dB)	Table (Deg.)	Ant High (m)
						Peak	Ave.			
2486.64	H	52.23	-2.75	49.48	Peak	74	54	-24.52	238	1.0
2483.51	H	40.29	-2.76	37.53	Ave	74	54	-16.47	238	1.0
2488.04	V	52.33	-2.74	49.59	Peak	74	54	-24.41	194	1.0
2483.51	V	41.80	-2.76	39.04	Ave	74	54	-14.96	194	1.0

Notes:

1. Result = Meter Reading + Factor
2. Factor = Antenna Factor + Cable Loss – Amplifier
3. The resolution bandwidth of test receiver/spectrum analyzer is 1 MHz and video bandwidth is 3 MHz for Peak detection at frequency above 1GHz.
4. The resolution bandwidth of test receiver/spectrum analyzer is 1MHz and video bandwidth is 10Hz for Average detection at frequency above 1GHz

12. Power Spectral Density

12.1 Test Limit

The Maximum of Power Spectral Density Measurement is 8dBm.

12.2 Test Procedures

- 1.The transmitter output was connected to spectrum analyzer.
- 2.The spectrum analyzer's resolution bandwidth were set at 3KHz RBW and 30KHz VBW as that of the fundamental frequency. Set the sweep time=span/3KHz.
- 3.The power spectral density was measured and recorded.
- 4.The Sweep time is allowed to be longer than span/3KHz for a full response of the mixer in the spectrum analyzer.

12.3 Test Setup Layout :

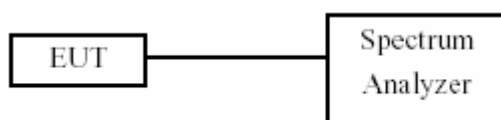

12.4 List of Measuring Equipment Used

Instrument/Ancillary	Model No.	Manufacturer	Serial No.	Calibration Date	Valid Date
Spectrum Analyzer	FSP40	R&S	10047	2008/02/22	2009/02/21

12.5 Test Result and Data

Modulation Standard: GFSK (1Mbps)

Test Date: Feb. 29, 2008 Temperature: 20 Humidity: 60% Atmospheric pressure: 1008 hPa

Channel	Frequency	Maximum Power Density of 3 kHz Bandwidth (dBm)
00	2402	-11.56
39	2441	-12.51
78	2480	-13.33

Modulation Standard: $\pi/4$ -DQPSK (2Mbps)

Test Date: May. 12, 2008 Temperature: 24 Humidity: 64% Atmospheric pressure: 1008 hPa

Channel	Frequency	Maximum Power Density of 3 kHz Bandwidth (dBm)
00	2402	-17.79
39	2441	-17.77
78	2480	-19.17

Modulation Standard: 8DPSK (3Mbps)

Test Date: Apr. 28, 2008 Temperature: 22 Humidity: 62% Atmospheric pressure: 1008 hPa

Channel	Frequency	Maximum Power Density of 3 kHz Bandwidth (dBm)
00	2402	-16.52
39	2441	-17.59
78	2480	-19.15

Modulation Standard: GFSK (1Mbps)
 Channel: 00

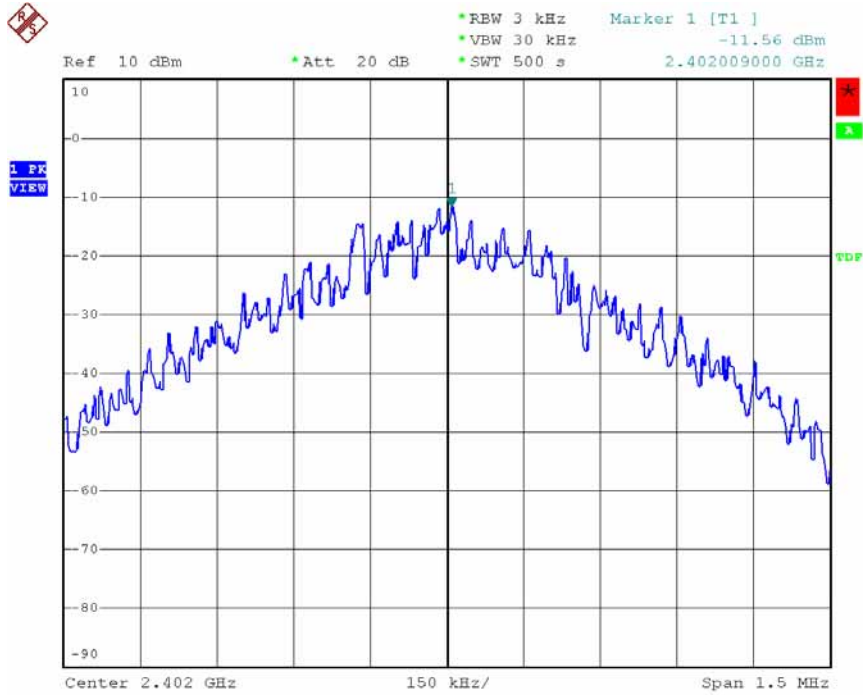

Date: 3.MAR.2008 13:57:04

Modulation Standard: GFSK (1Mbps)
 Channel: 39

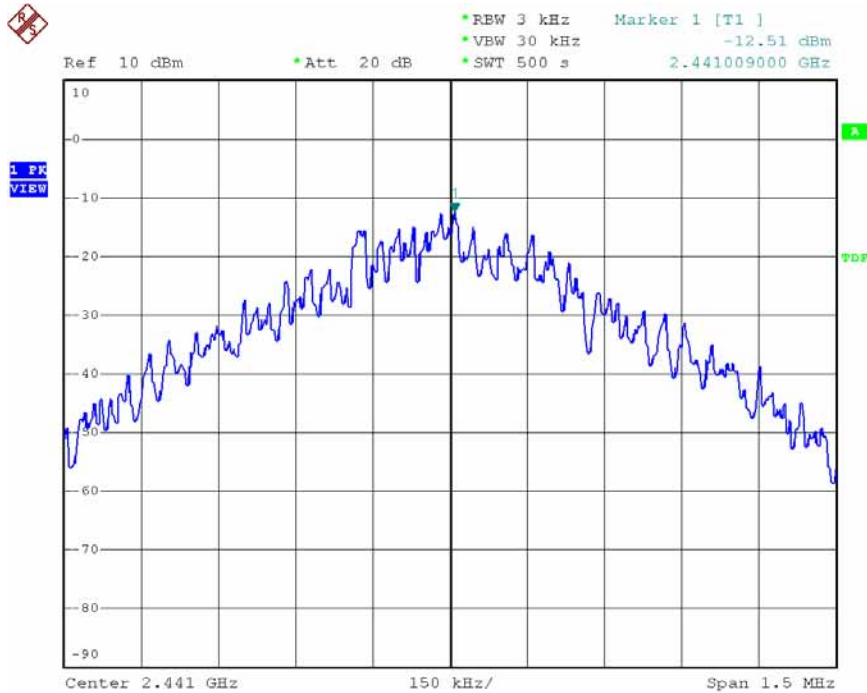

Date: 3.MAR.2008 14:38:31

Modulation Standard: GFSK (1Mbps)
 Channel: 78

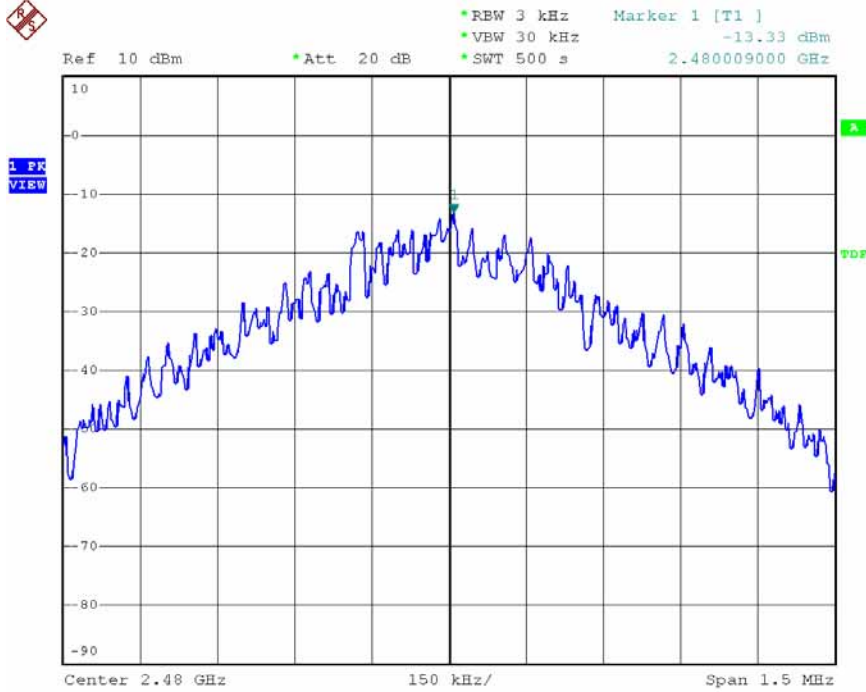

Date: 3.MAR.2008 15:05:35

Modulation Standard: $\pi/4$ -DQPSK (2Mbps)
 Channel: 00

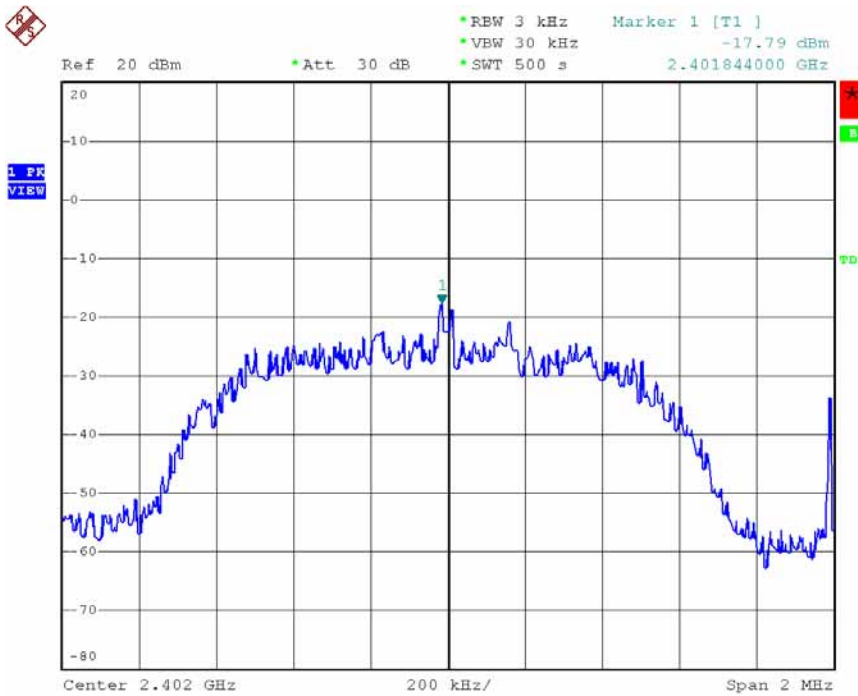

Date: 12.MAY.2008 15:53:24

Modulation Standard: 8DPSK (3Mbps)
 Channel: 00

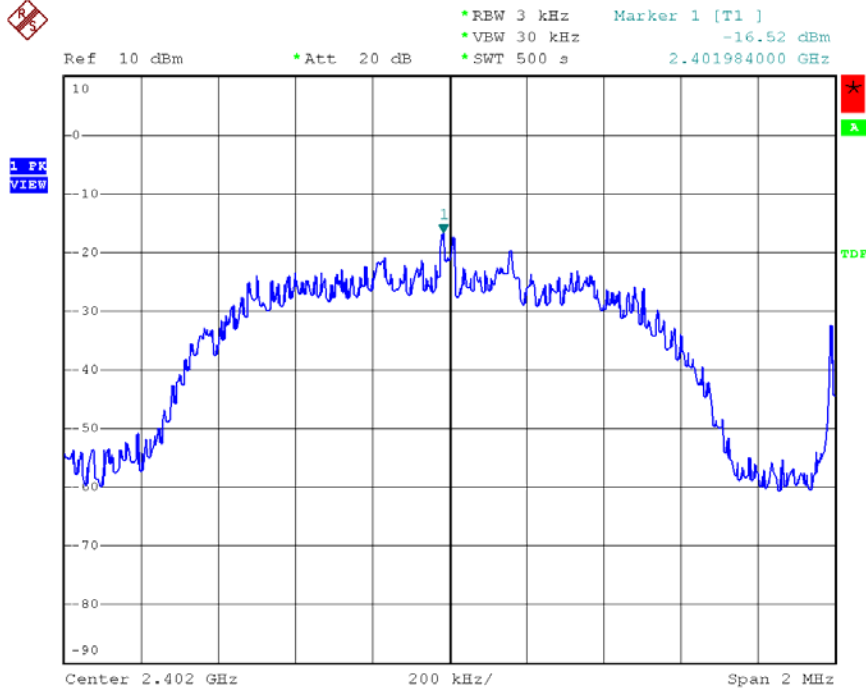

Date: 28.APR.2008 17:37:18

Modulation Standard: 8DPSK (3Mbps)
 Channel: 39

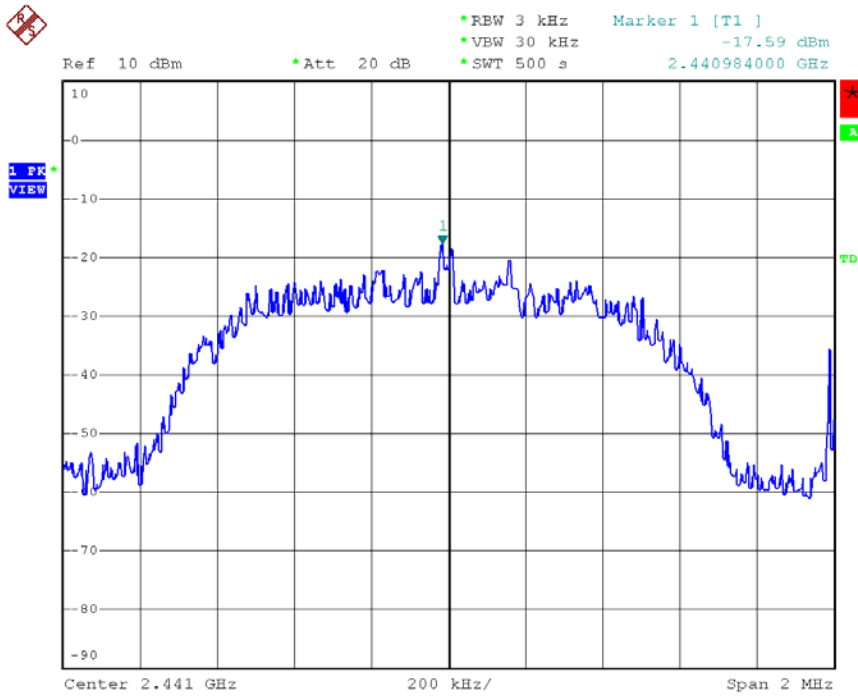

Date: 28.APR.2008 18:06:00

Modulation Standard: 8DPSK (3Mbps)
Channel: 78

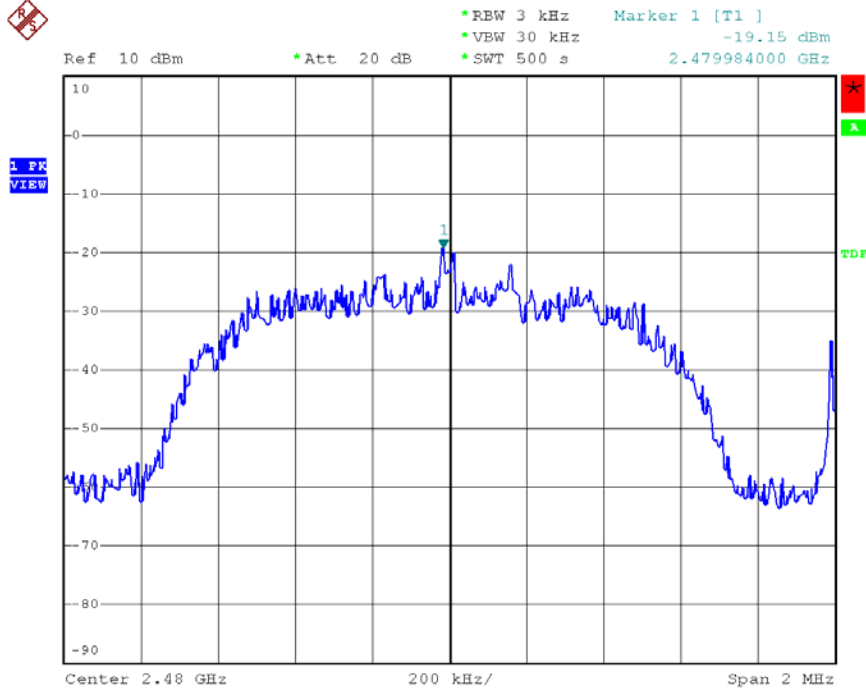

Date: 28.APR.2008 17:28:12

13. Restricted Bands of Operation

Only spurious emissions are permitted in any of the frequency bands listed below:

MHz	MHz	MHz	GHz
0.09000 – 0.11000	16.42000 – 16.42300	399.9 – 410.0	4.500 – 5.250
0.49500 – 0.505**	16.69475 – 16.69525	608.0 – 614.0	5.350 – 5.460
2.17350 – 2.19050	16.80425 – 16.80475	960.0 – 1240.0	7.250 – 7.750
4.12500 – 4.12800	25.50000 – 25.67000	1300.0 – 1427.0	8.025 – 8.500
4.17725 – 4.17775	37.50000 – 38.25000	1435.0 – 1626.5	9.000 – 9.200
4.20725 – 4.20775	73.00000 – 74.60000	1645.5 – 1646.5	9.300 – 9.500
6.21500 – 6.21800	74.80000 – 75.20000	1660.0 – 1710.0	10.600 – 12.700
6.26775 – 6.26825	108.00000 – 121.94000	1718.8 – 1722.2	13.250 – 13.400
6.31175 – 6.31225	123.00000 – 138.00000	2200.0 – 2300.0	14.470 – 14.500
8.29100 – 8.29400	149.90000 – 150.05000	2310.0 – 2390.0	15.350 – 16.200
8.36200 – 8.36600	156.52475 – 156.52525	2483.5 – 2500.0	17.700 – 21.400
8.37625 – 8.38675	156.70000 – 156.90000	2655.0 – 2900.0	22.010 – 23.120
8.41425 – 8.41475	162.01250 – 167.17000	3260.0 – 3267.0	23.600 – 24.000
12.29000 – 12.29300	167.72000 – 173.20000	3332.0 – 3339.0	31.200 – 31.800
12.51975 – 12.52025	240.00000 – 285.00000	3345.8 – 3358.0	36.430 – 36.500
12.57675 – 12.57725	322.00000 – 335.40000	3600.0 – 4400.0	Above 38.6
13.36000 – 13.41000			

** : Until February 1, 1999, this restricted band shall be 0.490-0.510 MHz

13.1 Labeling Requirement

The device shall bear the following statement in a conspicuous location on the device:

This device complies with part 15 of the FCC Rules. Operation is subject to the following two conditions: (1) This device may not cause harmful interference, and (2) this device must accept any interference received, including interference that may cause undesired operation.