



FCC ID: M82-AMIS850
Report No.: T201216D05-RP

Page: 1 / 33
Rev.: 01

FCC 47 CFR PART 15 SUBPART C

TEST REPORT

For

Electronic storage box

Model No.:

AMiS-850, AMiS-850XXXXXXXXXXXXXXXXXX (where "X" may be any alphanumeric character, "-" or blank)

Trade Name: ADVANTECH

Issued to

Advantech Co., Ltd.

No. 1, Alley 20, Lane 26, Rueiguang Road, Neihu District, Taipei 114,
Taiwan, R.O.C.

Issued by

Compliance Certification Services Inc.

Wugong Laboratory

No.11, Wugong 6th Rd., Wugong Dist.,

New Taipei City, Taiwan. (R.O.C.)

Issued Date: September 8, 2021

Unless otherwise stated the results shown in this test report refer only to the sample(s) tested and such sample(s) are retained for 90 days only.
除非另有說明，此報告結果僅對測試之樣品負責，同時此樣品僅保留90天。本報告未經本公司書面許可，不可部份複製。

This document is issued by the Company subject to its General Conditions of Service printed overleaf, available on request or accessible at <http://www.sgs.com.tw/Terms-and-Conditions> and, for electronic format documents, subject to Terms and Conditions for Electronic Documents at <http://www.sgs.com.tw/Terms-and-Conditions>. Attention is drawn to the limitation of liability, indemnification and jurisdiction issues defined therein. Any holder of this document is advised that information contained hereon reflects the Company's findings at the time of its intervention only and within the limits of client's instruction, if any. The Company's sole responsibility is to its Client and this document does not exonerate parties to a transaction from exercising all their rights and obligations under the transaction documents. This document cannot be reproduced, except in full, without prior written approval of the Company. Any unauthorized alteration, forgery or falsification of the content or appearance of this document is unlawful and offenders may be prosecuted to the fullest extent of the law.

Revision History

Rev.	Issue Date	Revisions	Effect Page	Revised By
00	April 23, 2021	Initial Issue	ALL	Doris Chu
01	September 8, 2021	See the following Note Rev. (01)	ALL	Doris Chu

Rev. (01)

1. Added an adapter (DELTA / ADP-60KD B), and only re-test conduction and radiation for below 1GHz. For conduction the worst mode is original test mode (adapter: FSP), but for radiation for below 1GHz the worst mode is update test mode (adapter: DELTA), so we only update test data for radiation for below 1GHz and the other measurement results in the original report are fully leveraged in this test report.

TABLE OF CONTENTS

1. TEST RESULT CERTIFICATION.....	4
2. EUT DESCRIPTION.....	5
3. TEST METHODOLOGY.....	6
3.1 EUT CONFIGURATION.....	6
3.2 FCC PART 15.205 RESTRICTED BANDS OF OPERATIONS.....	6
3.3 RSS GEN SECTION 8.10 RESTRICTED BANDS OF OPERATIONS.....	7
3.4 DESCRIPTION OF TEST MODES.....	8
4. TEST SUMMARY.....	9
5. INSTRUMENT CALIBRATION.....	10
5.1 MEASURING INSTRUMENT CALIBRATION.....	10
5.2 MEASUREMENT EQUIPMENT USED.....	10
5.3 MEASUREMENT UNCERTAINTY.....	12
6. FACILITIES AND ACCREDITATIONS.....	13
6.1 FACILITIES.....	13
6.2 EQUIPMENT.....	13
7. SETUP OF EQUIPMENT UNDER TEST.....	14
7.1 SETUP CONFIGURATION OF EUT.....	14
7.2 SUPPORT EQUIPMENT.....	14
8. FCC PART 15.225 REQUIREMENTS & RSS-210 REQUIREMENTS.....	15
8.1 OCCUPIED BANDWIDTH(99%) AND 20 DB BANDWIDTH.....	15
8.2 RADIATED EMISSIONS.....	17
8.3 FREQUENCY STABILITY.....	29
8.4 POWERLINE CONDUCTED EMISSIONS.....	31
APPENDIX A PHOTOGRAPHS OF TEST SETUP.....	A-1
APPENDIX 1 - PHOTOGRAPHS OF EUT	
APPENDIX 2 - RF EXPOSURE	

Report No.: T201216D05-RP

1. TEST RESULT CERTIFICATION

Applicant: Advantech Co., Ltd.
No. 1, Alley 20, Lane 26, Rueiguang Road, Neihu District,
Taipei 114, Taiwan, R.O.C.

Manufacturer: Advantech Co., Ltd.
No. 1, Alley 20, Lane 26, Rueiguang Road, Neihu District,
Taipei 114, Taiwan, R.O.C.

Equipment Under Test: Electronic storage box

Trade Name: ADVANTECH

Model No.: AMiS-850, AMiS-850XXXXXXXXXXXXXXXXXXXX (where "X" may
be any alphanumeric character , "-" or blank)

Date of Test: March 8 ~ August 6, 2021

APPLICABLE STANDARDS	
STANDARD	TEST RESULT
FCC 47 CFR Part 15 Subpart C	No non-compliance noted
Statements of Conformity	
Determination of compliance is based on the results of the compliance measurement, not taking into account measurement instrumentation uncertainty.	

We hereby certify that:

The above equipment was tested by Compliance Certification Services Inc. The test data, data evaluation, test procedures, and equipment configurations shown in this report were made in accordance with the procedures given in ANSI C63.10: 2013 and the energy emitted by the sample tested as described in this report is in compliance with the requirements of FCC Rules Part 15.225.

The test results of this report relate only to the tested sample identified in this report.

Approved by:



Kevin Tsai
Deputy Manager
Compliance Certification Services Inc.

Report No.: T201216D05-RP

2. EUT DESCRIPTION

Product	Electronic storage box
Model No.	AMiS-850, AMiS-850XXXXXXXXXXXXXXXXXX (where "X" may be any alphanumeric character , "-" or blank)
Model Discrepancy	All the above models are identical except for the designation of model numbers. The suffix of (where "X" may be any alphanumeric character , "-" or blank) on model number is just for marketing purpose only.
Trade	ADVANTECH
Received Date	December 16, 2020
Power Supply	Power from Adapter. 1. FSP / FSP084-DIBAN2 I/P: 100-240VAC, 50-60Hz, 1.3A O/P: 12VDC, 7.0A MAX 2. DELTA / ADP-60KD B I/P: 100-240VAC, 50-60Hz, 1.5A O/P: 12VDC, 5.0A, 60W
Frequency Range	13.56MHz
Modulation Technique	ASK
Number of Channels	1 Channel
Antenna Requirement	PCB Antenna
S/W Version	FW V0.7
H/W Version	A101-1

Remark:

1. For more details, refer to the User's manual of the EUT.
2. Disclaimer: Antenna information is provided by the applicant, test results of this report are applicable to the sample EUT received.
3. Disclaimer: Variant information between/among model numbers / trademarks are provided by the applicant, test results of this report are applicable to the sample EUT received of main test model name.

Report No.: T201216D05-RP

3. TEST METHODOLOGY

The tests documented in this report were performed in accordance with ANSI C63.10: 2013 and FCC CFR 47 Part 15.207, 15.209, 15.225.

The tests documented in this report were performed in accordance with IC RSS-210, IC RSS-Gen, and ANSI C63.10: 2013

3.1 EUT CONFIGURATION

The EUT configuration for testing is installed on RF field strength measurement to meet the Commissions requirement and operating in a manner that intends to maximize its emission characteristics in a continuous normal application.

3.2 FCC PART 15.205 RESTRICTED BANDS OF OPERATIONS

(a) Except as shown in paragraph (d) of this section, only spurious emissions are permitted in any of the frequency bands listed below:

MHz	MHz	MHz	GHz
0.090 - 0.110	16.42 - 16.423	399.9 - 410	4.5 - 5.15
¹ 0.495 - 0.505	16.69475 - 16.69525	608 - 614	5.35 - 5.46
2.1735 - 2.1905	16.80425 - 16.80475	960 - 1240	7.25 - 7.75
4.125 - 4.128	25.5 - 25.67	1300 - 1427	8.025 - 8.5
4.17725 - 4.17775	37.5 - 38.25	1435 - 1626.5	9.0 - 9.2
4.20725 - 4.20775	73 - 74.6	1645.5 - 1646.5	9.3 - 9.5
6.215 - 6.218	74.8 - 75.2	1660 - 1710	10.6 - 12.7
6.26775 - 6.26825	108 - 121.94	1718.8 - 1722.2	13.25 - 13.4
6.31175 - 6.31225	123 - 138	2200 - 2300	14.47 - 14.5
8.291 - 8.294	149.9 - 150.05	2310 - 2390	15.35 - 16.2
8.362 - 8.366	156.52475 -	2483.5 - 2500	17.7 - 21.4
8.37625 - 8.38675	156.52525	2655 - 2900	22.01 - 23.12
8.41425 - 8.41475	156.7 - 156.9	3260 - 3267	23.6 - 24.0
12.29 - 12.293	162.0125 - 167.17	3332 - 3339	31.2 - 31.8
12.51975 - 12.52025	167.72 - 173.2	3345.8 - 3358	36.43 - 36.5
12.57675 - 12.57725	240 - 285	3600 - 4400	(²)
13.36 - 13.41	322 - 335.4		

¹ Until February 1, 1999, this restricted band shall be 0.490-0.510 MHz.

² Above 38.6

(b) Except as provided in paragraphs (d) and (e), the field strength of emissions appearing within these frequency bands shall not exceed the limits shown in Section 15.209. At frequencies equal to or less than 1000 MHz, compliance with the limits in Section 15.209 shall be demonstrated using measurement instrumentation employing a CISPR quasi-peak detector. Above 1000 MHz, compliance with the emission limits in Section 15.209 shall be demonstrated based on the average value of the measured emissions. The provisions in Section 15.35 apply to these measurements.

3.3 RSS GEN SECTION 8.10 RESTRICTED BANDS OF OPERATIONS

Restricted frequency bands, identified in table 7, are designated primarily for safety-of-life services (distress calling and certain aeronautical activities), certain satellite downlinks, radio astronomy and some government uses. Except where otherwise indicated, the following conditions related to the restricted frequency bands apply:

- (a) The transmit frequency, including fundamental components of modulation, of licence-exempt radio apparatus shall not fall within the restricted frequency bands listed in table 7 except for apparatus compliant with RSS-287, Emergency Position Indicating Radio Beacons (EPIRB), Emergency Locator Transmitters (ELT), Personal Locator Beacons (PLB), and Maritime Survivor Locator Devices (MSLD).
- (b) Unwanted emissions that fall into restricted frequency bands listed in table 7 shall comply with the limits specified in table 5 and table 6.
- (c) Unwanted emissions that do not fall within the restricted frequency bands listed in table 7 shall comply either with the limits specified in the applicable RSS or with those specified in table 5 and table 6.

Table 7 – Restricted frequency bands ^{Note 1}			
MHz	MHz	MHz	GHz
0.090 - 0.110	16.42 - 16.423	608 - 614	9.0 - 9.2
0.495 - 0.505	16.69475 - 16.69525	960 - 1427	9.3 - 9.5
2.1735 - 2.1905	16.80425 - 16.80475	1435 - 1626.5	10.6 - 12.7
3.020 - 3.026	25.5 - 25.67	1645.5 - 1646.5	13.25 - 13.4
4.125 - 4.128	37.5 - 38.25	1660 - 1710	14.47 - 14.5
4.17725 - 4.17775	73 - 74.6	1718.8 - 1722.2	15.35 - 16.2
4.20725 - 4.20775	74.8 - 75.2	2200 - 2300	17.7 - 21.4
5.677 - 5.683	108 - 138	2310 - 2390	22.01 - 23.12
6.215 - 6.218	149.9 - 150.05	2483.5 - 2500	23.6 - 24.0
6.26775 - 6.26825	156.52475 -	2655 - 2900	31.2 - 31.8
6.31175 - 6.31225	156.52525	3260 - 3267	36.43 - 36.5
8.291 - 8.294	156.7 - 156.9	3332 - 3339	Above 38.6
8.362 - 8.366	162.0125 - 167.17	3345.8 - 3358	
8.37625 - 8.38675	167.72 - 173.2	3500 - 4400	
8.41425 - 8.41475	240 - 285	4500 - 5150	
12.29 - 12.293	322 - 335.4	5350 - 5460	
12.51975 - 12.52025	399.9 - 410	7250 - 7750	
12.57675 - 12.57725		8025 - 8500	
13.36 - 13.41			

Note 1: Certain frequency bands listed in table 7 and in bands above 38.6 GHz are designated for licence-exempt applications. These frequency bands and the requirements that apply to related devices are set out in the 200 and 300 series of RSSs.

Report No.: T201216D05-RP

3.4 DESCRIPTION OF TEST MODES

The EUT had been tested under engineering test mode condition and the EUT staying in continuous transmitting mode.

All modes and data rates were investigated and it was determined that ISO 14443A/B and ISO 18092 Type y, 106/212/424/848 kbps.

All data rates were investigated and it was determined that 106 Kbps was considered worst-case. Therefore, all testing was performed in 106 Kbps mode.

AC Power Line Conducted Emission	
Test Condition	AC Power line conducted emission for line and neutral
Power supply Mode	Mode 1: EUT Power by Adapter (FSP) Mode 2: EUT power by Adapter. (DELTA)
Worst Mode	<input checked="" type="checkbox"/> Mode 1 <input type="checkbox"/> Mode 2 <input type="checkbox"/> Mode 3 <input type="checkbox"/> Mode 4

Radiated Emission Measurement Above 1G	
Test Condition	Radiated Emission Above 1G
Power supply Mode	Mode 1: EUT Power by Adapter (FSP) Mode 2: EUT power by Adapter. (DELTA)
Worst Mode	<input checked="" type="checkbox"/> Mode 1 <input type="checkbox"/> Mode 2 <input type="checkbox"/> Mode 3 <input type="checkbox"/> Mode 4
Worst Position	<input checked="" type="checkbox"/> Placed in fixed position at X-Plane (E2-Plane)

Radiated Emission Measurement Below 1G	
Test Condition	Radiated Emission Below 1G
Power supply Mode	Mode 1: EUT Power by Adapter (FSP) Mode 2: EUT power by Adapter. (DELTA)
Worst Mode	<input type="checkbox"/> Mode 1 <input checked="" type="checkbox"/> Mode 2 <input type="checkbox"/> Mode 3 <input type="checkbox"/> Mode 4

Remark:

1. The worst mode was record in this test report.
2. EUT pre-scanned in axis X and two polarity, for radiated measurement. The worst case(X-Plane) were recorded in this report
3. AC power line conducted emission and for below 1G radiation emission were performed the EUT transmit at the highest output power channel as worse case.

4. TEST SUMMARY

FCC Standard Sec.	IC Standard Sec.	Chapter	Test Item	Result
15.203	RSS-GEN Sec. 8.3	2	Antenna Requirement	Pass
15.215	RSS-210	8.1	Occupied Bandwidth (99%) and 20dB Bandwidth	Pass
15.209	RSS-210	8.2	Radiated Emissions	Pass
15.225	RSS-210	8.3	Frequency Stability	Pass
15.207	RSS-GEN Sec. 8.8	8.4	AC Power-line Conducted Emission	N/A

Report No.: T201216D05-RP

5. INSTRUMENT CALIBRATION

5.1 MEASURING INSTRUMENT CALIBRATION

The measuring equipment, which was utilized in performing the tests documented herein, has been calibrated in accordance with the manufacturer's recommendations for utilizing calibration equipment, which is traceable to recognized national standards.

5.2 MEASUREMENT EQUIPMENT USED

Equipment Used for Emissions Measurement

RF Conducted Test Site					
Equipment	Manufacturer	Model	S/N	Cal Date	Cal Due
EXA Signal Analyzer	KEYSIGHT	N9010B	MY55460167	09/07/2020	09/06/2021
Thermostatic/Humidity Chamber	TAICHY	MHG-150LF	930619	09/24/2020	09/23/2021
Software	N/A				

3M 966 Chamber Test Site					
Equipment	Manufacturer	Model	S/N	Cal Date	Cal Due
Bilog Antenna	Sunol Sciences	JB3	A030105	07/24/2020	07/23/2021
Coaxial Cable	HUBER SUHNER	SUCOFLEX 104PEA	20995	02/25/2021	02/24/2022
Digital Thermo-Hygro Meter	WISEWIND	1206	D07	01/06/2021	01/05/2022
Loop Ant	COM-POWER	AL-130	121051	03/27/2020	03/26/2021
Pre-Amplifier	EMEC	EM330	060609	02/25/2021	02/24/2022
PSA Series Spectrum Analyzer	Agilent	E4446A	MY46180323	07/24/2020	07/23/2021
Antenna Tower	CCS	CC-A-1F	N/A	N.C.R	N.C.R
Controller	CCS	CC-C-1F	N/A	N.C.R	N.C.R
Turn Table	CCS	CC-T-1F	N/A	N.C.R	N.C.R
Software	e3 6.11-20180413				

Conducted Emission Room					
Name of Equipment	Manufacturer	Model	Serial Number	Calibration Date	Calibration Due
CABLE	EMCI	CFD300-NL	CERF	06/29/2020	06/28/2021
EMI Test Receiver	R&S	ESCI	100064	07/17/2020	07/16/2021
LISN	SCHAFFNER	NNB 41	03/10013	02/02/2021	02/01/2022
Software	EZ-EMC(CCS-3A1-CE)				

Remark:

1. Each piece of equipment is scheduled for calibration once a year.
2. N.C.R. = No Calibration Request.

Report No.: T201216D05-RP

Test date for August 6, 2021

3M 966 Chamber Test Site					
Equipment	Manufacturer	Model	S/N	Cal Date	Cal Due
Bilog Antenna	Sunol Sciences	JB3	A030105	07/19/2021	07/18/2022
Coaxial Cable	HUBER SUHNER	SUCOFLEX 104PEA	20995	02/24/2021	02/23/2022
Digital Thermo-Hygro Meter	WISEWIND	1206	D07	01/06/2021	01/05/2022
Loop Ant	COM-POWER	AL-130	121051	04/07/2021	04/06/2022
Pre-Amplifier	EMEC	EM330	060609	02/24/2021	02/23/2022
Signal Analyzer	R&S	FSV 40	101073	09/17/2020	09/16/2021
Antenna Tower	CCS	CC-A-1F	N/A	N.C.R	N.C.R
Controller	CCS	CC-C-1F	N/A	N.C.R	N.C.R
Turn Table	CCS	CC-T-1F	N/A	N.C.R	N.C.R
Software	e3 6.11-20180413				

5.3 MEASUREMENT UNCERTAINTY

PARAMETER	UNCERTAINTY
AC Powerline Conducted Emission	+/- 1.2575
Emission bandwidth, 20dB bandwidth	+/- 0.0014
RF output power, conducted	+/- 1.14
Power density, conducted	+/- 1.40
3M Semi Anechoic Chamber / 9K~30M	+/- 2.30
3M Semi Anechoic Chamber / 30M~200M	+/- 4.12
3M Semi Anechoic Chamber / 200M~1000M	+/- 4.68
3M Semi Anechoic Chamber / 1G~8G	+/- 5.18
3M Semi Anechoic Chamber / 8G~18G	+/- 5.47
3M Semi Anechoic Chamber / 18G~26G	+/- 3.81
3M Semi Anechoic Chamber / 26G~40G	+/- 3.87

Remark: This uncertainty represents an expanded uncertainty expressed at approximately the 95% confidence level using a coverage factor of k=2.

Report No.: T201216D05-RP

6. FACILITIES AND ACCREDITATIONS

6.1 FACILITIES

All measurement facilities used to collect the measurement data are located at

- No.199, Chunghsen Road, Hsintien City, Taipei Hsien, Taiwan, R.O.C.
Tel: 886-2-2217-0894 / Fax: 886-2-2217-1029
- No.11, Wugong 6th Rd., Wugu Dist., New Taipei City, Taiwan. (R.O.C.)
Tel: 886-2-2299-9720 / Fax: 886-2-2299-9721, CAB identifier: TW1309

The sites are constructed in conformance with the requirements of ANSI C63.7, ANSI C63.10: 2013 and CISPR Publication 22.

6.2 EQUIPMENT

Radiated emissions are measured with one or more of the following types of linearly polarized antennas: tuned dipole, bucolical, log periodic, bi-log, and/or ridged waveguide, horn. Spectrum analyzers with pre-selectors and quasi-peak detectors are used to perform radiated measurements.

Conducted emissions are measured with Line Impedance Stabilization Networks and EMI Test Receivers.

Calibrated wideband preamplifiers, coaxial cables, and coaxial attenuators are also used for making measurements.

All receiving equipment conforms to CISPR Publication 16-1, "Radio Interference Measuring Apparatus and Measurement Methods."

Report No.: T201216D05-RP

7. SETUP OF EQUIPMENT UNDER TEST

7.1 SETUP CONFIGURATION OF EUT

See test photographs attached in Appendix A for the actual connections between EUT and support equipment.

7.2 SUPPORT EQUIPMENT

No.	Device Type	Brand	Model	Series No.	FCC ID
	N/A				

Remark:

1. All the equipment/cables were placed in the worst-case configuration to maximize the emission during the test.
2. Grounding was established in accordance with the manufacturer's requirements and conditions for the intended use.

Report No.: T201216D05-RP

8. FCC PART 15.225 REQUIREMENTS & RSS-210 REQUIREMENTS

8.1 OCCUPIED BANDWIDTH(99%) AND 20 dB BANDWIDTH TEST CONFIGURATION

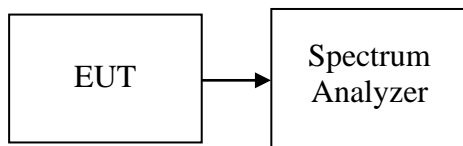

TEST PROCEDURE

1. Place the EUT on the table and set it in the transmitting mode.
2. Remove the antenna from the EUT and then connect a low loss RF cable from the antenna port to the spectrum analyzer.
3. Set the spectrum analyzer as RBW=1kHz, VBW = 3kHz, Span = 10kHz, Sweep = auto.
4. Record the max. reading.

TEST RESULTS

No non-compliance noted.

Temperature: 21.6°C

Humidity: 51% RH

Tested by: Dally Hong

Test Date: March 12, 2021

Test Condition	Frequency(MHz)	Occupied Bandwidth 99% (Hz)	20 dB Bandwidth (Hz)
NFC	13.56	709.1172	217.0

Test Plot

20dB & 99% Bandwidth

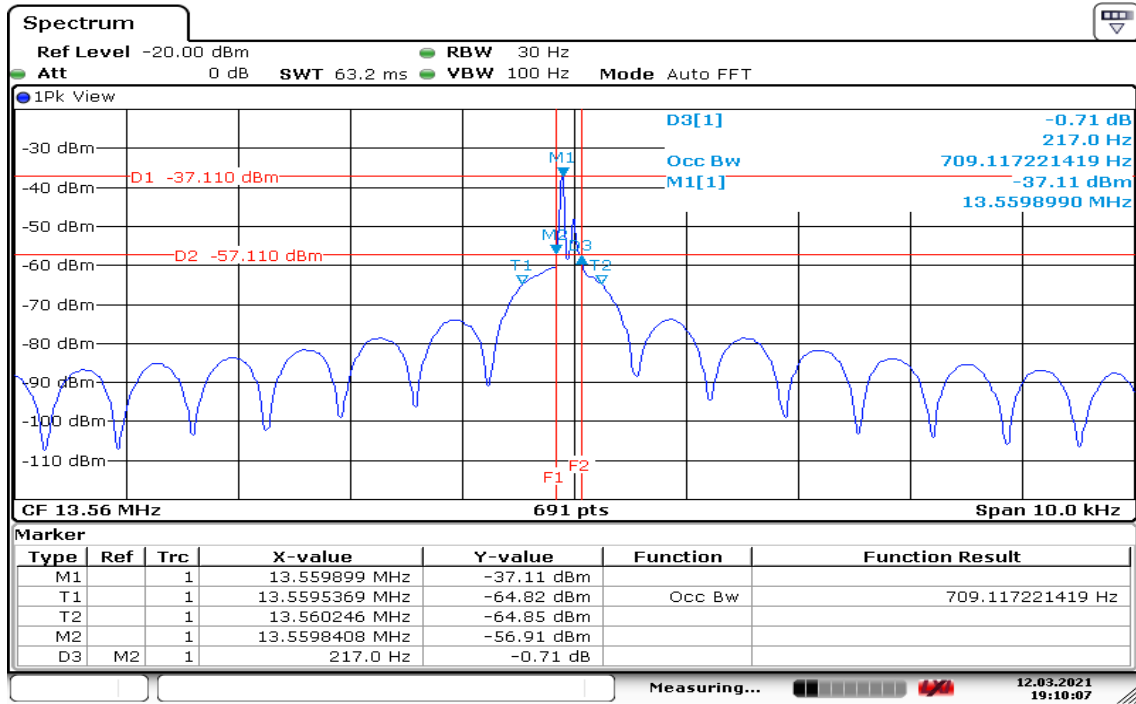

Date: 12.MAR.2021 19:10:08

Report No.: T201216D05-RP

8.2 FUNDAMENTAL AND RADIATED EMISSIONS

LIMIT

According to §15.225

- (a) The field strength of any emissions within the band 13.553 – 13.567 MHz shall not exceed 15,848 microvolts / meter at 30 meters.
- (b) Within the bands 13.410 – 13.553 MHz and 13.567 -13.710 MHz, the field strength of any emissions shall not exceed 334 microvolts / meter at 30 meters.
- (c) Within the bands 13.110 – 13.410 MHz and 13.710 – 14.010 MHz the field strength of any emissions shall not exceed 106 microvolts / meter at 30 meters.
- (d) The field strength of any emissions appearing outside of the 13.110 – 14.010 MHz and shall not exceed the general radiated emission limits in §15.209.

According to §15.225, except as provided elsewhere in this Subpart, the emissions from an intentional radiator shall not exceed the field strength levels specified in the following table:

Frequency (MHz)	Field Strength (µV/m at meter)	Measurement Distance (meter)
0.009 – 0.490	2400 / F (kHz)	300
0.490 – 1.705	24000 / F (kHz)	30
1.705 – 30.0	30	30
30 - 88	100**	3
88-216	150**	3
216-960	200**	3
Above 960	500	3

** Except as provided in paragraph (g), fundamental emissions from intentional radiators operating under this Section shall not be located in the frequency bands 54-72 MHz, 76-88 MHz, 174-216 MHz or 470-806 MHz. However, operation within these frequency bands is permitted under other sections of this Part, e.g., Sections 15.231 and 15.241.

Report No.: T201216D05-RP

According to RSS 210 §B.6

The field strength of any emission shall not exceed the following limits:

- (a) 15.848 mV/m (84 dBµV/m) at 30 m, within the band 13.553-13.567 MHz;
- (b) 334 µV/m (50.5 dBµV/m) at 30 m, within the bands 13.410-13.553 MHz and 13.567-13.710 MHz;
- (c) 106 µV/m (40.5 dBµV/m) at 30 m, within the bands 13.110-13.410 MHz and 13.710-14.010 MHz; and
- (d) RSS-Gen general field strength limits for frequencies outside the band 13.110-14.010 MHz.

Below 30 MHz

Frequency	Magnetic field strength (H-Field) (µA/m)	Measurement Distance (metres)
9-490 kHz ^{Note 1}	6.37/F (F in kHz)	300
490-1,705 kHz	63.7/F (F in kHz)	30
1.705-30 MHz	0.08	30

Note 1: The emission limits for the ranges 9-90 kHz and 110-490 kHz are based on measurements employing a linear average detector.

Above 30 MHz

Frequency	Field strength (µV/m at 3 m)
30-88	100
88-216	150
216-960	200
Above 960	500

Report No.: T201216D05-RP

Test Configuration

9kHz ~ 30MHz

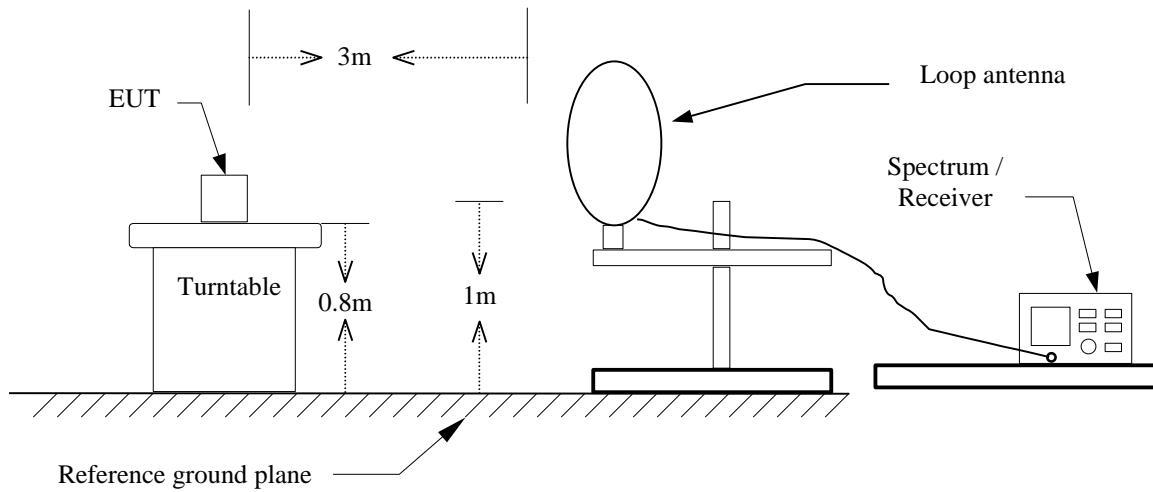

30MHz ~ 1GHz

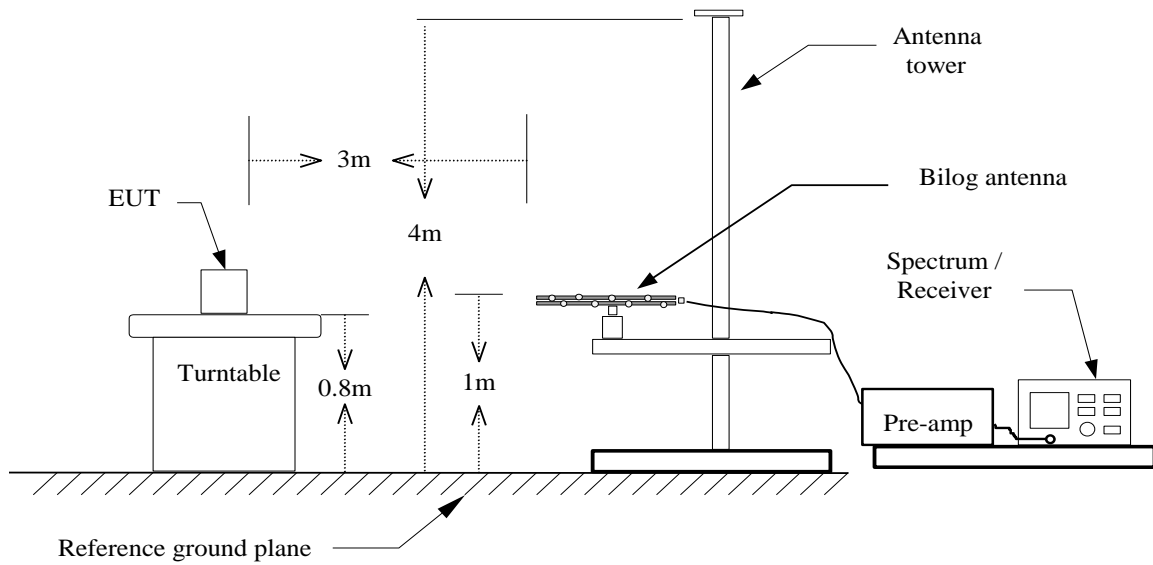

Report No.: T201216D05-RP

TEST PROCEDURE

For 9kHz ~ 30MHz

1. The EUT is placed on a turntable, which is 0.8m above ground plane.
2. The turntable shall be rotated for 360 degrees to determine the position of maximum emission level.
3. EUT is set 3m away from the receiving antenna, The center of the loop shall be 1 m above the ground then to find out the highest emissions.
4. Maximum procedure was performed on the six highest emissions to ensure EUT compliance.
5. Set the spectrum analyzer in the following setting as:
9KHz-490KHz : RBW=200Hz / VBW=1kHz / Sweep=AUTO
490KHz-30MHz : RBW=10kHz / VBW=30kHz / Sweep=AUTO
6. Repeat above procedures until the measurements for all frequencies are complete.

For 30MHz ~ 1GHz

1. The EUT is placed on a turntable, which is 0.8m above ground plane.
2. The turntable shall be rotated for 360 degrees to determine the position of maximum emission level.
3. EUT is set 3m away from the receiving antenna, which is varied from 1m to find out the highest emissions.
4. Maximum procedure was performed on the six highest emissions to ensure EUT compliance.
5. And also, each emission was to be maximized by changing the polarization of receiving antenna both horizontal and vertical.
6. Set the spectrum analyzer in the following setting as:
RBW=100kHz / VBW=300kHz / Sweep=AUTO
7. Repeat above procedures until the measurements for all frequencies are complete.

Remark :

Although these tests were performed other than open area test site, adequate comparison measurements were confirmed against 30 m open are test site. Therefore sufficient tests were made to demonstrate that the alternative site produces results that correlate with the ones of tests made in an open field based on KDB 414788.

Report No.: T201216D05-RP

Operation Mode:	TX mode	Test Date:	March 8, 2021
Temperature:	20.8°C	Tested by:	Ray Li
Humidity:	58 % RH	Polarity:	Ver.

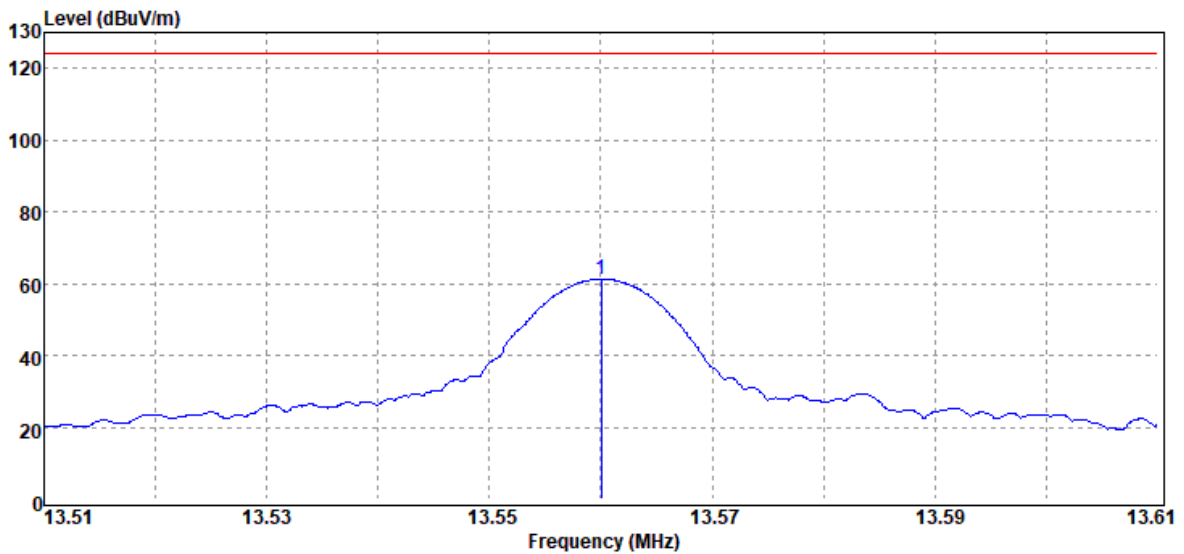

No.	Freq. MHz	Detector Mode PK/QP/AV	Spectrum Reading Level dB μ V	Factor dB	Actual FS dB μ V/m	Limit @3m dB μ V/m	Margin dB
1	13.56	Peak	45.90	15.34	61.24	124.00	-62.76

Remark:

1. Radiated emissions measured were made with an instrument using peak/quasi-peak/average detector mode.
2. Measurements above show only up to 6 maximum emissions noted, or would be lesser, with " N/A " remark, if no specific emissions from the EUT are recorded (ie: margin>20dB from the applicable limit) and considered that's already beyond the background noise floor.
3. Margin (dB) = Result (dBuV/m) – Limit (dBuV/m).
4. 9kHz to 490kHz Limit (@3m) = 2400(F/kHz)+ 40*Log (300 meters/3 meters)
490kHz to 1.705MHz Limit (@3m) = 2400(F/kHz)+ 40*Log (30 meters/3 meters)
1.705MHz to 30MHz Limit (@3m) = 30 + 40*Log (30 meters/3 meters)

Report No.: T201216D05-RP

Operation Mode:	TX mode	Test Date:	March 8, 2021
Temperature:	20.8°C	Tested by:	Ray Li
Humidity:	58 % RH	Polarity:	Hor.

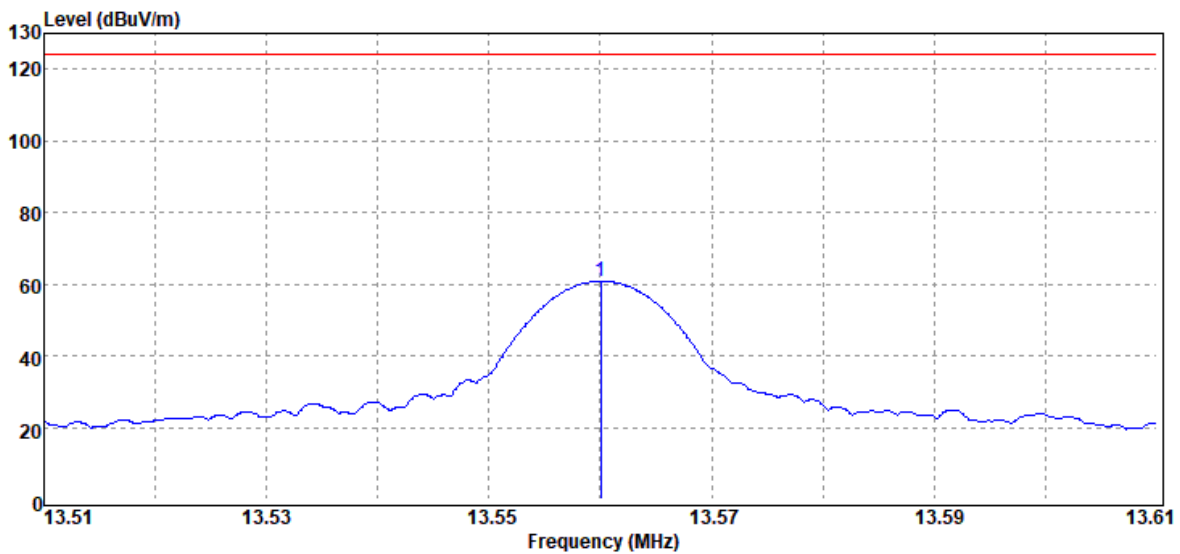

No.	Freq. MHz	Detector Mode PK/QP/AV	Spectrum Reading Level dB μ V	Factor dB	Actual FS dB μ V/m	Limit @3m dB μ V/m	Margin dB
1	13.56	Peak	45.46	15.34	60.80	124.00	-63.20

Remark:

1. Radiated emissions measured were made with an instrument using peak/quasi-peak/average detector mode.
2. Measurements above show only up to 6 maximum emissions noted, or would be lesser, with " N/A " remark, if no specific emissions from the EUT are recorded (ie: margin>20dB from the applicable limit) and considered that's already beyond the background noise floor.
3. Margin (dB) = Result (dBuV/m) – Limit (dBuV/m).
4. 9kHz to 490kHz Limit (@3m) = 2400(F/kHz)+ 40*Log (300 meters/3 meters)
490kHz to 1.705MHz Limit (@3m) = 2400(F/kHz)+ 40*Log (30 meters/3 meters)
1.705MHz to 30MHz Limit (@3m) = 30 + 40*Log (30 meters/3 meters)

Report No.: T201216D05-RP

Test Result of Mask

Operation Mode:	TX mode	Test Date:	March 8, 2021
Temperature:	20.8°C	Tested by:	Ray Li
Humidity:	58 % RH	Polarity:	Ver.

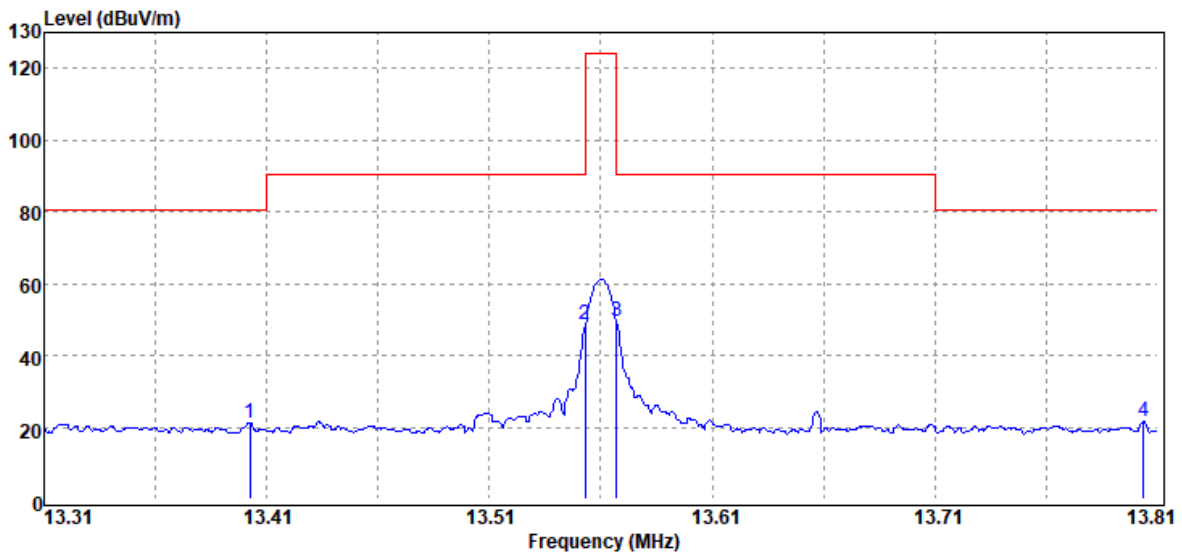

No.	Freq. MHz	Detector Mode PK/QP/AV	Spectrum Reading Level dBµV	Factor dB	Actual FS dBµV/m	Limit @3m dBµV/m	Margin dB
1	13.40	Peak	5.81	15.35	21.16	80.54	-59.38
2	13.55	Peak	33.13	15.34	48.47	90.47	-42.00
3	13.57	Peak	34.09	15.34	49.43	90.47	-41.04
4	13.80	Peak	6.33	15.33	21.66	80.50	-58.84

Remark:

1. Radiated emissions measured were made with an instrument using peak/quasi-peak/average detector mode.
2. Measurements above show only up to 6 maximum emissions noted, or would be lesser, with " N/A " remark, if no specific emissions from the EUT are recorded (ie: margin>20dB from the applicable limit) and considered that's already beyond the background noise floor.
3. Margin (dB) = Result (dBuV/m) – Limit (dBuV/m).
4. 9kHz to 490kHz Limit(@3m) = 2400(F/kHz)+ 40*Log (300 meters/3 meters)
490kHz to 1.705MHz Limit (@3m) = 2400(F/kHz)+ 40*Log (30 meters/3 meters)
1.705MHz to 30MHz Limit (@3m) = 30 + 40*Log (30 meters/3 meters)

Report No.: T201216D05-RP

Test Result of Mask

Operation Mode:	TX mode	Test Date:	March 8, 2021
Temperature:	20.8°C	Tested by:	Ray Li
Humidity:	58 % RH	Polarity:	Hor.

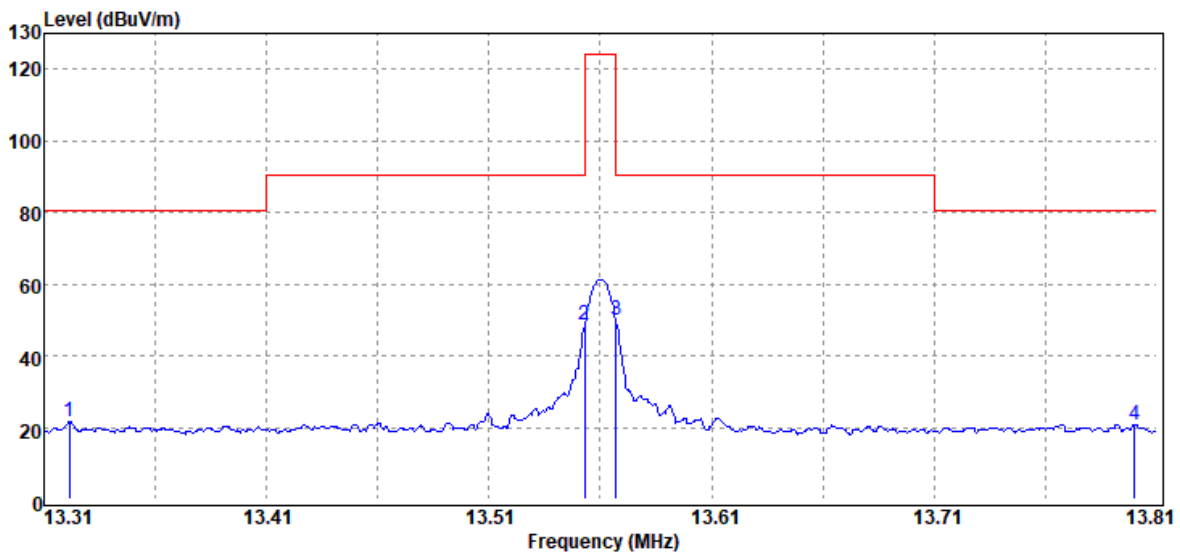

No.	Freq. MHz	Detector Mode PK/QP/AV	Spectrum Reading Level dBµV	Factor dB	Actual FS dBµV/m	Limit @3m dBµV/m	Margin dB
1	13.32	Peak	6.16	15.35	21.51	80.54	-59.03
2	13.55	Peak	33.39	15.34	48.73	90.47	-41.74
3	13.57	Peak	34.37	15.34	49.71	90.47	-40.76
4	13.80	Peak	5.48	15.33	20.81	80.50	-59.69

Remark:

1. Radiated emissions measured were made with an instrument using peak/quasi-peak/average detector mode.
2. Measurements above show only up to 6 maximum emissions noted, or would be lesser, with " N/A " remark, if no specific emissions from the EUT are recorded (ie: margin>20dB from the applicable limit) and considered that's already beyond the background noise floor.
3. Margin (dB) = Result (dBuV/m) – Limit (dBuV/m).
4. 9kHz to 490kHz Limit(@3m) = 2400(F/kHz)+ 40*Log (300 meters/3 meters)
 490kHz to 1.705MHz Limit (@3m) = 2400(F/kHz)+ 40*Log (30 meters/3 meters)
 1.705MHz to 30MHz Limit (@3m) = 30 + 40*Log (30 meters/3 meters)

Report No.: T201216D05-RP

9kHz ~ 30MHz

Operation Mode: TX mode

Test Date: March 8, 2021

Temperature: 20.8°C

Tested by: Ray Li

Humidity: 58 % RH

Polarity: Ver.

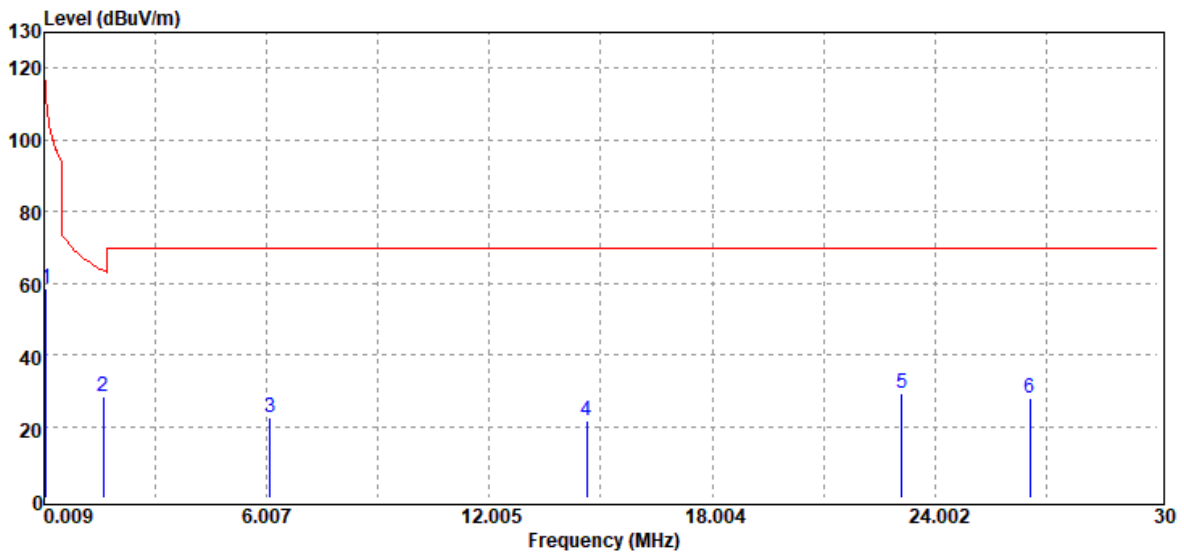

No.	Freq. MHz	Detector Mode PK/QP/AV	Spectrum Reading Level dB μ V	Factor dB	Actual FS dB μ V/m	Limit @3m dB μ V/m	Margin dB
1	0.07	Peak	44.97	13.53	58.50	110.83	-52.33
2	1.60	Peak	14.15	14.08	28.23	63.53	-35.30
3	6.10	Peak	7.36	15.10	22.46	69.54	-47.08
4	14.62	Peak	6.33	15.29	21.62	69.54	-47.92
5	23.10	Peak	14.70	14.35	29.05	69.54	-40.49
6	26.55	Peak	14.30	13.63	27.93	69.54	-41.61

Remark:

- 9kHz to 490kHz Limit(@3m) = $2400(F/kHz) + 40 * \text{Log}(300 \text{ meters}/3 \text{ meters})$
 490kHz to 1.705MHz Limit (@3m) = $2400(F/kHz) + 40 * \text{Log}(30 \text{ meters}/3 \text{ meters})$
 1.705MHz to 30MHz Limit (@3m) = $30 + 40 * \text{Log}(30 \text{ meters}/3 \text{ meters})$

Report No.: T201216D05-RP

Operation Mode: TX mode
Temperature: 20.8°C
Humidity: 58 % RH

Test Date: March 8, 2021
Tested by: Ray Li
Polarity: Hor.

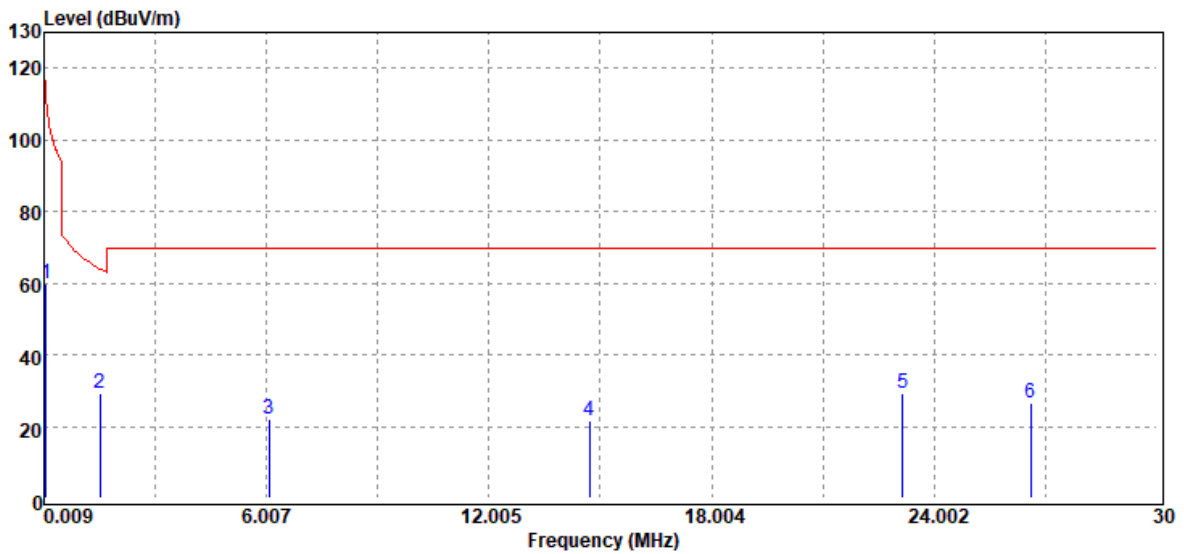

No.	Freq. MHz	Detector Mode PK/QP/AV	Spectrum Reading Level dB μ V	Factor dB	Actual FS dB μ V/m	Limit @3m dB μ V/m	Margin dB
1	0.07	Peak	46.13	13.53	59.66	110.83	-51.17
2	1.51	Peak	15.23	14.06	29.29	64.03	-34.74
3	6.07	Peak	6.88	15.10	21.98	69.54	-47.56
4	14.71	Peak	6.14	15.29	21.43	69.54	-48.11
5	23.16	Peak	14.81	14.33	29.14	69.54	-40.40
6	26.61	Peak	12.77	13.62	26.39	69.54	-43.15

Remark:

- 9kHz to 490kHz Limit(@3m) = 2400(F/kHz)+ 40*Log (300 meters/3 meters)
 490kHz to 1.705MHz Limit (@3m) = 2400(F/kHz)+ 40*Log (30 meters/3 meters)
 1.705MHz to 30MHz Limit (@3m) = 30 + 40*Log (30 meters/3 meters)

Report No.: T201216D05-RP

30MHz ~ 1GHz

Operation Mode: TX mode 2 **Test Date:** August 6, 2021
Temperature: 23.9°C **Tested by:** Ray Li
Humidity: 66 % RH **Polarity:** Ver. / Hor.

Freq. MHz	Detector Mode PK/QP/AV	Spectrum Reading Level dBµV	Factor dB	Actual FS dBµV/m	Limit @3m dBµV/m	Margin dB	Polarity
42.61	Peak	34.13	-11.59	22.54	40.00	-17.46	V
202.66	Peak	39.86	-10.67	29.19	43.50	-14.31	V
353.01	Peak	47.05	-7.13	39.92	46.00	-6.08	V
419.94	Peak	39.71	-5.06	34.65	46.00	-11.35	V
849.65	Peak	25.61	2.52	28.13	46.00	-17.87	V
954.41	Peak	25.79	3.97	29.76	46.00	-16.24	V
105.66	Peak	33.41	-11.23	22.18	43.50	-21.32	H
202.66	Peak	41.57	-10.67	30.90	43.50	-12.60	H
366.59	Peak	41.32	-6.60	34.72	46.00	-11.28	H
419.94	Peak	41.56	-5.06	36.50	46.00	-9.50	H
842.86	Peak	25.95	2.38	28.33	46.00	-17.67	H
995.15	Peak	25.21	4.60	29.81	54.00	-24.19	H

Report No.: T201216D05-RP

Vertical

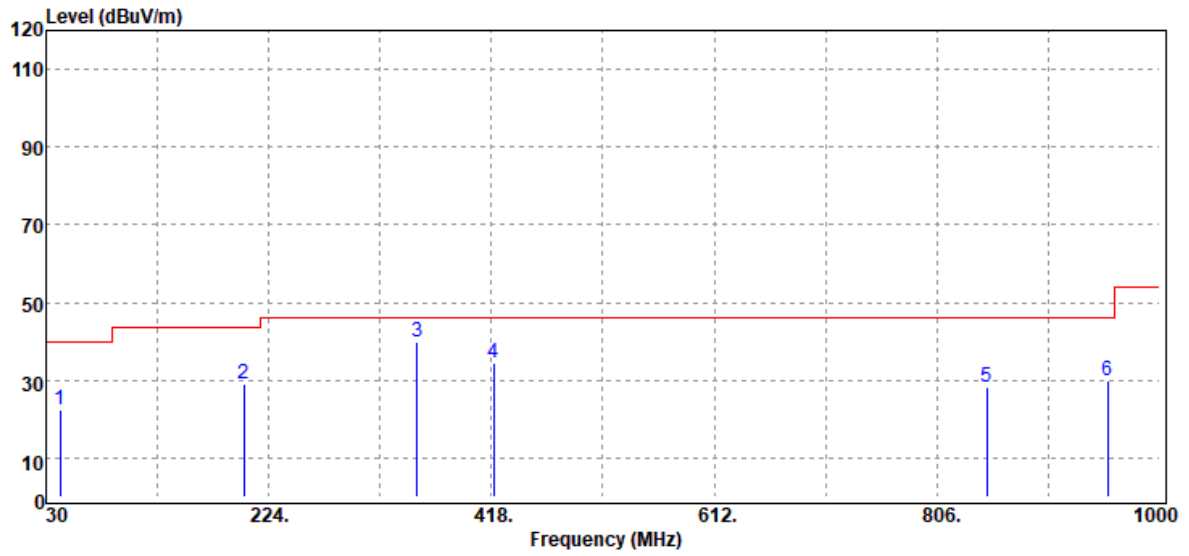

Horizontal

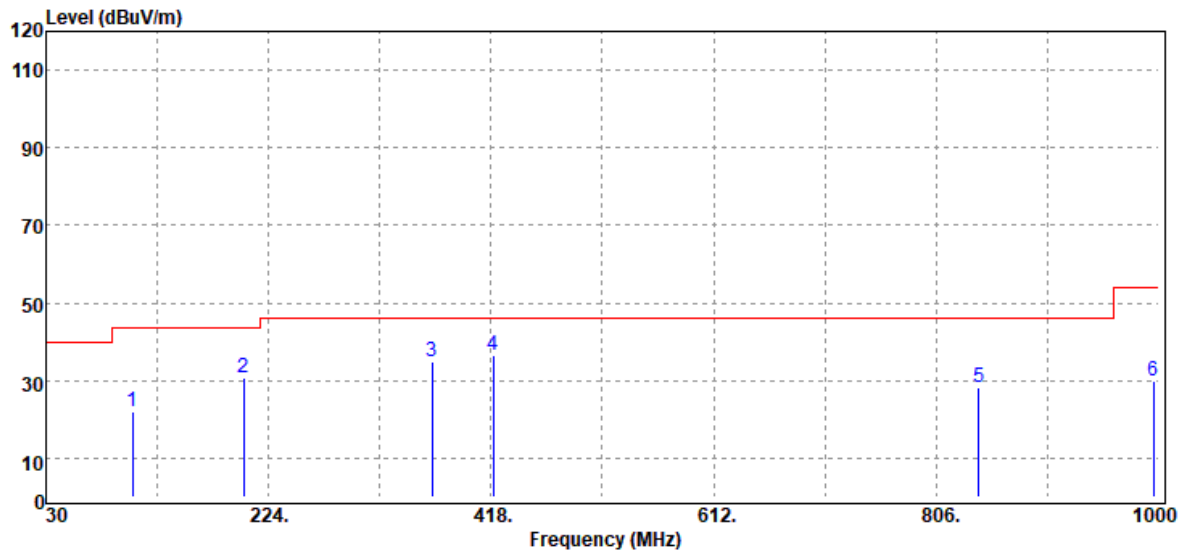

Report No.: T201216D05-RP

8.3 FREQUENCY STABILITY

LIMIT

According to §15.225(e) and RSS-210, B.6, The frequency tolerance of the carrier signal shall be maintained within +/- 0.01% of the operating frequency over a temperature variation of -20 degrees to +50 degrees C at normal supply voltage, and for a variation in the primary supply voltage from 85% to 115% of the rated supply voltage at a temperature of 20 degrees C. For battery operated equipment, the equipment tests shall be performed using a new battery.

Test Configuration

Temperature and Voltage Measurement (under normal and extreme test conditions)

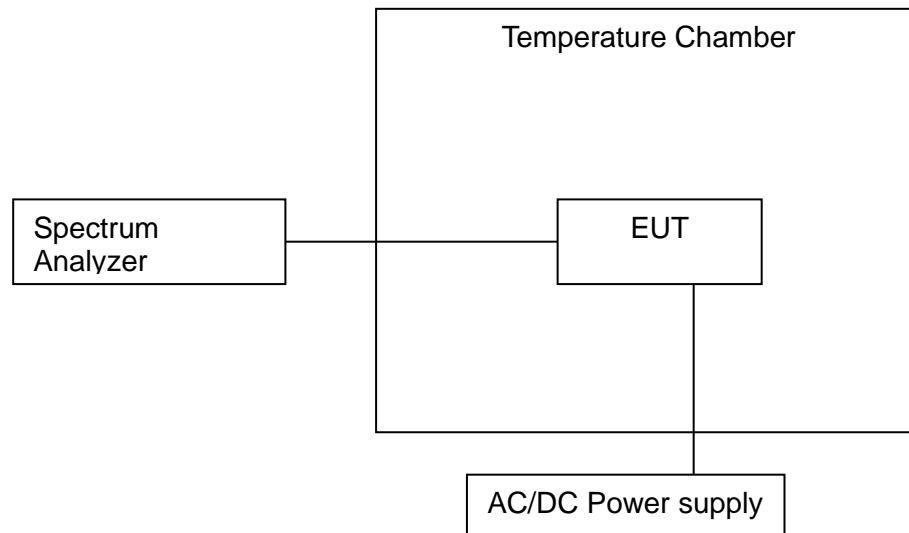

TEST PROCEDURE

1. Turn the EUT off, and place it inside the environmental temperature chamber.
2. Set the temperature control on the chamber to the highest specified in the regulatory requirements for the type of device and allow the oscillator heater and the chamber temperature to stabilize.
3. Set the spectrum analyzer as RBW=1kHz, VBW = RBW, Span = 200kHz, Sweep = auto.
4. Turn the EUT on and record the operating frequency at startup and two, five, and ten minutes after the EUT is energized.
5. Switch off the EUT and Lower the chamber temperature by not more than 10 °C and allow the temperature inside the chamber to stabilize.
6. Mark the peak frequency and measure the frequency tolerance using frequency counter function.
7. Repeat step 4 through step 6 down to the lowest specified temperature.

Report No.: T201216D05-RP

TEST RESULTS

No non-compliance noted.

Temperature: 21.6°C Humidity: 51% RH
Tested by: Dally Hong Test Date: March 12, 2021

TEST DATA

Condition			Frequency Error (ppm)										Limit (ppm)	Result
Temperature	Modulation Mode	Test Freq.	0 min	2 min	5 min	10 min	0 min	2 min	5 min	10 min	10 min			
Normal														
T _{20°C} V _{max}	CW	13.56	13.560058	13.560058	13.560058	13.560058	4.28	4.28	4.28	4.28	100	Pass		
T _{20°C} V _{min}	CW	13.56	13.560058	13.560058	13.560058	13.560058	4.28	4.28	4.28	4.28		Pass		
Extreme														
T _{40°C} V _{nom}	CW	13.56	13.560058	13.560058	13.560058	13.560058	4.28	4.28	4.28	4.28	100	Pass		
T _{30°C} V _{nom}	CW	13.56	13.560058	13.560058	13.560058	13.560058	4.28	4.28	4.28	4.28		Pass		
T _{20°C} V _{nom}	CW	13.56	13.560058	13.560058	13.560058	13.560058	4.28	4.28	4.28	4.28		Pass		
T _{10°C} V _{nom}	CW	13.56	13.560058	13.560058	13.560058	13.560058	4.28	4.28	4.28	4.28		Pass		
T _{0°C} V _{nom}	CW	13.56	13.560058	13.560058	13.560058	13.560058	4.28	4.28	4.28	4.28		Pass		
T _{-15°C} V _{nom}	CW	13.56	13.560058	13.560058	13.560058	13.560058	4.28	4.28	4.28	4.28		Pass		

Remark: Vnom: 120Vdc

Report No.: T201216D05-RP

8.4 POWERLINE CONDUCTED EMISSIONS

LIMIT

According to §15.207(a), for an intentional radiator that is designed to be connected to the public utility (AC) power line, the radio frequency voltage that is conducted back onto the AC power line on any frequency or frequencies within the band 150 kHz to 30 MHz shall not exceed the limits in the following table, as measured using a 50 μ H/50 ohms line impedance stabilization network (LISN). Compliance with the provisions of this paragraph shall be based on the measurement of the radio frequency voltage between each power line and ground at the power terminal. The lower limit applies at the boundary between the frequency ranges.

Frequency Range (MHz)	Limits (dB μ V)	
	Quasi-peak	Average
0.15 to 0.50	66 to 56*	56 to 46*
0.50 to 5	56	46
5 to 30	60	50

* Decreases with the logarithm of the frequency.

TEST PROCEDURE

1. The EUT was placed on a table, which is 0.8m above ground plane.
2. Maximum procedure was performed on the six highest emissions to ensure EUT compliance.
3. Repeat above procedures until all frequency measured were complete.

Report No.: T201216D05-RP

TEST RESULTS

Operation Mode: NFC mode

Test Date: March 23, 2021

Temperature: 21.5°C

Tested by: Jerry Chang

Humidity: 48% RH

Freq. (MHz)	QP Reading (dBuV)	AV Reading (dBuV)	Corr. factor (dB/m)	QP Result (dBuV/m)	AV Result (dBuV/m)	QP Limit (dBuV)	AV Limit (dBuV)	QP Margin (dB)	AV Margin (dB)	Note
0.1660	33.31	27.01	10.29	43.60	37.30	65.16	55.16	-21.56	-17.86	L1
0.2860	27.80	19.50	10.29	38.09	29.79	60.64	50.64	-22.55	-20.85	L1
0.4340	25.82	18.58	10.29	36.11	28.87	57.18	47.18	-21.07	-18.31	L1
0.6780	24.18	18.30	10.29	34.47	28.59	56.00	46.00	-21.53	-17.41	L1
0.9900	19.51	12.36	10.31	29.82	22.67	56.00	46.00	-26.18	-23.33	L1
13.5580	43.38	38.55	10.44	53.82	48.99	60.00	50.00	-6.18	-1.01	L1
0.1660	13.07	8.08	10.26	23.33	18.34	65.16	55.16	-41.83	-36.82	N
0.2860	10.63	4.55	10.26	20.89	14.81	60.64	50.64	-39.75	-35.83	N
0.4060	12.05	6.40	10.26	22.31	16.66	57.73	47.73	-35.42	-31.07	N
0.6940	19.27	13.74	10.26	29.53	24.00	56.00	46.00	-26.47	-22.00	N
1.0260	24.44	16.33	10.28	34.72	26.61	56.00	46.00	-21.28	-19.39	N
13.5580	43.31	39.43	10.45	53.76	49.88	60.00	50.00	-6.24	-0.12	N

Remark:

1. The measuring frequencies range between 0.15 MHz and 30 MHz.
2. The emissions measured in the frequency range between 0.15 MHz and 30MHz were made with an instrument using Quasi-peak detector and Average detector.
3. The IF bandwidth of SPA between 0.15MHz and 30MHz was 10kHz. The IF bandwidth of Test Receiver between 0.15MHz and 30MHz was 9kHz.
4. L1 = Line One (Live Line) / L2 = Line Two (Neutral Line)
5. "-" means Quasi-peak reading value also meets average limit and measurement with the average detector is unnecessary.
6. Correction factor = LISN loss + Cable loss.

Report No.: T201216D05-RP

Test Plots

Conducted emissions (Line 1)

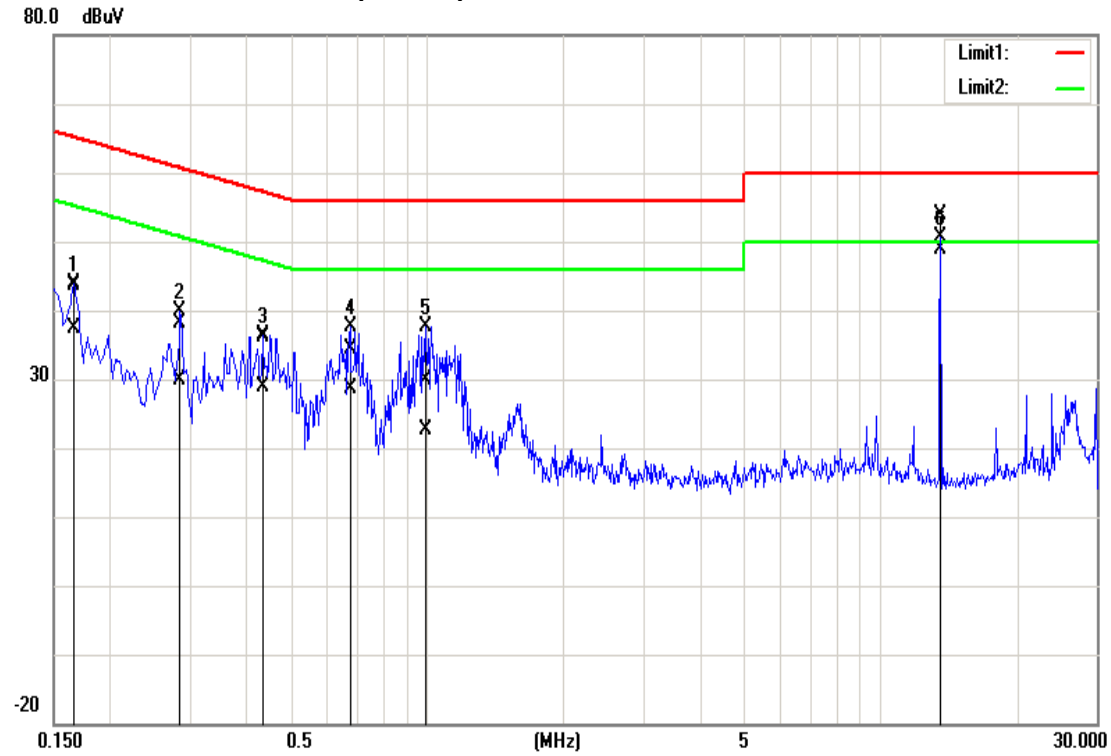

Conducted emissions (N)

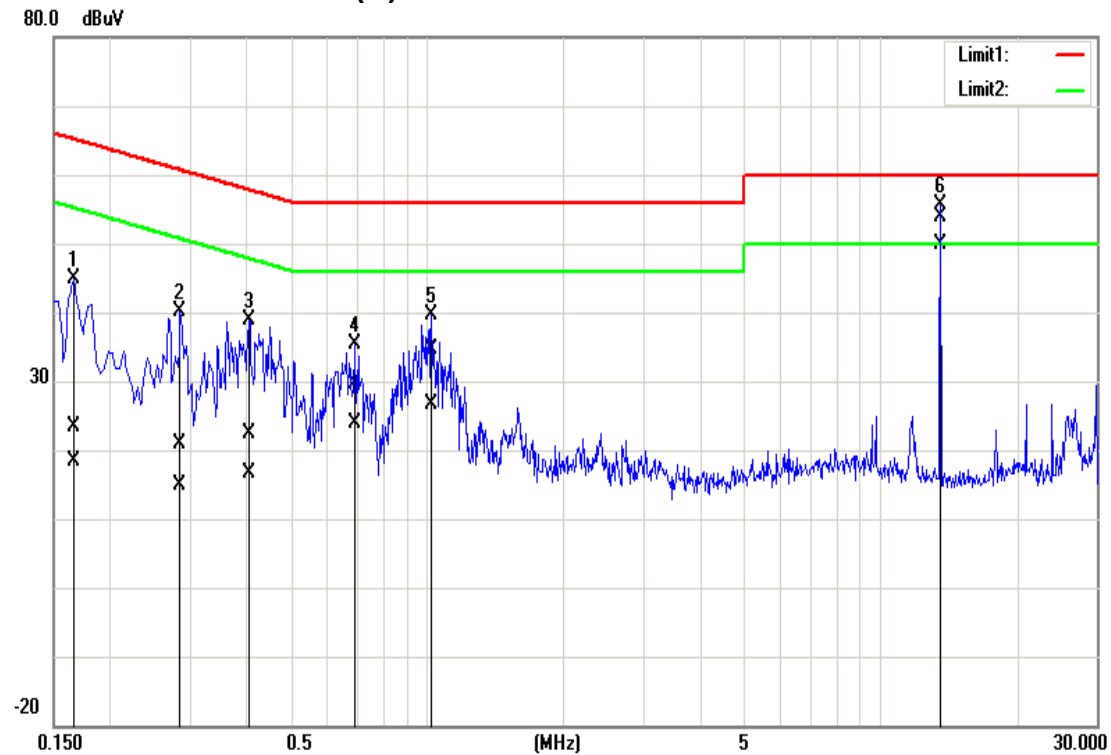

- End of Test Report -